

# HP 3457A Multimeter

---

## Service Manual



Copyright © Hewlett-Packard Company, 1988



03457-90012  
E0292

Manual Part Number: 03457-90012  
Microfiche Part Number: 03457-99012

Printed: FEBRUARY 1988 Edition 3  
Printed in U.S.A.

# HP 3457A Multimeter

---

## Service Manual



Copyright © Hewlett-Packard Company, 1988

# Printing History

---

The Printing History shown below lists the printing dates of all Editions and Updates created for this manual. The Edition number changes as the manual undergoes subsequent revisions. Editions are numbered sequentially starting with Edition 1. Updates, which are issued between Editions, contain individual replacement pages which the customer uses to update the current Edition of the manual. Updates are numbered sequentially starting with Update 1. When a new Edition is created, all Updates associated with the previous Edition are merged into the manual. Each new Edition or Update also includes a revised copy of this printing history page.

Many product updates and revisions do not require manual changes and, conversely, manual corrections may be done without accompanying product changes. Therefore, do not expect a one-to-one correspondence between product updates and manual updates.

Edition 1 (Part Number 03457-90010) . . . . . APRIL, 1985  
Update 1 (Part Number 03457-90201) . . . . . OCTOBER, 1985  
Edition 2 (Part Number 03457-90011) . . . . . MAY, 1986  
Update 1 (Part Number 03457-90090) . . . . . JUNE, 1987  
Edition 3 (Part Number 03457-90012) . . . . . FEBRUARY, 1988

## RESTRICTED RIGHTS LEGEND

Use, duplication, or disclosure by the Government is subject to restrictions as set forth in subdivision (b)(3)(ii) of the Rights in Technical Data and Computer Software clause at 52.227-7013.

Hewlett-Packard Company  
3000 Hanover Street, Palo Alto, California 94304

# Notice

---

## Hewlett-Packard to Agilent Technologies Transition

This manual may contain references to HP or Hewlett-Packard. Please note that Hewlett-Packard's former test and measurement, semiconductor products and chemical analysis businesses are now part of Agilent Technologies. To reduce potential confusion, the only change to product numbers and names has been in the company name prefix: where a product name/number was HP XXXX the current name/number is now Agilent XXXX. For example, model number HP8648 is now model number Agilent 8648.

### Contacting Agilent Sales and Service Offices

The sales and service contact information in this manual may be out of date. The latest service and contact information for your location can be found on the Web at:

<http://www.agilent.com/find/assist>

If you do not have access to the Internet, contact your field engineer or the nearest sales and service office listed below. In any correspondence or telephone conversation, refer to your instrument by its model number and full serial number.

**United States**

(tel) 1 800 452 4844

(fax) 1 800 829 4433

**Canada**

(tel) +1 877 894 4414

(fax) +1 888 900 8921

**Europe**

(tel) (31 20) 547 2323

(fax) (31 20) 547 2390

**Latin America**

(tel) (305) 269 7500

(fax) (305) 269 7599

**Japan**

(tel) (81) 426 56 7832

(fax) (81) 426 56 7840

**Australia**

(tel) 1 800 629 485

(fax) (61 3) 9210 5947

**New Zealand**

(tel) 0 800 738 378

(fax) 64 4 495 8950

**Asia Pacific**

(tel) (852) 3197 7777

(fax) (852) 2506 9284



**Agilent Technologies**



### **CERTIFICATION**

*Hewlett-Packard Company certifies that this product met its published specifications at the time of shipment from the factory. Hewlett-Packard further certifies that its calibration measurements are traceable to the National Institute of Standards and Technologies, to the extent allowed by the the Institute's calibration facility, and to the calibration facilities of other International Standards Organization members.*

### **WARRANTY**

This Hewlett-Packard instrument product is warranted against defects in materials and workmanship for a period of one year from date of shipment. During the warranty period, Hewlett-Packard Company will, at its option, either repair or replace products which prove to be defective.

For warranty service or repair, this product must be returned to a service facility designated by -hp-. Buyer shall prepay shipping charges to -hp- and -hp- shall pay shipping charges to return the product to Buyer. However, Buyer shall pay all shipping charges, duties, and taxes for products returned to -hp- from another country.

Duration and conditions of warranty for this instrument may be superceded when the instrument is integrated into (becomes a part of) other -hp- instrument products.

Hewlett-Packard warrants that its software and firmware designated by -hp- for use with an instrument will execute its programming instructions when properly installed on that instrument. Hewlett-Packard does not warrant that the operation of the instrument, or software, or firmware will be uninterrupted or error free.

### **LIMITATION OF WARRANTY**

The foregoing warranty shall not apply to defects resulting from improper or inadequate maintenance by Buyer, Buyer-supplied software or interfacing, unauthorized modification or misuse, operation outside of the environmental specifications for the product, or improper site preparation or maintenance.

**NO OTHER WARRANTY IS EXPRESSED OR IMPLIED. HEWLETT-PACKARD SPECIFICALLY DISCLAIMS THE IMPLIED WARRANTIES OF MERCHANTABILITY AND FITNESS FOR A PARTICULAR PURPOSE.**

### **EXCLUSIVE REMEDIES**

**THE REMEDIES PROVIDED HEREIN ARE BUYER'S SOLE AND EXCLUSIVE REMEDIES. HEWLETT-PACKARD SHALL NOT BE LIABLE FOR ANY DIRECT, INDIRECT, SPECIAL, INCIDENTAL, OR CONSEQUENTIAL DAMAGES, WHETHER BASED ON CONTRACT, TORT, OR ANY OTHER LEGAL THEORY.**

### **ASSISTANCE**

*Product maintenance agreements and other customer assistance agreements are available for Hewlett-Packard products.*

*For any assistance, contact your nearest Hewlett-Packard Sales and Service Office. Addresses are provided at the back of this manual.*

### Herstellerbescheinigung

Hiermit wird bescheinigt, daß das Gerät/System HP 3457A  
in Übereinstimmung mit den Bestimmungen von Postverfügung 1046/84 funkentstört ist.

Der Deutschen Bundespost wurde das Inverkehrbringen dieses Gerätes/Systems angezeigt und die Berechtigung zur Überprüfung der Serie auf Einhaltung der Bestimmungen eingeräumt.

#### Zusatzinformation für Meß- und Testgeräte

Werden Meß- und Testgeräte mit ungeschirmten Kabeln und/oder in offenen Meßaufbauten verwendet, so ist vom Betreiber sicherzustellen, daß die Funk-Entstörbestimmungen unter Betriebsbedingungen an seiner Grundstücksgrenze eingehalten werden.

### Manufacturer's declaration

This is to certify that the equipment HP 3457A  
is in accordance with the Radio Interference Requirements of Directive FTZ 1046/84. The German Bundespost was notified that this equipment was put into circulation, the right to check the series for compliance with the requirements was granted.

#### Additional Information for Test- and Measurement Equipment

If Test- and Measurement Equipment is operated with unshielded cables and/or used for measurements on open set-ups, the user has to assure that under operating conditions the Radio Interference Limits are still met at the border of his premises.

### NOTICE

The information contained in this document is subject to change without notice.

HEWLETT-PACKARD MAKES NO WARRANTY OF ANY KIND WITH REGARD TO THIS MATERIAL, INCLUDING, BUT NOT LIMITED TO, THE IMPLIED WARRANTIES OF MERCHANTABILITY AND FITNESS FOR A PARTICULAR PURPOSE. Hewlett-Packard shall not be liable for errors contained herein or for incidental or consequential damages in connection with the furnishing, performance or use of this material.

Hewlett-Packard assumes no responsibility for the use or reliability of its software on equipment that is not furnished by Hewlett-Packard.

This document contains proprietary information which is protected by copyright. All rights are reserved. No part of this document may be photocopied, reproduced or translated to another language without the prior written consent of Hewlett-Packard Company.

### **SAFETY SUMMARY**

The following general safety precautions must be observed during all phases of operation, service, and repair of this instrument. Failure to comply with these precautions or with specific warnings elsewhere in this manual violates safety standards of design, manufacture, and intended use of the instrument. Hewlett-Packard Company assumes no liability for the customer's failure to comply with these requirements.

#### **GROUND THE INSTRUMENT**

To minimize shock hazard, the instrument chassis and cabinet must be connected to an electrical ground.

#### **DO NOT OPERATE IN AN EXPLOSIVE ATMOSPHERE**

Do not operate the instrument in the presence of flammable gases or fumes. Operation of any electrical instrument in such an environment constitutes a definite safety hazard.

#### **KEEP AWAY FROM LIVE CIRCUITS**

Operating personnel must not remove instrument covers. Component replacement and internal adjustments must be made by qualified maintenance personnel. Under certain conditions, dangerous voltages may exist even with the instrument switched off. To avoid injuries, always disconnect input voltages and discharge circuits before touching them.

#### **DO NOT SERVICE OR ADJUST ALONE**

Do not attempt internal service or adjustment unless another person, capable of rendering first aid and resuscitation, is present.

#### **DO NOT SUBSTITUTE PARTS OR MODIFY INSTRUMENT**

Because of the danger of introducing additional hazards, do not install substitute parts or perform any unauthorized modification to the instrument. Return the instrument to a Hewlett-Packard Sales and Service Office for service and repair to ensure that safety features are maintained.

#### **DO NOT OPERATE A DAMAGED INSTRUMENT**

Whenever it is possible that the safety protection features built into this instrument have been impaired, either through physical damage, excessive moisture, or any other reason, REMOVE POWER and do not use the instrument until safe operation can be verified by service-trained personnel. If necessary, return the instrument to a Hewlett-Packard Sales and Service Office for service and repair to ensure that safety features are maintained.



# Operating and Safety Symbols

## Symbols Used On Products And In Manuals

~ LINE AC line voltage input receptacle.



Instruction manual symbol affixed to product. Cautions the user to refer to respective instruction manual procedures to avoid possible damage to the product.



Indicates dangerous voltage – terminals connected to interior voltage exceeding 1000 volts.

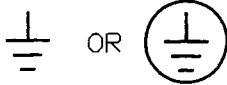

Protective conductor terminal. Indicates the field wiring terminal that must be connected to earth ground before operating equipment – protects against electrical shock in case of fault.



Clean ground (low-noise). Indicates terminal that must be connected to earth ground before operating equipment – for single common connections and protection against electrical shock in case of fault.

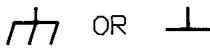

Frame or chassis ground. Indicates equipment chassis ground terminal – normally connects to equipment frame and all metal parts.



Affixed to product containing static sensitive devices – use anti-static handling procedures to prevent electrostatic discharge damage to components.

---

### NOTE

#### NOTE

*Calls attention to a procedure, practice, or condition that requires special attention by the reader.*

---

---

### CAUTION

#### CAUTION

*Calls attention to a procedure, practice, or condition that could possibly cause damage to equipment or permanent loss of data.*

---

---

### WARNING

#### WARNING

*Calls attention to a procedure, practice, or condition that could possibly cause bodily injury or death.*

---



# TABLE OF CONTENTS

Section I	Page	Section IV	Page
<b>GENERAL INFORMATION</b> . . . . .	<b>1-1</b>	<b>PERFORMANCE TESTS</b> . . . . .	<b>4-1</b>
1-1. Introduction. . . . .	1-1	4-1. Introduction. . . . .	4-1
1-3. Manual Description . . . . .	1-1	4-3. Equipment Required . . . . .	4-1
1-5. Instrument Description. . . . .	1-2	4-5. Test Record. . . . .	4-1
1-7. Safety Considerations. . . . .	1-2	4-7. Calibration Cycle . . . . .	4-1
1-9. Instruments Covered by this Manual . . . . .	1-2	4-9. Test Considerations . . . . .	4-1
1-13. Specifications . . . . .	1-2	4-10. General . . . . .	4-1
1-15. Options and Accessories . . . . .	1-24	4-12. Performance Tests . . . . .	4-2
1-17. Test Equipment. . . . .	1-25	<b>DC Voltage Performance Tests.</b> . . . . .	<b>4-2</b>
		4-13. Preliminary Steps. . . . .	4-2
		4-14. DC Voltage Function - Offset Test . . . . .	4-2
		4-16. DC voltage Function - Gain Test. . . . .	4-3
		4-18. DC Voltage Function - Linearity Test. . . . .	4-1
		<b>AC Voltage Performance Tests.</b> . . . . .	<b>4-4</b>
		4-20. AC Voltage Function - Gain Test . . . . .	4-1
		4-22. AC Voltage Function - Frequency Response Test . . . . .	4-5
		<b>DC Current Performance Tests.</b> . . . . .	<b>4-7</b>
		4-24. DC Current Function - Offset Test . . . . .	4-8
		4-26. DC Current Function - Gain Test . . . . .	4-8
		<b>AC Current Performance Tests.</b> . . . . .	<b>4-9</b>
		4-28. AC Current Function - Gain Test . . . . .	4-9
		<b>2-Wire Ohms Performance Tests</b> . . . . .	<b>4-10</b>
		4-30. 2-Wire Ohms Function - Offset Test. . . . .	4-10
		4-32. 2-Wire Ohms Function - Gain Test . . . . .	4-11
		<b>4-Wire Ohms Performance Tests</b> . . . . .	<b>4-11</b>
		4-34. 4-Wire Ohms Function - Offset Test. . . . .	4-12
		4-36. 4-Wire Ohms Function - Gain Test . . . . .	4-13
		<b>Frequency Counter Performance Tests</b> . . . . .	<b>4-13</b>
		4-38. Frequency Counter - Accuracy Test. . . . .	4-14
		<b>Rear Input Performance Tests (Standard Instrument)</b> . . . . .	<b>4-14</b>
		4-40. Preliminary Steps. . . . .	4-14
		4-41. DC Voltage Function - Rear Terminal Offset Test . . . . .	4-14
		4-43. DC Current Function - Rear Terminal Offset Test . . . . .	4-15
		4-45. 2-Wire Ohms Function - Offset Test. . . . .	4-15
		4-47. 4-Wire Ohms Function - Offset Test. . . . .	4-16
		<b>Rear Input Performance Tests (44491A General Purpose Relay Assy)</b> . . . . .	<b>4-17</b>
		4-49. Preliminary Steps. . . . .	4-17
<b>Section II</b>	<b>Page</b>		
<b>INSTALLATION</b> . . . . .	<b>2-1</b>		
2-1. Introduction. . . . .	2-1		
2-3. Initial Inspection. . . . .	2-1		
2-5. Preparation for Use. . . . .	2-2		
2-8. Line Voltage Selection . . . . .	2-2		
2-10. Power Cords. . . . .	2-2		
2-12. Grounding Requirements. . . . .	2-3		
2-14. Bench Use . . . . .	2-3		
2-16. Rack Mounting. . . . .	2-3		
2-18. Interface Connections. . . . .	2-4		
2-19. Control Interface. . . . .	2-4		
2-21. HP-IB Address Selection . . . . .	2-4		
2-23. Changing the Address from the Front Panel. . . . .	2-5		
2-24. Changing the Address from the Controller. . . . .	2-5		
2-25. Installation of Options . . . . .	2-6		
2-28. Rear Terminal Assembly Removal. . . . .	2-7		
2-30. Plug-In Assembly Installation . . . . .	2-8		
2-32. Plug-In Assembly Configuration . . . . .	2-9		
2-38. Wiring Block Preparation . . . . .	2-11		
<b>Section III</b>	<b>Page</b>		
<b>OPERATION</b> . . . . .	<b>3-1</b>		
3-1. Introduction. . . . .	3-1		
3-3. General Information . . . . .	3-1		
3-4. AC Power . . . . .	3-1		
3-6. Power On . . . . .	3-1		
3-9. Operation . . . . .	3-1		
3-11. Voltage Measurements . . . . .	3-1		
3-18. Resistance Measurements. . . . .	3-3		
3-25. Current Measurements . . . . .	3-4		
3-32. Frequency/Period Measurements. . . . .	3-6		
3-39. HP 44491A General Purpose Multiplexer . . . . .	3-6		
3-45. HP 44492A Reed Relay Multiplexer . . . . .	3-8		

## TABLE OF CONTENTS (Cont'd)

Section IV	Page	Section IV	Page
<b>PERFORMANCE TESTS (Cont'd)</b>		<b>PERFORMANCE TESTS (Cont'd)</b>	
4-50. DC Voltage Function - 44491A		4-90. Preliminary Steps . . . . .	4-32
Offset Test . . . . .	4-17	4-91. DC Voltage Function - Rear	
4-52. 2-Wire Ohms Function - 44491A		Terminal Offset Test . . . . .	4-33
Offset Test . . . . .	4-18	4-93. DC Current Function - Rear	
4-54. 4-Wire Ohms Function - 44491A		Terminal Offset Test . . . . .	4-33
Offset Test . . . . .	4-18	4-95. 2-Wire Ohms Function - Rear	
4-56. DC Current Function - 44491A		Terminal Offset Test . . . . .	4-33
Offset Test . . . . .	4-19	4-97. 4-Wire Ohms Function - Rear	
<b>Rear Input Performance Tests (44492A</b>		Terminal Offset Test . . . . .	4-33
<b>10 Channel Multiplexer Assy) . . . . .</b>	<b>4-20</b>	<b>Rear Input Operational Verification</b>	
4-58. Preliminary Steps . . . . .	4-20	<b>Tests (44491A General Purpose</b>	
4-59. DC Voltage Function - 44492A		<b>Relay Assy) . . . . .</b>	<b>4-34</b>
Offset Test . . . . .	4-20	4-99. Preliminary Steps . . . . .	4-34
4-61. 2-Wire Ohms Function - 44492A		4-100. DC Voltage Function - 44491A	
Offset Test . . . . .	4-21	Offset Test . . . . .	4-35
4-63. Operational Verification Tests . . . . .	4-22	4-102. 2-Wire Ohms Function - 44491A	
<b>DC Voltage Operational Verification</b>		Offset Test . . . . .	4-35
<b>Tests . . . . .</b>	<b>4-22</b>	4-104. 4-Wire Ohms Function - 44491A	
4-65. Preliminary Steps . . . . .	4-22	Offset Test . . . . .	4-35
4-66. DC Voltage Function - Offset Test . . . . .	4-22	4-106. DC Current Function - 44491A	
4-68. DC Voltage Function - Gain Test . . . . .	4-23	Offset Test . . . . .	4-36
<b>AC Voltage Operational Verification</b>		<b>Rear Input Operational Verification</b>	
<b>Tests . . . . .</b>	<b>4-24</b>	<b>Test (44492A 10 Channel</b>	
4-70. AC Voltage Function - Gain Test . . . . .	4-24	<b>Multiplexer Assy) . . . . .</b>	<b>4-36</b>
4-72. AC Voltage Function - Frequency		4-108. Preliminary Steps . . . . .	4-37
Response Test . . . . .	4-24	4-109. DC Voltage Function - 44492A	
<b>DC Current Operational Verification</b>		Offset Test . . . . .	4-37
<b>Tests . . . . .</b>	<b>4-25</b>	4-111. 2-Wire Ohms Function - 44492A	
4-74. DC Current Function - Offset Test . . . . .	4-26	Offset Test Limits . . . . .	4-37
4-76. DC Current Function - Gain Test . . . . .	4-26		
<b>AC Current Operational Verification</b>		<b>Section V</b>	<b>Page</b>
<b>Tests . . . . .</b>	<b>4-27</b>	<b>CALIBRATION . . . . .</b>	<b>5-1</b>
4-78. AC Current Function - Gain Test . . . . .	4-27	5-1. Introduction . . . . .	5-1
<b>2-Wire Ohms Operational Verification</b>		5-4. Calibration Security . . . . .	5-1
<b>Tests . . . . .</b>	<b>4-27</b>	5-6. Security Code . . . . .	5-1
4-80. 2-Wire Ohms Function - Offset		5-8. Changing the Security Code . . . . .	5-1
Test . . . . .	4-27	5-10. Calibration Number . . . . .	5-2
4-82. 2-Wire Ohms Function - Gain Test . . . . .	4-28	5-13. Preliminary Calibration	
<b>4-Wire Ohms Operational Verification</b>		Procedures . . . . .	5-3
<b>Tests . . . . .</b>	<b>4-29</b>	5-15. Input Amplifier Offset	
4-84. 4-Wire Ohms Function - Offset		Adjustments . . . . .	5-4
Test . . . . .	4-29	5-17. AC Converter Frequency	
4-86. 4-Wire Ohms Function - Gain Test . . . . .	4-30	Response Adjustment . . . . .	5-4
<b>Frequency Counter Operational</b>		5-19. Calibration Procedures - Front	
<b>Verification Tests . . . . .</b>	<b>4-31</b>	Panel Inputs . . . . .	5-5
4-88. Frequency Counter - Accuracy		5-21. DC Volts Offset Calibration . . . . .	5-5
Test . . . . .	4-31	5-23. DC Volts Gain Calibration . . . . .	5-6
<b>Rear Input Operational Verification</b>		5-25. DC Volts Linearity Calibration . . . . .	5-6
<b>Test (Standard Instrument) . . . . .</b>	<b>4-32</b>		

## TABLE OF CONTENTS (Cont'd)

<b>Section V</b>	<b>Page</b>	<b>Section VI</b>	<b>Page</b>
<b>CALIBRATION (Cont'd)</b>		<b>REPLACABLE PARTS (Cont'd)</b>	
5-27. 2-Wire Ohms Offset Calibration . . . . .	5-8	6-25. Digital (A1) Assembly Removal. . . . .	6-4
5-29. 2-Wire Ohms Gain Calibration . . . . .	5-7	6-27. Plug-In Support Assembly Removal. . . . .	6-5
5-31. 4-Wire Ohms Offset Calibration . . . . .	5-8	6-29. AC Converter (A3) Assembly Removal. . . . .	6-5
5-33. 4-Wire Ohms Gain Calibration . . . . .	5-9	6-31. Analog (A2) Assembly Removal . . . . .	6-5
5-35. DC Current Offset Calibration . . . . .	5-10	6-33. Front Panel Removal . . . . .	6-6
5-37. DC Current Gain Calibration . . . . .	5-10		
5-39. AC Volts Offset & Gain Calibration . . . . .	5-11	<b>Section VII</b>	<b>Page</b>
5-41. AC Current Calibration. . . . .	5-11	<b>MANUAL CHANGES. . . . .</b>	<b>7-1</b>
5-43. Frequency Calibration . . . . .	5-12	7-1. Introduction. . . . .	7-1
5-45. Calibration Procedures Rear Panel Inputs . . . . .	5-12	<b>Section VIII</b>	<b>Page</b>
5-47. DC Volts Offset Calibration. . . . .	5-12	<b>SERVICE . . . . .</b>	<b>8-1</b>
5-49. 2-Wire Ohms Offset Calibration . . . . .	5-13	8-1. Introduction. . . . .	8-1
5-51. 4-Wire Ohms Offset Calibration . . . . .	5-14	8-2. Safety Considerations. . . . .	8-1
5-53. DC Current Offset Calibration . . . . .	5-14	8-3. Static Handling. . . . .	8-2
5-55. Calibration Procedures - 44491A General Purpose Relay Assy . . . . .	5-15	8-4. Recommended Test Equipment . . . . .	8-2
5-56. Wiring Block Preparation . . . . .	5-15	8-5. General Block Diagram Theory of Operation . . . . .	8-2
5-58. DC Volts Offset Calibration. . . . .	5-16	8-6. Chassis Common Circuitry . . . . .	8-3
5-59. 2-Wire Ohms Offset Calibration . . . . .	5-17	8-10. Floating Common Circuitry. . . . .	8-3
5-60. 4-Wire Ohms Offset Calibration . . . . .	5-17	8-18. Detailed Theory of Operation . . . . .	8-5
5-61. DC Current Offset Calibration . . . . .	5-17	8-19. Input Circuitry . . . . .	8-5
5-62. Calibration Procedures - 44492A 10 Channel Multiplexer Assy. . . . .	5-18	8-26. Ohms Current . . . . .	8-11
5-63. Wiring Block Preparation . . . . .	5-18	8-31. A/D Converter . . . . .	8-13
5-65. DC Volts Offset Calibration. . . . .	5-19	8-35. A/D Controller . . . . .	8-16
5-66. 2-Wire Ohms Offset Calibration . . . . .	5-19	8-40. Main Controller (03457-66501) . . . . .	8-18
		8-49. Main Controller (03457-66511) . . . . .	8-23
<b>Section VI</b>	<b>Page</b>	8-55. AC to DC Converter . . . . .	8-27
<b>REPLACABLE PARTS. . . . .</b>	<b>6-1</b>	8-63. 44491A General Purpose Relay Card . . . . .	8-32
6-1. Introduction. . . . .	6-1	8-69. 44492A 10 Channel Reed Multiplexer . . . . .	8-35
6-3. Ordering Information. . . . .	6-1	8-71. Troubleshooting . . . . .	8-35
6-4. Listed Parts . . . . .	6-1	8-72. General Information . . . . .	8-36
6-6. Non-Listed Parts. . . . .	6-1	8-73. A1 Assy. Failure Indications. . . . .	8-36
6-8. Direct Mail Order System . . . . .	6-1	8-74. A2/A3 Assy. Failure Indications . . . . .	8-36
6-11. Part Changes. . . . .	6-2	8-75. Self Tests. . . . .	8-36
6-13. Proprietary Parts. . . . .	6-2	8-78. Self Test Changes for New Main Controller (03457-66511) . . . . .	8-44
6-15. Disassembly/Assembly Procedures . . . . .	6-3	8-81. Autocal (ACAL) . . . . .	8-46
6-17. Rear Terminal Assembly Removal. . . . .	6-3	8-82. Plug-in Cards . . . . .	8-60
6-19. Optional Plug-In Assembly Removal. . . . .	6-3	8-85. Replacement Procedures . . . . .	8-62
6-21. Top Cover Removal. . . . .	6-4		

# SECTION I

## GENERAL INFORMATION

### **WARNING**

*The information contained in this manual is intended for the use of service trained personnel who understand electronic circuitry and are aware of the hazards involved. Do not attempt to perform any of the procedures outlined in this manual unless you are qualified to do so.*

#### **1-1. INTRODUCTION**

1-2. This manual contains information relating to the installation, operation, performance testing, calibration, and service of the HP 3457A Multimeter. The information is designed for the use of service trained personnel. Other users should refer to the HP 3457A Operating Manual.

#### **1-3. MANUAL DESCRIPTION**

1-4. The following paragraphs provide a general description of the manual layout and content:

##### **Section I. General Information**

Section I contains a brief description of the manual, and a general description of the instrument. This section also contains the instrument specifications and information concerning options and accessories.

##### **Section II. Installation Procedures**

Section II contains information to prepare the HP 3457A for use. Included in this section is power requirements, line voltage selection, and interfacing information.

##### **Section III. Operating Instructions**

Section III contains operating instructions necessary to service the HP 3457A. These operating instructions are a condensed version of those contained in the Operating, Programming and Configuration Manual.

##### **Section IV. Performance Tests**

Section IV contains information and procedures required to test the HP 3457A to its rated specifications. Also included in this section is a condensed version of the performance test (operational verification test) which will provide a more rapid test and give a 90% confidence that the instrument will meet its specifications.

##### **Section V. Calibration**

Section V contains procedures required to calibrate the HP 3457A to its rated specifications.

**Section VI. Replaceable Parts**

Section VI lists part numbers for cabinet parts and printed circuit assemblies.

**Section VII. Manual Backdating**

Section VII contains information required to adapt this manual to instruments whose serial numbers are lower than those listed on the title page.

**Section VIII. Service**

Section VIII contains a block diagram theory of operation, schematic diagrams, and procedures to aid in troubleshooting the HP 3457A.

**1-5. INSTRUMENT DESCRIPTION**

1-6. The HP 3457A is a versatile high precision digital multimeter which measures ac or dc volts, ac or dc current, ac+dc volts or current, resistance, frequency and period. It measures voltages up to 300 Vac or 300 Vdc with high dc resolution and accuracy. The instrument is designed for both bench and system use. Program and reading storage are included to allow high speed measurement applications with reading rates of greater-than 1000 readings per second. Provision has been made for optional assemblies such as a general purpose scanner or multiplexer assembly.

**1-7. SAFETY CONSIDERATIONS**

1-8. The HP 3457A is a safety class I instrument (provided with a protective earth terminal). The instrument and manual should be reviewed for safety markings and instructions before operation. Refer to the Safety Summary preceding this section for appropriate safety instructions and markings covering this instrument.

**1-9. INSTRUMENTS COVERED BY THIS MANUAL**

1-10. Instruments covered by this manual are identified by a serial number prefix listed on the title page. Hewlett-Packard uses a two part serial number in the form XXXXAYYYYY, where XXXX is the serial prefix, A is the country of origin (A=USA) and YYYYY is the serial suffix. The serial number prefix identifies a series of identical instruments. The serial number suffix is assigned sequentially and is unique to each instrument.

1-11. If the serial number prefix of your instrument is greater than the one listed on the title page, a yellow Manual Changes supplement will explain how to adapt this manual to your instrument.

1-12. If the serial number prefix of your instrument is lower than the one listed on the title page, information contained in Section VII (Manual Backdating) will explain how to adapt this manual to your instrument.

**1-13. SPECIFICATIONS**

1-14. Specifications for the HP 3457A Multimeter are listed in Table 1-1. These specifications are the performance standards which the instrument is guaranteed to meet.

Table 1-1. Specifications

DC VOLTS						
INPUT CHARACTERISTICS:						
RANGE	MAXIMUM READING	RESOLUTION				
		6 1/2 digits	5 1/2 digits	4 1/2 digits	3 1/2 digits	3 1/2 digits
30 mV	30.30000 mV	10 nV	100 nV	1 $\mu$ V	10 $\mu$ V	100 $\mu$ V
300 mV	303.0000 mV	100 nV	1 $\mu$ V	10 $\mu$ V	100 $\mu$ V	1 mV
3 V	3.030000 V	1 $\mu$ V	10 $\mu$ V	100 $\mu$ V	1 mV	10 mV
30 V	30.30000 V	10 $\mu$ V	100 $\mu$ V	1 mV	10 mV	100 mV
300 V	303.0000 V	100 $\mu$ V	1 mV	10 mV	100 mV	

INPUT RESISTANCE (OHMS):  
 30 millivolt through 3 volt range - 10 gigaohms  
 30 volt and 300 volt range - 10 megohms (+/- 1%)

MAXIMUM INPUT VOLTAGE: (non-destructive)  
 HI or LO to Earth Ground:  $\pm$  450V peak

MEASUREMENT ACCURACY:  $\pm$ (% of reading + Number of Counts)  
 Auto-Zero ON

24 HOUR:  $T_{cal} \pm 1^{\circ}C$  2 hour warm-up Accuracy relative to calibration standard  
 24 hour specifications apply if the instrument is calibrated between 90 and 100% of full-scale. For calibration between 33 and 90% of full-scale, add .00015% to % Reading.

RANGE	% READING	NUMBER OF COUNTS					
		100 PLC* 6 1/2 digits	10 PLC* 6 1/2 digits	1 PLC* 6 1/2 digits	.1 PLC* 5 1/2 digits	.005 PLC* 4 1/2 digits	.0005 PLC* 3 1/2 digits
30 mV	0.0012	215	235	350	55	17	6
300 mV	0.0005	24	25	35	7	4	4
3 V	0.00035	5	6	6	4	4	4
30 V	0.00065	9	10	20	6	4	4
300 V	0.0025	5	6	6	4	4	4

90 DAY:  $T_{cal} \pm 5^{\circ}C$  After 1 hour warm-up

RANGE	% READING	NUMBER OF COUNTS					
		100 PLC* 6 1/2 digits	10 PLC* 6 1/2 digits	1 PLC* 6 1/2 digits	.1 PLC* 5 1/2 digits	.005 PLC* 4 1/2 digits	.0005 PLC* 3 1/2 digits
30 mV	0.0040	365	385	500	70	19	6
300 mV	0.0025	39	40	50	9	4	4
3 V	0.0017	6	7	7	4	4	4
30 V	0.0035	19	20	30	7	4	4
300 V	0.0050	6	7	7	4	4	4

Table 1-1. Specifications

DC VOLTS (Cont'd)

1 YEAR: Tcal ± 5°C After 1 hour warm-up

RANGE	% READING	NUMBER OF COUNTS					
		100 PLC* 6 1/2 digits	10 PLC* 6 1/2 digits	1 PLC* 6 1/2 digits	.1 PLC* 5 1/2 digits	.005 PLC* 4 1/2 digits	.0005 PLC* 3 1/2 digits
30 mV	0.0045	365	385	500	70	19	6
300 mV	0.0035	39	40	50	9	4	4
3 V	0.0025	6	7	7	4	4	4
30 V	0.0040	19	20	30	7	4	4
300 V	0.0055	6	7	7	4	4	4

\* PLC = Integration Time in Power Line Cycles. When using integration times of 100 PLC, 10 PLC, or 1PLC; multiply Number of Counts in the Measurement Accuracy Tables by 0.1 for 5 1/2 digit readings, 0.01 for 4 1/2 digit readings and 0.001 for 3 1/2 digit readings.

Tcal = the temperature of the environment where the 3457A was calibrated. Calibration should be performed with the environment temperature between 18 and 28 degrees centigrade.

TEMPERATURE COEFFICIENT: ±(% of Reading + Number of Counts)/°C  
6 1/2 Digits Displayed

RANGE	Auto-Zero ON	Auto-Zero OFF*
30 mV	.0005 + 30	.0005 + 40
300 mV	.0005 + 3	.0005 + 13
3 V	.0005 + .3	.0005 + 10.3
30 V	.0005 + 1.0	.0005 + 11.0
300 V	.0005 + .3	.0005 + 10.3

\* Specifications given are for a stable environment (± 1°C) and over a ten minute period. Multiply Number of Counts by 0.1 for 5 1/2 digit readings, 0.01 for 4 1/2 digit readings and 0.001 for 3 1/2 digit readings.

NOISE REJECTION:

With 1 Kohm imbalance in the LO lead and line frequency (50 or 60 Hz) ± 0.08%.

	INTEGRATION TIME					
	100 PLC	10 PLC	1 PLC	.1 PLC	.005 PLC	.0005 PLC
AC NMR	90 db	80 db	60 db	0 db	0 db	0 db
AC ECMR	160 db	156 db	136 db	76 db	76 db	76 db
DC CMR	140 db	140 db	140 db	140 db	140 db	140 db

Table 1-1. Specifications

## DC VOLTS (Cont'd)

MAXIMUM READING RATES: (Readings/Second)

INTEGRATION TIME	DIGITS DISPLAYED	READING RATE	
		60 HZ	50 Hz
0.0005 PLC	3 1/2	1350	1350
0.005 PLC	4 1/2	1250	1250
0.1 PLC	5 1/2	360	312
1 PLC	6 1/2	53	45
10 PLC	6 1/2	4.8	4.0
100 PLC	6 1/2	.48	.40

Reading Rates apply with the keyboard lock ON, Auto-Zero OFF, Display OFF, Math Function OFF, Delay Time set to 0.0, Manual ranging, readings stored in internal memory using Timer Trigger and single precision integer format.

## DC CURRENT

INPUT CHARACTERISTICS:

RANGE	MAXIMUM READING	RESOLUTION				SHUNT RESISTANCE
		6 1/2 digits	5 1/2 digits	4 1/2 digits	3 1/2 digits	
300 $\mu$ A	303.0000 $\mu$ A	100 pA	1 nA	10 nA	100 nA	1000 Ohm
3 mA	3.030000 mA	1 nA	10 nA	100 nA	1 $\mu$ A	100 Ohm
30 mA	30.30000 mA	10 nA	100 nA	1 $\mu$ A	10 $\mu$ A	10 Ohm
300 mA	303.0000 mA	100 nA	1 $\mu$ A	10 $\mu$ A	100 $\mu$ A	1 Ohm
1 A	1.000000 A	1 $\mu$ A	10 $\mu$ A	100 $\mu$ A	1 mA	.1 Ohm

MAXIMUM BURDEN VOLTAGE: 0.35V - 300 $\mu$ A, 3mA and 30mA ranges. 0.6V - 300mA range. 1 V - 1A range.

MEASUREMENT ACCURACY:  $\pm$ (% of reading + Number of Counts)  
After 1 hour warmup, with Auto-zero ON.

24 HOUR: Tcal  $\pm$  1 $^{\circ}$ C After two hour warm-up. Accuracy relative to calibration standard.

RANGE	% READING	NUMBER OF COUNTS					
		100 PLC* 6 1/2 digits	10 PLC* 6 1/2 digits	1 PLC* 6 1/2 digits	.1 PLC* 5 1/2 digits	.005 PLC* 4 1/2 digits	.0005 PLC* 3 1/2 digits
300 $\mu$ A	0.0020	54	54	65	9	5	4
3 mA	0.002	54	54	65	9	5	4
30 mA	0.0020	54	54	65	9	5	4
300 mA	0.03	154	154	165	19	6	4
1 A	0.03	504	504	515	54	9	5



Table 1-1. Specifications

DC CURRENT (Cont'd)

90 DAY:  $T_{cal} \pm 5^{\circ}C$  After one hour warm-up.

RANGE	% READING	NUMBER OF COUNTS					
		100 PLC* 6 1/2 digits	10 PLC* 6 1/2 digits	1 PLC* 6 1/2 digits	.1 PLC* 5 1/2 digits	.005 PLC* 4 1/2 digits	.0005 PLC* 3 1/2 digits
300 $\mu A$	0.020	104	104	115	14	5	4
3 mA	0.020	104	104	115	14	5	4
30 mA	0.020	104	104	115	14	5	4
300 mA	0.070	204	204	215	24	6	4
1 A	0.070	604	604	615	64	10	5

1 YEAR:  $T_{cal} \pm 5^{\circ}C$  After one hour warm-up.

RANGE	% READING	NUMBER OF COUNTS					
		100 PLC* 6 1/2 digits	10 PLC* 6 1/2 digits	1 PLC* 6 1/2 digits	.1 PLC* 5 1/2 digits	.005 PLC* 4 1/2 digits	.0005 PLC* 3 1/2 digits
300 $\mu A$	0.04	104	104	115	14	5	4
3 mA	0.04	104	104	115	14	5	4
30 mA	0.04	104	104	115	14	5	4
300 mA	0.08	204	204	215	24	6	4
1 A	0.08	604	604	615	64	10	5

\* PLC = Integration Time in Power Line Cycles. When using integration times of 100 PLC, 10 PLC, or 1PLC; multiply Number of Counts in the Measurement Accuracy Tables by 0.1 for 5 1/2 digit readings, 0.01 for 4 1/2 digit readings and 0.001 for 3 1/2 digit readings.

$T_{cal}$  = the temperature of the environment where the 3457A was calibrated. Calibration should be performed with the environment temperature between 18 and 28 degrees centigrade.

TEMPERATURE COEFFICIENT:  $\pm(\% \text{ of Reading} + \text{Number of Counts})/^{\circ}C$   
6 1/2 Digits Displayed

RANGE	Auto-Zero ON	Auto-Zero OFF*
300 $\mu A$	.002 + 20	.002 + 30
3 mA	.002 + 20	.002 + 30
30 mA	.002 + 20	.002 + 30
300 mA	.007 + 20	.007 + 30
1 A	.007 + 20	.007 + 30

\* Specifications given are for a stable environment ( $\pm 1^{\circ}C$ ) and over a ten minute period. Multiply Number of Counts by 0.1 for 5 1/2 digit readings, 0.01 for 4 1/2 digit readings and 0.001 for 3 1/2 digit readings.

Table 1-1. Specifications

## DC CURRENT (Cont'd)

MAXIMUM READING RATES: (Readings/Second)

INTEGRATION TIME	DIGITS DISPLAYED	READING RATE	
		60 HZ	50 HZ
0.0005 PLC	3 1/2	1350	1350
0.005 PLC	4 1/2	1250	1250
0.1 PLC	5 1/2	360	312
1 PLC	6 1/2	53	45
10 PLC	6 1/2	4.8	4.0
100 PLC	6 1/2	.48	.40

Reading Rates apply with the keyboard lock ON, Auto-Zero OFF, Display OFF, Math Function OFF, Delay Time set to 0.0, Manual ranging, readings stored in internal memory using Timer Trigger and single precision integer format.

**RESISTANCE**  
(2-Wire Ohms, 4-Wire Ohms, Offset Compensated Ohms)

INPUT CHARACTERISTICS:

RANGE (OHMS)	MAXIMUM READING	RESOLUTION				CURRENT THROUGH UNKNOWN
		6 1/2 digits	5 1/2 digits	4 1/2 digits	3 1/2 digits	
30	30.30000 Ohm	10 uOhm	100 uOhm	1 mOhm	10 mOhm	1 mA
300	303.0000 Ohm	100 uOhm	1 mOhm	10 mOhm	100 mOhm	1 mA
3 k	3.030000KOhm	1 mOhm	10 mOhm	100 mOhm	1 Ohm	1 mA
30 k	30.30000KOhm	10 mOhm	100 mOhm	1 Ohm	10 Ohm	100 uA
300 k	303.0000KOhm	100 mOhm	1 Ohm	10 Ohm	100 Ohm	10 uA
3 M	3.030000MOhm	1 Ohm	10 Ohm	100 Ohm	1 KOhm	1 uA
30 M	30.30000MOhm	10 Ohm	100 Ohm	1 KOhm	10 KOhm	100 nA
300 M*	303.0000MOhm	100 Ohm	1 KOhm	10 KOhm	100 KOhm	100 nA
3 G*	3.030000GOhm	1 KOhm	10 KOhm	100 KOhm	1 MOhm	100 nA

\* On the Extended Ohms ranges (300 MOhm & 3 GOhm), the current source is 100 nA in parallel with 10 MOhms.

INPUT PROTECTION: (non-destructive)

HI sense to LO sense:  $\pm 350V$  peak.HI or LO to Earth ground:  $\pm 450V$  peak.

MAXIMUM OPEN CIRCUIT VOLTAGE:

30 Ohm to 3 Megohm ranges: 12 volts

30 Megohm to 3 Gigaohm ranges: 8.5 volts

Table 1-1. Specifications

RESISTANCE (Cont'd)

MEASUREMENT ACCURACY - FOUR-WIRE OHMS:  $\pm$ (% of reading + Number of Counts)  
 Auto-zero ON.

24 HOUR: Tcal  $\pm$  1°C  
 After two hour warm-up. Accuracy relative to calibration standard.

RANGE (OHMS)	% READING	NUMBER OF COUNTS					
		100 PLC* 6 1/2 digits	10 PLC* 6 1/2 digits	1 PLC* 6 1/2 digits	.1 PLC* 5 1/2 digits	.005 PLC* 4 1/2 digits	.0005 PLC* 3 1/2 digits
30	0.003	215	235	350	55	17	6
300	0.0015	24	25	35	6	4	4
3 K	0.001	5	6	6	4	4	4
30 K	0.001	5	6	6	4	4	4
300 K	0.001	6	7	8	4	4	4
3 M	0.003	12	14	16	7	5	5
30 M	0.02	80	83	93	14	6	4

90 DAY: Tcal  $\pm$  5°C  
 After one hour warm-up.

RANGE (OHMS)	% READING	NUMBER OF COUNTS					
		100 PLC* 6 1/2 digits	10 PLC* 6 1/2 digits	1 PLC* 6 1/2 digits	.1 PLC* 5 1/2 digits	.005 PLC* 4 1/2 digits	.0005 PLC* 3 1/2 digits
30	0.0065	315	335	450	65	18	6
300	0.0045	34	35	45	8	4	4
3 K	0.0035	6	7	7	4	4	4
30 K	0.0035	6	7	7	4	4	4
300 K	0.004	7	8	9	4	4	4
3 M	0.0055	12	14	16	7	5	5
30 M	0.025	80	83	93	14	6	5

1 YEAR: Tcal  $\pm$  5°C  
 After one hour warm-up.

RANGE (OHMS)	% READING	NUMBER OF COUNTS					
		100 PLC* 6 1/2 digits	10 PLC* 6 1/2 digits	1 PLC* 6 1/2 digits	.1 PLC* 5 1/2 digits	.005 PLC* 4 1/2 digits	.0005 PLC* 3 1/2 digits
30	0.0075	315	335	450	65	18	6
300	0.0055	34	35	45	8	4	4
3 K	0.005	6	7	7	4	4	4
30 K	0.005	6	7	7	4	4	4
300 K	0.005	7	8	9	4	4	4
3 M	0.0065	12	14	16	7	5	5
30 M	0.04	80	83	93	14	6	5

Table 1-1. Specifications

## RESISTANCE (Cont'd)

MEASUREMENT ACCURACY - TWO-WIRE OHMS:  $\pm$ (% of reading + number of counts)  
Auto-zero ON.

24 HOUR: Tcal  $\pm$  1°C  
After two hour warm-up.

RANGE (OHMS)	% READING	NUMBER OF COUNTS					
		100 PLC* 6 1/2 digits	10 PLC* 6 1/2 digits	1 PLC* 6 1/2 digits	.1 PLC* 5 1/2 digits	.005 PLC* 4 1/2 digits	.0005 PLC* 3 1/2 digits
30	0.003	20215	20235	20350	20055	20017	20006
300	0.0015	2024	2025	2035	2006	2004	2004
3 K	0.001	205	206	206	204	204	204
30 K	0.001	25	26	26	24	24	24
300 K	0.001	8	9	10	6	6	6
3 M	0.003	12	14	16	7	5	5
30 M	0.02	80	83	93	14	6	4
300 M*	0.6	1000	1000	1000	100	10	1
3 G*	6.0	1000	1000	1000	100	10	1

\* Specifications apply for a stable environment ( $\pm$ 1°C) and after Ohms Auto-Cal (Auto-Cal 3).

90 DAY: Tcal  $\pm$  5°C  
After one hour warm-up.

RANGE (OHMS)	% READING	NUMBER OF COUNTS					
		100 PLC* 6 1/2 digits	10 PLC* 6 1/2 digits	1 PLC* 6 1/2 digits	.1 PLC* 5 1/2 digits	.005 PLC* 4 1/2 digits	.0005 PLC* 3 1/2 digits
30	0.0065	20315	20335	20450	20065	20018	20006
300	0.0045	2034	2035	2045	2008	2004	2004
3 K	0.0035	206	207	207	204	204	204
30 K	0.0035	26	27	27	24	24	24
300 K	0.004	9	10	11	6	6	6
3 M	0.0055	12	14	16	7	5	5
30 M	0.025	80	83	93	14	6	5
300 M	1.6	1000	1000	1000	100	10	1
3 G	16.0	1000	1000	1000	100	10	1

Table 1-1. Specifications

RESISTANCE (Cont'd)

1 YEAR:  $T_{cal} \pm 5^{\circ}C$

After one hour warm-up.

RANGE (OHMS)	% READING	NUMBER OF COUNTS					
		100 PLC* 6 1/2 digits	10 PLC* 6 1/2 digits	1 PLC* 6 1/2 digits	.1 PLC* 5 1/2 digits	.005 PLC* 4 1/2 digits	.0005 PLC* 3 1/2 digits
30	0.0075	20315	20335	20450	20065	20018	20006
300	0.0055	2034	2035	2045	2008	2004	2004
3 K	0.005	206	207	207	204	204	204
30 K	0.005	26	27	27	24	24	24
300 K	0.005	9	10	11	6	6	6
3 M	0.0065	12	14	16	7	5	5
30 M	0.04	80	83	93	14	6	5
300 M	1.6	1000	1000	1000	100	10	1
3 G	16.0	1000	1000	1000	100	10	1

\* PLC = Integration Time in Power Line Cycles. When using integration times of 100 PLC, 10 PLC, or 1PLC; multiply Number of Counts in the Measurement Accuracy Tables by 0.1 for 5 1/2 digit readings, 0.01 for 4 1/2 digit readings and 0.001 for 3 1/2 digit readings.

$T_{cal}$  = the temperature of the environment where the 3457A was calibrated. Calibration should be performed with the environment temperature between 18 and 28 degrees centigrade.

TEMPERATURE COEFFICIENT:  $\pm(\% \text{ of Reading} + \text{Number of Counts})/^{\circ}C$   
6 1/2 Digits Displayed

RANGE	Auto-Zero ON	Auto-Zero OFF*
30	.0005 + 50	.0005 + 510
300	.0005 + 5.0	.0005 + 60
3 K	.0005 + 0.5	.0005 + 15
30 K	.0005 + 0.5	.0005 + 15
300 K	.0008 + 0.5	.0008 + 15
3 M	.0010 + 0.5	.0010 + 15
30 M	.0025 + 0.5	.0025 + 15
300 M	.3500 + 0.0	.3500 + 10
3 G	3.5000 + 0.0	3.5000 + 10

\* Specifications given are for a stable environment ( $\pm 1^{\circ}C$ ) and over a ten minute period. For integration times of  $\geq 1$  PLC, multiply Number of Counts by 0.1 for 5 1/2 digit readings, 0.01 for 4 1/2 digit readings and 0.001 for 3 1/2 digit readings.

Table 1-1. Specifications

RESISTANCE (Cont'd)			
RANGE (OHMS)	MAXIMUM LEAD RESISTANCE FOUR-WIRE OHMS	MAXIMUM OFFSET VOLTAGE FOR OFFSET COMPENSATED OHMS (FULL SCALE)	PRE-PROGRAMMED SETTLING TIME
30	1 Ohm	1 mV	560 usec
300	10 Ohm	10 mV	350 usec
3 K	100 Ohm	100 mV	350 usec
30 K	1 KOhm	not applicable	350 usec
300 K	10 KOhm	not applicable	2.4 msec
3 M	100 KOhm	not applicable	24 msec
30 M	1 MOhm	not applicable	240 msec
300 M	not applicable	not applicable	2.4 sec
3 G	not applicable	not applicable	2.5 sec

**RESPONSE TIME:**  
First reading meets accuracy specification with pre-programmed settling times and <200 pF circuit capacitance. An additional delay of 0.1 seconds is necessary after a range or function change to meet rated accuracy.

**MAXIMUM READING RATES: (Readings/Second)**  
30 Ohm to 30 KOhm ranges

INTEGRATION TIME	DIGITS DISPLAYED	READING RATE	
		60 HZ	50 Hz
0.0005 PLC	3 1/2	1350	1350
0.005 PLC	4 1/2	1250	1250
0.1 PLC	5 1/2	360	312
1 PLC	6 1/2	53	45
10 PLC	6 1/2	4.8	4.0
100 PLC	6 1/2	.48	.40

Reading Rates apply with the keyboard lock ON, Auto-Zero OFF, Display OFF, Math Function OFF, Delay Time set to 0.0, Manual ranging, readings stored in internal memory using Timer Trigger and single precision integer format.

Table 1-1. Specifications

TRUE RMS AC VOLTAGE  
(AC and DC Coupled)

INPUT CHARACTERISTICS:

RANGE	MAXIMUM READING	RESOLUTION			
		6 1/2 digits	5 1/2 digits	4 1/2 digits	3 1/2 digits
30 mV	32.50000 mV	10 nV	100 nV	1 $\mu$ V	10 $\mu$ V
300 mV	325.0000 mV	100 nV	1 $\mu$ V	10 $\mu$ V	100 $\mu$ V
3 V	3.250000 V	1 $\mu$ V	10 $\mu$ V	100 $\mu$ V	1 mV
30 V	32.50000 V	10 $\mu$ V	100 $\mu$ V	1 mV	10 mV
300 V	303.0000 V	100 $\mu$ V	1 mV	10 mV	100 mV

INPUT IMPEDANCE:

1 megohm  $\pm$ 1% shunted by < 90 pF (< 115 pF rear input).

MAXIMUM INPUT VOLTAGE: (non-destructive)

Input Terminals:  $\pm$  450V peak.

HI or LO to Earth Ground:  $\pm$  450V peak.

CREST FACTOR: 3.5 to 1 at full-scale.

MEASUREMENT ACCURACY - AC COUPLED:  $\pm$ (% of reading + number of counts)

Specifications apply for sine-wave inputs > 10% of range with DC component < 10% of the AC component, with Auto-zero ON, AC slow filter ON (ACBAND 20), and after 2 hour warm-up.

For AC inputs between 3% and 10% of full-scale and < 20KHz, add 0.7% to the percent of reading figures.

For pre-programmed settling times, add .1% of input voltage step to accuracy specifications for the first reading.

24 HOUR: Tcal  $\pm$  1°C (ACV Function) After 2 hour warm-up Accuracy relative to calibration standard 30 mV to 30 V ranges.

FREQUENCY	PERCENT OF READING	NUMBER OF COUNTS			
		$\geq$ 1 PLC 6 1/2 digits	0.1 PLC 5 1/2 digits	.005 PLC 4 1/2 digits	.0005 PLC 3 1/2 digits
20Hz-45Hz	0.5	720	76	12	6
45Hz-100Hz	0.15	720	76	12	6
100Hz-20KHz	0.07	720	76	12	6
** 400Hz-20KHz	0.08	720	510	55	10
20KHz-100KHz	0.6	1700	184	23	7
100KHz-300KHz	3.1	9300	934	98	14
300KHz-1MHz	10.1	66000	6600	664	71

Table 1-1. Specifications

## TRUE RMS AC VOLTAGE (Cont'd)

24 HOUR: Tcal  $\pm 1^\circ\text{C}$  (ACV Function) After 2 hour warm-up Accuracy relative to calibration standard 300 V range.

FREQUENCY	PERCENT OF READING	NUMBER OF COUNTS			
		$\geq 1$ PLC 6 1/2 digits	0.1 PLC 5 1/2 digits	.005 PLC 4 1/2 digits	.0005 PLC 3 1/2 digits
20Hz-45Hz	0.56	720	76	12	6
45Hz-100Hz	0.21	720	76	12	6
100Hz-20KHz	0.13	720	76	12	6
** 400Hz-20KHz	0.14	720	510	55	10
20KHz-100KHz	1.0	3300	334	38	8

90 DAY: Tcal  $\pm 5^\circ\text{C}$  (ACV Function) After 1 hour warm-up  
30 mV to 30 V ranges.

FREQUENCY	* PERCENT OF READING	NUMBER OF COUNTS			
		$\geq 1$ PLC 6 1/2 digits	0.1 PLC 5 1/2 digits	.005 PLC 4 1/2 digits	.0005 PLC 3 1/2 digits
20Hz-45Hz	0.56	1120	116	16	6
45Hz-100Hz	0.21	1120	116	16	6
100Hz-20KHz	0.13	1120	116	16	6
** 400Hz-20KHz	0.14	1120	550	59	10
20KHz-100KHz	0.66	2100	224	27	7
100KHz-300KHz	3.16	9700	974	102	14
300KHz-1MHz	10.16	66400	6640	668	71

90 DAY: Tcal  $\pm 5^\circ\text{C}$  (ACV Function) After 1 hour warm-up  
300 V range.

FREQUENCY	* PERCENT OF READING	NUMBER OF COUNTS			
		$\geq 1$ PLC 6 1/2 digits	0.1 PLC 5 1/2 digits	.005 PLC 4 1/2 digits	.0005 PLC 3 1/2 digits
20Hz-45Hz	0.62	1120	116	16	6
45Hz-100Hz	0.27	1120	116	16	6
100Hz-20KHz	0.19	1120	116	16	6
** 400Hz-20KHz	0.2	1120	550	59	10
20KHz-100KHz	1.06	3700	374	42	8

\* Specifications apply within one week of AC auto-cal (ACAL 2) for stable temperature conditions. (Tcal  $\pm 5^\circ\text{C}$ ). If AC auto-cal is not used, add 0.6 to the percent of reading figures.

\*\* Using AC fast filter (ACBAND 400) for frequencies above 400Hz.

For 1 year specifications, add .1% to 24 hour percent of reading figures, add 600 to 6 1/2 digit counts, add 60 to 5 1/2 digit counts, add 6 to 4 1/2 digit counts, add .6 to 3 1/2 digit counts (Tcal  $\pm 5^\circ\text{C}$ ).



Table 1-1. Specifications

TRUE RMS AC VOLTAGE (Cont'd)

TEMPERATURE COEFFICIENT - AC COUPLED: All Ranges.

FREQUENCY	PERCENT READING	NUMBER OF COUNTS			
		6 1/2 digits	5 1/2 digits	4 1/2 digits	3 1/2 digits
* 20Hz-100kHz	0.01	150	15	1.5	0.15
100kHz-1MHz	0.08	300	30	3	0.3

\* For AC inputs between 3% and 10% of full-scale and < 20kHz, add .04% to percent reading.

MEASUREMENT ACCURACY - DC COUPLED:  $\pm$ (% of reading + number of counts)

Accuracy specified for sine-wave inputs > 10% of range with DC component < 10% of the AC component from a source impedance of <10 kOhms, with Auto-zero ON, AC slow filter ON (ACBAND 20), and after 2 hr warm-up. For DC component >10% of the AC component, allow an additional 1.5 sec. settling time for correct first reading, add .14% to the applicable percent of reading figures, add 23000 to the 6 1/2 digit counts, add 2300 to the 5 1/2 digit counts, add 230 to the 4 1/2 digit counts, add 23 to the 3 1/2 digit counts.

For pre-programmed settling times, add .1% of input voltage step to accuracy specifications for the first reading.

24 HOUR: Tcal  $\pm$  1°C (ACDCV Function) After 2 hour warm-up Accuracy relative to calibration std 30 mV to 30 V ranges

FREQUENCY	PERCENT OF READING	NUMBER OF COUNTS			
		$\geq$ 1 PLC 6 1/2 digits	0.1 PLC 5 1/2 digits	.005 PLC 4 1/2 digits	.0005 PLC 3 1/2 digits
20Hz-45Hz	1.3	1500	154	20	6
45Hz-100Hz	0.11	1500	154	20	6
100Hz-20kHz	0.11	1500	154	20	6
** 400Hz-20kHz	0.38	1500	2600	264	31
20kHz-100kHz	0.6	2520	256	30	7
100kHz-300kHz	3.1	9300	934	98	14
300kHz-1MHz	10.1	67500	6750	680	72

24 HOUR: Tcal  $\pm$  1°C (ACDCV Function) After 2 hour warm-up Accuracy relative to calibration std 300 V range

FREQUENCY	PERCENT OF READING	NUMBER OF COUNTS			
		$\geq$ 1 PLC 6 1/2 digits	0.1 PLC 5 1/2 digits	.005 PLC 4 1/2 digits	.0005 PLC 3 1/2 digits
20Hz-45Hz	1.3	1500	154	20	6
45Hz-100Hz	0.17	1500	154	20	6
100Hz-20kHz	0.17	1500	154	20	6
** 400Hz-20kHz	0.44	1500	2600	264	31
20kHz-100kHz	1.1	4320	440	48	9

Table 1-1. Specifications

## TRUE RMS AC VOLTAGE (Cont'd)

90 DAY: Tcal  $\pm 5^{\circ}\text{C}$  (ACDCV Function) After 1 hour warm-up  
30 mV to 300 V ranges

FREQUENCY	* PERCENT OF READING	NUMBER OF COUNTS			
		$\geq 1$ PLC 6 1/2 digits	0.1 PLC 5 1/2 digits	.005 PLC 4 1/2 digits	.0005 PLC 3 1/2 digits
20Hz-45Hz	1.36	3600	364	41	8
45Hz-100Hz	0.17	3600	364	41	8
100Hz-20KHz	0.17	3600	364	41	8
** 400Hz-20KHz	0.44	3600	2810	285	33
20KHz-100KHz	0.66	4620	466	51	9
100KHz-300KHz	3.16	11400	1144	119	16
300KHz-1MHz	10.16	69600	6960	701	74

90 DAY: Tcal  $\pm 1^{\circ}\text{C}$  (ACDCV Function) After 1 hour warm-up  
300 V range

FREQUENCY	PERCENT OF READING	NUMBER OF COUNTS			
		$\geq 1$ PLC 6 1/2 digits	0.1 PLC 5 1/2 digits	.005 PLC 4 1/2 digits	.0005 PLC 3 1/2 digits
20Hz-45Hz	1.36	3600	364	41	8
45Hz-100Hz	0.23	3600	364	41	8
100Hz-20KHz	0.23	3600	364	41	8
** 400Hz-20KHz	0.5	3600	2810	285	33
20KHz-100KHz	1.16	6420	650	69	11

\* Specifications apply within one week of AC auto-cal (ACAL 2) for stable temperature conditions (Tcal  $\pm 5^{\circ}\text{C}$ ). If AC auto-cal is not used, add 0.6 to the percent of reading figures, add 39000 to the 6 1/2 digit counts, add 3900 to the 5 1/2 digit counts, add 390 to the 4 1/2 digit counts and 39 to the 3 1/2 digit counts.

\*\* Using AC fast filter (ACBAND 400) for frequencies above 400Hz.

For 1 year specifications, add .1% to 24 hour percent of reading figures, add 2100 to 6 1/2 digit counts, add 210 to the 5 1/2 digit counts, add 21 to the 4 1/2 digit counts, add 2.1 to the 3 1/2 digit counts.

TEMPERATURE COEFFICIENT - DC COUPLED: 300 mV, 30 V and 300 V ranges.

FREQUENCY	PERCENT READING	NUMBER OF COUNTS			
		6 1/2 digits	5 1/2 digits	4 1/2 digits	3 1/2 digits
20Hz-100KHz	0.01	1000	100	10	1.0
101KHz-1MHz	0.08	1300	130	13	1.3

Table 1-1. Specifications

**TRUE RMS AC VOLTAGE (Cont'd)**

TEMPERATURE COEFFICIENT - DC COUPLED: 30 mV and 3 V ranges.

FREQUENCY	PERCENT READING	NUMBER OF COUNTS			
		6 1/2 digits	5 1/2 digits	4 1/2 digits	3 1/2 digits
20Hz-100KHz	0.01	5700	570	57	5.7
101KHz-1MHz	0.08	6000	600	60	6.0

COMMON MODE REJECTION:

With 1 KOhm imbalance in LO lead, > 76 db from DC to 60 Hz.

MAXIMUM READING RATES: (Readings/Second)

INTEGRATION TIME	DIGITS DISPLAYED	READING RATE			
		* AC SLOW RESPONSE		* AC FAST RESPONSE	
		60 Hz	50 Hz	60 Hz	50 Hz
0.0005 PLC	3 1/2	1.0	1.0	9.5	9.5
0.005 PLC	4 1/2	1.0	1.0	9.5	9.5
0.1 PLC	5 1/2	1.0	1.0	9.25	9.2
1 PLC	6 1/2	1.0	1.0	7.25	6.9
10 PLC	6 1/2	0.7	0.65	2.0	1.7
100 PLC	6 1/2	0.2	0.17	0.25	0.2

Reading Rates apply with Auto-zero ON, fixed range and preprogrammed settling times.

\* ACBAND set to < 400 for AC slow response and set to > 400 for AC fast response.

**TRUE RMS AC CURRENT (AC and DC Coupled)**

INPUT CHARACTERISTICS:

RANGE	MAXIMUM READING 6 1/2 digits	RESOLUTION			
		=> 1 PLC 6 1/2 digits	0.1 PLC 5 1/2 digits	.005 PLC 4 1/2 digits	.0005 PLC 3 1/2 digits
30 mA	32.50000 mA	10 nA	100 nA	1 uA	10 uA
300 mA	325.00000 mA	100 nA	1 uA	10 uA	100 uA
1 A	1.0000000 A	1 uA	10 uA	100 uA	1 mA

MAXIMUM INPUT: (non-destructive)

1.5 Amps from 250 volt source. Input is fuse protected.

MAXIMUM BURDEN VOLTAGE:

1 Vrms at 1 Arms input for frequencies < 20 KHz.

CREST FACTOR: > 3.5 to 1 at full-scale.

Table 1-1. Specifications

## TRUE RMS AC CURRENT (Cont'd)

MEASUREMENT ACCURACY - AC COUPLED:  $\pm$ (% of reading + number of counts)

After two hour warm-up.

Sine-wave inputs &gt; 10% of range.

AC slow filter ON (ACBAND 20).

Auto-zero ON.

For pre-programmed settling times, error is &lt; 0.1% of input current step.

24 HOUR:  $T_{cal} \pm 1^{\circ}C$  (ACI Function) After 2 hour warm-up Accuracy relative to calibration standard 30 mA and 300 mA ranges.

FREQUENCY	PERCENT OF READING	NUMBER OF COUNTS			
		$\geq 1$ PLC 6 1/2 digits	0.1 PLC 5 1/2 digits	.005 PLC 4 1/2 digits	.0005 PLC 3 1/2 digits
20Hz-45Hz	0.8	2800	290	32	7
46Hz-100Hz	0.25	2800	290	32	7
101Hz-20KHz	0.2	2800	290	32	7
** 400Hz-20KHz	0.2	2800	750	80	12
21KHz-100KHz	0.9	4000	400	42	8

24 HOUR:  $T_{cal} \pm 1^{\circ}C$  (ACI Function) After 2 hour warm-up Accuracy relative to calibration standard 1 A range. (1 amp maximum input)

FREQUENCY	PERCENT OF READING	NUMBER OF COUNTS			
		$\geq 1$ PLC 6 1/2 digits	0.1 PLC 5 1/2 digits	.005 PLC 4 1/2 digits	.0005 PLC 3 1/2 digits
20Hz-45Hz	0.9	2800	290	32	7
46Hz-100Hz	0.35	2800	290	32	7
101Hz-20KHz	0.30	2800	290	32	7
** 400Hz-20KHz	0.30	2800	750	80	12

90 DAY:  $T_{cal} \pm 5^{\circ}C$  (ACI Function) After 1 hour warm-up  
30 mA and 300 mA ranges.

FREQUENCY	* PERCENT OF READING	NUMBER OF COUNTS			
		$\geq 1$ PLC 6 1/2 digits	0.1 PLC 5 1/2 digits	.005 PLC 4 1/2 digits	.0005 PLC 3 1/2 digits
20Hz-45Hz	0.85	2800	290	32	7
46Hz-100Hz	0.3	2800	290	32	7
101Hz-20KHz	0.25	2800	290	32	7
** 400Hz-20KHz	0.25	2800	750	80	12
21KHz-100KHz	1.0	4000	400	42	8

Table 1-1. Specifications

## TRUE RMS AC CURRENT (Cont'd)

90 DAY: Tcal  $\pm 5^{\circ}\text{C}$  (ACI Function) After 1 hour warm-up  
1 A range. (1 amp maximum input)

FREQUENCY	* PERCENT OF READING	NUMBER OF COUNTS			
		$\geq 1$ PLC 6 1/2 digits	0.1 PLC 5 1/2 digits	.005 PLC 4 1/2 digits	.0005 PLC 3 1/2 digits
20Hz-45Hz	.95	2800	290	32	7
46Hz-100Hz	0.4	2800	290	32	7
101Hz-20KHz	0.35	2800	290	32	7
** 400Hz-20KHz	0.35	2800	750	80	12

\* Specifications apply within one week of AC auto-cal (ACAL 2) for stable temperature conditions. If AC auto-cal is not used, add 0.6 to the percent of reading figures. For 1 year specifications, add .08% to the 90 day Percent of Reading figures.

\*\* Using AC fast filter (ACBAND 400) for frequencies above 400Hz.

TEMPERATURE COEFFICIENT - AC COUPLED: All Ranges.

FREQUENCY	PERCENT READING	NUMBER OF COUNTS			
		6 1/2 digits	5 1/2 digits	4 1/2 digits	3 1/2 digits
20Hz-100KHz	0.017	150	15	1.5	0.15

MEASUREMENT ACCURACY - DC COUPLED:  $\pm$ (% of reading + number of counts)

After two hour warm-up.

Sine-wave inputs > 10% of range.

AC slow filter ON (ACBAND 20).

Auto-zero ON.

For pre-programmed settling times, error is 0.1% of input current step.

24 HOUR: Tcal  $\pm 1^{\circ}\text{C}$  (ACDCI Function) After 2 hour warm-up Accuracy relative to calibration std  
30 mA and 300 mA ranges.

FREQUENCY	PERCENT OF READING	NUMBER OF COUNTS			
		$\geq 1$ PLC 6 1/2 digits	0.1 PLC 5 1/2 digits	.005 PLC 4 1/2 digits	.0005 PLC 3 1/2 digits
20Hz-45Hz	1.5	16000	1600	165	20
46Hz-100Hz	0.35	16000	1600	165	20
101Hz-20KHz	0.25	16000	1600	165	20
** 400Hz-20KHz	0.6	16000	3750	375	42
21KHz-100KHz	0.9	17500	1750	180	22

Table 1-1. Specifications

## TRUE RMS AC CURRENT (Cont'd)

24 HOUR: Tcal  $\pm 1^{\circ}\text{C}$  (ACDCI Function) After 2 hour warm-up Accuracy relative to calibration std  
1 A range. (1 amp maximum input)

FREQUENCY	PERCENT OF READING	NUMBER OF COUNTS			
		$\geq 1$ PLC 6 1/2 digits	0.1 PLC 5 1/2 digits	.005 PLC 4 1/2 digits	.0005 PLC 3 1/2 digits
20Hz-45Hz	1.6	16000	1600	165	20
46Hz-100Hz	0.45	16000	1600	165	20
101Hz-20KHz	0.35	16000	1600	165	20
** 400Hz-20KHz	0.7	16000	3750	375	42

90 DAY: Tcal  $\pm 5^{\circ}\text{C}$  (ACDCI Function) After 1 hour warm-up  
30 mA and 300 mA ranges.

FREQUENCY	* PERCENT OF READING	NUMBER OF COUNTS			
		$\geq 1$ PLC 6 1/2 digits	0.1 PLC 5 1/2 digits	.005 PLC 4 1/2 digits	.0005 PLC 3 1/2 digits
20Hz-45Hz	1.55	16000	1600	165	20
46Hz-100Hz	0.4	16000	1600	165	20
101Hz-20KHz	0.3	16000	1600	165	20
** 400Hz-20KHz	0.65	16000	3750	375	42
21KHz-100KHz	0.95	17500	1750	180	22

90 DAY: Tcal  $\pm 1^{\circ}\text{C}$  (ACDCI Function) After 1 hour warm-up  
1 A range. (1 amp maximum input)

FREQUENCY	* PERCENT OF READING	NUMBER OF COUNTS			
		$\geq 1$ PLC 6 1/2 digits	0.1 PLC 5 1/2 digits	.005 PLC 4 1/2 digits	.0005 PLC 3 1/2 digits
20Hz-45Hz	1.65	16000	1600	165	20
46Hz-100Hz	0.5	16000	1600	165	20
101Hz-20KHz	0.4	16000	1600	165	20
** 400Hz-20KHz	0.75	16000	3750	375	42

\* Specifications apply within one week of AC auto-cal (ACAL 2) for stable temperature conditions. If AC auto-cal is not used, add 0.6 to the percent of reading figures, add 6000 to the 6 1/2 digit counts, add 600 to the 5 1/2 digit counts, add 60 to the 4 1/2 digit counts and 6 to the 3 1/2 digit counts.

For 1 year specifications, add .08% to the 90 day Percent of Reading figures.

\*\* Using AC fast filter (ACBAND 400) for frequencies above 400Hz.

Table 1-1. Specifications

**TRUE RMS AC CURRENT (Cont'd)**

TEMPERATURE COEFFICIENT - DC COUPLED: All Ranges.

FREQUENCY	PERCENT READING	NUMBER OF COUNTS			
		6 1/2 digits	5 1/2 digits	4 1/2 digits	3 1/2 digits
20Hz-100KHz	0.017	1500	150	15	1.5

MAXIMUM READING RATES: (Readings/Second)

INTEGRATION TIME	DIGITS DISPLAYED	READING RATE			
		* AC SLOW RESPONSE		* AC FAST RESPONSE	
		60 Hz	50 Hz	60 Hz	50 Hz
0.0005 PLC	3 1/2	1.0	1.0	9.5	9.5
0.005 PLC	4 1/2	1.0	1.0	9.5	9.5
0.1 PLC	5 1/2	1.0	1.0	9.25	9.2
1 PLC	6 1/2	1.0	1.0	7.25	6.9
10 PLC	6 1/2	0.7	0.65	2.0	1.7
100 PLC	6 1/2	0.2	0.17	0.25	0.2

Reading Rates apply with Auto-zero ON, fixed range and preprogrammed settling times.

\* ACBAND set to < 400 for AC slow response and set to > 400 for AC fast response.

**FREQUENCY AND PERIOD**

Measures the frequency or period of the ac component of ac or dc coupled voltage or current. The counter uses a reciprocal counting technique to provide constant resolution independent of the input frequency.

**INPUT IMPEDANCE:**

1 megohm shunted by < 90 picofarads.

**MAXIMUM INPUTS:**

**Voltage:**

Input Terminals - ± 450V peak.

HI or LO to Earth Ground - ± 450V peak.

**Current:**

1.5 amps from 250 volt source. Input is fuse protected.

**FREQUENCY RANGE:**

Voltage Function - 10Hz to 1.5MHz

Current Function - 10Hz to 100KHz

**PERIOD RANGE:**

Voltage Function - 100msec to 667nsec

Current Function - 100msec to 10usec

Table 1-1. Specifications

### FREQUENCY AND PERIOD (Cont'd)

**SENSITIVITY:**

10mV rms or 100uA rms sine-wave

**TRIGGERING:**

Triggers and counts on zero crossings.

**MEASUREMENT ACCURACY:  $\pm$ (% of reading)**

FREQUENCY	PERIOD	% OF READING
10Hz - 400Hz	100msec - 2.5msec	0.05
400Hz - 1.5MHz	2.5msec - 667nsec	0.01

**MAXIMUM READING RATE:**

2 readings/second (Integration time of 1 PLC, fast settling time, delay zero and math OFF, and fixed range)

### PLUG-IN OPTION 44491A Armature Relay Multiplexer Assembly

**INPUT CHARACTERISTICS:**

Eight two-wire armature relay channels and two current/actuator channels.

**MAXIMUM VOLTAGE: (Terminal to Terminal or Terminal to Chassis)**

250 VDC or 250 VAC rms

**MAXIMUM CURRENT: (per channel)**

1 amp DC or AC rms

**THERMAL OFFSET:**

&lt; 3 microvolts

**RELAY LIFE:** $10^7$  operations at maximum load (1.5 amps AC rms).**CLOSED CHANNEL RESISTANCE: (end of relay life)**

&lt; 2 ohms

**MAXIMUM SWITCHING AND MEASUREMENT SPEED:**

33 channels/second

**ADJACENT CHANNEL CROSSTALK: (Channels terminated into 50 ohms)**

-60 db @ 100KHz



Table 1-1. Specifications

**PLUG-IN OPTION**  
**44491A Armature Relay Multiplexer Assembly (Cont'd)**

**DC ISOLATION:**

Channels 0 - 7 (40°C, 95% Relative Humidity)  $10^{10}$  Ohms  
 Channels 8 and 9 (40°C, 95% Relative Humidity)  $10^9$  Ohms  
 Channels 0 - 7 (40°C, 60% Relative Humidity)  $10^{11}$  Ohms  
 Channels 8 and 9 (40°C, 60% Relative Humidity)  $10^{10}$  Ohms

**AC ISOLATION:**

Channels 0 - 7 Closed: 150 pF  
 Channels 0 - 7 Open: 10 pF  
 LO to Chassis: 420 pF

**PLUG-IN OPTION**  
**44492A Reed Relay Multiplexer Assembly**

**INPUT CHARACTERISTICS:**

Ten two-wire reed relay channels.

**MAXIMUM VOLTAGE:** (Terminal to Terminal or Terminal to Chassis)

125 volts peak to peak.

**THERMAL OFFSET:**

3 microvolts.

**RELAY LIFE:**

$10^7$  operations at maximum load (125 VAC peak to peak).

**CLOSED CHANNEL RESISTANCE:** (end of relay life)

< 4 ohms

**MAXIMUM SWITCHING AND MEASUREMENT SPEED:**

300 channels/second

**ADJACENT CHANNEL CROSSTALK:** (Channels terminated into 50 ohms)

-40 db @ 100KHz

**DC ISOLATION:**

Channels 0 - 9 (40°C, Relative Humidity 95%)  $10^9$  Ohms  
 Channels 0 - 9 (40°C, 60% Relative Humidity)  $10^{10}$  Ohms

**AC ISOLATION:**

Channels 0 - 9 Closed: 200 pF  
 Channels 0 - 9 Open: 15 pF  
 LO to Chassis: 420 pF

44492A operation is not specified for the 30 Ohm range or for frequencies above 100 KHz.

Table 1-1. Specifications

**GENERAL****OPERATING TEMPERATURE:**

0° to 55° C

**STORAGE TEMPERATURE:**

-40° to +75° C

**WARM-UP TIME:**

One hour to meet all specifications, except where noted.

**HUMIDITY RANGE:**

95% relative humidity for temperatures between 0° and 40° C.

**POWER REQUIREMENTS:**100/120/240 volts  $\pm 10\%$ , 48Hz to 66Hz. 30 VA maximum.**DIMENSIONS:**

Height - 89mm (3.5 ") (With feet removed), 100mm (4 ") (With feet)

Width - 425mm (16.75 ")

Depth - 292mm (11.5 ")

Allow 76mm (3 ") additional depth for wiring.

**NET WEIGHT:**

5.05 kgm (11.1 lbs)

**SHIPPING WEIGHT:**

9.3 kgm (20.5 lbs)

1-15. OPTIONS AND ACCESSORIES

1-16. Table 1-2. lists the options and accessories available for the HP 3457A Digital Multimeter:

Table 1-2. Available Options and Accessories

OPTION NUMBER Use this number when ordering with the HP 3457A	ACCESSORY NO. Use this number when ordering separately	DESCRIPTION of Option or Accessory
HP 44491A HP 44492A HP 44493A HP 44494A	HP 44491A HP 44492A HP 44493A HP 44494A	General Purpose Plug-in Assembly 10 Channel Multiplexer Assembly Extra Wiring Block for 44491A Extra Wiring Block for 44492A
Option 401 Option 907 Option 908 Option 909 Option 910	5061-1171 5061-1170 5061-1168 5061-1169 Order by Part No.	Side Handle Kit Front Handle Kit Rack Mount Kit Rack Mount with Front Handle Additional Set of 3457A Manuals
Option W30		2 Additional years of Return to HP hardware support
10833A 10833B 10833C 10833D	10833A 10833B 10833C 10833D	HP-IB Cable 1.0 meter (39.37 in) HP-IB Cable 2.0 meter (78.74 in) HP-IB Cable 4.0 meter (157.5 in) HP-IB Cable 0.5 meter (19.69 in)
34118 11096B 34111A HP 44414A 03457-10085 03457-10200	34118 11096B 34111A HP 44414A 03457-10085 03457-10200	Test Lead Kit RF Probe (700MHz) High Voltage Probe (40KVdc) Pack of 4 Thermistors Calibration Software for HP 85B Calibration Software for HP 200

1-17. TEST EQUIPMENT

1-18. Table 1-3 lists requirements for service equipment necessary to calibrate and repair the Model HP 3457A.

Table 1-3. Test Equipment Requirements

INSTRUMENT	CRITICAL SPECIFICATIONS	SUGGESTED MODEL	USE
DC VOLTAGE SOURCE	30mV $\pm$ .0055%, 300mV $\pm$ .0012% 1V, 2V & 3V $\pm$ .0006%, 30V $\pm$ .0013%, 300V $\pm$ .0017%	Datron Model 4000A	PAT
DC CURRENT SOURCE	300uA, 3mA & 30mA $\pm$ .007% 300mA $\pm$ .026%, 1A $\pm$ .04%	Datron Model 4000A	PAT
AC VOLTAGE SOURCE	1MHz - 30mVrms $\pm$ 10%, 300mVrms & 3Vrms $\pm$ 3% 300KHz - 30mVrms $\pm$ 2%, 300mVrms & 3Vrms $\pm$ 1% 100KHz - 30mVrms $\pm$ .6%, 300mVrms & 3Vrms $\pm$ .2% 20KHz - 30mVrms $\pm$ .3%, 300mVrms & 3Vrms $\pm$ .2% 6.5KHz - 30mVrms $\pm$ .3%, 300mVrms & 3Vrms $\pm$ .2% 1KHz - 30mVrms, 300mVrms, 1Vrms, 2Vrms, 3Vrms, 30Vrms & 300Vrms $\pm$ .1% 400Hz - 30mVrms $\pm$ .3%, 300mVrms & 3Vrms $\pm$ .2% 100Hz - 300mVrms & 3Vrms $\pm$ .1% 45Hz - 300mVrms & 3Vrms $\pm$ .3% 20Hz - 300mVrms & 3Vrms $\pm$ .3%	Datron Model 4200	PAT
AC CURRENT SOURCE	1KHz -30mA & 300mA $\pm$ .14%, 1A $\pm$ .24%	Datron Model 4200	PAT
RESISTANCE STANDARD	30ohms $\pm$ .004%, 300ohms $\pm$ .002%, 3Kohms $\pm$ .001% 30Kohm, 300Kohm & 3Mohm $\pm$ .001%, 30Mohm $\pm$ .009%	Datron Model 4000A	PAT
FREQUENCY SOURCE	20Hz $\pm$ .016%, 1MHz $\pm$ .003%	Datron Model 4200 or HP Model 3325A	PAT
FREQUENCY COUNTER	5Hz to 1.5MHz $\pm$ .003%	HP Model 3457A or HP Model 5314A	PAT
DIGITAL MULTIMETER		HP Model 3456A or HP Model 3457A	PAT
OSCILLOSCOPE		HP Model 1740A	T

P = Performance Test    A = Adjustment    T = Troubleshooting

## SECTION II INSTALLATION

### 2-1. INTRODUCTION

2-2. This section contains information to aid in the installation and interfacing of the HP 3457A Digital Multimeter. This section also includes initial inspection procedures, power requirements, environmental information, and instructions for repackaging the instrument for shipment. The information contained in this section is for service trained personnel.

### WARNING

*The information contained in this manual is for service trained personnel who are familiar with electronic circuitry and understand the hazards involved. To avoid electrical shock or damage to the instrument, do not perform any procedures in this manual or do any servicing to the instrument unless you are qualified to do so.*

### 2-3. INITIAL INSPECTION

2-4. The 3457A was carefully inspected, both mechanically and electrically, before shipment. It should be free of marks or scratches and in perfect electrical order upon receipt. The instrument should be carefully inspected for any damage which may have occurred during transit. If the shipping container or cushioning material is damaged, it should be kept until the contents of the shipment have been checked for completeness and the instrument has been mechanically and electrically inspected. The contents of the shipment should be as shown in Figure 2-1; procedures for testing the electrical performance of the HP 3457A are contained in Section IV of this manual. If the contents are incomplete, if there is mechanical damage or defect, or if the instrument does not pass the performance tests, notify the nearest Hewlett-Packard office (a list of HP Sales and Service offices is located in the back of this manual). If the shipping container is damaged, or the cushioning material shows signs of stress, notify the carrier as well as the Hewlett-Packard office. Save the shipping material for the carrier's inspection.

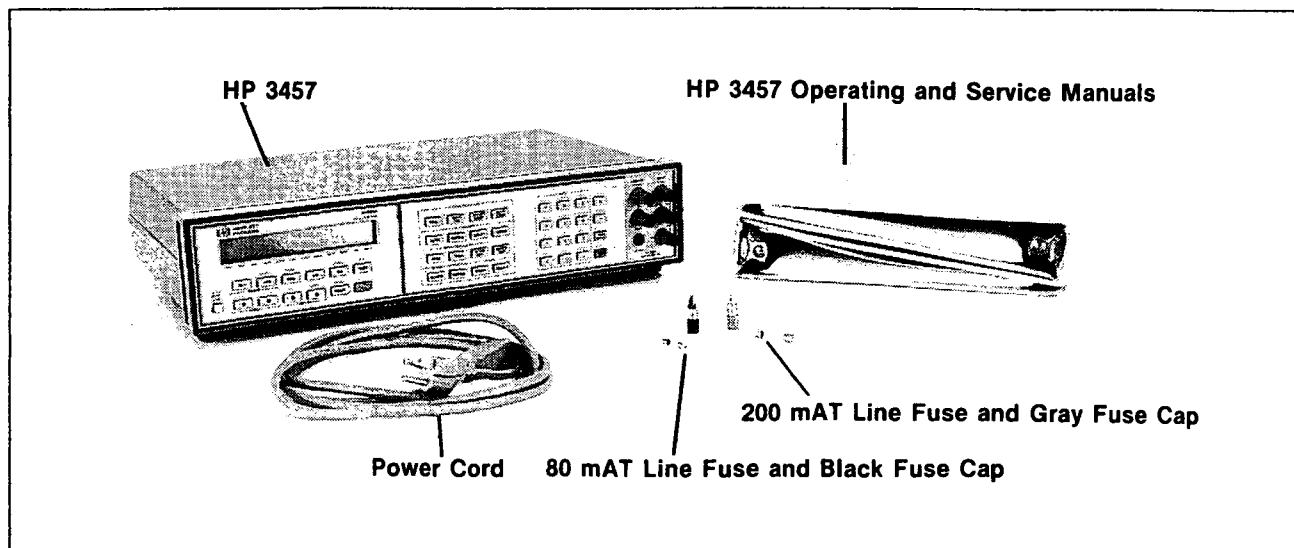

Figure 2-1. Shipment Contents

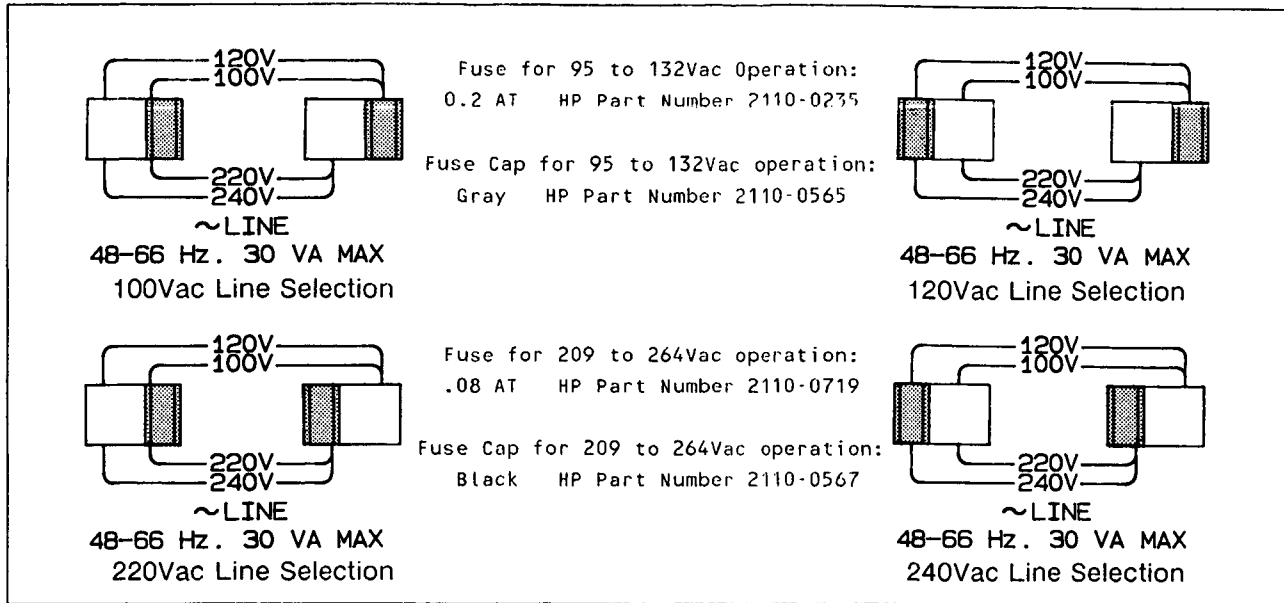

Figure 2-2. Line Voltage and Fuse Selection

## 2-5. PREPARATION FOR USE

### 2-6. Power Requirements

2-7. The HP 3457A requires a power source of 100, 120, 220, or 240 Vac (+5%, -10%), 48Hz to 66Hz single phase. Power consumption is less than 30VA.

### CAUTION

*Before connecting power to the HP 3457A, make certain that the line selection switches (located on the rear panel) have been set to accept the available power source and that the proper fuse is installed.*

### 2-8. Line Voltage Selection

2-9. The line voltage selection switches are located on the rear panel below the power connector and fuse. Figure 2-2 shows the appropriate switch positions and fuse requirements for the various power line voltages.

### 2-10. Power Cords

2-11. This instrument is equipped with a three-wire power cable. This cable, when connected to an appropriate ac power receptacle, grounds the metal parts of the cabinet. The type of plug supplied with the power cable depends upon the country of destination. Figure 2-3 illustrates the power plugs available. The HP Part Number listed below each figure is the part number for the complete power cord assembly. If the appropriate power cord is not supplied with your instrument, notify your nearest HP Sales and Service Office and a replacement cable will be supplied.

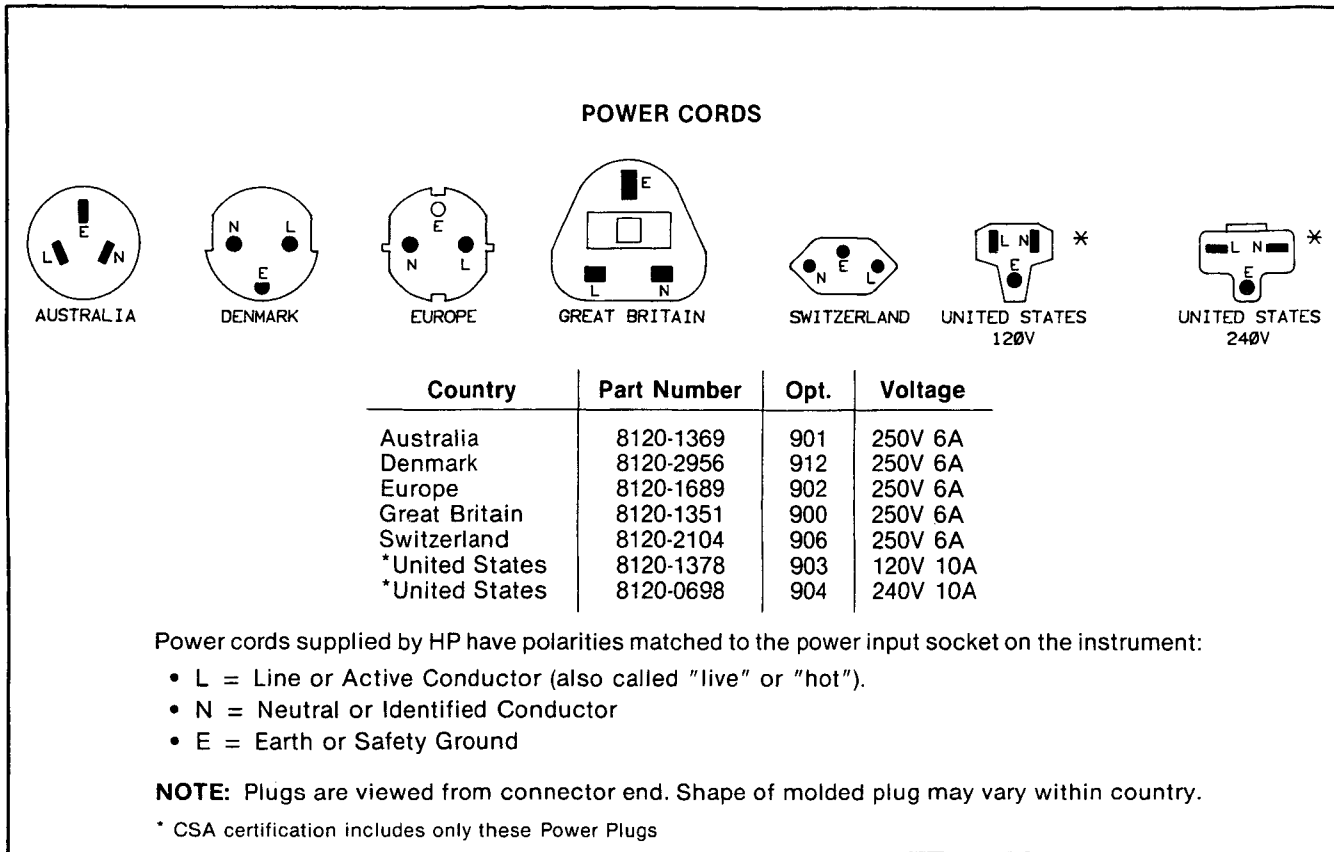

Figure 2-3. Power Cables

## 2-12. Grounding Requirements

2-13. To protect operating personnel from shock hazard, the National Electrical Manufacturer's Association (NEMA) recommends grounding the instrument cabinet. The *-hp-* 3457A is equipped with a three conductor power cord which, when connected to an appropriate outlet, grounds the metal portions of the cabinet.

## 2-14. Bench Use

2-15. The *-hp-* Model 3457A is shipped with feet and tilt stands installed and is ready for use as a bench instrument. The feet are shaped to permit stacking with other *-hp-* full-module instruments.

## 2-16. Rack Mounting

2-17. The *-hp-* 3457A may be rack mounted by adding rack mounting kit Option 908 when ordering the instrument. The rack mounting kit may also be ordered separately by ordering *-hp-* Part Number 5061-1168. The basic hardware and instructions for rack mounting is contained in the kit. The rack mounting hardware is designed to permit the 3457A to be mounted in a standard 19 inch rack, provided that sufficient rear support is available. Refer to Section I for other mounting options.

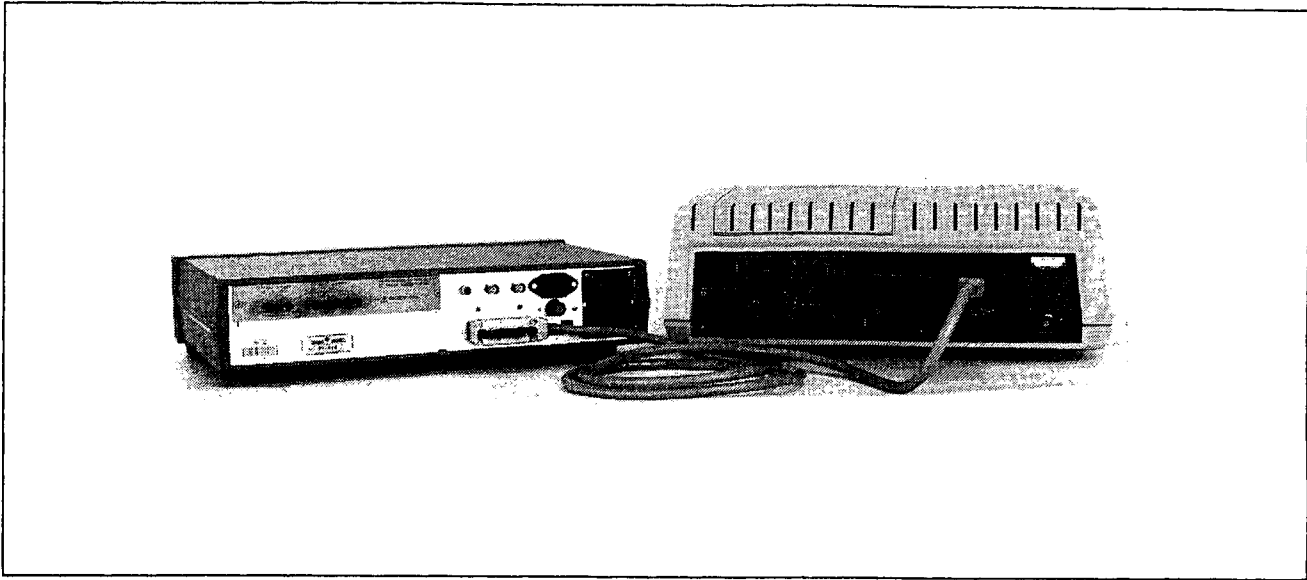

Figure 2-4. Typical HP-IB Interface Connection

## 2-18 INTERFACE CONNECTIONS

### 2-19. Control Interface

2-20. The HP Model 3457A is compatible with the Hewlett-Packard Interface Bus (HP-IB). Connection is made using an HP-IB interface cable to connect the controller to the appropriate connector on the rear of the HP 3457A. A typical HP-IB interface system is shown in Figure 2-4. The system shown uses three HP-IB interface cables to connect the instruments in the system. Each interface connector is both a male and female connector to permit connection to an instrument and another interface cable. As many as 15 instruments can be connected by the same interface bus. However, the maximum length of cable used to connect a group of instruments should not exceed the number of instruments times 2 meters (6.56 ft.), or a maximum of 20 meters (65.6 ft.), whichever is less. Refer to Figure 2-5 for a pictorial view of the HP-IB connector and its pin designations.

#### NOTE

*HP-IB is Hewlett-Packard's implementation of IEEE Std. 488-1978, "Standard Digital Interface for Programmable Instrumentation".*

### 2-21. HP-IB ADDRESS SELECTION

2-22. The HP-IB address is programmed from the front panel or over the interface bus. The address is set to decimal "22" at the factory. This corresponds to an ASCII listen address of "6" and talk address of "V". The HP 3457A display momentarily shows the current address code whenever the instrument is turned on or reset.

#### NOTE

*When choosing an address, be certain it is unique to the system involved. Some controllers have an HP-IB address. As an example: HP Series 200 computers have an address of decimal 21.*



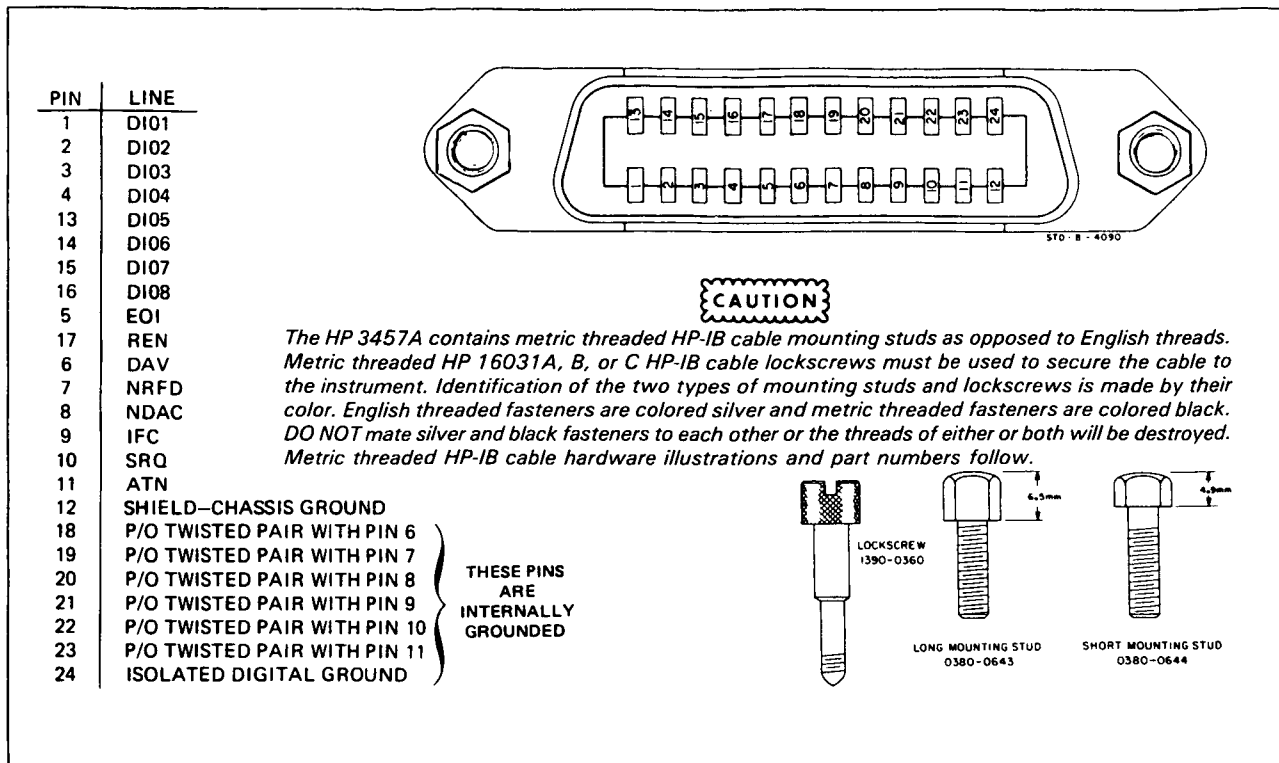

Figure 2-5. HP-IB Connector

**2-23. Changing the Address from the Front Panel.** The HP-IB address code is set from the front panel as follows:

- a. Select the Command Directory "A" listing by pressing the BLUE shift key, then the Configuration "A" key (the display will show ACAL).
- b. Use the ↓ scroll key to advance the command listing to ADDRESS.
- c. Enter the desired HP-IB decimal address using the MATH keys (refer to Figure 2-6 for a list of available codes).
- d. Press the ENTER key located at the lower-right corner of the keyboard.
- e. To check the new address, press the BLUE shift key then then the LOCAL/ADRS key. The display will show the new address code. Press any key to stop display of the address.

**2-24. Changing the Address from the Controller.** To change the HP-IB address from the controller, proceed as follows:

- a. Determine the present device address of the HP 3457A. (The address must be known in order to communicate with the HP 3457A.) The address is momentarily displayed during the power-on sequence or can be called by pressing the BLUE shift key then the LOCAL/ADRS key.

ASCII CODE CHARACTER			ASCII CODE CHARACTER		
Listen	Talk	Decimal Code	Listen	Talk	Decimal Code
SP	@	00	0	P	16
!	A	01	1	Q	17
"	B	02	2	R	18
#	C	03	3	S	19
\$	D	04	4	T	20
%	E	05	5	U	21
&	F	06	6	V	22
'	G	07	7	W	23
(	H	08	8	X	24
)	I	09	9	Y	25
*	J	10	:	Z	26
+	K	11	;	[	27
,	L	12	<	\	28
-	M	13	=	]	29
.	N	14	>	~	30
/	O	15		Talk Only	31*

\* Address 31 sets the 3457A to the Talk Only Mode. In this mode, the 3457A will output directly to an HP-IB printer without a controller on the bus. Address 31 is not, however, a valid HP-IB address with a controller on the bus.

Figure 2-6. HP-IB Address Codes

b. Transmit the new device address to the HP 3457A. The message required to transmit the new address code consists of the controller's transmit command, the HP-IB interface select code, the HP 3457A's device address and the message. As an example; typing the following into a controller which uses HP-enhanced BASIC, would change the device address of the HP 3457A from "22" to "18".

OUTPUT 722; "ADDRESS18"

In this command statement, OUTPUT is the transmit command of the controller used; "7" is the select code of the HP-IB interface; "22" is the present address of the HP 3457A and "ADDRESS18" is the message to change the instrument address to 18.

**2-25. INSTALLATION OF OPTIONS**

2-26. The HP 3457A is shipped from the factory with the Rear Terminal Assembly installed. Optional Plug-In Assemblies are packaged separately and must be configured and installed by the customer. Each Plug-In Assembly includes a wiring block and two-piece strain relief housing for making external connections.

2-27. The following paragraphs provide information necessary to configure and install Optional Plug-In Assemblies HP 44491A or HP 44492A.

**WARNING**

*To prevent personal injury, disconnect all external input connections to the HP 3457A before removing or installing the Rear Terminal Assembly or Optional Plug-In Assembly.*

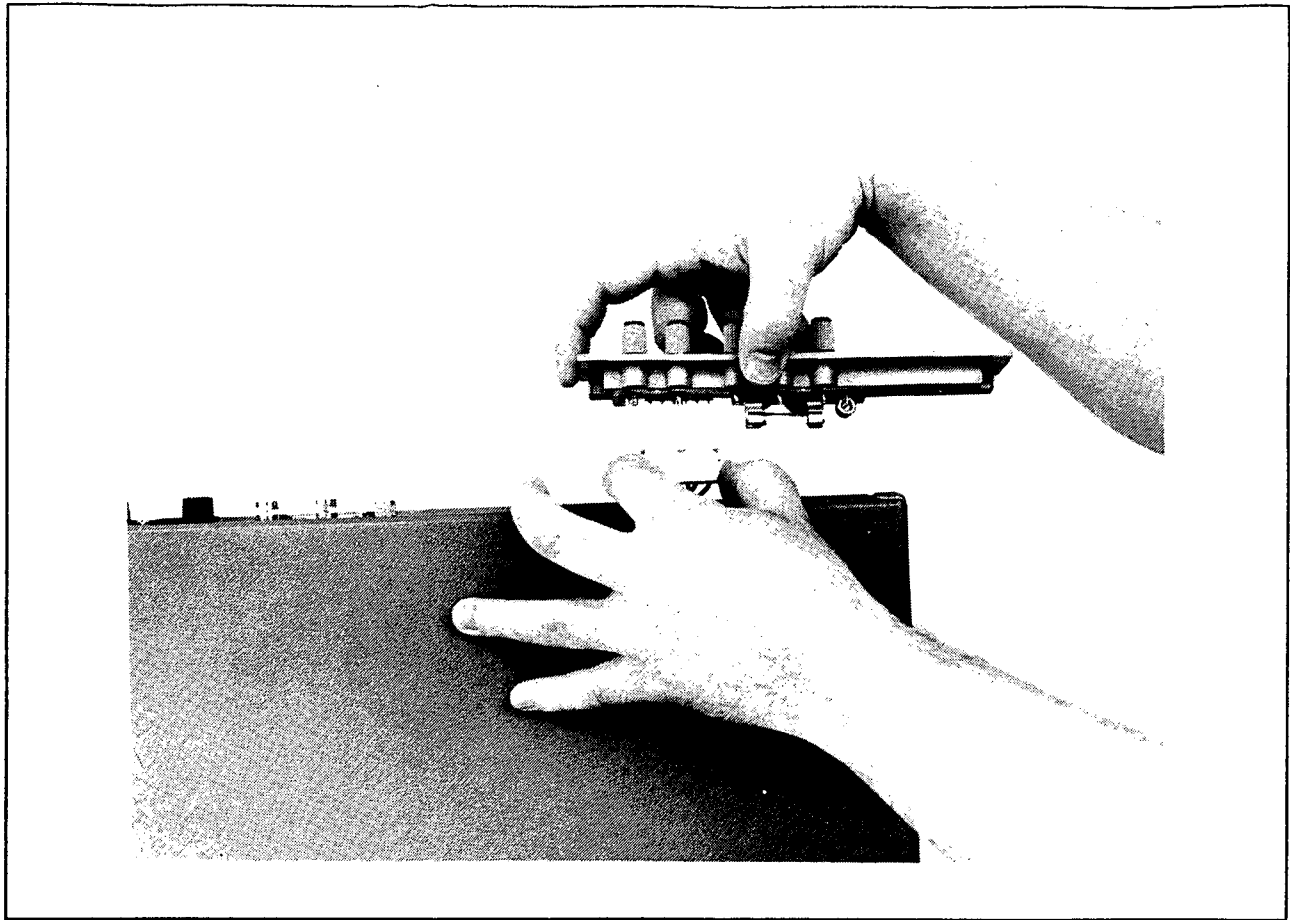

**Figure 2-7. Rear Terminal Assembly Removal**

**CAUTION**

*Use clean handling and anti-static techniques when removing, configuring, and installing a Plug-In Assembly. The circuit boards must be kept clean to ensure compliance with impedance specifications. The Plug-In Assemblies as well as the HP 3457A mainframe contain CMOS devices that are susceptible to damage from static electricity.*

**2-28. Rear Terminal Assembly Removal**

2-29. The Rear Terminal Assembly must be removed before an Optional Plug-In Assembly can be installed. Remove the Rear Terminal Assembly as follows:

- a. Remove the power cord and all external input connections from the HP 3457A.
- b. Remove the two screws attaching the Terminal Assembly to the rear panel.
- c. Remove the Terminal Assembly and disconnect the attached connector.

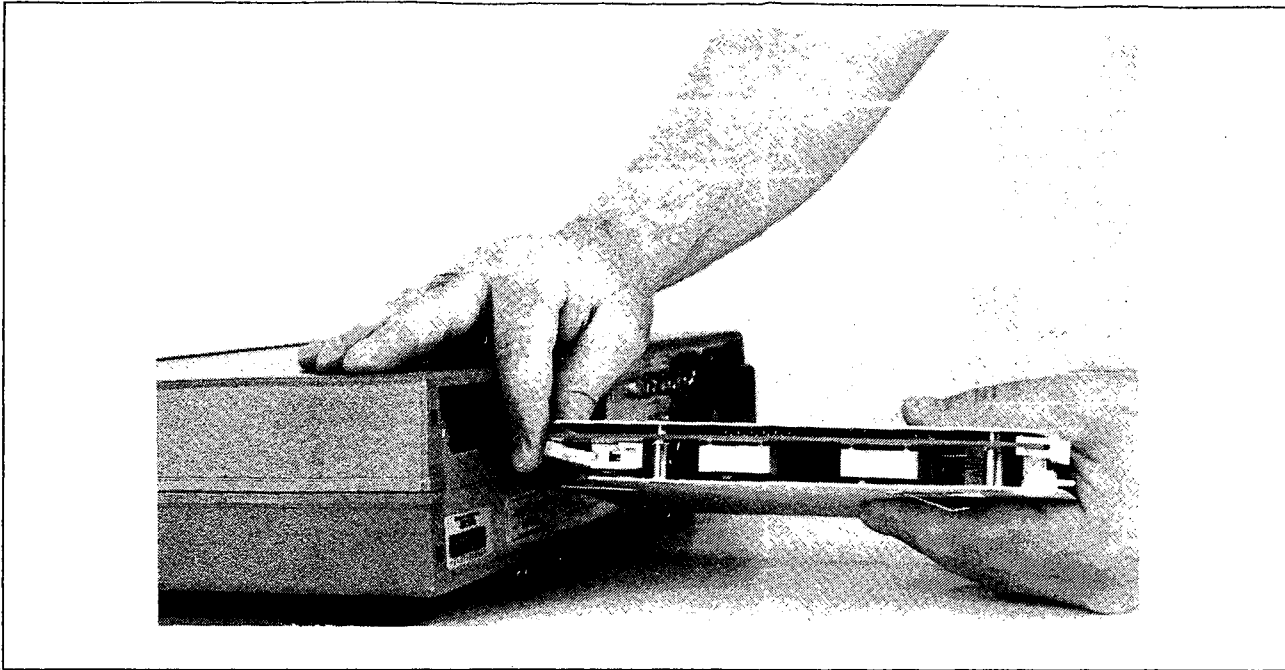

Figure 2-8. Connecting the Wiring Harness

### 2-30. Plug-In Assembly Installation

2-31. The Rear Terminal Assembly must be removed, as described in paragraph 2-28, before installing a Plug-In Assembly. Install the Plug-In Assembly as follows:

- a. Connect the HP 3457A wiring harness connector to the Plug-In Assembly connector as shown in Figure 2-8.
- b. Open the two white locking tabs by pulling them away from the circuit board. Notice that each locking tab has a detent which tends to hold it in the closed position.
- c. Position the Plug-In Assembly with the component side of the printed circuit board facing down. Slide the Plug-In Assembly into the guides in the rear of the HP 3457A. Firmly push the assembly into the HP 3457A until it stops.
- d. Close the two white locking tabs by pressing them flat against the circuit board. As the locking tabs are closed, the Plug-In Assembly is pushed into the slot. This action locks the assembly into place and engages the assembly's connector with the connector in the HP 3457A.
- e. Calibrate the Plug-In Assembly using the appropriate procedure in Section V of this manual.

**NOTE**

*To remove the Plug-In Assembly, simply open the white locking tabs. This releases the locking mechanism and pulls the assembly out of the mainframe connector.*

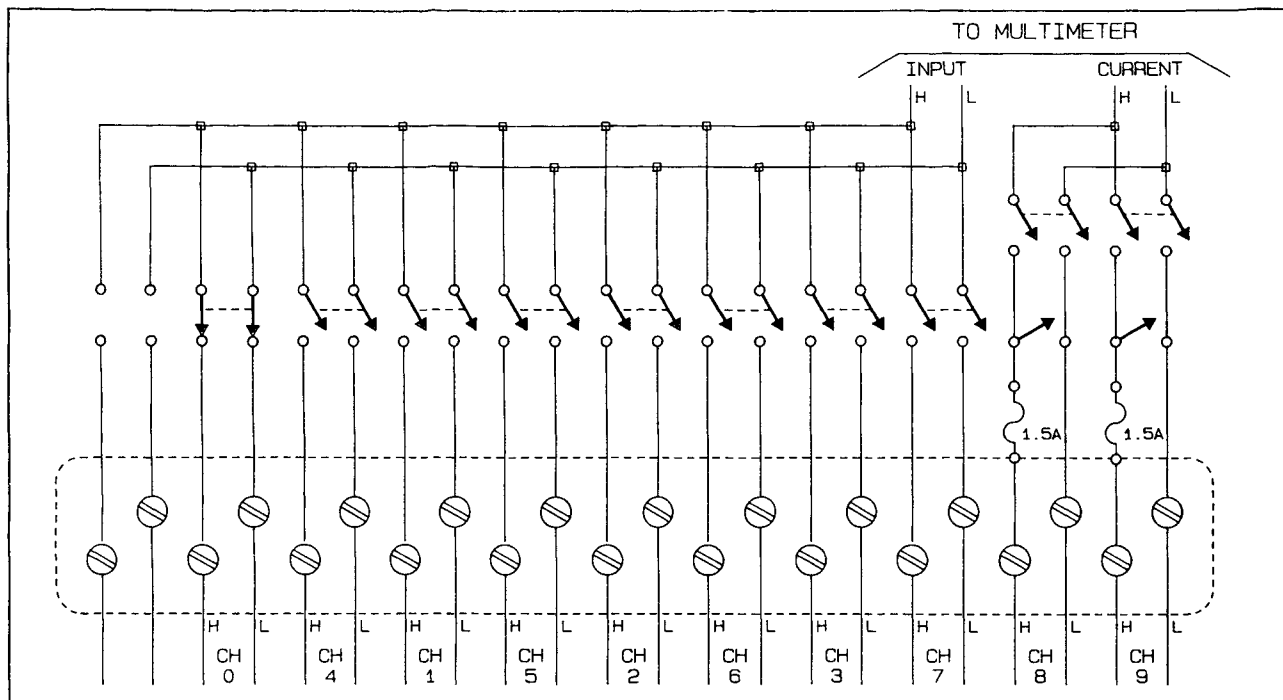

Figure 2-9. HP 44491A 2-Wire Input Configuration

### 2-32. Plug-In Assembly Configuration

2-33. The Wiring Block Assembly configuration is dependent upon the particular Plug-In Assembly installed (HP 44491A or HP 44492A) and the user's application.

**2-34. HP 44491A Configuration.** The HP 44491A Armature Relay Assembly can be configured for eight 2-wire input channels, four 4-wire input channels or a combination of 2 and 4-wire input channels. The assembly also has two 2-wire input channels which are used for measuring current or as actuator outputs. The Wiring Block Assembly must be wired for the particular configuration used.

## WARNING

*The HP 44491A Armature Relay Assembly uses latching relays. The state of these relays can only be altered under program control. This is an advantage in the sense that, under most conditions of failure, the relays will remain in whatever state the program has set them. However, in case of a power failure, any application requiring a fail-safe method of ensuring that the circuits under control are in a known state must be provided by the installer.*

*In case of component failure or programming error, any voltage input to a plug-in assembly may be present on any other terminal of the plug-in assembly.*

2-35. Figures 2-9 through 2-11 show simplified schematics of the HP 44491A Armature Relay Multiplexer Assembly configured for 2-wire inputs, 4-wire inputs and current/actuator applications.

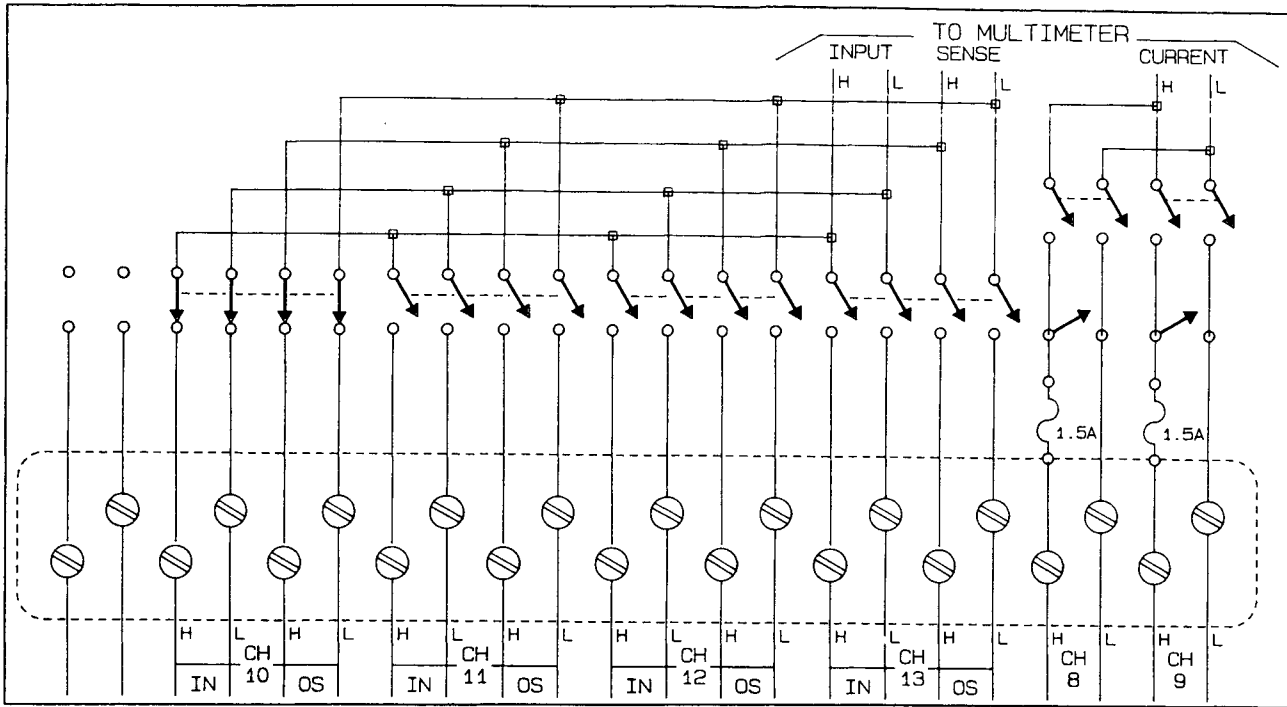

Figure 2-10. HP 44491A 4-Wire Input Configuration

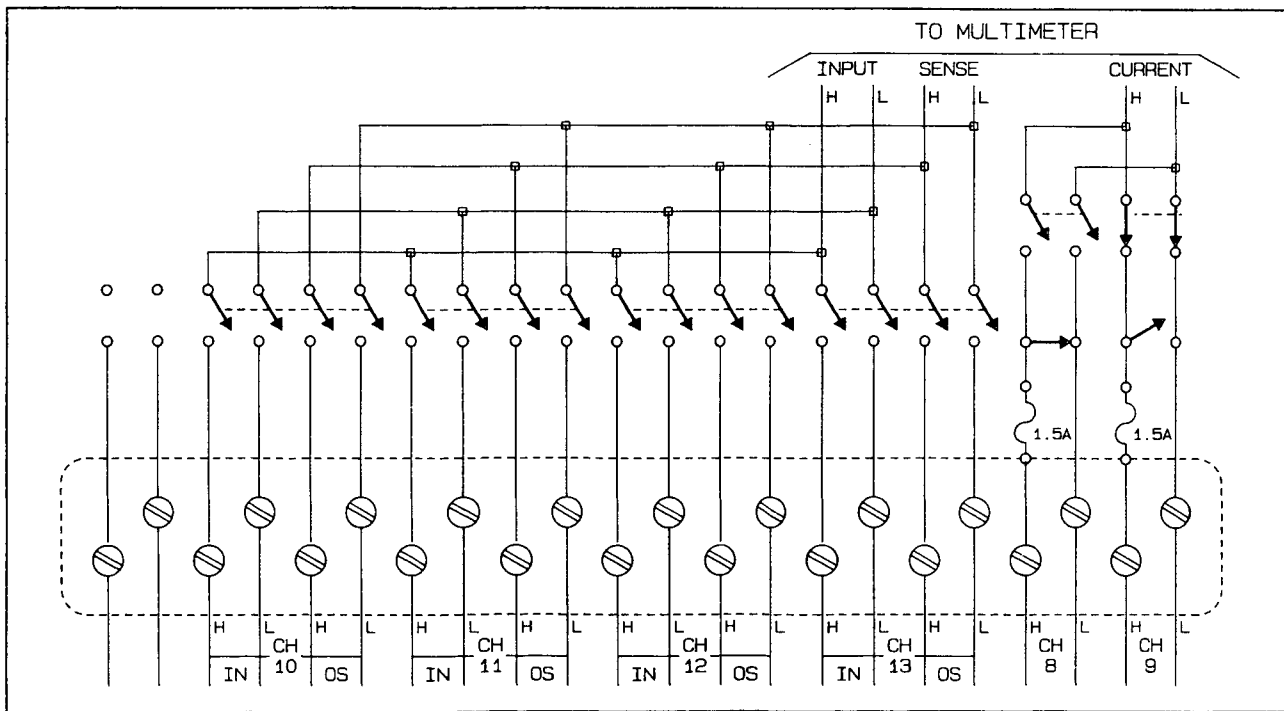

Figure 2-11. HP 44491A Current/Actuator Configuration

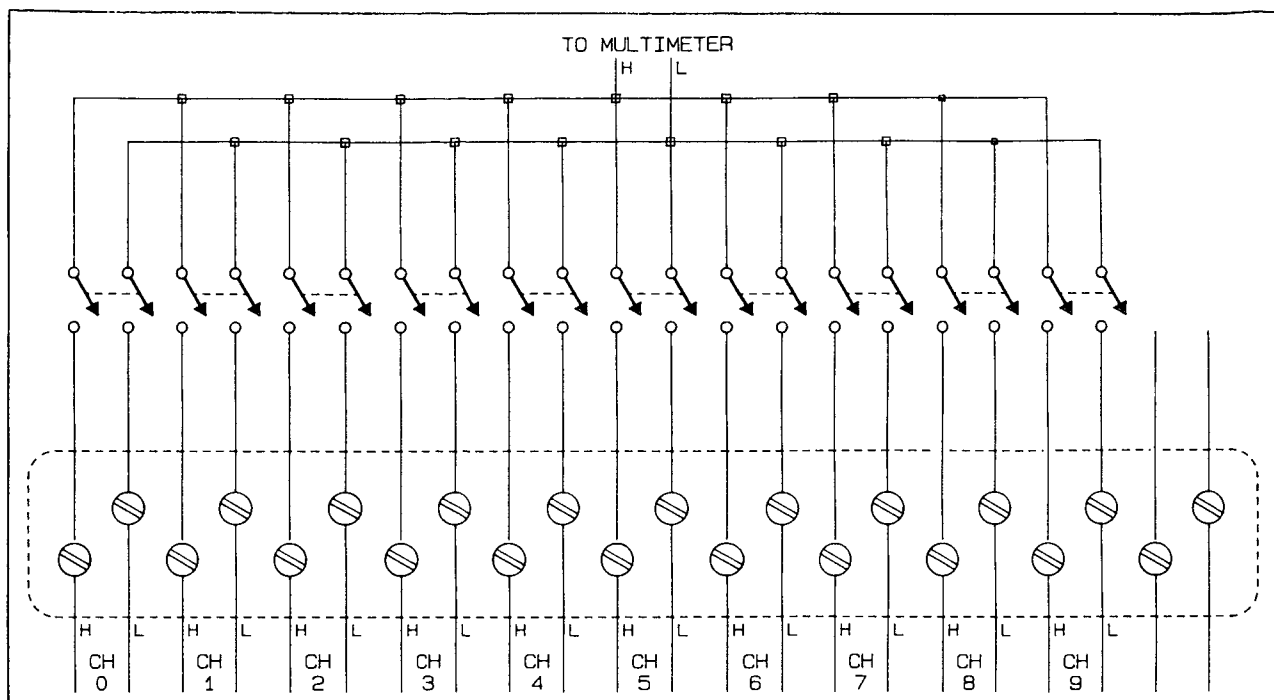

Figure 2-12. HP 44492A Simplified Schematic

**2-36. HP 44492A Configuration.** The HP 44492A Reed Relay Multiplexer Assembly can be configured for ten 2-wire input measurements. It can be used to measure dc voltage, ac voltage, ac + dc voltage, resistance, frequency and period. It cannot be used for 4-wire ohms or current measurements.

2-37. Figure 2-12 shows a simplified schematic of the HP 44492A Reed Relay Multiplexer Assembly.

### 2-38. Wiring Block Preparation

- a. Remove the Strain Relief Plate from the bottom of the Strain Relief Housing (Figure 2-13, Step 1)
- b. Remove the Wiring Block from the Strain Relief Housing (Figure 2-13, Step 2).
- c. Strip 8 mm (5/16 in.) of insulation from one end of each wire to connected to the Wiring Block.
- d. Loosen the appropriate retaining screw, insert the stripped end of the wire into the slot, and re-tighten the retaining screw (Figure 2-14).
- e. Repeat step "d" for each wire to be connected.
- f. Connect the Wiring Block to the Strain Relief Housing.
- g. Separate the wires into three equal bundles and route them through the cutouts in the Strain Relief Housing (if there are only a few wires, route them all through the center cutout).
- h. Secure the Strain Relief Plate to the Strain Relief Housing. Tighten the screws until the plate is snug against the wires. Do not over-tighten.
- i. Press the Wiring Block Assembly onto the Plug-In Assembly connector and tighten the screws at each end of the Strain Relief Housing.

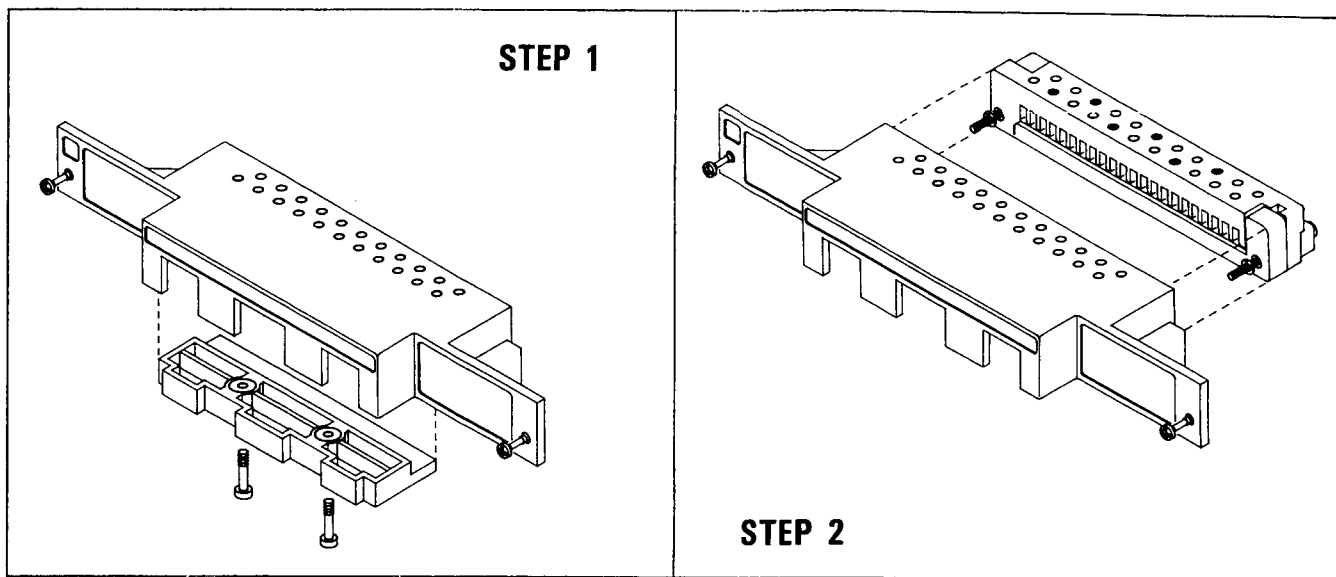

Figure 2-13. Wiring Block Disassembly

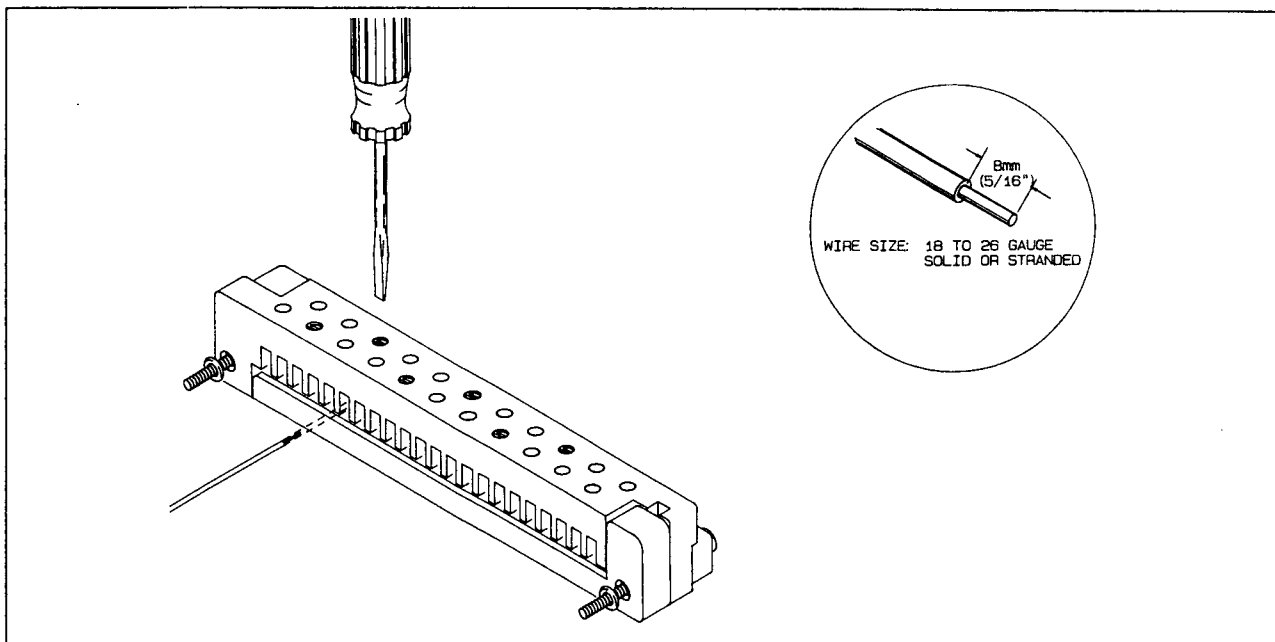

Figure 2-14. Wire Connection



# SECTION III

## OPERATION

### 3-1. INTRODUCTION

3-2. The information contained in this section describes manual operation of the HP 3457A Multimeter. The contents are intended to meet the needs of service personnel with emphasis on front panel operation. For more detailed information on overall operation, refer to the HP 3457A Operating Manual.

### 3-3. GENERAL INFORMATION

#### 3-4. AC Power

3-5. Before connecting power to the HP 3457A, be certain the line switches on the rear panel are set for your power source and that the proper fuse is installed. Information for setting the line switches and for fuse selection is located in Section II of this manual.

#### 3-6. Power-On

3-7. The HP 3457A automatically performs a power-on self test when it is switched on. This test takes approximately 1.5 seconds to complete and basically assures that the instrument is capable of operating. The test does not necessarily indicate that measurements will be accurate. The power-on self test checks the master processor, slave processor and the communication isolation circuitry (three of the ten tests performed by the complete self test). Upon satisfactory completion of the test, the instrument will display its HP-IB address for approximately five seconds. The address is displayed as ADDRESS-dd where "dd" is the decimal address code of the instrument (the address is set to decimal 22 at the factory). If the test can not be completed, the instrument will display FAILED. If this occurs, refer to Section VIII for troubleshooting procedures.

3-8. Upon completion of the Power-On Test, the instrument sets itself to predefined conditions (Power-On state). The power-on state conditions are listed in Table 3-1.

### 3-9. OPERATION

3-10. The following paragraphs describe basic operating procedures for the HP 3457A Multimeter. This section covers only front panel operating procedures such as voltage, resistance, and current measurements. Also included are manual procedures covering operation of the HP 44491A and 44492A Multiplexer Assemblies. For detailed operating information, refer to the HP 3457A Operating Manual.

#### 3-11. Voltage Measurements (Manual Operation)

**3-12. Function Selection.** The measurement function is selected by pressing the appropriate key. The voltage measurement functions available are DC Volts, AC Volts and DC Coupled AC Volts. The default function is DC Volts.

- To measure DC Voltage - Press the DCV function key.
- To measure AC Voltage - Press the ACV / ACDCV function key.
- To measure DC coupled AC voltage - Press the Blue SHIFT key then the ACV / ACDCV function key.

AC BANDWIDTH (ACBAND) .....	SLOW	MATH REGISTERS . All Cleared Except the following
AUTO-RANGE (ARANGE) .....	ON	DEGREE .....
AUTO-ZERO .....	ON	OFFSET .....
BEEP .....	ON	REFERENCE dB (REF) .....
CHANNELS CONNECTED (CHAN) .....	NONE	RES .....
DELAY ... DEFAULT (Minimum required for accuracy)		SCALE .....
DIGITS DISPLAYED (NDIG) .....	5	MEMORY (MEM) .....
DISPLAY (DISP) .....	ON	MEMORY SIZE (MSIZE) .....
EMASK .....	32767 enabled	NUMBER OF READINGS PER TRIGGER (NRDGS) .....
ERROR REGISTER .....	Results of Self-Test	OFFSET COMPENSATION (OCOMP) .....
FIXED IMPEDANCE (FIXEDZ) .....	OFF	OUTPUT FORMAT (OFORMAT) .....
FREQUENCY SOURCE (FSOURCE) .....	AC VOLTS	PROGRAM MEMORY .....
FUNCTION (FUNC) .....	DC VOLTS	READING MEMORY .....
HP-IB ADDRESS .... UNCHANGED (Factory setting 22)		REQUEST SERVICE (RQS) ....
INPUT BUFFER (INBUF) .....	OFF	SCAN ADVANCE (SADV) .....
INPUT TERMINALS (TERM) .....	FRONT	SCAN LIST (SLIST) .....
INTEGRATION TIME (NPLC) .....	10 PLC	STATUS REGISTER ..
MATH FORMAT (MFORMAT) .....	SREAL	TIMER .....
MATH FUNCTION (MATH) .....	OFF, OFF	TRIGGER (TRIG) .....
		TRIGGER ARM (TARM) .....

Table 3-1. 3457A Power-On State

**3-13. Range Selection.** The HP 3457A Auto-Range feature automatically selects the appropriate range to measure the voltage applied. The Auto-Range feature is disabled by selecting Manual Ranging. There are 5 voltage measurement ranges available; 30 mV, 300 mV, 3 V, 30 V and 300 V. The default range is Auto-Range.

- To select Manual Ranging and maintain the present range - Press the Blue SHIFT key then the ↓/HOLD scroll key.
- To select Manual Ranging and the next higher range - Press the ↑/AUTO scroll key.
- To select Manual Ranging and the next lower range - Press the ↓/HOLD scroll key.
- To return to Auto-Ranging - Press the Blue SHIFT key then the ↑/AUTO scroll key.

**3-14. Measurement Resolution.** Measurement Resolution is changed by selecting the number of digits displayed. You can choose a display of 3 1/2, 4 1/2, 5 1/2 or 6 1/2 digits. The 1/2 digit refers to the most significant digit which is limited to a value of 0, 1, 2, or 3. The default number of digits displayed is 5 1/2 (most significant digit plus 5 digits).

- To change the number of digits displayed - Press the DIGITS DISP / P configuration key, enter the number 3, 4, 5 or 6 and press the ENT / LAST ENTRY key.

**3-15. Integration Time.** The Integration time can be changed to reduce measurement noise or to permit faster readings. The integration time is dependent upon the power line frequency and is expressed in number of power line cycles (NPLC). There are six integration times available; 100 PLC, 10 PLC, 1 PLC, .1 PLC, .005 PLC and .0005 PLC. The greater the PLC number, the quieter and more accurate the reading will be and the slower the measurement speed.

- To select the Integration Time - Press the NPLC / A configuration key, use the ↑/AUTO or ↓/HOLD scroll key to display the desired number and press the ENT / LAST ENTRY key.

*The Integration Time can also be changed by pressing the NPLC/A key, entering the desired number directly, and pressing the ENT/LAST ENTRY key.*

**3-16. Input Connections.** For voltage measurements, the input voltage is connected to the INPUT HI and LO Terminals. This is true for both Front and Rear Terminal operation. When using one of the optional Plug-In assemblies, the input is connected to the HI and LO inputs of a particular channel.

**3-17. Front/Rear Input Selection.** The Input configurations are Front Terminals, Rear Terminals/Scanner or Open. Only one input configuration (front, rear, scanner or open) can be selected at a time.

- To select Input configuration - Press the TERM / M configuration key. Use the ↑/AUTO or ↓/HOLD scroll key to display the desired input and press the ENT / LAST ENTRY key.

*The input can also be changed by pressing the TERM/M key, entering the appropriate number, and pressing the ENT/LAST ENTRY key.*

### 3-18. Resistance Measurements (Manual Operation)

**3-19. Function Selection.** The measurement function is selected by pressing the appropriate function key. The resistance measurement functions available are 2-Wire Ohms and 4-Wire Ohms.

- To select 2-Wire resistance measurements - Press the OHM / OHMF function key.
- To select 4-Wire resistance measurements - Press the Blue SHIFT key then the OHM / OHMF key.

**3-20. Range Selection.** The Auto-Range feature automatically selects the appropriate range for the resistance being measured. The Auto-Range feature is disabled by selecting Manual Ranging. There are 9 resistance measurement ranges available; 30 Ohms, 300 Ohms, 3 KOhms, 30 KOhms, 300 KOhms, 3 MOhms, 30 MOhms, 300 MOhms and 3 GOhms. The extended ohms ranges (300 MOhms and 3 GOhms) are available only for 2-Wire resistance measurements. The default range is Auto-Range.

- To select Manual Ranging and maintain the present range - Press the Blue SHIFT key then the ↓/HOLD scroll key.
- To select Manual Ranging and the next higher range - Press the ↑/AUTO scroll key.
- To select Manual Ranging and the next lower range - Press the ↓/HOLD scroll key.
- To return to Auto-Ranging - Press the Blue SHIFT key then the ↑/AUTO scroll key.

**3-21. Measurement Resolution.** Measurement Resolution is changed by selecting the number of digits displayed. You can choose a display of 3 1/2, 4 1/2, 5 1/2 or 6 1/2 digits. The 1/2 digit refers to the most significant digit which is limited to a value of 0, 1, 2, or 3. The default number of digits displayed is 5 1/2 (most significant digit plus 5 digits).

- To change the number of digits displayed - Press the DIGITS DISP / P configuration key, enter the number 3, 4, 5 or 6 and press the ENT / LAST ENTRY key.

**3-22. Integration Time.** The Integration time can be changed to reduce measurement noise or to permit faster readings. The integration time is dependent upon the power line frequency and is expressed in number of power line cycles (NPLC). There are six integration times available; 100 PLC, 10 PLC, 1 PLC, .1 PLC, .005 PLC and .0005 PLC. The greater the PLC number, the quieter and more accurate the reading will be and the slower the measurement speed.

- To select the Integration Time - Press the NPLC / A configuration key. Use the ↑/AUTO or ↓/HOLD scroll key to display the desired number and press the ENT / LAST ENTRY key.

*The Integration Time can also be changed by pressing the NPLC/A key, entering the desired number directly using the MATH keys and pressing the ENT/LAST ENTRY key.*

**3-23. Input Connections.** For 2-Wire Ohms measurements, the unknown resistance is connected to the INPUT HI and LO terminals. This applies to both front and rear terminal operation. When using one of the optional Plug-In assemblies, the input would be connected to the HI and LO inputs of a particular channel. For 4-Wire Ohms measurements, the unknown resistance is connected to the INPUT HI and LO terminals and to the Ω SENSE HI and LO terminals as shown in Figure 3-1. When using the HP 44491A General Purpose Multiplexer assembly, the unknown resistance is connected as shown in Figure 3-2.

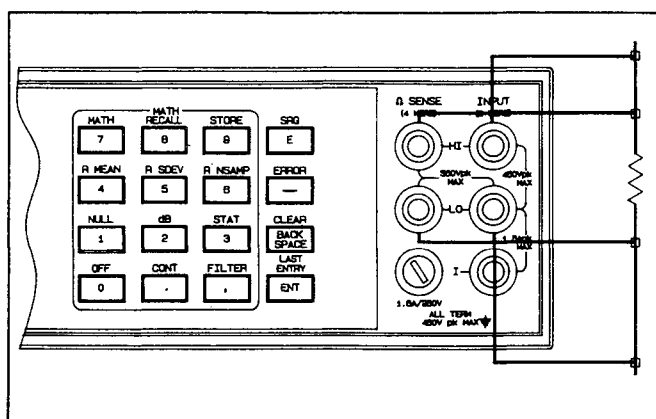

Figure 3-1. Front Panel Connections

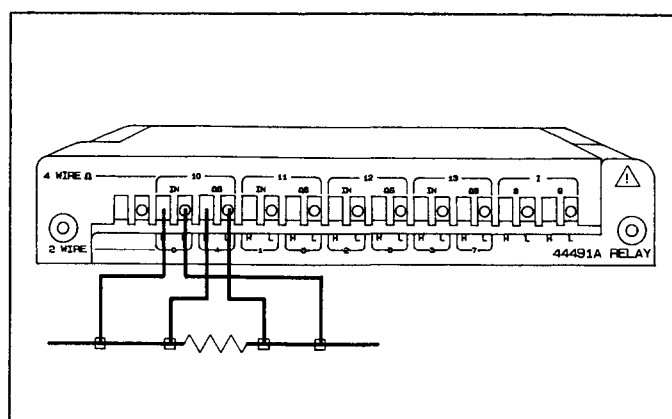

Figure 3-2. Plug-In Connections

**3-24. Front/Rear Input Selection.** The Input configurations are Front Terminals, Rear Terminals/Scanner or Open. Only one input configuration (front, rear, scanner or open) can be selected at a time.

- To select Input configuration - Press the TERM / M configuration key. Use the ↑/AUTO or ↓/HOLD scroll key to display the desired input and press the ENT / LAST ENTRY key.

*The input can also be changed by pressing the TERM/M key, entering the appropriate number using the MATH keys and pressing the ENT/LAST ENTRY key.*

**3-25. Current Measurements (Manual Operation)**

**3-26. Function Selection.** The measurement function is selected by pressing the appropriate function key. The current measurement functions available are DC Current, AC Current and DC Coupled AC Current.

- To select DC Current - Press the DCI function key.
- To select AC Current - Press the ACI / ACDCI function key.
- To select DC coupled AC Current - Press the Blue SHIFT key then the ACI / ACDCI function key.

**3-27. Range Selection.** The Auto-Range feature automatically selects the appropriate range for the current being measured. The Auto-Range feature can be disabled by selecting Manual Ranging. There are 5 DC current ranges available; 300  $\mu$ A, 3 mA, 30 mA, 300 mA and 1 A. There are 3 AC current ranges available; 30 mA, 300 mA and 1 A. The maximum input current for DC or AC inputs is 1.5 A peak. The default range is Auto-Range.

- To select Manual Ranging and maintain the present range - Press the Blue SHIFT key then the  $\downarrow$ /HOLD scroll key.
- To select Manual Ranging and the next higher range - Press the  $\uparrow$ /AUTO scroll key.
- To select Manual Ranging and the next lower range - Press the  $\downarrow$ /HOLD scroll key.
- To return to Auto-Ranging - Press the Blue SHIFT key then the  $\uparrow$ /AUTO scroll key.

**3-28. Measurement Resolution.** Measurement Resolution is changed by selecting the number of digits displayed. You can choose a display of 3 1/2, 4 1/2, 5 1/2 or 6 1/2 digits. The 1/2 digit refers to the most significant digit which is limited to a value of 0, 1, 2, or 3. The default number of digits displayed is 5 1/2 (most significant digit plus 5 digits).

- To change the number of digits displayed - Press the DIGITS DISP / P configuration key, enter the number 3, 4, 5 or 6 and press the ENT / LAST ENTRY key.

**3-29. Integration Time.** The Integration time can be changed to reduce measurement noise or to permit faster readings. The integration time is dependent upon the power line frequency and is expressed in number of power line cycles (NPLC). There are six integration times available; 100 PLC, 10 PLC, 1 PLC, .1 PLC, .005 PLC and .0005 PLC. The greater the PLC number, the quieter and more accurate the reading will be and the slower the measurement speed.

- To select the Integration Time - Press the NPLC / A configuration key. Use the  $\uparrow$ /AUTO or  $\downarrow$ /HOLD scroll key to display the desired number and press the ENT / LAST ENTRY key.

*The Integration Time can also be changed by pressing the NPLC/A key, entering the desired number directly using the MATH keys and pressing the ENT/LAST ENTRY key.*

**3-30. Input Connections.** For current measurements, the input current is applied to the INPUT I and LO Terminals. This applies to both Front and Rear Terminal operation. When using the HP 44491A Plug-In assembly, the input is connected to the I and LO inputs of either channel 8 or channel 9.

**3-31. Front/Rear Input Selection.** The Input configurations are Front Terminals, Rear Terminals/Scanner or Open. Only one input configuration (front, rear, scanner or open) can be selected at a time.

- To select Input configuration - Press the TERM / M configuration key. Use the  $\uparrow$ /AUTO or  $\downarrow$ /HOLD scroll key to display the desired input and press the ENT / LAST ENTRY key.

*The input can also be changed by pressing the TERM/M key, entering the appropriate number using the MATH keys and pressing the ENT/LAST ENTRY key.*

### 3-32. Frequency/Period Measurements (Manual Operation)

**3-33. Function Selection.** The measurement function is selected by pressing the appropriate key. The functions available are Frequency and Period.

- To select Frequency - Press the **FREQ / PER** function key.
- To select Period - Press the **Blue SHIFT** key then the **FREQ / PER** function key.

**3-34. Range Selection.** The HP 3457A has an Auto-Range feature which automatically selects the proper range to measure the signal applied.

**3-35. Measurement Resolution.** Measurement Resolution is changed by selecting the number of digits displayed. You can choose a display of 3 1/2, 4 1/2, 5 1/2 or 6 1/2 digits. The 1/2 digit refers to the most significant digit which is limited to a value of 0, 1, 2, or 3. The default number of digits displayed is 5 1/2 (most significant digit plus 5 digits).

- To change the number of digits displayed - Press the **DIGITS DISP / P** configuration key, enter the number 3, 4, 5 or 6 and press the **ENT / LAST ENTRY** key.

**3-36. Integration Time.** The Integration time can be changed to reduce measurement noise or to permit faster readings. The integration time is dependent upon the power line frequency and is expressed in number of power line cycles (NPLC). There are six integration times available; 100 PLC, 10 PLC, 1 PLC, .1 PLC, .005 PLC and .0005 PLC. The greater the PLC number, the quieter and more accurate the reading will be and the slower the measurement speed.

- To select the Integration Time - Press the **NPLC / A** configuration key. Use the **↑/AUTO** or **↓/HOLD** scroll key to display the desired number and press the **ENT / LAST ENTRY** key.

*The Integration Time can also be changed by pressing the **NPLC/A** key, entering the desired number directly using the **MATH** keys and pressing the **ENT/LAST ENTRY** key.*

**3-37. Input Connections.** For frequency/period measurements, the input signal is applied to the **INPUT HI** and **LO** Terminals. This applies to both **Front** and **Rear Terminal** operation. When using one of the optional **Plug-In** assemblies, the input is connected to the **HI** and **LO** inputs of a particular channel.

**3-38. Front/Rear Input Selection.** The Input configurations are **Front Terminals**, **Rear Terminals/Scanner** or **Open**. Only one input configuration (front, rear, scanner or open) can be selected at a time.

- To select Input configuration - Press the **TERM / M** configuration key. Use the **↑/AUTO** or **↓/HOLD** scroll key to display the desired input and press the **ENT / LAST ENTRY** key.

*The input can also be changed by pressing the **TERM/M** key, entering the appropriate number using the **MATH** keys and pressing the **ENT/LAST ENTRY** key.*

### 3-39. HP 44491A General Purpose Multiplexer (Manual Operation)

**3-40.** The HP 44491A General Purpose Multiplexer has eight 2-wire input channels numbered 0 through 7 and two current/actuator channels numbered 8 and 9. The 2-wire input channels can also be configured as four 4-wire input channels. In this configuration the input channels are numbered 10 through 13.

**3-41. Measurement Selection.** Determine the type of measurement you wish to make (Voltage, Resistance, Current, Frequency/Period) and set the instrument for that measurement as described in the previous paragraphs.

**3-42. Input Selection.** When using the General Purpose Multiplexer, the instrument must be set for Rear or Scanner inputs.

- To select Rear Inputs - Press the TERM / M configuration key. Use the ↑/AUTO or ↓/HOLD scroll key to display REAR or SCANNER and press the ENT / LAST ENTRY key.

**3-43. Channel Selection.** Only one input channel, either 2-wire or 4-wire, plus one actuator channel can be selected at a time. When an input channel is closed, the channel previously closed is opened. The same applies to the actuator channels.

- To select an input channel - Press the CHAN / N configuration key, enter the number of the channel to be closed and press the ENT / LAST ENTRY key.
- To close one of the actuator channels - Press the Blue SHIFT key then the OFFSET COMP / C key. Use the ↓/HOLD scroll key to display CLOSE. Enter the number of the actuator channel to be closed (8 or 9) and press the ENT / LAST ENTRY key.
- To open all channels - Press the Blue SHIFT key then the OFFSET COMP / C key. Use the ↓/HOLD scroll key to display CRESET and press the ENT / LAST ENTRY key.

**3-44. Scanning.** The instrument can be set to automatically take a number of readings and store them in memory. This makes it possible to measure some or all of the input channels and recall the measurements taken. The following is a simple procedure to measure inputs connected to channels 0 through 7 of the HP 44491A Multiplexer.

- Determine the type of measurement you wish to make (Voltage, Resistance, Current, Frequency/Period) and set the instrument for that measurement as described in the previous paragraphs.
- Select the Rear/Scanner input - Press the TERM / M configuration key. Use the ↑/AUTO or ↓/HOLD scroll key to display REAR:2 or SCANNER:2 and press the ENT / LAST ENTRY key.
- Set the Trigger to Hold - Press the Blue SHIFT key then the STORE / T configuration key. Use the ↓/HOLD scroll key to display the TRIG command. Press the → display key once to hold the command. Use the ↑/AUTO or ↓/HOLD scroll key to display HOLD:4 and press the ENT / LAST ENTRY key.
- Set the number of readings for the number of measurements to be made (in this case 8) - Press the NRDGS / L configuration key, enter the number 8 and press the ENT / LAST ENTRY key.
- Set the Scan Advance to Auto - Press the SCAN ADV / O configuration key. Use the ↑/AUTO or ↓/HOLD scroll key to display AUTO:2 and press the ENT / LAST ENTRY key.
- Enable the Reading Memory - Press the CONFIG / P configuration key then the ENT / LAST ENTRY key.
- Allocate Reading Memory space (each reading requires 4 bytes of memory) - Press the Blue SHIFT key then the TERM / M configuration key. Use the ↓/HOLD scroll key to display MSIZE. Enter the number 32 (8 readings times 4 bytes) and press the ENT / LAST ENTRY key.
- Select the channels to be measured - Press the Blue SHIFT key then the RECALL / S configuration key. Use the ↓/HOLD scroll key to display SLIST. Enter the number of each channel you wish to measure followed by a comma (,) to separate them (example: 0,1,2,3,4,5,6,7). Press the ENT / LAST ENTRY key. *(As many as 16 single digit channel numbers or 8 double digit channel numbers can be entered at one time. The number of readings (NRDGS) should be set for the number of channels entered).*

- Make the measurement - Press the SINGLE / F configuration key to start the measurement sequence. The instrument will read each channel listed and store the readings in memory.
- Recall the readings - Press the Reading Memory RECALL / S key then the ENT / LAST ENTRY key. The reading displayed is the last reading taken. The readings are shifted into memory so that the first reading taken is in the highest number memory location. The last reading taken is in memory location 1. Use the ↑/AUTO and ↓/HOLD scroll keys to view the measurement readings. Use the ←/TEST and →/RESET display keys to read the total display contents.
- To repeat the same set of measurements - Press the CONFIG / R configuration key then the ENT / LAST ENTRY key to clear the reading memory. Press the SINGLE / F configuration key to start the new reading sequence.

### 3-45. HP 44492A Reed Relay Multiplexer (Manual Operation)

3-46. The HP 44492A Reed Relay Multiplexer has ten 2-wire input channels numbered 0 through 9. This multiplexer is used to make voltage, resistance and frequency or period measurements. It is not designed to make 4-wire ohms or current measurements.

**3-47. Measurement Selection.** Determine the type of measurement you wish to make (Voltage, Resistance or Frequency/Period) and set the instrument for that measurement as described in the previous paragraphs.

**3-48. Input Selection.** To use the Reed Relay Multiplexer, the instrument must be set to the Rear/Scanner input.

- Select the Rear/Scanner input - Press the TERM / M configuration key. Use the ↑/AUTO or ↓/HOLD scroll key to display REAR:2 or SCANNER:2 and press the ENT / LAST ENTRY key.

**3-49. Channel Selection.** Only one input channel can be selected at a time. When an input channel is closed, the channel previously closed is automatically opened.

- To select an input channel - Press the CHAN / N configuration key, enter the number of the channel to be closed and press the ENT / LAST ENTRY key.
- To open all channels - Press the Blue SHIFT key then the OFFSET COMP / C key. Use the ↓/HOLD scroll key to display CRESET and press the ENT / LAST ENTRY key.

**3-50. Scanning.** The instrument can be set to automatically take a number of readings and store them in memory. This makes it possible to measure some or all of the input channels and recall the measurements taken. The following is a simple procedure to measure inputs connected to channels 0 through 9 of the HP 44492A Reed Relay Multiplexer.

- Determine the type of measurement you wish to make (Voltage, 2-Wire Resistance, Frequency/Period) and set the instrument for that measurement as described in the previous paragraphs.
- Select the Rear/Scanner input - Press the TERM / M configuration key. Use the ↑/AUTO or ↓/HOLD scroll key to display REAR:2 or SCANNER:2 and press the ENT / LAST ENTRY key.
- Set the Trigger to Hold - Press the Blue SHIFT key then the STORE / T configuration key. Use the ↓/HOLD scroll key to display the TRIG command. Press the →/RESET display key once to hold the command. Use the ↑/AUTO or ↓/HOLD scroll key to display HOLD:4 and press the ENT / LAST ENTRY key.
- Set the number of readings to match the number of measurements to be made (in this case 10) - Press the NDRGS / L configuration key, enter the number 10 and press the ENT / LAST ENTRY key.



- Set the Scan Advance to Auto - Press the SCAN ADV / O configuration key. Use the ↑ / AUTO or ↓ / HOLD scroll key to display AUTO:2 and press the ENT / LAST ENTRY key.
- Enable the Reading Memory - Press the CONFIG / R configuration key then the ENT / LAST ENTRY key.
- Allocate Reading Memory space (each reading requires 4 bytes of memory) - Press the Blue SHIFT key then the TERM / M configuration key. Use the ↓ / HOLD scroll key to display MSIZE. Enter the number 40 (10 readings times 4 bytes) and press the ENT / LAST ENTRY key.
- Select the channels to be measured - Press the Blue SHIFT key then the RECALL / S configuration key. Use ↓ / HOLD scroll key to display SLIST. Enter the number of each channel you wish to measure followed by a comma (,) to separate them (example: 0,1,2,3,4,5,6,7,8,9). Press the ENT / LAST ENTRY key. (As many as 16 single digit channel numbers can be entered at one time. The number of readings (NRDGS) should be set to match the number of channels entered).
- Make the measurement - Press the SINGLE / F configuration key to start the measurement sequence. The instrument will read each channel listed and store the readings in memory.
- Recall the readings - Press the Reading Memory RECALL / S key then the ENT / LAST ENTRY key. The reading displayed is the last reading taken. The readings are shifted into memory so that the first reading taken is in the highest number memory location. The last reading taken is in memory location 1. Use the ↑ / AUTO and ↓ / HOLD scroll keys to view the measurement readings. Use the ← and → display keys to read the total display contents.
- To repeat the same set of measurements - Press the CONFIG / R configuration key then the ENT / LAST ENTRY key to clear the reading memory. Press the SINGLE / F configuration key to start the new reading sequence.

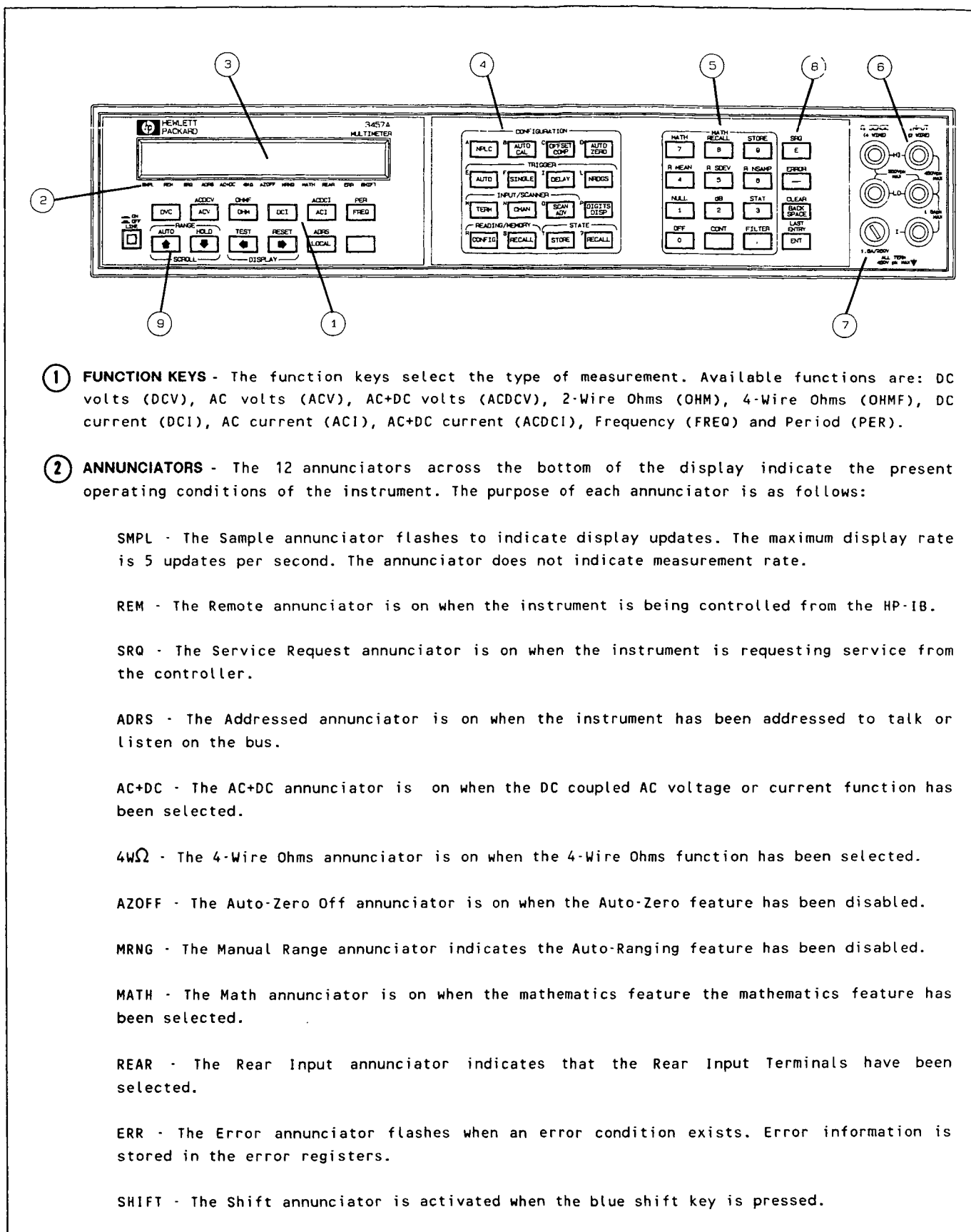

① **FUNCTION KEYS** - The function keys select the type of measurement. Available functions are: DC volts (DVC), AC volts (ACV), AC+DC volts (ACDCV), 2-Wire Ohms (OHM), 4-Wire Ohms (OHMF), DC current (DCI), AC current (ACI), AC+DC current (ACDCI), Frequency (FREQ) and Period (PER).

② **ANNUNCIATORS** - The 12 annunciators across the bottom of the display indicate the present operating conditions of the instrument. The purpose of each annunciator is as follows:

SMPL - The Sample annunciator flashes to indicate display updates. The maximum display rate is 5 updates per second. The annunciator does not indicate measurement rate.

REM - The Remote annunciator is on when the instrument is being controlled from the HP-IB.

SRQ - The Service Request annunciator is on when the instrument is requesting service from the controller.

ADRS - The Addressed annunciator is on when the instrument has been addressed to talk or listen on the bus.

AC+DC - The AC+DC annunciator is on when the DC coupled AC voltage or current function has been selected.

4WΩ - The 4-Wire Ohms annunciator is on when the 4-Wire Ohms function has been selected.

AZOFF - The Auto-Zero Off annunciator is on when the Auto-Zero feature has been disabled.

MRNG - The Manual Range annunciator indicates the Auto-Ranging feature has been disabled.

MATH - The Math annunciator is on when the mathematics feature the mathematics feature has been selected.

REAR - The Rear Input annunciator indicates that the Rear Input Terminals have been selected.

ERR - The Error annunciator flashes when an error condition exists. Error information is stored in the error registers.

SHIFT - The Shift annunciator is activated when the blue shift key is pressed.

Figure 3-3. Front Panel Features

- ③ **DISPLAY** - The display is a 12 character alphanumeric liquid crystal display (LCD). The display is used to show measurement readings and to display messages. When measurements are displayed, the first character indicates the polarity, characters 2 through 8 display the measurement value and the last four characters provide function and range information. The display buffer stores up to 24 characters. Use the ← and → display keys to view displays in excess of 12 characters.
- ④ **CONFIGURATION KEYS** - The Math Keys are used to set the operating parameters of the instrument. These keys permit the user to access the command catalog to configure 62 operating parameters. The most commonly used parameters are set by pressing one of the sixteen configuration keys and entering the appropriate parameter value.
- ⑤ **MATH KEYS** - The Math Keys access 13 built-in mathematical functions.
- ⑥ **INPUT TERMINALS** - The five Input Terminals provide HI and LO input connections voltage resistance and current measurements. DC voltage, AC voltage, AC+DC voltage and 2-Wire resistance measurements are made through the INPUT HI and LO terminals. DC current AC current and AC+DC current measurements are made through the INPUT LO and I terminals. 4-Wire resistance measurements are made through the Ω SENSE HI and LO terminals and the INPUT HI and LO terminals.
- ⑦ **FUSE** - The fuse protects the current input circuitry by limiting the input current to 1.5 amps.
- ⑧ **OTHER KEYS** - These special keys perform the following functions:
- E/SRQ key - In the normal state this key allows the user to enter exponents (E). In the shifted state, this key sets the Request Service bit.
- /ERROR key - In the normal state, this key is used to enter negative numbers. In the shifted state, this key is used to read the Error Register.
- BACK SPACE/CLEAR key - In the normal state, this key is used to back space to correct entries. In the shifted state, this key clears the display.
- ENT/LAST ENTRY key - In the normal state, this key is used to enter information into memory. In the shifted state, this key recalls the last entry made.
- ⑨ **DISPLAY KEYS** - These keys are used to change measurement ranges, scroll through the command catalog, shift display messages left or right, run the instrument self test routine, reset the instrument, read the HP-IB address and return the instrument to local (manual) control.

Figure 3-3. Front Panel Features (cont'd)

# SECTION IV

## PERFORMANCE TESTS

### 4-1. INTRODUCTION

4-2. Section IV contains Performance Tests designed to verify the accuracy of the HP 3457A Multimeter. Accuracy specifications are listed in Table 1-1 of this manual. This section also contains Operational Verification Tests which provide a more rapid method of testing the operation and accuracy of the unit. The Operational Verification Tests are designed to provide a 90% confidence that the HP 3457A is operational and meets specifications. Both the Performance Tests and Operational Verification Tests can be performed without access to the interior of the instrument.

### 4-3. EQUIPMENT REQUIRED

4-4. Equipment required for the performance tests and operational verification tests are listed in the Recommend Test Equipment table in Section I of this manual. Equipment other than that recommended may be used as long as the critical specifications are met.

### 4-5. TEST RECORD

4-6. Results of the performance or operational verification tests may be tabulated on the Test Record located at the end of the respective procedures. The Test Record lists all of the tested specifications and their acceptable limits. It is suggested that the performance tests or operational verification tests be performed and the results tabulated when the instrument is received. These results can be used for comparison with periodic calibration results.

### 4-7. CALIBRATION CYCLE

4-8. This instrument requires periodic performance verification. The frequency at which the instrument should be tested is dependent upon its usage and the environmental operating conditions. To maintain 24 hour specifications, the instrument should be checked daily; to maintain 90 day specifications, the instrument should be checked at 90 day intervals. It is suggested that the performance test be performed at 90 day intervals for normal operation.

### 4-9. TEST CONSIDERATIONS

#### 4-10. General

4-11. Because the HP 3457A is capable of making high accuracy measurements, certain requirements need to be made. For example, standards being used to test accuracy should not introduce any significant uncertainties in the performance tests. A standard which is ten times more accurate than the HP 3457A nearly eliminates uncertainties. In most cases, standards with these accuracies are not readily available, therefore, a compromise is necessary. A primary in house standard, one which has been certified by the National Bureau of Standards (NBS) and can supply the necessary outputs, is recommended. If a primary standard is not available, one of the following may be appropriate:

- a. Use a standard which is three or four times more accurate than the HP 3457A specifications to be tested. Keep in mind, however, the potential uncertainties these standards may introduce.
- b. Use a highly stable calibrated standard and add the correction factors (usually supplied on the calibration charts) to the test reading.
- c. Send the HP 3457A to an HP Service Center or other NBS-certified standards facility for calibration.

## 4-12. PERFORMANCE TESTS

The Performance Tests are divided into 6 main tests, DC Volts, AC Volts, DC Current, AC Current, Ohms, and Frequency. Each test can be performed independently of the others. The steps within each test, however, should be performed in order.

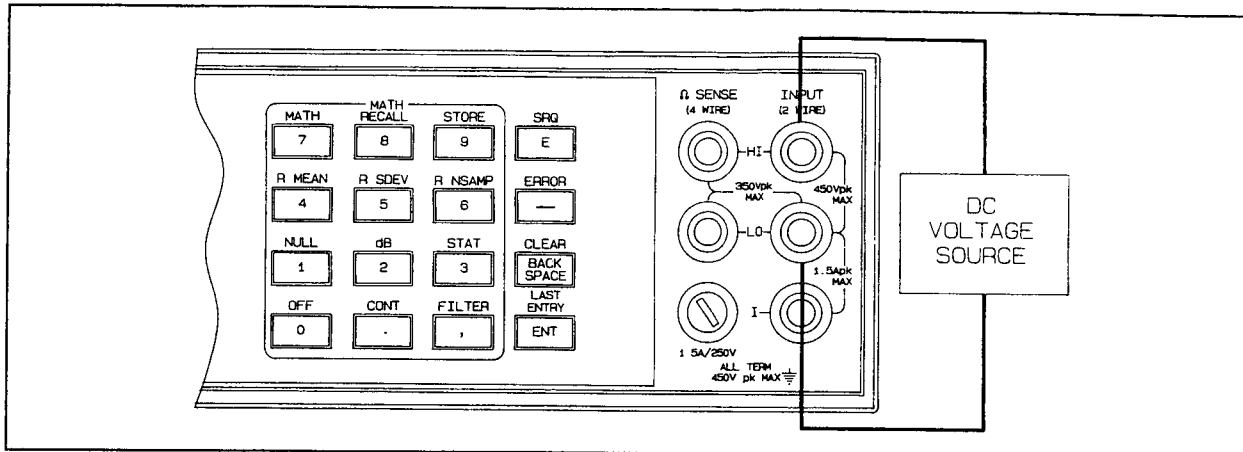

Figure 4-1. DCV Performance Test Connections

### NOTE

*The temperature of the environment where these tests are to be performed must be within  $\pm 5^{\circ}\text{C}$  of the temperature where the instrument was calibrated. The instrument was calibrated at the factory in an area with a temperature of  $24^{\circ}\text{C}$  ( $\pm 1^{\circ}\text{C}$ ).*

## 4-13. Preliminary Steps

1. Turn the instrument ON and allow a one hour warm-up period.
2. Be certain all external inputs are disconnected from the HP 3457A. Run the TEST routine. The test result must read "SELF TEST OK". If the display shows "TEST FAILED", the instrument probably needs repair.
3. Run the AUTO CAL routine. (Press the AUTO CAL key, enter the number 1 and press the ENT key).

## DC Voltage Performance Tests

### 4-14. DC Voltage Function - Offset Test

**4-15. Equipment Required.** A low thermal short (copper wire) is required for this procedure.

1. Connect a low thermal short across the Front Panel HI and LO Input Terminals.
2. Set the HP 3457A to the DC Voltage function (DCV) and the number of digits displayed (DIGITS DISP) to six.

## DC Voltage Performance Tests Cont'd

3457A Input	3457A Range	3457A Set Up	90 day limits		1 year limits	
			High	Low	High	Low
Short	300 V	DCV	+000.0007 V	-000.0007 V	+000.0007 V	-000.0007 V
Short	30 V	DCV	+ 00.00020 V	- 00.00020 V	+ 00.00020 V	- 00.00020 V
Short	3 V	DCV	+ 0.000007 V	- 0.000007 V	+ 0.000007 V	- 0.000007 V
Short	300 mV	DCV	+000.0040 mV	-000.0040 mV	+000.0040 mV	-000.0040 mV
Short	30 mV	DCV	+ 00.00385 mV	- 00.00385 mV	+ 00.00385 mV	- 00.00385 mV
30 mV	30 mV	DCV	+ 30.00505 mV	+ 29.99495 mV	+ 30.00520 mV	+ 29.99480 mV
300 mV	300 mV	DCV	+300.0115 mV	+299.9885 mV	+300.0145 mV	+299.9855 mV
3 V	3 V	DCV	+ 3.000058 V	+ 2.999942 V	+ 3.000082 V	+ 2.999918 V
2 V	3 V	DCV	+ 2.000041 V	+ 1.999959 V	+ 2.000057 V	+ 1.999943 V
1 V	3 V	DCV	+ 1.000024 V	+ 0.999976 V	+ 1.000032 V	+ 0.999968 V
-1 V	3 V	DCV	- 0.999976 V	- 1.000024 V	- 0.999968 V	- 1.000032 V
-2 V	3 V	DCV	- 1.999959 V	- 2.000041 V	- 1.999943 V	- 2.000057 V
-3 V	3 V	DCV	- 2.999942 V	- 3.000058 V	- 2.999918 V	- 3.000082 V
30 V	30 V	DCV	+ 30.00125 V	+ 29.99875 V	+ 30.00140 V	+ 29.99860 V
300 V	300 V	DCV	+300.0157 V	+299.9843 V	+300.0172 V	+299.9828 V

Table 4-1. DC Voltage Test Limits

3. Test the HP 3457A input offset on the 300 V, 30 V, 3 V, 300 mV and 30 mV ranges and record the reading of each range on the Test Record provided at the end of this section. Begin with the 300 V range to allow any thermal voltages which might affect the readings on the lower ranges to dissipate.

4. If any of the offset readings are beyond the limits specified on the Test Record, the instrument should be calibrated or repaired. Refer to Section V of this manual for calibration procedures.

5. Remove the short from the Front Panel Input Terminals.

#### 4-16. DC Voltage Function - Gain Test

**4-17. Equipment Required.** A DC Voltage Standard capable of providing 30 mV ( $\pm .0055\%$ ), 300 mV ( $\pm .0012\%$ ), 1 V, 2 V and 3 V ( $\pm .0006\%$ ), 30 V ( $\pm .0013\%$ ) and 300 V ( $\pm .0017\%$ ) is required for this procedure.

1. Set the output of the DC Voltage Standard to 30 mV and connect it to the HP 3457A front panel HI and LO Input Terminals. See Figure 4-1.

2. Use the Test Record to record the full-scale readings for the 30 mV, 300 mV, 3 V, 30 V and 300 V ranges. Begin with the 30 mV range.

3. If any of the full-scale readings are beyond the specified limits, refer to Section V for calibration procedures.

4. Reduce the output of the Voltage Standard to 3 volts.

## DC Voltage Performance Tests Cont'd

### 4-18. DC Voltage Function - Linearity Test

**4-19 Equipment Required.** A DC Voltage Standard capable of providing 1 V, 2 V and 3 V ( $\pm .0006\%$ ) is required for this procedure.

1. Set the HP 3457A to the 3 V range.
2. Set the Voltage Standard to 3 V, 2 V and 1 V. Use the Test Record to record the 3 V, 2 V and 1 V readings.
3. Reverse the leads at the Input Terminals of the HP 3457A to provide a negative input voltage.
4. Set the Voltage Standard to 1 V, 2 V and 3 V. Use the Test Record to record the -1 V, -2 V and -3 V readings.
6. If any of the linearity readings are beyond the limits specified, refer to Section V for calibration procedures. If the problem can not be corrected with calibration, refer to Section VIII for troubleshooting information.
7. Disconnect the DC Voltage Standard from the HP 3457A Input Terminals.

## AC Voltage Performance Tests

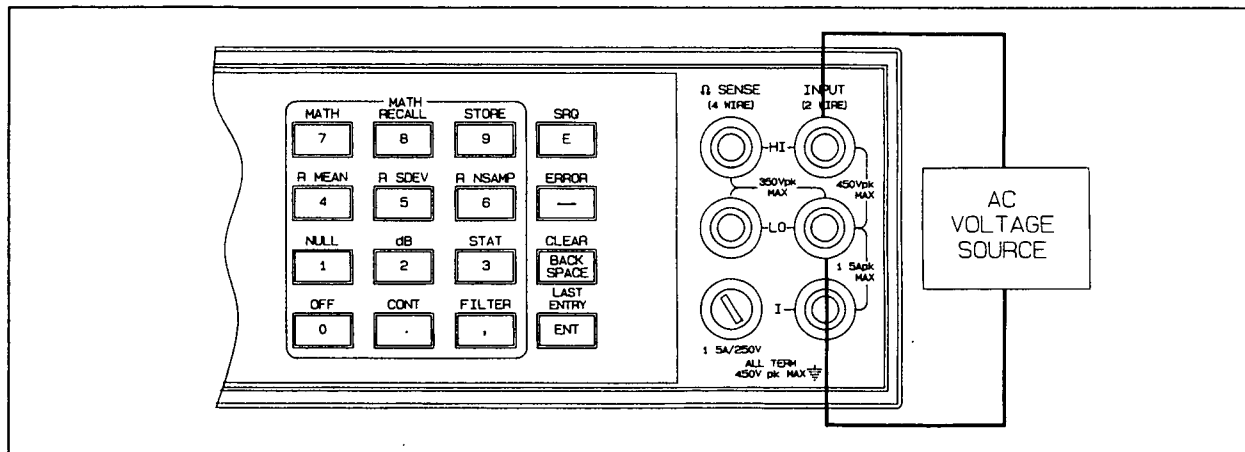

Figure 4-2. ACV Performance Test Connections

### 4-20. AC Voltage Function - Gain Test

**4-21. Equipment Required.** An AC Signal Source capable of providing sine-wave voltages of 30 mV, 300 mV, 1 V, 2 V, 3 V, 30 V and 300 V ( $\pm 0.1\%$ ) at a frequency of 1 KHz is required for the following procedure.

1. Set the output of the AC Signal Source for an output voltage of 30 mV at a frequency of 1 KHz and connect it to the HP 3457A front panel HI and LO input terminals.

**AC Voltage Performance Tests Cont'd**

2. Use the Test Record to record the 30 mV, 300 mV, 3 V, 30 V and 300 V full-scale readings beginning with the 30 mV range.
3. Test the HP 3457A accuracy at one-tenth of full-scale on the 300 V, 30 V, 3 V and 300 mV ranges. Set the HP 3457A to each range and the AC Signal Source to provide a voltage equal to one-tenth of the full-scale value of the range selected. Use the Test Record to record the readings for each range.
4. If any of the gain readings are beyond the limits specified in Table 4-2 and on the Test Record, the instrument should be calibrated or repaired. Refer to Section V of this manual for calibration procedures.
5. Set the AC Voltage Standard for an output of 30 mV.

3457A Input	Input Freq.	3457A Range	3457A Set Up	90 day limits	
				High	Low
30 mV	1 kHz	30 mV	ACV	30.05020 mV	29.94980 mV
300 mV	1 kHz	300 mV	ACV	300.5020 mV	299.4980 mV
1 V	1 kHz	3 V	ACV	1.002420 V	0.997580 V
2 V	1 kHz	3 V	ACV	2.003720 V	1.996280 V
3 V	1 kHz	3 V	ACV	3.005100 V	2.994900 V
30 V	1 kHz	30 V	ACV	30.05020 V	29.94980 V
300 V	1 kHz	300 V	ACV	300.6820 V	299.3180 V
30 V	1 kHz	300 V	ACV	030.1690 V	029.8310 V
3 V	1 kHz	30 V	ACV	03.01510 V	02.98490 V
300 mV	1 kHz	3 V	ACV	0.301510 V	0.298490 V
30 mV	1 kHz	300 mV	ACV	030.1510 mV	029.8490 mV

**Table 4-2. AC Gain Test Limits**

**4-22. AC Voltage Function - Frequency Response Test**

**4-23. Equipment Required.** An AC Signal Source capable of providing sine-wave voltages of 30 mV, 300 mV and 3 V at frequencies of 1 MHz, 300KHz, 100 KHz, 20 KHz, 6.5 KHz, 400 Hz, 100 Hz, 45 Hz and 20 Hz is required for the following procedure. Table 4-3 lists the required accuracy of the test equipment.

VOLTAGE	FREQUENCY								
	1MHz	300KHz	100KHz	20KHz	6.5KHz	400Hz	100Hz	45Hz	20Hz
30 mV	+ - 10%	+ - 2%	+ - .6%	+ - .3%	+ - .3%	+ - .3%			
300 mV	+ - 3%	+ - 1%	+ - .2%	+ - .2%	+ - .2%	+ - .2%	+ - .1%	+ - .3%	+ - .3%
3 V	+ - 3%	+ - 1%	+ - .2%	+ - .2%	+ - .2%	+ - .2%	+ - .1%	+ - .3%	+ - .3%

**Table 4-3. AC Signal Source Voltage Accuracy Requirements**

1. Set the AC Voltage Standard for an output voltage of 30 mV and connect it to the HP 3457A front panel HI and LO input terminals.



**AC Voltage Performance Tests Cont'd**

3457A Input	Input Freq.	3457A Range	3457A Set Up	90 day limits	
				High	Low
30 mV	1 MHz	300 mV	ACF	039.6880 mV	020.3120 mV
" "	300 kHz	" "	"	031.9180 mV	028.0820 mV
" "	100 kHz	" "	"	030.4080 mV	029.5920 mV
" "	20 kHz	" "	"	030.1510 mV	029.8490 mV
" "	6.5 kHz	" "	"	030.1510 mV	029.8490 mV
" "	400 Hz	" "	"	030.1510 mV	029.8490 mV
300 mV	1 MHz	300 mV	ACF	337.1200 mV	262.8800 mV
" "	300 kHz	" "	"	310.4500 mV	289.5500 mV
" "	100 kHz	" "	"	302.1900 mV	297.8100 mV
" "	20 kHz	" "	"	300.5320 mV	299.4680 mV
" "	6.5 kHz	" "	"	300.5320 mV	299.4680 mV
" "	400 Hz	" "	"	300.5320 mV	299.4680 mV
300 mV	1 MHz	3 V	ACF	0.396880 V	0.203120 V
" "	300 kHz	" "	"	0.319180 V	0.280280 V
" "	100 kHz	" "	"	0.304080 V	0.295920 V
" "	20 kHz	" "	"	0.301510 V	0.298490 V
" "	6.5 kHz	" "	"	0.301510 V	0.298490 V
" "	400 Hz	" "	"	0.301510 V	0.298490 V
3 V	1 MHz	3 V	ACF	3.371200 V	2.628800 V
" "	300 kHz	" "	"	3.104500 V	2.895500 V
" "	100 kHz	" "	"	3.021900 V	2.978100 V
" "	20 kHz	" "	"	3.005320 V	2.994680 V
" "	6.5 kHz	" "	"	3.005320 V	2.994680 V
" "	400 Hz	" "	"	3.005320 V	2.994680 V
3 V	100 Hz	3 V	ACS	3.007420 V	2.992580 V
" "	45 Hz	" "	"	3.017920 V	2.982080 V
" "	20 Hz	" "	"	3.017920 V	2.982080 V
300 mV	100 Hz	300 mV	ACS	300.7420 mV	299.2580 mV
" "	45 Hz	" "	"	301.7920 mV	298.2180 mV
" "	20 Hz	" "	"	301.7920 mV	298.2180 mV

**Table 4-4. AC Frequency Response Test Limits**

2. Set the HP 3457A to the AC Voltage function (ACV), the range to 300 mV and the AC Bandwidth to AC Fast. (To change the Bandwidth - Press the SHIFT key, then the Configuration A key. Use the ↓ scroil key to display ACBAND. Enter a number greater than 400 and press the ENT key).
3. Use the Test Record to record the 30 mV (300 mV tenth-scale) readings at 400 Hz, 6.5 KHz, 20 KHz, 100 KHz, 300 KHz and 1 MHz.
4. Set the AC Voltage Standard for an output voltage of 300 mV.
5. Use the Test Record to record the 300 mV readings at 1 MHz, 300 KHz, 100 KHz, 20 KHz, 6.5 KHz and 400 Hz.

## AC Voltage Performance Tests Cont'd

6. Set the HP 3457A to the 3 volt range.
7. Use the Test Record to record the 300 mV (3 V tenth-scale) readings at 400 Hz, 6.5 KHz, 20 KHz, 100 KHz, 300 KHz and 1 MHz.
8. Set the AC Voltage Standard for an output voltage of 3 volts.
9. Use the Test Record to record the 3 V readings at 1 MHz, 300 KHz, 100 KHz, 20 KHz, 6.5KHz and 400 Hz.
10. Set the HP 3457A AC Bandwidth to AC Slow. (Press the SHIFT key, then the Configuration A. Use the ↓ scroll key to display ACBAND. Enter a number less than 400 and press the ENT key).
11. Use the Test Record to record the 3 V readings at 100 Hz, 45 Hz and 20 Hz.
12. Set the AC Voltage Standard for an output voltage of 300 mV.
13. Set the HP 3457A to the 300 mV range.
14. Use the Test Record to record the 300 mV readings at 20 Hz, 45 Hz and 100 Hz.
15. Reduce the output of the AC Voltage Standard and disconnect it from the HP 3457A input terminals.
16. If any of the readings are beyond the limits specified in Table 4-4 and on the Test Record, the instrument should be calibrated or repaired. Refer to Section V of this manual for calibration procedures.

## DC Current Performance Tests

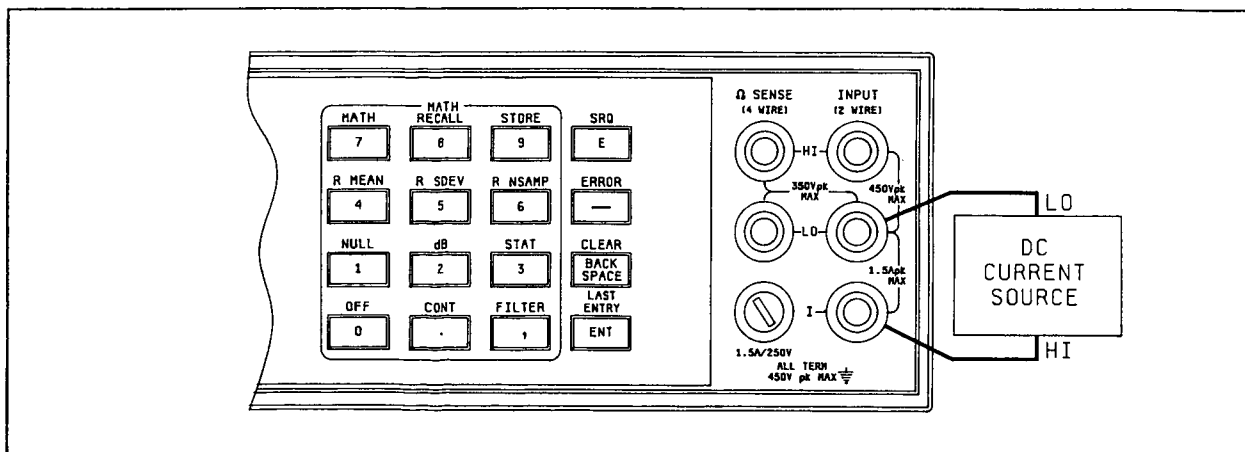

Figure 4-3. DCI Performance Test Connections

## DC Current Performance Tests Cont'd

3457A Input	3457A Range	3457A Set Up	90 day limits		1 year limits	
			High	Low	High	Low
Open	300 $\mu$ A	DCI	+000.0104 $\mu$ A	-000.0104 $\mu$ A	+000.0104 $\mu$ A	-000.0104 $\mu$ A
Open	3 mA	DCI	+0.000104 mA	-0.000104 mA	+0.000104 mA	-0.000104 mA
Open	30 mA	DCI	+00.00104 mA	-00.00104 mA	+00.00104 mA	-00.00104 mA
Open	300 mA	DCI	+000.0204 mA	-000.0204 mA	+000.0204 mA	-000.0204 mA
Open	1 A	DCI	+0.000604 A	-0.000604 A	+0.000604 A	-0.000604 A
300 $\mu$ A	300 $\mu$ A	DCI	300.0704 $\mu$ A	299.9296 $\mu$ A	300.1304 $\mu$ A	299.8696 $\mu$ A
3 mA	3 mA	DCI	3.000704 mA	2.999296 mA	3.001304 mA	2.998696 mA
30 mA	30 mA	DCI	30.00704 mA	29.99296 mA	30.01304 mA	29.98696 mA
300 mA	300 mA	DCI	300.2304 mA	299.7696 mA	300.2604 mA	299.7396 mA
1 A	1 A	DCI	1.001304 A	0.998696 A	1.001304 A	0.998696 A

Table 4-5. DC Current Offset and Gain Test Limits

## 4-24. DC Current Function - Offset Test

4-25. **Equipment Required.** This procedure does not require any test equipment.

1. Set the HP 3457A to the DC Current function (DCI), 300  $\mu$ A range, and the number of digits displayed (DIGITS DISP) to six.
2. Use the Test Record to record the current offset readings on the 300  $\mu$ A, 3 mA, 30 mA, 300 mA and 1 A ranges.
3. If any of the offset readings are beyond the limits specified in Table 4-5 and on the Test Record, the instrument should be calibrated or repaired. Refer to Section V of this manual for calibration procedures.

## 4-26. DC Current Function - Gain Test

4-27. **Equipment Required.** A DC Current Source capable of providing currents of 300  $\mu$ A, 3 mA, 30 mA ( $\pm .007\%$ ), 300 mA ( $\pm .026\%$ ), and 1 A ( $\pm .04\%$ ) is required for the following procedure.

1. Set the DC Current Source to 300  $\mu$ A and connect it to the HP 3457A front panel I and L0 input terminals.
2. Set the HP 3457A to the 300  $\mu$ A range and the number of digits displayed (DIGITS DISP) to six.
3. Use the Test Record to record the full-scale current readings for the 300  $\mu$ A, 3 mA, 30 mA, 300 mA and 1 A ranges.
4. If any of the full-scale readings are beyond the limits specified in Table 4-5 and on the Test Record, the instrument should be calibrated or repaired. Refer to Section V of this manual for calibration procedures.
5. Reduce the output of the DC Current Source and disconnect it from the HP 3457A input terminals.

### AC Current Performance Tests

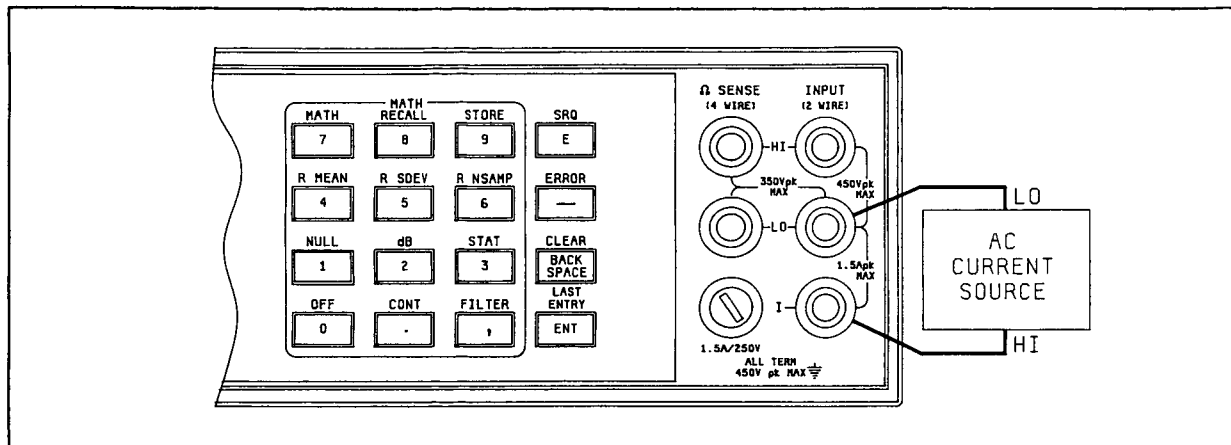

Figure 4-4. ACI Performance Test Connections

#### 4-28. AC Current Function - Gain Test

**4-29. Equipment Required,** An AC Current Source capable of providing currents of 30 mA ( $\pm .14\%$ ), 300 mA ( $\pm .14\%$ ) and 1 A ( $\pm .24\%$ ) at a frequency between 100 Hz and 20 KHz is required for the following test.

1. Set the AC Current source for an output of 30 mA at a frequency between 100 Hz and 20 KHz and connect it to the HP 3457A front panel I and LO input terminals.
2. Set the HP 3457A to the 30 mA range and the number of digits displayed (DIGITS DISP) to six.
3. Use the Test Record to record the 30 mA, 300 mA and 1 A full-scale readings.
4. If the full-scale readings are beyond the limits specified in Table 4-6 and on the Test Record, the instrument should be calibrated or repaired. Refer to Section V of this manual for calibration procedures.
5. Reduce the output of the AC Current Source and disconnect it from the HP 3457A input terminals.

3457A Input	3457A Range	3457A Set Up	90 day limits	
			High	Low
30 mA	30 mA	ACI	30.10300 mA	29.89700 mA
300 mA	300 mA	ACI	301.0300 mA	298.9700 mA
1 A	1 A	ACI	1.005300 A	0.994700 A

Table 4-6. AC Current Test Limits

### 2-Wire Ohms Performance Tests

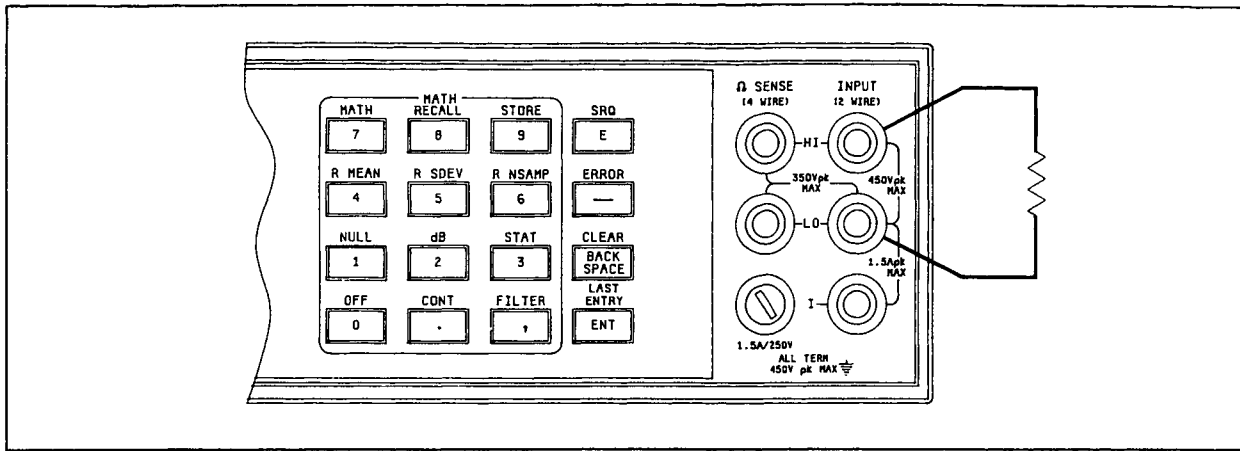

Figure 4-5. 2-Wire Ohms Performance Test Connections

#### 4-30. 2-Wire Ohms Function - Offset Test

4-31. **Equipment Required.** A low thermal short (copper wire) is required for this procedure.

1. Connect a low thermal short across the HP 3457A front panel HI and LO input terminals.
2. Set the HP 3457A to the 2-Wire Ohms Function, 30 Ohm range and the number of digits displayed (DIGITS DISP) to six.
3. Use the Test Record to record the offset readings for the 30 Ohm, 300 Ohm, 3 Kohm, 30 Kohm, 300 Kohm, 3 Mohm and 30 Mohm ranges.
4. If any of the offset readings are beyond the limits specified in Table 4-7 and on the Test Record, the instrument should be calibrated or repaired. Refer to Section V for calibration procedures.
5. Remove the short from the front panel input terminals.

3457A Input	3457A Range	3457A Set Up	90 day limits	1 year limits
Short	30 ohm	OHM	00.20335 ohm	00.20335 ohm
Short	300 ohm	OHM	000.2035 ohm	000.2035 ohm
Short	3 Kohm	OHM	0.000207 Kohm	0.000207 Kohm
Short	30 Kohm	OHM	00.00027 Kohm	00.00027 Kohm
Short	300 Kohm	OHM	000.0010 Kohm	000.0010 Kohm
Short	3 Mohm	OHM	0.000014 Mohm	0.000014 Mohm
Short	30 Mohm	OHM	00.00083 Mohm	00.00083 Mohm

Table 4-7. 2-Wire Ohms Offset Test Limits

### 2-Wire Ohms Performance Tests Cont'd

**4-32. 2-Wire Ohms Function - Gain Test**

**4-33. Equipment Required.** Resistance Standards of 30 Ohms ( $\pm .2\%$ ), 300 Ohms ( $.02\%$ ), 3 Kohms ( $\pm .003\%$ ) 30 Kohms ( $\pm .001\%$ ), 300 Kohms ( $\pm .001\%$ ) 3 Mohms ( $\pm .001\%$ ), and 30 Mohms ( $\pm .009\%$ ) are required for this procedure.

1. Set the HP 3457A to the 2-wire ohms function (OHM) and the number of digits displayed (DIGITS DISP) to six.
2. Connect the Resistance Standard to the HP 3457A front panel HI and LO input terminals. (The connecting wires should be as short as possible to reduce lead resistance).
3. Use the Test Record to record the 30 Ohm, 300 Ohm, 3 Kohm, 30 Kohm, 300 Kohm, 3 Mohm and 30 Mohm readings.
4. If any of the readings are beyond the limits specified in Table 4-8 and on the Test Record, the instrument should be calibrated or repaired. Refer to Section V for calibration procedures.
5. Remove the Resistance standard from the HP 3457A front panel input terminals.

3457A Input	3457A Range	3457A Set Up	90 day limits		1 year limits	
			High	Low	High	Low
30 ohm	30 ohm	OHM	30.20530 ohm	29.79470 ohm	30.20560 ohm	29.795440ohm
300 ohm	300 ohm	OHM	300.2170 ohm	299.7830 ohm	300.2200 ohm	299.7800 ohm
3 Kohm	3 Kohm	OHM	3.000312 Kohm	2.999688 Kohm	3.000357 Kohm	2.999643 Kohm
30 Kohm	30 Kohm	OHM	30.00132 Kohm	29.99868 Kohm	30.00177 Kohm	29.99823 Kohm
300 Kohm	300 Kohm	OHM	300.0130 Kohm	299.9870 Kohm	300.0160 Kohm	299.9840 Kohm
3 Mohm	3 Mohm	OHM	3.000179 Mohm	2.999821 Mohm	3.000209 Mohm	2.999791 Mohm
30 Mohm	30 Mohm	OHM	30.00833 Mohm	29.99167 Mohm	30.01283 Mohm	29.98717 Mohm

**Table 4-8. 2-Wire Ohms Gain Test Limits**

### 4-Wire Ohms Performance Tests

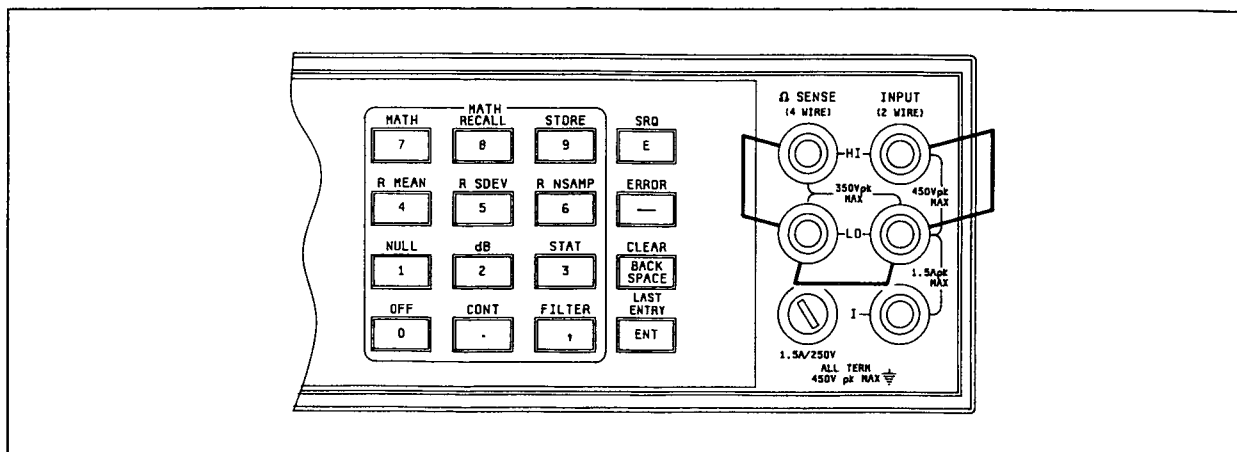

**Figure 4-6. 4-Wire Ohms Offset Performance Test Connections**

### 4-Wire Ohms Performance Tests Cont'd

**4-34. 4-Wire Ohms Function - Offset Test**

**4-35. Equipment Required.** A low thermal short (copper wire) is required for this procedure.

1. Set the HP 3457A to the 4-Wire Ohms Function (OHMF) and the number of digits displayed (DIGITS DISP) to six.
2. Short the front panel input terminals of the HP 3457A as shown in Figure 4-6.
3. Use the Test Record to record the offset readings of the 30 Ohm, 300 Ohm, 3 Kohm, 30 Kohm, 300 Kohm, 3 Mohm, and 30 Mohm ranges.
4. If any of the offset readings are beyond the limits specified in Table 4-9 and on the Test Record, the instrument should be calibrated or repaired. Refer to Section V of this manual for calibration procedures.
5. Remove the short from the front panel input terminals.

3457A Input	3457A Range	3457A Set Up	90 day limits	1 year limits
Short	30 ohm	OHMF	00.00335 ohm	00.00335 ohm
Short	300 ohm	OHMF	000.0035 ohm	000.0035 ohm
Short	3 Kohm	OHMF	0.000007 Kohm	0.000007 Kohm
Short	30 Kohm	OHMF	00.00007 Kohm	00.00007 Kohm
Short	300 Kohm	OHMF	000.0008 Kohm	000.0008 Kohm
Short	3 Mohm	OHMF	0.000014 Mohm	0.000014 Mohm
Short	30 Mohm	OHMF	00.00083 Mohm	00.00083 Mohm

**Table 4-9. 4-Wire Ohms Offset Test Limits**

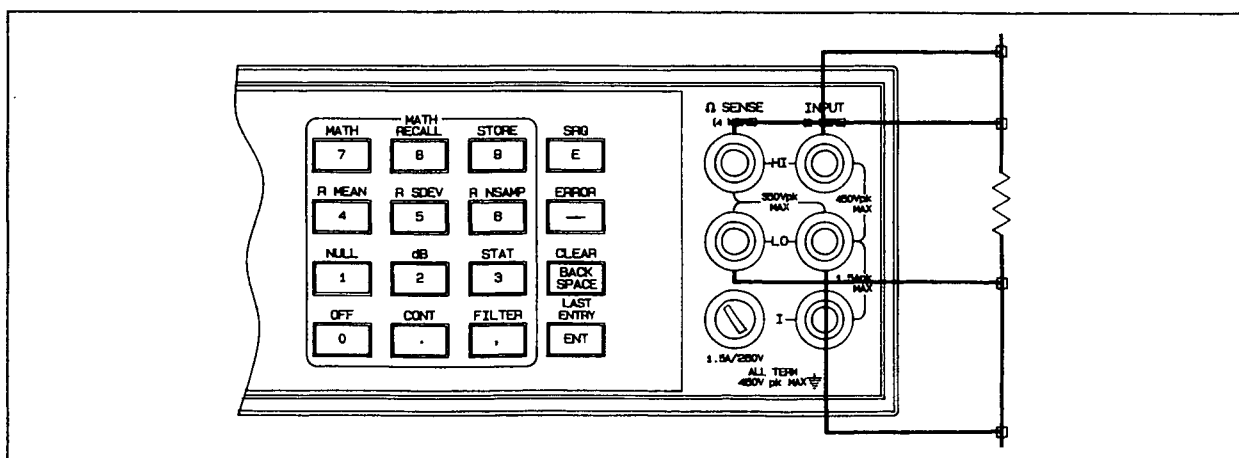

**Figure 4-7. 4-Wire Ohms Gain Performance Test Connections**

### 4-Wire Ohms Performance Tests Cont'd

#### 4-36. 4-Wire Ohms Function - Gain Test

**4-37. Equipment Required.** Resistance Standards of 30 Ohms ( $\pm .004\%$ ), 300 Ohms ( $.002\%$ ), 3 Kohms ( $\pm .001\%$ ) 30 Kohms ( $\pm .001\%$ ), 300 Kohms ( $\pm .001\%$ ), 3 Mohms ( $\pm .001\%$ ) and 30 Mohms ( $\pm .009\%$ ) are required for this procedure.

1. Set the HP 3457A to the 4-Wire ohms function (OHMF) and the number of digits displayed (DIGITS DISP) to six.
2. Connect the appropriate Resistance Standard to the HP 3457A front panel input terminals as shown in Figure 4-7.
3. Use the Test Record to record the resistance readings for the 30 Ohm, 300 Ohm, 3 Kohm, 30 Kohm, 300 Kohm, 3 Mohm and 30 Mohm ranges.
4. If any of the readings are beyond the limits specified in Table 4-10 and on the Test Record, the instrument should be calibrated or repaired. Refer to Section V for calibration procedures.
5. Remove the Resistance Standard from the HP 3457A front panel input terminals.

3457A Input	3457A Range	3457A Set Up	90 day limits		1 year limits	
			High	Low	High	Low
30 ohm	30 ohm	OHMF	30.00530 ohm	29.99470 ohm	30.00560 ohm	29.99440 ohm
300 ohm	300 ohm	OHMF	300.0170 ohm	299.9830 ohm	300.0200 ohm	299.9800 ohm
3 Kohm	3 Kohm	OHMF	3.000112 Kohm	2.999888 Kohm	3.000157 Kohm	2.999843 Kohm
30 Kohm	30 Kohm	OHMF	30.00112 Kohm	29.99888 Kohm	30.00157 Kohm	29.99844 Kohm
300 Kohm	300 Kohm	OHMF	300.0128 Kohm	299.9872 Kohm	300.0158 Kohm	299.9842 Kohm
3 Mohm	3 Mohm	OHMF	3.000179 Mohm	2.999821 Mohm	3.000209 Mohm	2.999791 Mohm
30 Mohm	30 Mohm	OHMF	30.00833 Mohm	29.99167 Mohm	30.01283 Mohm	29.98717 Mohm

Table 4-10. 4-Wire Ohms Gain Test Limits

### Frequency Counter Performance Tests

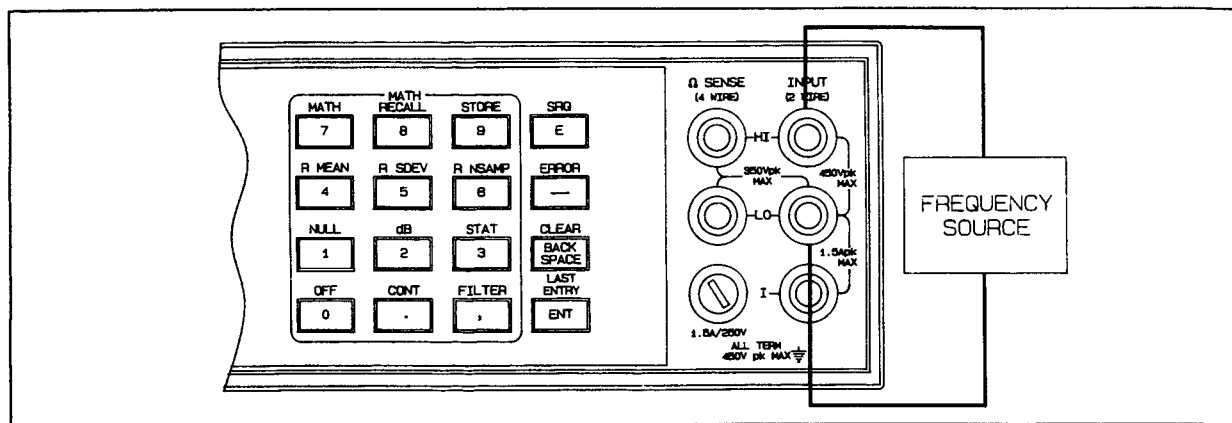

Figure 4-8. Frequency Counter Performance Test Connections



## Frequency Counter Performance Tests Cont'd

### 4-38. Frequency Counter - Accuracy Test

**4-39. Equipment Required.** A Frequency Source capable of providing a 20 Hz ( $\pm .016\%$ ) and a 1 MHz ( $\pm .003\%$ ) sine-wave signal is required for this procedure.

1. Set the HP 3457A to the Frequency Function (FREQ).
2. Set the Frequency Standard for a 1 volt, 20 Hz sine-wave output signal and connect it to the HI and LO input terminals of the HP 3457A.
3. Use the Test Record to record the frequency readings at 20 Hz and 1 MHz.
4. If either of the readings are beyond the limits specified, the instrument should be calibrated or repaired. Refer to Section V of this manual for calibration procedures.

## Rear Input Performance Tests (Standard Instrument)

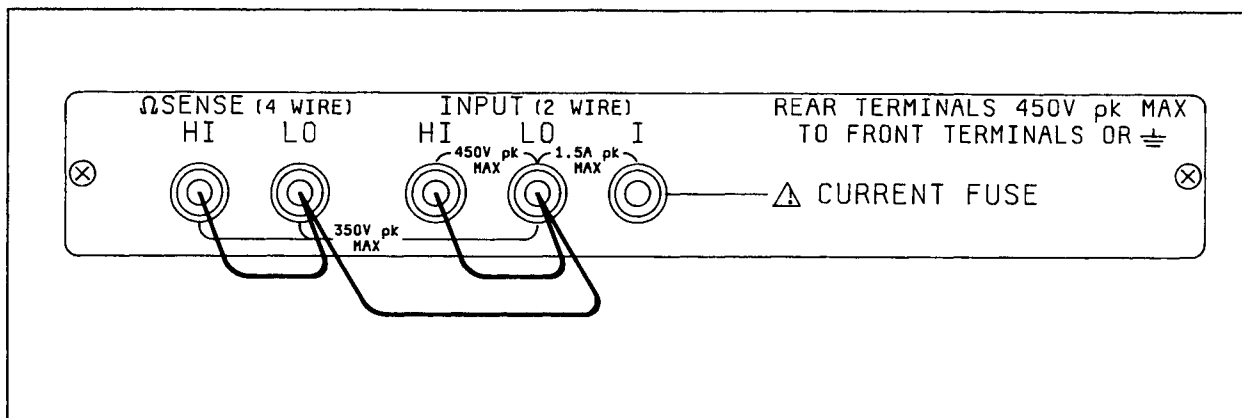

Figure 4-9. Standard Instrument Rear Input Performance Test Connections

### 4-40. Preliminary Steps

1. Short the Rear Input HI and LO terminals and the  $\Omega$  Sense HI and LO terminals as shown in Figure 4-9.
2. Select the Rear Terminal Input. (Press the TERM configuration key, enter the number 2 and press the ENT key.)

### 4-41. DC Voltage Function - Rear Terminal Offset Test

**4-42. Equipment Required.** A low thermal short (copper wire) is required for this procedure.

1. Set the HP 3457A to the DC Voltage function (DCV) and the number of digits displayed (DIGITS DISP) to six.

### Rear Input Performance Tests (Standard Instrument) Cont'd

2. Test the HP 3457A input offset on the 300 V, 30 V, 3 V, 300 mV and 30 mV ranges and record the reading of each range on the Test Record provided at the end of this section. Begin with the 300 V range to allow any thermal voltages which might affect the readings on the lower ranges to dissipate.

3. If any of the offset readings are beyond the limits specified in Table 4-11 and on the Test Record, the instrument should be calibrated or repaired. Refer to Section V for calibration procedures.

3457A Input	3457A Range	3457A Set Up	90 day limits		1 year limits	
			High	Low	High	Low
Short	300 V	DCV	+000.0007 V	-000.0007 V	+000.0007 V	-000.0007 V
Short	30 V	DCV	+ 00.00020 V	- 00.00020 V	+ 00.00020 V	- 00.00020 V
Short	3 V	DCV	+ 0.000007 V	- 0.000007 V	+ 0.000007 V	- 0.000007 V
Short	300 mV	DCV	+000.0040 mV	-000.0040 mV	+000.0040 mV	-000.0040 mV
Short	30 mV	DCV	+ 00.00385 mV	- 00.00385 mV	+ 00.00385 mV	- 00.00385 mV

Table 4-11. DC Voltage Offset Test Limits (Rear Terminals)

#### 4-43. DC Current Function - Rear Terminal Offset Test

4-44. **Equipment Required.** This procedure does not require any test equipment.

1. Set the HP 3457A to the DC Current function (DCI), 300 uA range, and the number of digits displayed (DIGITS DISP) to six.

2. Use the Test Record to record the current offset readings on the 300 uA, 3 mA, 30 mA, 300 mA and 1 A ranges.

3. If any of the offset readings are beyond the limits specified in Table 4-12 and on the Test Record, the instrument should be calibrated or repaired. Refer to Section V for calibration procedures.

3457A Input	3457A Range	3457A Set Up	90 day limits		1 year limits	
			High	Low	High	Low
Open	300 uA	DCI	+000.0104 uA	-000.0104 uA	+000.0104 uA	-000.0104 uA
Open	3 mA	DCI	+0.000104 mA	-0.000104 mA	+0.000104 mA	-0.000104 mA
Open	30 mA	DCI	+00.00104 mA	-00.00104 mA	+00.00104 mA	-00.00104 mA
Open	300 mA	DCI	+000.0204 mA	-000.0204 mA	+000.0204 mA	-000.0204 mA
Open	1 A	DCI	+0.000604 A	-0.000604 A	+0.000604 A	-0.000604 A

Table 4-12. DC Current Offset Test Limits (Rear Terminals)

#### 4-45. 2-Wire Ohms Function - Rear Terminal Offset Test

4-46. **Equipment Required.** A low thermal short (copper wire) is required for this procedure.

1. Set the HP 3457A to the 2-Wire Ohms Function, 30 Ohm range and the number of digits displayed (DIGITS DISP) to six.

**Rear Input Performance Tests (Standard Instrument) Cont'd**

2. Use the Test Record to record the offset readings for the 30 Ohm, 300 Ohm, 3 Kohm, 30 Kohm, 300 Kohm, 3 Mohm and 30 Mohm ranges.

3. If any of the offset readings are beyond the limits specified in Table 4-13 and on the Test Record, the instrument should be calibrated or repaired. Refer to Section V for calibration procedures.

3457A Input	3457A Range	3457A Set Up	90 day limits	1 year limits
Short	30 ohm	OHM	00.20335 ohm	00.20335 ohm
Short	300 ohm	OHM	000.2035 ohm	000.2035 ohm
Short	3 Kohm	OHM	0.000207 Kohm	0.000207 Kohm
Short	30 Kohm	OHM	00.00027 Kohm	00.00027 Kohm
Short	300 Kohm	OHM	000.0010 Kohm	000.0010 Kohm
Short	3 Mohm	OHM	0.000014 Mohm	0.000014 Mohm
Short	30 Mohm	OHM	00.00083 Mohm	00.00083 Mohm

**Table 4-13. 2-Wire Ohms Offset Test Limits (Rear Terminals)**

**4-47. 4-Wire Ohms Function - Offset Test**

**4-48. Equipment Required.** A low thermal short (copper wire) is required for this procedure.

1. Set the HP 3457A to the 4-Wire Ohms Function (OHMF) and the number of digits displayed (DIGITS DISP) to six.

2. Use the Test Record to record the offset readings of the 30 Ohm, 300 Ohm, 3 Kohm, 30 Kohm, 300 Kohm, 3 Mohm, and 30 Mohm ranges.

3. If any of the offset readings are beyond the limits specified in Table 4-14 and on the Test Record, the instrument should be calibrated or repaired. Refer to Section V for calibration procedures.

3457A Input	3457A Range	3457A Set Up	90 day limits	1 year limits
Short	30 ohm	OHMF	00.00335 ohm	00.00335 ohm
Short	300 ohm	OHMF	000.0035 ohm	000.0035 ohm
Short	3 Kohm	OHMF	0.000007 Kohm	0.000007 Kohm
Short	30 Kohm	OHMF	00.00007 Kohm	00.00007 Kohm
Short	300 Kohm	OHMF	000.0008 Kohm	000.0008 Kohm
Short	3 Mohm	OHMF	0.000014 Mohm	0.000014 Mohm
Short	30 Mohm	OHMF	00.00083 Mohm	00.00083 Mohm

**Table 4-14. 4-Wire Ohms Offset Test Limits (Rear Terminals)**

### Rear Input Performance Tests (44491A General Purpose Relay Assy)

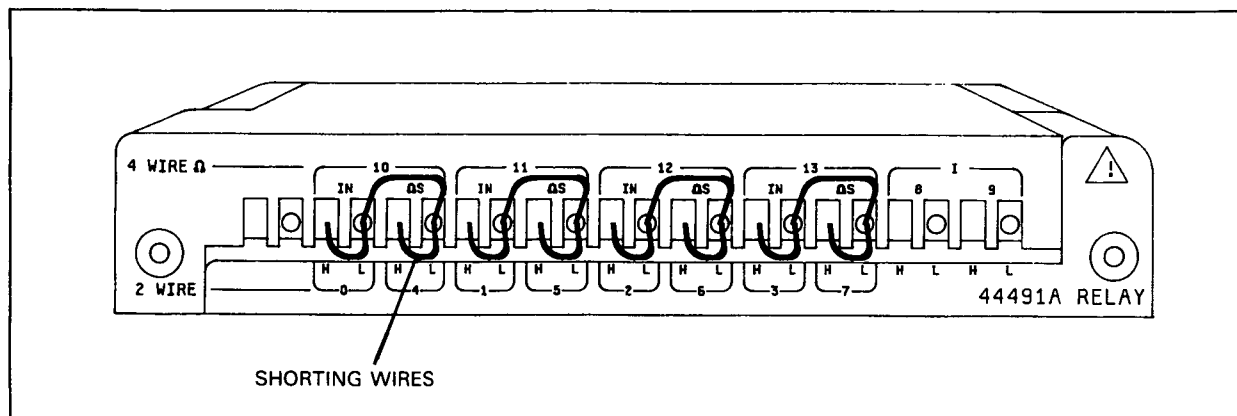

Figure 4-10. HP 44491A Terminal Block Assembly Connections

#### 4-49. Preliminary Steps

1. Short the Rear Input HI and LO terminals and the  $\Omega$  Sense HI and LO terminals as shown in Figure 4-9.
2. Select the Rear Terminal Input. (Press the TERM configuration key, enter the number 2 and press the ENT key.)

#### NOTE

*The 44491A Relay Assembly and the 3457A Multimeter must have been calibrated as a unit for these tests to apply. Calibration procedures are provided in Section V of this manual.*

#### 4-50. DC Voltage Function - 44491A Offset Test

#### 4-51. Equipment Required.

Low thermal (copper) shorting wires are required for this procedure.

1. Set the HP 3457A to the DC Voltage function (DCV) and the number of digits displayed (DIGITS DISP) to six.
2. Close channel 0. (Press the CHAN configuration key, enter the number 0 and press the ENT key).
3. Test the input offset on the 300 V, 30 V, 3 V, 300 mV and 30 mV ranges and record the reading of each range on the Test Record provided at the end of this section. Begin with the 300 V range to allow any thermal voltages which might affect the readings on the lower ranges to dissipate.
4. Test the HP 3457A input offset on channels 0 through 7 with the instrument set to the 30 mV range. Record the reading of each channel on the Test Record provided at the end of this section.
5. If any of the offset readings are beyond the limits specified in Table 4-15 and on the Test Record, the instrument should be calibrated or repaired. Refer to Section V for calibration procedures.

## Rear Input Performance Tests (44491A Relay Assy.) Cont'd

3457A Input	3457A Range	3457A Set Up	Test Limits	
			High	Low
Short	300 V	DCV	+000.0007 V	-000.0007 V
Short	30 V	DCV	+ 00.00020 V	- 00.00020 V
Short	3 V	DCV	+ 0.000010 V	- 0.000010 V
Short	300 mV	DCV	+000.0070 mV	-000.0070 mV
Short	30 mV	DCV	+ 00.00685 mV	- 00.00685 mV

Table 4-15. DC Voltage Offset Test Limits (44491A)

## 4-52. 2-Wire Ohms Function - 44491A Offset Test Limits

4-53. **Equipment Required.** Low thermal (copper) shorting wires are required for this procedure.

1. Set the HP 3457A to the 2-Wire Ohms Function, 30 Mohm range. Set the offset compensation (OFFSET COMP) on, and the number of digits displayed (DIGITS DISP) to six.

2. Close channel 0. (Press the CHAN configuration key, enter the number 0 and press the ENT key).

3. Use the Test Record to record the offset readings for the 30 Mohm, 3 Mohm, 300 Kohm, 30 Kohm, 3 Kohm, 300 Ohm and 30 Ohm ranges.

4. Test the ohms offset on channels 0 through 7 with the instrument set to the 30 Ohm range. Record the reading of each channel on the Test Record provided at the end of this section.

5. If any of the offset readings are beyond the limits specified in Table 4-16 and on the Test Record, the instrument should be calibrated or repaired. Refer to Section V for calibration procedures.

3457A Input	3457A Range	3457A Set Up	Test Limits
Short	30 ohm	OHM	02.20635 ohm
Short	300 ohm	OHM	002.2065 ohm
Short	3 Kohm	OHM	0.002210 Kohm
Short	30 Kohm	OHM	00.00230 Kohm
Short	300 Kohm	OHM	000.0033 Kohm
Short	3 Mohm	OHM	0.000019 Mohm
Short	30 Mohm	OHM	00.00086 Mohm

Table 4-16. 2-Wire Ohms Offset Test Limits (44491A)

## 4-54. 4-Wire Ohms Function - 44491A Offset Test Limits

4-55. **Equipment Required.** Low thermal (copper) shorting wires are required for this procedure.

1. Set the HP 3457A to the 4-Wire Ohms Function (OHMF). Set the offset compensation (OFFSET COMP) on, and the number of digits displayed (DIGITS DISP) to six.

**Rear Input Performance Tests (44491A Relay Assy.) Cont'd**

2. Close channel 10. (Press the CHAN configuration key, enter the number 10 and press the ENT key).
3. Use the Test Record to record the offset readings of the 30 Ohm, 300 Ohm, 3 Kohm, 30 Kohm, 300 Kohm, 3 Mohm, and 30 Mohm ranges.
4. If any of the offset readings are beyond the limits specified in Table 4-17 and on the Test Record, the instrument should be calibrated or repaired. Refer to Section V for calibration procedures.

3457A Input	3457A Range	3457A Set Up	Test Limits
Short	30 ohm	OHMF	00.00635 ohm
Short	300 ohm	OHMF	000.0065 ohm
Short	3 Kohm	OHMF	0.000010 Kohm
Short	30 Kohm	OHMF	00.00010 Kohm
Short	300 Kohm	OHMF	000.0011 Kohm
Short	3 Mohm	OHMF	0.000017 Mohm
Short	30 Mohm	OHMF	00.00086 Mohm

**Table 4-17. 4-Wire Ohms Offset Test Limits (44491A)**

**4-56. DC Current Function - 44491A Offset Test Limits**

**4-57. Equipment Required.** This procedure does not require any test equipment.

1. Set the HP 3457A to the DC Current function (DCI), 300 uA range, and the number of digits displayed (DIGITS DISP) to six.
2. Use the Test Record to record the current offset readings on the 300 uA, 3 mA, 30 mA, 300 mA and 1 A ranges.
3. If any of the offset readings are beyond the limits specified in Table 4-18 and on the Test Record, the instrument should be calibrated or repaired. Refer to Section V for calibration procedures.

3457A Input	3457A Range	3457A Set Up	Test Limits	
			High	Low
Open	300 uA	DCI	+000.0104 uA	-000.0104 uA
Open	3 mA	DCI	+0.000104 mA	-0.000104 mA
Open	30 mA	DCI	+00.00104 mA	-00.00104 mA
Open	300 mA	DCI	+000.0204 mA	-000.0204 mA
Open	1 A	DCI	+0.000604 A	-0.000604 A

**Table 4-18. DC Current Offset Test Limits (44491A)**

### Rear Input Performance Tests (44492A 10 Channel Multiplex Assy)

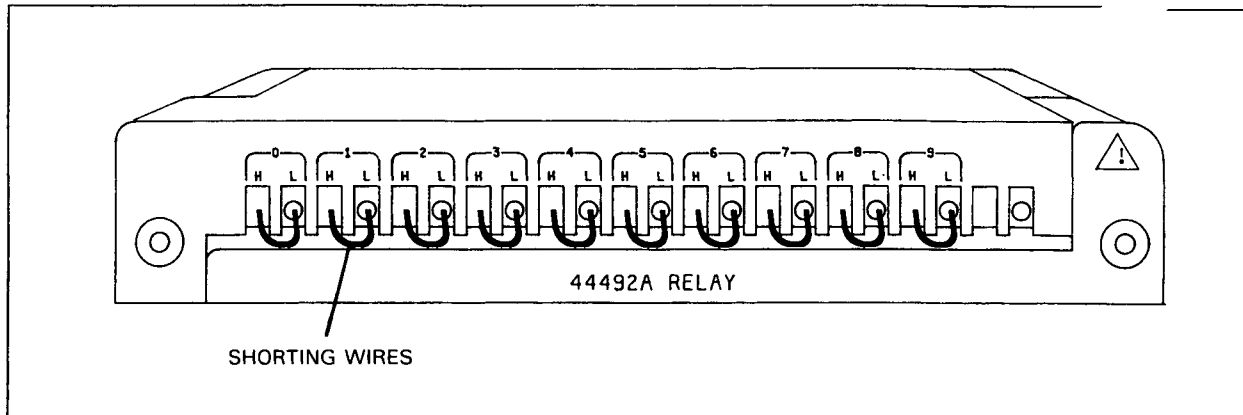

Figure 4-11. HP 44492A Terminal Block Assembly Connections

#### 4-58. Preliminary Steps

1. Connect shorting wires to the inputs of the Terminal Block assembly as shown in Figure 4-11.
2. Select the Scanner Input. (Press the TERM configuration key, enter the number 2 and press the ENT key).

#### NOTE

*The 44492A Multiplexer Assembly and the 3457A Multimeter must have been calibrated as a unit for these tests to apply. Calibration procedures are provided in Section V of this manual.*

#### 4-59. DC Voltage Function - 44492A Offset Test

**4-60. Equipment Required.** A low thermal (copper) shorting wire is required for this procedure.

1. Set the HP 3457A to the DC Voltage function (DCV) and the number of digits displayed (DIGITS DISP) to six.
2. Close channel 0. (Press the CHAN configuration key, enter the number 0 and press the ENT key).
3. Test the HP 3457A input offset on the 300 V, 30 V, 3 V, and 300 mV ranges and record the reading of each range on the Test Record provided at the end of this section. Begin with the 300 V range to allow any thermal voltages which might affect the readings on the lower ranges to dissipate.
4. Test the HP 3457A input offset on channels 0 through 9 with the instrument set to the 30 mV range. Record the reading of each channel on the Test Record provided at the end of this section.
5. If any of the offset readings are beyond the limits specified in Table 4-19 and on the Test Record, the instrument should be calibrated or repaired. Refer to Section V of this manual for calibration procedures.

**Rear Input Performance Tests (44492A Multiplex Assy.) Cont'd**

3457A Input	3457A Range	3457A Set Up	Test Limits	
			High	Low
Short	300 V	DCV	+000.0007 V	-000.0007 V
Short	30 V	DCV	+ 00.00020 V	- 00.00020 V
Short	3 V	DCV	+ 0.000010 V	- 0.000010 V
Short	300 mV	DCV	+000.0070 mV	-000.0070 mV

**Table 4-19. DC Voltage Offset Test Limits (44492A)**

**4-61. 2-Wire Ohms Function - 44492A Offset Test Limits**

**4-62. Equipment Required.** A low thermal (copper) shorting wire is required for this procedure.

1. Set the HP 3457A to the 2-Wire Ohms Function, 30 Mohm range, set the offset compensation (OFFSET COMP) on, and the number of digits displayed (DIGITS DISP) to six.
2. Close channel 0. (Press the CHAN configuration key, enter the number 0 and press the ENT key).
3. Use the Test Record to record the offset readings for the 30 Mohm, 3 Mohm, 300 Kohm, 30 Kohm, 3 Kohm and 300 Ohm ranges.
4. Test the ohms offset on channels 0 through 9 with the instrument set to the 300 Ohm range. Record the reading of each channel on the Test Record provided at the end of this section.
5. If any of the offset readings are beyond the limits specified in Table 4-20 and on the Test Record, the instrument should be calibrated or repaired. Refer to Section V of this manual for calibration procedures.

3457A Input	3457A Range	3457A Set Up	Test limits
Short	300 ohm	OHM	004.2065 ohm
Short	3 Kohm	OHM	0.004210 Kohm
Short	30 Kohm	OHM	00.00430 Kohm
Short	300 Kohm	OHM	000.0053 Kohm
Short	3 Mohm	OHM	0.000021 Mohm
Short	30 Mohm	OHM	00.00086 Mohm

**Table 4-20. 2-Wire Ohms Offset Test Limits (44492A)**



#### 4-63. OPERATIONAL VERIFICATION TESTS

4-64. The Operational Verification Tests are an abbreviated version of the Performance Tests. The purpose of these tests is to provide a more rapid means of testing the performance of the HP 3457A. The Operational Verification Tests are designed to provide a 90% confidence that the instrument is operational and that it meets its specifications.

#### DC Voltage Operational Verification Tests

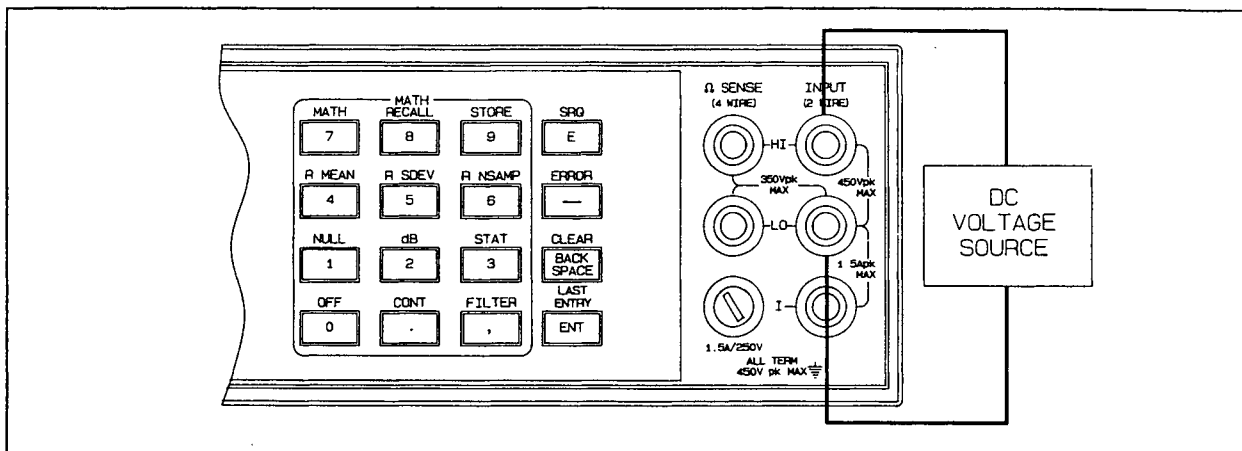

Figure 4-12. DCV Operational Verification Test Connections

#### NOTE

*The temperature of the environment where these tests are to be performed must be within  $\pm 5^\circ \text{C}$  of the temperature where the instrument was calibrated. The instrument was calibrated at the factory in an area with a temperature of  $20^\circ \text{C}$  ( $\pm 1^\circ \text{C}$ ).*

#### 4-65. Preliminary Steps

1. Turn the instrument ON and allow a one hour warm-up period.
2. Be certain all external inputs are disconnected from the HP 3457A. Run the TEST routine. The test result must read "SELF TEST OK". If the display shows "TEST FAILED", the instrument probably needs repair.
3. Run the AUTO CAL routine. (Press the AUTO CAL key, enter the number 1 and press the ENT key).

#### 4-66. DC Voltage Function - Offset Test

**4-67. Equipment Required.** A low thermal short (copper wire) is required for this procedure.

1. Connect a low thermal short across the Front Panel HI and LO Input Terminals.

## DC Voltage Operational Verification Tests Cont'd

2. Set the HP 3457A to the DC Voltage function (DCV) and the number of digits displayed (DIGITS DISP) to six.
3. Test the HP 3457A input offset on the 30 V, 3 V, and 300 mV ranges and record the reading of each range on the Test Record provided at the end of this section. Begin with the 30 V range to allow any thermal voltages which might affect the readings on the lower ranges to dissipate.
4. If any of the offset readings are beyond the limits specified in Table 4-21 and on the Test Record, the instrument should be calibrated. Refer to Section V of this manual for calibration procedures.
5. Remove the short from the Front Panel Input Terminals.

### 4-68. DC Voltage Function - Gain Test

**4-69. Equipment Required.** A set of low thermal cables and a DC Voltage Standard capable of providing 300 mV ( $\pm .0012\%$ ), 3 V ( $\pm .0006\%$ ) and 30 V ( $\pm .0013\%$ ) is required for this test.

1. Set the output of the DC Voltage Standard to 300 mV and connect it to the HP 3457A front panel HI and LO Input Terminals.
2. Use the Test Record to record the full-scale readings for the 300 mV, 3 V, and 30 V ranges. Begin with the 30 V range.
3. If any of the full-scale readings are beyond the limits specified in Table 4-21 and on the Test Record, the instrument should be calibrated. Refer to Section V of this manual for calibration procedures.
4. Reduce the output of the Voltage Standard to 0 volts and disconnect it from the HP 3457A.

3457A Input	3457A Range	3457A Set Up	90 day limits		1 year limits	
			High	Low	High	Low
Short	30 V	DCV	+ 00.00020 V	- 00.00020 V	+ 00.00020 V	- 00.00020 V
Short	3 V	DCV	+ 0.000007 V	- 0.000007 V	+ 0.000007 V	- 0.000007 V
Short	300 mV	DCV	+000.0040 mV	-000.0040 mV	+000.0040 mV	-000.0040 mV
300 mV	300 mV	DCV	+300.0115 mV	+299.9885 mV	+300.0145 mV	+299.9855 mV
3 V	3 V	DCV	+ 3.000058 V	+ 2.999942 V	+ 3.000082 V	+ 2.999918 V
30 V	30 V	DCV	+ 30.00125 V	+ 29.99875 V	+ 30.00140 V	+ 29.99860 V

**Table 4-21. DC Voltage Test Limits**

## AC Voltage Operational Verification Tests

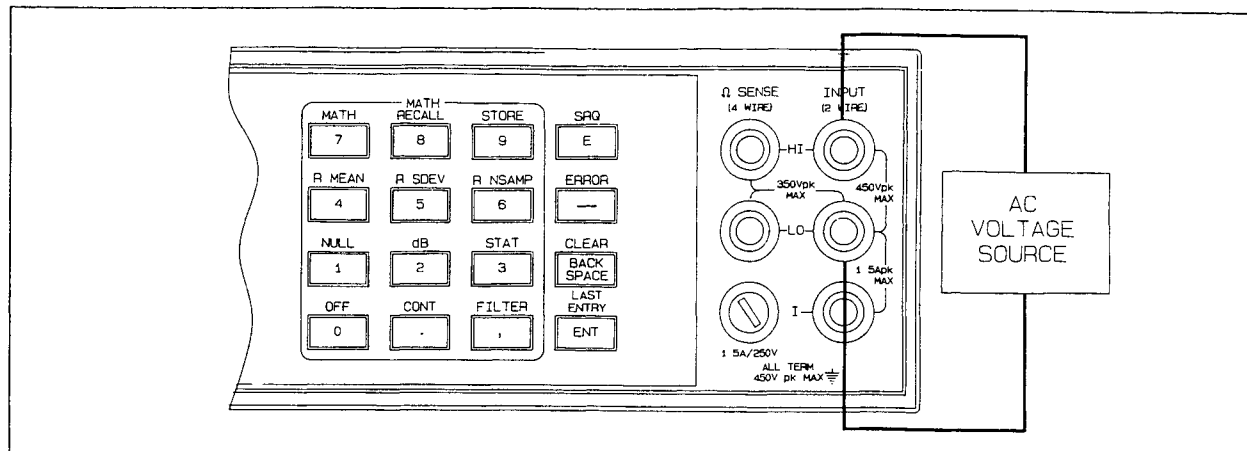

Figure 4-13. ACV Operational Verification Test Connections

## 4-70. AC Voltage Function - Gain Test

**4-71. Equipment Required.** An AC Signal Source capable of providing sine-wave voltages of 300 mV, 3 V, and 30 V ( $\pm 0.05\%$ ) at a frequency of 1 KHz is required for the following procedure.

1. Set the HP 3457A to the AC Voltage function (ACV).
2. Connect the AC Signal Source to the HP 3457A front panel HI and LO input terminals. Set the Signal Source for an output voltage of 30 V at a frequency of 1 KHz.
3. Use the Test Record to record the 300 mV, 3 V and 30 V full-scale readings beginning with the 30 V range.
4. If any of the gain readings are beyond the limits specified in Table 4-22 and on the Test Record, the instrument should be calibrated or repaired. Refer to Section V for calibration procedures.

3457A Input	Input Freq.	3457A Range	3457A Set Up	90 day limits	
				High	Low
300 mV	1 kHz	300 mV	ACV	300.5020 mV	299.4980 mV
3 V	1 kHz	3 V	ACV	3.005100 V	2.994900 V
30 V	1 kHz	30 V	ACV	30.05020 V	29.94980 V

Table 4-22. AC Gain Test Limits

## 4-72. AC Voltage Function - Frequency Response Test

**4-73. Equipment Required.** An AC Signal Source capable of providing sine-wave voltages of 300 mV and 3 V ( $\pm 2\%$ ) at 20 KHz, 300 mV and 3 V ( $\pm 1\%$ ) at 100 Hz and 300 mV and 3 V ( $\pm 3\%$ ) at 20 Hz is required for this test.

1. Connect the AC Signal Source to the HP 3457A front panel HI and LO input terminals. Set the AC Voltage Standard for an output voltage of 300 mV at a frequency of 20 KHz.

### AC Voltage Operational Verification Tests Cont'd

2. Set the HP 3457A to the AC Voltage function (ACV), the range to 3 V and the AC Bandwidth to AC Fast. (To change the Bandwidth - Press the SHIFT key, then the NPLC / A configuration key. Use the ↓ scroll key to display ACBAND. Enter a number greater than 400 and press the ENT key).
3. Use the Test Record to record the 3 V 1/10 full-scale reading at 20 KHz.
4. Set the AC Voltage Standard for an output of 3 V at 20 KHz. Use the Test Record to record the 3 V, 20 KHz full-scale reading.
5. Set the HP 3457A AC Bandwidth to AC Slow. (Press the Blue SHIFT key then the NPLC / A configuration key. Use the ↓ scroll key to display ACBAND. Enter a number smaller than 400 and press the ENT key).
6. Set the AC Voltage Standard for an output of 3 V at 100 Hz. Use the Test Record to record the 3 V, 100 Hz full-scale reading.
7. Set the AC Voltage Standard for an output of 3 V at 20 Hz. Use the Test Record to record the 3 V, 20 Hz full-scale reading.
8. If any of the readings are beyond the limits specified in Table 4-23 and on the Test Record, the instrument should be calibrated or repaired. Refer to Section V for calibration procedures.

3457A Input	Input Freq.	3457A Range	3457A Set Up	90 day limits	
				High	Low
300 mV	20 kHz	3 V	ACF	0.301510 V	0.298490 V
3 V	20 kHz	3 V	ACF	3.005320 V	2.994680 V
3 V	100 Hz	3 V	ACS	3.007420 V	2.992580 V
3 V	20 Hz	3 V	ACS	3.017920 V	2.982080 V

Table 4-23. AC Frequency Response Test Limits

### DC Current Operational Verification Tests

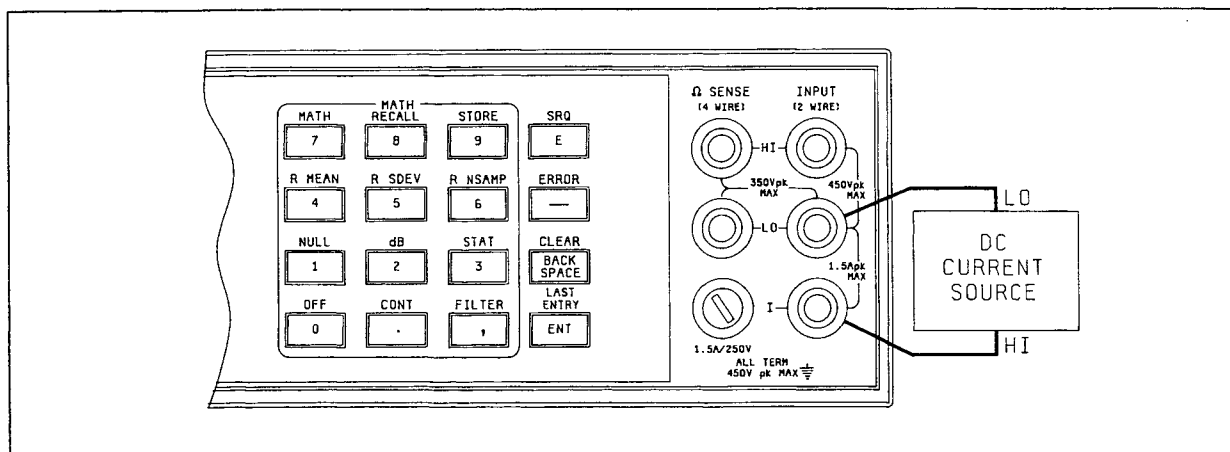

Figure 4-14. DCI Operational Verification Test Connections

## DC Current Operational Verification Tests Cont'd

3457A Input	3457A Range	3457A Set Up	90 day limits		1 year limits	
			High	Low	High	Low
Open	3 mA	DCI	+0.000104 mA	-0.000104 mA	+0.000104 mA	-0.000104 mA
Open	1 A	DCI	+00.00604 mA	-00.00604 mA	+00.00604 mA	-00.00604 mA
3 mA	3 mA	DCI	3.000704 mA	2.999296 mA	3.001304 mA	2.998696 mA
300 mA	1 A	DCI	0.300814 A	0.299186 A	0.300844 A	0.299156 A

Table 4-24. DC Current Test Limits

**4-74. DC Current Function - Offset Test**

**4-75. Equipment Required.** This procedure does not require any test equipment.

1. Set the HP 3457A to the DC Current function (DCI), 3 mA range, and the number of digits displayed (DIGITS DISP) to six.
2. Use the Test Record to record the current offset readings on the 3 mA and 1 A ranges.
3. If either of the offset readings are beyond the limits specified in Table 4-24 and on the Test Record, the instrument should be calibrated or repaired. Refer to Section V for calibration procedures.

**4-76. DC Current Function - Gain Test**

**4-77. Equipment Required.** A DC Current Source capable of providing currents of 3 mA and 300 mA ( $\pm .007\%$ ) is required for the following procedure.

1. Set the DC Current Source for an output of 0 mA and connect it to the HP 3457A front panel I and L0 input terminals.
2. Set the HP 3457A to the 3 mA range and the number of digits displayed (DIGITS DISP) to six. Set the DC Current Source to 3 mA.
3. Use the Test Record to record the 3 mA full-scale current reading.
4. Set the HP 3457A to the 1 A range and set the DC Current Source for an output of 300 mA.
5. Use the Test Record to record the 300 mA reading.
6. If either of the readings are beyond the limits specified in Table 4-24 and on the Test Record, the instrument should be calibrated or repaired. Refer to Section V for calibration procedures.
7. Set the output of the DC Current Source to 0 and disconnect it from the HP 3457A input terminals.

## AC Current Operational Verification Tests

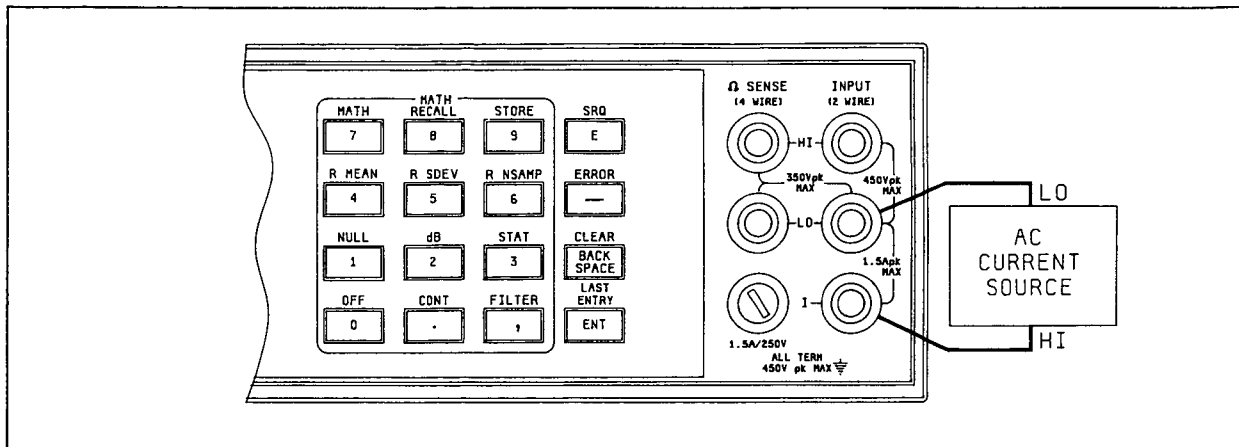

Figure 4-15. ACI Operational Verification Test Connections

### 4-78. AC Current Function - Gain Test

**4-79. Equipment Required,** An AC Current Source capable of providing a current of 300 mA ( $\pm .1\%$ ) at a frequency of 1 KHz is required for the following test.

1. Set the AC Current source for an output of 0 mA and connect it to the HP 3457A front panel I and LO input terminals.
2. Set the HP 3457A to the 300 mA range and the number of digits displayed (DIGITS DISP) to six. Set the AC Current Source for an output of 300 mA at a frequency of 1 KHz.
3. Use the Test Record to record the 300 mA full-scale reading.
4. If the full-scale reading is beyond the limits specified on the Test Record (301.0300 mA - 298.9700 mA), the instrument should be calibrated or repaired. Refer to Section V for calibration procedures.
5. Reduce the output of the AC Current Source to 0 and disconnect it from the HP 3457A input terminals.

## 2-Wire Ohms Operational Verification Tests

### 4-80. 2-Wire Ohms Function - Offset Test

**4-81. Equipment Required.** A low thermal short (copper wire) is required for this procedure.

1. Connect a low thermal short across the HP 3457A front panel HI and LO input terminals.
2. Set the HP 3457A to the 2-Wire Ohms Function, 3 Kohm range and the number of digits displayed (DIGITS DISP) to six.
3. Use the Test Record to record the offset readings for the 3 Kohm, 30 Kohm and 300 Kohm ranges.

## 2-Wire Ohms Operational Verification Tests Cont'd

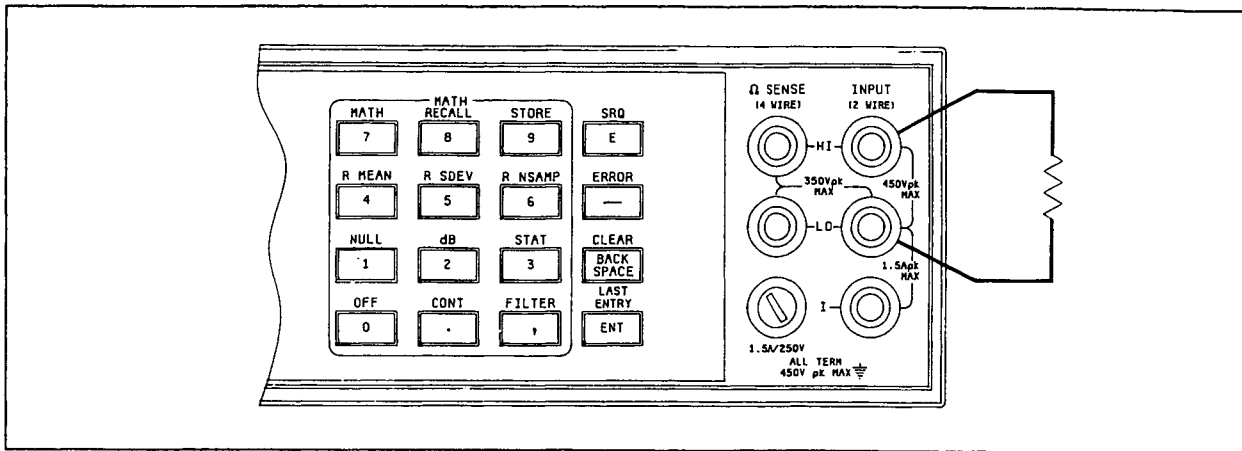

Figure 4-16. 2-Wire Ohms Operational Verification Test Connections

4. If any of the offset readings are beyond the limits specified in Table 4-25 and on the Test Record, the instrument should be calibrated. Refer to Section V of this manual for calibration procedures.
5. Remove the short from the front panel input terminals.

3457A Input	3457A Range	3457A Set Up	90 day limits	1 year limits
Short	3 Kohm	OHM	0.000207 Kohm	0.000207 Kohm
Short	30 Kohm	OHM	00.00027 Kohm	00.00027 Kohm
Short	300 Kohm	OHM	000.0010 Kohm	000.0010 Kohm

Table 4-25. 2-Wire Ohms Offset Test Limits

## 4-82. 2-Wire Ohms Function - Gain Test

**4-83. Equipment Required.** Resistance Standards of 3 Kohms ( $\pm .001\%$ ), 30 Kohms ( $\pm .001\%$ ), and 300 Kohms ( $\pm .001\%$ ) are required for this procedure.

1. Set the HP 3457A to the 2-wire ohms function (OHM) and the number of digits displayed (DIGITS DISP) to six.
2. Connect the Resistance Standard to the HP 3457A front panel HI and LO input terminals. (The connecting wires should be as short as possible to reduce lead resistance).
3. Use the Test Record to record the 3 Kohm, 30 Kohm and 300 Kohm full-scale readings.
4. If any of the readings are beyond the limits specified in Table 4-26 and on the Test Record, the instrument should be calibrated. Refer to Section V of this manual for calibration procedures.
5. Remove the Resistance standard from the HP 3457A front panel input terminals.

## 2-Wire Ohms Operational Verification Tests Cont'd

3457A Input	3457A Range	3457A Set Up	90 day limits		1 year limits	
			High	Low	High	Low
3 Kohm	3 Kohm	OHM	3.000312 Kohm	2.999688 Kohm	3.000357 Kohm	2.999643 Kohm
30 Kohm	30 Kohm	OHM	30.00132 Kohm	29.99868 Kohm	30.00177 Kohm	29.99823 Kohm
300 Kohm	300 Kohm	OHM	300.0130 Kohm	299.9870 Kohm	300.0160 Kohm	299.9840 Kohm

Table 4-26. 2-Wire Ohms Gain Test Limits

## 4-Wire Ohms Operational Verification Tests

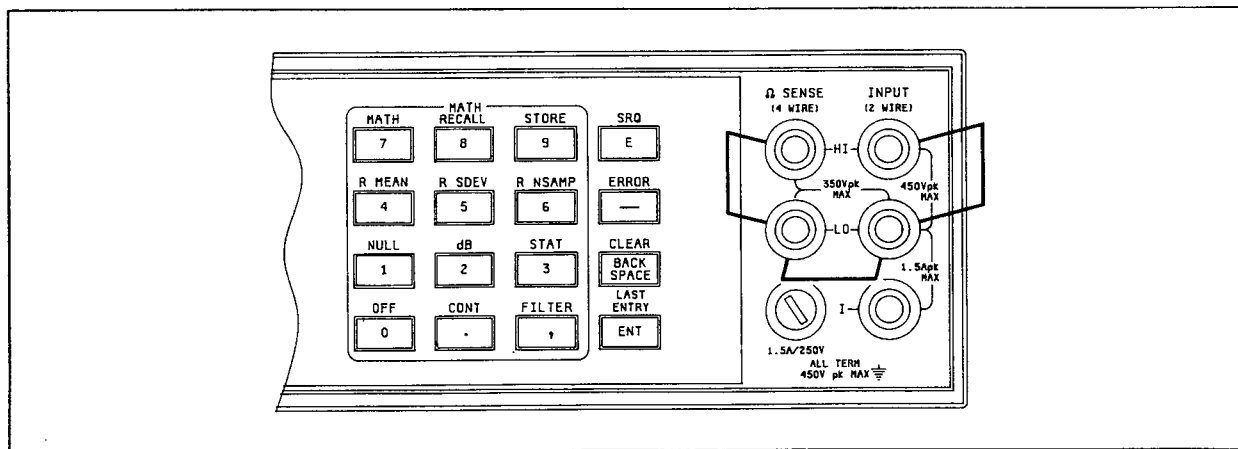

Figure 4-17. 4-Wire Ohms Operational Verification Test Connections

## 4-84. 4-Wire Ohms Function - Offset Test

**4-85. Equipment Required.** A low thermal short (copper wire) is required for this procedure.

1. Set the HP 3457A to the 4-Wire Ohms Function (OHMF) and the number of digits displayed (DIGITS DISP) to six.
2. Short the front panel input terminals of the HP 3457A as shown in Figure 4-17.
3. Use the Test Record to record the offset readings of the 3 Kohm, 30 Kohm and 300 Kohm ranges.
4. If any of the offset readings are beyond the limits specified in Table 4-27 and on the Test Record, the instrument should be calibrated. Refer to Section V of this manual for calibration procedures.
5. Remove the short from the front panel input terminals.



## 4-Wire Ohms Operational Verification Tests Cont'd

3457A Input	3457A Range	3457A Set Up	90 day limits	1 year limits
Short	3 Kohm	OHMF	0.000007 Kohm	0.000007 Kohm
Short	30 Kohm	OHMF	00.00007 Kohm	00.00007 Kohm
Short	300 Kohm	OHMF	000.0008 Kohm	000.0008 Kohm

Table 4-27. 4-Wire Ohms Offset Test Limits

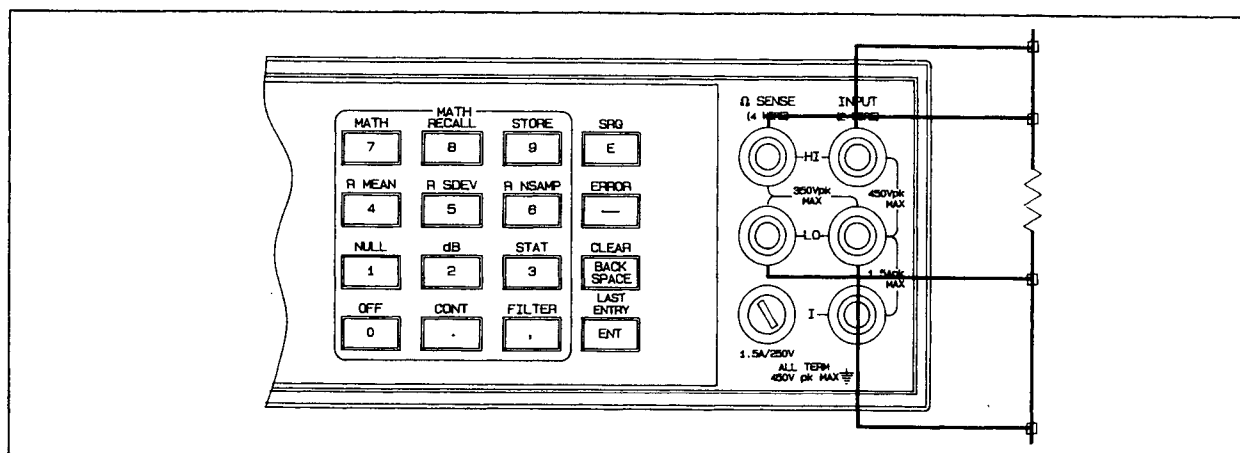

Figure 4-18. 4-Wire Ohms Operational Verification Test Connections

## 4-86. 4-Wire Ohms Function - Gain Test

**4-87. Equipment Required.** Resistance Standards of 3 Kohms ( $\pm .001\%$ ), 30 Kohms ( $\pm .001\%$ ) and 300 Kohms ( $\pm .001\%$ ) are required for this procedure.

1. Set the HP 3457A to the 4-Wire ohms function (OHMF) and the number of digits displayed (DIGITS DISP) to six.
2. Connect the appropriate Resistance Standard to the HP 3457A front panel input terminals as shown in Figure 4-18.
3. Use the Test Record to record the resistance readings for the 3 Kohm, 30 Kohm and 300 Kohm ranges.
4. If any of the readings are beyond the limits specified in Table 4-28 and on the Test Record, the instrument should be calibrated. Refer to Section V of this manual for calibration procedures.
5. Remove the Resistance Standard from the HP 3457A front panel input terminals.

**4-Wire Ohms Operational Verification Tests Cont'd**

3457A Input	3457A Range	3457A Set Up	90 day limits		1 year limits	
			High	Low	High	Low
3 Kohm	3 Kohm	OHMF	3.000112 Kohm	2.999888 Kohm	3.000157 Kohm	2.999843 Kohm
30 Kohm	30 Kohm	OHMF	30.00112 Kohm	29.99888 Kohm	30.00157 Kohm	29.99844 Kohm
300 Kohm	300 Kohm	OHMF	300.0128 Kohm	299.9872 Kohm	300.0158 Kohm	299.9842 Kohm

**Table 4-28. 4-Wire Ohms Gain Test Limits**

**Frequency Counter Operational Verification Tests**

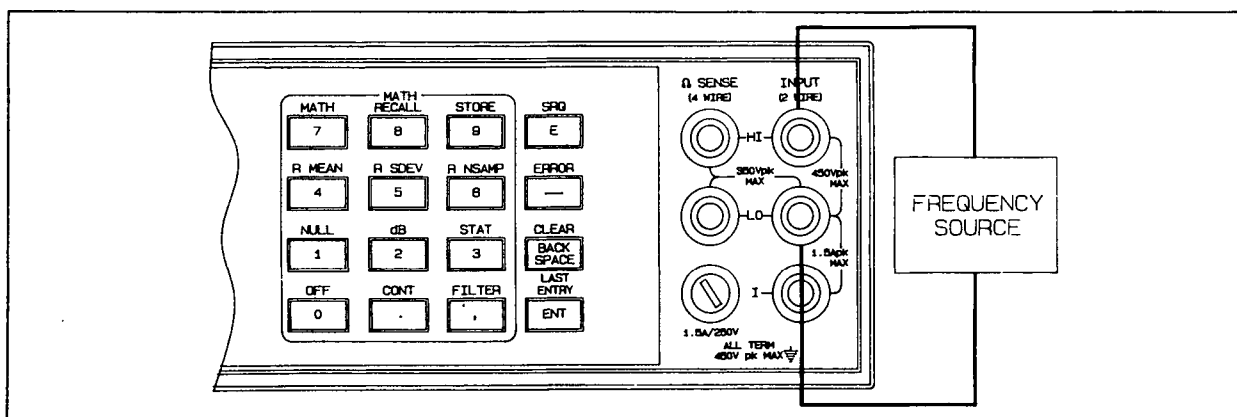

**Figure 4-19. Frequency Counter Operational Verification Test Connections**

**4-88. Frequency Counter - Accuracy Test**

**4-89. Equipment Required.** A Frequency Source capable of providing a 20 Hz ( $\pm .01\%$ ) and a 1 MHz ( $\pm .003\%$ ) sine-wave signal is required for this procedure.

1. Set the HP 3457A to the Frequency Function (FREQ).
2. Set the Frequency Standard for a 1 volt, 20 Hz sine-wave output signal and connect it to the HI and LO input terminals of the HP 3457A.
3. Use the Test Record to record the frequency readings at 20 Hz and 1 MHz.
4. If either of the readings are beyond the limits specified, the instrument should be calibrated. Refer to Section V of this manual for calibration procedures.

### Rear Input Operational Verification Tests (Standard Instrument)

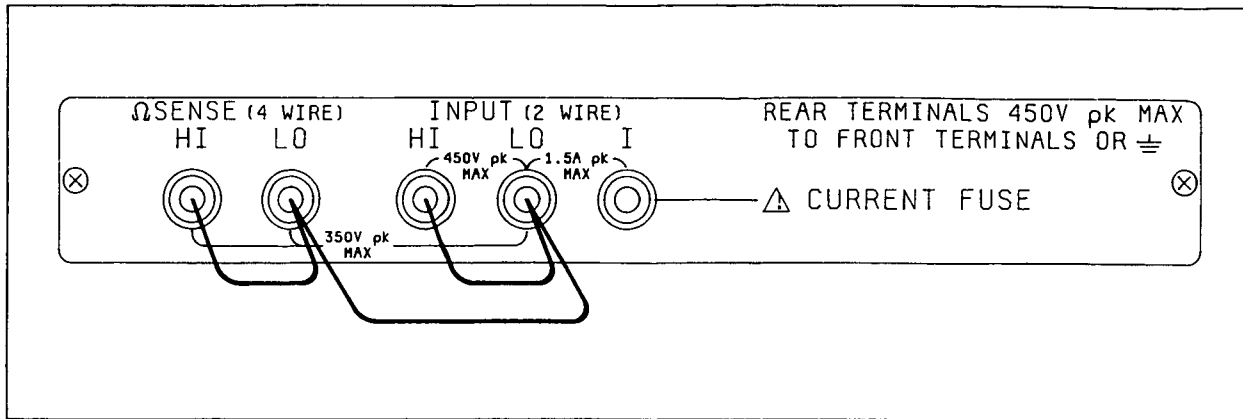

Figure 4-20. Standard Instrument Rear Input Test Connections

#### 4-90. Preliminary Steps

1. Short the Rear Input HI and LO terminals and the  $\Omega$  Sense HI and LO terminals as shown in Figure 4-9.
2. Select the Rear Terminal Input. (Press the TERM configuration key, enter the number 2 and press the ENT key.)

#### 4-91. DC Voltage Function - Rear Terminal Offset Test

**4-92. Equipment Required.** A low thermal short (copper wire) is required for this procedure.

1. Set the HP 3457A to the DC Voltage function (DCV) and the number of digits displayed (DIGITS DISP) to six.
2. Test the HP 3457A input offset on the 30 V, 3 V and 300 mV ranges and record the reading of each range on the Test Record provided at the end of this section. Begin with the 30 V range to allow any thermal voltages which might affect the readings on the lower ranges to dissipate.
3. If any of the offset readings are beyond the limits specified in Table 4-29 and on the Test Record, the instrument should be calibrated. Refer to Section V of this manual for calibration procedures.

3457A Input	3457A Range	3457A Set Up	90 day limits		1 year limits	
			High	Low	High	Low
Short	30 V	DCV	+ 00.00020 V	- 00.00020 V	+ 00.00020 V	- 00.00020 V
Short	3 V	DCV	+ 0.000007 V	- 0.000007 V	+ 0.000007 V	- 0.000007 V
Short	300 mV	DCV	+000.0040 mV	-000.0040 mV	+000.0040 mV	-000.0040 mV

Table 4-29. DC Voltage Offset Test Limits (Rear Terminals)

## Rear Input Operational Verification Tests (Standard Instrument) Cont'd

### 4-93. DC Current Function - Rear Terminal Offset Test

**4-94. Equipment Required.** This procedure does not require any test equipment.

1. Set the HP 3457A to the DC Current function (DCI), 3 mA range, and the number of digits displayed (DIGITS DISP) to six.
2. Use the Test Record to record the current offset readings on the 3 mA and 1 A ranges.
3. If any of the offset readings are beyond the limits specified in Table 4-30 and on the Test Record, the instrument should be calibrated. Refer to Section V of this manual for calibration procedures.

3457A Input	3457A Range	3457A Set Up	90 day limits		1 year limits	
			High	Low	High	Low
Open	3 mA	DCI	+0.000104 mA	-0.000104 mA	+0.000104 mA	-0.000104 mA
Open	30 mA	DCI	+00.00104 mA	-00.00104 mA	+00.00104 mA	-00.00104 mA

**Table 4-30. DC Current Offset Test Limits (Rear Terminals)**

### 4-95. 2-Wire Ohms Function - Rear Terminal Offset Test

**4-96. Equipment Required.** A low thermal short (copper wire) is required for this procedure.

1. Set the HP 3457A to the 2-Wire Ohms Function, 3 Kohm range and the number of digits displayed (DIGITS DISP) to six.
2. Use the Test Record to record the offset readings for the 3 Kohm, 30 Kohm and 300 Kohm ranges.
3. If any of the offset readings are beyond the limits specified in Table 4-31 and on the Test Record, the instrument should be calibrated. Refer to Section V of this manual for calibration procedures.

3457A Input	3457A Range	3457A Set Up	90 day limits	1 year limits
Short	3 Kohm	OHM	0.000207 Kohm	0.000207 Kohm
Short	30 Kohm	OHM	00.00027 Kohm	00.00027 Kohm
Short	300 Kohm	OHM	000.0010 Kohm	000.0010 Kohm

**Table 4-31. 2-Wire Ohms Offset Test Limits (Rear Terminals)**

### 4-97. 4-Wire Ohms Function - Offset Test

**4-98. Equipment Required.** A low thermal short (copper wire) is required for this procedure.

1. Set the HP 3457A to the 4-Wire Ohms Function (OHMF) and the number of digits displayed (DIGITS DISP) to six.

### Rear Input Operational Verification Tests (Standard Instrument) Cont'd

- Use the Test Record to record the offset readings of the 3 Kohm, 30 Kohm and 300 Kohm ranges.
- If any of the offset readings are beyond the limits specified in Table 4-32 and on the Test Record, the instrument should be calibrated. Refer to Section V of this manual for calibration procedures.

3457A Input	3457A Range	3457A Set Up	90 day limits	1 year limits
Short	3 Kohm	OHMF	0.000007 Kohm	0.000007 Kohm
Short	30 Kohm	OHMF	00.000007 Kohm	00.000007 Kohm
Short	300 Kohm	OHMF	000.0008 Kohm	000.0008 Kohm

Table 4-32. 4-Wire Ohms Offset Test Limits (Rear Terminals)

### Rear Input Operational Verification Tests (44491A General Purpose Relay Assy)

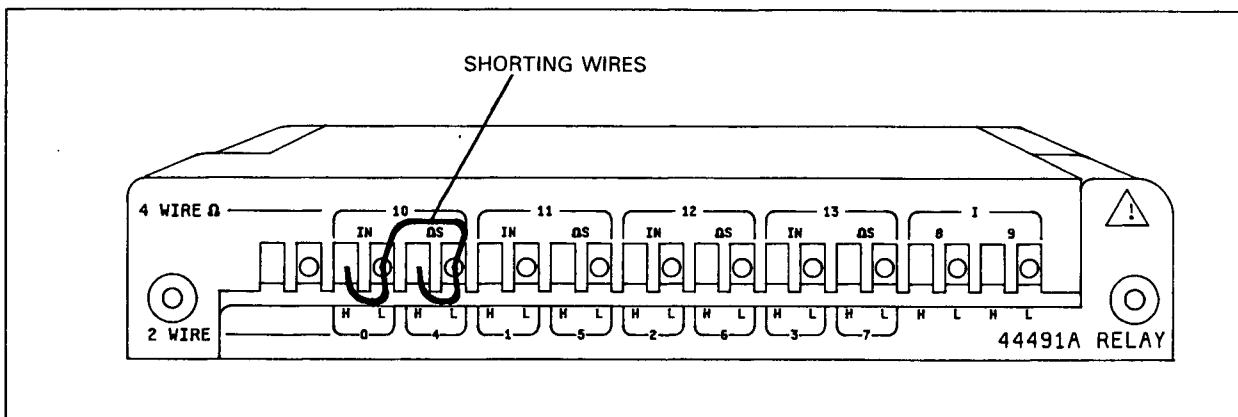

Figure 4-21. HP 44491A Terminal Block Assembly Connections

#### 4-99. Preliminary Steps

- Connect shorting wires to the channel 10 inputs of the Terminal Block assembly as shown in Figure 4-21.
- Select the Scanner Input. (Press the TERM configuration key, enter the number 2 and press the ENT key).

#### NOTE

*The 44491A Relay Assembly and the 3457A Multimeter must have been calibrated as a unit for these tests to apply. Calibration procedures are provided in Section V of this manual.*

## Rear Input Operational Verification Tests (44491A General Purpose Relay Assy)

### 4-100. DC Voltage Function - 44491A Offset Test

**4-101. Equipment Required.** Low thermal (copper) shorting wires are required for this procedure.

1. Set the HP 3457A to the DC Voltage function (DCV) and the number of digits displayed (DIGITS DISP) to six.
2. Close channel 0. (Press the CHAN configuration key, enter the number 0 and press the ENT key).
3. Test the HP 3457A input offset on the 30 V, 3 V and 300 mV ranges and record the reading of each range on the Test Record provided at the end of this section. Begin with the 30 V range to allow any thermal voltages which might affect the readings on the lower ranges to dissipate.
4. If any of the offset readings are beyond the limits specified in Table 4-33 and on the Test Record, the instrument should be calibrated or repaired. Refer to Section V for calibration procedures.

3457A Input	3457A Range	3457A Set Up	Test Limits	
			High	Low
Short	30 V	DCV	+ 00.00020 V	- 00.00020 V
Short	3 V	DCV	+ 0.000010 V	- 0.000010 V
Short	300 mV	DCV	+000.0070 mV	-000.0070 mV

**Table 4-33. DC Voltage Offset Test Limits (44491A)**

### 4-102. 2-Wire Ohms Function - 44491A Offset Test Limits

**4-103. Equipment Required.** Low thermal (copper) shorting wires are required for this procedure.

1. Set the HP 3457A to the 2-Wire Ohms Function, 3 Kohm range. Set the offset compensation (OFFSET COMP) on, and the number of digits displayed (DIGITS DISP) to six.
2. Close channel 0. (Press the CHAN configuration key, enter the number 0 and press the ENT key).
3. Use the Test Record to record the offset reading for the 3 Kohm range.
4. Test the ohms offset on channels 0 through 7 with the instrument set to the 3 Kohm range. Record the reading of each channel on the Test Record provided at the end of this section.
5. If any of the offset readings are beyond  $\pm 0.002207$  KOhms, the instrument should be calibrated or repaired. Refer to Section V for calibration procedures.

### 4-104. 4-Wire Ohms Function - 44491A Offset Test Limits

**4-105. Equipment Required.** Low thermal (copper) shorting wires are required for this procedure.

1. Set the HP 3457A to the 4-Wire Ohms Function (OHMF). Set the offset compensation (OFFSET COMP) on, and the number of digits displayed (DIGITS DISP) to six.

### Rear Input Operational Verification Tests (44491A General Purpose Relay Assy)

2. Close channel 10. (Press the CHAN configuration key, enter the number 10 and press the ENT key).
3. Use the Test Record to record the offset reading of the 3 Kohm range.
4. If any of the offset reading is beyond  $\pm 0.000010$  KOhm, the instrument should be calibrated or repaired. Refer to Section V for calibration procedures.

#### 4-106. DC Current Function - 44491A Offset Test Limits

**4-107. Equipment Required.** This procedure does not require any test equipment.

1. Set the HP 3457A to the DC Current function (DCI), 3 mA range, and the number of digits displayed (DIGITS DISP) to six.
2. Use the Test Record to record the current offset readings on the 3 mA and 1 A ranges.
3. If either of the offset readings are beyond the limits specified in Table 4-34 and on the Test Record, the instrument should be calibrated or repaired. Refer to Section V for calibration procedures.

3457A Input	3457A Range	3457A Set Up	Test Limits	
			High	Low
Open	3 mA	DCI	+0.000104 mA	-0.000104 mA
Open	30 mA	DCI	+00.00104 mA	-00.00104 mA

Table 4-34. DC Current Offset Test Limits (44491A)

### Rear Input Operational Verification Tests (44492A 10 Channel Multiplex Assy)

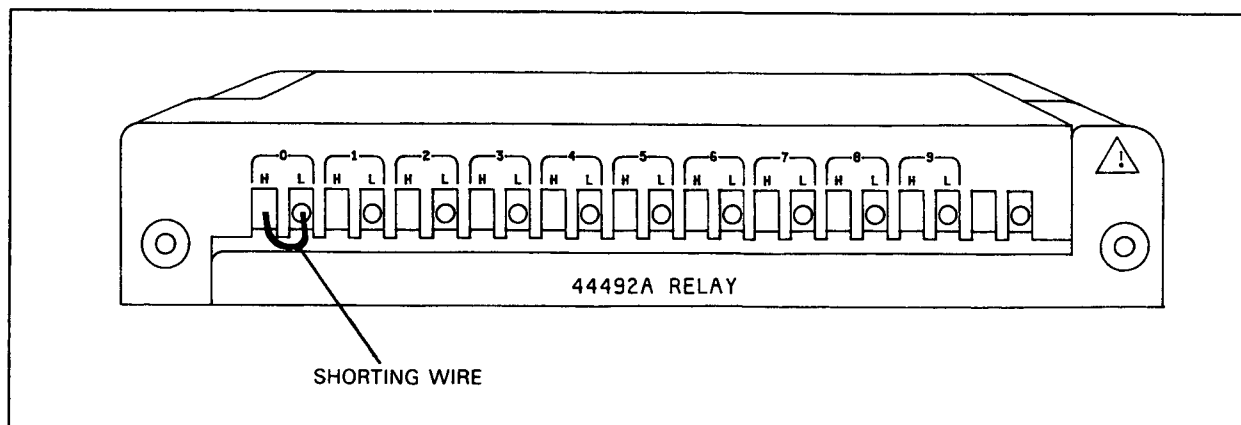

Figure 4-22. HP 44492A Terminal Block Assembly Connections

## Rear Input Operational Verification Tests (44492A 10 Channel Multiplex Assy)

### 4-108. Preliminary Steps

1. Connect a shorting wire to the channel 0 inputs of the Terminal Block assembly as shown in Figure 4-22.
2. Select the Scanner Input. (Press the TERM configuration key, enter the number 2 and press the ENT key).

#### NOTE

*The 44492A Multiplexer Assembly and the 3457A Multimeter must have been calibrated as a unit for these tests to apply. Calibration procedures are provided in Section V of this manual.*

### 4-109. DC Voltage Function - 44492A Offset Test

**4-110. Equipment Required.** A low thermal (copper) shorting wire is required for this procedure.

1. Set the HP 3457A to the DC Voltage function (DCV) and the number of digits displayed (DIGITS DISP) to six.
2. Close channel 0. (Press the CHAN configuration key, enter the number 0 and press the ENT key).
3. Test the HP 3457A input offset on the 300 mV range and record the reading on the Test Record provided at the end of this section.
4. If the offset reading is beyond  $\pm 000.0070$  mV, the instrument should be calibrated or repaired. Refer to Section V for calibration procedures.

### 4-111. 2-Wire Ohms Function - 44492A Offset Test Limits

**4-112. Equipment Required.** A low thermal (copper) shorting wire is required for this procedure.

1. Set the HP 3457A to the 2-Wire Ohms Function, 3 Kohm range. Set the offset compensation (OFFSET COMP) on, and the number of digits displayed (DIGITS DISP) to six.
  2. Close channel 0. (Press the CHAN configuration key, enter the number 0 and press the ENT key).
  3. Use the Test Record to record the offset reading for the 3 Kohm range.
  4. Test the ohms offset on channels 0 through 9 with the instrument set to the 3 Kohm range. Record the reading of each channel on the Test Record provided at the end of this section.
  5. If any of the offset readings are beyond  $\pm 0.004210$  KOhm, the instrument should be calibrated or repaired. Refer to Section V for calibration procedures.
-



# PERFORMANCE TEST CARD 90 DAY LIMITS

Hewlett-Packard Model 3457A  
Digital Multimeter  
Serial Number \_\_\_\_\_

Test Performed by \_\_\_\_\_  
Date \_\_\_\_\_  
Reference Temperature \_\_\_\_\_

## DC VOLTAGE TEST

Step#	Input to 3457A	Set-Up and Configuration	High Limit	Reading	Low Limit	Test Pass	Test Fail
<b>OFFSET TEST</b>							
1	Short	300 V Range	+ 000.0007 V	_____	- 000.0007 V	_____	_____
2	Short	30 V Range	+ 00.00020 V	_____	- 00.00020 V	_____	_____
3	Short	3 V Range	+ 0.000007 V	_____	- 0.000007 V	_____	_____
4	Short	300 mV Range	+ 000.0040 mV	_____	- 000.0040 mV	_____	_____
5	Short	30 mV Range	+ 00.00385 mV	_____	- 00.00385 mV	_____	_____
<b>GAIN TEST</b>							
6	30 mV	30 mV Range	+ 30.00505 mV	_____	+ 29.99495 mV	_____	_____
7	300 mV	300 mV Range	+ 300.0115 mV	_____	+ 299.9885 mV	_____	_____
8	3 V	3 V Range	+ 3.000058 V	_____	+ 2.999942 V	_____	_____
9	30 V	30 V Range	+ 30.00125 V	_____	+ 29.99875 V	_____	_____
10	300 V	300 V Range	+ 300.0157 V	_____	+ 299.9843 V	_____	_____
<b>LINEARITY TEST</b>							
11	3 V	3 V Range	+ 3.000058 V	_____	+ 2.999942 V	_____	_____
12	2 V	3 V Range	+ 2.000041 V	_____	+ 1.999959 V	_____	_____
13	1 V	3 V Range	+ 1.000024 V	_____	+ 0.999976 V	_____	_____
14	- 1 V	3 V Range	- 0.999976 V	_____	- 1.000024 V	_____	_____
15	- 2 V	3 V Range	- 1.999959 V	_____	- 2.000041 V	_____	_____
16	- 3 V	3 V Range	- 2.999942 V	_____	- 3.000058 V	_____	_____

# PERFORMANCE TEST CARD 90 DAY LIMITS

Hewlett-Packard Model 3457A  
Digital Multimeter  
Serial Number \_\_\_\_\_

Test Performed by \_\_\_\_\_  
Date \_\_\_\_\_  
Reference Temperature \_\_\_\_\_

## AC VOLTAGE TEST

Step#	Input to 3457A	Set-Up and Configuration	High Limit	Reading	Low Limit	Test Pass	Test Fail
1	Set the 3457A to the AC Voltage Function and run the AUTO-CAL 2 routine.						
GAIN TEST							
2	30mV, 1KHz	30 mVAC Range	30.05020 mV	_____	29.94980 mV	_____	_____
3	300mV, 1KHz	300 mVAC Range	300.5020 mV	_____	299.4980 mV	_____	_____
4	1V, 1KHz	3 VAC Range	1.002420 V	_____	0.997580 V	_____	_____
5	2V, 1KHz	3 VAC Range	2.003720 V	_____	1.996280 V	_____	_____
6	3V, 1KHz	3 VAC Range	3.005100 V	_____	2.994900 V	_____	_____
7	30V, 1KHz	30 VAC Range	30.05020 V	_____	29.94980 V	_____	_____
8	300V, 1KHz	300 VAC Range	300.6820 V	_____	299.3180 V	_____	_____
9	30V, 1KHz	300 VAC Range	030.1690 V	_____	029.8310 V	_____	_____
10	3V, 1KHz	30 VAC Range	03.01510 V	_____	02.98490 V	_____	_____
11	300mV, 1KHz	3 VAC Range	0.301510 V	_____	0.298490 V	_____	_____
12	30mV, 1KHz	300 mVAC Range	030.1510 mV	_____	029.8490 mV	_____	_____
13	Set the 3457A to AC Fast Response (ACBAND > 400)						
FREQUENCY RESPONSE TEST							
14	30mV, 1MHz	300 mVAC Range	039.6880 mV	_____	020.3120 mV	_____	_____
15	30mV, 300KHz	300 mVAC Range	031.9180 mV	_____	028.0820 mV	_____	_____
16	30mV, 100KHz	300 mVAC Range	030.4080 mV	_____	029.5920 mV	_____	_____
17	30mV, 20KHz	300 mVAC Range	030.1510 mV	_____	029.8490 mV	_____	_____
18	30mV, 6.5KHz	300 mVAC Range	030.1510 mV	_____	029.8490 mV	_____	_____
19	30mV, 400Hz	300 mVAC Range	030.1510 mV	_____	029.8490 mV	_____	_____

## PERFORMANCE TEST CARD 90 DAY LIMITS

Hewlett-Packard Model 3457A  
Digital Multimeter  
Serial Number \_\_\_\_\_

Test Performed by \_\_\_\_\_  
Date \_\_\_\_\_  
Reference Temperature \_\_\_\_\_

### AC VOLTAGE TEST (Cont'd)

Step#	Input to 3457A	Set-Up and Configuration	High Limit	Reading	Low Limit	Test Pass	Test Fail
-------	-------------------	-----------------------------	---------------	---------	--------------	--------------	--------------

### FREQUENCY RESPONSE TEST (Cont'd)

20	300mV, 1MHz	300 mVAC Range	337.1200 mV	_____	262.8800 mV	_____	_____
21	300mV, 300KHz	300 mVAC Range	310.4500 mV	_____	289.5500 mV	_____	_____
22	300mV, 100KHz	300 mVAC Range	302.1900 mV	_____	297.8100 mV	_____	_____
23	300mV, 20KHz	300 mVAC Range	300.5320 mV	_____	299.4680 mV	_____	_____
24	300mV, 6.5KHz	300 mVAC Range	300.5320 mV	_____	299.4680 mV	_____	_____
25	300mV, 400Hz	300 mVAC Range	300.5320 mV	_____	299.4680 mV	_____	_____
26	300mV, 1MHz	3 VAC Range	0.396880 V	_____	0.203120 V	_____	_____
27	300mV, 300KHz	3 VAC Range	0.319180 V	_____	0.280820 V	_____	_____
28	300mV, 100KHz	3 VAC Range	0.304080 V	_____	0.295920 V	_____	_____
29	300mV, 20KHz	3 VAC Range	0.301510 V	_____	0.298490 V	_____	_____
30	300mV, 6.5KHz	3 VAC Range	0.301510 V	_____	0.298490 V	_____	_____
31	300mV, 400Hz	3 VAC Range	0.301510 V	_____	0.298490 V	_____	_____
32	3V, 1MHz	3 VAC Range	3.371200 V	_____	2.628800 V	_____	_____
33	3V, 300KHz	3 VAC Range	3.104500 V	_____	2.895500 V	_____	_____
34	3V, 100KHz	3 VAC Range	3.021900 V	_____	2.978100 V	_____	_____
35	3V, 20KHz	3 VAC Range	3.005320 V	_____	2.994680 V	_____	_____
36	3V, 6.5KHz	3 VAC Range	3.005320 V	_____	2.994680 V	_____	_____
37	3V, 400Hz	3 VAC Range	3.005320 V	_____	2.994680 V	_____	_____

## PERFORMANCE TEST CARD 90 DAY LIMITS

Hewlett-Packard Model 3457A  
Digital Multimeter  
Serial Number \_\_\_\_\_

Test Performed by \_\_\_\_\_  
Date \_\_\_\_\_  
Reference Temperature \_\_\_\_\_

### AC VOLTAGE TEST (Cont'd)

Step#	Input to 3457A	Set-Up and Configuration	High Limit	Reading	Low Limit	Test Pass	Test Fail
FREQUENCY RESPONSE TEST (Cont'd)							
37	Set the 3457A to AC Slow Response (ACBAND < 400)						
38	3V, 100Hz	3 VAC Range	3.008800 V	_____	2.991200 V	_____	_____
39	3V, 45Hz	3 VAC Range	3.026800 V	_____	2.973200 V	_____	_____
40	3V, 20Hz	3 VAC Range	3.026800 V	_____	2.973200 V	_____	_____
41	300mV, 100Hz	300 mVAC Range	300.8800 mV	_____	299.1200 mV	_____	_____
42	300mV, 45Hz	300 mVAC Range	302.6800 mV	_____	297.3200 mV	_____	_____
43	300mV, 20Hz	300 mVAC Range	302.6800 mV	_____	297.3200 mV	_____	_____

### FREQUENCY TEST

Step#	Input to 3457A	Set-Up and Configuration	High Limit	Reading	Low Limit	Test Pass	Test Fail
1	1V, 20Hz	3 VAC Range	20.01000 Hz	_____	19.99000 Hz	_____	_____
2	1V, 1MHz	3 VAC Range	1.000100 MHz	_____	0.999900 MHz	_____	_____

## PERFORMANCE TEST CARD 90 DAY LIMITS

Hewlett-Packard Model 3457A  
Digital Multimeter  
Serial Number \_\_\_\_\_

Test Performed by \_\_\_\_\_  
Date \_\_\_\_\_  
Reference Temperature \_\_\_\_\_

### DC CURRENT TEST

Step#	Input to 3457A	Set-Up and Configuration	High Limit	Reading	Low Limit	Test Pass	Test Fail
-------	-------------------	-----------------------------	---------------	---------	--------------	--------------	--------------

#### OFFSET TEST

1	Open	300 uADCI Range	+ 000.0104 uA	_____	- 000.0104 uA	_____	_____
2	Open	3 mADCI Range	+ 0.000104 mA	_____	- 0.000104 mA	_____	_____
3	Open	30 mADCI Range	+ 00.00104 mA	_____	- 00.00104 mA	_____	_____
4	Open	300 mADCI Range	+ 000.0204 mA	_____	- 000.0204 mA	_____	_____
5	Open	1 ADCI Range	+ 0.000604 A	_____	- 0.000604 A	_____	_____

#### GAIN TEST

6	300 uA	300 uADCI Range	300.0704 uA	_____	299.9296 uA	_____	_____
7	3 mA	3 mADCI Range	3.000704 mA	_____	2.999296 mA	_____	_____
8	30 mA	30 mADCI Range	30.00704 ma	_____	29.99296 mA	_____	_____
9	300 mA	300 mADCI Range	300.2304 mA	_____	299.7696 mA	_____	_____
10	1 A	1 ADCI Range	1.001304 A	_____	0.998696 A	_____	_____

### AC CURRENT TEST

Step#	Input to 3457A	Set-Up and Configuration	High Limit	Reading	Low Limit	Test Pass	Test Fail
-------	-------------------	-----------------------------	---------------	---------	--------------	--------------	--------------

#### GAIN TEST

1	30 mA	30 mAACI Range	30.10300 mA	_____	29.89700 mA	_____	_____
2	300 mA	300 mAACI Range	301.0300 mA	_____	298.9700 mA	_____	_____
3	1 A	1 AACI Range	1.005300 A	_____	0.994700 A	_____	_____

## PERFORMANCE TEST CARD 90 DAY LIMITS

Hewlett-Packard Model 3457A  
Digital Multimeter  
Serial Number \_\_\_\_\_

Test Performed by \_\_\_\_\_  
Date \_\_\_\_\_  
Reference Temperature \_\_\_\_\_

### 2-WIRE OHMS TEST

Step#	Input to 3457A	Set-Up and Configuration	High Limit	Reading	Low Limit	Test Pass	Test Fail
OFFSET TEST							
1	Short	30 Ohm Range	+ 00.20335 ohm	_____	- 00.20335 ohm	_____	_____
2	Short	300 Ohm Range	+ 000.2035 ohm	_____	- 000.2035 ohm	_____	_____
3	Short	3 KOhm Range	+ 0.000207 Kohm	_____	- 0.000207 Kohm	_____	_____
4	Short	30 KOhm Range	+ 00.00027 Kohm	_____	- 00.00027 Kohm	_____	_____
5	Short	300 KOhm Range	+ 000.0010 Kohm	_____	- 000.0010 Kohm	_____	_____
6	Short	3 MOhm Range	+ 0.000014 Mohm	_____	- 0.000014 Mohm	_____	_____
7	Short	30 MOhm Range	+ 00.00083 Mohm	_____	- 00.00083 Mohm	_____	_____
GAIN TEST							
8	30 Ohm	30 Ohm Range	30.20530 ohm	_____	29.79470 ohm	_____	_____
9	300 Ohm	300 Ohm Range	300.2170 ohm	_____	299.7830 ohm	_____	_____
10	3 KOhm	3 KOhm Range	3.000312 Kohm	_____	2.999688 Kohm	_____	_____
11	30 KOhm	30 KOhm Range	30.00132 Kohm	_____	29.99868 Kohm	_____	_____
12	300 KOhm	300 KOhm Range	300.0130 Kohm	_____	299.9870 Kohm	_____	_____
13	3 MOhm	3 MOhm Range	3.000179 Mohm	_____	2.999821 Mohm	_____	_____
14	30 MOhm	30 MOhm Range	30.00833 Mohm	_____	29.99167 Mohm	_____	_____

## PERFORMANCE TEST CARD 90 DAY LIMITS

Hewlett-Packard Model 3457A  
Digital Multimeter  
Serial Number \_\_\_\_\_

Test Performed by \_\_\_\_\_  
Date \_\_\_\_\_  
Reference Temperature \_\_\_\_\_

### 4-WIRE OHMS TEST

Step#	Input to 3457A	Set-Up and Configuration	High Limit	Reading	Low Limit	Test Pass	Test Fail
<b>OFFSET TEST</b>							
1	Short	30 Ohm Range	+ 00.00335 ohm	_____	- 00.00335 ohm	_____	_____
2	Short	300 Ohm Range	+ 000.0035 ohm	_____	- 000.0035 ohm	_____	_____
3	Short	3 KOhm Range	+ 0.000007 Kohm	_____	- 0.000007 Kohm	_____	_____
4	Short	30 KOhm Range	+ 00.00007 Kohm	_____	- 00.00007 Kohm	_____	_____
5	Short	300 KOhm Range	+ 000.0008 Kohm	_____	- 000.0008 Kohm	_____	_____
6	Short	3 MOhm Range	+ 0.000014 Mohm	_____	- 0.000014 Mohm	_____	_____
7	Short	30 MOhm Range	+ 00.00083 Mohm	_____	- 00.00083 Mohm	_____	_____
<b>GAIN TEST</b>							
8	30 Ohm	30 Ohm Range	30.00530 ohm	_____	29.99470 ohm	_____	_____
9	300 Ohm	300 Ohm Range	300.0170 ohm	_____	299.9830 ohm	_____	_____
10	3 KOhm	3 KOhm Range	3.000112 Kohm	_____	2.999888 Kohm	_____	_____
11	30 KOhm	30 KOhm Range	30.00112 Kohm	_____	29.99888 Kohm	_____	_____
12	300 KOhm	300 KOhm Range	300.0128 Kohm	_____	299.9872 Kohm	_____	_____
13	3 MOhm	3 MOhm Range	3.000179 Mohm	_____	2.999821 Mohm	_____	_____
14	30 MOhm	30 MOhm Range	30.00833 Mohm	_____	29.99167 Mohm	_____	_____

# PERFORMANCE TEST CARD 90 DAY LIMITS

Hewlett-Packard Model 3457A  
Digital Multimeter  
Serial Number \_\_\_\_\_

Test Performed by \_\_\_\_\_  
Date \_\_\_\_\_  
Reference Temperature \_\_\_\_\_

## REAR INPUT TESTS (STANDARD INSTRUMENT)

Step#	Input to 3457A	Set-Up and Configuration	High Limit	Reading	Low Limit	Test Pass	Test Fail
DC VOLTAGE OFFSET TEST (Rear Terminals)							
1	Short	300 V Range	+ 000.0007 V	_____	- 000.0007 V	_____	_____
2	Short	30 V Range	+ 00.00020 V	_____	- 00.00020 V	_____	_____
3	Short	3 V Range	+ 0.000007 V	_____	- 0.000007 V	_____	_____
4	Short	300 mV Range	+ 000.0040 mV	_____	- 000.0040 mV	_____	_____
5	Short	30 mV Range	+ 00.00385 mV	_____	- 00.00385 mV	_____	_____
DC CURRENT OFFSET TEST (Rear Terminals)							
6	Open	300 uADCI Range	+ 000.0104 uA	_____	- 000.0104 uA	_____	_____
7	Open	3 mADCI Range	+ 0.000104 mA	_____	- 0.000104 mA	_____	_____
8	Open	30 mADCI Range	+ 00.00104 mA	_____	- 00.00104 mA	_____	_____
9	Open	300 mADCI Range	+ 000.0204 mA	_____	- 000.0204 mA	_____	_____
10	Open	3 ADCI Range	+ 0.000604 A	_____	- 0.000604 A	_____	_____
2-WIRE OHMS OFFSET TEST (Rear Terminals)							
11	Short	30 Ohm Range	+ 00.20335 ohm	_____	- 00.20335 ohm	_____	_____
12	Short	300 Ohm Range	+ 000.2035 ohm	_____	- 000.2035 ohm	_____	_____
13	Short	3 KOhm Range	+ 0.000207 Kohm	_____	- 0.000207 Kohm	_____	_____
14	Short	30 KOhm Range	+ 00.00027 Kohm	_____	- 00.00027 Kohm	_____	_____
15	Short	300 KOhm Range	+ 000.0010 Kohm	_____	- 000.0010 Kohm	_____	_____
16	Short	3 MOhm Range	+ 0.000014 Mohm	_____	- 0.000014 Mohm	_____	_____
17	Short	30 MOhm Range	+ 00.00083 Mohm	_____	- 00.00083 Mohm	_____	_____



## PERFORMANCE TEST CARD 90 DAY LIMITS

Hewlett-Packard Model 3457A  
Digital Multimeter  
Serial Number \_\_\_\_\_

Test Performed by \_\_\_\_\_  
Date \_\_\_\_\_  
Reference Temperature \_\_\_\_\_

### REAR INPUT TESTS (STANDARD INSTRUMENT)

Step#	Input to 3457A	Set-Up and Configuration	High Limit	Reading	Low Limit	Test Pass	Test Fail
-------	-------------------	-----------------------------	---------------	---------	--------------	--------------	--------------

#### 4-WIRE OHMS OFFSET TEST (Rear Terminals)

18	Short	30 Ohm Range	+ 00.00335 ohm	_____	- 00.00335 ohm	_____	_____
19	Short	300 Ohm Range	+ 000.0035 ohm	_____	- 000.0035 ohm	_____	_____
20	Short	3 KOhm Range	+ 0.000007 Kohm	_____	- 0.000007 Kohm	_____	_____
21	Short	30 KOhm Range	+ 00.00007 Kohm	_____	- 00.00007 Kohm	_____	_____
22	Short	300 KOhm Range	+ 000.0008 Kohm	_____	- 000.0008 Kohm	_____	_____
23	Short	3 MOhm Range	+ 0.000014 Mohm	_____	- 0.000014 Mohm	_____	_____
24	Short	30 MOhm Range	+ 00.00083 Mohm	_____	- 00.00083 Mohm	_____	_____

## PERFORMANCE TEST CARD 90 DAY LIMITS

Hewlett-Packard Model 3457A  
Digital Multimeter  
Serial Number \_\_\_\_\_

Test Performed by \_\_\_\_\_  
Date \_\_\_\_\_  
Reference Temperature \_\_\_\_\_

### REAR INPUT TESTS (44491A General Purpose Relay Assy)

Step#	3457 Input	Set-Up and Configuration	High Limit	Reading	Low Limit	Test Pass	Test Fail
DC VOLTAGE OFFSET TEST (44491A)							
1	Short	300 V Rng (Chan 0)	+ 000.0007 V	_____	- 000.0007 V	_____	_____
2	Short	30 V Rng (Chan 0)	+ 00.00020 V	_____	- 00.00020 V	_____	_____
3	Short	3 V Rng (Chan 0)	+ 0.000010 V	_____	- 0.000010 V	_____	_____
4	Short	300 mV Rng (Chan 0)	+ 000.0070 mV	_____	- 000.0070 mV	_____	_____
5	Short	30 mV Rng (Chan 0)	+ 00.00685 mV	_____	- 00.00685 mV	_____	_____
6	Short	30 mV Rng (Chan 1)	+ 00.00685 mV	_____	- 00.00685 mV	_____	_____
7	Short	30 mV Rng (Chan 2)	+ 00.00685 mV	_____	- 00.00685 mV	_____	_____
8	Short	30 mV Rng (Chan 3)	+ 00.00685 mV	_____	- 00.00685 mV	_____	_____
9	Short	30 mV Rng (Chan 4)	+ 00.00685 mV	_____	- 00.00685 mV	_____	_____
10	Short	30 mV Rng (Chan 5)	+ 00.00685 mV	_____	- 00.00685 mV	_____	_____
11	Short	30 mV Rng (Chan 6)	+ 00.00685 mV	_____	- 00.00685 mV	_____	_____
12	Short	30 mV Rng (Chan 7)	+ 00.00685 mV	_____	- 00.00685 mV	_____	_____
2-WIRE OHMS OFFSET TEST (44491A)							
13	Short	30 MOhm Rng (Chan 0)	+ 00.00086 MOhm	_____	- 00.00086 MOhm	_____	_____
14	Short	3 MOhm Rng (Chan 0)	+ 0.000019 MOhm	_____	- 0.000019 MOhm	_____	_____
15	Short	300 KOhm Rng (Chan 0)	+ 000.0033 KOhm	_____	- 000.0033 KOhm	_____	_____
16	Short	30 KOhm Rng (Chan 0)	+ 00.00230 KOhm	_____	- 00.00230 KOhm	_____	_____
17	Short	3 KOhm Rng (Chan 0)	+ 0.002210 KOhm	_____	- 0.002210 KOhm	_____	_____
18	Short	300 Ohm Rng (Chan 0)	+ 002.2065 Ohm	_____	- 002.2065 Ohm	_____	_____
19	Short	30 Ohm Rng (Chan 0)	+ 02.20635 Ohm	_____	- 02.20635 Ohm	_____	_____

## PERFORMANCE TEST CARD 90 DAY LIMITS

Hewlett-Packard Model 3457A  
Digital Multimeter  
Serial Number \_\_\_\_\_

Test Performed by \_\_\_\_\_  
Date \_\_\_\_\_  
Reference Temperature \_\_\_\_\_

### REAR INPUT TESTS (44491A General Purpose Relay Assy)

Step#	3457 Input	Set-Up and Configuration	High Limit	Reading	Low Limit	Test Pass	Test Fail
-------	------------	--------------------------	------------	---------	-----------	-----------	-----------

20	Short	30 Ohm Rng (Chan 1)	+ 02.20635 Ohm	_____	- 02.20635 Ohm	_____	_____
21	Short	30 Ohm Rng (Chan 2)	+ 02.20635 Ohm	_____	- 02.20635 Ohm	_____	_____
22	Short	30 Ohm Rng (Chan 3)	+ 02.20635 Ohm	_____	- 02.20635 Ohm	_____	_____
23	Short	30 Ohm Rng (Chan 4)	+ 02.20635 Ohm	_____	- 02.20635 Ohm	_____	_____
24	Short	30 Ohm Rng (Chan 5)	+ 02.20635 Ohm	_____	- 02.20635 Ohm	_____	_____
25	Short	30 Ohm Rng (Chan 6)	+ 02.20635 Ohm	_____	- 02.20635 Ohm	_____	_____
26	Short	30 Ohm Rng (Chan 7)	+ 02.20635 Ohm	_____	- 02.20635 Ohm	_____	_____

### 4-WIRE OHMS OFFSET TEST (44491A)

27	Short	30 Ohm Rng (Chan 10)	+ 00.00635 Ohm	_____	- 00.00635 Ohm	_____	_____
28	Short	300 Ohm Rng (Chan 10)	+ 000.0065 Ohm	_____	- 000.0065 Ohm	_____	_____
29	Short	3 KOhm Rng (Chan 10)	+ 0.000010 KOhm	_____	- 0.000010 KOhm	_____	_____
30	Short	30 KOhm Rng (Chan 10)	+ 00.00010 KOhm	_____	- 00.00010 KOhm	_____	_____
31	Short	300 KOhm Rng (Chan 10)	+ 000.0011 KOhm	_____	- 000.0011 KOhm	_____	_____
32	Short	3 MOhm Rng (Chan 10)	+ 0.000017 MOhm	_____	- 0.000017 MOhm	_____	_____
33	Short	30 MOhm Rng (Chan 10)	+ 00.00086 MOhm	_____	- 00.00086 MOhm	_____	_____

### DC CURRENT OFFSET TEST (44491A)

34	Open	300 uA Range	+ 000.0104 uA	_____	- 000.0104 uA	_____	_____
35	Open	3 mA Range	+ 0.000104 mA	_____	- 0.000104 mA	_____	_____
36	Open	30 mA Range	+ 00.00104 mA	_____	- 00.00104 mA	_____	_____
37	Open	300 mA Range	+ 000.0204 mA	_____	- 000.0204 mA	_____	_____
38	Open	3 A Range	+ 0.000604 A	_____	- 0.000604 A	_____	_____

## PERFORMANCE TEST CARD 90 DAY LIMITS

Hewlett-Packard Model 3457A  
Digital Multimeter  
Serial Number \_\_\_\_\_

Test Performed by \_\_\_\_\_  
Date \_\_\_\_\_  
Reference Temperature \_\_\_\_\_

### REAR INPUT TESTS (44492A 10 Channel Multiplex Assy)

Step#	3457 Input	Set-Up and Configuration	High Limit	Reading	Low Limit	Test Pass	Test Fail
DC VOLTAGE OFFSET TEST (44492A)							
1	Short	300 V Rng (Chan 0)	+ 000.0007 V	_____	- 000.0007 V	_____	_____
2	Short	30 V Rng (Chan 0)	+ 00.00020 V	_____	- 00.00020 V	_____	_____
3	Short	3 V Rng (Chan 0)	+ 0.000010 V	_____	- 0.000010 V	_____	_____
4	Short	300 mV Rng (Chan 0)	+ 000.0070 mV	_____	- 000.0070 mV	_____	_____
5	Short	300 mV Rng (Chan 1)	+ 000.0070 mV	_____	- 000.0070 mV	_____	_____
6	Short	300 mV Rng (Chan 2)	+ 000.0070 mV	_____	- 000.0070 mV	_____	_____
7	Short	300 mV Rng (Chan 3)	+ 000.0070 mV	_____	- 000.0070 mV	_____	_____
8	Short	300 mV Rng (Chan 4)	+ 000.0070 mV	_____	- 000.0070 mV	_____	_____
9	Short	300 mV Rng (Chan 5)	+ 000.0070 mV	_____	- 000.0070 mV	_____	_____
10	Short	300 mV Rng (Chan 6)	+ 000.0070 mV	_____	- 000.0070 mV	_____	_____
11	Short	300 mV Rng (Chan 7)	+ 000.0070 mV	_____	- 000.0070 mV	_____	_____
12	Short	300 mV Rng (Chan 8)	+ 000.0070 mV	_____	- 000.0070 mV	_____	_____
13	Short	300 mV Rng (Chan 9)	+ 000.0070 mV	_____	- 000.0070 mV	_____	_____
2-WIRE OHMS OFFSET TEST (44492A)							
14	Short	30 MOhm Rng (Chan 0)	+ 00.00086 KOhm	_____	- 00.00086 KOhm	_____	_____
15	Short	3 MOhm Rng (Chan 0)	+ 0.000021 MOhm	_____	- 0.000021 MOhm	_____	_____
16	Short	300 KOhm Rng (Chan 0)	+ 000.0033 KOhm	_____	- 000.0033 KOhm	_____	_____
17	Short	30 KOhm Rng (Chan 0)	+ 00.00230 KOhm	_____	- 00.00230 KOhm	_____	_____
18	Short	3 KOhm Rng (Chan 0)	+ 0.002210 KOhm	_____	- 0.002210 KOhm	_____	_____
19	Short	300 Ohm Rng (Chan 0)	+ 004.2065 Ohm	_____	- 004.2065 Ohm	_____	_____
20	Short	300 Ohm Rng (Chan 1)	+ 004.2065 Ohm	_____	- 004.2065 Ohm	_____	_____

## PERFORMANCE TEST CARD 90 DAY LIMITS

Hewlett-Packard Model 3457A  
Digital Mutimeter  
Serial Number \_\_\_\_\_

Test Performed by \_\_\_\_\_  
Date \_\_\_\_\_  
Reference Temperature \_\_\_\_\_

### REAR INPUT TESTS (44492A 10 Channel Multiplex Assy)

Step#	3457 Input	Set-Up and Configuration	High Limit	Reading	Low Limit	Test Pass	Test Fail
2-WIRE OHMS OFFSET TEST (44492A) CONT'D							
21	Short	300 Ohm Rng (Chan 2)	+ 004.2065 Ohm	_____	- 004.2065 Ohm	_____	_____
22	Short	300 Ohm Rng (Chan 3)	+ 004.2065 Ohm	_____	- 004.2065 Ohm	_____	_____
23	Short	300 Ohm Rng (Chan 4)	+ 004.2065 Ohm	_____	- 004.2065 Ohm	_____	_____
24	Short	300 Ohm Rng (Chan 5)	+ 004.2065 Ohm	_____	- 004.2065 Ohm	_____	_____
25	Short	300 Ohm Rng (Chan 6)	+ 004.2065 Ohm	_____	- 004.2065 Ohm	_____	_____
26	Short	300 Ohm Rng (Chan 7)	+ 004.2065 Ohm	_____	- 004.2065 Ohm	_____	_____
27	Short	300 Ohm Rng (Chan 8)	+ 004.2065 Ohm	_____	- 004.2065 Ohm	_____	_____
28	Short	300 Ohm Rng (Chan 9)	+ 004.2065 Ohm	_____	- 004.2065 Ohm	_____	_____

# PERFORMANCE TEST CARD 1 YEAR LIMITS

Hewlett-Packard Model 3457A  
Digital Multimeter  
Serial Number \_\_\_\_\_

Test Performed by \_\_\_\_\_  
Date \_\_\_\_\_  
Reference Temperature \_\_\_\_\_

## DC VOLTAGE TEST

Step#	Input to 3457A	Set-Up and Configuration	High Limit	Reading	Low Limit	Test Pass	Test Fail
OFFSET TEST							
1	Short	300 V Range	+ 000.0007 V	_____	- 000.0007 V	_____	_____
2	Short	30 V Range	+ 00.00020 V	_____	- 00.00020 V	_____	_____
3	Short	3 V Range	+ 0.000007 V	_____	- 0.000007 V	_____	_____
4	Short	300 mV Range	+ 000.0040 mV	_____	- 000.0040 mV	_____	_____
5	Short	30 mV Range	+ 00.00385 mV	_____	- 00.00385 mV	_____	_____
GAIN TEST							
6	30 mV	30 mV Range	+ 30.00520 mV	_____	+ 29.99480 mV	_____	_____
7	300 mV	300 mV Range	+ 300.0145 mV	_____	+ 299.9855 mV	_____	_____
8	3 V	3 V Range	+ 3.000082 V	_____	+ 2.999918 V	_____	_____
9	30 V	30 V Range	+ 30.00140 V	_____	+ 29.99860 V	_____	_____
10	300 V	300 V Range	+ 300.0172 V	_____	+ 299.9828 V	_____	_____
LINEARITY TEST							
11	3 V	3 V Range	+ 3.000082 V	_____	+ 2.999918 V	_____	_____
12	2 V	3 V Range	+ 2.000057 V	_____	+ 1.999943 V	_____	_____
13	1 V	3 V Range	+ 1.000032 V	_____	+ 0.999968 V	_____	_____
14	- 1 V	3 V Range	- 0.999968 V	_____	- 1.000032 V	_____	_____
15	- 2 V	3 V Range	- 1.999943 V	_____	- 2.000057 V	_____	_____
16	- 3 V	3 V Range	- 2.999918 V	_____	- 3.000082 V	_____	_____

# PERFORMANCE TEST CARD 1 YEAR LIMITS

Hewlett-Packard Model 3457A  
Digital Multimeter  
Serial Number \_\_\_\_\_

Test Performed by \_\_\_\_\_  
Date \_\_\_\_\_  
Reference Temperature \_\_\_\_\_

## AC VOLTAGE TEST

Step#	Input to 3457A	Set-Up and Configuration	High Limit	Reading	Low Limit	Test Pass	Test Fail
-------	-------------------	-----------------------------	---------------	---------	--------------	--------------	--------------

1 Set the 3457A to the AC Voltage Function and run the AUTO-CAL 2 routine.

### GAIN TEST

2	30mV, 1KHz	30 mVAC Range	30.06420 mV	_____	29.93580 mV	_____	_____
3	300mV, 1KHz	300 mVAC Range	300.6420 mV	_____	299.3580 mV	_____	_____
4	1V, 1KHz	3 VAC Range	1.003020 V	_____	0.996980 V	_____	_____
5	2V, 1KHz	3 VAC Range	2.004720 V	_____	1.995280 V	_____	_____
6	3V, 1KHz	3 VAC Range	3.006420 V	_____	2.993580 V	_____	_____
7	30V, 1KHz	30 VAC Range	30.06420 V	_____	29.93580 V	_____	_____
8	300V, 1KHz	300 VAC Range	300.8220 V	_____	299.1780 V	_____	_____
9	30V, 1KHz	300 VAC Range	30.2010 V	_____	29.7990 V	_____	_____
10	3V, 1KHz	30 VAC Range	3.01830 V	_____	2.98170 V	_____	_____
11	300mV, 1KHz	3 VAC Range	.301830 V	_____	.298170 V	_____	_____
12	30mV, 1KHz	300 mVAC Range	30.1830 mV	_____	29.8170 mV	_____	_____

13 Set the 3457A to AC Fast Response (ACBAND > 400)

### FREQUENCY RESPONSE TEST

14	30mV, 1MHz	300 mVAC Range	039.7200 mV	_____	020.2800 mV	_____	_____
15	30mV, 300KHz	300 mVAC Range	031.9500 mV	_____	028.0500 mV	_____	_____
16	30mV, 100KHz	300 mVAC Range	030.4400 mV	_____	029.5600 mV	_____	_____
17	30mV, 20KHz	300 mVAC Range	030.1830 mV	_____	029.8170 mV	_____	_____
18	30mV, 6.5KHz	300 mVAC Range	030.1830 mV	_____	029.8170 mV	_____	_____
19	30mV, 400Hz	300 mVAC Range	030.1830 mV	_____	029.8170 mV	_____	_____

## PERFORMANCE TEST CARD 1 YEAR LIMITS

Hewlett-Packard Model 3457A  
Digital Mutimeter  
Serial Number \_\_\_\_\_

Test Performed by \_\_\_\_\_  
Date \_\_\_\_\_  
Reference Temperature \_\_\_\_\_

### AC VOLTAGE TEST (Cont'd)

Step#	Input to 3457A	Set-Up and Configuration	High Limit	Reading	Low Limit	Test Pass	Test Fail
FREQUENCY RESPONSE TEST (Cont'd)							
20	300mV, 1MHz	300 mVAC Range	337.2600 mV	_____	262.7400 mV	_____	_____
21	300mV, 300KHz	300 mVAC Range	310.5900 mV	_____	289.4100 mV	_____	_____
22	300mV, 100KHz	300 mVAC Range	302.3300 mV	_____	297.6700 mV	_____	_____
23	300mV, 20KHz	300 mVAC Range	300.6420 mV	_____	299.3580 mV	_____	_____
24	300mV, 6.5KHz	300 mVAC Range	300.6420 mV	_____	299.3580 mV	_____	_____
25	300mV, 400Hz	300 mVAC Range	300.6420 mV	_____	299.3580 mV	_____	_____
26	300mV, 1MHz	3 VAC Range	0.397200 V	_____	0.202800 V	_____	_____
27	300mV, 300KHz	3 VAC Range	0.319500 V	_____	0.280500 V	_____	_____
28	300mV, 100KHz	3 VAC Range	0.304400 V	_____	0.295600 V	_____	_____
29	300mV, 20KHz	3 VAC Range	0.301830 V	_____	0.298170 V	_____	_____
30	300mV, 6.5KHz	3 VAC Range	0.301830 V	_____	0.298170 V	_____	_____
31	300mV, 400Hz	3 VAC Range	0.301830 V	_____	0.298170 V	_____	_____
32	3V, 1MHz	3 VAC Range	3.372600 V	_____	2.627400 V	_____	_____
33	3V, 300KHz	3 VAC Range	3.105900 V	_____	2.894100 V	_____	_____
34	3V, 100KHz	3 VAC Range	3.023300 V	_____	2.976700 V	_____	_____
35	3V, 20KHz	3 VAC Range	3.006420 V	_____	2.993580 V	_____	_____
36	3V, 6.5KHz	3 VAC Range	3.006420 V	_____	2.993580 V	_____	_____
37	3V, 400Hz	3 VAC Range	3.006420 V	_____	2.993580 V	_____	_____



# PERFORMANCE TEST CARD 1 YEAR LIMITS

Hewlett-Packard Model 3457A  
Digital Mutimeter  
Serial Number \_\_\_\_\_

Test Performed by \_\_\_\_\_  
Date \_\_\_\_\_  
Reference Temperature \_\_\_\_\_

## AC VOLTAGE TEST (Cont'd)

Step#	Input to 3457A	Set-Up and Configuration	High Limit	Reading	Low Limit	Test Pass	Test Fail
FREQUENCY RESPONSE TEST (Cont'd)							
38	Set the 3457A to AC Slow Response (ACBAND < 400)						
39	3V,100Hz	3 VAC Range	3.008820 V	_____	2.991180 V	_____	_____
40	3V,45Hz	3 VAC Range	3.019320 V	_____	2.980680 V	_____	_____
41	3V,20Hz	3 VAC Range	3.019320 V	_____	2.980680 V	_____	_____
42	300mV,100Hz	300 mVAC Range	300.8820 mV	_____	299.1180 mV	_____	_____
43	300mV,45Hz	300 mVAC Range	301.9320 mV	_____	298.0680 mV	_____	_____
44	300mV,20Hz	300 mVAC Range	301.9320 mV	_____	298.0680 mV	_____	_____

## FREQUENCY TEST

Step#	Input to 3457A	Set-Up and Configuration	High Limit	Reading	Low Limit	Test Pass	Test Fail
1	1V,20Hz	3 VAC Range	20.01000 Hz	_____	19.99000 Hz	_____	_____
2	1V,1MHz	3 VAC Range	1.000100 MHz	_____	0.999900 MHz	_____	_____

## PERFORMANCE TEST CARD 1 YEAR LIMITS

Hewlett-Packard Model 3457A  
Digital Multimeter  
Serial Number \_\_\_\_\_

Test Performed by \_\_\_\_\_  
Date \_\_\_\_\_  
Reference Temperature \_\_\_\_\_

### DC CURRENT TEST

Step#	Input to 3457A	Set-Up and Configuration	High Limit	Reading	Low Limit	Test Pass	Test Fail
-------	-------------------	-----------------------------	---------------	---------	--------------	--------------	--------------

#### OFFSET TEST

1	Open	300 uADCI Range	+ 000.0104 uA	_____	- 000.0104 uA	_____	_____
2	Open	3 mADCI Range	+ 0.000104 mA	_____	- 0.000104 mA	_____	_____
3	Open	30 mADCI Range	+ 00.00104 mA	_____	- 00.00104 mA	_____	_____
4	Open	300 mADCI Range	+ 000.0204 mA	_____	- 000.0204 mA	_____	_____
5	Open	1 ADCI Range	+ 0.000604 A	_____	- 0.000604 A	_____	_____

#### GAIN TEST

6	300 uA	300 uADCI Range	300.1304 uA	_____	299.8696 uA	_____	_____
7	3 mA	3 mADCI Range	3.001304 mA	_____	2.998696 mA	_____	_____
8	30 mA	30 mADCI Range	30.01304 mA	_____	29.98696 mA	_____	_____
9	300 mA	300 mADCI Range	300.2604 mA	_____	299.7396 mA	_____	_____
10	1 A	1 ADCI Range	1.001304 A	_____	0.998696 A	_____	_____

### AC CURRENT TEST

Step#	Input to 3457A	Set-Up and Configuration	High Limit	Reading	Low Limit	Test Pass	Test Fail
-------	-------------------	-----------------------------	---------------	---------	--------------	--------------	--------------

#### GAIN TEST

1	30 mA	30 mAACI Range	30.12700 mA	_____	29.87300 mA	_____	_____
2	300 mA	300 mAACI Range	301.2700 mA	_____	298.7300 mA	_____	_____
3	1 A	1 AACI Range	1.007100 A	_____	0.992900 A	_____	_____

# PERFORMANCE TEST CARD 1 YEAR LIMITS

Hewlett-Packard Model 3457A  
Digital Multimeter  
Serial Number \_\_\_\_\_

Test Performed by \_\_\_\_\_  
Date \_\_\_\_\_  
Reference Temperature \_\_\_\_\_

## 2-WIRE OHMS TEST

Step#	Input to 3457A	Set-Up and Configuration	High Limit	Reading	Low Limit	Test Pass	Test Fail
<b>OFFSET TEST</b>							
1	Short	30 Ohm Range	+ 00.20335 ohm	_____	- 00.20335 ohm	_____	_____
2	Short	300 Ohm Range	+ 000.2035 ohm	_____	- 000.2035 ohm	_____	_____
3	Short	3 KOhm Range	+ 0.000207 Kohm	_____	- 0.000207 Kohm	_____	_____
4	Short	30 KOhm Range	+ 00.00027 Kohm	_____	- 00.00027 Kohm	_____	_____
5	Short	300 KOhm Range	+ 000.0010 Kohm	_____	- 000.0010 Kohm	_____	_____
6	Short	3 MOhm Range	+ 0.000014 Mohm	_____	- 0.000014 Mohm	_____	_____
7	Short	30 MOhm Range	+ 00.00083 Mohm	_____	- 00.00083 Mohm	_____	_____
<b>GAIN TEST</b>							
8	30 Ohm	30 Ohm Range	30.20560 ohm	_____	29.79440 ohm	_____	_____
9	300 Ohm	300 Ohm Range	300.2200 ohm	_____	299.7800 ohm	_____	_____
10	3 KOhm	3 KOhm Range	3.000357 Kohm	_____	2.999643 Kohm	_____	_____
11	30 KOhm	30 KOhm Range	30.00177 Kohm	_____	29.99823 Kohm	_____	_____
12	300 KOhm	300 KOhm Range	300.0160 Kohm	_____	299.9840 Kohm	_____	_____
13	3 MOhm	3 MOhm Range	3.000209 Mohm	_____	2.999791 Mohm	_____	_____
14	30 MOhm	30 MOhm Range	30.01283 Mohm	_____	29.98717 Mohm	_____	_____

# PERFORMANCE TEST CARD 1 YEAR LIMITS

Hewlett-Packard Model 3457A  
Digital Multimeter  
Serial Number \_\_\_\_\_

Test Performed by \_\_\_\_\_  
Date \_\_\_\_\_  
Reference Temperature \_\_\_\_\_

## 4-WIRE OHMS TEST

Step#	Input to 3457A	Set-Up and Configuration	High Limit	Reading	Low Limit	Test Pass	Test Fail
-------	-------------------	-----------------------------	---------------	---------	--------------	--------------	--------------

### OFFSET TEST

1	Short	30 Ohm Range	+ 00.00335 ohm	_____	- 00.00335 ohm	_____	_____
2	Short	300 Ohm Range	+ 000.0035 ohm	_____	- 000.0035 ohm	_____	_____
3	Short	3 KOhm Range	+ 0.000007 Kohm	_____	- 0.000007 Kohm	_____	_____
4	Short	30 KOhm Range	+ 00.00007 Kohm	_____	- 00.00007 Kohm	_____	_____
5	Short	300 KOhm Range	+ 000.0008 Kohm	_____	- 000.0008 Kohm	_____	_____
6	Short	3 MOhm Range	+ 0.000014 Mohm	_____	- 0.000014 Mohm	_____	_____
7	Short	30 MOhm Range	+ 00.00083 Mohm	_____	- 00.00083 Mohm	_____	_____

### GAIN TEST

8	30 Ohm	30 Ohm Range	30.00560 ohm	_____	29.99440 ohm	_____	_____
9	300 Ohm	300 Ohm Range	300.0200 ohm	_____	299.9800 ohm	_____	_____
10	3 KOhm	3 KOhm Range	3.000157 Kohm	_____	2.999843 Kohm	_____	_____
11	30 KOhm	30 KOhm Range	30.00157 Kohm	_____	29.99843 Kohm	_____	_____
12	300 KOhm	300 KOhm Range	300.0158 Kohm	_____	299.9842 Kohm	_____	_____
13	3 MOhm	3 MOhm Range	3.000209 Mohm	_____	2.999791 Mohm	_____	_____
14	30 MOhm	30 MOhm Range	30.01283 Mohm	_____	29.98717 Mohm	_____	_____

# PERFORMANCE TEST CARD 1 YEAR LIMITS

Hewlett-Packard Model 3457A  
Digital Mutimeter  
Serial Number \_\_\_\_\_

Test Performed by \_\_\_\_\_  
Date \_\_\_\_\_  
Reference Temperature \_\_\_\_\_

## REAR INPUT TESTS (STANDARD INSTRUMENT)

Step#	Input to 3457A	Set-Up and Configuration	High Limit	Reading	Low Limit	Test Pass	Test Fail
DC VOLTAGE OFFSET TEST (Rear Terminals)							
1	Short	300 V Range	+ 000.0007 V	_____	- 000.0007 V	_____	_____
2	Short	30 V Range	+ 00.00020 V	_____	- 00.00020 V	_____	_____
3	Short	3 V Range	+ 0.000007 V	_____	- 0.000007 V	_____	_____
4	Short	300 mV Range	+ 000.0040 mV	_____	- 000.0040 mV	_____	_____
5	Short	30 mV Range	+ 00.00385 mV	_____	- 00.00385 mV	_____	_____
DC CURRENT OFFSET TEST (Rear Terminals)							
6	Open	300 uADCI Range	+ 000.0104 uA	_____	- 000.0104 uA	_____	_____
7	Open	3 mADCI Range	+ 0.000104 mA	_____	- 0.000104 mA	_____	_____
8	Open	30 mADCI Range	+ 00.00104 mA	_____	- 00.00104 mA	_____	_____
9	Open	300 mADCI Range	+ 000.0204 mA	_____	- 000.0204 mA	_____	_____
10	Open	1 ADCI Range	+ 0.000604 A	_____	- 0.000604 A	_____	_____
2-WIRE OHMS OFFSET TEST (Rear Terminals)							
11	Short	30 Ohm Range	+ 00.20335 ohm	_____	- 00.20335 ohm	_____	_____
12	Short	300 Ohm Range	+ 000.2035 ohm	_____	- 000.2035 ohm	_____	_____
13	Short	3 KOhm Range	+ 0.000207 Kohm	_____	- 0.000207 Kohm	_____	_____
14	Short	30 KOhm Range	+ 00.00027 Kohm	_____	- 00.00027 Kohm	_____	_____
15	Short	300 KOhm Range	+ 000.0010 Kohm	_____	- 000.0010 Kohm	_____	_____
16	Short	3 MOhm Range	+ 0.000014 Mohm	_____	- 0.000014 Mohm	_____	_____
17	Short	30 MOhm Range	+ 00.00083 Mohm	_____	- 00.00083 Mohm	_____	_____

# PERFORMANCE TEST CARD 1 YEAR LIMITS

Hewlett-Packard Model 3457A  
Digital Mutimeter  
Serial Number \_\_\_\_\_

Test Performed by \_\_\_\_\_  
Date \_\_\_\_\_  
Reference Temperature \_\_\_\_\_

## REAR INPUT TESTS (STANDARD INSTRUMENT)

Step#	Input to 3457A	Set-Up and Configuration	High Limit	Reading	Low Limit	Test Pass	Test Fail
-------	-------------------	-----------------------------	---------------	---------	--------------	--------------	--------------

### 4-WIRE OHMS OFFSET TEST (Rear Terminals)

18	Short	30 Ohm Range	+ 00.00335 ohm	_____	- 00.00335 ohm	_____	_____
19	Short	300 Ohm Range	+ 000.0035 ohm	_____	- 000.0035 ohm	_____	_____
20	Short	3 KOhm Range	+ 0.000007 Kohm	_____	- 0.000007 Kohm	_____	_____
21	Short	30 KOhm Range	+ 00.00007 Kohm	_____	- 00.00007 Kohm	_____	_____
22	Short	300 KOhm Range	+ 000.0008 Kohm	_____	- 000.0008 Kohm	_____	_____
23	Short	3 MOhm Range	+ 0.000014 Mohm	_____	- 0.000014 Mohm	_____	_____
24	Short	30 MOhm Range	+ 00.00083 Mohm	_____	- 00.00083 Mohm	_____	_____

# PERFORMANCE TEST CARD 1 YEAR LIMITS

Hewlett-Packard Model 3457A  
Digital Multimeter  
Serial Number \_\_\_\_\_

Test Performed by \_\_\_\_\_  
Date \_\_\_\_\_  
Reference Temperature \_\_\_\_\_

## REAR INPUT TESTS (44491A General Purpose Relay Assy)

Step#	3457 Input	Set-Up and Configuration	High Limit	Reading	Low Limit	Test Pass	Test Fail
DC VOLTAGE OFFSET TEST (44491A)							
1	Short	300 V Rng (Chan 0)	+ 000.0007 V	_____	- 000.0007 V	_____	_____
2	Short	30 V Rng (Chan 0)	+ 00.00020 V	_____	- 00.00020 V	_____	_____
3	Short	3 V Rng (Chan 0)	+ 0.000010 V	_____	- 0.000010 V	_____	_____
4	Short	300 mV Rng (Chan 0)	+ 000.0070 mV	_____	- 000.0070 mV	_____	_____
5	Short	30 mV Rng (Chan 0)	+ 00.00685 mV	_____	- 00.00685 mV	_____	_____
6	Short	30 mV Rng (Chan 1)	+ 00.00685 mV	_____	- 00.00685 mV	_____	_____
7	Short	30 mV Rng (Chan 2)	+ 00.00685 mV	_____	- 00.00685 mV	_____	_____
8	Short	30 mV Rng (Chan 3)	+ 00.00685 mV	_____	- 00.00685 mV	_____	_____
9	Short	30 mV Rng (Chan 4)	+ 00.00685 mV	_____	- 00.00685 mV	_____	_____
10	Short	30 mV Rng (Chan 5)	+ 00.00685 mV	_____	- 00.00685 mV	_____	_____
11	Short	30 mV Rng (Chan 6)	+ 00.00685 mV	_____	- 00.00685 mV	_____	_____
12	Short	30 mV Rng (Chan 7)	+ 00.00685 mV	_____	- 00.00685 mV	_____	_____
2-WIRE OHMS OFFSET TEST (44491A)							
13	Short	30 MOhm Rng (Chan 0)	+ 00.00086 MOhm	_____	- 00.00086 MOhm	_____	_____
14	Short	3 MOhm Rng (Chan 0)	+ 0.000019 MOhm	_____	- 0.000019 MOhm	_____	_____
15	Short	300 KOhm Rng (Chan 0)	+ 000.0033 KOhm	_____	- 000.0033 KOhm	_____	_____
16	Short	30 KOhm Rng (Chan 0)	+ 00.00230 KOhm	_____	- 00.00230 KOhm	_____	_____
17	Short	3 KOhm Rng (Chan 0)	+ 0.002210 KOhm	_____	- 0.002210 KOhm	_____	_____
18	Short	300 Ohm Rng (Chan 0)	+ 002.2065 Ohm	_____	- 002.2065 Ohm	_____	_____
19	Short	30 Ohm Rng (Chan 0)	+ 02.20635 Ohm	_____	- 02.20635 Ohm	_____	_____

# PERFORMANCE TEST CARD 1 YEAR LIMITS

Hewlett-Packard Model 3457A  
Digital Mutimeter  
Serial Number \_\_\_\_\_

Test Performed by \_\_\_\_\_  
Date \_\_\_\_\_  
Reference Temperature \_\_\_\_\_

## REAR INPUT TESTS (44491A General Purpose Relay Assy)

Step#	3457 Input	Set-Up and Configuration	High Limit	Reading	Low Limit	Test Pass	Test Fail
20	Short	30 Ohm Rng (Chan 1)	+ 02.20635 Ohm	_____	- 02.20635 Ohm	_____	_____
21	Short	30 Ohm Rng (Chan 2)	+ 02.20635 Ohm	_____	- 02.20635 Ohm	_____	_____
22	Short	30 Ohm Rng (Chan 3)	+ 02.20635 Ohm	_____	- 02.20635 Ohm	_____	_____
23	Short	30 Ohm Rng (Chan 4)	+ 02.20635 Ohm	_____	- 02.20635 Ohm	_____	_____
24	Short	30 Ohm Rng (Chan 5)	+ 02.20635 Ohm	_____	- 02.20635 Ohm	_____	_____
25	Short	30 Ohm Rng (Chan 6)	+ 02.20635 Ohm	_____	- 02.20635 Ohm	_____	_____
26	Short	30 Ohm Rng (Chan 7)	+ 02.20635 Ohm	_____	- 02.20635 Ohm	_____	_____
4-WIRE OHMS OFFSET TEST (44491A)							
27	Short	30 Ohm Rng (Chan 10)	+ 00.00635 Ohm	_____	- 00.00635 Ohm	_____	_____
28	Short	300 Ohm Rng (Chan 10)	+ 000.0065 Ohm	_____	- 000.0065 Ohm	_____	_____
29	Short	3 KOhm Rng (Chan 10)	+ 0.000010 KOhm	_____	- 0.000010 KOhm	_____	_____
30	Short	30 KOhm Rng (Chan 10)	+ 00.00010 KOhm	_____	- 00.00010 KOhm	_____	_____
31	Short	300 KOhm Rng (Chan 10)	+ 000.0011 KOhm	_____	- 000.0011 KOhm	_____	_____
32	Short	3 MOhm Rng (Chan 10)	+ 0.000017 MOhm	_____	- 0.000017 MOhm	_____	_____
33	Short	30 MOhm Rng (Chan 10)	+ 00.00086 MOhm	_____	- 00.00086 MOhm	_____	_____
DC CURRENT OFFSET TEST (44491A)							
34	Open	300 uA Range	+ 000.0104 uA	_____	- 000.0104 uA	_____	_____
35	Open	3 mA Range	+ 0.000104 mA	_____	- 0.000104 mA	_____	_____
36	Open	30 mA Range	+ 00.00104 mA	_____	- 00.00104 mA	_____	_____
37	Open	300 mA Range	+ 000.0204 mA	_____	- 000.0204 mA	_____	_____
38	Open	3 A Range	+ 0.000604 A	_____	- 0.000604 A	_____	_____



# PERFORMANCE TEST CARD 1 YEAR LIMITS

Hewlett-Packard Model 3457A  
Digital Multimeter  
Serial Number \_\_\_\_\_

Test Performed by \_\_\_\_\_  
Date \_\_\_\_\_  
Reference Temperature \_\_\_\_\_

## REAR INPUT TESTS (44492A 10 Channel Multiplex Assy)

Step#	3457 Input	Set-Up and Configuration	High Limit	Reading	Low Limit	Test Pass	Test Fail
DC VOLTAGE OFFSET TEST (44492A)							
1	Short	300 V Rng (Chan 0)	+ 000.0007 V	_____	- 000.0007 V	_____	_____
2	Short	30 V Rng (Chan 0)	+ 00.00020 V	_____	- 00.00020 V	_____	_____
3	Short	3 V Rng (Chan 0)	+ 0.000010 V	_____	- 0.000010 V	_____	_____
4	Short	300 mV Rng (Chan 0)	+ 000.0070 mV	_____	- 000.0070 mV	_____	_____
5	Short	300 mV Rng (Chan 1)	+ 000.0070 mV	_____	- 000.0070 mV	_____	_____
6	Short	300 mV Rng (Chan 2)	+ 000.0070 mV	_____	- 000.0070 mV	_____	_____
7	Short	300 mV Rng (Chan 3)	+ 000.0070 mV	_____	- 000.0070 mV	_____	_____
8	Short	300 mV Rng (Chan 4)	+ 000.0070 mV	_____	- 000.0070 mV	_____	_____
9	Short	300 mV Rng (Chan 5)	+ 000.0070 mV	_____	- 000.0070 mV	_____	_____
10	Short	300 mV Rng (Chan 6)	+ 000.0070 mV	_____	- 000.0070 mV	_____	_____
11	Short	300 mV Rng (Chan 7)	+ 000.0070 mV	_____	- 000.0070 mV	_____	_____
12	Short	300 mV Rng (Chan 8)	+ 000.0070 mV	_____	- 000.0070 mV	_____	_____
13	Short	300 mV Rng (Chan 9)	+ 000.0070 mV	_____	- 000.0070 mV	_____	_____
2-WIRE OHMS OFFSET TEST (44492A)							
14	Short	30 MOhm Rng (Chan 0)	+ 00.00086 KOhm	_____	- 00.00086 KOhm	_____	_____
15	Short	3 MOhm Rng (Chan 0)	+ 0.000021 MOhm	_____	- 0.000021 MOhm	_____	_____
16	Short	300 KOhm Rng (Chan 0)	+ 000.0033 KOhm	_____	- 000.0033 KOhm	_____	_____
17	Short	30 KOhm Rng (Chan 0)	+ 00.00230 KOhm	_____	- 00.00230 KOhm	_____	_____
18	Short	3 KOhm Rng (Chan 0)	+ 0.002210 KOhm	_____	- 0.002210 KOhm	_____	_____
19	Short	300 Ohm Rng (Chan 0)	+ 004.2065 Ohm	_____	- 004.2065 Ohm	_____	_____
20	Short	300 Ohm Rng (Chan 1)	+ 004.2065 Ohm	_____	- 004.2065 Ohm	_____	_____

# PERFORMANCE TEST CARD 1 YEAR LIMITS

Hewlett-Packard Model 3457A  
Digital Multimeter  
Serial Number \_\_\_\_\_

Test Performed by \_\_\_\_\_  
Date \_\_\_\_\_  
Reference Temperature \_\_\_\_\_

## REAR INPUT TESTS (44492A 10 Channel Multiplex Assy)

Step#	3457 Input	Set-Up and Configuration	High Limit	Reading	Low Limit	Test Pass	Test Fail
-------	---------------	-----------------------------	---------------	---------	--------------	--------------	--------------

### 2-WIRE OHMS OFFSET TEST (44492A) CONT'D

21	Short	300 Ohm Rng (Chan 2)	+ 004.2065 Ohm	_____	- 004.2065 Ohm	_____	_____
22	Short	300 Ohm Rng (Chan 3)	+ 004.2065 Ohm	_____	- 004.2065 Ohm	_____	_____
23	Short	300 Ohm Rng (Chan 4)	+ 004.2065 Ohm	_____	- 004.2065 Ohm	_____	_____
24	Short	300 Ohm Rng (Chan 5)	+ 004.2065 Ohm	_____	- 004.2065 Ohm	_____	_____
25	Short	300 Ohm Rng (Chan 6)	+ 004.2065 Ohm	_____	- 004.2065 Ohm	_____	_____
26	Short	300 Ohm Rng (Chan 7)	+ 004.2065 Ohm	_____	- 004.2065 Ohm	_____	_____
27	Short	300 Ohm Rng (Chan 8)	+ 004.2065 Ohm	_____	- 004.2065 Ohm	_____	_____
28	Short	300 Ohm Rng (Chan 9)	+ 004.2065 Ohm	_____	- 004.2065 Ohm	_____	_____

# SECTION V CALIBRATION

## WARNING

*The information contained in this section is intended for the use of service trained personnel who understand electronic circuitry and are aware of the hazards involved. Do not attempt to perform any of the procedures outlined in this section unless you are qualified to do so.*

### 5-1. INTRODUCTION

5-2. Section V contains Manual Calibration Procedures for the HP 3457A Multimeter. Section V also contains information explaining the Calibration Security features built into the 3457A. The 3457A has only two screwdriver adjustments which, under normal conditions, do not require adjusting. All calibration is accomplished from the front panel or through computer control.

5-3. An Automatic Calibration procedure, which includes software and instructions, is available by ordering HP Part Number 03457-10085 (for use with the HP Model 85B) or 03457-10200 (for use with the HP Series 200 computer). The equipment listed below is preferred for use with the Automatic Calibration Procedure, however, other equipment may be used.

Controller - - - - -	HP Model 85B Computer or HP Series 200 Computer
Frequency Counter - - - - -	HP 5314A or HP 3457A
DC Voltage/Current Resistance Calibrator - - - - -	Datron 4000A
AC Voltage/Current/Frequency Calibrator - - - - -	Datron 4200

### 5-4. CALIBRATION SECURITY

5-5. The Calibration Security feature of the 3457A allows the person responsible for calibration of the unit to enter a Security Code to prevent accidental or unauthorized calibration.

### 5-6. Security Code

5-7. The Security Code is a six digit integer number from 0 through 999,999 (if the number entered is not an integer number, it will be rounded to an integer value and then used). The instrument is shipped from the factory with the Security Code set to 3457. Setting the code to zero disables the security feature.

5-8. **Changing the Security Code** (SECURE <old security code> , <new security code>). The procedure for changing the Security Code is as follows:

- a. Access the SECURE command. (*Press the Blue SHIFT key, then the RECALL / S configuration key. Use the ↓ scroll key to display the SECURE command.*)
- b. Enter the old Security Code, the delimiter ( , ) and the new Security Code. (*The instrument is shipped from the factory with the security code set to 3457*). Example: To change the Security Code from 3457 to 7543, enter 3457 , 7543.
- c. Press the ENT key. The instrument will now respond to the new Security Code.

5-9. In the event that the security code is unknown, the security feature can be disabled to permit a new code to be entered. To disable the security feature, complete the following steps.

- a. Remove all power from the 3457A (line cord and external inputs) and turn the unit upside-down.
- b. Loosen the six captive screws in the bottom cover. (*It is not necessary to remove these screws from the bottom cover.*)
- c. Return the unit to an upright position and remove the top cover.
- d. Remove the NORM / DSA / KEY jumper (JM532) from the NORM position and place it in the KEY position. (*JM532 is located on the A1 logic board directly behind the front panel display.*)
- e. Reconnect the power and turn the instrument ON.
- f. Access the SECURE command. (*Press the Blue SHIFT key then the RECALL / S configuration key. Use the ↓ scroll key to display the SECURE command.*)
- g. Enter the number 0, the delimiter ( , ) and the security number you wish to use.
- h. Press the ENT key.
- i. Disconnect power and return jumper JM532 to the NORM position.
- j. Replace the top cover, tighten the retaining screws and reconnect the power. The instrument will now respond to the security code just entered.

<b>NOTE</b>
-------------

*When jumper JM532 is in the KEY position, the security feature is disabled. It is possible to calibrate the instrument without entering a security number under these conditions. If a new security number is not entered while the jumper is in the KEY position, the original number will again be in effect when jumper JM532 is returned to the NORM position.*

#### 5-10. Calibration Number (CALNUM?)

5-11. The CALNUM? command provides you with a method of monitoring the number of calibrations performed. By using this command, you can determine whether un-authorized calibrations have occurred. The instrument will always respond the CALNUM query command by displaying the number of calibration RAM entries completed since factory initialization. The maximum calibration number which can be stored is 32767. After reaching the maximum number, the counter resets to 0 and begins again. Please note that the calibration number is increased by one for each calibration point. A complete calibration increases the calibration number by several digits.

5-12. The procedure for reading the Calibration Number is as follows:

- a. Access the CALNUM? command. (*Press the Blue SHIFT key then the OFFSET COMP / C configuration key. Use the ↓ scroll key to display the CALNUM? command.*)
- b. Press the ENT key.

- c. The display will show CALNUM? and the current calibration number.
- d. Press any key to return the instrument to normal operation.

### 5-13. PRELIMINARY CALIBRATION PROCEDURES

5-14. The following steps should be performed prior to calibration of the 3457A:

a. Select the calibration area. The 3457A may be calibrated in a "bench" environment or in a system cabinet. For greatest accuracy, select an area where the temperature is between 18°C and 28°C and stable within ±5°C.

b. Connect the 3457A to an appropriate power source and turn the instrument ON. The 3457A can operate on line voltages from 100 Vac to 240 Vac, 50 Hz or 60 Hz. Refer to Section II, Line Voltage Selection, for proper rear panel switch settings and fuse selection.

c. Remove all external input signals from the front and rear/scanner input terminals.

d. Run the instrument Self Test. (*Press the Blue SHIFT key then the ← / TEST key*). The display will show TESTING while the test routine is running.

1. If the display shows SELF TEST OK after the test has completed, continue with step " e ".

2. If the display shows TEST FAILED, check the ERROR message. (*Press the Blue SHIFT key then the - / ERROR key*).

- If the Error Message reads OUT OF CALIBRATION, continue with step " e ". (*It is probable that performing the Calibration Procedures will eliminate this error*).

- If the Error Message reads HARDWARE ERR, check the AUXERR? (Auxiliary Error) message for additional information. (*Press the Blue SHIFT key then the NPLC / A configuration key. Use the ↓ scroll key to display AUXERR. Press the ENT key*).

- An AUXERR? message of 16 indicates the Input Amplifier Offset is beyond tolerance. Perform the Input Amplifier Offset adjustment (Paragraph 5-15) and repeat steps " d " through " h " of this procedure.

- An AUXERR? message of 256 indicates the AC attenuator frequency compensation is beyond tolerance. Perform the AC Converter Frequency Response adjustment (Paragraph 5-17) and repeat steps " d " through " h " of this procedure.

- An AUXERR? message, other than 16 or 256 indicates a component failure. Refer to Section VIII for repair procedures.

e. Allow the instrument to warm-up for a period of one hour.

f. Run the AUTO CAL (Auto-calibration) routine. (*Press the AUTO CAL configuration key, to display the ACAL command, enter the number 1 and press the ENT key*).

g. Record the Calibration Number if desired. (Refer to paragraph 5-10).

h. Proceed to the calibration procedures beginning at paragraph 5-19.

**5-15. Input Amplifier Offset Adjustment**

5-16. This adjustment is not required unless the Self Test response is **HARDWARE ERR** and the **AUXERR** message is 16. Adjust the Input Amplifier Offset as follows:

- a. Remove all power from the 3457A (line cord and external inputs).
- b. Loosen the two screws attaching the rear terminal assembly or terminal block assembly to the rear panel and remove the terminal or terminal block assembly.
- c. Turn the instrument upside-down and loosen the six captive screws in the bottom cover. *(It is not necessary to remove these screws from the bottom cover).*
- d. Return the unit to an upright position and remove the top cover.
- e. With the front panel of the instrument facing you, move the plug-in support assembly slightly to the left to release the locking tab and lift the support assembly.
- f. Lay the plug-in support assembly over the front panel to gain access to the Input Amplifier adjustment (Vos Adj A2R113).
- g. Reconnect power to the instrument and turn it ON.
- h. Enable Diagnostic Routine number 4. *(Press the Blue SHIFT key then the AUTO ZERO / D configuration key. Use the ↓ scroll key to display DIAGNOSTIC. Enter the number 4 and press the ENT key).*
- i. Use an insulated adjustment tool to adjust A2-R113 (Vos adj) until the display reads **PASSED**.
- j. Exit the Diagnostic Routine. *(Press and hold the → / RESET display key until a tone is heard).*
- k. Turn the instrument OFF and remove the power cord.
- l. Replace the plug-in support assembly, top cover and terminal or terminal block assembly.
- m. Reconnect power and turn the instrument ON.

**5-17. AC Convertor Frequency Response Adjustment**

5-18. This adjustment is not required unless the Self-Test response is **HARDWARE ERR** and the **AUXERR** message is 256. Adjust the AC Convertor Frequency Response as follows:

- a. Remove all power from the 3457A (line cord and external inputs).
- b. Loosen the two screws attaching the rear terminal assembly or terminal block assembly to the rear panel and remove the terminal or terminal block assembly.
- c. Turn the instrument upside-down and loosen the six captive screws in the bottom cover. *(It is not necessary to remove these screws from the bottom cover).*
- d. Return the unit to an upright position and remove the top cover.
- e. With the front panel of the instrument facing you, move the plug-in support assembly slightly to the left to release the locking tab and lift the support assembly.

- f. Lay the plug-in support assembly over the front panel to gain access to the AC convertor frequency response adjustment (Gain/Flatness A3C332).
- g. Reconnect power to the instrument and turn it ON.
- h. Run the AC Auto-Cal routine. (*Press the AUTO CAL configuration key, enter the number 2 and press the ENT key*).
- i. Enable Diagnostic Routine number 8. (*Press the Blue SHIFT key then the AUTO ZERO / D configuration key. Use the ↓ scroll key to display DIAGNOSTIC. Enter the number 8 and press the ENT key*).
- j. Use an insulated adjustment tool to adjust A3-C332 (Gain/Flatness adj) until the display reads PASSED 0.
- k. Exit the Diagnostic Routine. (*Press and hold the → / RESET display key until a tone is heard*).
- l. Turn the instrument OFF and remove the power cord.
- m. Replace the plug-in support assembly, top cover and terminal or terminal block assembly.
- n. Reconnect power and turn the instrument ON.

#### 5-19. CALIBRATION PROCEDURES - FRONT PANEL INPUTS

5-20. Calibration of the 3457A from the front input terminals consists of calibrating the offset and gain of each range for the DCV, 2-Wire Ohms, 4-Wire Ohms and DCI Functions and gain of each range for the ACV and ACI Functions. The FREQ Function is calibrated at one frequency.

**NOTE**

*The Preliminary Calibration Procedures should be completed before attempting the following procedures.*

#### 5-21. DC Volts Offset Calibration - Front Terminals

5-22. **Equipment Required.** A low thermal short (copper wire) is required for this procedure.

- a. Select the DC Voltage Function. (*Press the DCV function key*).
- b. Connect a short between the front panel HI and LO input terminals.
- c. Use the following procedure to calibrate the front terminal offset on the 30 mV, 300 mV, 3 V, 30 V and 300 V ranges beginning with the 300 V range and ending on the 30 mV range.
  - 1. Set the 3457A to the appropriate voltage range. (*Use the ↑ or ↓ scroll key to select the proper voltage range*).
  - 2. Access the Calibration Command. (*Press the Blue SHIFT key, then the OFFSET COMP / C configuration key*). The display will show CAL.
  - 3. Enter the value of the input; in this case 0. (*NOTE: If the security feature has not been disabled, (set to 0) it will be necessary to enter the input value, the delimiter ( , ) and the security code*).

4. Press the ENT key. The display will show CALIBRATING while the calibration routine is running.
- d. Repeat steps " c1 " through " c4 " for each of the remaining voltage ranges.
- e. Remove the short from the front panel HI and LO Input Terminals.

### 5-23. DC Volts Gain Calibration - Front Terminals

**5-24. Equipment Required.** A DC Voltage Source capable of providing 30 mV ( $\pm 0.055\%$ ), 300 mV ( $\pm 0.012\%$ ), 3 V ( $\pm 0.006\%$ ), 30 V ( $\pm 0.013\%$ ) and 300 V ( $\pm 0.017\%$ ) is required for the following procedure.

- a. Set the HP 3457A to the 300 volt range. (Use the  $\uparrow$  scroll key to select the 300 V range).
- b. Connect the Voltage Source to the HP 3457A front panel HI and LO input terminals and set its output to 300 V.
- c. Use the following steps to calibrate the DC Voltage Gain on the 300 V, 30 V, 3 V, 300 mV and 30 mV ranges beginning with the 300 V range and ending on the 30 mV range.
  1. Set the 3457A to the appropriate voltage range. (Use the  $\uparrow$  or  $\downarrow$  scroll key to select the proper voltage range).
  2. Set the voltage source to an output which will provide a full-scale reading on the HP 3457A.
  3. Access the Calibration Command. (Press the Blue SHIFT key, then the OFFSET COMP / C configuration key). The display will show CAL.
  4. Enter the value of the input voltage (in volts). (NOTE: If the security feature has not been disabled, (set to 0) it will be necessary to enter the input value, the delimiter ( , ) and the security code).
  5. Press the ENT key. The display will show CALIBRATING while the calibration routine is running.
- d. Repeat steps " c1 " through " c5 " for each of the remaining voltage ranges.
- e. Set the output of the Voltage Source to 3 volts.

### 5-25. DC Volts Linearity Calibration - Front Terminals

**5-26. Equipment Required.** A DC Voltage Source capable of providing 3 V ( $\pm 0.006\%$ ) is required to calibrate linearity of the DC Voltage Function.

- a. Set the HP 3457A to the 3 volt range.
- b. Set the Voltage Source for an output voltage of 3 Vdc.
- c. Reverse the leads at the 3457A input terminals to provide a negative input voltage.
- d. Access the Calibration Command. (Press the Blue SHIFT key then the OFFSET COMP / C configuration key). The display will will show CAL.



e. Enter the value of the input voltage (in volts), including the polarity. *(NOTE: If the security feature has not been disabled, (set to 0) it will be necessary to enter the input value, the delimiter ( , ) and the security code).*

f. Press the ENT key. The display will show CALIBRATING while the calibration routine is running.

g. Set the output of the Voltage Source to 0 V and disconnect it from the HP 3457A input terminals.

#### 5-27. Two-Wire Ohms Offset Calibration - Front Terminals

**5-28. Equipment Required.** A low thermal short (copper wire) is required for this procedure.

a. Select the 2-Wire Ohms Function. *(Press the OHM function key).*

b. Connect a short between the Front Panel HI and LO input terminals.

c. Use the following procedure to calibrate the front terminal offset on the 30 ohm, 300 ohm, 3 Kohm, 30 Kohm, 300 Kohm, 3 Mohm and 30 Mohm ranges beginning with the 30 Mohm range.

1. Set the 3457A to the appropriate resistance range. *(Use the ↑ or ↓ scroll key to select the proper range).*

2. Access the Calibration Command. *(Press the Blue SHIFT key, then the OFFSET COMP / C configuration key).* The display will show CAL.

3. Enter the value of the input resistance - in this case 0. *(NOTE: If the security feature has not been disabled, (set to 0) it will be necessary to enter the input value, the delimiter ( , ) and the security code).*

4. Press the ENT key. The display will show CALIBRATING while the calibration routine is running.

d. Repeat steps "c1" through "c4" for each of the remaining ranges.

e. Remove the short from the Front Panel HI and LO Input Terminals.

#### 5-29. Two-Wire Ohms Gain Calibration - Front Terminals

**5-30. Equipment Required.** Resistance Standards of 30 Ohms ( $\pm 2\%$ ), 300 Ohms ( $\pm 0.2\%$ ), 3 Kohms ( $\pm 0.03\%$ ), 30 Kohms ( $\pm 0.01\%$ ), 300 Kohms ( $\pm 0.01\%$ ), 3 Mohms ( $\pm 0.02\%$ ) and 30 Mohms ( $\pm 0.09\%$ ) are required to calibrate the 2-Wire Ohms Function.

a. Run the Ohms Auto-Calibration routine. *(Press the AUTO CAL configuration key, enter the number 3 and press the ENT key).*

b. Set the Resistance Standard to 30 MOhms and connect it to the HP 3457A front panel HI and LO input terminals.

c. Use the following procedure to calibrate the Gain on the 30 Mohm, 3 Mohm, 300 Kohm, 30 Kohm, 3 Kohm, 300 Ohm and 30 Ohm ranges beginning with the 30 Mohm range.

1. Set the 3457A to the appropriate Resistance range. *(Use the ↑ or ↓ scroll key to select the proper range).*

2. Set the resistance standard to the full-scale resistance of HP 3457A range selected.

3. Access the Calibration Command. (Press the Blue *SHIFT* key, then the *OFFSET COMP / C* configuration key). The display will show *CAL*.

4. Enter the value of the input resistance (in ohms). (NOTE: If the security feature has not been disabled (set to 0), it will be necessary to enter the input value, the delimiter ( , ) and the security code). 5. Press the *ENT* key. The display will show *CALIBRATING* while the calibration routine is running.

d. Repeat steps "c1" through "c5" for each of the remaining ranges.

e. Disconnect the resistance standard from the 3457A input terminals.

### 5-31. Four-Wire Ohms Offset Calibration - Front Terminals

5-32. Equipment Required. A low thermal short (copper wire) is required for this procedure. (Refer to Figure 5-1).

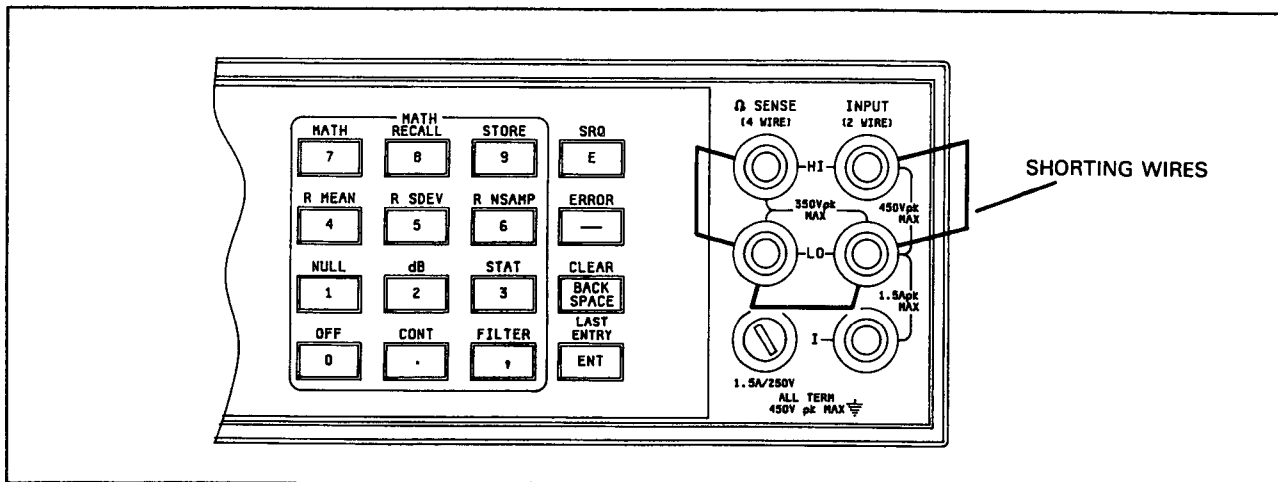

Figure 5-1. Input Connections for Four-Wire Ohms Offset Calibration

a. Select the 4-Wire Ohms Function. (Press the Blue *SHIFT* key, then the *OHM / OHMF* key).

b. Connect the short across the Front Panel HI and LO Input Terminals and the  $\Omega$  Sense HI and LO terminals as shown in Figure 5-1.

c. Use the following procedure to calibrate the front terminal offset on the 30 Mohm, 3 Mohm, 300 Kohm, 30 Kohm, 3 Kohm, 300 Ohm and 30 Ohm ranges beginning with the 30 Mohm range.

1. Set the 3457A to the appropriate resistance range. (Use the  $\uparrow$  or  $\downarrow$  scroll keys to select the proper range).

2. Access the Calibration Command. (Press the Blue *SHIFT* key, then the *OFFSET COMP / C* configuration key). The display will show *CAL*.

3. Enter the value of the input - in this case 0. (NOTE: If the security feature has not been disabled (set to 0), it will be necessary to enter the input value, the delimiter ( , ) and the security code).

4. Press the *ENT* key. The display will show *CALIBRATING* while the calibration routine is running.

- d. Repeat steps " c1 " through " c4 " for each of the remaining ranges.
- e. Remove the shorting wires from the Front Panel  $\Omega$  Source and Input terminals.

### 5-33. Four-Wire Ohms Gain Calibration - Front Terminals

**5-34. Equipment Required.** Resistance Standards capable of providing 30 Ohms ( $\pm 2\%$ ), 300 Ohms ( $\pm 0.2\%$ ), 3 Kohm ( $\pm 0.03\%$ ), 30 Kohms ( $\pm 0.01\%$ ), 300 Kohms ( $\pm 0.01\%$ ), 3 Mohms ( $\pm 0.002\%$ ) and 30 Mohms ( $\pm 0.009\%$ ) are required to calibrate the 4-Wire Ohms Function.

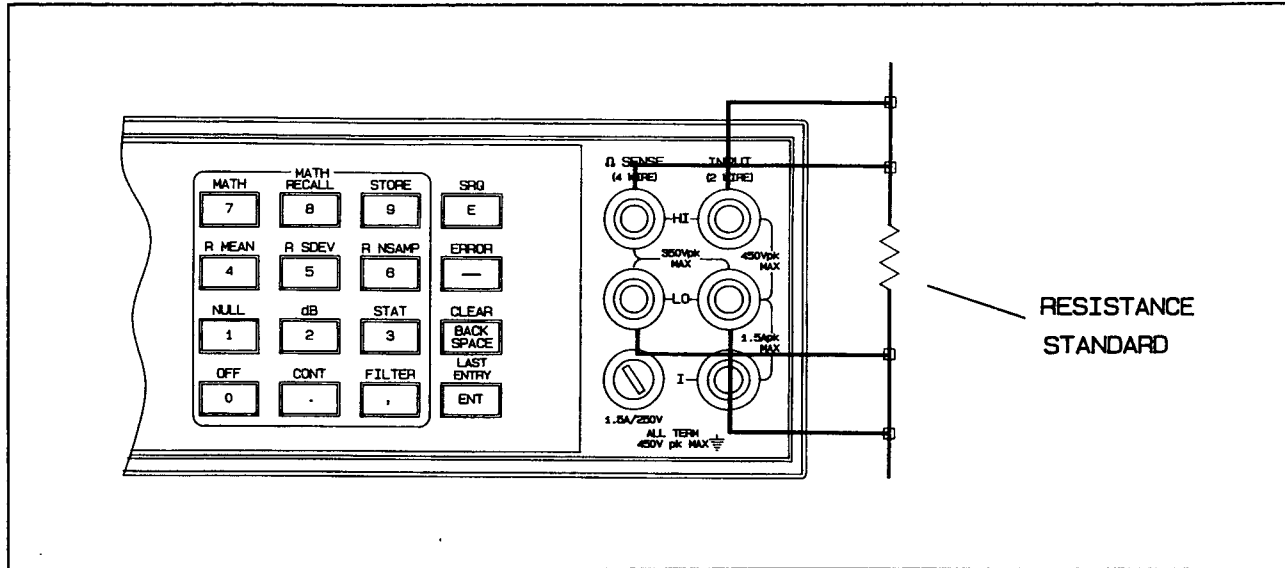

**Figure 5-2. Input Connections for 4-Wire Ohms Gain Calibration**

- a. Run the Ohms Auto-Calibration routine. (Press the *AUTO CAL* configuration key, enter the number 3 and press the *ENT* key).
- b. Set the Resistance Standard to 30 MOhms and connect it to the HP 3457A front panel HI and LO Input terminals and  $\Omega$  Sense HI and LO terminals as shown in Figure 5-2.
- c. Use the following procedure to calibrate the Gain on the 30 Mohm, 3 Mohm, 300 Kohm, 30 Kohm, 3 Kohm, 300 Ohm and 30 Ohm ranges beginning with the 30 Mohm range.
  1. Set the 3457A to the appropriate Resistance range. (Use the  $\uparrow$  or  $\downarrow$  scroll key to select the proper range).
  2. Set the resistance standard to the full-scale resistance of HP 3457A range selected.
  3. Access the Calibration Command. (Press the Blue *SHIFT* key, then the *OFFSET COMP / C* configuration key). The display will show *CAL*.
  4. Enter the value of the input resistance (in ohms). (NOTE: If the security feature has not been disabled (set to 0), it will be necessary to enter the input value, the delimiter ( , ) and the security code).
  5. Press the *ENT* key. The display will show *CALIBRATING* while the calibration routine is running.

- d. Repeat steps " c1 " through " c5 " for each of the remaining ranges.
- e. Disconnect the resistance standard from the 3457A input terminals.

### 5-35. DC Current Offset Calibration - Front Terminals

#### 5-36. Equipment Required. No equipment is needed for this procedure.

- a. Be certain all leads are disconnected from the HP 3457A input terminals.
- b. Select the DC Current Function. (*Press the DCI function key*).
- c. Use the following procedure to calibrate the front terminal offset on the 1 A, 300 mA, 30 mA, 3 mA and 300 uA ranges beginning with the 1 A range.
  1. Set the 3457A to the appropriate current range. (*Use the  $\uparrow$  or  $\downarrow$  scroll key to select the proper range*).
  2. Access the Calibration Command. (*Press the Blue SHIFT key, then the OFFSET COMP / C configuration key*). The display will show CAL.
  3. Enter the value of the input - in this case 0. (*NOTE: If the security feature has not been disabled (set to 0), it will be necessary to enter the input value, the delimiter ( , ) and the security code*).
  4. Press the ENT key. The display will show CALIBRATING while the calibration routine is running.
- d. Repeat steps " c1 " through " c4 " for each of the remaining ranges.

### 5-37. DC Current Gain Calibration - Front Terminals

#### 5-38. Equipment Required. A DC Current Source capable of providing 300 uA, 3 mA, 30 mA ( $\pm 0.007\%$ ), 300 mA ( $\pm 0.026\%$ ) and 1 A ( $\pm 0.04\%$ ) is required to calibrate the DC Current Function.

- a. Connect the Current Source to the HP 3457A front panel I and LO input terminals. Set the output of the Current Source to 1 A.
- b. Use the following procedure to calibrate the front terminal gain on the 1 A, 300 mA, 30 mA, 3 mA and 300 uA ranges beginning with the 1 A range.
  1. Set the 3457A to the appropriate current range. (*Use the  $\uparrow$  or  $\downarrow$  scroll key to select the proper range*).
  2. Set the current source to provide a full-scale reading on the HP 3457A range selected.
  3. Access the Calibration Command. (*Press the Blue SHIFT key, then the OFFSET COMP / C configuration key*). The display will show CAL.
  4. Enter the value of the input current (in amps). (*NOTE: If the security feature has not been disabled (set to 0), it will be necessary to enter the input value, the delimiter ( , ) and the security code*).
  5. Press the ENT key. The display will show CALIBRATING while the calibration routine is running.
- c. Repeat steps " b1 " through " b4 " for each of the remaining ranges.

**5-39. AC Volts Offset & Gain Calibration - Front Terminals**

**5-40. Equipment Required.** An AC Voltage Source capable of providing 30 mVrms, 300 mVrms, 1 Vrms, 2 Vrms, 3 Vrms, 30 Vrms and 300 Vrms ( $\pm 0.1\%$ ) at a frequency of 1 KHz is required to calibrate the AC Voltage Function.

- a. Select the AC Voltage function. *(Press the ACV function key).*
- b. Run the AC Auto-Calibration routine. *(Press the AUTO CAL configuration key, enter the number 2 and press the ENT key).*
- c. Set the AC Voltage Source to provide a 3 volt, 1 kHz signal and connect it to the front panel HI and LO input terminals.

**NOTE**

*The 3457A must be calibrated on the 3 volt range before calibrating the other ranges. This is because the offset constant for all ac voltage and ac current ranges is computed while calibrating the 3 Vac range.*

- d. Set the 3457A to the 3 volt range. *(Use the  $\uparrow$  or  $\downarrow$  scroll keys to select the proper range).*
- e. Use the following procedure to calibrate the Gain on the 30 mV, 300 mV, 3 V, 30 V and 300 V AC ranges beginning with the 3 V range.
  1. Set the 3457A to the appropriate voltage range. *(Use the  $\uparrow$  or  $\downarrow$  scroll key to select the proper range).*
  2. Set the output of the AC voltage source to provide a full-scale reading on the HP 3457A.
  3. Access the Calibration Command. *(Press the Blue SHIFT key, then the OFFSET COMP / C configuration key).* The display will show CAL.
  4. Enter the value of the input voltage (in volts). *(NOTE: If the security feature has not been disabled (set to 0), it will be necessary to enter the input value, the delimiter ( , ) and the security code).*
  5. Press the ENT key. The display will show CALIBRATING while the calibration routine is running.
- f. Repeat steps " e1 " through " e4 " for each of the remaining ranges.
- g. Set the output of the AC Voltage Source to 0 and disconnect it from HP the 3457A.

**5-41. AC Current Calibration - Front Terminals**

**5-42. Equipment Required.** An AC Current Source capable of providing 30 mA ( $\pm 14\%$ ), 300 mA ( $\pm 14\%$ ) and 1 A ( $\pm 24\%$ ) at a frequency of 1 KHz is required to calibrate the AC Current Function.

- a. Select the AC Current function. *(Press the ACI function key).*
- b. Set the AC Current Source to provide an output of 30 mA and connect it to the HP 3457A front panel I and LO input terminals.

c. Use the following procedure to calibrate the AC Current function on the 30 mA, 300 mA and 1 A ranges beginning with the 30 mA range.

1. Set the 3457A to the appropriate current range. (*Use the  $\uparrow$  or  $\downarrow$  scroll key to select the proper range.*)
2. Set the current source to provide a full-scale reading on the HP 3457A range selected.
3. Access the Calibration Command. (*Press the Blue SHIFT key, then the OFFSET COMP / C configuration key*). The display will show CAL.
4. Enter the value of the input current (in amps). (*NOTE: If the security feature has not been disabled (set to 0), it will be necessary to enter the input value, the delimiter ( , ) and the security code.*)
5. Press the ENT key. The display will show CALIBRATING while the calibration routine is running.

d. Repeat steps " c1 " through " c5 " for each of the remaining ranges.

e. Set the Current Source for an output of 0 and disconnect it from the HP 3457A.

#### 5-43. Frequency Calibration - Front Terminals

**5-44. Equipment Required.** A Frequency Generator capable of providing a single sine-wave signal between 100 Hz and 1 MHz with a frequency accuracy of  $\pm 0.003\%$  is required to calibrate the Frequency Function.

- a. Set the 3457A to the Frequency function. (*Press the FREQ function key*).
- b. Set the Frequency Source to a known frequency between 100 Hz and 1 MHz and connect it to the HP 3457A front panel HI and LO input terminals.
- c. Access the Calibration command. (*Press the Blue SHIFT key, then the OFFSET COMP / C configuration key*). The display will show CAL.
- d. Enter the value of the input frequency (in hertz). (*NOTE: If the security feature has not been disabled (set to 0), it will be necessary to enter the input frequency, the delimiter ( , ) and the security code.*)
- e. Press the ENT key. The display will show CALIBRATING while the calibration routine is running.
- f. Disconnect the Frequency Source from the HP 3457A.

#### 5-45. CALIBRATION PROCEDURES - REAR PANEL INPUTS

5-46. The following paragraphs describe the calibration process for the HP 3457A rear panel inputs. Separate procedures are provided for the standard instrument (Rear Input Terminals), and instruments equipped with optional plug-in assemblies 44491A (General Purpose Relay Assembly) and 44492A (Reed Relay Multiplex Assembly). Select the procedure which applies to your instrument.

#### 5-47. DC Volts Offset Calibration - Rear Terminals (Standard Instrument)

**5-48. Equipment Required.** A low thermal short (copper wire) is required for this procedure.

- a. Short the  $\Omega$  SENSE HI and LO and INPUT HI and LO rear input terminals together.

- b. Select the rear input terminals. *(Press the TERM configuration key, enter the number 2 and press the ENT key).*
- c. Select the DC Voltage function. *(Press the DCV function key).*
- d. Use the following procedure to calibrate the rear terminal offset on the 300 V, 30 V, 3 V, 300 mV, and 30 mV ranges beginning with the 300 V range.
  1. Set the 3457A to the appropriate voltage range. *(Use the ↑ or ↓ scroll key to select the proper voltage range).*
  2. Access the Calibration command. *(Press the Blue SHIFT key, then the OFFSET COMP / C configuration key).* The display will show CAL.
  3. Enter the value of the input - in this case 0. *(NOTE: If the security feature has not been disabled (set to 0), it will be necessary to enter the input value, the delimiter ( , ) and the security code).*
  4. Press the ENT key. The display will show CALIBRATING while the calibration routine is running.
- e. Repeat steps " d1 " through " d4 " for each of the remaining voltage ranges.

#### **5-49. Two-Wire Ohms Offset Calibration - Rear Terminals (Standard Instrument)**

#### **5-50. Equipment Required.** A low thermal short is required for this procedure.

- a. Short the  $\Omega$  SENSE HI and LO and INPUT HI and LO rear input terminals together.
- b. Select the rear input terminals. *(Press the TERM configuration key, enter the number 2 and press the ENT key).*
- c. Select the 2-Wire Ohms function. *(Press the OHM function key).*
- d. Use the following procedure to calibrate the rear terminal offset on the 30 Mohm, 3 Mohm, 300 Kohm, 30 Kohm, 3 Kohm, 300 Ohm and 30 Ohm ranges beginning with the 30 Mohm range.
  1. Set the 3457A to the appropriate resistance range. *(Use the ↑ or ↓ scroll key to select the proper range).*
  2. Access the Calibration command. *(Press the Blue SHIFT key, then the OFFSET COMP / C configuration key).* The display will show CAL.
  3. Enter the value of the input; in this case 0. *(NOTE: If the security feature has not been disabled (set to 0), it will be necessary to enter the input value, the delimiter ( , ) and the security code).*
  4. Press the ENT key. The display will show CALIBRATING while the calibration routine is running.
- e. Repeat steps " d1 " through " d4 " for each of the remaining ranges.

**5-51. Four-Wire Ohms Offset Calibration - Rear Terminals (Standard Instrument)**

**5-52. Equipment Required.** A low thermal short (copper wire) is required for this procedure.

- a. Short the → SENSE HI and LO and INPUT HI and LO rear input terminals together.
- b. Select the rear input terminals. *(Press the TERM configuration key, enter the number 2 and press the ENT key).*
- c. Select the 4-Wire Ohms function. *(Press the Blue SHIFT key, then the OHM / OHMF function key).*
- d. Use the following procedure to calibrate the rear terminal offset on the 30 Mohm, 3 Mohm, 300 Kohm, 30 Kohm, 3 Kohm, 300 Ohm and 30 Ohm ranges beginning with the 30 Mohm range.
  1. Set the 3457A to the appropriate resistance range. *(Use the ↑ or ↓ scroll key to select the proper range).*
  2. Access the Calibration command. *(Press the Blue SHIFT key, then the OFFSET COMP / C configuration key).* The display will show CAL.
  3. Enter the value of the input - in this case 0. *(NOTE: If the security feature has not been disabled (set to 0), it will be necessary to enter the input value, the delimiter ( , ) and the security code).*
  4. Press the ENT key. The display will show CALIBRATING while the calibration routine is running.
- e. Repeat steps " d1 " through " d4 " for each of the remaining ranges.

**5-53. DC Current Offset Calibration - Rear Terminals (Standard Instrument)**

**5-54. Equipment Required.** No equipment is needed for this procedure.

- a. Select the rear input terminals. *(Press the TERM configuration key, enter the number 2 and press the ENT key).*
- b. Select the DC Current function. *(Press the DCI function key).*
- c. Use the following procedure to calibrate the rear terminal offset on the 300 uA, 3 mA, 30 mA, 300 mA, and 3 A ranges beginning with the 3 A range.
  1. Set the 3457A to the appropriate current range. *(Use the ↑ or ↓ scroll key to select the proper range).*
  2. Access the Calibration command. *(Press the Blue SHIFT key, then the OFFSET COMP / C configuration key).* The display will show CAL.
  3. Enter the value of the input - in this case 0. *(NOTE: If the security feature has not been disabled (set to 0), it will be necessary to enter the input value, the delimiter ( , ) and the security code).*
  4. Press the ENT key. The display will show CALIBRATING while the calibration routine is running.
- d. Repeat steps " c1 " through " c4 " for each of the remaining ranges.



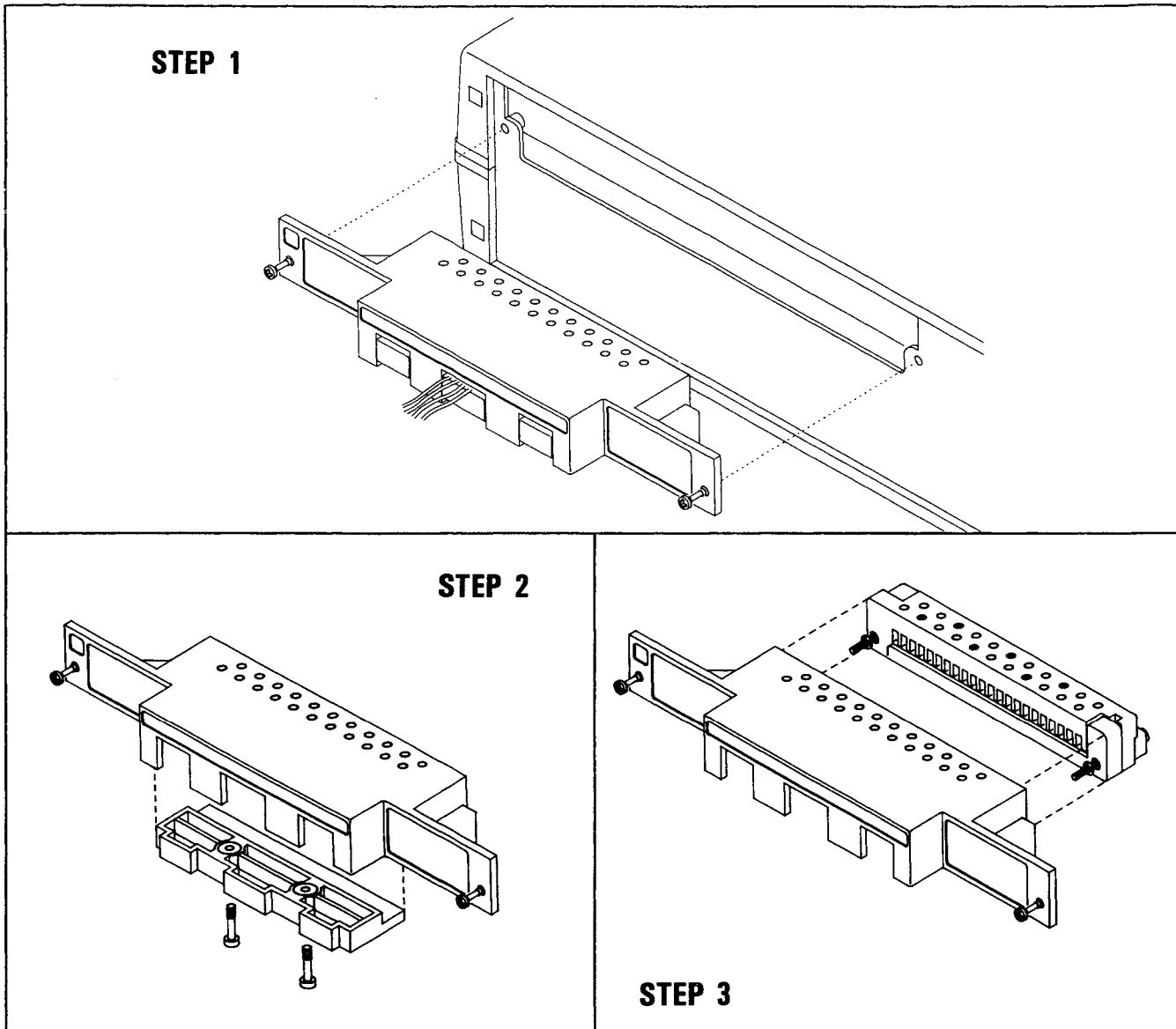

Figure 5-3. Terminal Block Removal

#### 5-55. CALIBRATION PROCEDURES - HP 44491A GENERAL PURPOSE RELAY ASSEMBLY

#### 5-56. Wiring Block Preparation

5-57. It will be necessary to connect shorting wires to the Plug-In Assembly Wiring Block before calibration can be performed. The following procedures outline the wiring block preparation.

### WARNING

*This procedure assumes that the Wiring Block is new and has no wires connected to it. If the Wiring Block is connected to an external device, hazardous voltages may be exposed when the Strain Relief/Wiring Block Assembly is removed.*

- a. Remove the two screws attaching the Strain Relief/Wiring Block Assembly to the rear panel and disconnect it from the instrument. (Refer to Figure 5-3, Step 1).
- b. Remove the Strain Relief Plate from the bottom of the Strain Relief Assembly (Figure 5-3, Step 2).
- c. Remove the Wiring Block from the Strain Relief Housing (Figure 5-3, Step 3).
- d. Install copper shorting wires from INput HI to INput LO, from INput HI to  $\Omega$  Sense HI, and from INput LO to  $\Omega$  Sense LO on 4-Wire  $\Omega$  input channel 10. Securely tighten the appropriate retaining screws. (Refer to Figure 5-4 for wire connections).
- e. Connect the prepared Wiring Block Assembly to the HP 44491A General Purpose Relay Assembly.

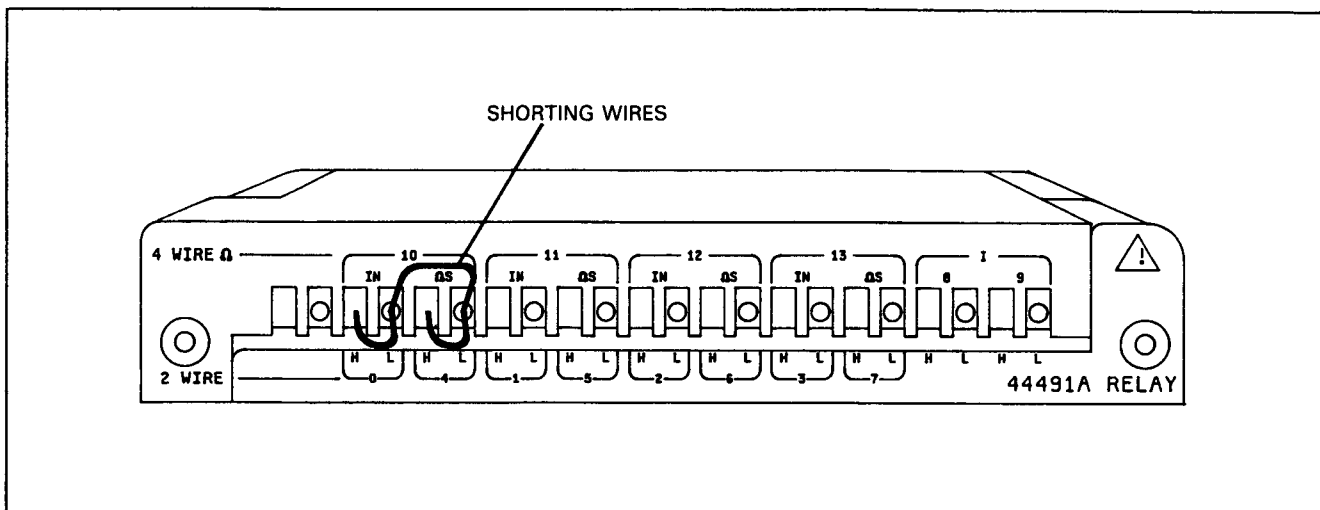

Figure 5-4. 44491A Wiring Block Connections

#### 5-58. DC Volts Offset Calibration - HP 44491A

- a. Select the DC Voltage function. (Press the DCV function key).
- b. Select the Scanner Input. (Press the TERM configuration key, enter the number 2 and press the ENT key).
- c. Select channel 0. (Press the CHAN configuration key, enter the number 0 and press the ENT key).
- d. Use the following procedure to calibrate the DC offset on the 300 V, 30 V, 3 V, 300 mV and 30 mV ranges beginning with the 300 V range.
  1. Set the 3457A to the appropriate range. (Use the  $\uparrow$  or  $\downarrow$  scroll keys to select the proper range).
  2. Access the Calibration Command. (Press the Blue SHIFT key, then the OFFSET COMP / C configuration key). The display will show CAL.
  3. Enter the value of the input - in this case 0. (NOTE: If the security feature has not been disabled (set to 0), it will be necessary to enter the input value, the delimiter ( , ) and the security code).
  4. Press the ENT key. The display will show CALIBRATING while the calibration routine is running.

e. Repeat steps " d1 " through " d4 " for each of the remaining ranges.

#### 5-59. Two-Wire Ohms Offset Calibration - HP 44491A

a. Select the 2-Wire Ohms function. *(Press the OHM function key).*

b. Close channel 0. *(Press the CHAN configuration key, enter the number 0 and press the ENT key).*

c. Use the following procedure to calibrate the 2-wire ohm offset on the 30 Mohm, 3 Mohm, 300 Kohm, 30 Kohm, 3 Kohm, 300 Ohm and 30 Ohm ranges beginning with the 30 Mohm range.

1. Set the 3457A to the appropriate resistance range. *(Use the ↑ or ↓ scroll keys to select the proper range).*

2. Access the Calibration Command. *(Press the Blue SHIFT key, then the OFFSET COMP / C configuration key).* The display will show CAL.

3. Enter the value of the input - in this case 0. *(NOTE: If the security feature has not been disabled (set to 0), it will be necessary to enter the input value, the delimiter ( , ) and the security code).*

4. Press the ENT key. The display will show CALIBRATING while the calibration routine is running.

d. Repeat steps " c1 " through " c4 " for each of the remaining ranges.

#### 5-60. Four-Wire Ohms Offset Calibration - HP 44491A

a. Select the 4-Wire Ohms function. *(Press the Blue SHIFT key then the OHM / OHMF function key).*

b. Close channel 10. *(Press the CHAN configuration key, enter the number 10 and press the ENT key).*

c. Use the following procedure to calibrate the 4-Wire ohm offset on the 30 Mohm, 3 Mohm, 300 Kohm, 30 Kohm, 3 Kohm, 300 Ohm and 30 Ohm ranges beginning with the 30 Mohm range.

1. Set the 3457A to the appropriate resistance range. *(Use the ↑ or ↓ scroll keys to select the proper range).*

2. Access the Calibration Command. *(Press the Blue SHIFT key, then the OFFSET COMP / C configuration key).* The display will show CAL.

3. Enter the value of the input - in this case 0. *(NOTE: If the security feature has not been disabled (set to 0), it will be necessary to enter the input value, the delimiter ( , ) and the security code).*

4. Press the ENT key. The display will show CALIBRATING while the calibration routine is running.

d. Repeat steps " c1 " through " c4 " for each of the remaining ranges.

#### 5-61. DC Current Offset Calibration - HP 44491A

a. Select the DC Current function. *(Press the DCI function key.)*

b. Select the Scanner Input. *(Press the TERM configuration key, enter the number 2, and press the ENT key.)*

c. Use the following procedures to calibrate the DC Current offset on the 300  $\mu$ A, 3 mA, 30 mA, 300 mA and 3 A ranges beginning with the 3 A range.

1. Set the 3457A to the appropriate current range. (Use the  $\uparrow$  or  $\downarrow$  scroll key to select the proper range.)
2. Access the Calibration Command. (Press the Blue **SHIFT** key, then the **OFFSET COMP / C** configuration key.) The display will show **CAL**.
3. Enter the value of the input - in this case 0. (NOTE: If the security feature has not been disabled (set to 0), it will be necessary to enter the input value, the delimiter ( , ) and the security code.)
4. Press the **ENT** key. The display will show **CALIBRATING** while the calibration routine is running.

e. Repeat steps "c1" through "c4" for each of the remaining ranges.

## 5-62. CALIBRATION PROCEDURES - HP 44492A 10 CHANNEL MULTIPLEXER ASSEMBLY

### 5-63. Wiring Block Preparation

5-64. It will be necessary to connect a shorting wire to the Plug-In Assembly Wiring Block before calibration can be performed. The following procedure outlines the wiring block preparation.

### WARNING

*This procedure assumes that the Wiring Block is new and has no wires connected to it. If the Wiring Block is connected to an external device, hazardous voltages may be exposed when the Strain Relief/Wiring Block Assembly is removed.*

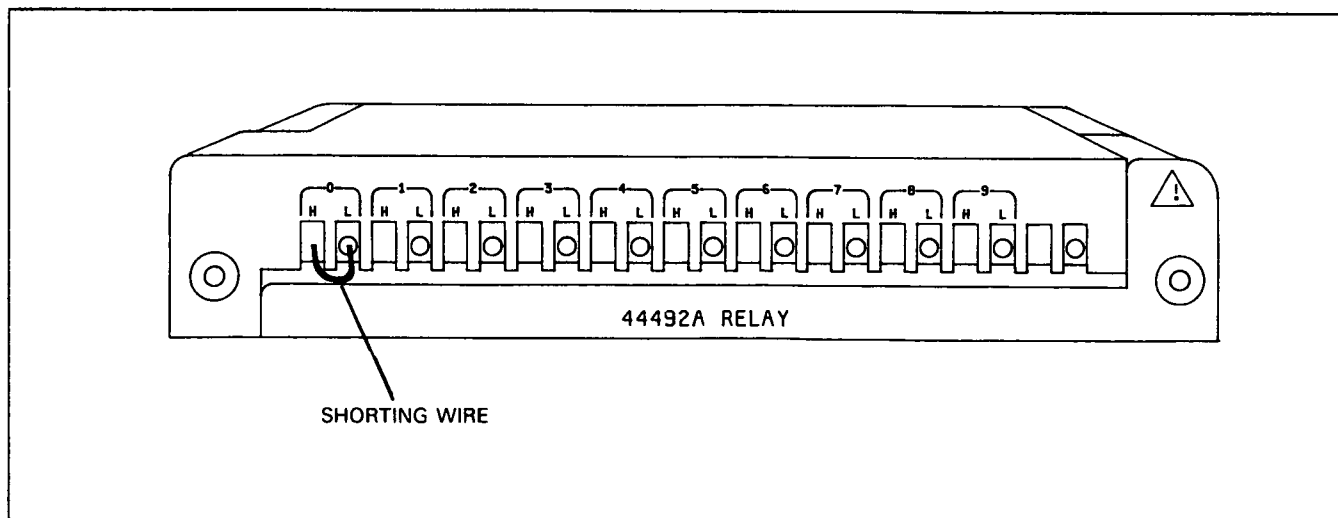

**Figure 5-5. 44492A Wiring Block Connections**

- a. Remove the two screws attaching the Strain Relief/Wiring Block Assembly to the rear panel and disconnect it from the instrument. (Refer to Figure 5-3, Step 1).
- b. Remove the Strain Relief Plate from the bottom of the Strain Relief Assembly (Figure 5-3, Step 2).

- c. Remove the Wiring Block from the Strain Relief Housing (Figure 5-3, Step 3).
- d. Install a copper shorting wire between the H and L inputs of channel 0. Tighten the two retaining screws. (Refer to Figure 5-5 for wire connection).
- e. Connect the prepared Wiring Block Assembly to the HP 44492A 10 Channel Multiplexer Assembly.

#### 5-65. DC Volts Offset Calibration - HP 44492A

- a. Select the DC Voltage function. *(Press the DCV function key).*
- b. Select the Scanner Input. *(Press the TERM configuration key, enter the number 2 and press the ENT key).*
- c. Select channel 0. *(Press the CHAN configuration key, enter the number 0 and press the ENT key).*
- d. Use the following procedure to calibrate the DC offset on the 300 V, 30 V, 3 V, 300 mV and 30 mV ranges beginning with the 300 V range.
  1. Set the 3457A to the appropriate range. *(Use the ↑ or ↓ scroll keys to select the proper range).*
  2. Access the Calibration Command. *(Press the Blue SHIFT key, then the OFFSET COMP / C configuration key).* The display will show CAL.
  3. Enter the value of the input - in this case 0. *(NOTE: If the security feature has not been disabled (set to 0), it will be necessary to enter the input value, the delimiter ( , ) and the security code).*
  4. Press the ENT key. The display will show CALIBRATING while the calibration routine is running.
- e. Repeat steps " d1 " through " d4 " for each of the remaining ranges.

#### 5-64. Two-Wire Ohms Offset Calibration - HP 44492A

- a. Select the 2-Wire Ohms function. *(Press the OHM function key).*
- b. Close channel 0. *(Press the CHAN configuration key, enter the number 0 and press the ENT key).*
- c. Use the following procedure to calibrate the 2-wire ohm offset on the 30 Mohm, 3 Mohm, 300 Kohm, 30 Kohm, 3 Kohm and 300 Ohm ranges beginning with the 30 Mohm range.
  1. Set the 3457A to the appropriate resistance range. *(Use the ↑ or ↓ scroll keys to select the proper range).*
  2. Access the Calibration Command. *(Press the Blue SHIFT key, then the OFFSET COMP / C configuration key).* The display will show CAL.
  3. Enter the value of the input - in this case 0. *(NOTE: If the security feature has not been disabled (set to 0), it will be necessary to enter the input value, the delimiter ( , ) and the security code).*
  4. Press the ENT key. The display will show CALIBRATING while the calibration routine is running.
- d. Repeat steps " c1 " through " c4 " for each of the remaining ranges.