























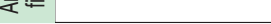









AC/DC Power Supply Photo Sensors

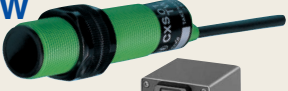

- NAL series
- NE series
- NA series
- J series
- CX-TW series
- GM series

AC/DC Power Supply Photo Sensors

List of models

Type	Series/Appearance (Typical Example)	Detection method	Model	Detecting distance	See page ...
Polarized	NAL 	Polarization reflector type	NAL-M10RP	 0.5-10m	388
Compact	NE  (Connector types available)	Through-beam type	NE-T10RD	 10m	392
			NE-T10R	 10m	
			NE-T30D	 30m	
		Polarization reflector type	NE-M5RD	 0.03-5m	
			NE-M5R	 0.03-5m	
		Diffuse-reflector type	NE-R10D	 1m	
Fully open terminal block	NA 	Through-beam type	NA-T20R	 20m	396
			NA-T20RF	 20m	
			NA-T20RA	 10m Anti interference filter integrated	
			NA-T20RB		
			NA-T20RFA		
			NA-T20RFB	 10m	
		NA-T30	 30m		
		NA-T30F	 30m		
		Polarization reflector type	NA-M7R	 0.03-7m	
			NA-M7RF		
Diffuse-reflector type	NA-R10	 1m			
	NA-R10F				
Quick replacement	J 	Through-beam type	JT10R	 10m	400
			JT10R-SR		
		Polarization reflector type	JRM3R	 0.03-3m	
			JRM3R-SR		
		Diffuse-reflector type	JR07	 700mm	
			JR07-SR		
		Through-beam type	JT10RF	 10m Timer feature provided	
			JT10RF-SR		
Polarization reflector type	JRM3RF	 0.03-3m			
	JRM3RF-SR				
Diffuse-reflector type	JR07F	 700mm			
	JR07F-SR				
Twin-wired	CX-TW 	Polarization reflector type	CXM1RDTW	 1m	404
		Reflector type	CXM2DTW	 2m	
		Diffuse-reflector type	CXS01TW	 100mm	
Die-cast case	GM 	Through-beam type	GM30	 30m	406
			GM10	 10m	
		Reflector type	GM5	 5m (With K-6 reflector)	
		Diffuse-reflector type	GM05	 500mm	

AC/DC Power Supply Photo Sensors

Applications

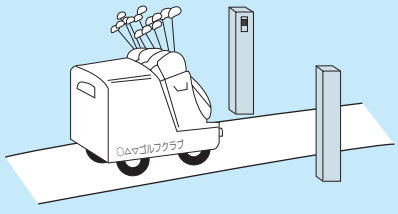
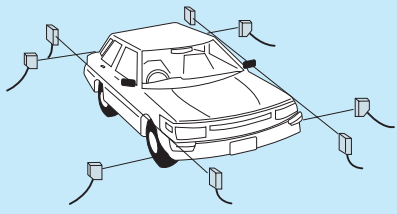
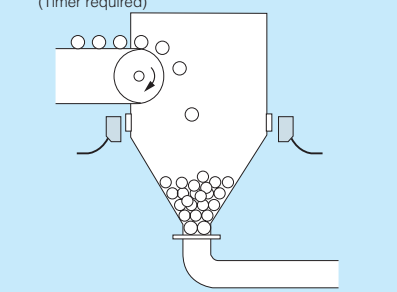
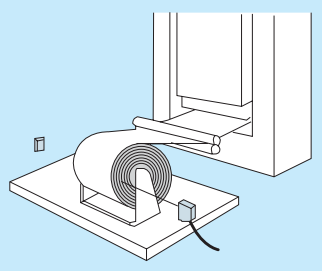
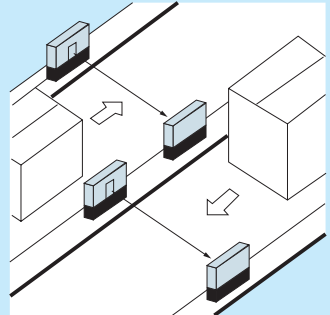
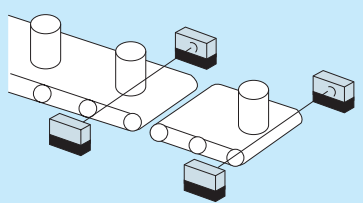
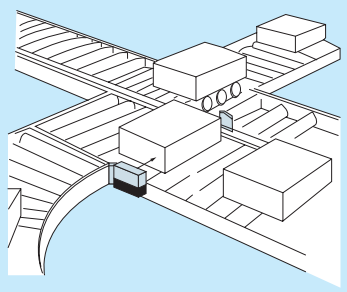
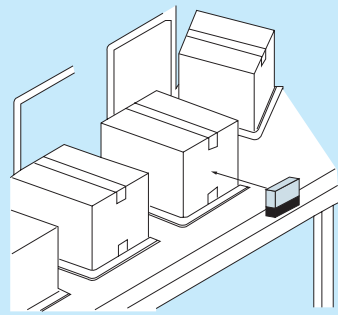
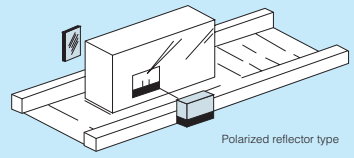
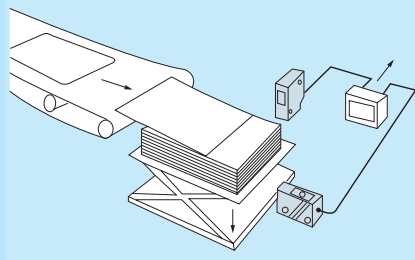
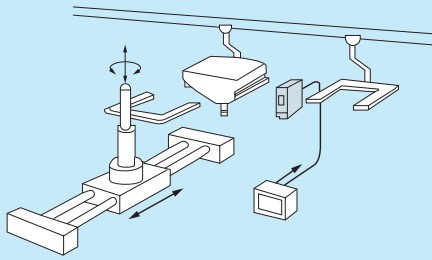
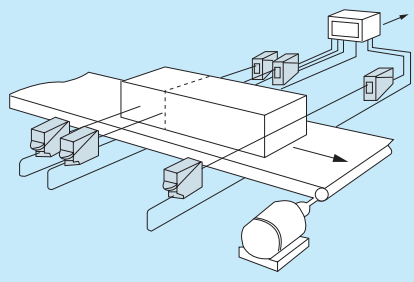
<ul style="list-style-type: none"> • Sensor for stopping carts 	<ul style="list-style-type: none"> • Detecting position of vehicle in multilevel parking garage 	<ul style="list-style-type: none"> • Detecting level of material in hopper <p>(Timer required)</p> 
<ul style="list-style-type: none"> • Detecting of remaining amount of coiled material 	<ul style="list-style-type: none"> • Detecting passage of objects on narrow conveyor 	<ul style="list-style-type: none"> • Detecting comparatively large objects 
<ul style="list-style-type: none"> • Automatic sorting on shipping line 	<ul style="list-style-type: none"> • Detecting cartons with diffuse-reflective type sensor 	<ul style="list-style-type: none"> • Detecting mirror-like objects <p>Polarized reflector type</p> 
<ul style="list-style-type: none"> • Detecting height of board-shaped objects on lift 	<ul style="list-style-type: none"> • Detecting objects on conveyor hangers 	<ul style="list-style-type: none"> • Sorting by length 

NAL-M10R

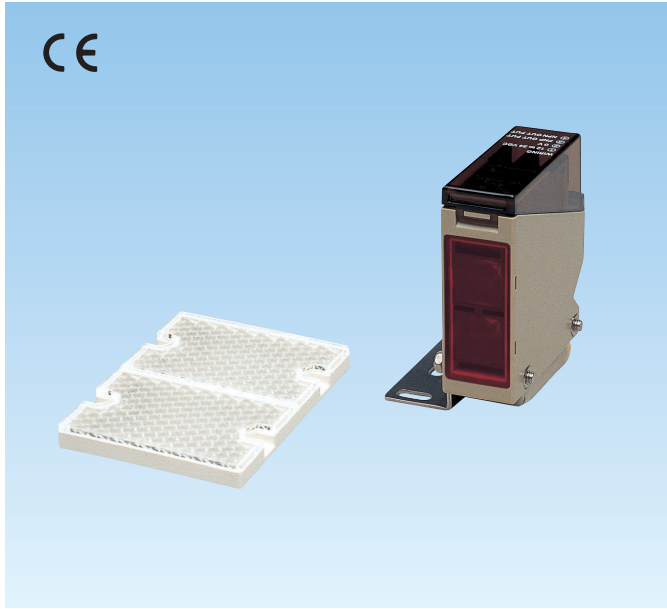

Long-range polarization reflector type
photo sensor

CE



- Long detecting distance of 10 m achieved with reflector type
- Mirror-like objects stably detected
- Single unit simplified wiring
- Stable operation can be checked at a glance with stability indicator

Type

Type	Detecting distance	Model	Operation mode	Output mode	Power supply
 Polarization reflector type	 0.5-10m	NAL-M10RP	Light-ON/Dark-ON selectable (with switch)	Relay output 1a	24-240V AC/DC

- Long detecting distance of 10 m ideal for detecting large objects and for use on large conveyors
- Reflector type requires wiring of only one unit, simplifying wiring and reducing cost

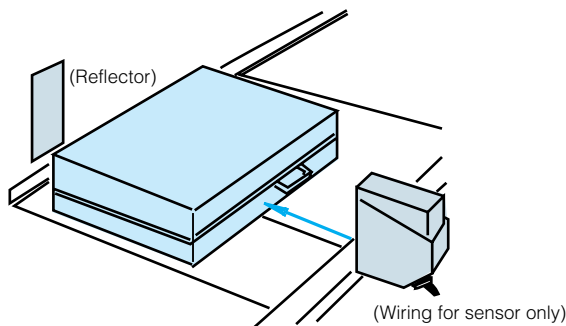
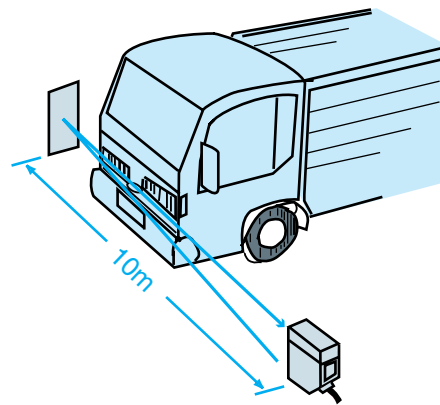

- Polarization reflector type for stable detection of glossy objects
- Detecting condition can be checked at a glance with stability indicator

NAL-M10R

Rating/Performance/Specification

Model		NAL-M10RP	
Rating/performance	Detection method	Polarization reflector type	
	Detecting distance	0.5-10m	
	Detection object	Mirror-like objects, opaque objects	
	Power supply	24-240V AC/DC $\pm 10\%$ 50/ 60Hz	
	Power consumption	2W max.	
	Output mode	Relay output 1a / Rating: 3 A (250 VAC max. resistance load) (30 VDC max. resistance load)	
	Operation mode	Light-ON/Dark-ON selectable	
	Response time	15 ms or less	
	Operating angle	30°	
	Specification	Light source	Red LED (670nm)
		Indicator	Operation indicator: orange LED Stability indicator: green LED
Switch		Light-ON/Dark-ON selector switch	
Material		Case	Polycarbonate
		Lens	Acrylic
		Terminal cover	Polycarbonate
		Mounting bracket	Stainless steel (SUS304)
Wiring		Terminal block (with M3.5 screws)	
Mass	200 g max. (including mounting bracket)		

*1 With reflector model K-77 (accessory)

Environmental Specification

Environment		
Environment	Ambient light	Sunlight: illumination on light receiving surface 10,000 lx max.
		Incandescent lamp: illumination on light receiving surface 3,000 lx max.
	Ambient temperature	-25 - +55 °C (non-freezing)
	Ambient humidity	35-85%RH (non-condensing)
	Protective structure	IP67
	Vibration	10-55 Hz / 1.5 mm amplitude / 2 hours each in 3 directions
	Shock	500 m/s ² / 3 times each in 3 directions
	Dielectric withstanding	2,000 VAC for 1 minute
Insulation resistance	500 VDC, 100 MΩ or higher	

Input/Output Circuit and Connection

- Relay output type

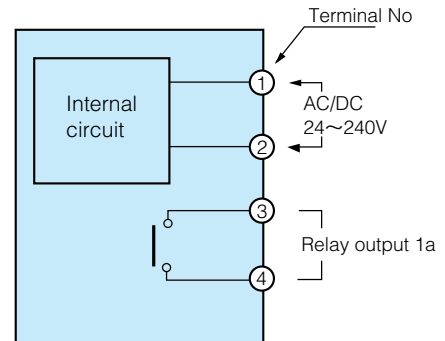

Directional Characteristics (Typical Example)

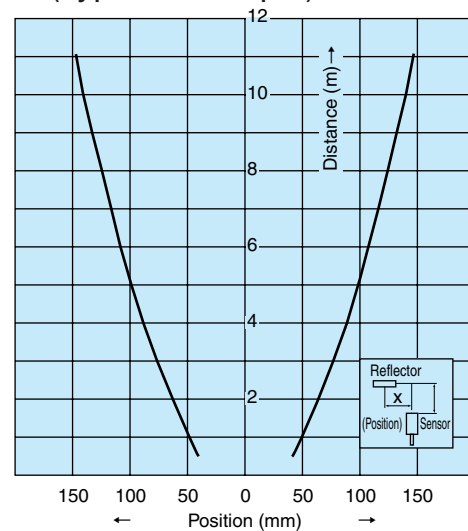

NAL-M10R

For Correct Use

Panel layout

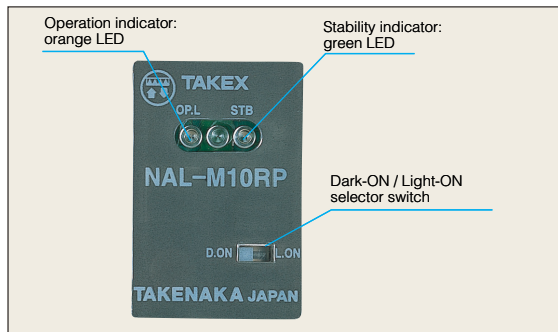

◆ Operation indicator (O.P)

The orange LED is illuminated to indicate operation

◆ Stability indicator (STB)

The green LED is illuminated when the received light intensity level is in a range that allows stable activation (120% or higher of the activation level) or stable deactivation (80% or lower of the activation level).

◆ D.ON/L.ON selector switch

[D.ON] output activated when light is blocked
[L.ON] output activated when light is received

Indicators

- The operation indicator (orange LED) and stability indicator (green LED) respectively show different received light intensity levels as described in the figure below.

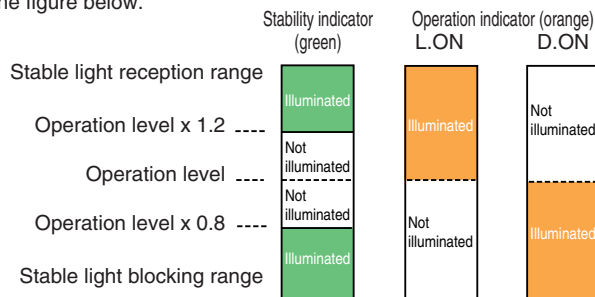

- After aligning the optical axis, use a detection object to block and unblock the light beam several times to make sure that the sensitivity level is in a range that allows stable activation and deactivation.
- Setting the sensitivity in a range allowing stable operation achieves higher reliability against changes in the operating environment generated after the sensitivity is set.

Detecting distances for different reflectors

The detecting distance depends on the reflector used.

Reflector model	K-77	K-7	K-71	S-510G
Detecting distance	0.5~10m	0.5~7.5m	0.5~4m	0.5~6m
Remarks	Accessory	Optional	Optional	Optional



- Do not use the sensor for protection of human body.
- For safety applications, ensure safe operation of the detection and control system overall.
- This product is not explosion proof.

NAL-M10R

Dimensions (in mm)

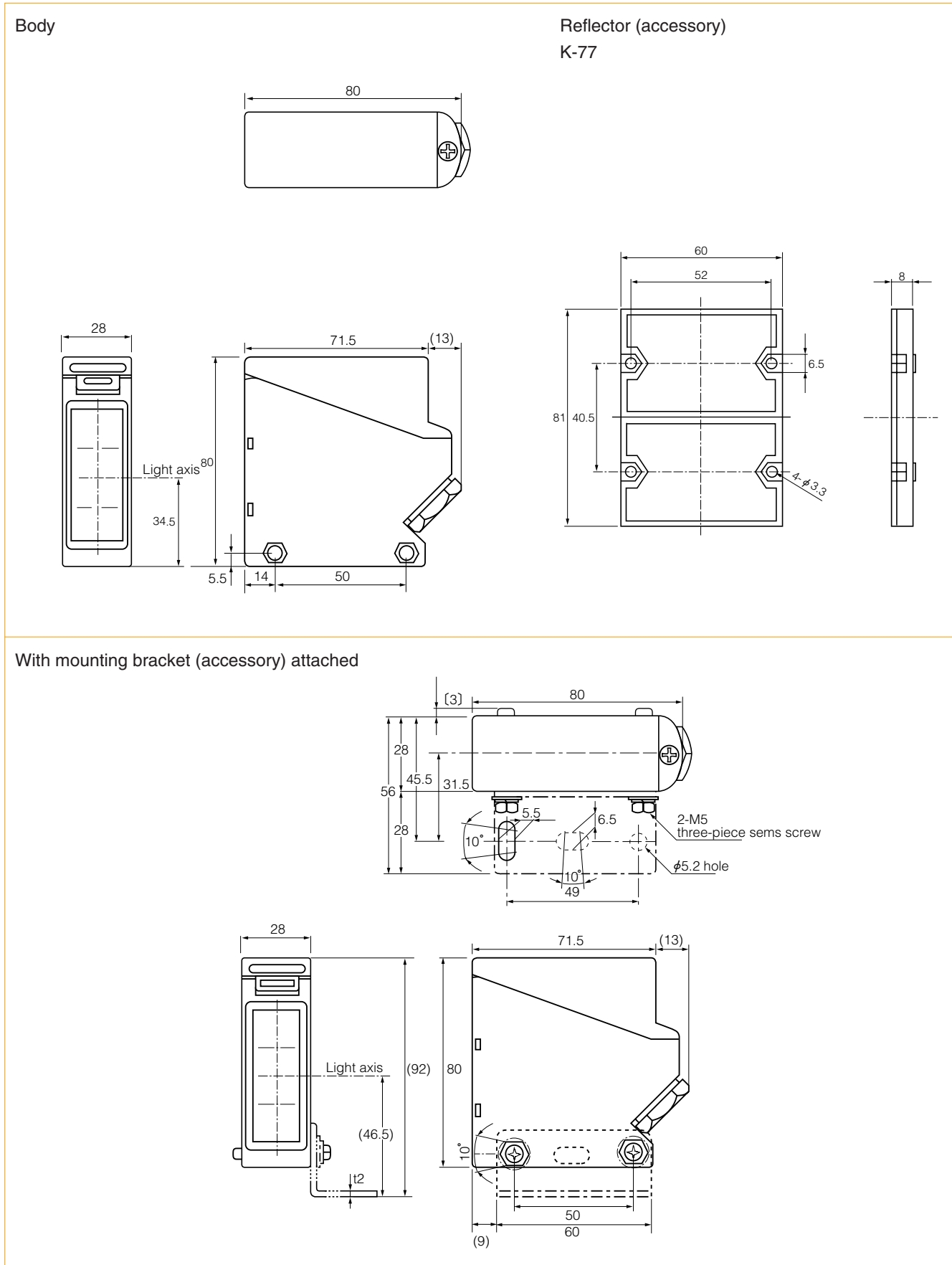



- Ultimate simplicity
- Smallest of all AC/DC power supply models (18 x 55 x 35 mm)
 - Longest-in-class detecting distance for accurate detection
 - Polarization reflector type allows stable detection of mirror-like objects
 - Red LED for easy adjustment (through-beam type, polarization reflector type)
 - Dramatically improved stability with original photo IC
 - Capable of adjacent installation with polarization filter (optional) (through-beam type)

Type

Type	Detecting distance	Model		Output mode	Remarks
		Dark-ON mode	Light-ON mode		
Through-beam type	10m	NE-T10RD	NE-T10R	Relay output 1c (Sensors with high-speed, long-life photo-MOS relay are available on request. Contact Takex for details.)	“-J” indicates models with permanently attached cord with connector.
		NE-T10RD-J	NE-T10R-J		
	30m	NE-T30D	NE-T30		
		NE-T30D-J	NE-T30-J		
Polarization reflector type	0.03-5m	NE-M5RD	NE-M5R		
		NE-M5RD-J	NE-M5R-J		
Diffuse-reflector type	1m	NE-R10D	NE-R10		
		NE-R10D-J	NE-R10-J		

Optional Parts

Type	Model	Applicable model	Description		
Pinhole plate	NE-P3	NE-T10R (D) NE-T30 (D)	Hole diameter $\phi 3$	For detecting distance with plate attached, see p. 394.	Two plates required for attaching to both transmitter and receiver.
	NE-P5		Hole diameter $\phi 5$		
	NE-P5 × 1		Hole diameter 5 × 1 mm		
Reflector	K-71	NE-M5R (D)	Detecting distance: 0.03-2m		
	S-510G		Detecting distance : 0.1-3m		
Anti interference filter	NE-PFA	NE-T10R (D)	Longitudinal polarization filter		
	NE-PFB		Horizontal polarization filter		
Mounting bracket	NE-B1	All models	Vertical mounting		
	NE-B2		Back-to-back mounting		
Cord with connector	FAC-A2R2	NE-TL10R	Cord for sensor with permanently attached cord	For transmitter of through-beam type	2m
	FAC-A2R5	NE-TL30			5m
	FAC-A4R2	NE-TR10R (D)	For receiver of through-beam type, polarization reflector type, diffuse-reflective type	2m	
	FAC-A4R5	NE-TR30 (D) NE-M5R (D) NE-R10		5m	

Rating/Performance/Specification

Model	NE-T10RD	NE-T30D	NE-M5RD	NE-R10
Detection method	Through-beam type		Polarization reflector type	Diffuse-reflector type
Detecting distance	10m max.	30m max.	0.03-5m max.	1m max.
Detection object	Opaque object of ϕ 20 min.		Mirror-like objects, opaque objects	Opaque objects, translucent objects
Power supply	AC/DC24-240V \pm 10% 50/60Hz			
Power consumption	Transmitter: 1.5 W max. Receiver: 2 W max.	Transmitter: 1.8 W max. Receiver: 2 W max.	2 W max.	
Output mode	Relay output 1a / Rating: 1 A (250 VAC max. resistance load 30 VDC max. resistance load) (*2) (*5)			
Operation mode	Dark-ON (*3)			Light-ON (*4)
Response time	5ms max.			
Hysteresis	—			10% max.
Operating angle	3% (at receiver)	5% (at receiver)	30° (reflector)	—
Light source (wavelength)	Red LED (700 nm)	Infrared LED (880 nm)	Red LED (700 nm)	Infrared LED (880 nm)
Indicator	(Receiver) Operation indicator (red LED) / Stability indicator: green LED		Operation indicator (red LED) Stability indicator: green LED	
Volume (VR)	—		Sensitivity adjustment provided	
Material	Lens: acrylic / Case: heat-resistant ABS			
Connection (*5)	Permanently attached cord (Outer dimension: dia.6) Transmitter: 0.3 mm ² x 2 cores, 2 m, gray Receiver: 0.3 mm ² x 5cores, 2 m, black		Permanently attached cord (Outer dimension: dia.6) 0.3 mm ² x 5 cores, 2 m, black	
Mass	Transmitter: 150 g max. / Receiver: 150 g max.		150g max.	
Notes	<ul style="list-style-type: none"> Sensors with sensitivity adjustment provided for receivers are available on request. <p>(*1) When used with K-7 reflector provided (*2) Sensors with high-speed, long-life photo-MOS relay (1a) are available on request (Contact Takex for details). (*3) Light-ON type separately available. (*4) Dark-ON type separately available. (*5) The cable length for a sensor with permanently attached wiring including connector (-J type) is 300 mm. The cable with connector is optional. The output of a sensor with permanently attached cable with connector (-J type) is 1a. Sensors of this series are not provided with mounting brackets. Brackets for vertical or back-to-back mounting are optionally available</p>			

AC/DC Power Supply Photo Sensors

Environmental Specification

Ambient light	10,000 lx max.
Ambient temperature	-25 ~ +55 °C (non-freezing)
Ambient humidity	35-85%RH (non-condensing)
Protective structure	IP66
Vibration	10-55 Hz / 1.5 mm amplitude / 2 hours each in 3 directions
Shock	100 m/s ² / 3 times each in 3 directions
Dielectric withstanding	1,500 VAC for 1 minute
Insulation resistance	500 VDC, 100 M Ω or higher



(Mounting bracket optional)

Input/Output Circuit and Connection

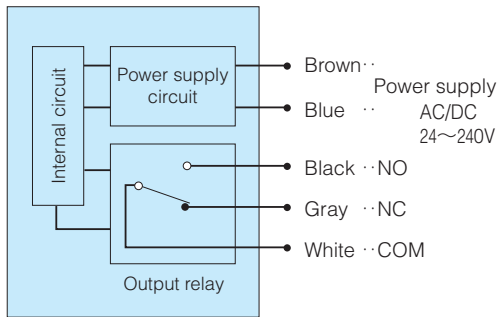

Transmitter of the through-beam type only has power supply lines.

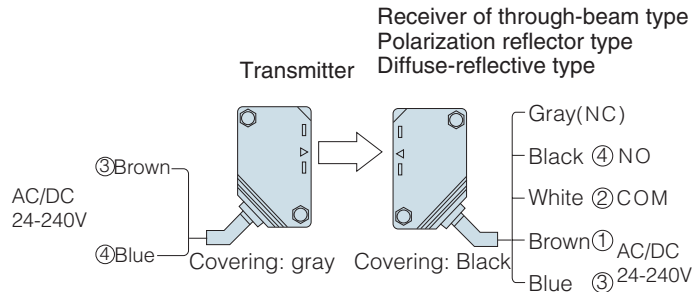

- Circled numbers show connector pin Nos. for -J type
- The output of -J type is 1 a.

Directional Characteristics (Typical Example)

NE-M5RD

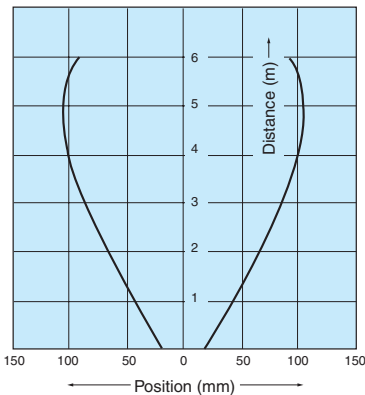

NE-T10RD

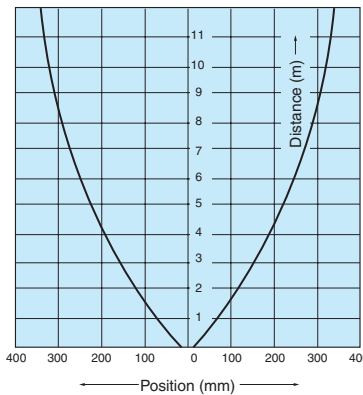

Activation area characteristics

NE-R10

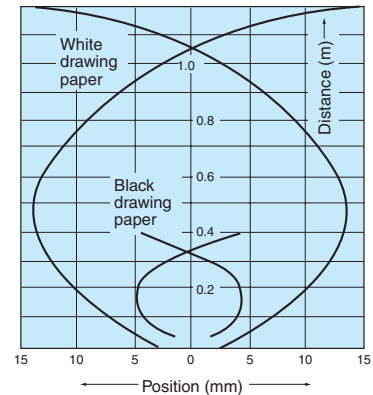

Distance-Area Characteristics (Typical Example)

NE-R10

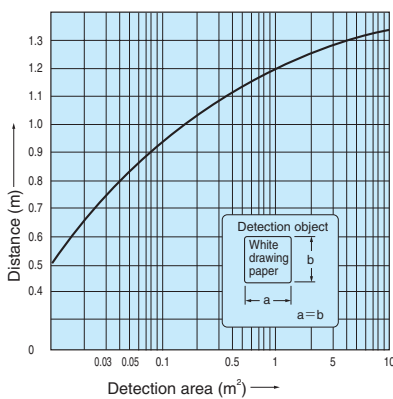

Indicators

- Indicators allow easy light axis alignment and sensitivity adjustment. Setting the sensitivity in a range allowing stable operation achieves a higher degree of reliability against changes in the operating environment that may be generated after the sensitivity is set.
- The operation indicator (red LED) and stability indicator (green LED) respectively show different received light intensity levels as described in the figure below.

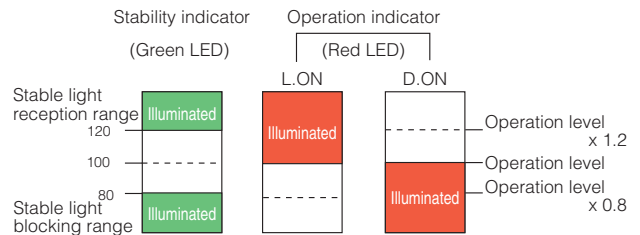

Pinhole Plate (Optional)

Pinhole plates as described below are available for through-beam type models. Use of pinhole plates reduces the smallest allowable detected object diameter and activation area.

Detecting distance with plates attached to both transmitter and receiver

Sensor model	Pinhole plate model		
	NE-P3	NE-P5	NE-P5×1
NE-T10R (D)	1m	3m	0.7m
NE-T30 (D)	3m	7m	2m

Detecting Distances for Different Reflectors (for model NE-M5RD)

The detecting distance depends on the reflector used.

Reflector model	Detecting distance
K-7	0.03~5m
K-71	0.03~2m
S-510G	0.1 ~3m

Dimensions (in mm)

Body

CAD

Permanently attached cord with connector (-J) type

With mounting bracket NE-B1 (vertical) attached

CAD

With mounting bracket NE-B2 (back-to-back) attached

Reflector K-7

Effective reflecting surface: 56 x 36 mm
 Mounting: secured with M3 screws (alternatively adhesive may be used)
 Protective structure: IP 67

The NE Series sensors are not provided with mounting brackets however two types of brackets are optionally available. The tightening torque for the sensor body and mounting bracket should be 0.8 N·m max.

Attachment of Anti Interference filter (optional)

Model

NE-PFA (longitudinal polarization)

NE-PFB (horizontal polarization)

Use of filters allows adjacent mounting of through-beam type sensors. For adjacent mounting of two sensors, use the longitudinal type for one pair and horizontal type for the other.

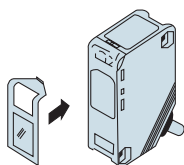

Insert into grooves at the top and bottom of the lens side of the transmitter and receiver.

Attach NE-PFA

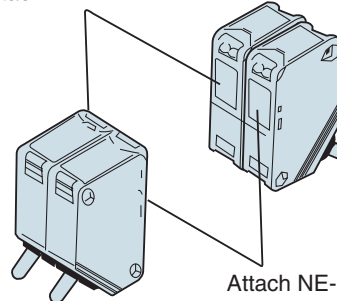

Attach NE-PFB

May be attached to model NE-T10R (D). The detecting distance with the filters attached is up to 5 m.



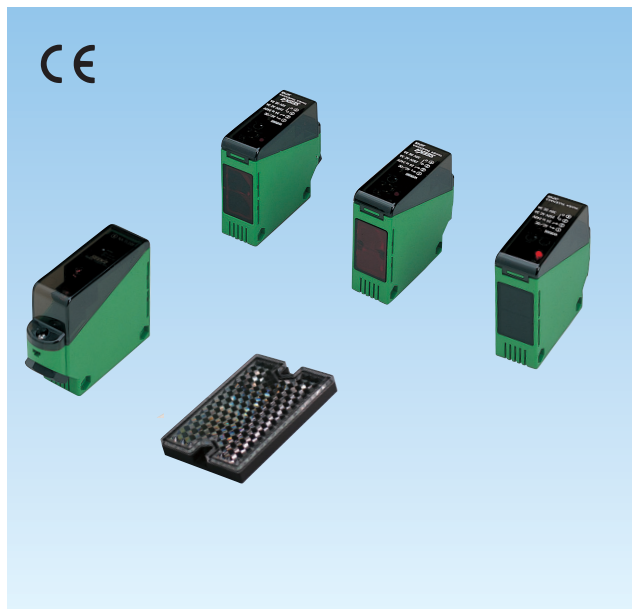

- Do not use the sensor for protection of human body.
- For safety applications, ensure safe operation of the detection and control system as a whole.
- This product is not explosion proof.



- Fully open terminal block for ease of wiring
- Compatibility with broad range of power supply voltages, therefore, allowing global use
 - Polarization reflector for stable detection of mirror-like objects
 - Red LED for easy adjustment
 - Improved resistance to noise with original photo IC

Type

Type	Detecting distance	Model	Timer feature	Operation mode	Output mode
 Through-beam type	20m	NA-T20R	—	Light-ON/ Dark-ON selectable (Models with "F" at the end of the model No. is Light-ON/Dark- ON and timer function selectable)	Relay output 1a
		NA-T20RF	Provided		
	10m	NA-T20RA※	—		
		NA-T20RB※	—		
		NA-T20RFA※	Provided		
	30m	NA-T20RFB※	—		
NA-T30		—			
 Polarization reflector type	0.03-7m	NA-T30F	Provided		
		NA-M7R	—		
 Diffuse-reflector type	1m	NA-M7RF	Provided		
		NA-R10	—		
		NA-R10F	Provided		

*Interference between models with the "A" and "B" designation at the end of model Nos. is prevented.

Optional Parts

Type	Model	Applicable model	Description	
Pinhole sticker	AP35	NA-T20R NA-T20RF NA-T30 NA-T30F	Detecting distance with stickers attached to both transmitter and receiver of NT-T20R(F) φ3mm……1m φ5mm……3.5m	One sticker contains φ3 and φ5 holes. Two stickers required for attachment to both transmitter and receiver.
Reflector	K-71	NA-M7R	Detecting distance: 0.03-3.5m	
	S-510G	NA-M7RF	Detecting distance : 0.1-4m	
Bushing rubber	JV7	All models	Compatible cable diameter: 6-8 mm	

- Mounting brackets are accessories.

Rating/Performance/Specification

	Type	Basic type			Multifunctional type (with timer)		
	Model	NA-T20R	NA-M7R	NA-R10	NA-T20RF	NA-M7RF	NA-R10F
Rating/performance	Detection method	Through-beam type	Polarization reflector type	Diffuse-reflector type	Through-beam type	Polarization reflector type	Diffuse-reflector type
	Detecting distance	20m max.	0.03-7m max(*1)	1m max. (*2)	20m max.	0.03-7m max. *1)	1m max (*2)
	Detection object	Opaque object of ϕ 22 min	Mirror-like objects, opaque objects	Opaque objects, translucent objects	Opaque object of ϕ 22 min	Mirror-like objects, opaque objects	Opaque objects, translucent objects
	Power supply	24-240V AC/DC \pm 10% 50/60Hz					
	Power consumption	Transmitter: 1.5 W max. Receiver: 2 W max.	2 W max.		Transmitter: 1.5 W max. Receiver: 2 W max.	2 W max.	
	Output mode	Relay output 1a / Rating: 3 A (250 VAC max. resistance load 30 VDC max. resistance load)					
	Operation mode	Light-ON/Dark-ON selectable.			<ul style="list-style-type: none"> Light-ON/Dark-ON selectable Timer function selectable Selectable between on-delay, off-delay, one-shot and timer disabled (with switch) Delay time: 0.1-5 s		
	Response time	10ms max.					
	Hysteresis	—		10% max	—		10% max
	Operating angle	3° (at receiver)	30° (at reflector)	—	3° (at receiver)	30° (at reflector)	—
Specification	Light source (wavelength)	Red LED (700 nm)		Infrared LED (880 nm)	Red LED (700 nm)		Infrared LED (880 nm)
	Indicator	Operation indicator (red LED)					
	Volume (VR)	— (*3)	—	Sensitivity adjustment	Delay time adjustment		Sensitivity adjustment Delay time djustment
	Switch (SW)	Light-ON/Dark-ON selector switch			FUNCTION.SW provided OND.: on-delay <input type="radio"/> side...Light-ON <input checked="" type="radio"/> side...Dark-ON OFD.: off-delay <input type="radio"/> side...Light-ON <input checked="" type="radio"/> side...Dark-ON OST.: one-shot <input type="radio"/> side...Light-ON <input checked="" type="radio"/> side...Dark-ON NORM.: timer disabled <input type="radio"/> side...Light-ON <input checked="" type="radio"/> side...Dark-ON		
	Material	Lens: acrylic / Case: heat-resistant ABS / Cover: acrylic					
	Connection	Terminal block (with M3.5 screws)					
	Mass	Transmitter: about 150 g./ Receiver: about 170 g	About 170 g		Transmitter: about 150 g./ Receiver: about 170 g	About 170 g	
	Notes	(*1) When used with K-7 reflector provided (*2) With 200 x 200 mm white drawing paper (*3) Sensors with sensitivity adjustment provided for receivers are available on request.					

AC/DC Power Supply Photo Sensors

Environmental Specification

Environment	Ambient light	10,000 lx max.
	Ambient temperature	-25 ~ +55 °C (non-freezing)
	Ambient humidity	35-85%RH (non-condensing)
	Protective structure	IP66
	Vibration	10-55 Hz / 1.5 mm amplitude / 2 hours each in 3 directions
	Shock	100 m/s ² / 3 times each in 3 directions
	Dielectric withstanding	1,500 VAC for 1 minute
	Insulation resistance	500 VDC, 100 M Ω or higher

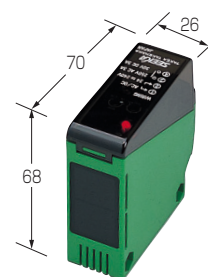

Compatible to DIN-PG11

The ground hub may be made to conform to DIN PG11. Add X-PGE at the end of the model No. for ordering.

Ground hub bushing rubber

Standard models are provided with linings compatible with cables of 9-11 mm in diameter. When using cables of 6-8 mm, use optional bushings.

Input/Output Circuit and Connection

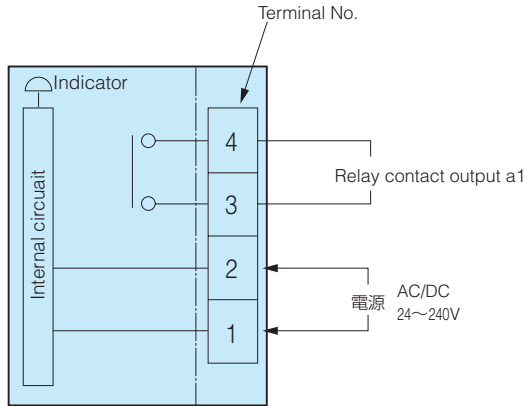

(Note) Transmitter of the through-beam type only has power supply lines.

Timing Chart for "F" (multifunctional) Type

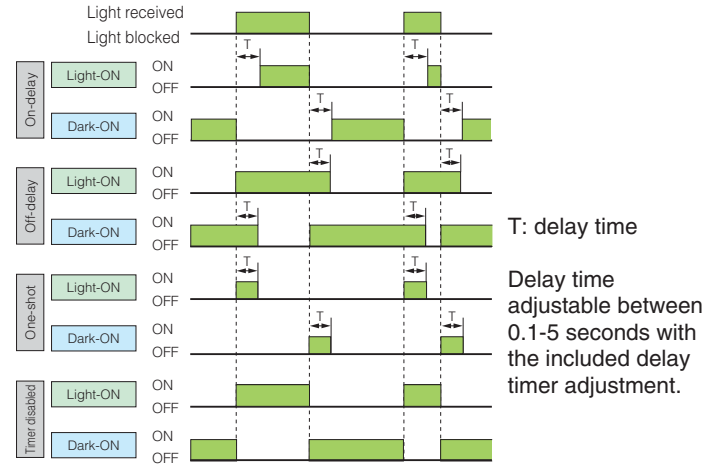

Directional Characteristics (Typical Example)

NA-T20R, NA-T20RF

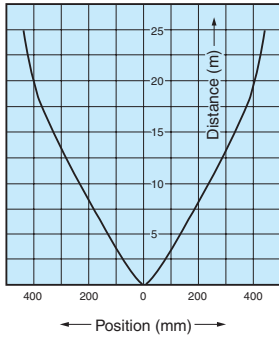

Directional Characteristics (Typical Example)

NA-M7R, NA-M7RF

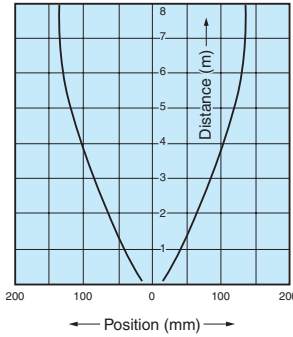

Activation Area Characteristics (Typical Example)

NA-R10, NA-R10F

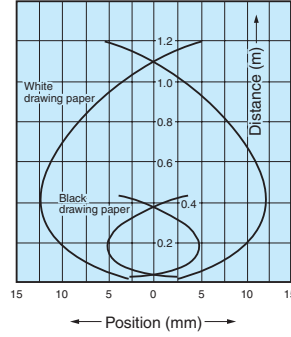

Distance-Area Characteristics (Typical Example)

NA-R10
NA-R10F

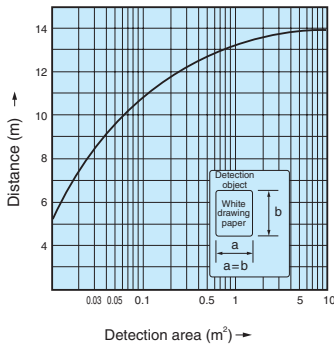

Pinhole

Pinhole stickers as described below are optionally available for through-beam type models. Use of pinhole stickers reduces the smallest allowable detection object diameter and activation area. Attach the sticker with either the top or bottom side up for aligning either of the holes with the light axis. (The stickers are designed to allow automatic alignment of the light axis and a pinhole by aligning the "sticker" to the concave part of the sensor with either top or bottom side up.) Do not cut the sticker in two pieces.

Applicable model
NA-T20R
NA-T20RF

Pinhole	$\phi 3$	$\phi 5$
Detecting distance	1m	3.5m

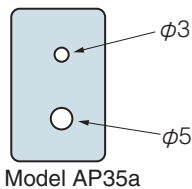

Detecting Distances for Different Reflectors

Applicable model
NA-M7R
NA-M7RF

Reflector model	Detecting distance
K-7	0.03~7 m
K-71	0.03~3.5m
S-510G	0.1 ~4 m

Dimensions (in mm)

CAD

With mounting bracket (accessory) attached

Note)
Light axis 1: through-beam type
Light axis 2: diffuse-reflective type, polarization reflector type

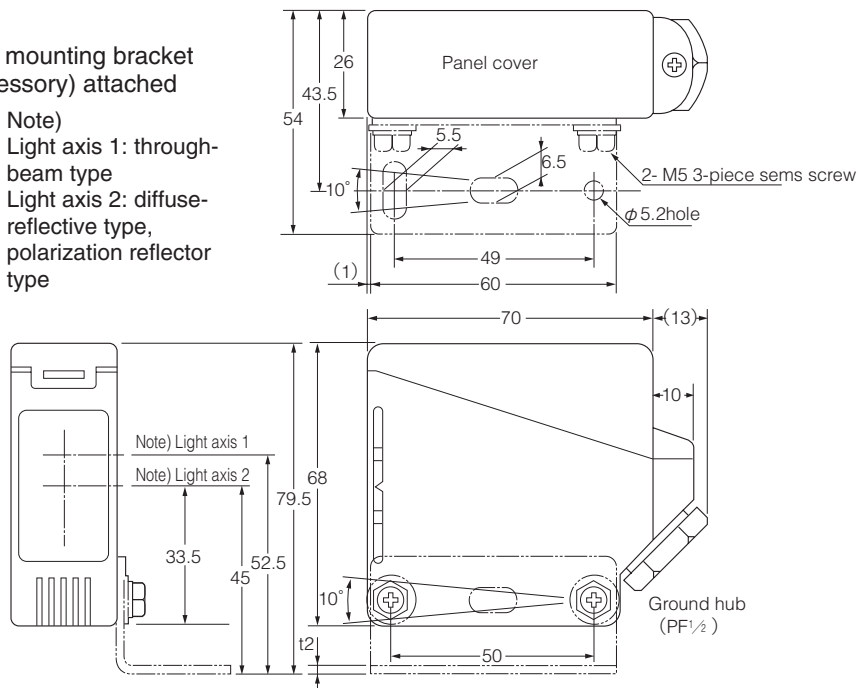

Reflector K-7 (accessory)

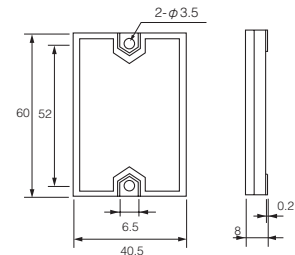

Effective reflecting surface: 56 x 36 mm
Mounting: secured with M3 screws (alternately adhesive may be used)
Protective structure: IP 67

The tightening torque for the sensor body and mounting bracket should be 0.8 N·m max.

Panel layout and functions

Diffuse-reflective type
NA-R10

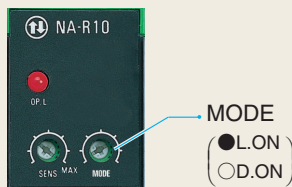

The switch is provided for selecting between Light-ON and Dark-ON modes. Turn the switch to L.ON or D.ON for Light-ON or Dark-ON mode respectively. Be sure to turn all the way to the end.
(Provided on NA-TR20R, NA-M7R and NA-R10)

Diffuse-reflective type with timer
NA-R10F

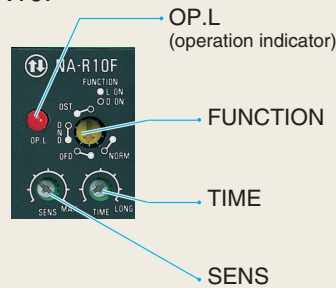

- **OP.L (operation indicator)**
Red LED is illuminated when output relay is activated.
- **FUNCTION**
Rotary switch for selecting between functions, used for specifying the output relay timer function or operation mode.
- **TIME**
Delay time adjustment for use of the timer feature. Time is adjustable between 0.1 and 5 seconds.
- **SENS**
Sensitivity adjustment. Turning clockwise increases the sensitivity.

“F” (multifunctional type)

- Configure settings with FUNCTION switch on the panel.

Dark-ON setting



One-shot

Signal output for specified period after detection.

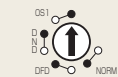

On-delay

Signal output after specified delay time after detection

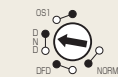

Off-delay

Signal extended by specified period



Time disabled

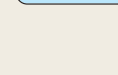

- Do not use the sensor for protection of human body.
- For safety applications, ensure safe operation of the detection and control system overall.
- This product is not explosion proof.



- Quick replacement feature
- 3 openings for cables

- Metal and mirror-like objects are detected
- Flat body integrating many functions
- Offers much larger wiring space

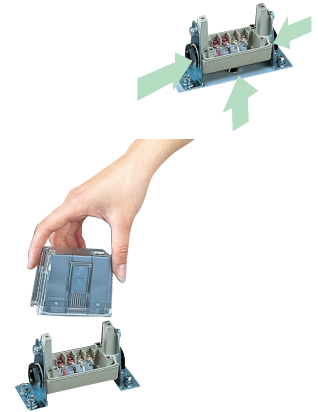

Type

Type	Detecting distance	Model	Timer feature	Operation mode	Output mode	
Through-beam type	10m	JT10R	Not provided	Light-ON/ Dark-ON selectable <small>(with switch on bottom of sensor unit)</small>	Relay output 1a	
		JT10R-SR			Triac output	
Polarization reflector type	0.03-3m	JRM3R			Relay output 1a	
		JRM3R-SR			Triac output	
Diffuse-reflector type	700mm	JR07			Relay output 1a	
		JR07-SR			Triac output	
Through-beam type	10m	JT10RF		Provided	Light-ON/ Dark-ON and timer range selectable <small>(switching between Light-ON and Dark-ON and between timer functions with FUNCTION switch on bottom of sensor unit)</small>	Relay output 1a
		JT10RF-SR				Triac output
Polarization reflector type	0.03-3m	JRM3RF				Relay output 1a
		JRM3RF-SR				Triac output
Diffuse-reflector type	700mm	JR07F				Relay output 1a
		JR07F-SR				Triac output

Optional Parts

Type	Model	Applicable model	Description	
Pinhole sticker	JP37	JT10R JT10R-SR JT10RF JT10RF-SR	Detecting distance with stickers attached to both transmitter and receiver φ 3mm·····2.5m φ 5mm·····6m	(One sticker contains φ 3 and φ 5 holes. Two stickers are required for attaching to both transmitter and receiver.)
Bushing rubber	JV7	All models	Compatible cable diameter: 6-8 mm	

- Mounting brackets are accessories.

Rating/Performance/Specification

Type	Basic type			Multifunctional type			
	Relay output	JT10R	JRM3R	JR07	JT10RF	JRM3RF	JR07F
Model	Triac output	JT10R-SR	JRM3R-SR	JR07-SR	JT10RF-SR	JRM3RF-SR	JR07F-SR
Detection method	Through-beam type	Polarization reflector type	Diffuse-reflector type	Through-beam type	Polarization reflector type	Diffuse-reflector type	
Detecting distance	10m max.	0.03-3m max(*1)	700mm max (*2)	10m max.	0.03-3m max(*1)	700mm max (*2)	
Detection object	Opaque object of ϕ 16 min	Mirror-like objects, opaque objects	Translucent objects, opaque objects,	Opaque object of ϕ 16 min	Mirror-like objects, opaque objects	Translucent objects, opaque objects,	
Power supply	24-240V AC/DC \pm 10% 50/60Hz						
Power consumption	2W max. (transmitter/receiver)	2 W max.		2W max. (transmitter/receiver)	2 W max.		
Output mode	Relay output 1a / Rating: 2 A (250 VAC max. resistance load) Triac output / Rating: 3.5 mA min., 100 mA max. (250 VAC)						
Operation mode	Light-ON/Dark-ON selectable. (with switch)			<ul style="list-style-type: none"> Light-ON/Dark-ON selectable Timer function selectable Selectable between on-delay, off-delay, one-shot and timer disabled (with switch) Delay time: 0.1-1 s, 1-10 s			
Response time	Relay output: 5ms max. *3			Triac output: 12ms max.			
Hysteresis	—		10% max.	—		10% max.	
Operating angle	5% (at receiver)	30° (at reflector)	—	5% (at receiver)	30° (at reflector)	—	
Light source (wavelength)	Red LED		Infrared LED	Red LED		Infrared LED	
Indicator	Transmitter P.L: power indicator (red LED) Receiver OP.L: operation indicator (red LED) STB: stability indicator (green LED)		OP.L: operation indicator (red LED) STB: stability indicator (green LED)	Transmitter P.L: power indicator (red LED) Receiver OP.L: operation indicator (red LED) STB: stability indicator (green LED)		OP.L: operation indicator (red LED) STB: stability indicator (green LED)	
Volume (VR)	—		Sensitivity adjustment	Delay time adjustment		Sensitivity adjustment Delay time adjustment	
Switch (SW)	Light-ON/Dark-ON selector switch (integrated on bottom of sensor unit)			FUNCTION.SW provided (selects between functions) OND.: on-delay Δ : Light-ON \blacktriangle : Dark-ON OFD.: off-delay Δ : Light-ON \blacktriangle : Dark-ON OST.: one-shot Δ : Light-ON \blacktriangle : Dark-ON NORM: timer disabled Δ : Light-ON \blacktriangle : Dark-ON (With rotary switch: integrated on bottom of sensor unit) Delay time range selector switch provided 0.1-1 s: variable between 0.1 and 1 second with TIME VR 1-10 s: variable between 1 and 10 seconds with TIME VR (Sliding switch integrated on bottom of sensor unit)			
Case material	Acrylic resin						
Connection	Terminal block (with M3.5 screws)						
Mass	About 250 g max. (transmitter/reflector)	250g max.		About 250 g max. (transmitter/reflector)	250g max.		
Notes	(*1) When used with K-7 reflector provided		(*3) While the response time is fast, use at a switching frequency of 30/min max. is recommended in view of the life of the relay.				
	(*2) With 200-mm square white drawing paper						

Environmental Specification

Ambient light	10,000 lx max.
Ambient temperature	-25 ~ +55 °C (non-freezing)
Ambient humidity	35-85%RH (non-condensing)
Protective structure	IP66
Vibration	10-55 Hz / 1.5 mm amplitude / 2 hours each in 3 directions
Dielectric withstanding	1,500 VAC for 1 minute
Insulation resistance	500 VDC, 100 M Ω or higher

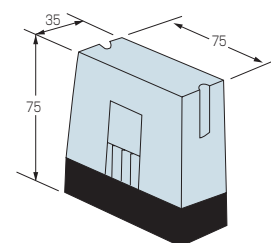

Input/Output Circuit and Connection

Relay output type

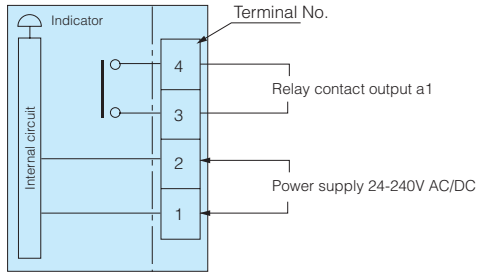

Triac output type

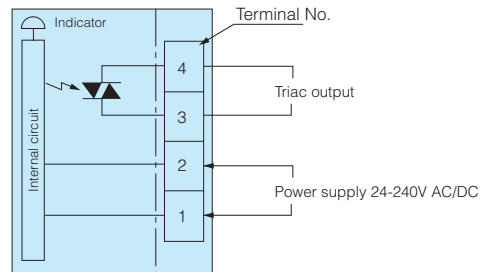

Directional Characteristics (Typical Example)

JT10R/JT10R-SR
JT10RF/JT10RF-SR

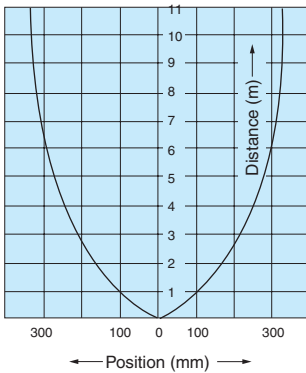

JRM3R/JRM3R-SR
JRM3RF/JRM3RF-SR

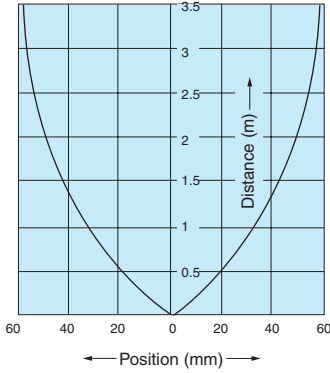

With 2 reflectors (K-7) for
JRM3R/JRM3R-SR/JRM3RF/JRM3RF-SR

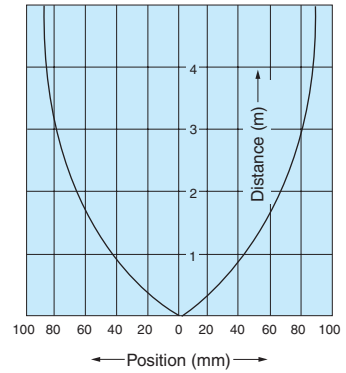

Activation Area Characteristics

JR07/JR07-SR
JR07F/JR07F-SR

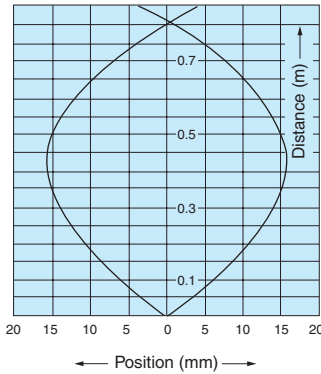

Distance-Area Characteristics (Typical Example)

JR07/JR07-SR
JR07F/JR07F-SR

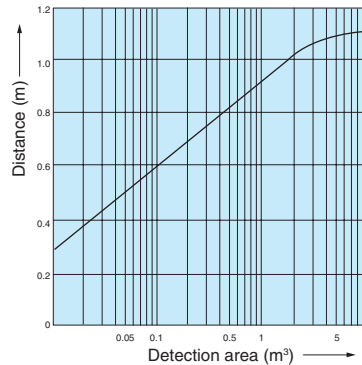

Distance-output Characteristics (Typical Example)

JT10R/JT10R-SR
JT10RF/JT10RF-SR

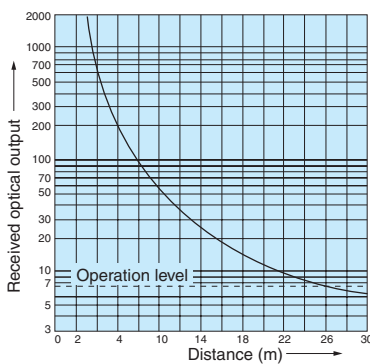

JRM3R/JRM3R-SR
JRM3RF/JRM3RF-SR

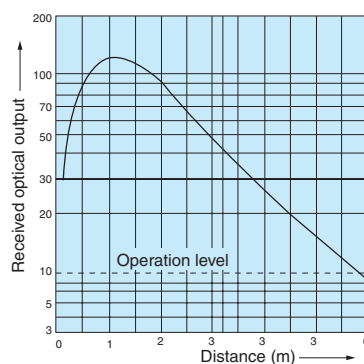

JR07/JR07-SR
JR07F/JR07F-SR

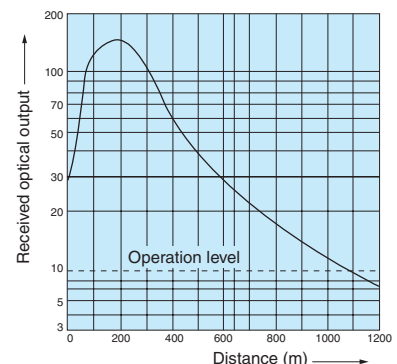

Dimensions (in mm)

CAD

Mounting hole dimensions

4-M5タップ 100 R3 24 17.8 30 11.7 13.1 約7度

Reflector K-7
(provided for polarization reflector type)

CAD

Effective reflecting surface: 56 x 36 mm
 Mounting: secured with M3 screws (alternatively adhesive may be used)
 Protective structure: IP 67

A: through-beam type light axis and reflective type light reception axis
 B: reflective type light axis center
 C: reflective type light emission axis

- JIS B 0202 PF1/2 screws used
- Compatible cable diameter: 9-11 mm
- When using cable diameters of 6-8 mm, use optional bushings <JV7>.

Operation Mode Setting and Switching

Switches for selecting the operation mode and timer function are on the bottom of the sensor unit.

• Basic type

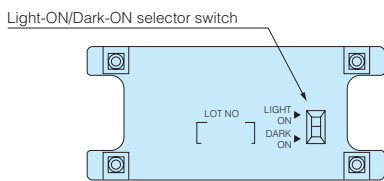

• Multifunctional type

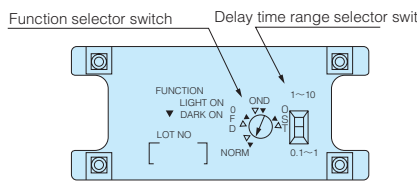

Description of Volumes

• Basic diffuse-reflective type
JR07•JR07-SR

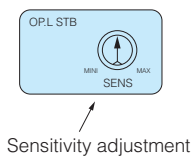

• Multifunctional diffuse-reflective type
JR07F•JR07F-SR

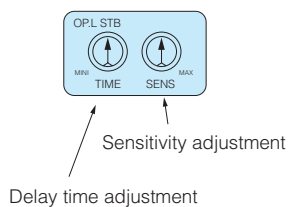

• Multifunctional type receiver
JTR10RF•JTR10RF-SR
 Polarization reflector type
JRM3RF•JRM3RF-SR

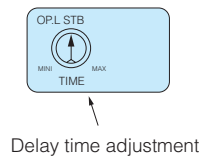

Indicators

The STB stability indicator (green LED) and OPL operation indicator (red LED) respectively show different received light intensity levels as described in the figure below.

After aligning the optical axis and adjusting the sensitivity, use a detection object to block and unblock the light beam several times to make sure that the sensitivity level is in a range that allows stable activation and deactivation.

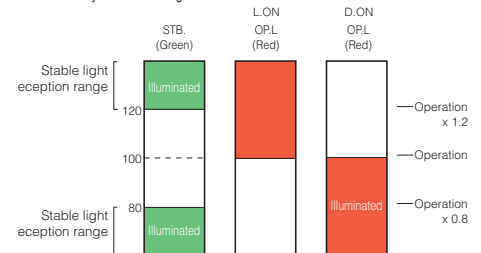

Setting the sensitivity in a range allowing stable operation achieves higher reliability against changes in the operating environment generated after the sensitivity is set.

Pinhole (Optional)

Pinhole stickers as described below are optionally available for through-beam type models. Use of pinhole stickers reduces the smallest allowable detection object diameter and activation area.

Attach the sticker with either the top or bottom side up for aligning either of the holes with the light axis (see Dimensions). (The stickers are designed to allow automatic alignment of the light axis and a pinhole by the alignment of the sticker to the concave part of the sensor with either top or bottom side up. Do not cut the sticker in two pieces.)

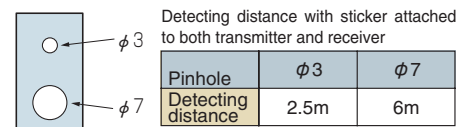



- M18 cylindrical, twin-wired
- Readily replaceable with limit switch
- Polarization reflector for stable detection of mirror-like objects
 - Greatly improved environmental resistance with water resistance of IP 66 is achieved by enhanced resin molding and enhanced robustness, etc.
 - Permanently attached cable and connector styles available

Type

Type	Detecting distance	Model	Operation mode	Output mode
Polarization reflector type	1m	CXM1RDTW	Dark-ON / Light-ON	2-wire AC current output
Reflector type	2m	CXM2DTW		
Diffuse-reflector type	100mm	CXS01TW		

*Connector types available for all models; "-J" added at the end of model No.

Activation Area Characteristics (Typical Example)

CXM1RDTW (-J)

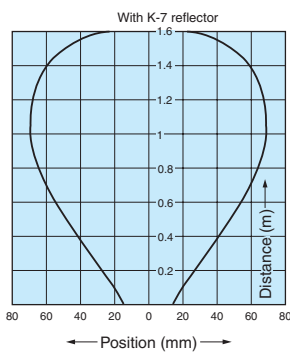

CXM2DTW (-J)

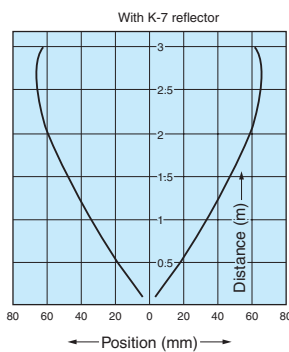

Distance-Area Characteristics (Typical Example)

CXS01TW (-J)

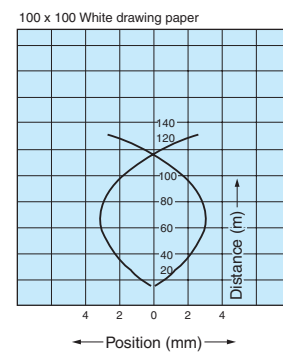

Distance-output characteristics (Typical Example)

CXM1RDTW (-J)

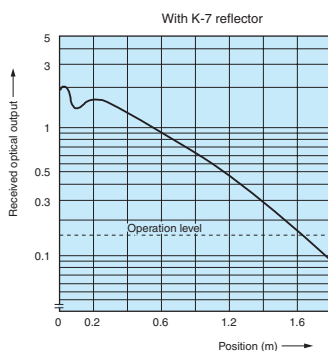

CXM2DTW (-J)

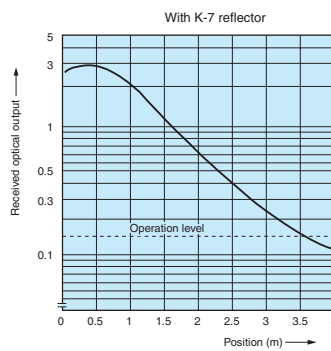

CXS01TW (-J)

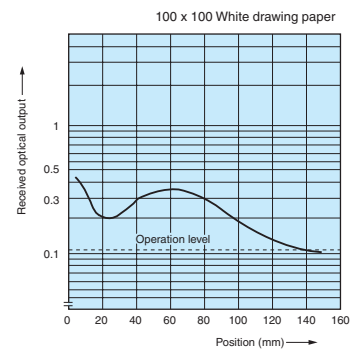

Rating/Performance/Specification

Model	Permanently attached cord type	CXM1RDTW	CXM2DTW	CXS01TW
	Connector type	CXM1RDTW-J	CXM2DTW-J	CXS01TW-J
Detection method		Polarization reflector type	Reflector type	Diffuse-reflector type
Detecting distance		1m *1	2m *1	100mm *2
Power supply		100-240V AC ±10% 50/ 60Hz		
Current consumption		1.5 max.		
Output mode		2-wire AC current output / Rating: 7-200 mA		
Operation mode		Dark-ON		Light-ON
Residual voltage (when activated)		10V		
Hysteresis		—		20% max
Response time		30ms max		
Operating angle		30°(Reflector)		
Light source (wavelength)		Red LED (700nm)	Infrared LED (900nm)	Infrared LED (910nm)
Indicator		Operation indicator: red LED		
Material	Lens	Acrylic	Polycarbonate	Acrylic
	Case	Polycarbonate		
Wiring	Permanently attached cord type	Outer dimension: dia.4, 0.2 mm ² x 2 cores, 2 m, black		
	Connector type	M12 x 1. 0 4-pin		
Mass	Permanently attached cord type	75 g max.		
	Connector type	30 g max.		
Notes		Do not use reflectors other than K-7.	*2 With 50 x 50 mm white drawing paper (slit plate model CX-P) (optionally available)	
		(*1) When used with K-7 reflector provided		For connector type (-J), cable with connector model CX-C4 is optionally available.

Input/Output Circuit and Connection

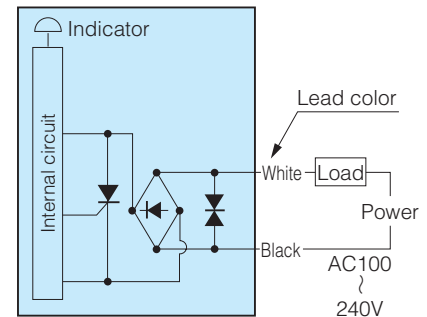

Be sure to connect power supply via a load.
Direct output may damage the internal elements.

Connector type

CXS01TW-J Diffuse-reflector type

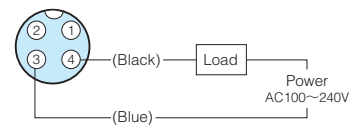

CXM1RDTW-J Polarization reflector type
CXM2DTW -J Reflector type

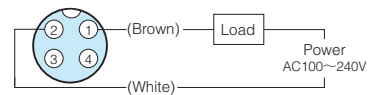

*Colors in parentheses show colors of wires for use with the optional cable with connector (model: CX-C4).

Environmental Specification

Ambient light	5,000 lx max.
Ambient temperature	-25 - +55 °C (non-freezing)
Ambient humidity	35-85%RH (non-condensing)
Protective structure	IP66
Vibration	10-55 Hz / 1.5 mm amplitude / 2 hours each in 3 directions
Dielectric withstanding	1,500 VAC for 1 minute Between entire power supply and case
Insulation resistance	500 VDC, 100 MΩ or higher Between entire power supply and case

Dimensions (in mm)

<p>CXM1RDTW CXS01TW</p> <p>CAD</p>	<p>CXM1RDTW-J CXS01TW-J</p> <p>CAD</p>
<p>CXM2DTW</p> <p>CAD</p>	<p>CXM2DTW-J</p> <p>CAD</p>

For reflector model K-7, see P. 403

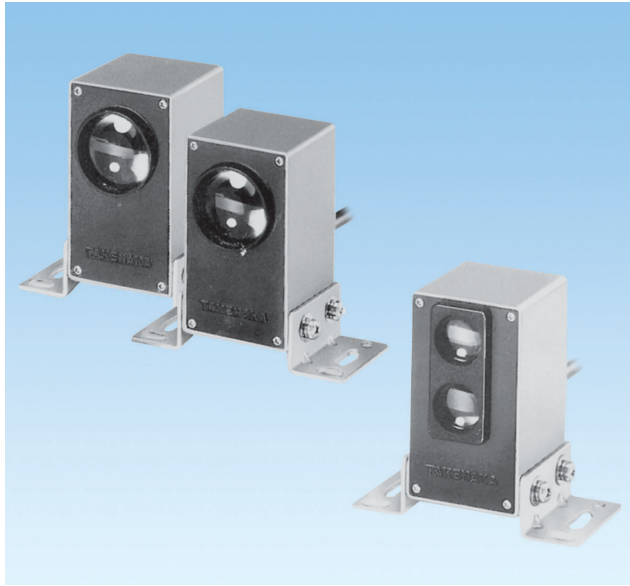

- Relay output available with commercial power supply

- Robust die-cast case

- All models provided with operation indicator (diffuse-reflective model GM05 also with sensitivity adjustment)
- Simplified wiring only of one unit (reflective type)

Type

Type	Detecting distance	Model	Operation mode	Output mode	
 Through-beam type	30m	GM30	Dark-ON	Relay output 1c	(reflector optional)
	10m	GM10			
 Reflector type	0.2-5m (K-6 reflector)	GM5			
 Diffuse-reflector type	500mm	GM05	Light-ON		

Input/Output Circuit and Connection

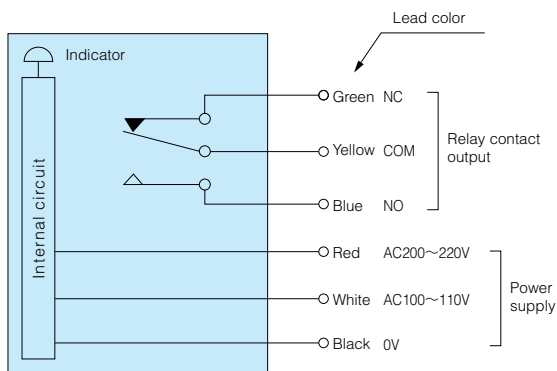

Model GM30 ● The COM and NO contacts are closed when light is blocked.
GM10 ● The COM and NC contacts are closed when light is received.
 ● Cut off any unused cord to prevent unwanted contact.

Model GM5 ● The COM and NO contacts are closed when light is blocked.
 ● The COM and NC contacts are closed when light is received.

Model GM05 ● The COM and NO contacts are closed when light is received.
 ● The COM and NC contacts are closed when light is blocked.
 ● Cut off any unused cord to prevent unwanted contact.

Rating/Performance/Specification

Model		GM30	GM10	GM5	GM05	
Rating/performance	Detection method	Through-beam type		Reflector type	Diffuse-reflector type	
	Detecting distance	30m	10m	0.2-5m *	500mm	
	Detection object	Opaque object of $\phi 24$ mm min		—	—	
	Power supply	AC 100V, 110V / 200V, 220V \pm 10% 50/60Hz				
	Power consumption	Transmitter: 1.2 VA max. / Receiver: 1 VA max.		1.1 VA max.	1.8 VA max.	
	Output mode	Relay output 1c / Rating: 2 A (250 VAC) max. resistance load				
	Operation mode	Dark-ON			Light-ON	
	Response time	25ms max.				
	Ambient light	10,000 lx max.	13,000 lx max.	20,000 lx max.	50,000 lx max.	
	Light source (wavelength)	Infrared LED				
Specification	Indicator	Transmitter: power indicator (red LED) Receiver: operation indicator (red LED)		Operation indicator (red LED)		
	Volume (VR)	—			Sensitivity adjustment provided	
	Material	Case	Zinc die-cast			
		Lens	Glass			
	Connection (*5)	Permanently attached cable (Outer dimension: dia.6) Transmitter: 0.5 mm ² x 3cores, 1 m, Receiver: 0.3 mm ² x 6cores, 1 m,		Permanently attached cable (Outer dimension: dia.6) 0.3 mm ² x 6 cores, 1 m,		
	Mass	Transmitter: 390 g max. / Receiver: 390 g max.		420g max.		
	Notes	Transmitter model:	GM30 (L)	Transmitter model:	GM10 (L)	*Standard detection object: 200 x 200 mm white drawing paper
		Receiver model:	GM30 (R)	Receiver model:	GM10 (R)	
		Power indicator visible obliquely downward from above				
	● Mounting brackets provided					

Environmental Specification

Environment	Ambient temperature	-10 ~ +50 °C (non-freezing)
	Ambient humidity	35-85%RH (non-condensing)
	Protective structure	IP54
	Vibration	10-55 Hz / 1.5 mm amplitude / 2 hours each in 3 directions
	Dielectric withstanding	1,500 VAC for 1 minute
	Insulation resistance	500 VDC, 20 M Ω or higher

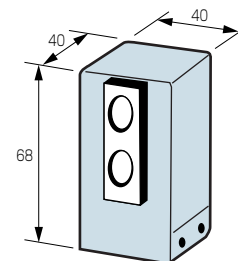

代理以下品牌:

- ◇日本山武 YAMATAKE/azbil ◇台湾阳明 FOTEK ◇美国霍尼韦尔 HONEYWELL
◇日本竹中 TAKEX/SEEKA ◇日本大仓 OHKURA ◇ASEE 安圣光纤线专业生产厂
◇日本基恩斯 KEYENCE ◇日本理研 RIKEN 光幕/镜片◇台湾 moujen

记录仪:大仓 OHKURA, 山武 YAMATAKE 千野 CHINO,神港 SHINKO,东邦 TOHO,横河 YOKOGAWA
安全光幕: 安圣 ASEE, SSG20 对射光幕, 神视 SUNX, 阳明 fotek, 理研 RIKEN 鲜光 SUN KWANG
光纤放大器:山武 YAMATAKE 竹中 TAKEX 神视 SUNX,基恩斯 KEYENCE 阳明 fotek 奥托尼克斯

主营产品: 安全光幕、记录仪、光纤放大器、光纤线、接近开关、光电开关、行程开关、计数器、计时器、温控器、固态继电器、热电偶、PT100 热电阻、燃烧保护继电器、火焰检测器、PLC、变频器、触摸屏、步进电机及驱动器、各国进口品牌记录纸、色带、记录笔

欢迎访问我公司网站:www.Lansea.net

深圳市创丰机电设备有限公司

深圳市宝安九区澎柏白金酒店商务大厦 917 室

手机:13143436561 直线: 0755-81642429

传真: 0755-61658146

联系人:钱军辉

网址 www.Lansea.net E-mail:sensorschina@126.com

服务 QQ:50827480 MSN:qianqun@163.com