



CAUTION!

- Refer to instruction manual for more details.
- Remove power to unit before wiring input and output connections.
- Follow instructions carefully to avoid personal injury.

Contents

1. Power Connections
2. Compatible Sensor Wiring
3. 4 - 20 mA Current Output Connections
4. Relay Connections
5. Relay Operation
6. Menu Functions
7. Temperature Coefficient
8. Parts and Accessories
9. Specifications
10. Quick Reference Menu Parameters
11. Troubleshooting
12. Maintenance

1. Power Connections



CAUTION!
Never connect 110 VAC or 220 VAC to rear power terminals. High voltage AC will damage instrument and void warranty.

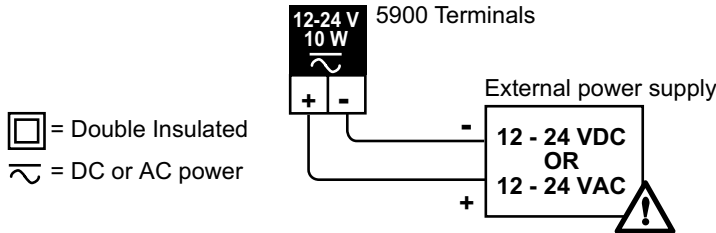

Technical Notes:

- To reduce the possibility of noise interference, isolate AC power lines from signal lines.
- Maximum 4-20 mA loop impedance is affected by the supply voltage.

2. Compatible Sensor Wiring

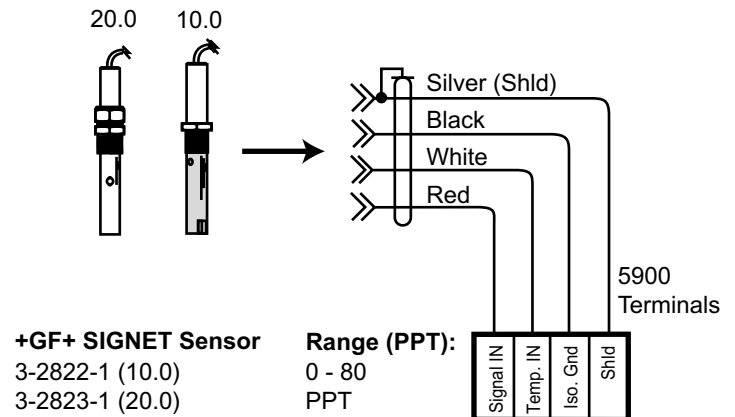

Technical Notes:

- Use three conductor shielded cable for cable extensions up to 30 m (100 ft) max.
- Cable shield **MUST** be maintained through cable splice

3. 4-20 mA Current Output Connections

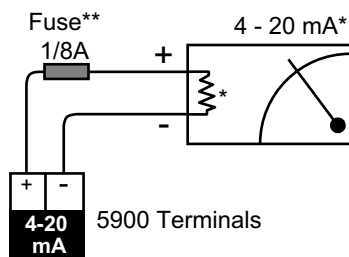

Technical Notes:

- ** 1/8A fuse recommended (customer supplied)
- * 4-20 mA output is **internally powered** (non-isolated), maximum loop impedance 350 Ω with a 12 V instrument supply voltage, 950 Ω with a 24 V instrument supply voltage.

To isolate output and prevent ground loop problems:

1. Use monitor device with isolated inputs, or
2. Use separate DC supply for 5900 and monitor device, or
3. Power 5900 with 12 - 24 VAC step down transformer

4. Relay Connections

Two internal relay contact sets (COM, NO, and NC) may be used for external device control. Front panel LED annunciators indicate the activation status of each relay. Each relay can control up to two devices simultaneously. Relay operation modes include Low alarm, High alarm, and Proportional Pulse.

Common device connections include:

- Pulse mode - metering pump control
- Pulse mode - solenoid valve control
- Low or High mode - warning lamps
- Low or High mode - bells or sirens
- Low or High mode - external heavy-duty relay

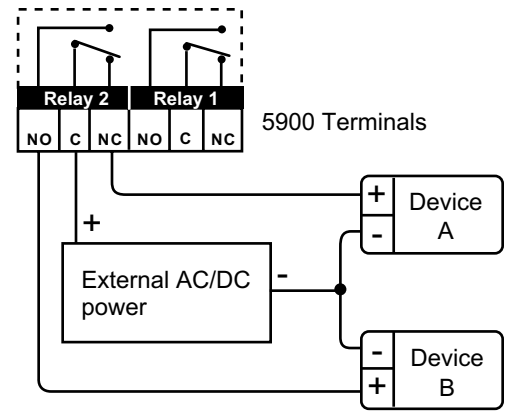
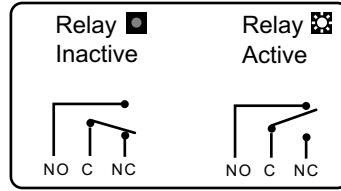

Wiring Example (right)

Device A is powered when relay 2 is inactive (front panel LED "off"). Power is discontinued when the relay 2 setpoint is reached (front panel LED "on"). Device B is not powered when relay 2 is inactive. Power is applied after the relay 2 setpoint is reached.

Technical Notes:

- Maximum relay contact ratings: 5 A @ 30 VDC, 5 A @ 125 VAC, or 3 A @ 250 VAC
- An external heavy-duty relay must be used for devices with surge currents or operating currents that exceed the above specifications.

5. Relay Operation

5.1 LOW alarm mode

The relay is active when the solution salinity in Parts Per Thousand (PPT) drops below the setpoint, and is inactive when the solution salinity rises above the setpoint plus hysteresis.

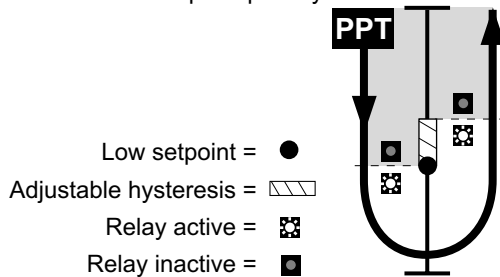

5.2 HIGH alarm mode

The relay is active when the solution salinity (PPT) rises above the setpoint, and is inactive when the solution salinity drops below the setpoint plus hysteresis.

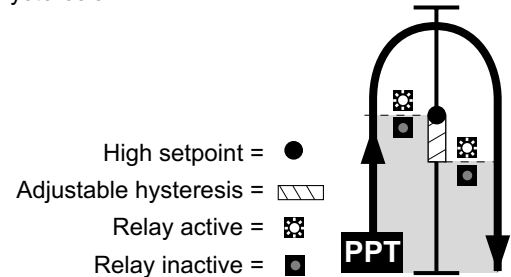

5.3 Proportional PULSE mode

The proportional pulse relay configuration is primarily designed for metering pump control. The operator is prompted to enter a minimum and maximum salinity setpoint and maximum pulse rate for the assigned relay. Relay pulse width is fixed at 130 ms.

- Metering pump chemical addition (dry contact activation type required)

Example 1: As the process salinity (PPT) rises above the minimum pulse setpoint (10 PPT) the relay begins pulsing, triggering the metering pump for deionized water addition. As the process salinity continues to rise, pulsing accelerates proportionally until the maximum programmed pulse rate of 300 pulses/minute and setpoint (30 PPT) is reached, forcing the process salinity back down to intended levels (e.g. ≤ 10 PPT).

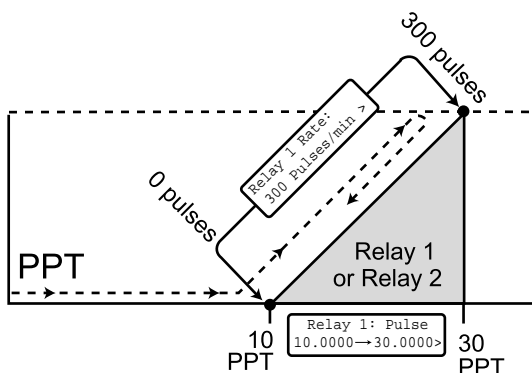

Example 2: As the process salinity (PPT) falls below the minimum pulse setpoint (30 PPT) the relay begins pulsing, triggering the metering pump for chemical addition. As the process salinity continues to decrease, pulsing accelerates proportionally until the maximum programmed pulse rate of 300 pulses/minute and setpoint (10 ppt) is reached, forcing the process salinity back up to intended levels (e.g. ≤ 30 PPT).

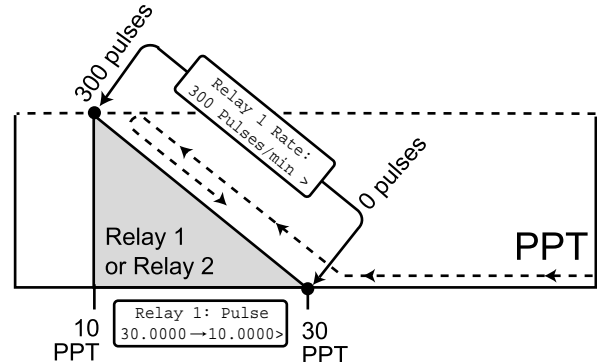

6. Menu Functions

To access either CALIBRATE or OPTIONS menus, press and hold the ENTER key as illustrated (right):

Menus:

- **VIEW menu:** Displayed during standard operation. The operator can navigate through the menu by pressing UP or DOWN arrow keys.
- **CALIBRATE Menu:** Contains all critical display setup and output parameters. A security code feature prevents unauthorized tampering. The operator is required to enter an access code for menu access. The same code also unlocks OPTIONS menus.
- **OPTIONS Menu:** Contains setup and display features accessed for minor display or output adjustments.
- **Reversible Dials (right)**
The 5900 includes a dial kit with 6 reversible dial faces and units decals (factory installed dial: 0 - 100). See dial kit for additional information.

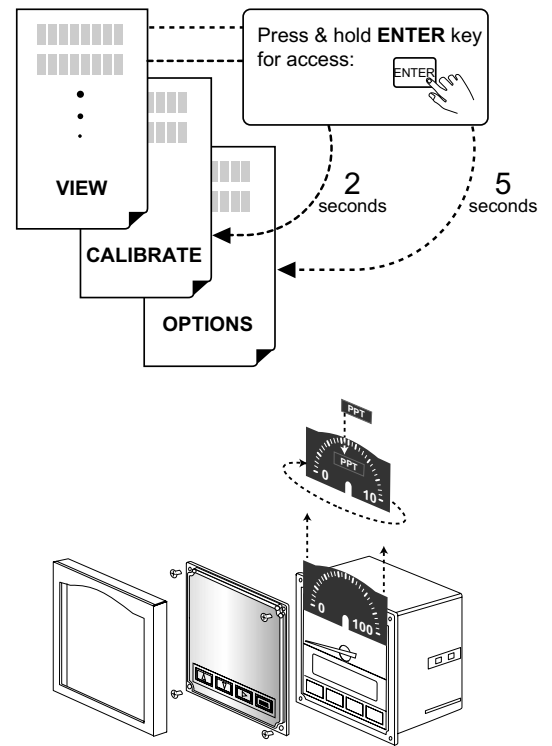

6.1 VIEW Menu

Menu Displays A - G:
(Factory default displays shown in menu column 1)

- A. Active display of salinity (PPT) and temperature in degrees celsius (°C) or fahrenheit (°F).
- B. Display of conductivity and temperature.
- C. Loop output display shows the loop current output level.
- D. Range display shows the programmed min and max meter dial range.
- E. Relay 1 display shows the programmed operation mode and setpoint for relay 1.
- F. Relay 2 display shows the programmed operation mode and setpoint for relay 2.
- G. Last calibration shows a user defined setup date for maintenance records. This feature is not an internal timer or calendar.

To G	Choose:	Change:	Save:
▲	A. 40.0 PPT +25.0 °C		
▲	B. 22.0 mS/cm +25.0 °C		
▲	C. Loop Output: 20.00 mA		
▲	D. Min→Max: PPT 0.0000→40.0000		
▲	E. Relay 1: Low 20.0000 PPT		
▲	F. Relay 2: High 40.0000 PPT		
▲	G. Last CAL: 01-01-99		
▼			

To A

6.2 CALIBRATE Menu

Requirements

System calibration (WET CAL) is required for first-time system setup or periodic sensor verification. System calibration can be performed with a solution of known salinity, or by comparison to a refractometer. Refer to the WET CAL procedure for calibration details.

Press and hold ENTER key for 2 seconds:

CALIBRATE: ----
Enter Key Code is displayed.

Press keys in sequence to enter menu:

▲▲▲▼

CALIBRATE: XXXX
Enter Key Code is displayed.

Menu Settings A - J:

(Factory default displays shown in menu column 1)

- A. Selects cell type and cell value:
 - Standard cells: 10.0, or 20.0. Use 10.0 or 20.0 settings.
 - Custom (certified) cells: 00.0000 - 999999.
- B. Selects displayed units; should be selected for conductivity display INFO ONLY.
- C. Sets PPM factor when PPM display units are selected, 0.01 - 9.99.
- D. Sets Min->Max meter dial range (factory installed dial, 0 - 100). Contact factory for custom dial configurations. Does not effect 4 to 20 mA output; set separately.
- E. Selects WET CAL procedure for first time system setup or periodic system recalibration.

Menu items F - I repeat for relay 2 setup.

- F. Sets relay operation mode Low or High, and setpoint, 00.0000 - 999999. units.
- G. Sets relay hysteresis, 00.0000 - 999999. units. Set to zero to disable feature
- H. Sets relay minimum and maximum pulse setpoint, 00.0000 - 999999. units.
- I. Sets relay pulse rate, 000 - 300 pulses/minute.
- J. Sets user defined setup date for maintenance records. This feature is not an internal timer or calendar.

To J	Choose:	Change:	Save:
▲	Cell: Standard 10 >	Cell: Standard .01 .1 1 10 20	Cell: Custom 10.020
▲	Units: mS	Units: uS mS PPM kΩ MΩ	Units: uS mS PPM kΩ MΩ
▲	PPM Factor: 2.00 >	PPM Factor: 2.00	PPM Factor: 1.95
▲	Min->Max: PPT 0.0000->40.000 >	Min->Max: PPT 0.0000->40.000 >	Min->Max: PPT 00000.0->0080.00>
▲	WET CAL: >	WET CAL: Press <ENTER>	
Relay Low or High Mode Selected			
▲	Relay 1: Low 20.00 PPT >	Relay 1: Low 20.00 PPT >	Relay 1: Low 10.0000 PPT >
▲	Relay 1 Hys: 4.0000 PPT >	Relay 1 Hys: 04.0000 PPT >	Relay 1 Hys: 02.0000 PPT >
Relay Pulse Mode Selected			
▲	Relay 1 Pulse 00.0000->30.0000>	Relay 1 Pulse 00.0000->30.0000>	Relay 1 Pulse 10.0000->30.0000>
▲	Relay 1 Rate 120 Pulses/min>	Relay 1 Rate 120 Pulses/min	Relay 1 Rate 025 Pulses/min
▲	Last CAL: 01-01-98 >	Last CAL: 01-01-98	Last CAL: 02-05-98
To return to VIEW:	To A ▲▼ quick press	To restore original value:	▲▼ quick press

ENTER
"SAVING"
displayed

6.3 WET CAL Procedure

Requirements





Electronic calibration is performed to exacting standards by +GF+ SIGNET. System calibration will reduce errors which may be caused by sensor wire lengths longer than the standard 15 foot length. Wire lengths of 100 feet are acceptable; cable shield must be maintained through cable splice. Calibration may be done by known solution value or by comparison to a refractometer.

Calibration with NIST Traceable Solutions:

When using calibration standards traceable to the National Institute of Standards and Technology (NIST), care must be taken to ensure the sensor and test solution are at the solution temperature specified on the test solution label. Care must be taken to prevent contamination of the calibration solution. It is recommended to thoroughly rinse the sensor in a small amount of test solution (then discard) before placing in any test solution for calibration purposes. The 2-step WET CAL process first allows for verification or calibration of temperature, followed by verification or calibration of salinity (PPT) using a known process solution.

WET CAL Procedure (Solution calibration illustrated below)

Note: Always match test solution manufacturer's temperature recommendation.

Display:	To Change:	To Accept:
<p>Temperature: +25.7 °C ></p> <p>A) Solution cal.: place sensor and thermometer into standard solution then press right arrow key.</p> 	<p>Temperature: +025.0 °C ></p>  <p>A) Solution cal.: allow approx. 3 minutes for stabilization, then enter solution temperature.</p>	<p>Press <input type="button" value="ENTER"/> to accept temperature calibration.</p> <p>Temperature: +025.0 °C ></p>
<p>Salinity 20.0 PPT</p> <p>Measured salinity shown after temperature calibration.</p>	<p>Salinity 20.0 PPT</p>  <p>Enter known solution salinity or reference reading.</p> <p><i>Optional: enter zero to reset factory calibration (zero MUST be re-entered if currently displayed to reset factory calibration).</i></p>	<p>Salinity 20.0 PPT</p> <p>Press <input type="button" value="ENTER"/> to accept salinity calibration; display returns to CALIBRATE MENU in 3 seconds</p>
<p>To exit WET CAL at any time without saving changes:</p>		 quick press

6.4 OPTIONS Menu

Press and hold ENTER key for 5 seconds:

OPTIONS: ----
Enter Key Code is displayed.

Press keys in sequence to enter menu:

▲▲▲▼
OPTIONS: XXXX
Enter Key Code is displayed.

Menu Settings A - I:

(Factory default displays shown in menu column 1)

- A. Selects LCD display contrast: 5 levels
- B. Selects display decimal: ***** to *****
- C. Selects LCD display averaging: Off = 0 seconds, Low= 4 seconds, High= 8 seconds (affects 4-20 mA output)
- D. Sets 4 mA output setpoint. 4 mA and 20 mA setpoints are reversible.
- E. Sets 20 mA output setpoint. 20 mA and 4 mA setpoints are reversible.
- F. Sets 4 mA current output: 3.0 to 5.0 mA (overrides 4.00 mA factory calibration)
- G. Sets 20 mA current output: 19 to 21 mA (overrides 20.00 mA factory calibration)
- H. Selects temperature display: °C or °F
Recalibration is not required when switching from celsius to fahrenheit.
- I. Selects temperature compensation

To I	Choose:	Change:	Save:
A.	Contrast: 3 >	Contrast: 1 2 3 4 5 Low --- High	Contrast: 1 2 3 4 5
B.	Display Decimal: ***.* >	Display Decimal: ***.*	Display Decimal: *****
C.	Display Average: Low >	Display Average: Off Low High	Display Average: Off Low High
D.	Set 4 mA: 0.0000 PPT	Set 4 mA: 00.0000 PPT	Set 4 mA: 40.0000 PPT
E.	Set 20 mA 40.000 PPT	Set 20 mA 40.000 PPT	Set 20 mA 00.0000 PPT
F.	4 mA Adjust: 4.00 mA >	4 mA Adjust: 4.00 mA	4 mA Adjust: 3.88 mA
G.	20mA Adjust: 20.00 mA >	20mA Adjust: 20.00 mA	20mA Adjust: 19.98 mA
H.	Temperature: °C >	Temperature: °C °F	Temperature: °C °F
I.	Temperature: Comp %: 2.00 >	Temperature: Comp %: 2.00 >	Temperature: Comp %: 1.81
	To return to VIEW menu: ▲▼ quick press	To restore original value: ▲▼ quick press	ENTER "SAVING" displayed

7. Temperature Coefficient (Temp. Comp. %)

Salinity measurement is dependent on temperature. Temperature dependence is usually expressed as the relative change per °C, commonly known as percent/°C change from 25 °C, or slope of the solution.

Slopes can vary significantly depending on process solution type. The factory default temperature compensation factor is 2.00%/°C. This setting satisfies salinity applications.

8. Parts and Accessories

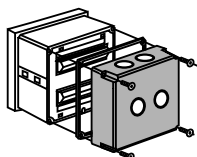

Splashproof rear cover
#3-5000.395
(code 198 840 227)

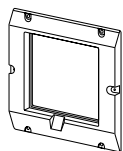

5 x 5 inch adapter plate for
+GF+ SIGNET retrofit
3-5000.399
(code 198 840 224)

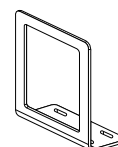

Optional surface mount bracket
3-5000.598
(code 198 840 225)

- Power supply, 120 VAC - 24 VAC, 3-5000.075
- Front snap-on bezel, 3-5000.525 (code 198 840 226)
- Assorted conductivity unit/multiplier decal sheet, 3-5500.612 (code 198 840 231)
- 5900 Salinity Monitor Instruction Sheet, 3-5900.090-1 (code 159 000 080)

9. Specifications

General

Compatible sensors: +GF+ SIGNET 3-28XX-1 Standard and Certified Series Sensors

Accuracy: ±0.5% PPT
 Input range: 1 to 80 PPT optically isolated
 Enclosure:

- NEMA 4X/IP65 front
- Dimensions: 1/4 DIN, 96 x 96 x 88 mm (3.8 x 3.8 x 3.5 in.)
- Case materials: ABS plastic
- Keypad material: Sealed 4-key silicone rubber
- Weight: 500 g (18 oz.)

Display:

- Type: Microprocessor controlled air-core meter movement and backlit alphanumeric 2 x 16 LCD
- Update rate: <2s
- Contrast: User selected
- Relay annunciators: 2 LEDs
- Displayed units: PPT (Salinity), µS, mS, kΩ, MΩ, PPM (TDS)

Environmental

Operating temp.: -10 to 55°C (14 to 131°F), 50°C (122°F) max. with optional rear cover
 Storage temp.: -15 to 80°C (5 to 176°F)
 Relative humidity: 0 to 95%, non-condensing
 Altitude: 4000 m max.
 Pollution degree: 2

Electrical

Power requirements:
 • 12 to 24 VDC or 12 to 24 VAC, unregulated, 50-60 Hz, 10 W max.

Temperature input:

- PT1000, 0 to 100°C (32 to 212°F), optically isolated

Dimensions:

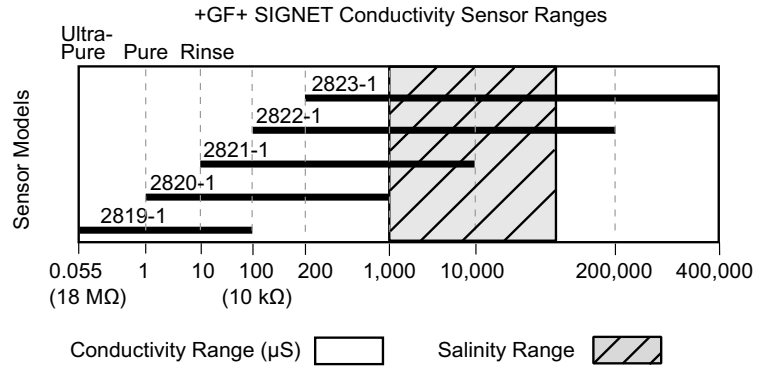
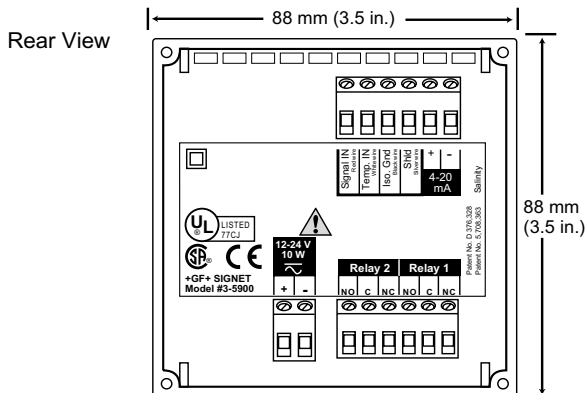
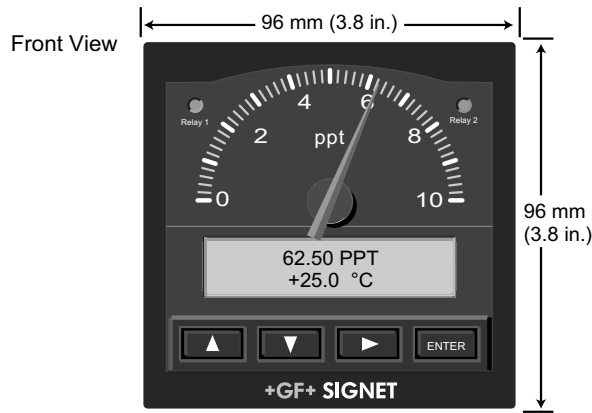

Relay outputs (2 sets):

- Mechanical SPDT contacts
- Max. voltage rating: 5 A @ 30 VDC, 5 A @ 125 VAC, or 3 A @ 250 VAC, (power factor = 1.0)
- Hysteresis: User adjustable

Current output:

- 4 to 20 mA, non-isolated, internally powered, fully adjustable and reversible
- Update rate: <2s
- Max loop impedance: 350 Ω with a 12 V instrument supply voltage, 950 Ω with a 24 V instrument supply voltage
- Accuracy ±0.1% of max range

Noise immunity: EN50082-2
 Noise emissions: EN55011
 Safety: EN61010-1

Agency Approvals

- CSA, CE, UL listed
- Manufactured under ISO 9001

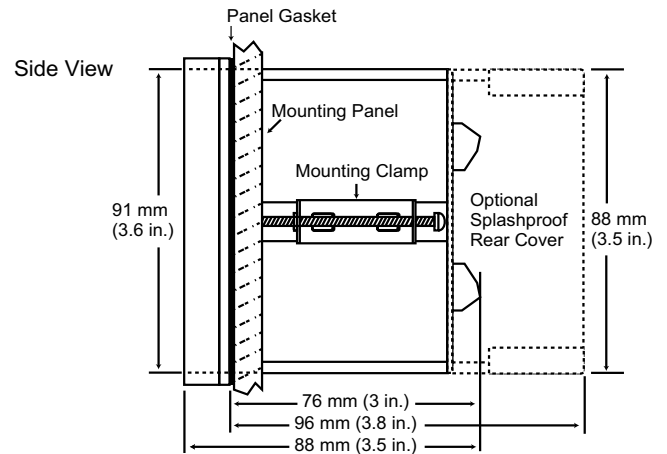

Panel Cutout

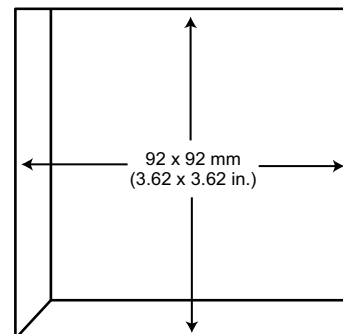

10. Quick Reference Menu Parameters

10.1 VIEW Menu Setup Parameters

Menu Parameters	Display Description	Range	Factory Default
A. 0.0 PPT +25.0 °C	<ul style="list-style-type: none"> Process salinity Process temperature 	<ul style="list-style-type: none"> 1 to 80 PPT Process temperature 	n/a n/a
B. Loop Output: 20.00 mA	Current loop output	3 - 21 mA	n/a
C. Min→Max: PPT 0.000→40.000	Min→Max meter dial range	0.055 - 400,000 mS	0.0000 - 40.000 PPT
D. Relay 1: Low 20.0000 PPT	<ul style="list-style-type: none"> Relay 1 mode Relay 1 setpoint 	Low, High, or Pulse,	Low 20 PPT
E. Relay 2: High 40.0000 PPT	<ul style="list-style-type: none"> Relay 2 mode Relay 2 setpoint 	Low, High, or Pulse,	High 40 PPT
F. Last CAL: 01-01-98	Last calibration date	00 - 00 - 00 - 39 - 39 - 99	01 - 01 - 98

10.2 CALIBRATE Menu Setup Parameters

Menu Parameters	Display Description	Range	Factory Default
A. Cell: Standard 1 >	<ul style="list-style-type: none"> Sensor type: and cell constant 	<ul style="list-style-type: none"> Standard sensor cells: 0.01, 0.1, 1.0, 10.0, 20.0 Custom sensor cells: 00.0000 - 9999999 	10.0
B. Units: mS	Process Units	µS, mS, PPT kΩ, or MΩ	mS
C. Min→Max: PPT 0.0000→40.0000>	Min→Max meter dial range	1 to 80	0.0000 - 40.000 PPT
D. WET CAL: >	System Calibration Procedure	Wet Solution or resistor calibration	n/a
E. Relay 1: Low 10.0000 PPT	<ul style="list-style-type: none"> Relay 1 mode Relay 1 setpoint 	<ul style="list-style-type: none"> Low or High 00.0000 - 9999999. 	Low 10.0000 PPT
F. Relay 1 Hys: 4.0000	Relay 1 hysteresis	<ul style="list-style-type: none"> Low or High 00.0000 - 9999999. 	4.0000 PPT
G. Relay 1: Pulse 10.0000→30.0000>	<ul style="list-style-type: none"> Relay 1 mode Relay 1 range 	<ul style="list-style-type: none"> Pulse 00.0000 - 9999999. 	10.0000 - 30.0000 PPT
H. Relay 1 Rate: 120 Pulses/min >	Relay 1 pulse rate	000 - 300 pulses/minute	120 pulses/minute
I. Last CAL: 01-01-98	Last calibration date	00 - 00 - 00 - 39 - 39 - 99	01 - 01 - 98

Relay mode and setpoint displays repeat for relay 2 setup

10.3 OPTIONS Menu Setup Parameters

Menu Parameters	Display Description	Range	Factory Default
A. Contrast: 3 >	Display contrast	0 - 5	3
B. Display Decimal: ***. **	Display decimal	*.**** - ****.	***. **
C. Display Average: Low >	Display averaging	Off= 0 sec., Low= 4 sec., High= 8 sec.	Low= 4 sec.
D. Set 4 mA: 0.0000 PPT	4 mA setpoint	00.0000 - 999999.	00.0000 PPT
E. Set 20 mA: 40.0000 PPT	20 mA setpoint	00.0000 - 999999.	40.0000 PPT
F. 4 mA Adjust: 4.00 mA	4 mA adjust	3.0 - 5.0 mA	4.00 mA
G. 20 mA Adjust: 20.00 mA >	20 mA adjust	19 - 21 mA	20.00 mA
H. Temperature: °C	Temperature display	°Celsius or °Fahrenheit	°C
I. Temperature Comp %: 2.00 >	Temperature comp. percentage	0.00 % - 9.99 %	2.00 %

11. Troubleshooting

Display	Problem	Solution
1. 0.0 /PPT ----- °C or ----- PPT ----- °C	Temperature wiring shorted or temperature element in sensor bad.	A) Verify sensor wiring. B) Verify instrument temperature input: <ul style="list-style-type: none"> Remove Black and White sensor wires from rear Temp. IN and Iso. Gnd terminals, then place a 1100 Ω resistor across terminals. Power instrument and verify approximately 26.0°C (79°F) on display. If instrument reads correctly, replace sensor. If error condition persists, instrument requires factory service.
2. 0.0 PPT 25.0 °C	A) Sensor not connected or improperly connected. B) Pipe empty or sensor not in solution. C) Wrong range selected. D) TC% set incorrectly for process temperature. E) Sensor wiring open. F) Water too cold for high-purity water measurement.	A) Verify sensor wiring B) Fill pipe or place sensor in process solution. C) Choose a sensor with cell constant adequate for process solution. D) Set TC% to 2% E) Replace sensor F) See specifications section for recommended high-purity range and temperature requirements.
3. ----- PPT 25.0 °C	A) Sensor not connected or improperly connected. B) Wrong range selected. (cell constant too large) C) TC% set incorrectly for process temperature.	A) Verify sensor wiring including cable splice; cable shield must continue through splice. B) Choose a sensor with cell constant adequate for process solution. C) Set TC% to 2%.
4. Too Much Error Check Sensor	Temperature input out of tolerance during WET CAL procedure.	Exit WET CAL procedure by pressing UP and DOWN arrow keys simultaneously, then refer to solution steps 1B above to verify sensor temperature input.
5. Reset to Factory Calibration	Zero entered as solution conductance or resistance during WET CAL step 2.	Measured conductivity, resistivity or PPT entered as zero during WET CAL step 2. Operator can enter zero to quickly recall factory defaults.
6. SETUP READ ERROR Press any key	Power fault occurred while saving setup menu entry.	Press any key to reload factory defaults then reprogram conductivity system setup parameters.

12. Maintenance

Clean the instrument case and front panel with a soft cloth and a mild liquid soap solution.

+GF+ SIGNET

Sales Offices:

- USA** George Fischer, Inc., 2882 Dow Avenue, Tustin, CA 92780/USA, Tel. (714) 731-8800, Fax (714) 731-6201
- Switzerland** Georg Fischer Rohrleitungssysteme AG, P.O. Box 671, CH-8201 Schaffhausen/Switzerland, Tel. 052/631 1111, Fax 052/631 2830
- Singapore** George Fischer Pte. Ltd., 15 Kaki Bukit Road 2, KB Warehouse Complex, Singapore 1441, Tel. 65/747 0611, Fax 65/747 0577
- Japan** Kubota George Fischer, 2-47 Shikitsuhigashi, 1-Chome, Naniwa-Ku, Osaka, 556-91 Japan, Tel. 816/648 2545, Fax 816/648 2565
- China** Georg Fischer Ltd., Rm 1503, Business Residence Bldg. of Asia Plaza, 2-3 Bldg. No. 5th Qu Anzhenxili, Chaoyang Qu, Beijing 100029, P.R. China, Tel. 86/10 6443 0577, Fax 86/10 6443 0578
- Australia** George Fischer Pty. Ltd., Suite 3, 41 Stamford Road, Oakleigh, Victoria 3166, Australia, Tel. 61/3 9568 0966, Fax 61/3 9568 0988

Signet Scientific Company, 3401 Aerojet Avenue, El Monte, CA 91731-2882 U.S.A., Tel. (626) 571-2770, Fax (626) 573-2057

GEORGE FISCHER +GF+ Piping Systems

3-5900.090-1/(B-8/99), English

© Signet Scientific Company 1999

Printed in U.S.A. on Recycled Paper

