

Relative pressure transmitter type 520



Pressure range

-1 ... 9 bar / 0 ... 2.5 – 1000 bar



The compact type 520 pressure transmitter is based upon the Huba Control developed thick film technology where the pressure measuring cell is fully welded. This transmitter meets the high burst protection demands and is suitable for the use in all types of refrigerants including ammonia.

- Compact, rugged construction
- Welded without sealing parts, no elastomer seals
- Large selection of connections available.
- Saving time by quick cable mounting by the customer with swift connector

Technical overview

Pressure range	
Relative	-1 ... 9 bar / 0 ... 2.5 – 1000 bar
Operating conditions	
Medium	Liquids, gases and refrigerants (incl. ammonia)
Temperature	Medium -40 ... +135 °C (⊕ -30 ... +120 °C) Ambient -30 ... +85 °C (⊕ -25 ... +85 °C) Storage -50 ... +100 °C
Tolerable overload	≤ 6 bar 5 x fs > 6 bar 3 x fs (max. 1500 bar)
Rupture pressure	≤ 6 bar 10 x fs > 6 bar 6 x fs (max. 2500 bar)

Materials	
Cover	Stainless steel 1.4404 / AISI 316L (inside thread Schrader 1.4305 / AISI 303 only)
Plug accommodation	Polyarylamide 50% GF UL 94 V-0
Materials in contact with medium	Pressure connection Sensor
	Stainless steel 1.4404 / AISI 316L (inside thread Schrader 1.4305 / AISI 303 only) Stainless steel

Electrical overview				
2 wire	Output	Power supply	Load	Current consumption
	4 ... 20 mA	7 ... 33 VDC	< $\frac{\text{supply voltage} - 7V}{0.02 A}$ [Ohm]	< 23 mA
	4 ... 20 mA	10 ... 30 VDC	< $\frac{\text{supply voltage} - 10V}{0.02 A}$ [Ohm]	< 23 mA
3 wire	0 ... 5 V	7 ... 33 VDC	> 10 kOhm / < 100 nF	< 7 mA
	1 ... 6 V	8 ... 33 VDC	> 10 kOhm / < 100 nF	< 7 mA
	0 ... 10 V	12 ... 33 VDC	> 10 kOhm / < 100 nF	< 7 mA
	0 ... 10 V	12 ... 33 VDC / 24 VAC ± 15%	> 10 kOhm / < 100 nF	< 7 mA
	ration. 10 ... 90%	5 VDC ± 10%	> 10 kOhm / < 100 nF	< 7 mA
	⊕ ratiom. 10 ... 90%	5 VDC ± 10%	> 10 kOhm / < 100 nF	< 7 mA
Polarity reversal protection	Short circuit proof and protected against polarity reversal. Each connection is protected against crossover up to max. supply voltage.			
Insulation voltage	standard			500 VDC

Dynamic response	
Response time	< 2 ms, 1 ms typ.
Load cycle	< 100 Hz

Electrical connection		Protection standard	Protection class
Swift connector with or without cable 1.5 / 2.0 / 3.0 / 5.0 m (PVC spec.)		IP 67	III
Connector DIN EN 175301-803-A or C (industrial standard 9.4 mm)		IP 65	III
Metri Pack Serie 150		IP 67	III
Connector M12x1		IP 67	III
Braids		IP 65	III
Connector RAST 2.5 (3 wire, only)		IP 00	III

Pressure connection		
Inside thread	$\frac{7}{16}$ - 20 UNF	without or with Schrader
	$\frac{1}{2}$ - 14 NPT	(≤ 60 bar)
	G $\frac{1}{4}$	with O-Ring seal FPM (-30 ... +135 °C)
Outside thread	$\frac{7}{16}$ - 20 UNF	sealing cone
	$\frac{1}{4}$ - 18 NPT	
	$\frac{7}{16}$ - 20 UNF	sealed at back SAE 4 with O-Ring seal FPM (-20 ... +135 °C)
	G $\frac{1}{4}$	sealed at back DIN 3852-E with profile seal ring in FPM (-30 ... +135 °C)
	G $\frac{1}{4}$	sealed at back and manometer (combi) with profile seal ring in FPM (-30 ... +135 °C) (≤ 60 bar)
	R $\frac{1}{4}$	EN 10226
	G $\frac{1}{2}$	sealed at back and manometer (combi) with profile seal ring in FPM (-30 ... +135 °C)
	$\frac{1}{8}$ - 27 NPT	(≤ 60 bar)
	G $\frac{1}{8}$	sealed at front (≤ 60 bar)
	G $\frac{1}{4}$	sealed at back DIN 3852-E with profile seal ring in FPM (-30 ... +135 °C) (> 60 bar - without UL and ATEX certificate)
	M10x1	sealed at back DIN 3852-E with Profile seal ring in FPM (-30 ... +135 °C) (≤ 60 bar)
M20x1.5	sealed at front and manometer (combi)	
G $\frac{1}{2}$, G $\frac{1}{4}$	sealed at front	

Installation arrangement	
Unrestricted	

Tests / Admissions	
Electromagnetic compatibility	CE conformity acc. EN 61326-2-3
Enhanced EMC protection	EN 50121-3-2
Shock acc. IEC 68-2-27	100 g, 11 ms half sine wave, all 6 directions, free fall from 1 m on concrete (6x)
Constant shock acc. IEC 68-2-29	40 g for 6 ms, 1000x all 3 directions
Vibration acc. IEC 68-2-6	20 g, 15 ... 2000 Hz, 15 ... 25 Hz with amplitude ± 15 mm, 1 Octave/min. all 3 directions, 50 constant load
UL	ANSI/UL 61010-1 acc. E325110
Drinking water approval	NSF/ANSI 61/372 acc. MH60087
EAC	

Protection against explosion ⊕		ration. 10 ... 90%	4 ... 20 mA
Intrinsic safety "i"	Ex II 1/2 G Ex ia IIC T4 Ga/Gb	Ex II 1/2 G Ex ia IIC T4 Ga/Gb	Ex II 1/2 G Ex ia IIC T4 Ga/Gb
	Ex II 1/2 D Ex ia IIC T125°C Da/Db	Ex II 1/2 D Ex ia IIC T125°C Da/Db	Ex II 1/2 D Ex ia IIC T125°C Da/Db
EC type examination certificate	SEV 15 ATEX 0173	SEV 10 ATEX 0145	SEV 10 ATEX 0145
Connection to certified intrinsically safe resistive circuits with maximum values	Ui ≤ 15 VDC; Ii ≤ 200 mA; Pi ≤ 750 mW	Ui ≤ 30 VDC; Ii ≤ 100 mA; Pi ≤ 750 mW	Ui ≤ 30 VDC; Ii ≤ 100 mA; Pi ≤ 750 mW
Effective internal inductance and capacitance for versions with plugs complying with EN 175301-803-A or M12x1	Li = 0 nH; Ci ≤ 150 nF	Li = 0 nH; Ci = 0 nF	Li = 0 nH; Ci = 0 nF
IECEx		SEV 16.0007	

Weight	
~ 90 g	

Packaging (Please state on order)	
Single packaging in cardboard	accessories integrated
Multiple packaging in cardboard (25 pcs)	

Accuracy

Parameter	Unit	
Characteristic line ¹⁾	% fs	± 0.3
Resolution	% fs	0.1
Thermal characteristic ²⁾	max. % fs/10K	± 0.2
Long term stability acc. IEC EN 60770-1	max. % fs	± 0.25

Test conditions: 25 °C, 45% RH, power supply 24 VDC

Order code selection table in bar		1	2	3	4	5	6	7	8	9	10	11	
		520.	X	X	X	X	X	X	X	X	X	X	
Pressure range ³⁾	-1 ... 9 bar	9	0	6									
	0 ... 2.5 bar	9	1	4									
	0 ... 4 bar	9	1	5									
	0 ... 6 bar	9	1	7									
	0 ... 10 bar	9	3	0									
	0 ... 16 bar	9	3	1									
	0 ... 25 bar	9	3	2									
	0 ... 40 bar	9	3	3									
	0 ... 60 bar	9	4	0									
	0 ... 100 bar	9	4	1									
	0 ... 160 bar	9	4	2									
	0 ... 250 bar	9	4	3									
0 ... 400 bar	9	5	4										
0 ... 600 bar	9	5	5										
0 ... 1000 bar	9	5	7										
Application	standard					S	0						
	for oxygen applications					S	1			0			
	with drinking water approval NSF 61					S	4			0	1		
Output / power supply	0 ... 5 V	7 ... 33 VDC						1					
	1 ... 6 V	8 ... 33 VDC						6					
		12 ... 33 VDC						2					
	0 ... 10 V	12 ... 33 VDC Enhanced EMC protection						C	1,2,3				
		12 ... 33 VDC / 24 VAC ±15% (not possible with M12x1, metri Pack, RAST, braids)						8					
	ration. 10 ... 90%	5VDC ±10%						7					
		5VDC ±10% Ex protection					0,4	9	1,3		1		
Electrical connection	4 ... 20 mA	7 ... 33 VDC						3					
		7 ... 33 VDC Enhanced EMC protection (not possible with Braids)						A					
		10 ... 30 VDC Ex protection					0,4	4	1,3		1		
	Connector ⁴⁾	DIN EN 175301-803-A									1		
		DIN EN 175301-803-C (industrial standard 9.4 mm)									2		
		M12x1 2w: IN=1 / OUT=3 3w: IN=1 / OUT=4 / GND=3									3		
		M12x1 2w: IN=1 / OUT=4 3w: IN=1 / OUT=3 / GND=4									M		
		M12x1 2w: IN=1 / OUT=2 3w: IN=1 / OUT=2 / GND=3									P		
		RAST 2.5						0,4	7	4			
	Braids	Metri Pack Serie 150						0,4	5				
80 ±10 mm							0,4	6					
290 ±10 mm							0,4	7					
480 ±10 mm							0,4	8					
730 ±10 mm							0,4	9					
Swift connector	without cable									0			
	with cable 1.5 m									L			
	with cable 2.0 m									N			
	with cable 3.0 m									Q			
	with cable 5.0 m									R			
Pressure connection ³⁾	Inside thread	7/16-20 UNF sealing cone with schrader					0,4			0	0	N	
		7/16-20 UNF sealing cone								K		1	
		1/2 -14 NPT ⁵⁾								D		1	
		G 1/4 with O-Ring seal FPM									1		1
	Outside thread	7/16 -20 UNF sealing cone									2		1
		1/4 -18 NPT									3		1
		G 1/4 sealed at back DIN 3852-E with profile seal ring in FPM									4		1
		G 1/4 sealed at back and manometer with profile seal ring in FPM									5	0	1
		R 1/4 acc. to EN 10226									7		1
		G 1/2 sealed at back and manometer with profile seal ring in FPM						0,1			8		1
		7/16-20 UNF sealed at back SAE 4 with O-Ring seal FPM									G		1
		1/8 - 27 NPT ⁵⁾									A		1
		G 3/8 sealed at front ⁵⁾									M		1
		G 1/2 sealed at back DIN 3852-E with Profile seal ring in FPM ⁶⁾						0,1			H		1
		M10x1 sealed at back DIN 3852-E with profile seal ring in FPM ⁵⁾						0,1			F		1
		M20x1.5 sealed at front and manometer (combi)									E		1
G 1/4 sealed at front									J		1		
G 1/2 sealed at front									9		1		
Pressure orifice	without (inclusive pressure tip orifice from 100 bar on)										0		
	with										2		
Material	Stainless steel 1.4305 / AISI 303											N	
pressure connection	Stainless steel 1.4404 / AISI 316L											1	
Pressure range variation (optional)	Indicate W and state range on order (e.g.: W0... + 3bar/OUT0...5V)											W	

¹⁾ typ. ; max. 0.5% fs (incl. zero point, full scale, linearity, hysteresis and repeatability) ²⁾ -15 ... 85 °C ³⁾ Other pressure ranges or pressure connections on request ⁴⁾ Delivery without female connector ⁵⁾ (≤ 60 bar) ⁶⁾ Rupture pressure 1000 bar

Order code selection table in psi		1	2	3	4	5	6	7	8	9	10	11	
		520.	X	X	X	X	X	X	X	X	X	X	
Pressure range ¹⁾	-15 ... 130 psi	9	A	6									
	0 ... 30 psi	9	B	4									
	0 ... 60 psi	9	B	4									
	0 ... 100 psi	9	B	7									
	0 ... 200 psi	9	C	1									
	0 ... 300 psi	9	C	2									
	0 ... 500 psi	9	C	3									
	0 ... 750 psi	9	D	0									
	0 ... 1000 psi	9	D	1									
	0 ... 2000 psi	9	D	2									
	0 ... 3000 psi	9	D	3									
	0 ... 5000 psi	9	E	4									
	0 ... 7500 psi	9	E	5									
0 ... 14500 psi	9	E	7										
Application	standard					S	0						
	for oxygen applications					S	1			0			
	with drinking water approval NSF 61					S	4			0	1		
Output / power supply	0 ... 5 V								1				
	1 ... 6 V								6				
									2				
	0 ... 10 V								C	1,2,3			
										8			
	ration. 10 ... 90%								7				
								0,4	9	1,3		1	
	4 ... 20 mA								3				
Electrical connection	Connector ²⁾	10 ... 30 VDC Ex protection							A				
		7 ... 33 VDC							4	1,3		1	
		7 ... 33 VDC Enhanced EMC protection (not possible with Braids)											
		DIN EN 175301-803-A											1
		DIN EN 175301-803-C (industrial standard 9.4 mm)											2
		M12x1 2w: IN=1 / OUT=3 3w: IN=1 / OUT=4 / GND=3											3
	Braids	M12x1 2w: IN=1 / OUT=4 3w: IN=1 / OUT=3 / GND=4											M
		M12x1 2w: IN=1 / OUT=2 3w: IN=1 / OUT=2 / GND=3											P
		RAST 2.5						0,4	7	4			
		Metri Pack Serie 150 ³⁾							0,4	5			
		80 ±10 mm							0,4	6			
		290 ±10 mm								0,4	7		
		480 ±10 mm								0,4	8		
Swift connector	730 ±10 mm							0,4	9				
	without cable											0	
	with cable 1.5 m											L	
	with cable 2.0 m											N	
	with cable 3.0 m											Q	
Pressure connection ¹⁾	Inside thread	with cable 5.0 m										R	
		¾-20 UNF sealing cone with schrader					0,4				0	0	N
		¾-20 UNF sealing cone											K
		½ -14 NPT ³⁾											D
	Outside thread	G ¼ with O-Ring seal FPM											1
		¾-20 UNF sealing cone											2
		¼ -18 NPT											3
		G ¼ sealed at back DIN 3852-E with profile seal ring in FPM											4
		G ¼ sealed at back and manometer with profile seal ring in FPM											5
		R ¼ acc. to EN 10226											7
		G ½ sealed at back and manometer with profile seal ring in FPM							0,1				8
		¾-20 UNF sealed at back SAE 4 with O-Ring seal FPM											G
		¾ - 27 NPT ³⁾											A
		G ½ sealed at front ³⁾											M
		G ½ sealed at back DIN 3852-E with Profile seal ring in FPM ⁴⁾							0,1				H
		M10x1 sealed at back DIN 3852-E with profile seal ring in FPM ³⁾							0,1				F
		M20x1.5 sealed at front and manometer (combi)											E
G ¼ sealed at front											J		
G ½ sealed at front											9		
Pressure orifice	without (inclusive pressure tip orifice from 2000 psi on)											0	
	with											2	
Material pressure connection	Stainless steel 1.4305 / AISI 303											N	
	Stainless steel 1.4404 / AISI 316L											1	
Pressure range variation (optional)	Indicate W and state range on order (e.g.: W0... + 400psi/OUT0...5V)											W	

¹⁾ Other pressure ranges or pressure connections on request

²⁾ Delivery without female connector

³⁾ (≤ 870 psi)

⁴⁾ Rupture pressure 14500 psi

Order code selection table in MPa		1	2	3	4	5	6	7	8	9	10	11	
		520.	X	X	X	X	X	X	X	X	X	X	
Pressure range ¹⁾	-0.1 ... 0.9 MPa	9	F	6									
	0 ... 0.25 MPa	9	G	4									
	0 ... 0.4 MPa	9	G	5									
	0 ... 0.6 MPa	9	G	7									
	0 ... 1 MPa	9	H	0									
	0 ... 1.6 MPa	9	H	1									
	0 ... 2.5 MPa	9	H	2									
	0 ... 4 MPa	9	H	3									
	0 ... 6 MPa	9	K	0									
	0 ... 10 MPa	9	K	1									
	0 ... 16 MPa	9	K	2									
	0 ... 25 MPa	9	K	3									
	0 ... 40 MPa	9	L	4									
	0 ... 60 MPa	9	L	5									
0 ... 100 MPa	9	L	7										
Application	standard					S	0						
	for oxygen applications					S	1				0		
	with drinking water approval NSF 61					S	4				0	1	
Output / power supply	0 ... 5 V								1				
	1 ... 6 V								6				
									2				
	0 ... 10 V								C	1,2,3			
										8			
	ration. 10 ... 90%	5VDC ±10%							7				
		5VDC ±10% Ex protection					0,4		9	1,3		1	
4 ... 20 mA	7 ... 33 VDC								3				
	7 ... 33 VDC Enhanced EMC protection (not possible with Braids)								A				
	10 ... 30 VDC Ex protection					0,4		4	1,3		1		
Electrical connection	Connector ²⁾	DIN EN 175301-803-A								1			
		DIN EN 175301-803-C (industrial standard 9.4 mm)								2			
		M12x1 2w: IN=1 / OUT=3 3w: IN=1 / OUT=4 / GND=3									3		
		M12x1 2w: IN=1 / OUT=4 3w: IN=1 / OUT=3 / GND=4									M		
		M12x1 2w: IN=1 / OUT=2 3w: IN=1 / OUT=2 / GND=3									P		
		RAST 2.5					0,4	7	4				
	Braids	Metri Pack Serie 150 ³⁾					0,4		5				
		80 ±10 mm					0,4		6				
		290 ±10 mm					0,4		7				
		480 ±10 mm					0,4		8				
	Swift connector	730 ±10 mm					0,4		9				
		without cable								0			
		with cable 1.5 m								L			
with cable 2.0 m									N				
Pressure connection ¹⁾	Inside thread	with cable 3.0 m							Q				
		with cable 5.0 m							R				
		$\frac{7}{16}$ -20 UNF sealing cone with schrader					0,4				0	0	N
		$\frac{7}{16}$ -20 UNF sealing cone									K		1
	Outside thread	$\frac{1}{2}$ -14 NPT ³⁾									D		1
		G $\frac{1}{4}$ with O-Ring seal FPM									1		1
		$\frac{7}{16}$ -20 UNF sealing cone									2		1
		$\frac{1}{4}$ -18 NPT									3		1
		G $\frac{1}{4}$ sealed at back DIN 3852-E with profile seal ring in FPM									4		1
		G $\frac{1}{4}$ sealed at back and manometer with profile seal ring in FPM									5	0	1
		R $\frac{1}{4}$ acc. to EN 10226									7		1
		G $\frac{1}{2}$ sealed at back and manometer with profile seal ring in FPM					0,1				8		1
		$\frac{7}{16}$ -20 UNF sealed at back SAE 4 with O-Ring seal FPM									G		1
Pressure orifice	$\frac{1}{8}$ -27 NPT ³⁾									A		1	
	G $\frac{1}{8}$ sealed at front ³⁾									M		1	
	G $\frac{1}{8}$ sealed at back DIN 3852-E with Profile seal ring in FPM ⁴⁾					0,1				H		1	
	M10x1 sealed at back DIN 3852-E with profile seal ring in FPM ³⁾					0,1				F		1	
	M20x1.5 sealed at front and manometer (combi)									E		1	
	G $\frac{1}{4}$ sealed at front									J		1	
	G $\frac{1}{2}$ sealed at front									9		1	
Material	without (inclusive pressure tip orifice from 10 MPa on)										0		
	with										2		
pressure connection	Stainless steel 1.4305 / AISI 303											N	
Pressure range variation (optional)	Stainless steel 1.4404 / AISI 316L											1	
	Indicate W and state range on order (e.g.: W0... + 0.3MPa/OUT0...5V)											W	

¹⁾ Other pressure ranges or pressure connections on request

²⁾ Delivery without female connector

³⁾ (≤ 870 psi)

⁴⁾ Rupture pressure 14500 psi

Swift connector	117312
Female connector DIN EN 175301-803-A with seal	103510
Female connector DIN EN 175301-803-C with seal	104244
Corner-wire box for connector M12x1	106975
Corner-wire box for connector M12x1 with cable 2.0 m	114604
Straight-wire box for connector M12x1	114570
Straight-wire box for connector M12x1 with cable 2.0 m	114605
Mounting bracket with screw	118716
Heat sink with outside thread G ½ sealed at front - inside thread G ½	105631
Heat sink with outside thread G ½ sealed at front - inside thread G ¼	105073
Heat sink with outside thread G ¼ sealed at front - inside thread G ¼	105074
Calibration certificate (≤ 600 bar)	104551

Mounting bracket

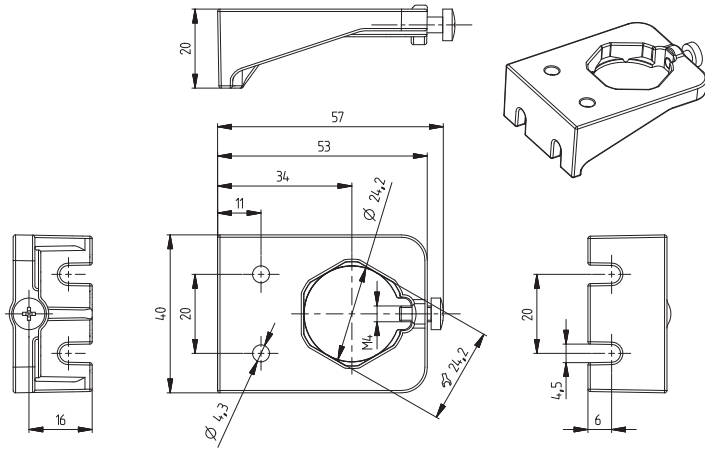

Heat sink

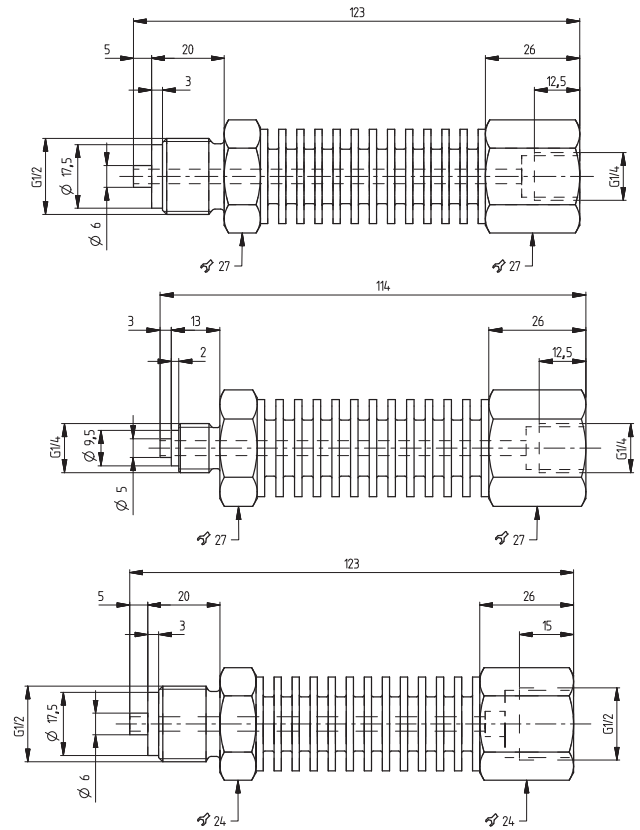

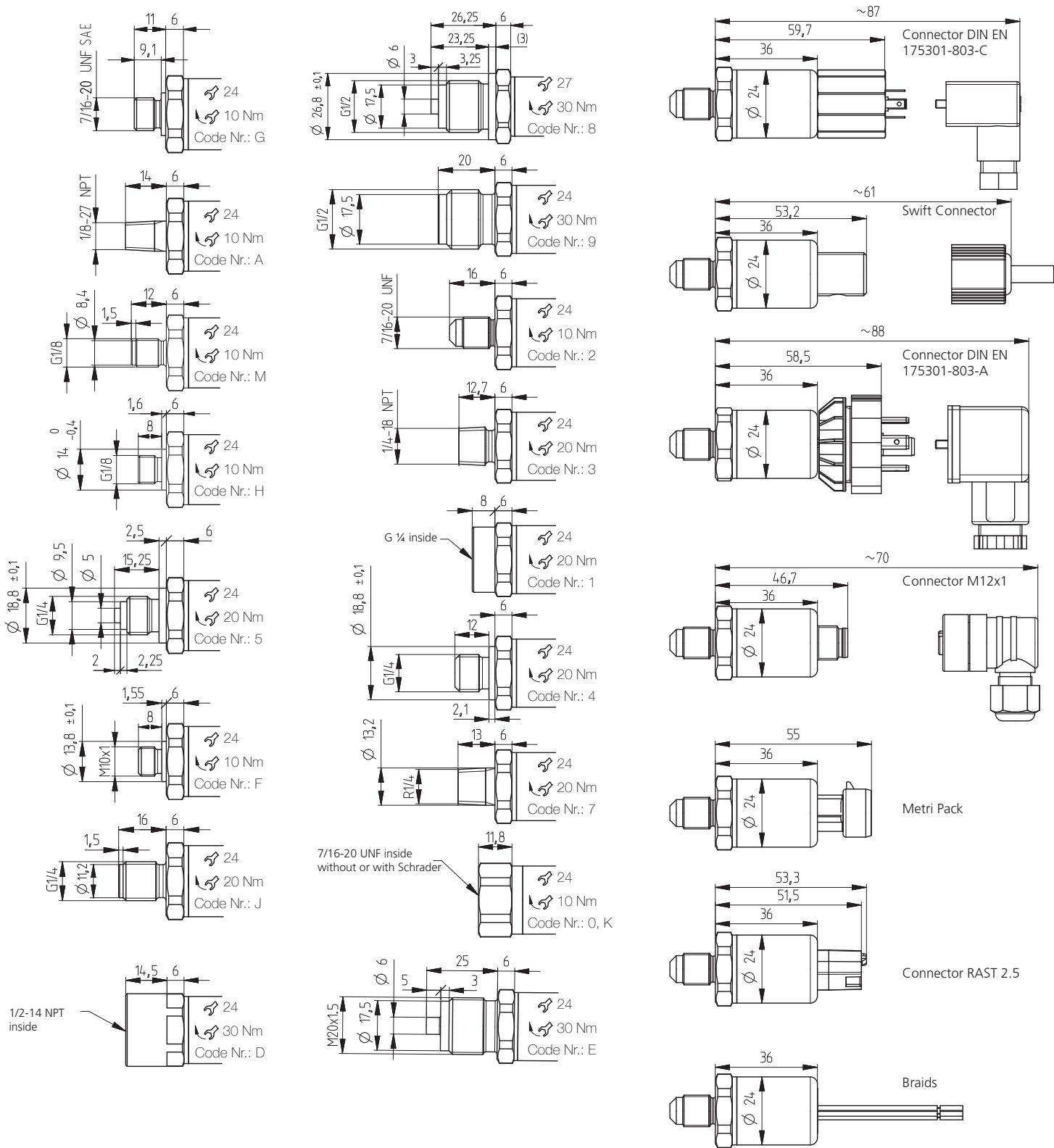

2 wire

Connector DIN
EN 175301-803-A or C

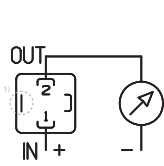

1 (IN) 2 (OUT)

Swift connector

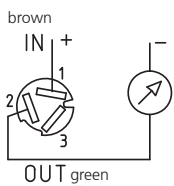

1 (IN) 2 (OUT)

Connector M12x1

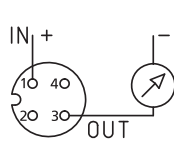

1 (IN) 3 (OUT)

Connector M12x1

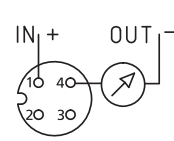

1 (IN) 4 (OUT)

Connector M12x1

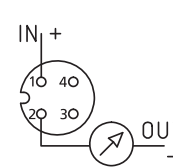

1 (IN) 2 (OUT)

Metri Pack Serie 150

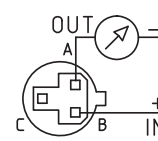

B (IN) A (OUT)

Braids

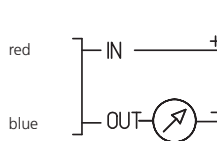

3 wire

Connector DIN
EN 175301-803-A or C

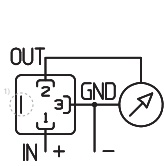

1 (IN) 2 (OUT) 3 (GND)

Swift connector

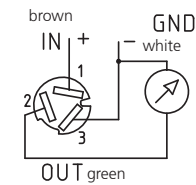

1 (IN) 2 (OUT) 3 (GND)

Connector M12x1

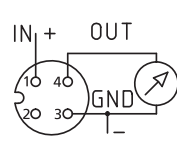

1 (IN) 4 (OUT) 3 (GND)

Connector M12x1

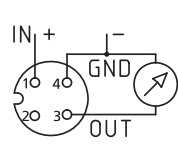

1 (IN) 3 (OUT) 4 (GND)

Connector M12x1

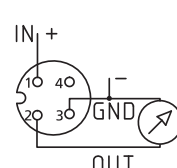

1 (IN) 2 (OUT) 3 (GND)

Metri Pack Serie 150

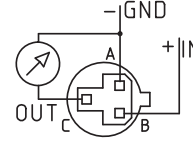

B (IN) C (OUT) A (GND)

Braids

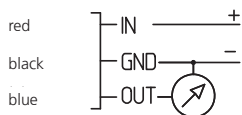

Connector RAST 2.5

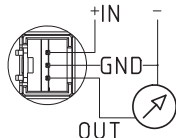

Device design with explosion protection: 4 ... 20 mA
The grounding connection is conductively connected to the transmitter housing.

Connector DIN
EN 175301-803-A

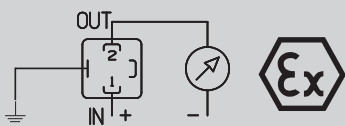

1 (IN) 2 (OUT) ↓

Connector M12x1

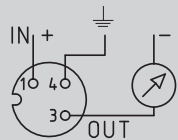

1 (IN) 3 (OUT) 4 (↓)

Device design with explosion protection: ratiom. 10 ... 90%
The electronic GND is connected with a 1MΩ resistor to the transmitter housing.

Connector DIN
EN 175301-803-A

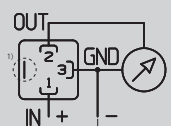

1 (IN) 2 (OUT) 3 (GND)

Connector M12x1

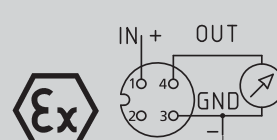

1 (IN) 3 (GND) 4 (OUT)

¹⁾ Not connected with transmitter housing

Huba Control AG
Headquarters

Industriestrasse 17
5436 Würenlos
Telefon +41 (0) 56 436 82 00
Telefax +41 (0) 56 436 82 82
info.ch@hubacontrol.com

Huba Control AG
Niederlassung Deutschland

Schlattgrabenstrasse 24
72141 Walddorfhäslach
Telefon +49 (0) 7127 23 93 00
Telefax +49 (0) 7127 23 93 20
info.de@hubacontrol.com

Huba Control SA
Succursale France

Rue Lavoisier
Technopôle Forbach-Sud
57602 Forbach Cedex
Téléphone +33 (0) 387 847 300
Télécopieur +33 (0) 387 847 301
info.fr@hubacontrol.com

Huba Control AG
Vestiging Nederland

Hamseweg 20A
3828 AD Hoogland
Telefoon +31 (0) 33 433 03 66
Telefax +31 (0) 33 433 03 77
info.nl@hubacontrol.com

Huba Control AG
Branch Office United Kingdom

Unit 13 Berkshire House
County Park Business Centre
Shrivenham Road
Swindon Wiltshire SN1 2NR
Phone +44 (0) 1993 776667
Fax +44 (0) 1993 776671
info.uk@hubacontrol.com