

UMG 103-CBM energy meter with memory



COMPACT, BEST-PRICED
AND SAFETY



UMG 103-CBM energy meter with memory

Large measurement data memory for even more data security

Qualified statements on energy consumption and power quality cannot be achieved with measurements that are restricted just to the point of common coupling (PCC). If one wishes to discover fault sources or energy wasters, it is necessary to acquire data at several points across the grid, i.e. the resolution of the measurement is critical. But this is often a question of space and cost.

The new UMG 103-CBM is the ideal solution for this task. The extremely compact and affordable universal measurement device requires a width of just 71.5 mm on the mounting rail and so fits conveniently into any installation distributor. Along with a large number of energy values and electrical measured values it offers a multitude of additional functions such as the measurement of harmonics, saving of minimum and maximum values, operating hours counter and bi-metallic strip function. It can be operated both as a Slave to a higher-level device, such as the UMG 604E for example, or directly connected with a PC.



Measured data acquisition in the IT sector

A wide variety of application areas is opened due to the clock, battery and memory. It is suitable for the measurement and checking of electrical characteristics, the energy consumption and for monitoring the power quality, e.g. harmonics. Suitable applications include energy distribution systems, cost centre accounting and threshold value monitoring and it can also be used as a measured value transducer for building management systems or PLCs.

UMG 103-CBM energy meter with memory

WE SAFEGUARD YOUR DATA

Local data backup with clock | battery | memory

The Janitza UMG 103-CBM is based on the well-proven technology from the UMG 103. The clock, battery and measured data memory enable this device to tackle completely new applications. On the one hand, data security is significantly increased. This is crucial when energy data is to be acquired

separately for individual company units or customers. On the other hand, the device can operate as a standalone solution in areas where differentiated network monitoring was previously too expensive.

Well-proven technology, new features:
The new UMG 103-CBM with clock,
battery and measured data memory



UMG 103-CBM energy meter with memory

Your benefits

8 advantages for you

- 1 Redundant – Maximum security for your measured data in the device memory
- 2 No separate supply voltage required
- 3 Simple setting of the Modbus address
- 4 Cost-effective and universally applicable
- 5 Simple installation – Rapid installation with Screw-type terminals
- 6 Saves space and costs during installation
- 7 Measurement device itself has a very low power footprint
- 8 Always up-to-date with firmware updates

UMG 103-CBM energy meter with memory

COMPACT UNIVERSALIST

The construction of the UMG 103-CBM is so compact that it can even find a space in heavily equipped distribution board. In doing so, it can operate as a satellite incorporated into a company-wide energy acquisition system or can act just as well as an individual

measurement point. Thanks to the clock, battery and measured value memory, there is no need for a permanent communication link to a PC to save the measured data. Nonetheless, historical and current data are reliably available.

Technical data

Auxiliary voltage up to 277 V

Wide range – can be used in numerous applications

Measured voltage up to 480 V

Precision class

Effective energy class 0.5S (DIN EN62053-22:2003)
for .../5 A current transformer

Voltage and current measurement

Voltage and current measurement inputs

Continuous sampling of the voltage and current measurement inputs

Voltage measurement

Overvoltage category 300 V CATIII

Measurement of positive, negative and zero sequence component

Knowledge of disruptive factors through which motors could be damaged for example

Measurement of the reactive distortion power

Detection of unnecessary current loading, e.g. for distribution boards, transformers up to the consumers



UMG 103-CBM energy meter with memory

HIGHLIGHTS AT A GLANCE

Measured data recording

Measurement and energy data memory

If all profiles are activated, 400,000 measured values can be saved – this represents a period of 144 days.

Clock

Measured data with precise timestamp

Minimum, maximum and working values

Saving of the minimum, maximum and working values

Communication and interface

RS485

- RS485 with ground connection and 3-pole plug (A, B, GND)
- Galvanic separation incl. DC/DC converter

Simple setting of the Modbus address

Clear and intuitive adjustment directly on the device

Additional functions

CREST factor

- Measurement for the power quality
- Fail-safe operation

Comparator

- 2 comparator groups with 3 comparators each (A-C)
- The results of comparators A to C can be combined with AND/OR operators (can be read out via Modbus)

Plenty of memory!

Data:

Voltage L1, L2, L3
Current L1, L2, L3
Power L1, L2, L3
Reactive power L1, L2, L3
Apparent power L1, L2, L3
THD (U) L1, L2, L3
THD (I) L1, L2, L3
Effective energy L1, L2, L3
Reactive energy L1, L2, L3
(27 values) 15 min. intervals, resulting in a **recording period of 144 days**
(15 min * 13824 = 3456 hours (144 days))

Example 1

Data:

Voltage L1, L2, L3
Current L1, L2, L3
Power L1, L2, L3
Reactive power L1, L2, L3
Apparent power L1, L2, L3
THD (U) L1, L2, L3
THD (I) L1, L2, L3
Effective energy L1, L2, L3
Reactive energy L1, L2, L3
(27 values) 1 hour intervals, resulting in a **recording period of 1.5 years**
(1 hour * 13824 = 13824 hours (576 days))

Example 2

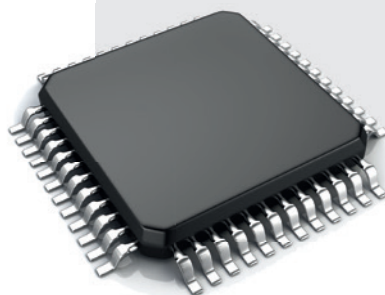

Smart Energy & Power Quality Solutions

Andrei Kholmov / Shutterstock.com

A large industrial robotic arm, painted orange, is shown in a factory setting. The arm is positioned over a metal workpiece, and a bright, glowing shower of sparks is visible at the point of contact, indicating a welding or grinding process. The background features a complex network of metal beams, pipes, and other industrial equipment, all illuminated with a cool blue light. The overall scene conveys a sense of advanced manufacturing and automation.

Inodu

UMG 103-CBM energy meter with memory

INDUSTRIAL REVOLUTION

The UMG 103-CBM: ideal for Industry 4.0 applications

Industry 4.0 - on the one hand this means networking and on the other hand intelligent control deep into the system field. The data collected by the sensors on the tip of the robot arm is transmitted to a development team on the other side of the world. This technology requires a power supply with the highest quality and reliability. Data processing in real-time cannot tolerate voltage dips. It is only logical that the energy supply is not monitored with a multitude of instruments but rather integrated in a single, modern monitoring system – just as the philosophy of Industry 4.0 advocates. Measurement technology specialist Janitza has developed the 3-in-1 Monitoring system for this.

The Janitza product range encompasses all relevant areas:

- Energy management per ISO 50001
(acquisition of V, A, Hz, kWh, kW, kVAh, kvar ...)
- Power quality monitoring (harmonics, flicker, voltage dips, transients, etc.)
- Residual current monitoring (RCM)

The UMG 103-CBM is an ideal building block for measurement data acquisition at the front line. Together with master devices (e.g. UMG 604E or UMG 96RM-E) and the GridVis® software, this allows scalable solutions to be realised. All data is logged centrally in a database and can be recorded and analysed with GridVis®. This not only saves direct costs during purchasing but also simplifies integration, training and maintenance tasks. Because all information can be called up via common, standardised interfaces, the 3-in-1 Monitoring fits perfectly into the Industry 4.0 concept.



Sub-measurements in the process, directly on the machine

stry 4.0

UMG 103-CBM energy meter with memory

Typical application illustration with 2 supplies

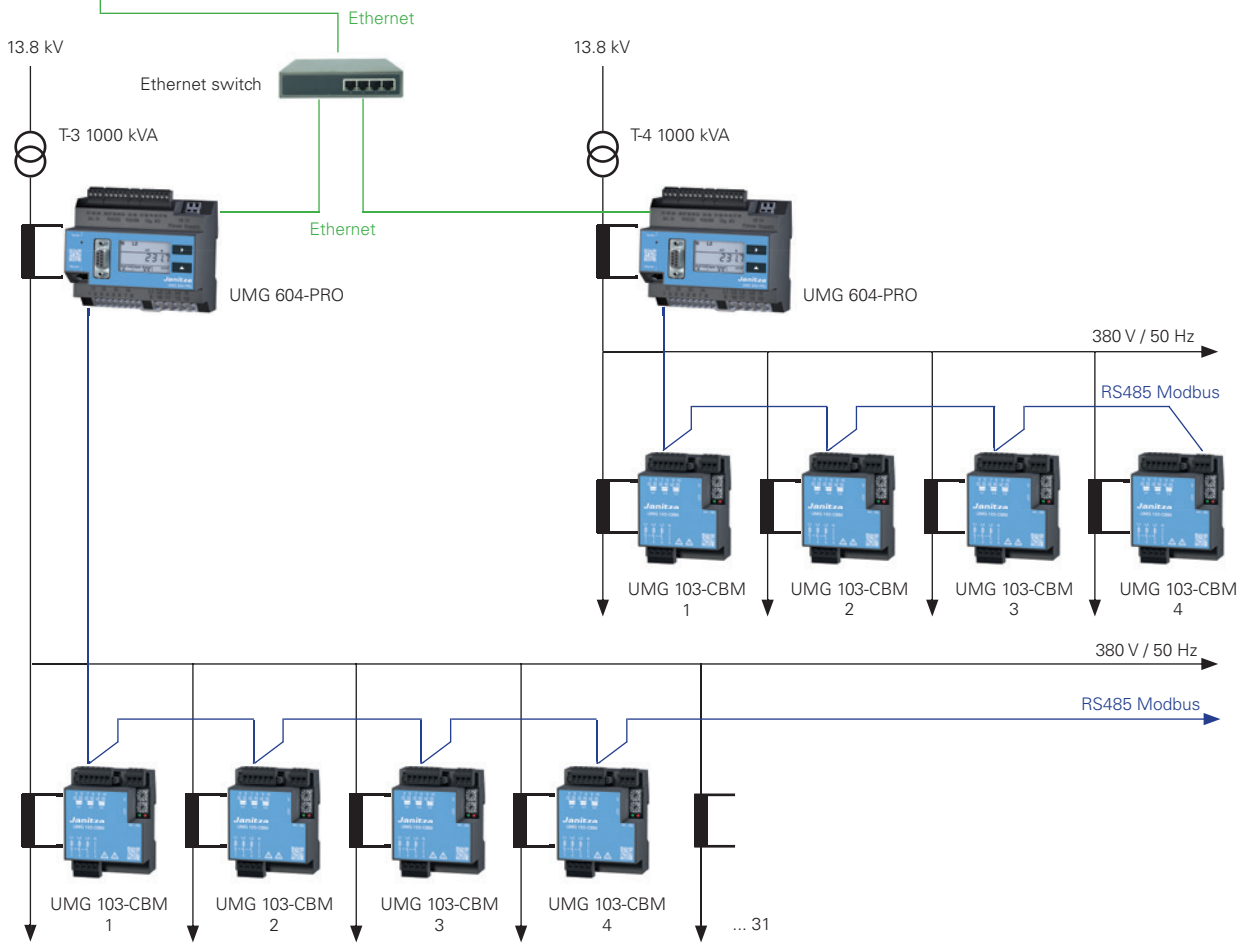
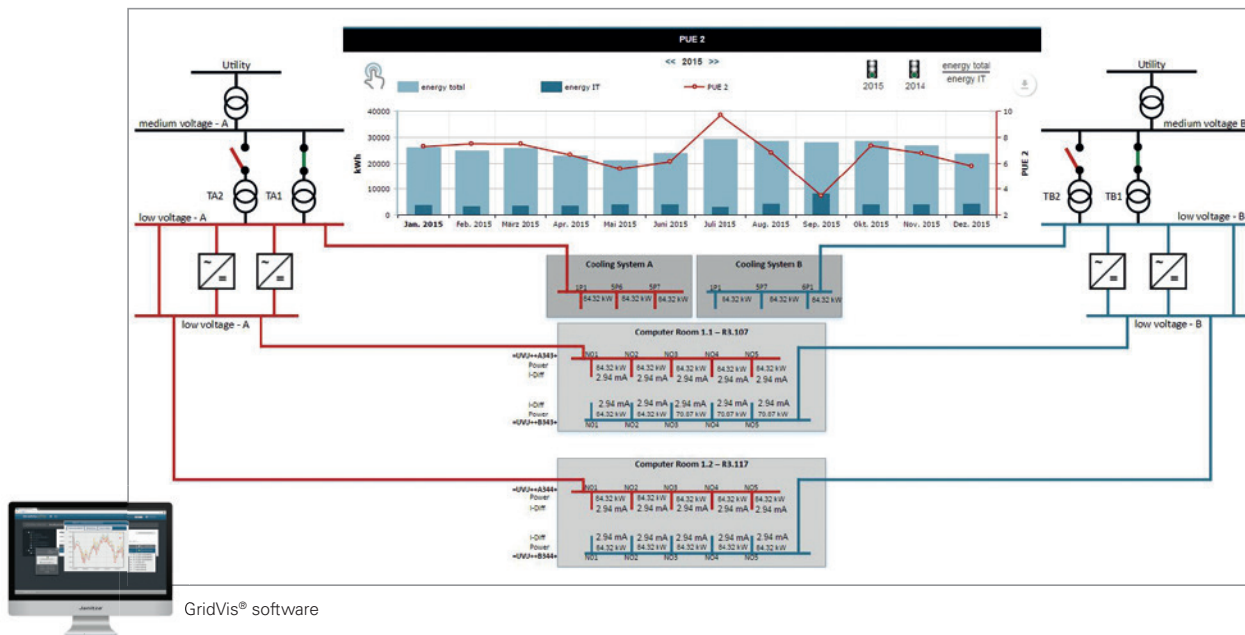
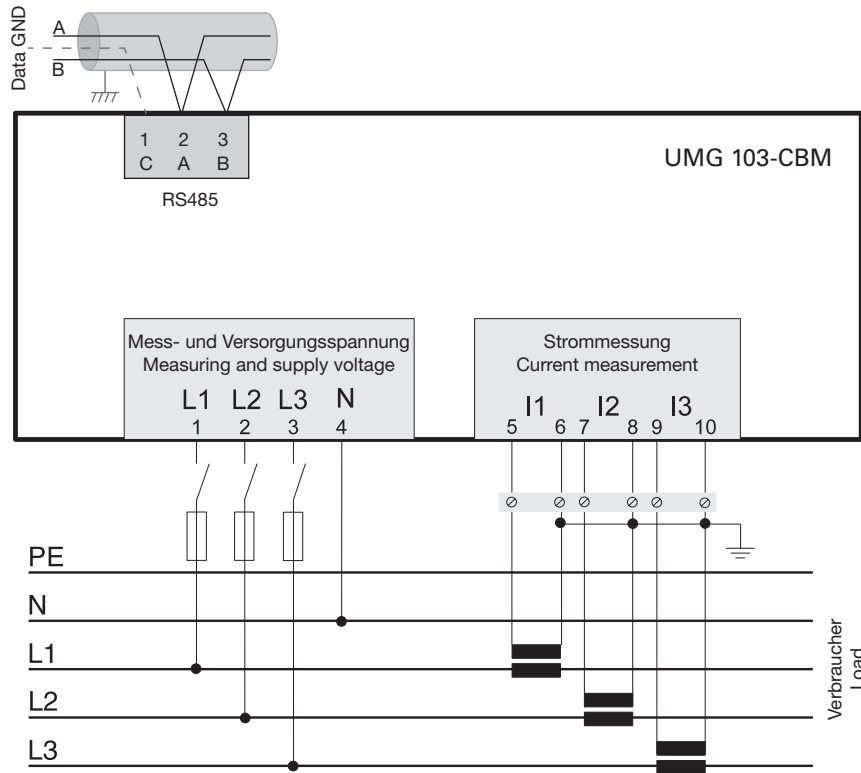

Fig.: Typical application illustration with 2 supplies, UMG 604-PRO as Master measurement device in the main supply and UMG 103-CBM for measuring the low voltage outputs.

UMG 103-CBM energy meter with memory

Connection diagram



Dimension diagrams

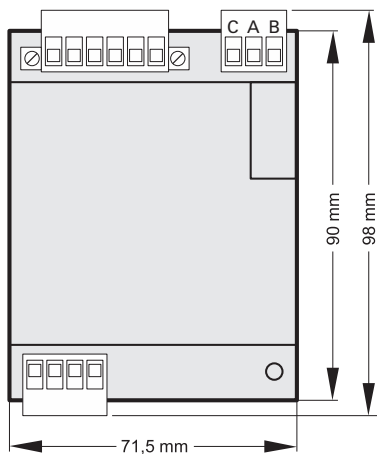

Front view

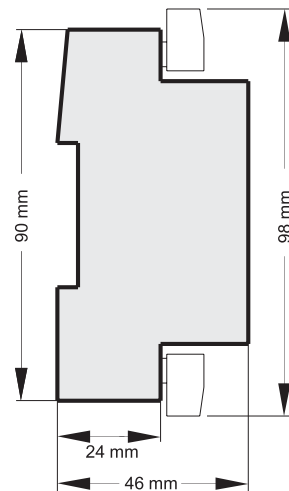

Side view

UMG 103-CBM energy meter with memory

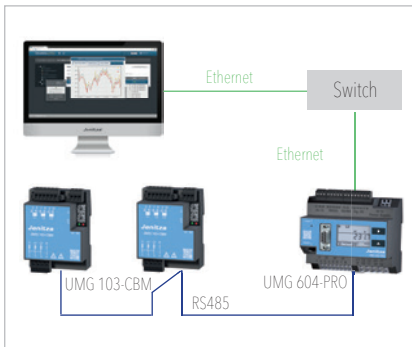

Connection of multiple UMG 103-CBMs to a PC via a UMG 604-PRO (with Ethernet option)

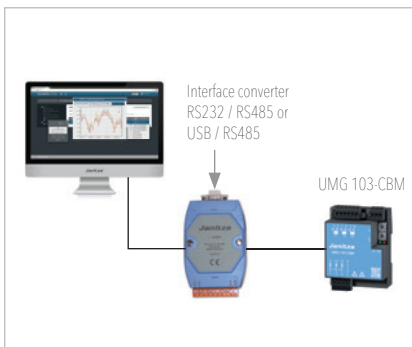

Connection of a UMG 103-CBM to a PC via an interface converter

UMG 103-CBM

Item no. 52.28.001

Auxiliary voltage

Supply from single phase	115 – 277 V AC (+- 10%), 50/60 Hz
Supply from three phases	80 – 277 V AC (+- 10%), 50/60 Hz

General

Use in low and medium voltage networks	•
Accuracy of voltage measurement	0.2 %
Accuracy of current measurement	0.5 %
Accuracy of active energy (kWh, .../5 A) measurement	Class 0.5S
Number of measurement points per period	108
Uninterrupted measurement	•

RMS - momentary value

Current, voltage, frequency	•
Active, reactive and apparent power / total and per phase	•
Power factor / total and per phase	•

Energy measurement

Active, reactive and apparent energy [L1,L2,L3, Σ L1-L3]	•
Number of tariffs	4

Recording of the mean values

Voltage, current / actual and maximum	•
Active, reactive and apparent power / actual and maximum	•
Frequency / actual and maximum	•
Requirement calculation mode (bi-metallic function) / thermal	•

Other measurements

Operating hours measurement	•
-----------------------------	---

Measurement of the power quality

Harmonics per order / current	1. – 25th.
Harmonics per order / voltage	1. – 25th.
Distortion factor THD-U in %	•
Distortion factor THD-I in %	•
Current and voltage, positive, zero and negative sequence component	•

Measured data recording

Current measurement channel	3
Recording period	Up to 144 days
Memory (Flash)	4 MB
Battery	BR1632 A
Clock	•
Online readout with GridVis®	•
Mean, minimum, maximum values	•

Interfaces

RS485: Autobaud, 9.6 – 115.22 kbps (Screw-type terminal)	•
--	---

Protocols

Modbus RTU	•
------------	---

Databases (Janitza DB, Derby DB) supported by GridVis®-Basic

Manual reports (energy, power quality)	•
Topology views	•
Manual read-out of the measuring devices	•
Graph sets	•

Programming / threshold values / alarm management

Comparator (2 Groups with 3 comparators each)	•
---	---

UMG 103-CBM energy meter with memory

Technical data

Type of measurement	Continuous real effective value measurement up to the 25th harmonic
Nominal voltage, three-phase, 4-conductor	Up to max. 277 / 480 V AC (+ 10%)
Measurement in quadrants	4
Networks	TN, TT

Measured voltage input

Overvoltage category	300 V CAT III
Metering range, voltage L-N, AC (without transformer)	80 - 277 Vrms (+/- 10%)
Metering range, voltage L-L, AC (without transformer)	80 - 480 Vrms (+/- 10%)
Resolution	0.01 V
Frequency measuring range	45 to 65 Hz
Power consumption	1,5 VA
Measurement surge voltage	4 kV
Sampling rate	5.4 kHz / phase

Measured current input

Rated current	1 / 5 A
Resolution	0.1 mA
Metering range	0.005 - 6 Amps
Overvoltage category	300 V CAT II
Measurement surge voltage	2 kV
Power consumption	approx. 0.2 VA (Ri = 5 mOhm)
Overload for 1 sec.	60 A (sinusoidal)
Sampling rate	5.4 kHz / phase

Mechanical properties

Weight	200 g
Device dimensions in mm (H x W x D)	Approx. 98 x 71.5 x 46
Protection class per EN 60529	IP20
Assembly per IEC EN 60999-1 / DIN EN 50022	35-mm DIN rail
Connecting phase (U / I), Single core, multi-core, fine-stranded	0.08 to 2.5 mm ²
Terminal pins, core end sheath	1.5 mm ²

Environmental conditions

Temperature range	Operation: K55 (-25 ... +60 °C)
Relative humidity	Operation: 5 to 95 % (at 25 °C)
Operating altitude	0 to 2,000 m above sea level
Pollution degree	2
Mounting position	any

Software GridVis® Basic*1

Online graphs	•
---------------	---

Firmware

Firmware update	Update via GridVis® software. Firmware download (free of charge) from the website: http://www.janitza.de
-----------------	---

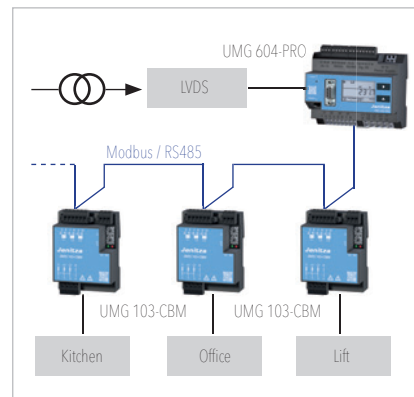

Topology example UMG 604-PRO (Master) – UMG 103-CBM (Slave)

Comment:

For detailed technical information, please refer to the operation manual and the Modbus address list.

• = included - = not included

*1 Optional additional functions with the packages GridVis®-Professional, GridVis®-Service and GridVis®-Ultimate.

ENERGY MONITORING "MADE IN

Digital integrated measurement devices

Individual, tailored solutions for RCM, energy and power quality measurement technology to meet every requirement

Energy measurement devices

GridVis® network visualisation software

Software for the development of an RCM, energy and power quality monitoring system. Both PC and web-based solutions are available.

GridVis®

Energy-Portal (SaaS)

The Cloud solution for your energy management

Energy portal

APPs

Software-based developments with 'know-how'

APPs



MONITORING SYSTEMS MADE IN GERMANY"



Log energy data, display energy consumption, reduce costs

Nowadays, energy management is not only relevant for the environment and for society but is also a critical competitive factor. Only those who can keep a close eye on their energy consumption can reduce costs and increase efficiency. To ensure optimum use of the measurement devices, Janitza offers the corresponding accessories and tailored software - a complete package that guarantees efficient energy management.

The comprehensive Janitza product portfolio ranges from the current transformer and measurement device, from the communications devices and the IT environment, right through to software solutions and databases including data analyses and evaluations. After formulating the technical solution, on request Janitza provides support throughout the entire product life cycle. **For more information visit our website at www.janitza.com**



Current transformers

The link between heavy current and digital technology

Service

Janitza provides support with selection, maintenance and support of the systems

Commissioning

Commissioning of the monitoring systems

Training

Training of the personnel

Janitza electronics GmbH
Vor dem Polstück 6 | 35633 Lahnau
Germany

Tel.: +49 6441 9642-0
Fax: +49 6441 9642-30
info@janitza.de | www.janitza.com

Sales partner

Item no.: 33.03.722 • Doc. no.: 2.500.119.5 • Version 04/2018 • Subject to technical alterations.
The latest version of the brochure is available at www.janitza.com