



# Displacement Type Level Switch

Model : SMC



**SeoJin Instech Co., Ltd.**

[www.seojin.biz](http://www.seojin.biz)



SMC

### Principle

A vertical displacement is induced on Rod and Core, which are connected to the Displacer and Spring, due to a change in the spring tension that results from a change in the buoyancy of the Displacer when the liquid level changes. The vertical displacement of the core causes magnet "A" to move away from the Lead Pipe actuating Micro-switch.

### Features

- SMC type Level Switch can be used to prevent an overflow of liquids in a variety of tanks by starting a draining pump or stopping a filling pump.
- Safe actuation of the switch is accomplished since the switching parts are completely separated from the tank.
- Setting of High and Low contact points is flexible, and the cost of equipment does not depend heavily on measurement distance.
- Switching point can be adjustable by moving float to up and down only.

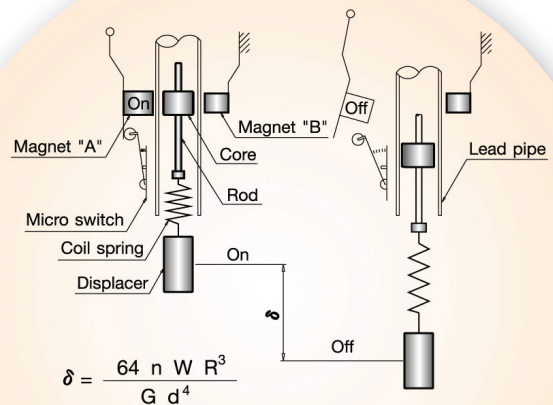

- $\delta$  : Displacement (mm)
- G : Modulus of Elasticity (kg/mm<sup>3</sup>)
- d : Wire Diameter (mm)
- n : Number of Coils
- W : Load (kg)
- R : Radius of Coil (mm)

## Specifications

DESCRIPTION		SMC series
Application	Liquid	
Specific Gravity	0.7 ~ 1.3	
Ambient Temperature	-40 ~ +80°C	
Process Temperature	-40 ~ +230°C (Cooling Fin from 200°C)	
Pressure	30 kgf/cm <sup>2</sup> (Max.)	
Enclosure	Weather Proof Explosion Proof	
Output	1 ~ 4 SPDT, 1 ~ 4 DPDT	
Range	5 m Max.	
Switch Type	Micro Switch	
Contact Rating	(High temp') 250V AC 5A, (General) 250V AC 10A	
Cable Gland	PF 1/2", PF 3/4"	
Material	Housing	ADC, AC, C.S
	Flange	C.S, 304SS, 316SS
	Spring	Inconel
	Chain	304SS & 316LSS & Monel
	Displacer	304SS & 316LSS & Monel
	Ex. Proof	Ex d IIC T6, IP66

## Structure

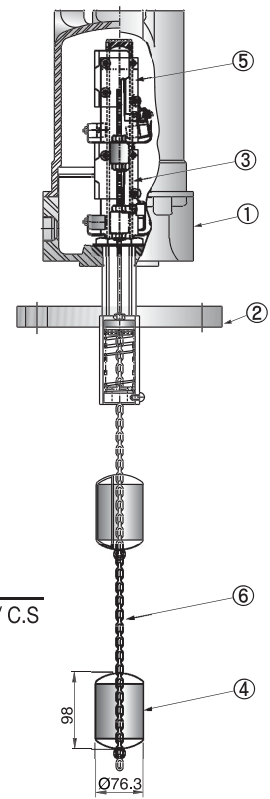

NO.	NAME OF PART	MATERIAL
①	HOUSING ASS'Y	ADC / AC / C.S
②	FLANGE	304SS
③	SET PLATE ASS'Y	304SS
④	DISPLACER	304SS
⑤	MICRO SWITCH	
⑥	CHAIN	304SS

## Control

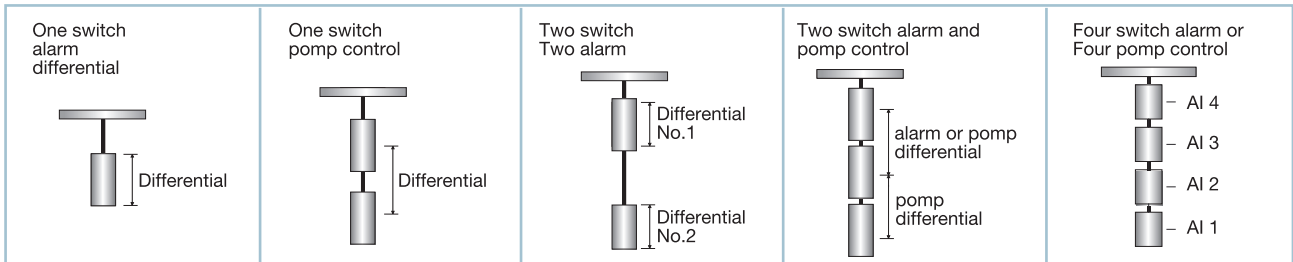

## Table for Chamber Selection

SIDE-SIDE (FLANGE)	SIDE-SIDE (SW)	SIDE-BOTTOM (FLANGE)	SIDE-BOTTOM (SW)

## Number of Contact for Control

1. 1 Point(Alarm~SPDT) : HH or LL Alarm

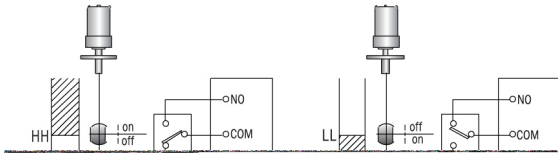

2. 1 Point(Alarm~DPDT) : HH or LL Alarm

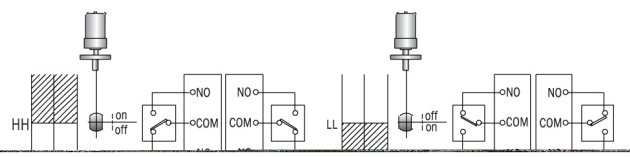

3. 2 Point(Alarm~SPDT) : HH or LL Alarm

4. 2 Point(Alarm~DPDT) : HH or LL Alarm

5. 2 Point Control~SPDT) : H and L Control

6. 2 Point Control~DPDT) : H and L Control

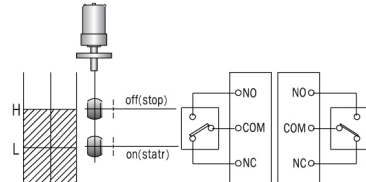
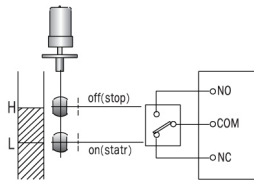

7. 3 Point (Control and Alarm ~ SPDT) : Control and HH(LL)

8. 3 Point (Control and Alarm ~ DPDT) : Control and HH(LL)

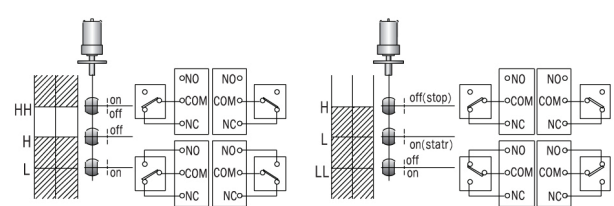
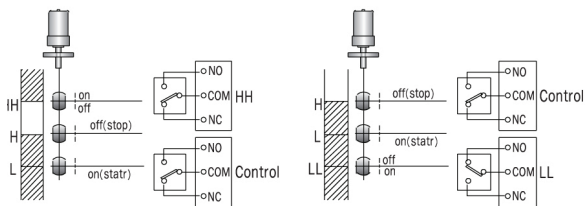

## Number of Contact for Control

9. 3 Point(Alarm~SPDT) : HH(LL), H, L Alarm

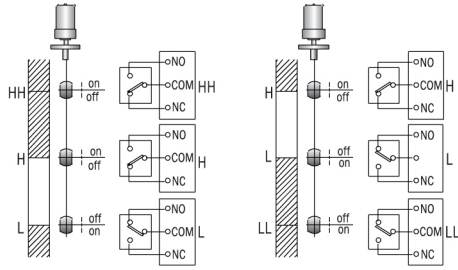

10. 3 Point(Alarm~DPDT) : HH(LL), H, L Alarm

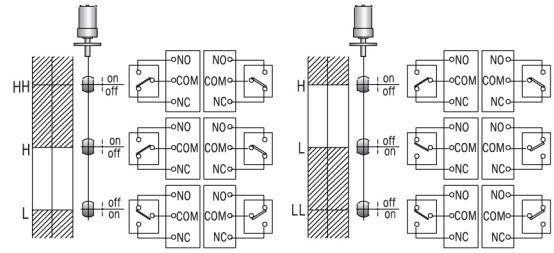

11. 4 Point(Alarm and Control~SPDT) : HH, LL and Control

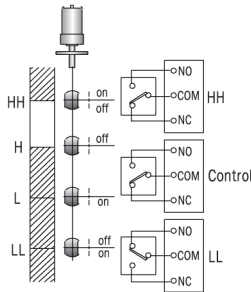

12. 4 Point(Alarm and Control~DPDT) : HH, LL and Control

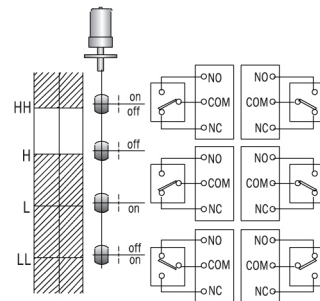

13. 4 Point(Alarm ~SPDT) : HH, H, L, LL Alarm

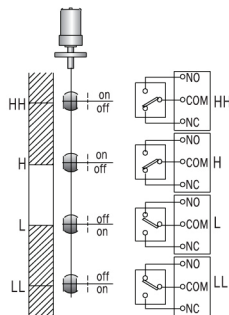

14. 4 Point(Alarm ~DPDT) : HH, H, L, LL Alarm

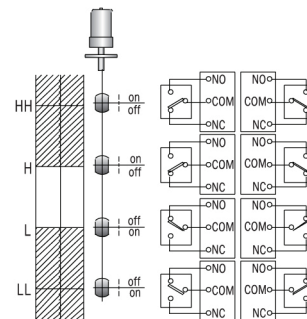

15. 4 Point(2 Control~SPDT) : 1 Control and 1 Control

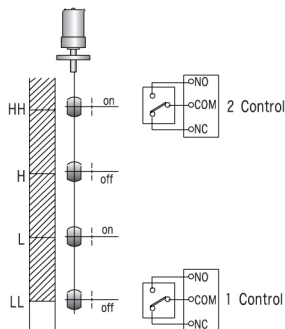

16. 4 Point(2 Control~DPDT) : 1 Control and 1 Control

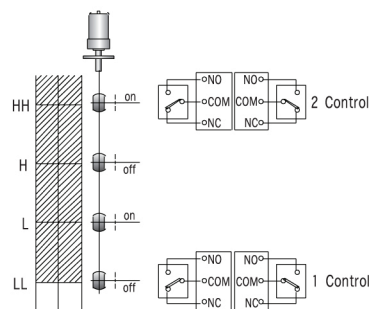

## Ordering Information

### ■ Displacement Type Level Switch

SMC- 1 A 1 A 1 A

#### CONDUIT CONNECTION

A = PF 3/4" (Std.)  
 B = PT 3/4"  
 C = PF 1/2"  
 D = PT 1/2"  
 E = NPT1/2"  
 F = NPT3/4"  
 OP = etc.

#### ENCLOSURE

1 = Weather proof (Std.) - C.S Cover  
 2 = Weather proof - AC Cover  
 3 = Explosion proof ( Ex d IIC T6 IP66) - AC Cover

#### MOUNTING SIZE

A = JIS 10K 80A 304SS 6t Flange (Std.)  
 B = JIS 10K 100A 304SS 6t Flange (Std.)  
 C = JIS 10K 80A FF C.S Flange  
 D = JIS 10K 100A FF C.S Flange  
 E = JIS 10K 80A FF 304SS Flange  
 F = JIS 10K 100A FF 304SS Flange  
 OP = etc.

#### WET PART MATERIAL

1 = 304SS (Std.)  
 2 = 316LSS  
 3 = Monel (Special Option)

#### OPERATING TEMP' & PRESSURE

A = -40 ~ +120°C & 10Kgf/cm<sup>2</sup> (Std.)  
 B = -40 ~ +230°C & 30Kgf/cm<sup>2</sup> (1S, 2S)  
 C = -40 ~ +230°C & 30Kgf/cm<sup>2</sup> (3S)  
 D = -40 ~ +230°C & 30Kgf/cm<sup>2</sup> (4S)  
 (High temp') 250V AC 5A  
 (General) 250V AC 10A

#### NUMBER OF CONTACT FOR CONTROL

1 = 1 point (Alarm)	9 = 3 point (HH/H/L/LL Alarm SPDT)
2 = 1 point (Alarm DPDT)	10 = 3 point (HH/H/L/LL Alarm DPDT)
3 = 2 point (Alarm)	11 = 4 point (H/L Alarm & Control SPDT)
4 = 2 point (Alarm DPDT)	12 = 4 point (H/L Alarm & Control DPDT)
5 = 2 point (Control)	13 = 4 point (HH/H/L/LL Alarm SPDT)
6 = 2 point (Control DPDT)	14 = 4 point (HH/H/L/LL Alarm DPDT)
7 = 3 point (Alarm, Control)	15 = 4 point (2×ControlSPDT)
8 = 3 point (Alarm, Control DPDT)	16 = 4 point (2×ControlDPDT)

※9 ~ 14 : Only weather proof

### ■ CHAMBER

SMC -CH 1 A 1 ###

#### CHAMBER SCH # (Pressure Rate)

#### TYPE OF CHAMBER

1 = Side Side (Flange type)  
 2 = Side Side (Socket type)  
 3 = Side Bottom (Flange type)  
 4 = Side Bottom (Socket type)  
 OP = etc.

#### C TO C (Carbon Steel)

A = 300mm  
 B = 500mm  
 C = 600mm  
 D = 800mm  
 E = 1,000mm  
 OP = etc.

#### CHAMBER PARTS MATERIAL

1 = Carbon steel (A106.B)  
 2 = 304SS  
 3 = 316LSS  
 OP = etc.

■ When placing an order, selected ordering number should be indicated on the purchase order sheet.

 **SeoJin Instech Co., Ltd.**

14, Dunchon-daero 457beon-gil, Junwon-gu  
 Seongnam-si, Gyeonggi-do, Korea[Zip.13218]

☎ +82-31-627-9000 📠 +82-31-624-5345

<http://www.seojin.biz>

2018 Edition Rev.0 (printed by Daoom)

■ Specifications subject to change without notice