

**HYDAC**

**INTERNATIONAL**

**Filtration and  
Fluid Conditioning  
Product Overview**

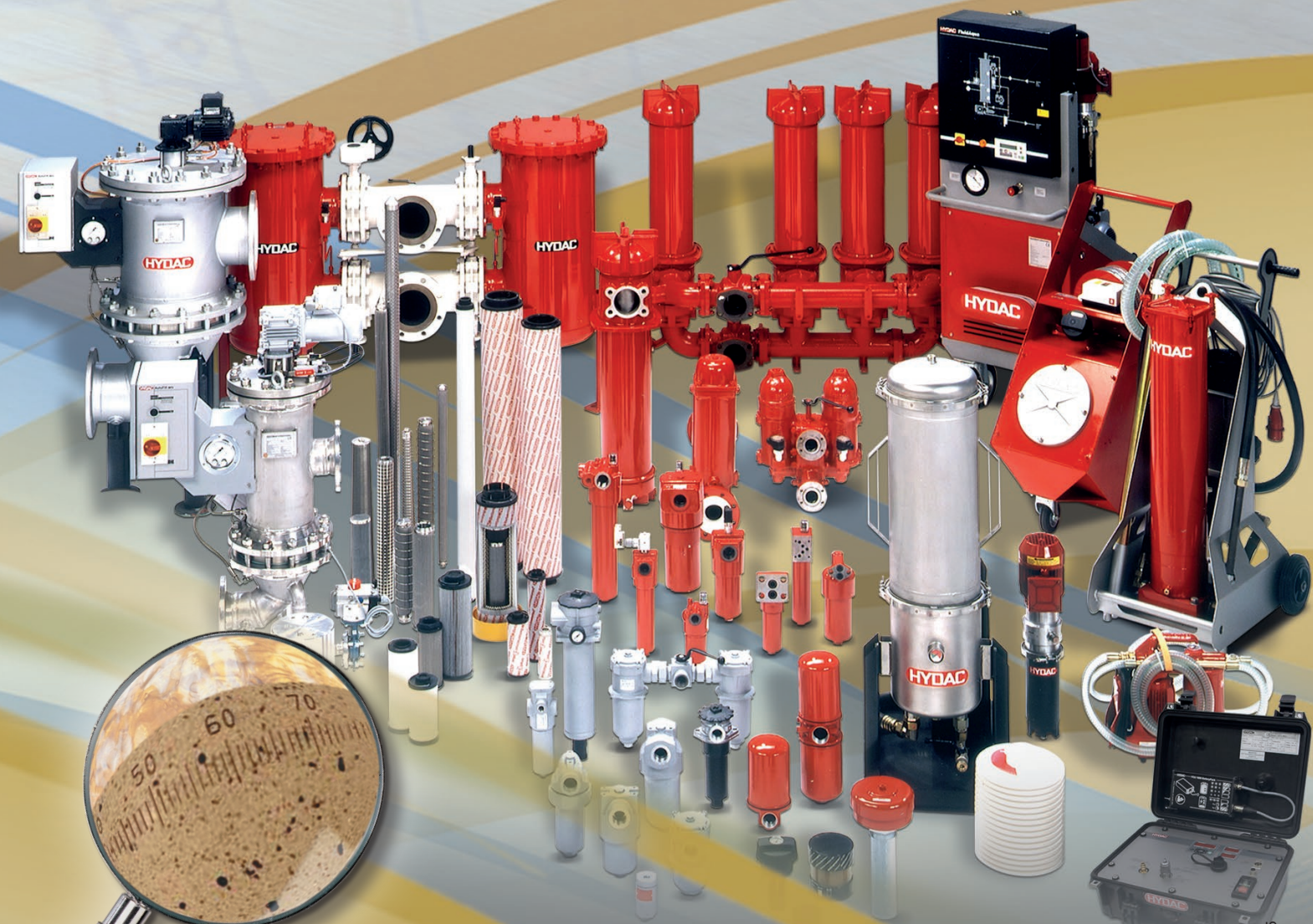

**Fluid Condition  
Monitoring**



## Table of Contents

	Page
<b>1. Introduction</b>	
● The HYDAC Group	5
● HYDAC – Expertise in all Industries	7
<b>Overview of HYDAC Products:</b>	
<b>2. Fluid Filters</b>	
● Tank Filler/Breather Filters	11
● Hydraulic and Lubrication Oil Filters	12
● Clogging Indicators for Hydraulic and Lubrication Oil Filters	28
<b>3. Tank Systems</b>	
● Plastic Tanks	29
● Steel Tanks	30
● Tank Optimisation	30
<b>4. Diesel Filtration</b>	
● Diesel Fuel Filters	31
● Clogging Indicators for Diesel Fuel Filters	33
<b>5. Cab-air Filtration</b>	
● CabinAirCare	35
<b>6. Fluid Conditioning Systems</b>	
● Stationary Filtration Systems	37
● Mobile Filtration Systems	38
● Dewatering/Degassing and Other Fluid Conditioning Systems	39
<b>7. Fluid monitoring</b>	
● Measurement and Analysis Systems	41
<b>8. Process Technology</b>	
● Filters for Process Technology	43
● System Solutions	49
● Clogging Indicators for Process Filters	50
<b>9. Filter Element technology</b>	
● Filter Elements for Hydraulic and Lubrication Oils	53
● Filter Elements for Fuel Filtration	57
● Filter Elements for Process Technology	58
<b>10. HYDAC Expertise</b>	
● Understanding Fluids	63
● Contamination and Filtration	65
● Understanding Process Media	69

### Note

The information in this brochure relates to the operating conditions and applications described.

For applications and operating conditions not described, please contact the relevant technical department.

Subject to technical modifications.



# The HYDAC Group

## The HYDAC Group

The HYDAC consortium of companies consists of 20 legally independent companies each with a different product and service focus. With over 7,500 employees, HYDAC can give the customer access to a vast network of knowledge, experience and innovation across the world: collective expertise and enthusiasm for solving complex problems.

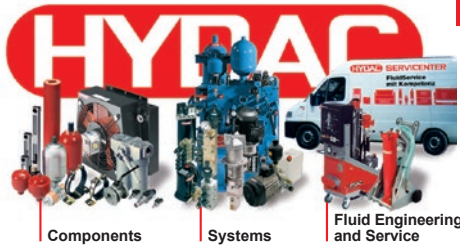

## Range of Services

Hydac is a leading manufacturer worldwide of almost all the components and systems required in hydraulic and lubrication technology: Hydraulic filters, lubrication oil filters and process filters, condition monitoring tools, sensors, dewatering units, coolers, accumulators, cylinders, pumps, valves and mounting elements.

The crucial advantage for the customer is: one stop supply – from high-quality components to subsystems, right up to turnkey complete systems, including FluidEngineering.

## Global Presence

With over 50 subsidiaries and 500 sales and service partners worldwide, HYDAC is always close to its customers.

The high proportion of export business (over 80%) is further evidence of HYDAC's global presence.

There are production locations in Germany, the US, India, China, Korea, England, Switzerland, Sweden, Poland, the Czech Republic and Slovakia.

## Satisfied Customers in all Sectors

HYDAC is renowned across all industries as being a skilled problem solver.

To list some examples: automotive industry, construction and agricultural machines, lifting and materials handling technology, rail technology, machine tools, plastic injection moulding machines, hydraulic and mechanical presses, iron and steel industry, power station technology, wind power, industrial processing, mining machines, marine and offshore technology, paper industry ...

## The HYDAC FluidCareCenter

**You can count on top quality and innovation.**

Development at HYDAC means designing application-orientated filtration systems based on test results from our research and test laboratories as well as on-site measurement and analysis, taking into account the requirements of the user and the manufacturer.

In the **HYDAC FluidCareCenter**, in collaboration with our customers, we develop innovative projects in a wide range of industries.

A skilled development team, using state-of-the-art computer-aided analysis, measuring and testing equipment and test rigs, ensures rapid implementation of the project.



HYDAC FluidCareCenter Sulzbach/Saar

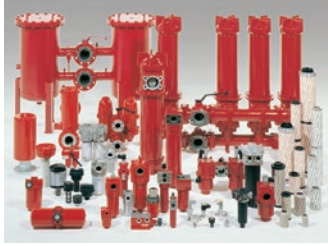

HYDAC Filter Technology



HYDAC Process Technology



HYDAC Filter Systems and  
Condition Monitoring Equipment



HYDAC Cooling Systems

## ■ Efficient Fluid Conditioning

HYDAC provides you with filters, coolers and condition monitoring units to condition the fluid and monitor the fluid condition. You therefore profit from a complete package designed for condition-based maintenance.

This ensures that fluid problems which can lead to system faults or a complete breakdown, will be detected in good time and rectified. You save unnecessary maintenance and repair costs and profit from the fact that maintenance expenditure is optimised.

**You can rely on us when it comes to conditioning your fluid – we have the expertise and knowledge for your fluids.**

# Overview of Industries and Applications

## With us, your Fluid is in Safe Hands

The specialists at HYDAC have a good knowledge of your fluid and welcome the opportunity to help you reduce the burden of fluid conditioning. You will see for yourself the clear benefit of having a system that works perfectly, leaving you to concentrate fully on your area of expertise. When you decide on a HYDAC product, you are also benefitting at the same time from the HYDAC network of expertise and service available worldwide:

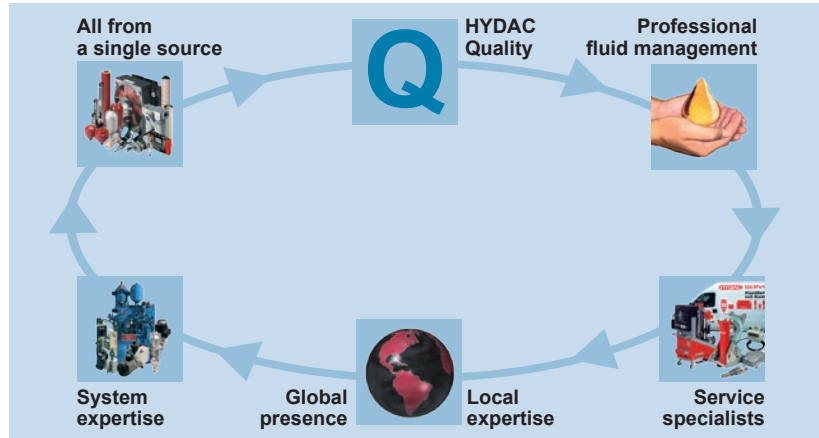

## Highest Level of Operating Reliability for your Applications

In HYDAC you have a professional partner for all aspects of fluid cleanliness as well as operating reliability and availability for your system or machine. The HYDAC filter range is also impressive with over 50 types of filter in every conceivable size and type. In addition, new individual solutions are constantly being developed, partly in active development partnership with the manufacturers.

## Filtration and fluid conditioning with HYDAC provides you with the following Advantages:

### Low costs

Industry-optimised filter elements and housings

### Easy to service

Simple element change and easy-to-install filter housing

### High level of operating reliability

Filter media have high filtration efficiency for exceptional cleanliness classes and benefit from a high level of production quality

### Low operating costs

Particularly low pressure drops across filter and filter element for low energy consumption

### All components and systems from one supplier

Providing comprehensive system know-how and an integrated system approach

### Worldwide availability and advice

Provided by our worldwide network of regional offices, agents and service partners

# Industries and Typical Applications

## Filtration Technology

## Filter Systems

## Process Filtration



### Steel industry

Brochure No.  
E 10.114

- Optimised systems for main filters, offline filters and breather filters

- Fluid condition monitoring for the prevention of unplanned system shutdowns
- Fluid handling
- Offline filtration and dewatering of hydraulic and lubrication oils
- Conditioning of fire-resistant oils
- Extending the service life of transformers

- Filtration of the process water to protect the nozzles and pumps in high pressure descaling
- Water conditioning for cooling blast furnaces and rolling mills
- Emulsion filtration in cold rolling mills

- Filters for hydraulics and lubrication

- Fluid condition monitoring for the prevention of unplanned system shutdowns
- Fluid handling
- Offline filtration and dewatering of hydraulic and lubrication oils
- Extending the service life of transformers

- Protection of nozzles of all types on paper machines.
- Treatment of fresh water (e.g. river water) to be used for cooling



### Paper industry

Brochure No.  
E 10.108

- Application-specific filter elements (e.g. Stat-Free® elements)
- High quality filters for hydraulic and lubrication oil (e.g. change-over inline filters)

- Fluid handling
- Optimisation of existing oil systems through offline filtration and dewatering
- Conditioning of fire-resistant oils
- Elimination of oil ageing products / varnish
- Extending the service life of transformers

- Conditioning of industrial water used to cool generators
- Filtration of sealing water to increase the service life of the turbine shaft floating ring seals in hydropower stations
- Fuel Gas Filtration



### Power plants

Brochure No.  
E 10.106

- Main filters, offline filters, diesel pre-filters and breather filters
- Filters and elements to DIN 24550
- Automotive industry compliant clogging indicators
- Filtration elements for clutch and braking systems, active chassis systems, steering systems, suspension and damping systems, automatic transmission

- Analysis of the technical cleanliness
- Fluid monitoring and cleanliness monitoring in flushing and test rigs
- Optimisation of the filtration in industrial part washers
- Fluid condition monitoring for the prevention of unplanned system shutdowns
- Fluid conditioning and fluid handling
- Elimination of oil ageing products, for example, from presses

- Filtration of cooling lubricants and washing fluids to extend service intervals
- Treatment of cooling and process water for different applications



### Automotive industry

Brochure No.  
E 10.125

- Main filters, offline filters, breather filters
- Filters and elements to DIN 24550
- Worldwide approval in the automotive industry

- Fluid condition monitoring for the prevention of unplanned system shutdowns
- Fluid handling
- Offline filtration and dewatering of hydraulic and lubrication oils
- Elimination of oil ageing products, for example, from presses

- Improving the quality of cooling lubricants
- Increases service life
- Consistent quality of the manufactured parts



### Machine tools

Brochure No.  
E 10.111

- Concepts for pressure filtration, return line filtration and offline filtration
- Inline high pressure filter (fitted at back of pump car for mobile pumping stations); filter elements with high pressure stability
- Inline filter with quick release couplings

- Conditioning of water-based, fire-resistant oils

- Filtration of water for sprinkling the shield and cutting machines
- Cooling water treatment for mine ventilation
- Protective filtration for the water hydraulics underground



### Mining

Brochure No.  
E 10.112





### Oil and gas industry

Brochure No. E 10.118

- Stainless steel high pressure filter
- Components compliant with ATEX Directives
- Return line filter with special offshore coating

- Monitoring of the flushing procedure of hydraulic and lubricant systems before commissioning
- Fluid handling
- Offline filtration and dewatering of hydraulic and lubrication oils

- Filtration of injection water
- Filtration of cooling water and service water
- Filtration of flushing water (pipeline flushing)
- Filtration of seal gas for dry gas seals

- Change-over filter for the gear oil (engine, steering gear, pitch adjustment etc.)
- Hydraulic filters for superstructure (winches, ship's cranes, etc.)

- Fluid condition monitoring for the prevention of unplanned system shutdowns
- Fluid handling
- Offline filtration and dewatering of hydraulic and lubrication oils

- Pre-filtration for ballast water treatment systems
- Filtering fuels and lubricating oils in heavy diesel engines



### Marine

Brochure No. E 10.129

- Protective filters before membrane systems
- Conditioning of service water in sewage treatment plants
- Increase in service life
- Prefiltration for ozone systems
- Prefiltration for UV systems



### Water / waste water treatment

Brochure No. E 7.709

- Fluid handling
- Optimisation of existing oil systems through offline filtration and dewatering
- Conditioning of fire-resistant oils
- Elimination of oil ageing products / varnish
- Extending the service life of transformers
- Fluid conditioning systems in ATEX version

- Cooling water and waste water filtration
- Filtration of a wide variety of chemicals



### Chemical industry

Brochure No. E 10.103

- Offline filters
- Application-specific filter elements for high dynamic performance

- Polymer melt filtration

- Fluid condition monitoring for the prevention of unplanned system shutdowns
- Fluid handling
- Offline filtration and dewatering of hydraulic and lubrication oils
- Elimination of oil ageing products from food grade oils (H1)



### Plastics industry

Brochure No. E 10.115

- Function integration (e.g. plastic tank systems, filter cooler tank units, valve integration in filters)
- Cab-air filter for very fine and nano dust
- In-tank filters / Tank-top filters / Breather filters
- Supply circuit filtration, diesel pre-filtration and water elimination
- Gear oil filtration and application-specific filter elements (adapted for cold start)

- Analysis of the technical cleanliness
- Fluid monitoring and cleanliness monitoring in flushing and test rigs
- Optimisation of the filtration in industrial part washers
- Fluid condition monitoring for the prevention of unplanned system shutdowns
- Fluid conditioning and fluid handling



### Mobile hydraulics

Brochure No. E 10.121

- Main filters, offline filters and breather filters as per wind power standard AGMA 6006
- Hydraulic filters, gear filters with application specific filter elements (2 and 3 stage elements)
- Motor pump unit with filter

- Fluid condition monitoring for the prevention of unplanned system shutdowns
- Fluid handling
- Offline filtration and dewatering of hydraulic and lubrication oils
- Fluid monitoring and cleanliness monitoring in flushing and test rigs

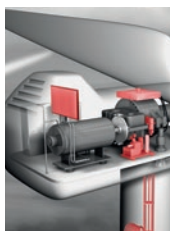

### Wind Energy

Brochure No. E 10.113













- Filtration of cooling and service water
- Protective filtration upstream of heat exchangers and pumps

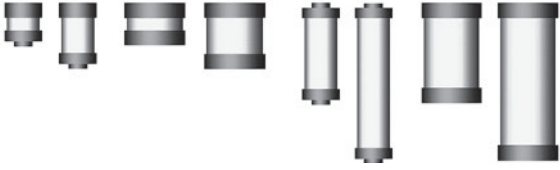

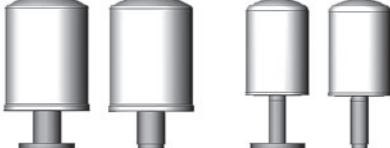
# Fluid Filters: Tank Filler/Breather Filters

## Tank Filler/Breather Filters







Tank filler/breather filters from HYDAC prevent contamination and water in the environment from entering the system as a result of fluctuations of the oil level in the tank (tank breathing).

			P <sub>max</sub> [bar]	Q <sub>max</sub> [l/min]
	<b>BLT</b>		-	270
	<b>BDE</b>		-	-
	<b>BDL/BDM</b>		-	-
	<b>BL</b>		-	1,800
	<b>TC - TankConditioner®</b>		-	-
	<b>ELF/ELFL</b>		-	5,500
	<b>BF</b>		-	11,000

# Fluid Filters: Hydraulic and Lubrication Filters

## Tank Mounted Filters – Mobile



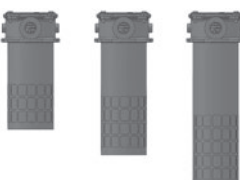

Tank-mounted filters from HYDAC remove the contamination from the operating fluid flowing into the tank via the return line. This protects the tank from system contamination.

		P <sub>max</sub> [bar]	Q <sub>max</sub> [l/min]
<p><b>RFM</b> with 2-hole or 4-hole mounting</p>  <p style="margin-left: 150px;">In-tank mounting</p> 		10	850 (4-hole) 200 (2-hole) 2,600 (tank)
	<p><b>RMER</b> – return line filters – in-tank mounted</p> <p>Flow direction from in to out</p> 	10	1,100
	<p><b>RMTR</b> – Return line filters – in-tank mounted</p> <p>Flow direction from in to out</p> 	10	1,100
	<p><b>RPER</b> – Return line filters – in-tank mounted</p> <p>Flow from inside to outside</p> 	10	300

# Fluid Filters: Hydraulic and Lubrication Filters

## Return Line Suction Boost Filter – Mobile

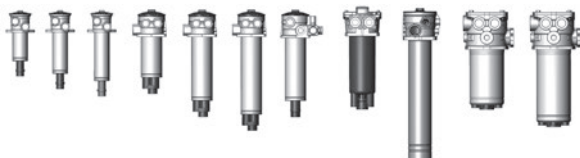
Return line suction boost filters are the interface between the open circuit of the working hydraulics and the closed circuit of the traction drive. The return line flow is finely filtered and some of it is pressurised (0.5 bar) and supplied to the boost pump, thus preventing cavitation.

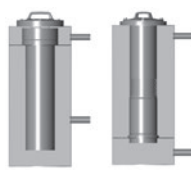
		P <sub>max</sub> [bar]	Q <sub>max</sub> [l/min]
 <p><b>RKM Return line and suction boost filter</b></p> 		10	850
 <p><b>RKM return line and suction boost filter – Optimised for service</b> Also available with Multiport filter head, as an option</p> 		10	800
 <p><b>RKMR – Return line suction filter</b> Flow from inside to outside</p> 		10	800











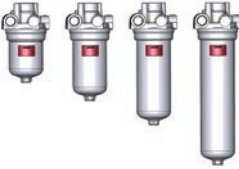

# Fluid Filters: Hydraulic and Lubrication Filters

## Inline Filters – Mobile

HYDAC inline filters for the mobile sector are distinguished by high filtration performance and simple handling, thus contributing to safe and economical plant operation.

### Features

- Numerous connection options
- Particularly suited to cold start due to low initial Delta P (use of Mobilemicron® element material)

			P <sub>max</sub> [bar]	Q <sub>max</sub> [l/min]
	<b>MF/MFD</b>		8	300
	<b>LPF../-TH</b>		50	140
	<b>LPF.. GGA..</b>		50	260
	<b>MFX</b>		50	130
	<b>LFM</b>		63	120
	<b>ILFR</b>		140	50
	<b>MFM</b>		280	100









# Fluid Filters: Hydraulic and Lubrication Filters

## Inline Filters – Mobile

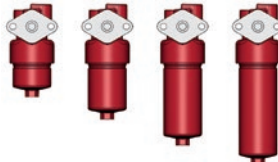
HYDAC inline filters for the mobile sector are distinguished by high filtration performance and simple handling, thus contributing to safe and economical plant operation.

### Features

- Numerous connection options
- Particularly suited to cold start due to low initial Delta P (use of Mobilemicron® element material)







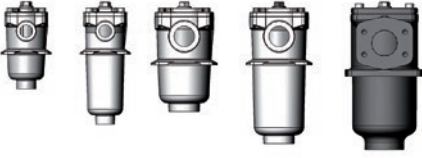

			P <sub>max</sub> [bar]	Q <sub>max</sub> [l/min]
	MFM../-OIU		280	100
	MFM..L..		280	100
	ILF		350	120
	DFM		400	280
	HFM		400	140

# Fluid Filters: Hydraulic and Lubrication Filters

## Suction Filters – Mobile

Suction filters from HYDAC are used to protect the function of the downstream pump in the circuit – although only to prevent coarse contamination.

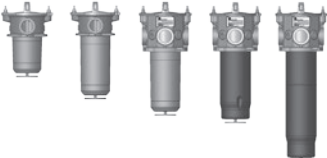
In order to prevent cavitation of the pump (negative pressure), ultrafine filtration is not recommended at this point in the system.











		P <sub>max</sub> [bar]	Q <sub>max</sub> [l/min]
<b>SF</b>	 	-	300
<b>SFM</b>	 	-	300
<b>SFF</b>	 	-	500
<b>SFAR</b>	 	-	250
<b>Suction filter elements S...</b> and suction filter element for installing on outside of tank	 	-	450 or 120



# Fluid Filters: Hydraulic and Lubrication Filters

## Return Line Filters Tank Mounted – Stationary

Tank-mounted filters from HYDAC remove the contamination from the operating fluid flowing into the tank via the return line. This protects the tank from system contamination.









			P <sub>max</sub> [bar]	Q <sub>max</sub> [l/min]
 <b>RFN</b> 			10	490
 <b>RFND Change-over version</b> 			10	480
 <b>RF</b>			25	15,000
 <b>RFD Change-over version</b>			25	1,300

# Fluid Filters: Hydraulic and Lubrication Filters

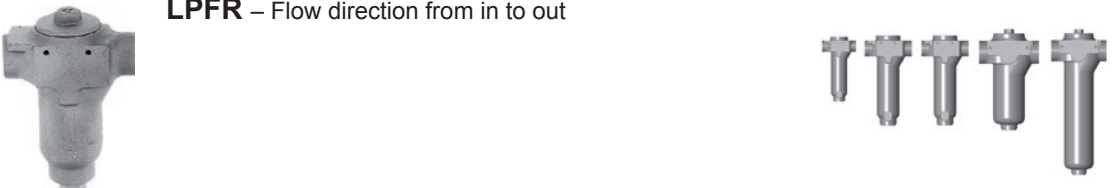
## Inline Filters up to 100 bar

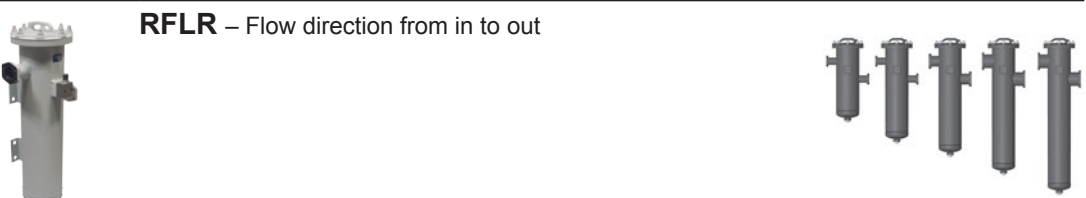
The following low pressure filters are installed inline to remove solid particles.





2

		P <sub>max</sub> [bar]	Q <sub>max</sub> [l/min]
 <p><b>RFL/RFLN Weld version</b></p>		16	15,000
 <p><b>NF</b></p>		25	3,500
 <p><b>LPFR</b> – Flow direction from in to out</p>		25	250
 <p><b>FLN</b></p> 		25	400
 <p><b>RFLR</b> – Flow direction from in to out</p>		25	1,200
 <p><b>RFL Cast version</b></p>		40	1,300
 <p><b>AFLS</b> energy </p>		40	1,700

# Fluid Filters: Hydraulic and Lubrication Filters

## Inline Filters up to 100 bar

The following low pressure filters are installed inline to remove solid particles.

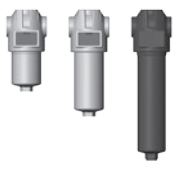









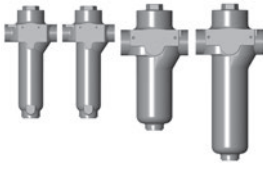

		P <sub>max</sub> [bar]	Q <sub>max</sub> [l/min]
 <b>LPF</b>		50	280
 <b>LF/LFF</b>		100	500 (LF) 240 (LFF)
 <b>LFN/LFNF</b>		100	30

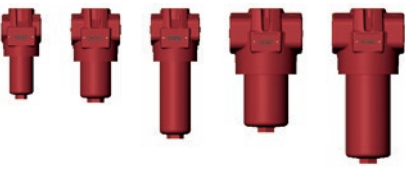

# Fluid Filters: Hydraulic and Lubrication Filters

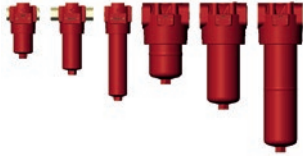
## Inline Filters from 100 bar

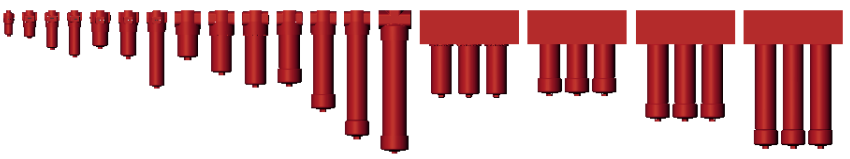







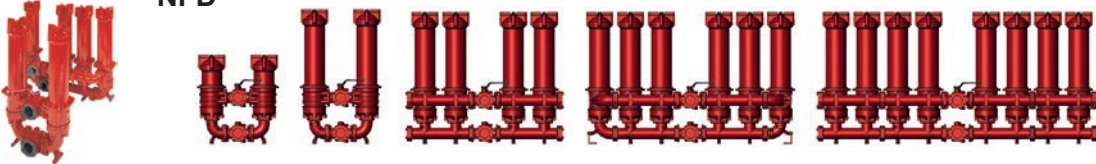

The following high pressure filters are designed for inline installation. They are distinguished by low pressure losses and high endurance strength.

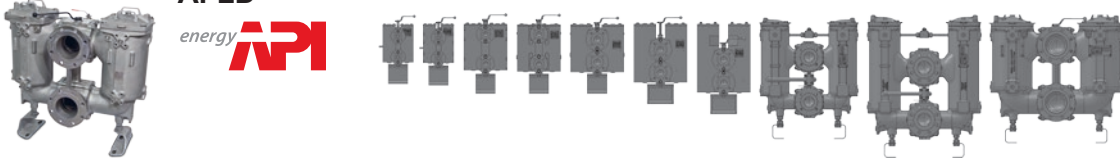
			P <sub>max</sub> [bar]	Q <sub>max</sub> [l/min]
	<b>LFR</b> – Flow direction from in to out		120	250
	<b>MDFR</b> – Flow direction from in to out		250	250
	<b>MDF</b>		280	280
	<b>HDF/HDF</b>		280 (420)	380
	<b>DFN/DFNF</b> 		400	350
	<b>DF/DFF</b>		420	1,800 (DFF: 1,000)
	<b>DFFX</b>		420	1,000

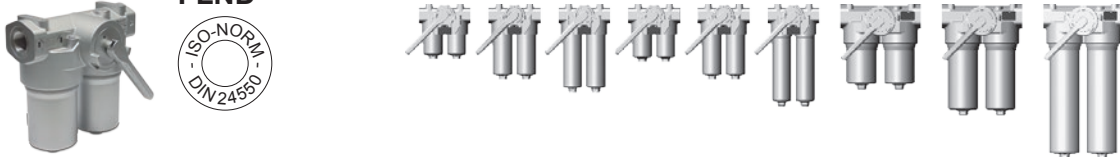
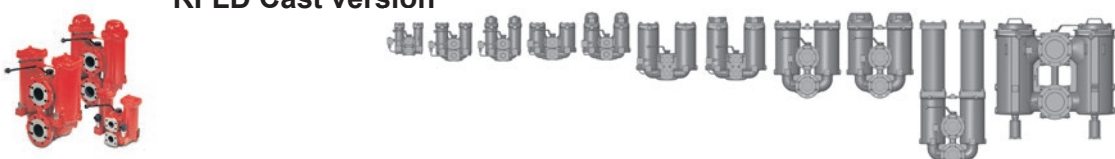
# Fluid Filters: Hydraulic and Lubrication Filters

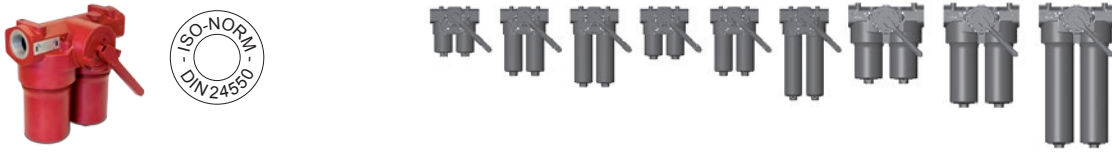
## Change-Over Inline Filters











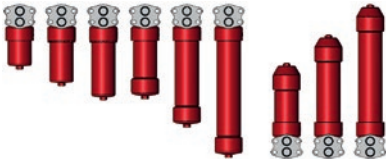

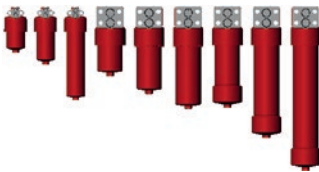
Change-over inline filters are installed inline in hydraulic and lubrication systems. The change-over design allows elements to be changed without shutting down the system (24 hour operation).

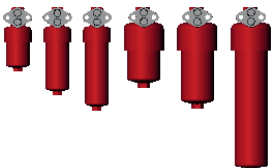
		P <sub>max</sub> [bar]	Q <sub>max</sub> [l/min]
<b>RFLD/RFLND Weld version</b>		16	15,000
<b>NFD</b>		25	1,600
<b>AFLD</b> energy 		40	1,700
<b>FLND</b> 		63	400
<b>RFLD Cast version</b>		64	2,500
<b>FMND</b> 		250	400
<b>DFDK</b>		315	1,800
<b>DFDKN</b> 		315	800

# Fluid Filters: Hydraulic and Lubrication Filters

## Manifold Mounted Filters

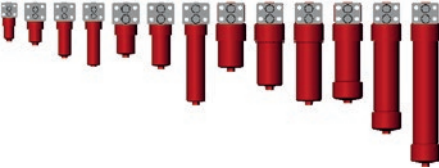











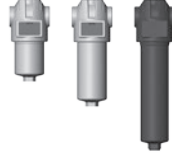

HYDAC manifold mounting filters are installed directly after the pump on the control manifold or are used as protective filters before high-quality servo or proportional valves.

			P <sub>max</sub> [bar]	Q <sub>max</sub> [l/min]
	<b>DF...K P</b>		180	550
	<b>DF...MHA/DF...MHE</b>		250	550
	<b>DF...M A</b>		250	200
	<b>DF...M P</b>		260	280
	<b>DFZ</b>		315	80
	<b>DF...Q E</b>		315	550
	<b>DFP/F</b>		315	620

# Fluid Filters: Hydraulic and Lubrication Filters

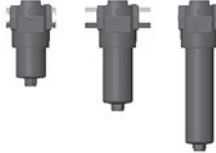
## Filters for Reversible Oil Flow











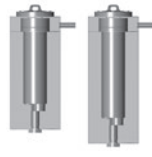

The following filters for reversible oil flow are installed inline in hydraulic systems. They allow free flow in both directions, with the oil flow being filtered in one direction only.

			P <sub>max</sub> [bar]	Q <sub>max</sub> [l/min]
	<b>LFNF</b> 		100	30
	<b>LFF – Inline Filter</b>		100	240
	<b>HDDF – Inline Filter</b>		280 (420)	380
	<b>DFPF – Manifold Mounted Filter</b>		315	620
	<b>DFNF – Inline Filter</b> 		400	50
	<b>DFF – Inline Filter</b>		420	1,000
	<b>DFFX – Inline Filter</b>		420	1,200

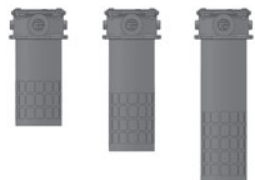
# Fluid Filters: Hydraulic and Lubrication Filters

## Filters with Flow Direction from In to Out

In addition to the HYDAC standard range of filtration products where the flow direction is from out to in, HYDAC also offers filters where the flow direction is from in to out. This also includes models with integrated magnetic candles for more efficient filtration.



		P <sub>max</sub> [bar]	Q <sub>max</sub> [l/min]
	<b>RKMR – Return line suction filter</b> 	10	800
	<b>RMER – Return line filters – in-tank mounted</b> 	10	1,100
	<b>RMTR – Return line filters – in-tank mounted</b> 	10	1,100
	<b>RPER – Return line filters – in-tank mounted</b> 	10	300
	<b>LPFR – Inline filter</b> 	25	250
	<b>RFLR – Inline filter</b> 	25	1,200
	<b>LFR – Inline filter</b> 	120	250



# Fluid Filters: Hydraulic and Lubrication Filters

## Filters with Flow Direction from In to Out

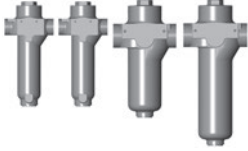

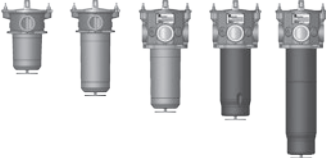







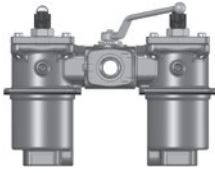

In addition to the HYDAC standard range of filtration products where the flow direction is from out to in, HYDAC also offers filters where the flow direction is from in to out. This also includes models with integrated magnetic plugs for more efficient filtration.

		P <sub>max</sub> [bar]	Q <sub>max</sub> [l/min]
	<b>MDFR – Inline filter</b> 	250	250
	<b>SFAR – Suction filter</b> 	-	250

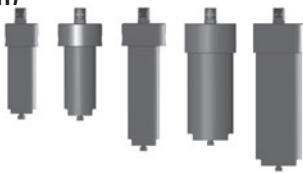
# Fluid Filters: Hydraulic and Lubrication Filters

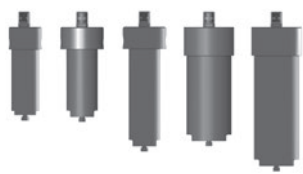
## Filters for Oil and Gas Applications

In order to fulfil the requirements of the oil and gas industry in respect of hydraulic and lubrication filters, HYDAC offers a special stainless steel range.

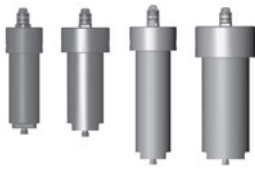
		P <sub>max</sub> [bar]	Q <sub>max</sub> [bar]	
	<b>SSRF – Return Line Filter</b>		25	150
	<b>SSRFD – Change-Over Return Line Filter</b>		25	150
	<b>EMLF – Return line filter</b>		40	150
	<b>MPSSF – Inline filter (also available in manifold version)</b>		450	130
	<b>HPSSF – Inline Filter</b>		700	130
	<b>SSDF/SSDFF – Inline Filter</b>		700	15
	<b>ACSSF – Inline Filter</b>		1,035	100

# Fluid Filters: Hydraulic and Lubrication Filters

## Filters in conformity with US Automotive Standard

HYDAC filters in conformity with US automotive standards meet the stringent stipulations of the US automotive industry.

			P <sub>max</sub> [bar]	Q <sub>max</sub> [l/min]
	<b>HF4R – Return Line Filter</b>		10	450
	<b>HF2P – Inline Filter (also Manifold Mounted Filter)</b>		280	100
	<b>HF4P – Inline Filter (also Manifold Mounted Filter)</b>		350	450
	<b>HF3P – Inline Filter</b>		420	450







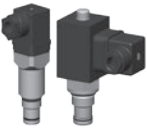

# Fluid Filters: Hydraulic and Lubrication Filters

## Clogging Indicators for Hydraulic and Lubrication Oil Filters

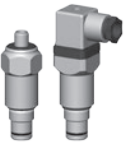
HYDAC clogging indicators are designed to monitor filters. As the contamination in the filter element increases, the pressure drop in the filter housing rises. As soon as a specific limit is reached, the clogging indicator signals that the element requires changing.

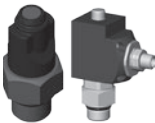
### Features

- Return line or differential pressure indicators
- Visual, electrical or electronic signal
- Wide range of pressure settings

	P <sub>max</sub> [bar]	Pressure setting [bar]
 <p><b>VD – Differential pressure</b></p>	420	2, 5, 8
 <p><b>PVD – Differential pressure</b></p>	420	2, 5, 8
 <p><b>VM – Differential pressure</b></p>	210	2, 5, 8
 <p><b>V01 and V02 – Differential pressure indicator</b></p>	100	0.8, 2 4.3
 <p><b>VR – Return line</b></p>	7 or 40	0.2, 2, 5.5, 5, 16
 <p><b>VRD – Return line</b></p>	40	0.2, 2
 <p><b>VMF – Return line</b></p>	40	0.2, 2, 2.5, 5, 16
 <p><b>VLGW – Dirt Controller/Filter Condition Monitoring</b></p>	25	2, 3, 5

# Tank Systems

## Plastic Tank Systems

The customer receives the complete system from one company, factory-tested and ready-to-install. It includes the tank, hydraulic filter, breather filter, fluid level gauge, with standard and special threaded connections. What is more, the client will also save considerably on installation, logistics and transportation costs.

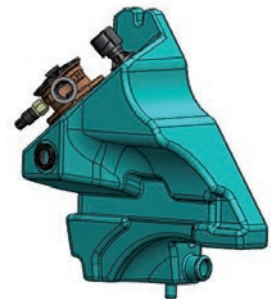
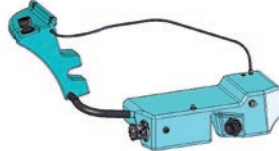
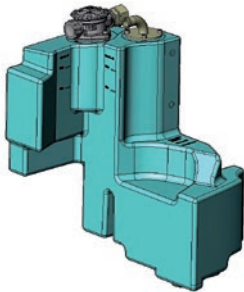
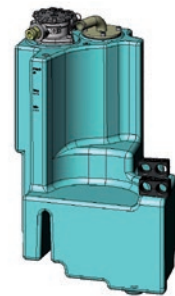
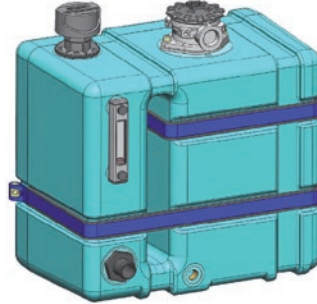

## Standard Plastic Fuel Tanks

The customer receives the complete system from one company, factory-tested and ready-to-install. It includes the tank, hydraulic filter, breather filter, fluid level gauge, with standard and special threaded connections. What is more, the client will also save considerably on installation, logistics and transportation costs.



Tank versions:

45 l and 70 l (both sizes available in Basic or Premium version) or 100 l (Premium version only)

Basic version: with return line and breather filter

Premium version: with return line filter, filler/breather filter, suction filter and fluid level gauge.

All models can also be delivered with either vertical or horizontal fixing straps.

# Tank Systems

## Steel Tank Systems

In addition to our plastic tanks, HYDAC also offers steel tanks in a wide variety of designs. With these too, the customer receives the complete system from one company, factory-tested and ready-to-install. It includes the tank, hydraulic filter, breather filter, fluid level gauge, with standard and special threaded connections. What is more, the client will also save considerably on installation, logistics and transportation costs. See example below:



## Tank Optimisation

“Vacuum-packed” tank solution for hydraulic systems with integrated hydraulically driven degassing and dewatering power unit.

- Oil vacuum-packed to optimise the hydraulic system
- Reduction of tank size: design based on oscillating volume
- Reduced oil volume, typically by a factor of 10



### OXS

#### OXiStop

Complete solution with tank, filters, coolers and degassing and dewatering unit



### OXS LID

#### OXiStop LID

Installation variation for integration into customer-specific tank

Q<sub>max</sub>  
[l/min]

900

900















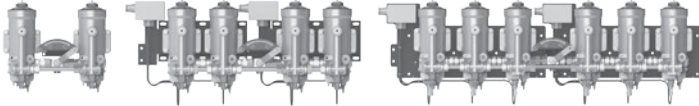

# Diesel Filtration

## Diesel Fuel Filters

Emissions guidelines are requiring more and more of diesel fuels. As a result, suppliers need to make sure that there is less contamination and lower water content in their fuels. In addition, the increasing share of biogenic fuels has the effect that existing systems need to be retrofitted with diesel maintenance systems.

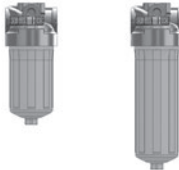
The fuel needs to be filtered and dewatered at every stop along the transport chain: from production, to the refinery, all the way to the end consumer. In this regard, the product range of HYDAC comprises filters, fluid conditioning units and sensors.

Alongside on-board products for smaller diesel quantities in consuming devices, supplementary products for larger volumes are also available. These can be used when transporting between the various storage locations, at petrol pumps, and thus at the crossover to the engine.

		P <sub>max</sub> [bar]	Q <sub>max</sub> [l/h]
 <b>HDP BestCost (BC) – Pre-filter</b> 		<1 bar	1,800
 <b>HDP HighTech (HT) – Pre-filter</b> 		<1 bar	1,800
 <b>HDP BestCost (BC) – Pre-filter</b> Can be changed over  		<1 bar	1,800
 <b>HDP HighTech (HT) – Pre-filter</b> Can be changed over  		<1 bar	1,800
 <b>HDM Standard Economy (EC) – Main filter</b>  		-	-
 <b>HDM Customised – Main filter</b>  		-	-







# Diesel Filtration

## Diesel Fuel Filters

Emissions guidelines are requiring more and more of diesel fuels. As a result, suppliers need to make sure that there is less contamination and lower water content in their fuels. In addition, the increasing share of biogenic fuels has the effect that existing systems need to be retrofitted with diesel maintenance systems.

The fuel needs to be filtered and dewatered at every stop along the transport chain: from production, to the refinery, all the way to the end consumer. In this regard, the product range of HYDAC comprises filters, fluid conditioning units and sensors.

Alongside on-board products for smaller diesel quantities in consuming devices, supplementary products for larger volumes are also available. These can be used when transporting between the various storage locations, at petrol pumps, and thus at the crossover to the engine.

		<b>P<sub>max</sub> [bar]</b>	<b>Q<sub>max</sub> [l/h]</b>
	<b>LVU-CD – LowViscosity Unit Diesel-Coalescer</b> LVU-CD-10 	<b>3</b>	<b>10</b>
	<b>LVU-CD-40</b> 	<b>4.5</b>	<b>40</b>
	<b>LVH – LowViscosity Housing</b> LVH-F (filtration) LVU-C (dewatering) 	<b>16</b>	<b>3,600</b>











# Diesel filtration

## Clogging Indicators for Diesel Fuel Filters

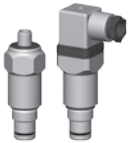
HYDAC clogging indicators are designed to monitor filters. As the contamination in the filter element increases, the pressure drop in the filter housing rises. As soon as a specific limit is reached, the clogging indicator signals that the element requires changing.

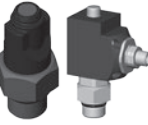
### Features

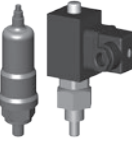
- Return line or differential pressure indicator
- Visual, electrical or electronic signal
- Wide range of pressure settings

	P <sub>max</sub> [bar]	Pressure setting [bar]
 <b>VD – Differential pressure</b>	420	2, 5, 8
 <b>PVD – Differential pressure</b>	420	2, 5, 8
 <b>VM – Differential pressure</b>	210	2, 5, 8
 <b>V01 and V02 – Differential pressure indicator</b>	100	0.8, 2 4.3
 <b>VR – Return line</b>	7 or 40	0.2, 2, 5.5, 5, 16
 <b>VRD – Return line</b>	40	0.2, 2
 <b>VMF – Return line</b>	40	0.2, 2, 2.5, 5, 16
 <b>VLGW – Dirt Controller/Filter Condition Monitoring</b>	25	2, 3, 5



# Cab-air filtration

## CabinAirCare

Although combustion engines are being used more and more, the corresponding legislation is old and the specifications need updating. As a result, ambient air in the cab is alarmingly contaminated with fine particles and nanoparticles that can be breathed in, even though the exhaust emission directive has recently been intensified.

In vehicle interiors, work cabins and in passenger compartments, too, high concentrations of dangerous nanoparticles can be measured. In some cases, the nanoparticles are so small that they not only penetrate the lungs but also spread deeply throughout the body – the smaller the particle, the more harm it can cause. As with the tightening of the soot particle emission limits for diesel vehicles, restrictions are also likely to be imposed on the assessment of internal space air in vehicles and working devices.

For this reason, and also to create a healthy climate that promotes top work performance, HYDAC has already started providing highly effective air filtering systems for new systems and for retrofitting.

### CACR CabinAirCare

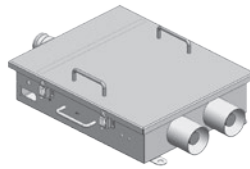

Air flow rate [m <sup>3</sup> /h]	Possible overpressure in vehicle cab [Pa]
30 – 320*	25 – 300*





\* Max. depending on choice of fan



# Fluid Conditioning Systems

## Stationary Filtration Systems for Use Offline









These units in their many versions are installed permanently offline. Stationary filter systems from HYDAC are designed to remove particles (with or without integrated fluid sensors). By deploying these systems, the service life of components and systems is improved, machine availability is greater, oil change intervals are longer and the life cycle cost LCC is reduced.

	P <sub>max</sub> [bar]	Q <sub>max</sub> [l/min]
 <p><b>OLF BD</b> <b>OffLine Filter BiDirectional</b></p> <ul style="list-style-type: none"> <li>● Compact, stationary offline filter up to 5 l/min</li> <li>● Any flow direction of element</li> </ul>	25	5
 <p><b>OLFP 1/3/6</b> <b>OffLine Filter Pressure</b></p> <ul style="list-style-type: none"> <li>● Stationary offline filtration unit up to 6 l/min to separate ultrafine particulate contamination, water and oil ageing products</li> <li>● 3 different installation sizes</li> <li>● Also available with integrated fluid sensors, as an option</li> </ul>	25	6
 <p><b>OLF 5</b> <b>OffLine Filter</b></p> <ul style="list-style-type: none"> <li>● Compact, stationary offline filtration unit up to 15 l/min</li> <li>● Also available with integrated fluid sensors, as an option</li> <li>● Numerous versions: with or without motor-pump unit, element removal from either top or bottom, in-tank mounting versions, options for integrated fluid sensor etc.</li> </ul>	4.5	15
 <p><b>OF 5 / OF 5 mini</b> <b>Filtromat (with or without change-over valve)</b></p> <ul style="list-style-type: none"> <li>● Stationary offline filtration unit up to 40 l/min</li> </ul>	4.5	40
 <p><b>OLF 15/30/45/60</b> <b>OffLine Filter</b></p> <ul style="list-style-type: none"> <li>● Stationary offline filtration unit up to 60 l/min</li> <li>● 4 different sizes</li> <li>● Also available with integrated fluid sensors, as an option</li> </ul>	6	60
 <p><b>MRF 1/2/3/4/5/6/7 / AMRF 1/2/3/4/5/6/7</b> <b>MultiRheo Filter / Automotive MultiRheo Filter</b></p> <ul style="list-style-type: none"> <li>● Stationary offline filter up to 2,000 l/min</li> <li>● 7 different sizes</li> <li>● As single or duplex filter</li> </ul>	40	2,000

# Fluid Conditioning Systems

## Mobile Filtration Systems for Use Offline

HYDAC provides mobile filtration systems, specially developed for offline filtration, for filtering, dewatering, degassing and conditioning operating fluids. By deploying these systems, the service life of components and systems is improved, machine availability is greater, oil change intervals are longer and the life cycle cost LCC is reduced.







		P <sub>max</sub> [bar]	Q <sub>max</sub> [l/min]
	<b>FCC</b> <b>FluidCarrier Compact</b> <ul style="list-style-type: none"> <li>● Mobile offline filtration unit</li> <li>● Up to 15 l/min</li> <li>● Tank volume: 70 l</li> </ul>	3.5	15
	<b>OF 7</b> <b>Filtration Unit</b> <ul style="list-style-type: none"> <li>● Mobile offline filtration unit</li> <li>● Up to 15 l/min</li> <li>● Also available with integrated fluid sensors, as an option</li> </ul>	3.5	15
	<b>FT 5</b> <b>Barrel Transportation and Filtration Trolley</b> <ul style="list-style-type: none"> <li>● Up to 40 l/min</li> <li>● For standard 200 l barrel</li> </ul>	4.5	40
	<b>OF 5 mobile</b> <b>Filtromat (with or without change-over valve)</b> <ul style="list-style-type: none"> <li>● Mobile offline filtration unit</li> <li>● Up to 40 l/min</li> <li>● Optionally with integrated fluid sensors</li> </ul>	4.5	40
	<b>OF 5 with FCU</b> <b>Filtromat (with or without change-over valve)</b> <ul style="list-style-type: none"> <li>● Mobile offline filtration unit</li> <li>● Up to 40 l/min</li> <li>● With integrated FluidControl unit to monitor solid particle contamination</li> </ul>	4.5	40
	<b>TW 5</b> <b>Mobile Oil Transport and Filtration Unit (with or without change-over valve)</b> <ul style="list-style-type: none"> <li>● Mobile offline filtration unit</li> <li>● up to 40 l/min</li> <li>● Tank volume: 200 l</li> </ul>	4.5	40
	<b>FCM</b> <b>FluidCleaner Mobil</b> <ul style="list-style-type: none"> <li>● Mobile offline filtration unit</li> <li>● Up to 100 l/min</li> </ul>	10	100
	<b>OFU</b> <b>OfflineFiltration Unit</b> <ul style="list-style-type: none"> <li>● Mobile filter pump transfer unit</li> <li>● Up to 100 l/min</li> </ul>	10	100

# Fluid Conditioning Systems

## Dewatering/Degassing and other Fluid Conditioning Systems

HYDAC provides both stationary and mobile fluid service systems for dewatering, degassing and conditioning hydraulic and lubrication fluids.

- Dewatering by means of vacuum vaporisation or coalescence techniques
- Elimination of acids and oil ageing products
- Elimination of varnish
- Degassing and conditioning of transformer oil
- Removal of oil from water

	P <sub>max</sub> [bar]	Q <sub>max</sub> [l/min]
 <p><b>FAM 5 / FAM 10 / FAM 25-95 / FAM-E</b> <b>FluidAqua Mobil</b></p> <ul style="list-style-type: none"> <li>● Mobile unit for dewatering (vacuum vaporisation), degassing and filtration</li> <li>● Different sizes: 5 to 95 l/min</li> <li>● Stationary variants available</li> </ul>	4.5	95
 <p><b>OLS</b> <b>OffLine Separator</b></p> <ul style="list-style-type: none"> <li>● Unit for dewatering on basis of coalescence method</li> <li>● For hydraulic oils, diesel oil and light gear oil with densities below 1000 kg/m<sup>3</sup></li> </ul>	6	5
 <p><b>OLSW</b> <b>OffLine Separator Water</b></p> <ul style="list-style-type: none"> <li>● Unit for removing free mineral oil from aqueous cleaning fluids</li> <li>● on the basis of the coalescence principle</li> </ul>	6	20
 <p><b>IXU 1/4</b> <b>Ion eXchange Unit</b></p> <ul style="list-style-type: none"> <li>● Offline unit for conditioning fire-resistant fluids</li> <li>● Up to 9 l/min</li> <li>● Stationary or mobile version</li> </ul>	6	9
 <p><b>VMU</b> <b>VarnishMitigation Unit</b></p> <ul style="list-style-type: none"> <li>● Offline unit for conditioning mineral oils</li> <li>● Up to 9 l/min</li> <li>● Stationary or mobile version</li> </ul>	8	9
 <p><b>TCU</b> <b>Transformer Care Unit</b></p> <ul style="list-style-type: none"> <li>● Conditioning unit for transformers</li> <li>● Online / Onload</li> </ul>		





## Fluid Monitoring

# Measurement and Analysis Systems

HYDAC offers a comprehensive range of easy-to-use measurement and analysis equipment. It is ideal for particle or liquid contaminants, for both sporadic checks and permanent installation, whether in the laboratory or in the field. The right tool for every application:

- Fluid sensors (to measure particle contamination and water saturation)
- Sampling systems
- Laboratory equipment
- Component analysis equipment
- Software and controls

## Equipment / Service



## Fluid Sensors for HYDAC Filter Systems

The mobile and stationary fluid conditioning units from HYDAC can be equipped with proven fluid sensors, as an option. By integrating fluid sensors it is possible to monitor the fluid level during cleaning.

- **ContaminationSensor CS 1000**  
to monitor the particle contamination in hydraulic and lubrication fluids
- **AquaSensor AS 1000**  
to monitor the water saturation level (in %) in hydraulic and lubrication fluids
- **MetallicContamination Sensor MCS 1000**  
to monitor metallic particle contamination (ferromagnetic and non-ferromagnetic particles) in lubrication fluids.
- **Oil Condition Sensor HYDACLab®**  
to monitor the relative change in dielectric constant
- **SensorMonitoring Unit SMU1200**  
a display unit to display and store the measurement data from HYDAC fluid sensors













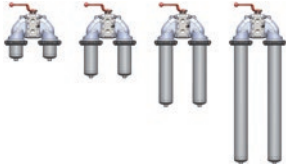

# Process Technology

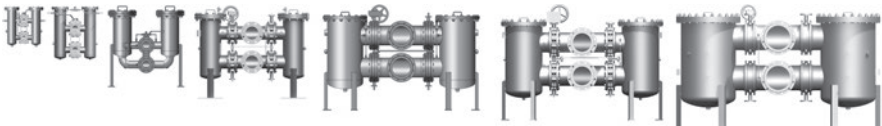
## Inline Filters

HYDAC inline filters are designed for the toughest applications in process technology. They allow solid particles of all kinds to be removed effectively. A large variety of sizes and filter materials allows optimum adjustment to suit the particular filtration task and process conditions.

- Temperatures up to +400 °C
- Pressures up to 1,000 bar
- Filtration ratings from 1 µm (absolute) to 10,000 µm
- Flow rates up to 6,000 m³/h







		Pmax [bar]	Qmax [l/min]
	<b>PFM, PFH</b> – Process filter, Medium and High Pressure 	100	120
	<b>PFMD, PFHD</b> – Process duplex filter, change-over 	100	120
	<b>PRFL</b> – Process inline filter 	64	60,000
	<b>PRFLD</b> – Process inline filter, change-over 	40	15,000
	<b>PRFS</b> – Process screen basket filter 	16	60,000
	<b>PRFSD</b> – Process screen basket filter, change-over 	16	15,000
	<b>EDF</b> – Stainless steel pressure filter 	400	300

# Process Technology

## Inline Filters

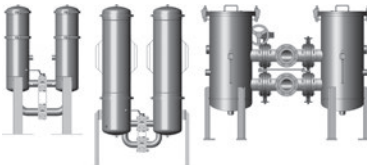
HYDAC inline filters are designed for the toughest applications in process technology. They allow solid particles of all kinds to be removed effectively. A large variety of sizes and filter materials allows optimum adjustment to suit the particular filtration task and process conditions.

- Temperatures up to +400 °C
- Pressures up to 1,000 bar
- Filtration ratings from 1 µm (absolute) to 10,000 µm
- Flow rates up to 6,000 m³/h

		P <sub>max</sub> [bar]	Q <sub>max</sub> [l/min]
 <b>PMRF</b> – Process multi-rheo filter		40	10,000
 <b>PMRFD</b> – Process multi-rheo filter, change-over		40	10,000
 <b>PBF</b> – Process bag filter		10	500
 <b>PLF1</b> – Process inline filter		16	24,000*











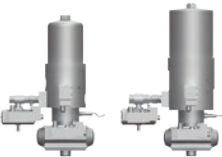

\* For cooling lubricant and washing emulsions, please consult our Head Office.

# Process Technology

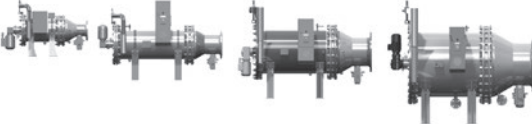
## Auto. Back-Flush. Filter AutoFilt®

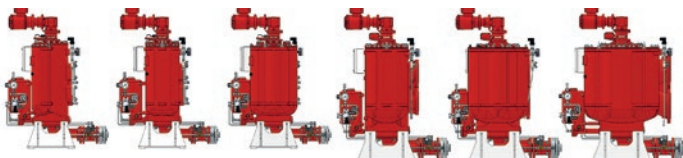
HYDAC AutoFilt® automatic back-flushing filters are designed for continuous or discontinuous filtration operation in all areas of industry and in water treatment. These automatic back-flushing filters are self-cleaning systems that separate solid particles from fluids. They make a great contribution to operational reliability and reduce operating and maintenance costs.

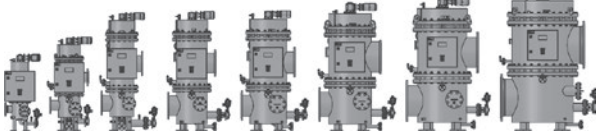
- Temperatures up to +90 °C
- Pressures up to 350 bar
- Filtration ratings from 15 µm to 10,000 µm
- Flow rates up to 10,000 m³/h



			P <sub>max</sub> [bar]	Q <sub>max</sub> [l/min]
	<b>AutoFilt® RF3</b>		100	167,000
	<b>AutoFilt® RF4</b>		25	220*
	<b>AutoFilt® RF5</b>		10	70,000
	<b>AutoFilt® RF7</b>		40	75,000
	<b>AutoFilt® RF9</b>		16	10,000
	<b>AutoFilt® RF10</b>		6	3,000
	<b>AutoFilt® RF12</b>		10	80

# Process Technology

## Auto. Back-Flush. Filter AutoFilt®

HYDAC AutoFilt® automatic back-flushing filters are designed for continuous or discontinuous filtration operation in all areas of industry and in water treatment. These automatic back-flushing filters are self-cleaning systems that separate solid particles from fluids. They make a great contribution to operational reliability and reduce operating and maintenance costs.

- Temperatures up to +90 °C
- Pressures up to 350 bar
- Filtration ratings from 15 µm to 10,000 µm
- Flow rates up to 10,000 m³/h

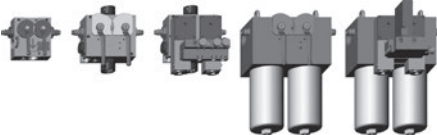
	P <sub>max</sub> [bar]	Q <sub>max</sub> [l/min]
 <b>AutoFilt® ATF</b> 	16	6,700
 <b>AutoFilt® RFH – Back-flushing high pressure filter</b> 	350	800







\* For cooling lubricant applications, please consult our Head Office.

# Process Technology

## Gas Filters

The HYDAC GCF gas filters are high-performance, change-over duplex filters in stainless steel which have been specially developed for use in dry gas seals in turbo compressors.

- Temperatures from -35 °C to +225 °C
- Pressures up to 1,000 bar
- Filtration rating 0.1 µm to 25 µm\*
- Other temperatures and pressures possible on request

	P <sub>max</sub> [bar]	Q <sub>max</sub> [l/min]
 <p><b>GCF</b> – Gas Coalescer Filter</p>	500	Flow rates are dependent on the gas and operating conditions
 <p><b>GCF</b> – with cyclone</p>	500	
 <p><b>GCF</b> – Double Block &amp; Bleed</p>	500	
 <p><b>GPF</b> – Gas Particulate Filter</p>	500	
 <p><b>GDS</b> – Gas Demister Separator</p>	250	
 <p><b>GCS</b> – Gas Cyclone Separator</p>	250	
 <p><b>GF1</b> – High Pressure Filter</p>	1,000	

# Process Technology

## Gas Filters

The HYDAC GCF gas filters are high-performance, change-over duplex filters in stainless steel which have been specially developed for use in dry gas seals in turbo compressors.

- Temperatures from -35 °C to +225 °C
- Pressures up to 1,000 bar
- Filtration rating 0.1 µm to 25 µm\*
- Other temperatures and pressures possible on request



**FGF** – Fuel Gas Filter

P <sub>max</sub> [bar]	Q <sub>max</sub> [l/min]
100	On request







\* Refers to gases

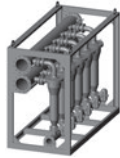

# Process Technology

## System Solutions

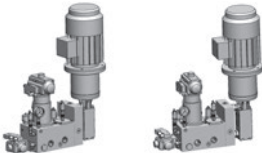
HYDAC Process Technology develops integrated complete solutions for and in collaboration with their customers in almost all industries. When matched to the customer's requirements, skid and system solutions make an effective contribution to optimising the process chain and to reducing the operating and maintenance costs.

		P <sub>max</sub> [bar]	Q <sub>max</sub> [l/min]	
	<b>BTU</b> – Back-flush treatment unit		25	1,000
	<b>AutoFilt® ATF-Skid</b> – TwistFlow strainer station		16	15,000*
	<b>PBB</b> – Process booster block Cooling lubricant supply for machine tools		70	80
	<b>FGF</b> – Fuel Gas Filter		100	On request
<b>Customised system solutions available on request</b>			individual	individual
				

\* Higher values on request

# Process Technology

## Clogging Indicators for Process Filters

HYDAC clogging indicators are designed to indicate visually and/or electrically when the filter elements must be cleaned or changed.

- Differential pressure indicators
- Visual, electrical or analogue differential pressure signal
- Wide range of pressure settings
- Optional electrical ATEX indicator

	P <sub>max</sub> [bar]	Pressure setting [bar]
 <p><b>PVD x B.x</b></p>	420	1, 1.5, 2, 3, 5, 8
 <p><b>PVD x C.x</b></p>	420	1, 1.5, 2, 3, 5, 8
 <p><b>PVD x D.x/-L</b></p>	420	1, 1.5, 2, 3, 5, 8
 <p><b>V01 x VZ.x</b></p>	160	0.8, 2.0, 4.3
 <p><b>DS11</b></p>	25, 40 on request	0 - 1.6, 0 - 4
 <p><b>PVL x GW</b></p>	25	0.5, 1, 1.5, 2, 3, 5

# Process Technology

## Clogging Indicators for Process Filters

HYDAC clogging indicators are designed to indicate visually and/or electrically when the filter elements must be cleaned or changed.

- Differential pressure indicators
- Visual, electrical or analogue differential pressure signal
- Wide range of pressure settings
- Optional electrical ATEX indicator

HDA 4xxx



EDS 3xxx/8xxx











P <sub>max</sub> [bar]	Pressure setting [bar]
On request	–
On request	–









# Filter Element Technology

## High Quality Element Technology for Hydraulic Oils and Lubricants

		Technical properties	Filtration rating [µm]	Collapsing pressure [bar]
	<b>Optimicron® Power</b> ON/PO	<ul style="list-style-type: none"> <li>● High <math>\beta_{x(c)}</math> values</li> <li>● Contamination retention</li> <li>● <b>Very low element differential pressure</b></li> <li>● High <math>\beta_{x(c)}</math> value stability</li> </ul>	5, 10, 20	10
	incl. 			
	<b>Optimicron® Pulse</b> ON/PS, OH/PS	<ul style="list-style-type: none"> <li>● High <math>\beta_{x(c)}</math> values</li> <li>● Contamination retention</li> <li>● High <math>\beta_{x(c)}</math> value stability</li> <li>● <b>&gt;1 million cycles</b></li> </ul>	3, 5, 10, 20	20 or 210
	incl. 			
	<b>Optimicron® Pulp &amp; Paper</b> ON/PP	<ul style="list-style-type: none"> <li>● High <math>\beta_{x(c)}</math> value stability</li> <li>● Low element differential pressure</li> <li>● <b>Particularly high contamination retention</b></li> </ul>	5	10
	<b>Optimicron®</b> ON	<ul style="list-style-type: none"> <li>● High <math>\beta_{x(c)}</math> value stability</li> <li>● <b>Low element differential pressure</b></li> <li>● High <math>\beta_{x(c)}</math> value stability</li> <li>● <b>High contamination retention</b></li> </ul>	1, 3, 5, 10, 15, 20	20
	<b>Betamicron®</b> BN4HC, BH4HC	<ul style="list-style-type: none"> <li>● High <math>\beta_{x(c)}</math> values</li> <li>● Low element differential pressure</li> <li>● High <math>\beta_{x(c)}</math> value stability</li> <li>● <b>Particularly high contamination retention</b></li> </ul>	3, 5, 6*, 10, 20, 25* * for dimensions to DIN 24550	25 or 210
	<b>Stat-Free®</b> -SFREE	<ul style="list-style-type: none"> <li>● For preventing electrostatic discharge, and therefore oil ageing products and varnish, in hydraulic and lubrication systems</li> <li>● High <math>\beta_{x(c)}</math> values</li> <li>● Contamination retention</li> <li>● <b>We recommend this is used in conjunction with IXU (for varnish removal)</b></li> </ul>	3, 5, 10, 20	20 or 210
	incl. 			

# Filter Element Technology

## High Quality Element Technology for Hydraulic Oils and Lubricants

		Technical properties	Filtration rating [µm]	Collapsing pressure [bar]
	<b>Mobilemicron®</b> MM	<ul style="list-style-type: none"> <li>● High <math>\beta_{x(c)}</math> values</li> <li>● Contamination retention</li> <li>● Particularly low element differential pressure</li> </ul>	8, 10, 15	20
	<b>ECOMICRON®</b> ECO/N	<ul style="list-style-type: none"> <li>● High <math>\beta_{x(c)}</math> values</li> <li>● Contamination retention</li> <li>● Low element differential pressure</li> <li>● <b>Incinerable</b></li> <li>● High flow fatigue stability</li> </ul>	3, 5, 10, 20	10
	<b>Stainless steel wire mesh</b> W, W/HC	<ul style="list-style-type: none"> <li>● Low pressure drop</li> <li>● Limited cleanability</li> </ul>	25, 50, 100, 200, ...	20
	<b>Stainless steel fibre</b> V, VB	<ul style="list-style-type: none"> <li>● Limited cleanability</li> </ul>	3, 5, 10, 20	210
	<b>Paper</b> P, P/HC	<ul style="list-style-type: none"> <li>● For less stringent filtration requirements</li> </ul>	10, 20	10
	<b>Aquamicron®</b> AM	<ul style="list-style-type: none"> <li>● <b>High water absorption</b></li> <li>● Low element differential pressure</li> </ul>	2, 20, 40	10
	<b>Betamicron®/Aquamicron®</b> BN/AM	<ul style="list-style-type: none"> <li>● <b>High water absorption</b></li> <li>● High contamination retention</li> <li>● Low element differential pressure</li> </ul>	3, 10	10

# Filter Element Technology

## High Quality Element Technology for Hydraulic Oils and Lubricants

### Technical data

Filtration rating in  $\mu\text{m}$

#### Dimicron® N15DM



- Filtration efficiency:  $\beta(x) > 1,000$  at  $\Delta p = 2$  bar
- Combination of deep and surface filtration = High level of cleanliness in a single pass
- Extremely high contamination retention capacity = formation of a filter cake with robust support provided by membrane to prevent material migration

2, 5, 10, 20, 30

N10DM

2, 5, 10, 20

N5DM

- $\beta(x) > 1,000$  at  $\Delta p = 2.5$  bar
- Extremely high contamination retention capacity

2, 5, 10, 20

#### Trimicron®







TM  
N1  
N3

- Combined pleated and spun spray elements
- Removal of oil ageing products, fine particles and water

3

# Filter Element Technology

## Efficient Element Technology for Systems with Consistently High Contamination Intake

Technical properties		Filt. rating in $\mu\text{m}$
 <p><b>Flexmicron Premium®</b> FM-P</p>	<ul style="list-style-type: none"> <li>● Graduated depth filtration in thin media layer = Long lifetime even with fluids which are difficult to filter</li> <li>● Low initial differential pressure = High contamination retention capacity</li> <li>● Robust support for non-woven media = Prevents material migration during pulsation</li> <li>● Compact housing with high flow rates</li> <li>● Standard dimensions, compatible with other manufacturers</li> </ul>	1-90
 <p><b>Flexmicron Standard®</b> FM-S</p>	<ul style="list-style-type: none"> <li>● Graduated depth filtration = High level of cleanliness in a single pass</li> <li>● Thick layer of filter media = High retention capacity for contamination</li> <li>● Standard dimensions, compatible with other manufacturers</li> </ul>	
 <p><b>Flexmicron Economy®</b> FM-E</p>		
 <p><b>Wombat</b> WB</p>	<ul style="list-style-type: none"> <li>● Bag filter with pleated filter area = High contamination retention capacity</li> <li>● Flow direction from in to out = No transfer of contamination onto the clean side when changing filter element</li> <li>● Good fluid compatibility and temperature resistance</li> </ul>	1-90



# Filter Element Technology

## High Quality Element Technology for Diesel Fuels

### Technical properties

Filtration rating  
ISO 19438



#### Dieselmicron®

- All-synthetic filter media
- Integrated, 2-stage water elimination function at a separation efficiency rate  $\eta > 95\%$  to ISO/CD 16332
- Long service life due to high contamination retention capacity and certified resistance to all conventional diesel fuels
- Environmentally friendly - fully incinerable

Standard version  
(10  $\mu\text{m}$ )  
 $\eta_{> 10 \mu\text{m} (c)} > 99\%$   
→ further, typical pre-filter  
filtration ratings  
available



#### Optimicron® Diesel

- For the filtration and dewatering of diesel, mainly in stationary systems

#### Filter elements



N10ON-DF  
N20ON-DF

- High contamination retention capacity for offline applications
- Optimum protection, even for downstream water separation functions
- Filtration efficiency  $> 99.8\%$
- Flow direction from outside to inside

3 to 10  $\mu\text{m}$



N42ON-DF

- Flow from inside to outside
- Top contamination retention capacities and separation values in a single pass for use in transfer filtration of larger flows

3 to 20  $\mu\text{m}$

#### Coalescence and separation elements



N7ON-DC

- Flow direction from outside to inside
- Separation of water with a separation rate  $> 95\%$  on basis of two-stage process
- Separation of solid particles with separation rate  $> 99.8\%$

5 to 30  $\mu\text{m}$



N42ON-DC

- Flow from inside to outside
- Water separated by means of coalescence, specially for use with large flows



N32ON-DS

- Flow direction from outside to inside
- Removal of very small water droplets from large flows
- Use in combination with N42ON-DC elements for optimum water separation results

# Filter Element Technology

## Filter Element Technology for Process Technology

### HYDAC AutoFilt® filter elements RF3 / RF4 / RF5 / RF7



- Low viscosity fluids
- Isokinetic filtration and back-flushing
- Residue-free cleaning
- Fewer back-flushing cycles
- Lower back-flushing losses
- Even flow characteristics

### HYDAC AutoFilt® RF9 filter elements



- Low to high viscosity fluids
- Isokinetic filtration and back-flushing (conical filter elements)
- Residue-free cleaning
- High contamination retention capacity (pleated filter elements)
- Fewer back-flushing cycles
- Lower flow resistance

### HYDAC AutoFilt® RF10 filter elements



- Low to high viscosity fluids
- Conical filter elements with JetFlush technology
- Residue-free cleaning
- Even flow characteristics

### Inline and pressure filter elements

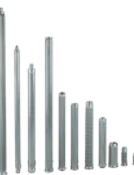

- Low to high viscosity fluids
- Standard and customised models
- Excellent differential pressure stability
- High porosity
- Pressure filter elements up to 210 bar  $\Delta p$

### Gas coalescer and gas particle filter elements



- High level of defined filtration efficiency
- Low pressure loss
- High contamination retention capacity
- High pressure stability thanks to Chemicon® metal fibre
- Filtering surface of the coalescer filter elements designed for optimum aerosol separation capacity
- End caps and connection adaptors crimped – no bonding agents
- No electrostatic charging
- Also available as betterfit variant

Type	Filtration rating in $\mu m$
Slotted tube conical	50 – 3,000
SuperMesh conical	25, 40, 60, 80
Slotted tube conical, SuperFlush coating	50 – 3,000
SuperMesh conical, SuperFlush coating	25, 40, 60
Chemicon®	1 – 100
Dutch weave	25 – 60
Square mesh	100 – 500
Slotted tube conical	50 – 3,000
SuperMesh conical	25 – 60
Slotted tube conical SuperFlush coating	50 – 3,000
SuperMesh conical SuperFlush coating	25 – 60
Slotted tube cylindrical	50 – 3,000
Chemicon®	3 – 20 (absolute)
Wire mesh	25 – 500
Flexmicron	1 – 90
Betamicron®	3 – 20 (absolute)
Chemicon®	0.5 – 25 (absolute)

# Filter element technology

## Filter Materials for Process Technology

### Screen basket filter elements



- Low viscosity fluids
- Pre-filtration
- Coarse filtration
- Filtration direction from inside to outside
- Cleanable filter materials

### PELF1 inline filter elements



- Low viscosity fluids
- Filter material Ecomicon®
- Very large filter area per element > 5 m<sup>2</sup>
- Low pressure drops
- High contamination retention capacity
- High filtration efficiency

### Flexmicron inline filter elements



- High contamination retention capacity
- Long service life
- Compact housing with high flow rates

### Betamicron® inline filter elements



- High contamination retention
- High level of particle removal over a wide differential pressure range
- High resistance to fluctuations in pressure and flow rate

### Filter bag



- Low viscosity fluids
- Continuous removal of solid particles
- Flow direction from in to out





Type	Filtration rating in µm
Wire mesh	25 – 1,000
Slotted tube	50 – 3,000
Perforated plate	3,000
Ecomicon®	1 – 90
Polyester, pleated	
Flexmicron Economy®	1 – 90
Flexmicron Standard®	
Flexmicron Premium®	
Betamicron®	3 – 20 (absolute)
Filter bag PP/PE/nylon	1 – 1,000

# Filter element technology

## Filter Materials for Process Technology

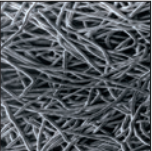
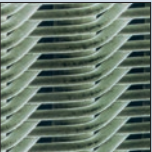

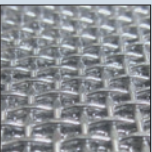
### Cleanable filter materials

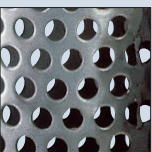

Material	Description	Filtration Surface		Material	Filtration rating in $\mu\text{m}$	Retention rate		Temperature in $^{\circ}\text{C}$	Used in following HYDAC filter
		Surface ●	Depth ◆			Nominal ■	Absolute ▲		
	Chemicon® metal fibre	◆	◆	Stainless steel	1 to 100 0.5 to 25 for gases	▲		400	Inline filter
	Wire mesh (Dutch weave)	●		Stainless steel	25 to 60	■		400	Inline filter Automatic back-flushing filters
	Wire mesh Square mesh	●		Stainless steel	100 to 500	■		400	Inline filter Automatic back-flushing filters
	Wire mesh SuperMesh	●		Stainless steel	25 to 60	■		400	Automatic back-flushing filters
	Slotted tube	●		Stainless steel	50 to 3,000	■		400	Inline filter Automatic back-flushing filters
	Perforated plate	●		Stainless steel	3,000 to 10,000	■		400	Screen basket filter

# Filter element technology

## Filter Materials for Process Technology

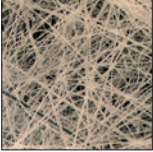
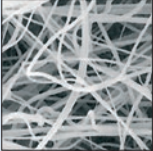

### Non-cleanable filter materials

Material	Description	Filtration		Material	Filtration rating in µm	Retention rate		Temperature in °C	Used in following HYDAC filter
		Surface ●	Depth ◆			Nominal ■	Absolute ▲		
	Betamicron®	◆		Glass fibre	3 to 20		▲	95	Inline filter
	Synthetic non-woven material	◆		PP / PES / nylon	1 to 100		▲	95	Inline filter
	Filter bag	◆	●	PP / PE / nylon	1 to 1,000	■	▲	80	Inline filter

## Special Features

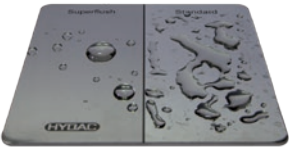
Description	Features
<p><b>SuperFlush coating</b></p>  <p>with                  without</p>	<ul style="list-style-type: none"> <li>● Suitable for low viscosity fluids</li> <li>● Can be used in virtually all sectors of industry</li> <li>● Unique coating technology</li> <li>● Available as an option for conical filter elements</li> <li>● Standard in HYDAC ballast water applications</li> <li>● Prevents particle build-up on the filter element surface</li> <li>● Gel-like particles do not adhere to the filter element surface</li> <li>● Prevents biofouling</li> <li>● Increased service life</li> <li>● Increased efficiency</li> </ul>



# HYDAC Expertise – Understanding Fluids

## What is it all about?

Once the direct connection between fluid condition and the profitability and efficiency of hydraulic and lubrication systems is recognised, the action required becomes obvious:

Cooling, continuous online monitoring and a well-engineered filtration concept guarantee the efficiency and operational reliability of the entire system.

In addition to “filter” components, HYDAC also provides modern solutions in the areas of cooling and condition monitoring which are specific to your system. Only by taking an integrated approach is it possible to improve the condition of the fluid used and to reduce the Life Cycle Costs.

HYDAC prides itself on understanding fluids to make life easier for system operators through the use of relevant product solutions.

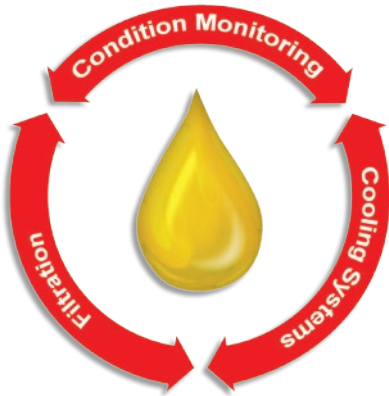

## Cooling Systems

In all hydraulic systems, energy is converted and transported. This gives rise to losses, as mechanical and hydraulic energy is partly converted into heat. It is the function of cooling systems to dissipate this heat, because if the heat remains in the system and it overheats, the consequence is contamination in the operating medium, which can lead to damage in the components.

That is why a common-sense “understanding of fluids” without cooling systems is inconceivable. Precisely for this reason, therefore, HYDAC sees itself as an efficient supplier and partner of components and systems of cooler technology in modular design for these tasks.

For further information on the subject of “Cooling Systems”, see the separate brochure D/E/F 5.700



## Condition Monitoring

Only if the operating fluid is in perfect condition can one guarantee smooth system function. Friction, leakage and ageing processes leave traces in the medium, e.g. in the form of particles or water.

The oil condition is to a certain extent an indicator of the condition of the whole system. So “understanding the fluid” also implies measuring the condition of the operating fluid.

The condition can be determined by condition monitoring, which aims to enable predictive maintenance based on fluid condition. Condition monitoring systems for fluid technology can thus efficiently help to reduce the life cycle cost (LCC) of your system.

HYDAC provides a comprehensive range, from components to ready-to-install systems, as well as conditioning services tailored to the application.

The product range includes solutions for all sections of the condition monitoring system: data acquisition, interpretation, control and monitoring.

For further information on the subject of “Condition Monitoring”, see the separate brochure E 10.122



## Filtration

The cleaner the operating fluid, the more smoothly hydraulic and lubrication systems will function. Approx. 75% of all system failures are due to damage to the components used – caused by contaminated fluid. Therefore a common-sense “understanding of fluids” will include the purchase of high quality filtration.

HYDAC has spent the last 40 years developing filter solutions to increase service life and protect components. Increasing the operational availability of your hydraulic and lubrication systems, as well as reducing down-times, is our main focus. In process technology, too, HYDAC is setting the standard with innovative products such as back-flushing filters and inline filters.

# Different Factors Affecting Fluid Condition

Lubricant properties have a significant influence on the functionality and service life of your systems or machines. Fluid condition monitoring and corresponding fluid conditioning guarantee the functionality, availability, and service life of industrial systems in stationary and mobile hydraulics.

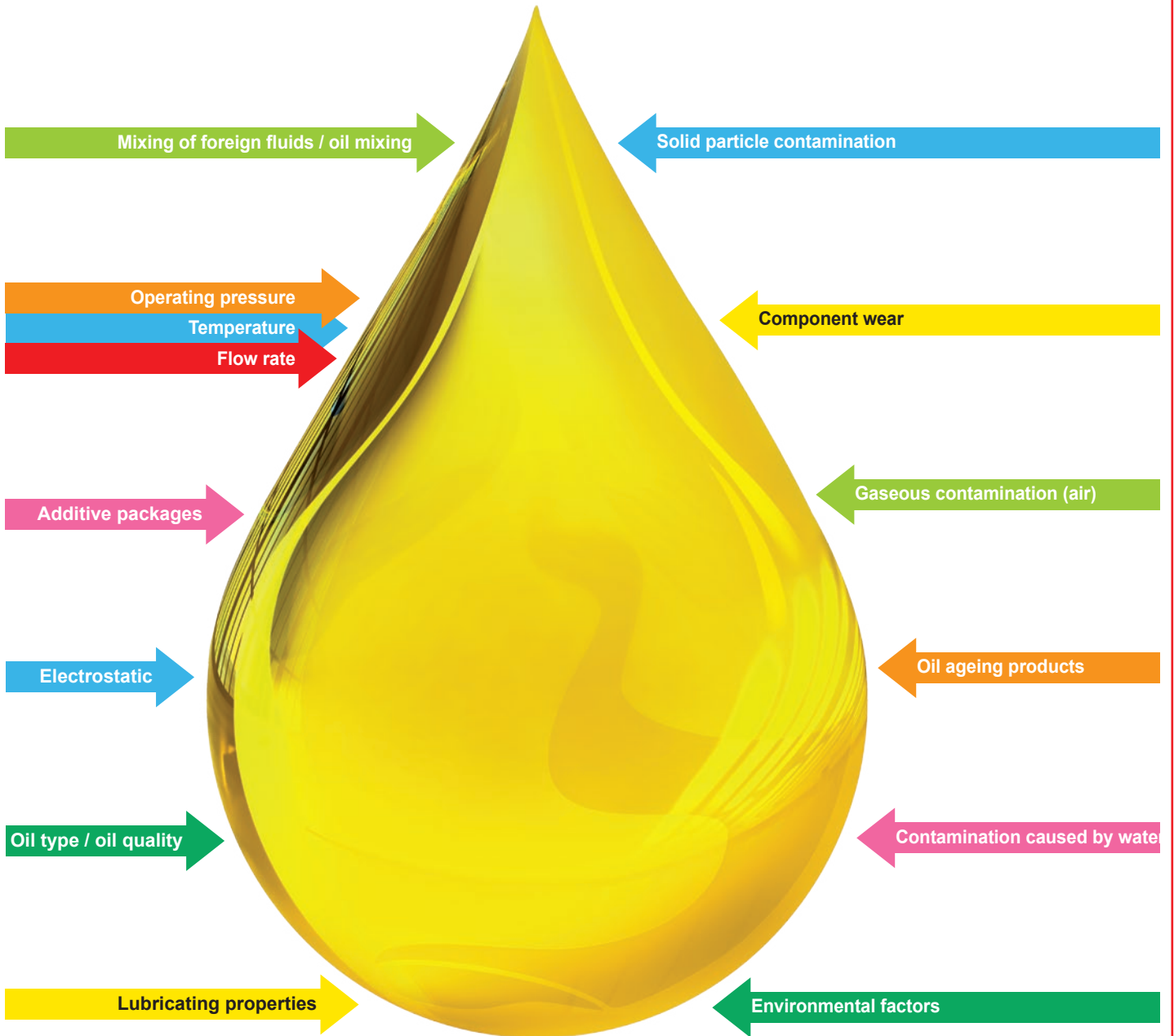



# Contamination and Filtration

## What is the contamination?



Oil ageing



Water in oil

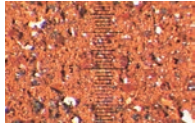

Rust

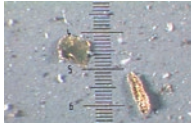

Particle contamination

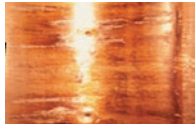

Bearing wear

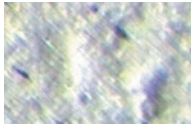

Zinc soap



Corrosion on the tank floor

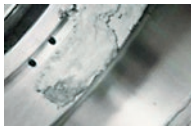

Damaged components

### Solid particles

- Rust
- Additives
- Metal shavings
- Paint particles
- Plastic particles
- Rubber
- Fibres
- Metallic salts

### Fluids

- Water in hydraulic and lubrication oils
- Acids
- Gel-type contamination

### Gases

- Air

## What size range are we looking at?

The relative sizes of solid particles as commonly found in hydraulic and lubrication media, are:

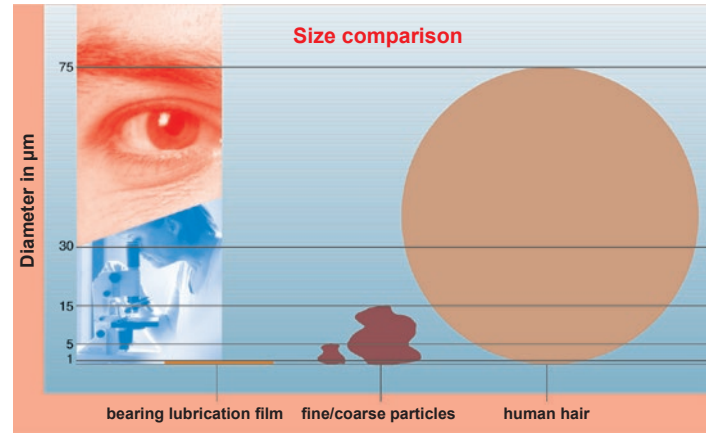

## How is solid particle contamination classified?

The classification of solid particle contamination in hydraulic and lubrication fluids generally follows ISO 4406: 1999 / SAE AS 4059, sometimes also the obsolete ISO 4406:1987 / NAS 1638 (for overview, see table). More detailed information on standards can be found in the brochures "Contamination Management in Practice" or "Particle Measurement Technology in Practice".

Standard	ISO 4405	ISO 4406:1999	NAS 1638	SAE AS 4059
<b>Area of application</b>	Heavily contaminated fluids, e.g. washing fluids, machining fluids	Hydraulic fluids, lubrication oils	Hydraulic fluids, lubrication oils	Hydraulic fluids, lubrication oils
<b>Parameters</b>	[mg/litre fluid]	Number of particles > 4 $\mu\text{m}$ (c) > 6 $\mu\text{m}$ (c) > 14 $\mu\text{m}$ (c)	Number of particles 5 – 15 $\mu\text{m}$ 15 – 25 $\mu\text{m}$ 25 – 50 $\mu\text{m}$ 50 – 100 $\mu\text{m}$ > 100 $\mu\text{m}$	Number of particles > 4 $\mu\text{m}$ (c) > 6 $\mu\text{m}$ (c) > 14 $\mu\text{m}$ (c) > 21 $\mu\text{m}$ (c) > 38 $\mu\text{m}$ (c) > 70 $\mu\text{m}$ (c)

The ISO Code can be "translated" into a maximum particle quantity for each particle size range with the aid of the adjacent table. This code is determined for each size range.

The oil cleanliness class determined by electronic particle counters is expressed as a combination of three numbers, e.g. 21/18/15; the particle quantity determined by microscopic counting is expressed as a combination of two numbers, e.g. -/18/15

ISO Code (to ISO 4406)	Particle quantity/100ml		Determined using...
	from	to	
5	16	32	...electronic particle counter 21 / 18 / 15 > 4 $\mu\text{m}_c$ > 6 $\mu\text{m}_c$ 14 $\mu\text{m}_c$
6	32	64	
7	64	130	...microscopic counting - / 18 / 15 > 5 $\mu\text{m}_c$ 15 $\mu\text{m}_c$
8	130	250	
9	250	500	
10	500	1000	
11	1000	2000	
12	2000	4000	
13	4000	8000	
14	8000	16000	
15	16000	32000	
16	32000	64000	
17	64000	130000	
18	130000	260000	
19	260000	500000	
20	500000	1000000	
21	1000000	2000000	
22	2000000	4000000	
23	4000000	8000000	
24	8000000	16000000	
25	16000000	32000000	
26	32000000	64000000	
27	64000000	130000000	
28	130000000	250000000	

# Contamination and Filtration

## What damage can the contamination cause?

1. **Abrasion**  
caused by particles between reciprocating surfaces.
2. **Erosion**  
caused by particles and high fluid velocity.
3. **Adhesion**  
caused by metal-to-metal friction (loss of fluid).
4. **Surface fatigue**  
surfaces damaged by particles are subjected to repeated stress.
5. **Corrosion**  
caused by water or chemicals (not included below).

## Consequences

The contamination in the system and the associated mechanical damage patterns result in:

- Poor system cleanliness class
- System failures
- High level of component wear
- Cavitation
- Formation of sludge (from formation of oil ageing products, such as varnish)
- Reduction in thickness of dynamic lubrication film
- Shorter oil service life due to accelerated oil ageing

## What are the costs to me of such damage?

The damage outlined has a negative affect on the maintenance costs of the system. Generally, you can expect a rise in the following costs:

- Spare parts costs
- Costs of stoppage times
- Guarantee costs and ex gratia payments
- Energy costs
- Re-working costs
- Tooling costs for machining centres
- Operating costs of washing machines and test rigs
- Working time costs (above all for maintenance personnel)

## Which cleanliness classes are recommended by component manufacturers?

Component manufacturers, too, recognise the problem of particle contamination and specify guidelines for the cleanliness of systems.

Cleanliness requirements for lubricating and hydraulic components	Low / medium pressure > 140 bar (moderate conditions)		High pressure 140 ... 200 bar (low / medium under poor conditions <sup>1)</sup> )		Very high pressure > 200 bar (high pressure under poor conditions <sup>1)</sup> )	
	ISO 4406:1999 Target cleanliness class	Filtration rating in µm	ISO 4406:1999 Target cleanliness class	Filtration rating in µm	ISO 4406:1999 Target cleanliness class	Filtration rating in µm
<b>Pumps / motors</b>						
Gear or vane	20/18/15	20	19/17/14	10	18/16/13	5
Piston	19/17/14	10	18/16/13	5	17/15/12	3
Variable vane	18/16/13	5	17/15/12	3	not applicable	not applicable
Variable piston	18/16/13	5	17/15/12	3	16/14/11	3 <sup>2)</sup>
<b>Drives</b>						
Cylinders	20/18/15	20	19/17/14	10	18/16/13	5
Hydrostatic drives	16/15/12	3	16/14/11	3 <sup>2)</sup>	15/13/10	3 <sup>2)</sup>
Test rigs	15/13/10	3 <sup>2)</sup>	15/13/10	3 <sup>2)</sup>	15/13/10	3 <sup>2)</sup>
<b>Valves</b>						
Check valve	20/18/15	20	20/18/15	20	19/17/14	10
Directional valve	20/18/15	20	19/17/14	10	18/16/13	5
Standard flow control valve	20/18/15	20	19/17/14	10	18/16/13	5
Poppet valve	19/17/14	10	18/16/13	5	17/15/12	3
Proportional valve	17/15/12	3	17/15/12	3	16/14/11	3 <sup>2)</sup>
Servo valve	16/14/11	3 <sup>2)</sup>	16/14/11	3 <sup>2)</sup>	15/13/10	3 <sup>2)</sup>
<b>Bearings</b>						
Plain bearing <sup>3)</sup>	18/15/12	10	not applicable	not applicable	not applicable	not applicable
Gears <sup>3)</sup>	17/15/12	10	not applicable	not applicable	not applicable	not applicable
Ball bearing <sup>3)</sup>	15/13/10	3 <sup>2)</sup>	not applicable	not applicable	not applicable	not applicable
Roller bearing <sup>3)</sup>	16/14/11	5	not applicable	not applicable	not applicable	not applicable

1) Poor conditions may include flow rate fluctuations, pressure spikes, frequent cold starts, extremely high ingress of contamination, or the presence of water.

2) Two or more system filters with the recommended filtration rating may be required to achieve and maintain the desired target cleanliness class.

3) Valid for the average diameter range.

**For system cleanliness, we recommend working at one class better than the cleanliness class required for the most sensitive component.**

**Filling filtration / flushing filtration to be at least one filtration class finer than the system filter.**

**According to DIN 51524, a cleanliness of ISO 21/19/16 must be guaranteed for new hydraulic oil.**

## How do I know if contamination has got into my hydraulic or lubrication system and how do I measure it?

### 1) Permanent online fluid monitoring in hydraulic and lubrication systems and on test rigs (Online Condition Monitoring)

Through the use of permanently installed fluid sensors, the condition of the system can be continuously monitored online.

This forms the basis of planned availability of systems and components, prevention of unexpected stoppage times and condition-based maintenance.

HYDAC offers an extensive product range of fluid sensors for recording

- Solid particle contamination
- Metallic particles or
- Fluid contamination (water)

The measurements can either be displayed and stored directly on the built-in display on the sensor or via a separate display unit. In addition it is also possible to integrate the measurements in the customer's own control system as well as transfer them to a PC.

The data from the connected sensors is displayed online as a table & graphics and is also automatically stored in files.

The files can be opened again in the software and can be exported in different formats (e.g. MS Excel format, different graphics formats).

Moreover, the graphic currently displayed can be printed using this software.

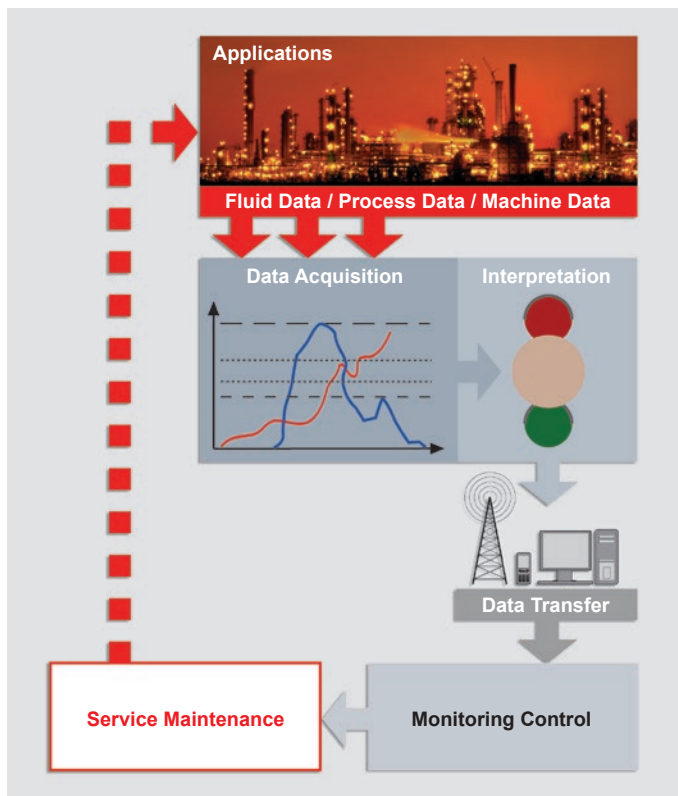

### 2) Short-term fluid monitoring and service (Offline Condition Monitoring)

For short-term measurement of particle contamination, water saturation and temperature, portable plug & work instruments are used.

Short-term system analysis can be undertaken on unpressurised reservoirs (sampling), control circuits and high pressure circuits.

The measurements are stored in the internal memory and can be transferred to a PC via a number of different interfaces, and displayed, processed and printed out in HYDAC's own FluidMonitoring Software FluMoS.



Fluid condition monitoring equipment for permanent installation or short-term use

### 3) Oil sample analysis in the laboratory (Offline Condition Monitoring)

Whether it is to analyse individual oil samples or up to 500 oil samples per day, the HYDAC product range has the just the right equipment.

The laboratory particle laser counter for sample bottle analysis allows measurements to be stored, transferred and printed out.

The fully automated laboratory particle counter is also available with a robotic arm, as an option. Automated and monitored processing of measurement and rinsing cycles.

“All in one” system including PC, keyboard and monitor for user-friendly operation and graphical evaluation of the results through the use of ALPC Desk software.

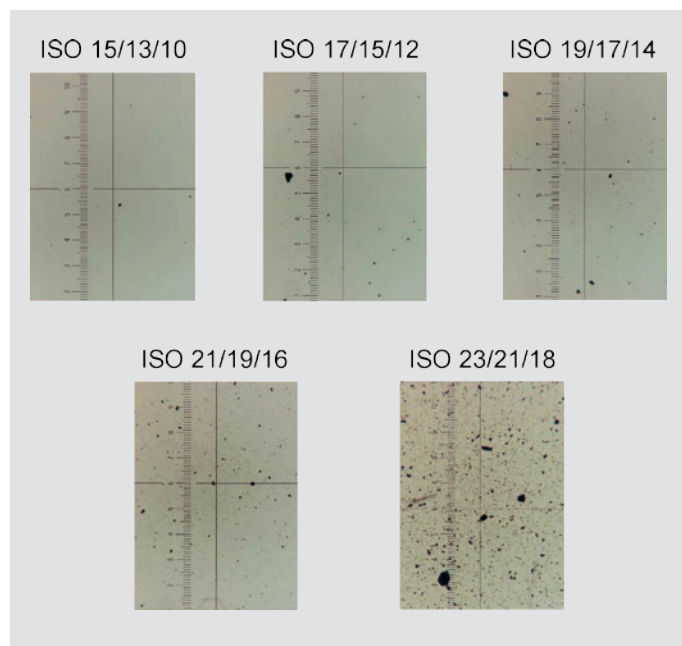

Oil samples under the microscope in the laboratory

# HYDAC Expertise – Understanding Process Fluids

## Process Media

Water



Polymer melts



Seal gas



Ballast water

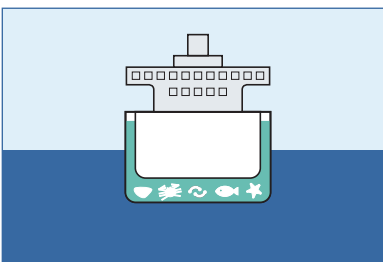

Cooling lubricant



Heavy engines

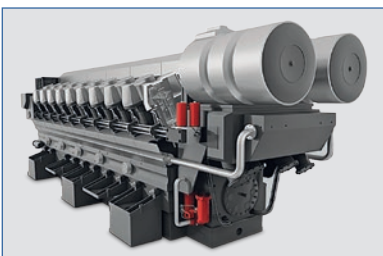

## Why Filter Process Fluids?

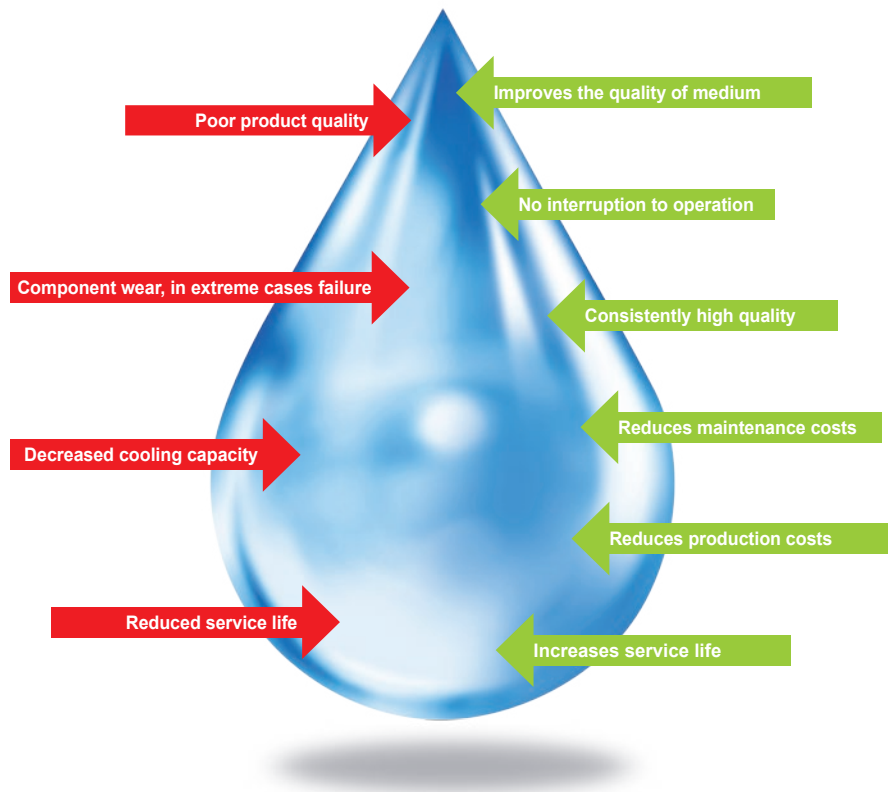

## Selecting a Suitable Process Filter

In contrast to hydraulic media the solid contamination of process media is not classified according to ISO. No two applications for which process media filtration is required are alike. Nevertheless, various parameters can be identified from which it is possible to make the best selection to match the filter to the particular process.

In addition to having an exact description of the application, one of the first steps in selecting the appropriate filter is the classification and analysis of the filtered medium.

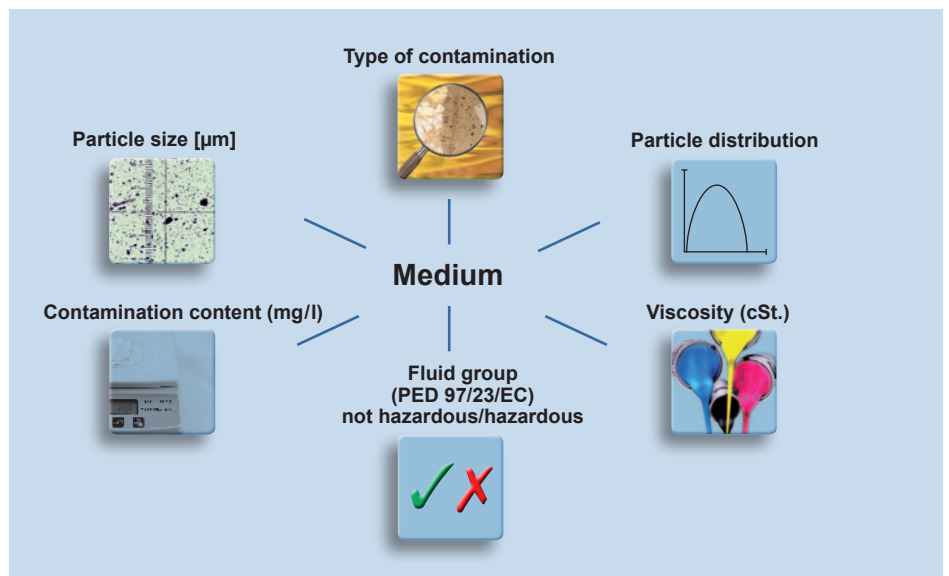

## Main Design Principles of a Process Filter

When selecting and matching the filter to the individual and process-specific conditions, the following design principles should be factored in.

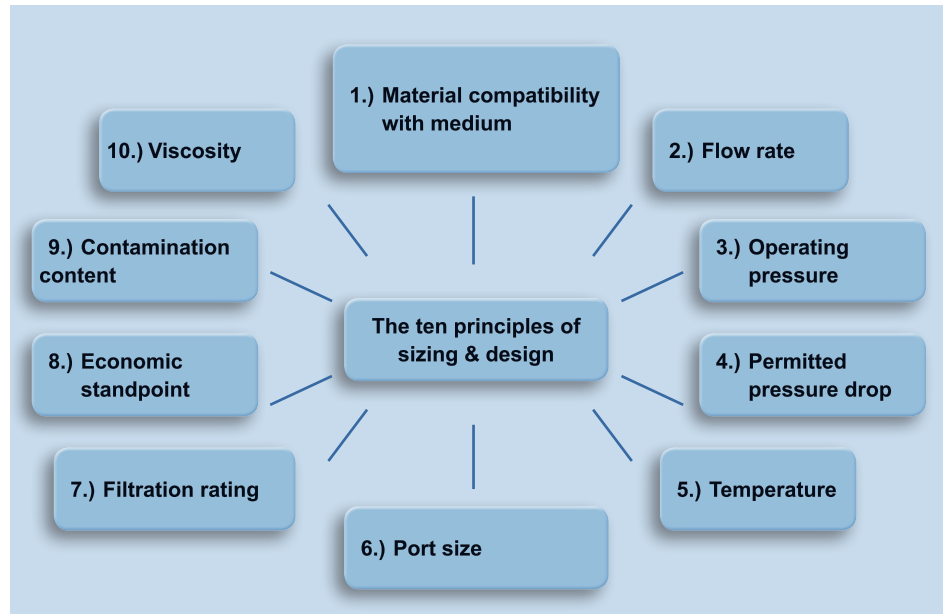

## Process Media

### Water



Many industrial companies require different types of process and service water for their production and manufacturing processes. These include, for example, water for cooling purposes, washing and flushing water, seal water for glide-ring seals, service water to prepare chemical solutions etc. The use of drinking or mains water for such applications is too expensive as a rule and so ground or surface water is utilised for these purposes. Depending on the application and the quality of the raw water, more or less complex treatment is required for the water to obtain the required water quality.

In all water treatment processes, the solid particles suspended in the untreated water must always be filtered out in order to be able to guarantee operationally safe recovery of process and service water. Owing to its broad product range of automatic back-flushing filters HYDAC can provide the right process filter for almost all areas of application and industry.

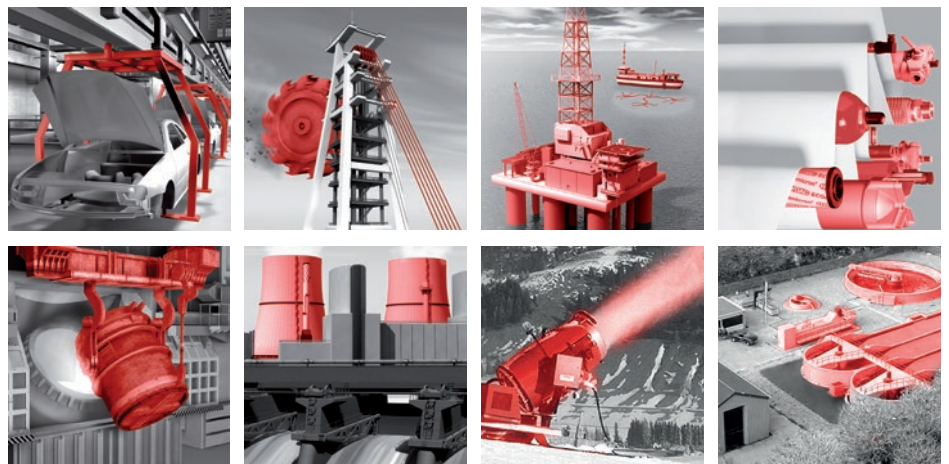

and many more



## Polymer Melts

A specialist area of fluid filtration is in the production and processing of plastics. In addition to the impurities brought in from outside and caused by the manufacture of raw materials, the presence of gels and specks often brings further problems in product quality assurance.

Filtration using special filter elements made from Chemicon (metal fibre), in filtration ratings of 1 and 100 µm absolute, has proven most effective in this field. The filter elements are pleated as standard or available in customised versions.

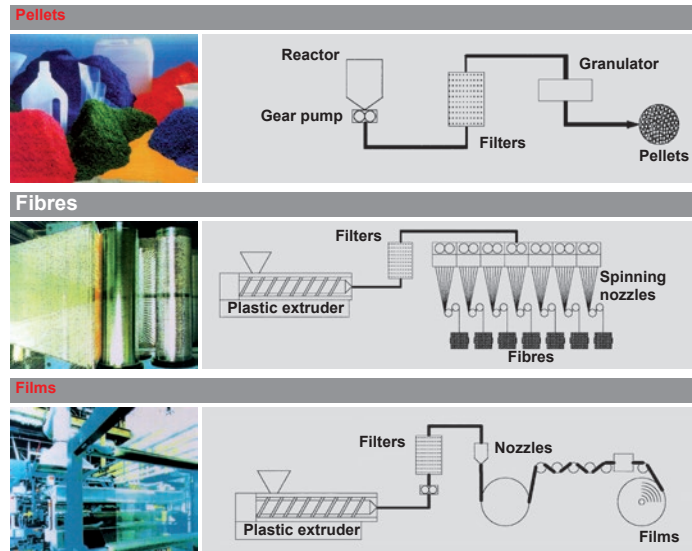

Application diagrams showing manufacture of pellets, fibre or film



## Seal Gas

HYDAC gas filters have been specially developed for use in dry gas seals in turbo compressors.

Dry gas seals on turbo machines are very complex systems and extremely sensitive to contamination from solid particles, aerosols and condensates. Whilst the shaft is rotating, a tiny gap, just 3 µm wide, is formed at the seal ring, through which the seal gas flows. To protect these seals, the seal gases must be filtered accordingly to ensure the seal has as long a service life as possible.

Filter elements with a coalescing action (coalescer elements) are invariably used in all HYDAC seal gas filters.

All the elements consist of a pleated filter material which defines the micron rating and the contamination retention capacity, and coalescer materials which cause the fluid phase to coalesce.

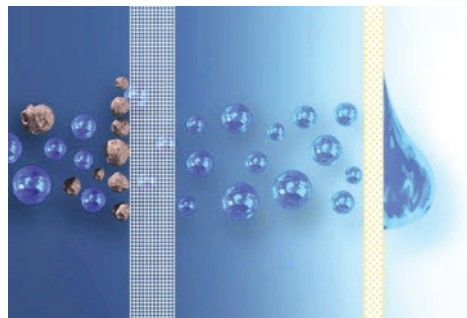

The design criteria for HYDAC seal gas filters are clearly described in the API. The customer requirements take precedence, and these can be different to the API. HYDAC has developed special design software for sizing and matching the filter to the particular application.

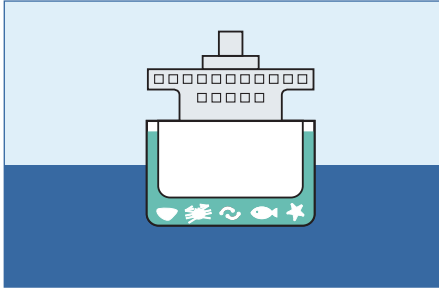

## Ballast Water

Water is required to provide ballast depending on the load condition of the ship. Up to now, the exchange of ballast water has given rise to the risk of sea-life being transported to areas where they damage the ecosystem.

For this reason, so-called ballast water treatment systems are to be installed on ships in future. By using mostly two-stage systems which consist initially of pre-filtration followed secondly by disinfection (such as electrolysis, UV irradiation or ozonation systems) harmful microorganisms and viruses are killed.

The automatic back-flushing filter AutoFilt® from HYDAC is ideally suited to pre-filtration and have already a proven track-record in numerous installations.

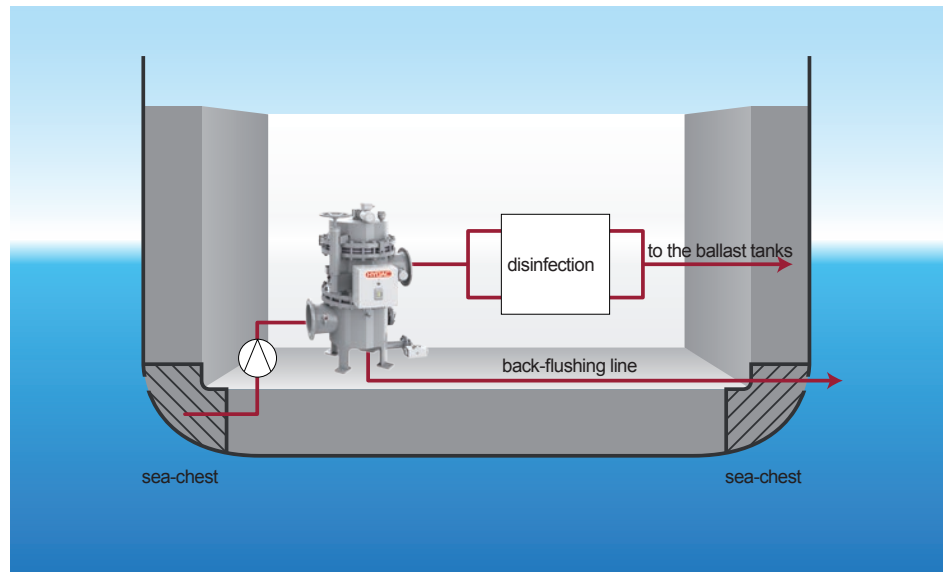

## Cooling Lubricant

### Functions of cooling lubricants

Cooling lubricants are used in modern manufacturing for cutting and forming with machine tools and essentially perform the following tasks.

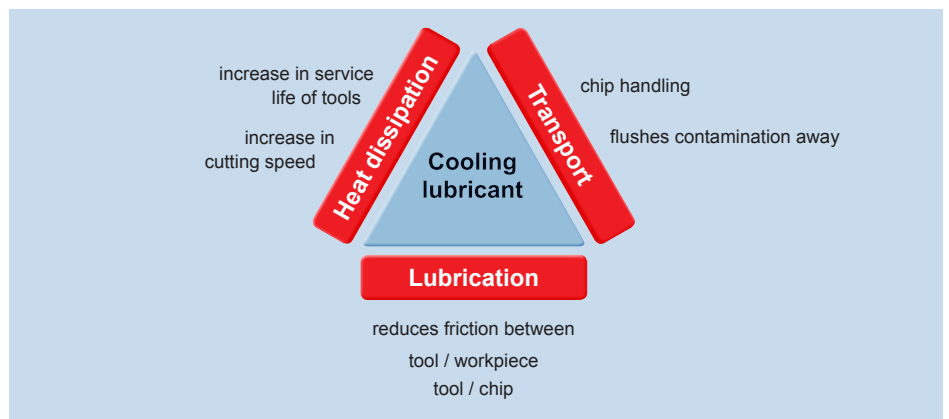

The relative importance and emphasis of the individual criteria are dependent on the particular machining process. In addition, all cooling lubricants for metal machining are optimally suited to numerous secondary requirements which also have positive implications for the user:

- Consistent stability for long term use due to perfect filtration
- Excellent corrosion protection
- Neutral to compatible elastomers, machine coatings
- Reduced machine breakdown costs and maintenance costs as a result of consistent conditioning
- Easy disposal





## Range of cooling lubricants

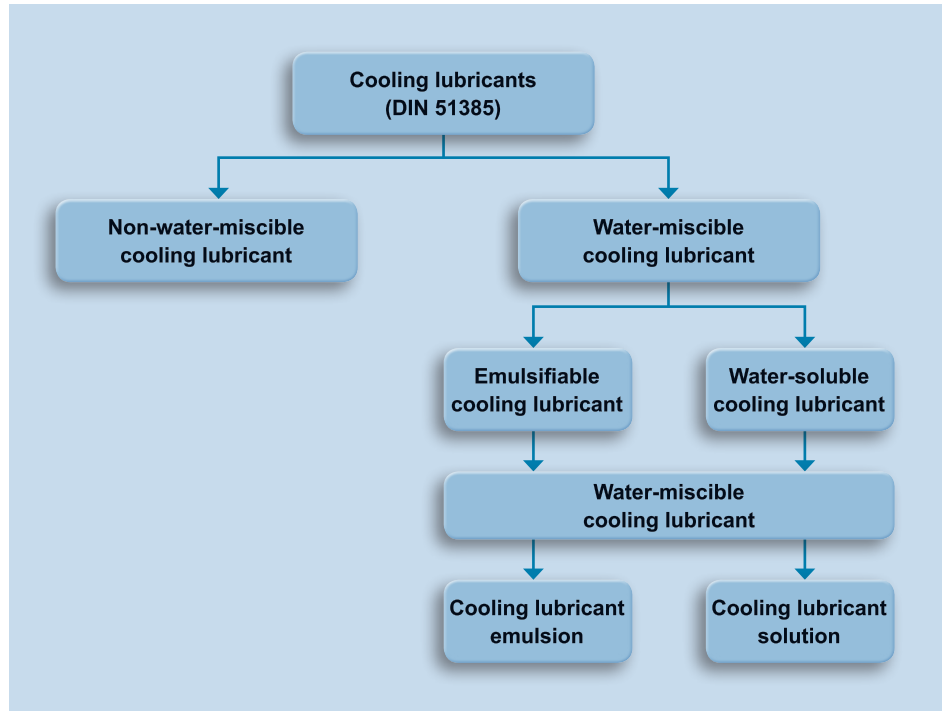

## Filtration of cooling lubricant

### Even the best cooling lubricant will not work without conditioning!

In order to be able to guarantee the best use of the cooling lubricant over a long time period, effective filtration is essential.

All contamination which enters the system must also be removed from the system by filtration.

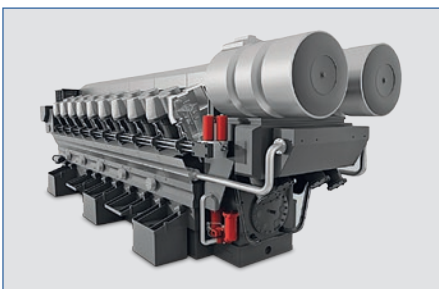
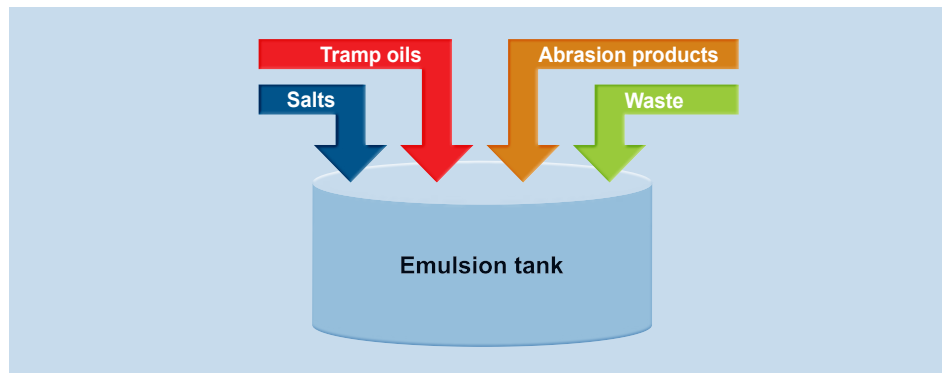

## Heavy Engines

In response to the Tier III standard to come into effect in 2016, the International Maritime Organization (IMO) is setting tighter limits for climate-relevant ship exhaust gases such as nitrogen oxides and sulphur oxides. The marine engine builders are using common rail systems to reduce fuel consumption and to reduce the exhaust gases. This creates new requirements for efficient fluid management in marine engines.

To meet the resulting demand for cleanliness in marine fuels and lubricants, HYDAC presents the new AutoFilt® RF9. This filter is a product of HYDAC's expertise and innovative strength, and unites solid filter technology and tried-and-tested piston accumulator technology to form a new, innovative filter design. What sets the AutoFilt® RF9 apart is its globally unique, patented hydropneumatic back-flushing technology with secure media separation.

The specially developed filter elements with filtration ratings from 1 µm (absolute) offer low flow resistance and high contamination retention capacities.

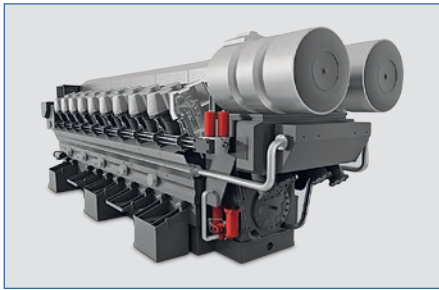

They also clean without leaving any residue. You can benefit from robust filter technology with consistently high cleanliness classes – for diesel fuels, too, up to ISO 11/8/7 – and highly efficient back-flushing, all in one system.

### Efficient fluid management for marine engines

**Clean fuel, clean combustion, clean air.**

- Heavy Fuel Oil
- Diesel (Marine Diesel Oil / Marine Gas Oil)
- Biodiesel oil
- Lubricating oil

**AutoFilt® RF9**





Accumulator Technology 30,000



Filter Technology 70,000



Process Technology 77,000



Filter Systems 79,000



Compact Hydraulics 53,000



Accessories 61,000



Electronics 180,000



Cooling Systems 57,000

# Global Presence. Local Expertise. [www.hydac.com](http://www.hydac.com)



- 📍 HYDAC Head Office
- HYDAC Companies
- HYDAC Sales and Service Partners

## **HYDAC** INTERNATIONAL

### **HYDAC FILTER SYSTEMS GMBH**

Industriegebiet  
66280 Sulzbach/Saar  
Germany

Tel.: +49 6897 509-01  
Fax: +49 6897 509-9046

E-mail: [filtersystems@hydac.com](mailto:filtersystems@hydac.com)

### **HYDAC FILTERTECHNIK GMBH**

Industriegebiet  
66280 Sulzbach/Saar  
Germany

Tel.: +49 6897 509-01  
Fax: +49 6897 509-300

E-mail: [filter@hydac.com](mailto:filter@hydac.com)

### **HYDAC PROCESS TECHNOLOGY GMBH**

Industriegebiet Grube König  
Am Wrangelflöz 1  
66538 Neunkirchen  
Germany

Tel.: +49 6897 509-1241  
Fax: +49 6897 509-1278

E-mail: [prozess-technik@hydac.com](mailto:prozess-technik@hydac.com)

Internet: [www.hydac.com](http://www.hydac.com)