

5" 金剛石銼

5" DIAMOND FILES

435



尺寸150mm

■ #200

■特長

- 與K-5類型相比比較厚，200mm長度比較全長及電極沉積長度短，能方便的收納進工具箱中。
- 銼身與柄部呈一體狀，使用相當方便。

■Use : This is the 5" DIAMOND FILE with a soft grip, regarding to the handy convenience for a file working, and this total length (215mm) FILE can be settled in a tool box easily.

規格表 STANDARD TABLE

TYPE	DIMENSION		BOX pcs	kg-10pcs	ITEM No.
	L	ℓ			
扁 HAND	215L	80 ℓ	16 × 4	10	1.0
半圓 HALF ROUND			16 × 4.5	10	0.83

平扁200mm (8") 類型

(金剛石粒度#200, #600)

HAND200mm (DIAMOND GRID NO.#200, #600)

430



■ #200 ■ #600

規格表 STANDARD TABLE

TYPE	DIMENSION		BOX pcs	kg-10pcs	ITEM No.	
	L	ℓ			#200	#600
平 HAND	200L	180 ℓ	21 × 5	0.2	DHI20020	DHI20060

■特長

- 鉗工・扁200mm材料用電極沉積法鍍上金剛石，適用於寬平滑面的作業。

金剛石研具

DIAMOND LAPPER

470



■ #150
■ #200

照片為#200。(Photo: #200)

規格表 STANDARD TABLE

TYPE	DIMENSION		BOX pcs	kg-5pcs	ITEM No.	
	L	ℓ			#150	#200
	200L	50 ℓ	10 × 3	5	0.35	TDHIL10

■ Grid No. ■ #150 (BLUE GRIP)

■ Grid No. ■ #200 (RED GRIP)

金剛石菱形銼

DIAMOND FEATHER EDGE SAW-FILES

445



■ #300

■特長

- 鋸齒修整時使用。在菱形銼的形材上用電極沉積法鍍上金剛石，能有效提高鋸齒的再生能力。

■用途

- 適用於鋸齒再生，切割玻璃，鍛件，超硬金屬，陶瓷等材料的研削。

■Use : DIAMOND GRID # 300 are plated on FEATHER EDGE SAW FILES blank.
It is easier and faster to sharpen the teeth of HAND SAW.

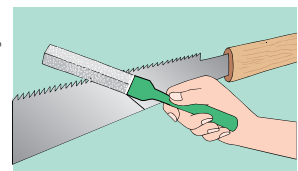

規格表 STANDARD TABLE

TYPE	DIMENSION		BOX pcs	kg-10pcs	ITEM No.			
	L	ℓ			#150	#300		
DIA 菱形銼 DIAMOND FILE-SAW	75mm (3")	155L	70 ℓ	17 × 2.3	10	0.31	—	TDRH 330H
	100mm (4")	180L	90 ℓ	20 × 3.0	10	0.51	TDRH 410H	TDRH 430H
	125mm (5")	215L	100 ℓ	25 × 3.5	10	0.78	—	TDRH 530H

金剛石異形銼 DIAMOND CRAFTSMAN 450

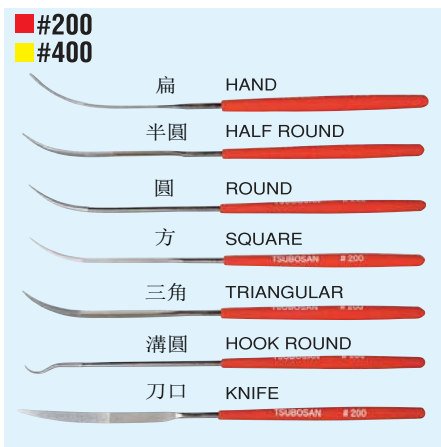

特長

●線徑與S-10類型相同。適用於修整鍛模的底部，溝狀細微部分的作業。

■Use: These bended Diamond RIFLOIRS are used for the Molding-Die works, especially pointed at the corners of bottom of the Molding-Dies.

規格表 STANDARD TABLE

L A mm		7種套	扁 HAND	半圓 HALF ROUND	圓 ROUND	方 SQUARE	三角 TRIANGULAR	溝圓 HOOK ROUND	刀口 KNIFE
170L	2.9A								
電鍍部分長度 PLATED LENGTH (mm)			25	40	25	25	25	25	40
BOX	pcs	7(each1)	7						
kg-7pcs		0.12	0.12						
ITEM No.	#200	TDST20J	TDHI20J	TDHA20J	TDMA20J	TDKA20J	TDSA20J	TDKM20J	TDKH20J
	#400	TDST40J	TDHI40J	TDHA40J	TDMA40J	TDKA40J	TDSA40J	TDKM40J	TDKH40J

金剛石線狀圓銼 DIAMOND LINE-ROUND 428



特長

●金剛石電極沉積鍍層，直徑φ 1.0mm~φ 2.0mm(尖端有錐形)的極細類型。裝置粗柄容易操作性。適用於溝底洞穴加工。

■Use: These Diamond Files like a needle have the diameter range of φ 1.0mm-φ 2.0mm in parallel (tapered to the top) with the bigger handle to use easily. To polish the bore hole.

規格表 STANDARD TABLE

DIMENSION		金剛石粒度 Grid No.	L mm		W mm	BOX pcs	kg-10pcs	ITEM No.
TYPE	TYPE		L mm	l mm				
1.0mm	圓 ROUND	#300	170L	50 l	φ 1.0	10	0.10	DLMA 1030
1.2mm					φ 1.2	10		DLMA 1230
1.5mm					φ 1.5	10	0.12	DLMA 1520
2.0mm					φ 2.0	10	0.12	DLMA 2020

金剛石電動鋸用銼 DIAMOND ROUND CHAIN SAW-FILES 447



特長

●修整電動鋸的刃部時使用。能有效進行電動鋸的刃部再生作業，提高使用壽命。

■Use: These DIAMOND ROUND CHAIN SAW FILES are available to sharpen the teeth of Chain-Saw-Machine, with a speedy work and a long life.

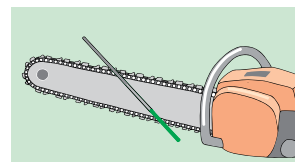

規格表 STANDARD TABLE

DIMENSION		L mm	W mm	BOX pcs	kg-10pcs	ITEM No.	
TYPE	TYPE						
DIA電動鋸用銼 DIAMOND CHAINSAW FILE	φ 3.2mm (1/8")	220L	80 l	φ 3.2	10	0.14	TDMA3230
	φ 4.0mm (5/32")			φ 4.0	10	0.20	TDMA4030
	φ 4.7mm (3/16")			φ 4.7	10	0.30	TDMA4730

金剛石圓形銼 DIAMOND ROUND-TYPE(DIAMOND GRID NO.#400) 460



規格表 STANDARD TABLE

DIMENSION		L mm	W mm	BOX pcs	kg-10pcs	ITEM No.
TYPE	TYPE					
140L	電鍍部分長度 PLATED LENGTH	50 l	φ 1.2	10	0.06	TD 03124
			φ 1.5	10	0.07	TD 03154
			φ 2.0	10	0.08	TD 03204
			φ 2.5	10	0.11	TD 03254
			φ 3.0	10	0.14	TD 03304
			φ 3.5	10	0.16	TD 03354
			φ 4.0	10	0.20	TD 03404

金剛石銼

彈性竹杆金剛石銼 FLEX DIAMOND (Bamboo Stick) 440



■特長

- 因為銼身是竹制的，具有輕和彈性的性能。
- 尖端部分加工成錐形，柔軟性，銼削性，耐久性及操作性出色。
- 有#120，#200，#400，#800等規格。

■Use : By the way of the flexibility of its own bamboo stick, the top point of the stick with the bonded FLEX DIAMOND SHEET (No.442) can be utilized for a slender work, delicately.

規格表 STANDARD TABLE

DIMEN-SION TYPE	金剛石粒度 Grid No.	W mm		ITEM No.
		W	L	
直線型 STRAIGHT-Type	黃色/YELLOW #400	200L	10W	BHI 0840
		170L	6W	BHI 0740
曲型 SHIP-Type	黃色/YELLOW #400	200L	10W	BHIS 840
		170L	6W	BHIS 740
6件套 6-PCS.SET		各一支，金剛石貼皮一張，竹軸一根。 Ins.+FLEX DIA+Bamboo Stick(blank)		BHIS T40

可彎金剛石薄型貼皮 FLEX DIAMOND SHEET 442

■特長

- 薄型貼皮背面為強力粘合膠。
- 根據不同尺寸，用裁紙刀，鐵皮剪等切割後粘貼本公司的竹軸（No. 440）上使用。

■Use : Cut-able freely by scissors or knife. This FLEX DIAMOND SHEET attaches to a special adhesive on each reverse side.



規格表 STANDARD TABLE

DIMEN-SION TYPE	金剛石粒度 Grid No.	L × W mm	kg-10pcs	ITEM No.
可彎金剛石薄型貼皮 (竹軸用) FLEX DIA	黑色/BLACK #120	50 × 50	0.03	TDPA 12K
		50 × 100	0.06	TDPA 12N
	紅色/RED #200	50 × 50	0.03	TDPA 20K
		50 × 100	0.06	TDPA 20N
	黃色/YELLOW #400	50 × 50	0.03	TDPA 40K
		50 × 100	0.06	TDPA 40N
	白色/WHITE #800	50 × 50	0.03	TDPA 80K
		50 × 100	0.06	TDPA 80N

金剛石砂紙 DIAMOND SHEET 490



規格表 STANDARD TABLE

金剛石粒度 Grid No.	T mm	L × W mm	kg-10pcs	ITEM No.
#100	0.5T	50 × 100	0.055	TDPA 100
#200			0.045	TDPA 200
#300			0.040	TDPA 300
#400			0.035	TDPA 400
#600			0.032	TDPA 600

■特長

- 在0.5mm厚（T）的銅板上用電極沉積法鍍上金剛石。用剪刀，裁紙刀自由切割尺寸，用雙面膠或強力膠粘貼使用。

■Use : Cut-able freely by scissors or knife. This is bonded on any surface of tools by a chemical adhesive or a tape.

金剛石修整筆



DIAMOND DRESSER

480



●端部鑽石尺寸為6種。
Diamond grain size
(1/3CT · 1/2CT · 3/4CT · 1CT · 1.5CT · 2CT)

規格表 STANDARD TABLE

 mm	 W mm	 kg-1p	ITEM No.
100	φ10	0.06	TDD 10**
	φ11	0.07	TDD 11**
	φ12	0.09	TDD 12**

ITEM No. ** assorted

CT	1/3	1/2	3/4	1.0	1.5	2.0
**	01	02	03	04	05	06

(注) φ10mm 柄徑無 1.5CT · 2.0CT。
(*) The range of φ10mm shank is upto 1.0CT.



金剛石割磨片

DIAMOND DISK SHARPENER

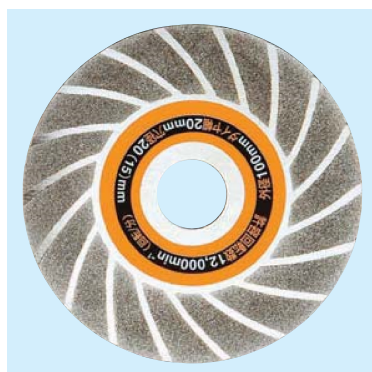
485



規格表 STANDARD TABLE

 mm	 mm	 kg-1p	ITEM No.
φ100W	20w	1.1T	#200 TDE 100



圓盤鋸
(Disk Saw)

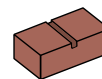

磚瓦 (Block)

用途

●適用於割草用圓盤鋸，刃物的再生研磨和磚，瓷磚等的切割用。

■Use : For sharpening CBN Hand Metal & Knives, or for facing & cutting off ceramic tile and brick block.

金剛石打孔鑽

DIAMOND CORE DRILL

484

用途

●先將待打孔部位加入充分的水，把物件物牢靠固定後進行作業。

■Use : For holing work on ceramic tile and brick block. Used by the electric acting power tool, and worked on the fixed article tightly with cooling water supply.

規格表 STANDARD TABLE

ITEM No.	DCD 0300	DCD 0400	DCD 0500	DCD 0600	DCD 0800	DCD 1000
A mm	φ3	φ4	φ5	φ6	φ8	φ10
B mm	10	21	30	35	35	35
C mm	30	26	35	30	30	30
kg-1p	0.011	0.011	0.014	0.014	0.016	0.017

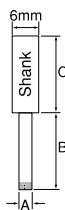

ITEM No.	DCD 1200	DCD 1500	DCD 1600	DCD 1800	DCD 2000	DCD 2200	DCD 2500	DCD 2600	DCD 2800	DCD 3000	DCD 3200	DCD 3500	DCD 3800	DCD 4000
A mm	φ12	φ15	φ16	φ18	φ20	φ22	φ25	φ26	φ28	φ30	φ32	φ35	φ38	φ40
kg-1p	0.027	0.033	0.034	0.040	0.044	0.046	0.054	0.060	0.060	0.061	0.075	0.075	0.083	0.085

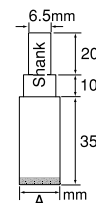

使用例

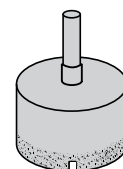

電鍍金剛石粒
Plated Diamond Grid
±3.5mm
粒度#120
Grid No.120



馬蹄銼

HORSERASPS

木材加工銼 MILL SAW FILES 210



用途
 ●帶棱角的小刃面能夠修整大型木材，加工鋸的齒刃，平面則能銼削和修整刃狀刃面。

Use : Principally for FILING MILL, CIRCULAR SAW, PLANER KNIVES.



規格表 STANDARD TABLE

INCH	mm	扁一端圓 1 Round Edge				三角 Triangular				扁兩端圓 2 Round Edge		扁兩端方 Square Sides	
		W × T mm	kg-doz	BOX pcs	ITEM NO.	W mm	kg-doz	BOX pcs	ITEM NO.	W × T mm	kg-doz	W × T mm	kg-doz
6	150	16 × 3	0.58	12	HI 15020	8.5	0.45	12	SA 15020	16 × 3	0.57	16 × 3	0.60
8	200	21 × 3.5	1.17	12	HI 20020	12	1.20	12	SA 20020	21 × 3.5	1.14	21 × 3.5	1.20
10	250	25 × 4	2.15	12	HI 25020	15	2.34	12	SA 25020	25 × 4	2.10	25 × 4	2.20
12	300	28 × 5	3.40	12	HI 30020	18	4.04	12	SA 30020	28 × 5	3.30	28 × 5	3.50

鏈鋸銼 ROUND CHAIN SAW FILES 208



規格表 STANDARD TABLE

mm	mm INCH	kg-doz	BOX pcs	ITEM NO.
200	φ 3.2 (8/64)	0.15	12	MA 03228
200	φ 3.5 (9/64)	0.21	12	MA 03528
200	φ 3.8	0.24	12	MA 03828
200	φ 4.0 (10/64)	0.26	12	MA 04028
200	φ 4.5 (11/64)	0.33	12	MA 04528
200	φ 4.7 (12/64)	0.35	12	MA 04728
200	φ 5.0 (13/64)	0.39	12	MA 05028
200	φ 5.5 (14/64)	0.48	12	MA 05528
200	φ 6.0 (15/64)	0.59	12	MA 06028
200	φ 6.3 (16/64)	0.63	12	MA 06328
200	φ 7.0 (18/64)	0.70	12	MA 07028
200	φ 8.0 (20/64)	0.97	12	MA 08028

用途
 ●鏈鋸的鋸齒修整。

Use : For sharpening the blade of CHAIN SAW MACHINE.

菱形銼 FEATHER EDGE SAW FILES 200



規格表 STANDARD TABLE

INCH	mm	W × T mm	kg-doz	BOX pcs	ITEM NO.
3	75	17 × 2.3	0.21	12	RH 075 * *
4	100	20 × 3.0	0.38	12	RH 100 * *
5	125	25 × 3.5	0.63	12	RH 125 * *
6	150	28 × 4.0	0.98	12	RH 150 * *
7	175	28 × 4.0	1.13	12	RH 175 * *
8	200	28 × 4.0	1.27	12	RH 200 * *

ITEM No. * * assorted

	中齒 Second	細齒 Smooth	油光 Dead Smooth	精密 Precision
* *	22	23	24	25

用途
 ●鋸齒的修整。

Use : For sharpening HAND SAW.

刃銼 FEATHER EDGE SAW FILES : FINISHING (Japanese Market) 201



規格表 STANDARD TABLE

mm	W × T mm	名稱	ITEM NO.
55	11 × 1.2	小挽切	RH 05526
60	13 × 1.5	中挽切	RH 06026
65	15 × 1.8	大挽切	RH 06526
70	20 × 3	相中	RH 07026
50	9 × 1.3	毛志	RH 05026

用途
 ●修整鋸刃的齒部。

Use : For finishing to sharpen HAND SAW.

窄形三角銼

SLIM FILES

220



■用途

●修整鋸齒部。(主要用於出口)

■Use : For sharpening HAND SAW.

規格表 STANDARD TABLE



INCH	mm	HEAVY		REGULAR		SLIM		X SLIM		XX SLIM		DOUBLE ENDER	
		△ W mm	⚖ kg-doz	△ W mm	⚖ kg-doz	△ W mm	⚖ kg-doz	△ W mm	⚖ kg-doz	△ W mm	⚖ kg-doz	△ W mm	⚖ kg-doz
3	75	7.0	0.20	5.5	0.15	3.9	0.07	—	—	—	—	—	—
3 1/2	88	8.6	0.33	7.0	0.24	4.7	0.11	—	—	—	—	—	—
4	100	9.4	0.35	8.6	0.31	5.5	0.18	4.7	0.11	3.9	0.08	—	—
4 1/2	113	10.9	0.55	9.4	0.45	6.3	0.23	5.5	0.16	4.3	0.10	—	—
5	125	11.7	0.85	10.2	0.61	7.0	0.31	5.5	0.19	4.7	0.13	—	—
5 1/2	138	13.3	1.13	10.9	0.78	7.8	0.39	6.3	0.25	5.5	0.19	—	—
6	150	13.3	1.24	11.8	0.98	8.6	0.51	7.0	0.34	5.5	0.21	4.7	0.15
7	170	14.8	1.64	13.3	1.26	10.2	0.94	8.6	0.61	6.3	0.33	5.5	0.25
8	200	16.4	2.35	14.8	1.85	11.7	1.28	10.2	0.94	7.8	0.55	7.0	0.44
9	225	18.0	2.80	16.4	2.60	13.3	1.70	—	—	—	—	8.6	0.68
10	250	20.3	4.50	18.0	3.00	14.8	2.34	—	—	—	—	9.4	0.95

農鏟銼

FARMER'S FILES

211

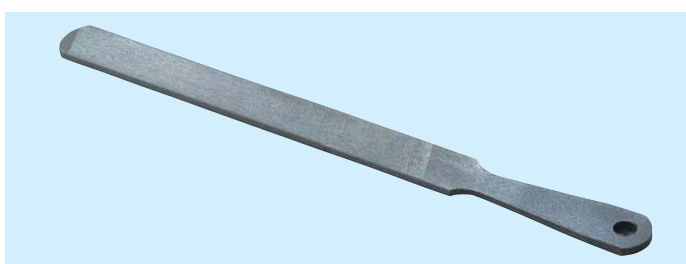

■特長

●能有效除去植物的樹脂，提高鋒利度。

■用途

●用於鏟刀，鎬等工具刃面的再生。

■Use : With a hand carry, farmers put aside plant-fat and furthermore sharpen knives well.
For sharpening SICKLE, PLANER KNIVES.

規格表 STANDARD TABLE



INCH	mm	W×T mm	mm	kg-doz	BOX pcs	ITEM NO.
6	150	20 × 3.5	85	1.33	12	HI 15021
8	200	25 × 4.0	90	2.15	12	HI 20021
10	250	28 × 5.0	100	4.50	12	HI 25021

銼刀八題 ③

荊山 信行

傳世之品的錯(やすり)在奈良・正倉院保存有五把。南倉的工匠的三把和北倉的十合鞘禦刀子二把。

參照『正倉院的金工』和『正倉院的刀劍』二本著作，工匠的錯傳說是當時工匠在進行木工細工或雕刻金屬時使用的東西。三把銼的長度包括木制的柄均為26厘米左右。銼身為5-10厘米，寬度為5-13厘米，厚度為1-4厘米。與現在的什錦銼中的扁銼較相似。

一號銼是本體有著緩和曲面的異形銼刀，適用於銼削凸部，銼的齒為單齒。二號銼是任意下垂即右邊的斜線連續的單齒，側面也有齒。三號銼更像銼刀，銼身長10厘米，銼刀兩面都有齒，一看便知是銼刀，側面刻有鋸齒狀的東西，推壓時能進行切削。

正倉院的鎮殿之寶

北倉的二把錯是與十合鞘禦刀子(刀子七把，矛一根，錯二把)放在一個鞘裏。這二把錯與工匠的三把不同，製作相當考究，有品位。

被稱為十合鞘七的錯全長16厘米，銼齒部分為10.5厘米。銼身與柄部相交的接頭處變細，呈八角形。有手工作業的跡象。銼刀的齒乍一看像鯊魚的皮一樣，凹凸不平的樣子，那其橫向卻呈規則性地排列。近似於現在的鬼齒銼(粗齒銼)。

另外一把十合鞘九銼僅長19厘米。其接頭細部為旋狀圓形。銼齒也與七銼相同為粗齒銼。

正倉院內銼刀的齒被認為是用鋼鑿(剃刀)剃的。它的頭部有卷邊，足以證明使用相當激烈。

(廣島縣立西部工業技術中心主任研究員=吳市)

綠地帶 3.9.30 摘自中國新聞

鋁板銼

CURVED TOOTH FILES

240

鋁板銼



特長

●與剝齒的齒紋不同，根據切削加工要求形成刃的銼刀。因銼距相當寬，適用於加工容易積屑的銅，鋁等輕金屬以及去除塗料膜，硬質橡膠，塑膠，木頭等。能獲取良好的加工面。

Use : File Teeth shaped with a milling machine has it's wide interval, so that it's not so much clogged.

By this reason it's useful for Copper, Aluminum, Babbitt, Brass, Hard Rubber, Plastics, Wood, etc, with a file finishing.

規格表 STANDARD TABLE

INCH		mm		扁 HAND			半圓 HALF ROUND		
W × T mm		kg-doz	BOX PCS	ITEM NO.	W × T mm		kg-doz	BOX PCS	ITEM NO.
6	150	16 × 4	0.76	6	16 × 4.5	0.68	6	6	HA 150**
8	200	21 × 4.5	1.44	6	21 × 6	1.34	6	6	HA 200**
10	250	25 × 6	2.76	6	25 × 7	2.20	6	6	HA 250**
12	300	30 × 7	4.70	6	30 × 8.5	4.30	6	6	HA 300**
14	350	34 × 7.5	6.55	6	34 × 10	7.30	6	6	HA 350**

齒紋粗度表 CUTTING NO.

Size mm	粗齒 Bastard		中齒 Second	
	cuts/cm	cuts/inch	cuts/cm	cuts/inch
150	5	13	6	15
200	5	12	6	15
250	4	10	5	13
300	4	10	5	12
350	3.5	9	5	12
ITEM No.**	61		62	

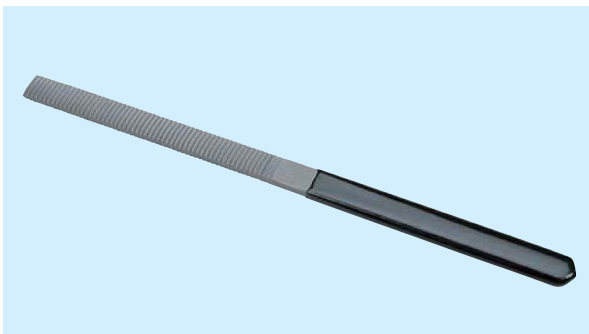

規格表 STANDARD TABLE

L mm	W × T mm	kg-25 pcs	BOX PCS	ITEM NO.	
215L	105 ℓ	11 × 3.5	1.48	25	HI 005**

齒紋粗度表 CUTTING NO. TABLE

CUTTING No	粗齒 Bastard	中齒 Second	細齒 Smooth	油光 Dead Smooth
	cuts/cm	6	7	9
cuts/inch	15	18	23	40
ITEM No.**	61	62	63	64

木雕銼

WOODCRAFT FILES

245



特長

●在鋁板銼上加工排屑槽。這樣切屑便能順利排出並能得到良好的加工面。
●主要針對木材加工。也適用於銅，鋁等輕金屬及硬質橡膠，塑膠等。

Use : For WOOD works ,and also for Copper,Aluminum,soft metals, Hard-rubber and Plastics, etc.
By the function of chip-breakers on the milled tooth files surfaces.

規格表 STANDARD TABLE

L mm	W × T mm	kg-5 pcs	BOX PCS	ITEM NO.	
200L	100 ℓ	16 × 4	0.47	5	HI 10072

軟材料加工銼 SOFT WORK FILES 242

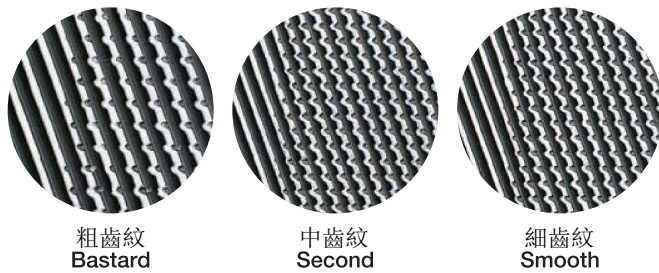

粗齒紋
Bastard

中齒紋
Second

細齒紋
Smooth

■用途

●適用於塑膠，石膏板，硬質橡膠等軟質材料的加工。
銼身附排屑槽。

■Use : For Prastics, Plaster Board, Hard Rubber, etc.
with the function of chip-brakers.



規格表 STANDARD TABLE

INCH	mm	扁 HAND				半圓 HALF ROUND (SHELL TYPE)			
		W × T mm	kg-doz	BOX pcs	ITEM NO.	W × T mm	kg-doz	BOX pcs	ITEM NO.
6	150	—	—	—	—	—	—	—	—
8	200	19 × 6.0	1.63	6	HI 200 * *	18 × 7.0	1.25	6	HA 200 * *
10	250	25 × 6.5	2.40	6	HI 250 * *	23 × 8.0	1.91	6	HA 250 * *
12	300	30 × 7.5	4.43	6	HI 300 * *	26 × 8.0	2.10	6	HA 300 * *

ITEM No. * * assorted

	粗齒 Bastard	中齒 Second	細齒 Smooth
* *	71	72	73

〈ITEM No.例〉軟材料加工銼半圓250mm中齒：HA25072

〈ITEM No.ex〉SOFT WORK FILES HALF ROUND 250mm Second：HA25072

銼刀八題 ④ 荊山 信行

在江戶時代中期的圖鑒百科辭典『和漢三才圖會』裏記載了四把銼刀。除雁岐鑿，雙手鑿之外，另外二把名稱不詳。

說明裏以「四聲字苑雲...」開始，到「雁岐鑿」結束。

竹島淳夫的注釋如下。根據「四聲字苑」，鑿是修整鋸齒並讓鋸齒鋒利的工具。是銼切銅和鐵的東西。鑿不混雜鐵，用純鋼製成。形狀似折疊的扇子，表面和內側剝上細齒紋，用來切割鐵器。有大小多種種類，修整鋸齒並使其銳利的鑿齒呈三棱形。此外磨獸角的東西齒距大，把這個叫做雁岐鑿（平凡社·和漢三才圖會·五）。

「鑿的材料裏不混雜生鐵」中的「生鐵」不太清楚。把生鐵讀作「しょうてつ」的話就是非常脆的銳鐵（鑄鐵的原材料）。讀作「なまてつ」的話，就成為很軟且淬不進火的鋼，混雜進銼鐵後不能進行鍛造。所以，這裏絕不是「しょうてつ」，而是「なまてつ」的東西。

說明文裏的意思是鑿只能使用淬火後變硬的鋼，淬不進火的混

和漢三才圖會

雜進銼鐵的生鐵不能用於鑿材料。

修整大鋸齒並使其鋒利的銼刀有三個棱，即三角銼。但是仔細觀察圖（沒有名稱的鑿），與現在的刃銼接近。刃銼主要用於鋸齒的修整。其斷面呈菱形，具有四個棱。修整大鋸齒的銼刀究竟是三角銼還是刃銼，業界有不同的看法。

此外在德國，修整鋸齒用的銼刀使用了三個棱的「三角鋸鑿」。

研磨獸角的銼刀呈直線狀，使用齒粗的雁岐鑿。雁岐表示石段的重疊狀態，大約是指大鋸（粗銼）吧。

（廣島縣立西部工業技術中心主任研究員=吳市）

綠地帶 3.10.1 摘自中國新聞

可曲銼刀

CURVED TOOTH BLADES

255

鋁板銼



特長

●安裝在支架（910）上使用。逐漸收緊金屬制的支架，使可曲銼刀呈弧狀彎曲。僅修補研磨平面上的鏽斑以及去除被切削物上的塗料時使用。

Use

It can be used with a Holder (910) attached To.
A Slightly bending status is available for the damaged points of the object to file down stains or paints.

規格表 STANDARD TABLE

INCH		mm		W × T mm	kg-doz	BOX	ITEM NO.
						pcs	
12	300	30	4.5	2.5	6	6	FX 300**
14	350	34	4.8	3.6	6	6	FX 350**

齒紋粗度表 CUTTING No. TABLE

		粗齒	中齒	細齒	油光
		Bastard	Second	Smooth	Dead Smooth
CUTTING No	cuts/cm	3.5	5	6	7
	cuts/inch	9	13	15	18
ITEM No. **		61	62	63	64

金屬制支架
METAL



木制支架
WOOD



支架 HOLDER

DIMENSION		全長		ITEM NO.
		TOTAL LENGTH		
TYPE		mm	kg-1p	
金屬制	METAL	300	0.77	HO 300M
		350	0.85	HO 350M
木制	WOOD	350	0.22	HO 350W

910



刀鞘内側精加工使用。
SCABBARD RASPS



粗齒紋銼 (木工類型)

FILE RASPS

270

粗齒 RASPS CUT



精加工銼齒 TRIPLE FILE CUT



特長

● 一面是粗齒 (粗切削), 反面則是精加工銼齒。

用途

● 用於木或軟金屬。

Use : For wood or soft metals.

Rasps Cut on one side, and Triple File Cut on another.

規格表 STANDARD TABLE

INCH	mm	扁 HAND				半圓 HALF ROUND				圓 ROUND			
		W × T mm	kg-doz	BOX pcs	ITEM No.	W × T mm	kg-doz	BOX pcs	ITEM No.	W mm	kg-doz	BOX pcs	ITEM No.
6	150	16 × 4	0.82	6	HI 15040	16 × 4.5	0.74	6	HA 15040	φ 6	0.46	6	MA 15090
8	200	21 × 5	1.72	6	HI 20040	21 × 6	1.82	6	HA 20040	φ 8	1.00	6	MA 20090
10	250	25 × 6	3.22	6	HI 25040	25 × 7	3.00	6	HA 25040	φ 10	1.88	6	MA 25090
12	300	30 × 7	5.50	6	HI 30040	30 × 8.5	5.26	6	HA 30040	φ 12	3.32	6	MA 30090
14	350	34 × 7.5	8.00	6	HI 35040	34 × 10	8.12	6	HA 35040	φ 15	5.62	6	MA 35090
16	400	36 × 8.5	11.24	6	HI 40040	36 × 11	10.48	6	HA 40040	φ 18	9.60	6	MA 40090

齒紋粗度表 CUTTING No. TABLE

	150 mm	200 mm	250 mm	300 mm	350 mm
粗齒 Raspers Cut cuts/cin	20	16	10	7	5

粗齒紋銼 (鉛工類型)

RASPS

276

扁 HAND



半圓 HALF ROUND



圓 ROUND

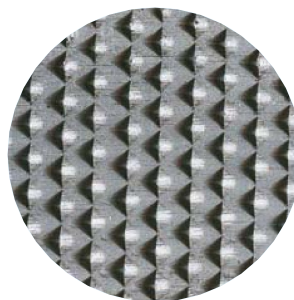

粗齒 (兩面)
Raspers Cut (Both sides)

特長

● 兩面均為粗齒 (粗加工)。

用途

● 用於軟金屬。

Characteristic : Rasps Cut on both sides.

Use : For soft metals.

規格表 STANDARD TABLE

INCH	mm	扁 HAND				半圓 HALF ROUND				圓 ROUND			
		W × T mm	kg-doz	BOX pcs	ITEM No.	W × T mm	kg-doz	BOX pcs	ITEM No.	W mm	kg-doz	BOX pcs	ITEM No.
6	150	16 × 4	0.82	6	HI 15030	16 × 4.5	0.74	6	HA 15030	φ 6	0.46	6	MA 15090
8	200	21 × 5	1.72	6	HI 20030	21 × 6	1.82	6	HA 20030	φ 8	1.00	6	MA 20090
10	250	25 × 6	3.22	6	HI 25030	25 × 7	3.00	6	HA 25030	φ 10	1.88	6	MA 25090
12	300	30 × 7	5.50	6	HI 30030	30 × 8.5	5.26	6	HA 30030	φ 12	3.32	6	MA 30090
14	350	34 × 7.5	8.00	6	HI 35030	34 × 10	8.12	6	HA 35030	φ 15	5.62	6	MA 35090
16	400	36 × 8.5	11.24	6	HI 40030	36 × 11	10.48	6	HA 40030	φ 18	9.60	6	MA 40090

馬蹄銼

BOARD RASPS

280

粗齒 RASPS CUT



精加工齒 FILE CUT



用途

●石膏板的粗加工用，及馬蹄的修整。

■Use : For Plaster Board.

規格表 STANDARD TABLE

INCH	mm	W × T mm	BOX pcs	kg-doz	ITEM No.
12	300	32 × 6	6	5.5	BD 30000
14	350	36 × 6	6	7.1	BD 35000
14	WIDE350	42 × 5	6	6.9	BD 35100

鉛木工銼

CABINET FILES

272

扁 HAND



半圓 HAIF ROUND



圓 ROUND

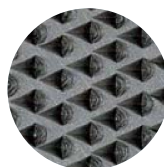

粗齒 Rasp Cut



精加工齒 File Cut

特長

●扁銼是木工類型（單面是精加工齒），半圓是鉛工銼（兩面均為粗齒），圓銼是粗齒。

用途

●既可作為木工教材，又可作為攜帶方便的野外工具使用。

■Use : For it's education as one of wood-working tools.

“Hand” File has file cut/Rasp cut.

“Half Round” File has Rasp cut in front and back side.

“Round” File has Rasp cut.

規格表 STANDARD TABLE

	扁 HAND	半圓 HALF ROUND	圓 ROUND
mm	W × T mm	W × T mm	W mm
220	15.5 × 3.8	19.5 × 3.5	φ6
kg-doz	1.3	1.3	0.6
ITEM No.	HI 22040	HA 22040	MA 22040

鞋銼

SHOE RASPS

279

表面 FRONT SIDE



背面 BACK SIDE



用途

●主要用於鞋類修理加工。

●木，軟木，橡膠等也可使用。

■Use : By shoe-makers and shoe-repairers.

規格表 STANDARD TABLE

INCH	mm	W × T mm	CARTON pcs	kg-doz	ITEM No.
8	200	22.5 × 5	300	1.87	KU 20040
9	225	22.5 × 5	300	2.55	KU 22540
10	250	25.0 × 5.5	300	3.51	KU 25040



銼刀八題 ⑤

刘山 信行

銼刀的歷史，根據希臘文獻記載「BC2000年希臘的克立特文明發明了青銅銼刀」。這應該是最早的記載。接著BC1300年古埃及發明了銅制的粗齒銼。BC700年又製作了鐵制的銼刀。隨著時代的推移，羅馬人於AD1100年製作了經過鐵浸碳處理的銼刀。

所謂浸碳處理，即為使銼刀的刃部堅硬，把碳素滲透其中。在冶金技術發達的中國，據說早在BC200年就盛行浸碳處理技術了。

那麼，本地的仁方銼刀的歷史又是如何呢。根據『仁方鄉土志』等記載，「文政年間或者天保年間鐵匠從大阪引進了製作法」。「文政七年，金穀彌助或嘉平次被盛傳在大阪立賣堀修業完成」。「大阪的銼刀屋師傅壺井豐次郎招了弟子，學習淬火劑的配方技術」等等，眾說紛雲。無論怎麼說，大阪是仁方銼的發祥地。

四千年的歷史

在大阪調查了仁方銼刀的身世。文政三年和七年的『商人購物獨家指南』中收錄了鑄鍛造工匠山口屋加兵衛的名字，但沒有收錄當時評價很高的銼刀工匠壺井豐次郎的名字。另外據『大阪商工名家集』（弘化三年）記載，除上述的山口屋和銼刀工匠高橋長兵衛，銼刀工匠惣兵衛的名字被收錄外，壺井的名字同樣也沒有被記載。究竟是壺井氏原本就不存在呢，還是忘記收錄，至今不得而知。

銼刀企業名字裏「壺○○鈔製作所」之類的企業往往帶有壺字。一種說法是採用了上述工匠壺井中的壺字，也有認為是用淬火劑用的豆瓣醬保存用的壺來命名的。

（廣島縣立西部工業技術中心主任研究員=吳市）

綠地帶 3.10.2摘自中國新聞

邊緣修整器

EDGE TRIMMER

257

在ET20上附一片ETB21刀片。
A ETB21 is attached to a ET20.



粗齒
ETB21精齒
ETB22萬能齒
ETB23



■用途

●用於木，石膏板，塑膠，金屬的稜邊的加工。

■Use : For finishing the board-edges of Wood, Plastics, Plaster Board, Metals etc.

規格表 STANDARD TABLE

			ITEM No.
mm	A×B mm	kg-1p	
114	53 × 51	0.18	ET 20

DIMEN- SION					ITEM No.
	mm	W×T mm			
TYPE					
粗齒Bastard	100	30 × 4.5	10	0.8	ETB 21
精齒Smooth				0.8	ETB 22
萬能齒All-around				1.15	ETB 23

1 ETB21 (粗齒) · ETB22 (精齒)

● 側面切削時

請按〈圖1〉所示的標準形態使用。
For finishing "Side Face", it's used like 〈fig.1〉.

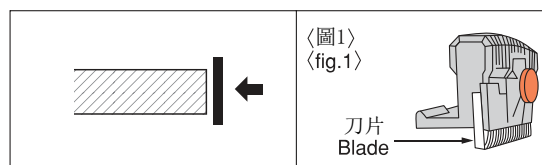

● 45° 面切削時

請按〈圖2〉所示，將刀片鑲嵌在內側使用。安裝方法是：將刀片固定到B的槽之後，往A的方向推壓。取出時，請使用硬幣插入旋轉後取出。

For facing the angle 45°, it's used like 〈fig.2〉. At first the blade is fixed on B, and pushed in A by hand. Then in order to care your hand, please take gloves on hand. When the blade is taken off, please insert and twist a coin, like 〈fig.2〉.

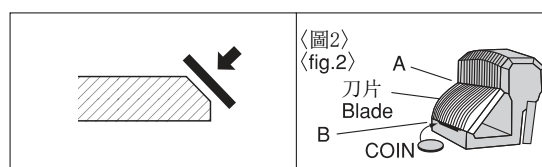

2 ETB23 (萬能齒類型，用螺絲釘擰緊)

● 切削上面時

按〈圖3〉所示，在中央處擰緊螺絲。
擰緊ETB23時使用。

For finishing "Front Face", ETB23 is used like 〈fig.3〉.

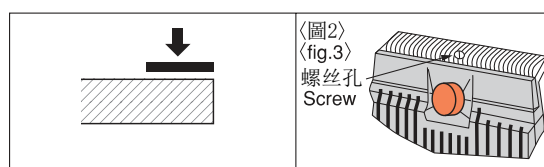

3 ETB21 · ETB22 · ETB23

● 兩片刀片相對90° 角加工時

把圖1和圖3結合起來使用。兩片刀片呈90° 角使用。〈圖4〉

For facing the angle 90°, it's used like 〈fig.4〉 assorting 〈fig.1〉 with 〈fig.3〉.

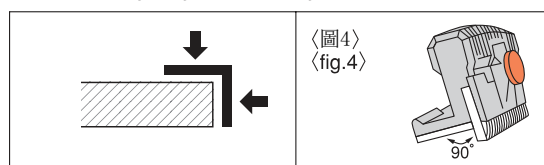

螺紋休整銼 SCREW THREADS FILES 800

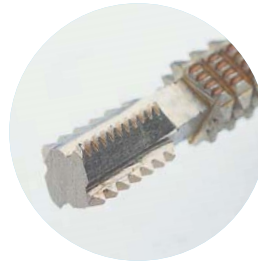

■用途

- 修整損壞的螺紋。
- 每一根螺紋休整銼有8種規格螺紋。

■Use : Precision hand tool for restoring all screw threads- male and female.

規格表 STANDARD TABLE

mm	mm		kg-lp	ITEM No.	
	A	B		RED	BLUE
230	20A	75B	0.13	SCW 010	SCW 020

TYPE		CASE COLOR	螺紋距離 PITCH								
公制用	INTERNATIONAL	紅 RED	0.75	1.00	1.25	1.50	1.75	2.00	2.50	3.00	mm
英制用	WHITHWORTH	藍 BLUE	10	11	12	14	16	18	20	24	F

修整銼

超薄平銼

VERY THIN HAND DITCH FILES

350



規格表 STANDARD TABLE

規格表		平 HAND	BOX		ITEM No.
190L	90ℓ	10 × 0.5	25	kg- 25pcs	GHI 1902
mm		W × T mm	pcs		

■用途

- 因為厚度僅為0.5mm，可加工修整窄縫。

■Use : For repair to modify "flute" like comb by only 0.5mm thickness of file.

吉他銼

GUITAR FILES

380

3PCS-SET

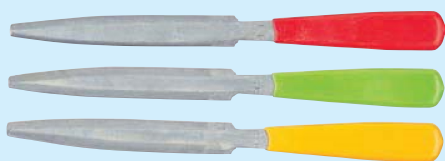

規格表 STANDARD TABLE

TYPE	規格表		BOX		ITEM No.
3PCS-SET	190L	90ℓ	3 (each1)	0.16 (1set)	GTST 190
2R			10	0.85 (10pcs)	GT2R 190
	mm		pcs	kg	

■用途

- 修整吉他等絃樂器槽板上定音的枕弦。
- 木管，金管樂器等的制作和修整。

■Use : For repair of stringed music instrument (guitar etc.)

去飛邊刀

TRIMMING KNIFE

397

右手用 RIGHT-HANDED



左手用 LEFT-HANDED



規格表 STANDARD TABLE

TYPE	規格表		BOX		ITEM No.
右手用 RIGHT-HAND	162L	37ℓ	5	0.13	BTK 162R
左手用 LEFT-HAND					BTK 162L
	mm		pcs	kg- 5pcs	

■用途

- 去除塑膠或金屬的飛邊。
- 有右手和左手用兩種。

■Use : For the Trimming work of Plastic or soft Metals.

銼刀八題 ⑥ 荊山 信行

仁方，以前又被稱為新瀉。想不到新瀉也是銼刀的產地。仁方銼始於大阪製造法的引進。

傳說「仁方不是銼刀工業發展的理想地域」。據說文政二年，當時的工匠包括木工，鍛工，桶屋，木挽，鉗屋等僅有8人。

仁方的確不是得天獨厚，但是，在技術方面似乎得到真傳。進入明治年後，仁方村的阪本幸兵衛特地為在東京舉辦的第二屆內國勸業博覽會（明治十四年）製作了三把「黑燒橫目鑢（銼）。所謂黑燒橫目鑢即單齒，淬火後不經任何處理的黑色銼刀。

因此，仁方銼刀技術遵循明治十八年的『農商工申合規約』的行業規範，經過大量實踐，得到了很大的發展。在那個規約中，強調了要「勤奮和節儉」，「杜絕粗製濫造」，「改良製品使之成為流行品」等嚴格的行業規範。

仁方與新瀉

據說「古時候把鑢稱作越後（新瀉）鑢」，燕市的銼比仁方的銼有名。

又據說歷史悠久，流傳元祿年間的鋸鐵件的材料是使用出雲的玉鋼。因此鋸齒修整用的銼刀製作法便應運而生。當時燕製造了和釘。據說這是和釘工匠們繼承和發展了銼刀技術的結果。到明治四十四年，燕銼的產量達到三百萬支，占日本全國的80%，成為日本最大的銼刀生產地。而當時仁方的銼刀產量還不足四十四萬支。但是，隨著大正六年的戰事頻發，社會不穩定。燕銼也陷入了粗製濫造的混亂局面，燕銼頻出弊端，使其名譽掃地。

據說昭和十年，燕銼和仁方銼打起了「兩刃銼訴訟」，最後燕銼勝訴。但在吳地載和新瀉地載的記錄裏都沒有關於兩刃銼訴訟的記載。（廣島縣立西部工業技術中心主任研究員=吳市）

綠地帶 3.10.3摘自中國新聞

牙刷柄油石

HAND LAPPER

850



■ C粒度 結合度N

■ 用途

- 鑽頭，刨刀，銑刀，菜刀，剪刀等淬火鋼的研磨及刃部修整。
- 超硬金屬工具，玻璃，陶瓷等的修整。

■ Use : Modifying the edge of Twist-drill, Cutter, Knife, Scissors, Glass, Hard Metals, etc.

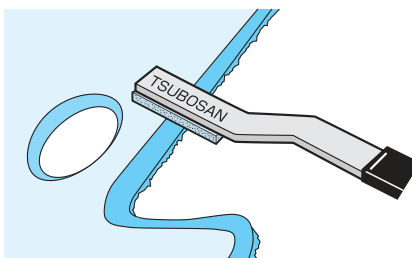

● 去除塑膠成型或鑄件的毛邊。

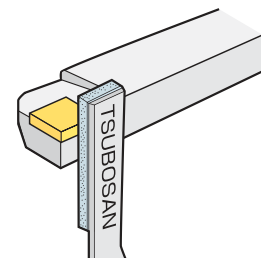

● 鑽頭，刨刀等再研磨後的修整。

規格表 STANDARD TABLE

DIMENSION	DIMENSION		扁 HAND	半圓 HALF ROUND	三角 TRIANGULAR	BOX	
	mm	mm	W×T mm	W×T mm	W mm	pcs	kg-10pcs
	175L	45L	12×5	12×4.6	12	10	0.4
ITEM No.			HIL ****	HAL ****	SAL ****		

HANDLE COLOR	粗 ← 中 ← 細 ← 油						
	藍 BLUE	紅 RED	綠 GREEN	黃 YELLOW	黑 BLACK	紫 NAVY BLUE	深綠 DARK GREEN
粒度 GRID No.	#180	#240	#320	#400	#600	#800	#1000
ITEM No.***assorted	0180	0240	0320	0400	0600	0800	1000

< ITEM No. 例 > 半圓牙刷柄油石 #320 : HAL0320

< ITEM No. ex > HALF ROUND HAND LAPPER #320 : HAL0320



銼刀八題 ⑦ 荊山 信行

根據書中記載，「銼刀材料是購自出雲松江，伯耆的玉鋼」，「使用了用安來的砂鐵生產的安來鋼」，而玉鋼和安來鋼同樣是用「たたら製鐵」製造的。

たたら製鐵是把砂鐵作為原料把木炭作為燃料製造的鐵。製成的鐵塊稱為鑄，其中央部能製成品質優良的玉鋼。

這個玉鋼也分等級。根據『鑪和鍛冶』記載，特優稱為天，上品稱為寸，次上品稱為可，普通級則稱為や。

特優品多用於日本刀，上品使用於銼刀或者菜刀的刃部，次上品使用於柴刀或鐮刀，普通級則多被海軍工廠使用。可見，銼刀是使用了高級的玉鋼。

這種玉鋼從產地用馬或用船集中運輸到廣島的批發店，再向內海的各地供應。仁方銼刀的流通方式亦是如此。

安來的玉鋼

「玉鋼經過鍛造，鍛打成寬度約15厘米左右的銼刀材料。用這種玉鋼製成的銼刀，評價一般。究其原因玉鋼的成分參差不一。像銼刀那樣，使用面大，但均質加工非常困難。只有充分熟悉玉鋼的性能，運用卓越的技術含量並有效駕馭它的人才能製作出優質的銼刀。」

「到明治二十年代，誕生了取代玉鋼的金屬材料『Stahl』」，但這種Stahl材料的實體不太清楚。

經過調查後得知，Stahl是德國的「Stahl」鋼，是把鐵鋼石作為原材料用溶礦爐製成的鋼。用這種材料製造的銼刀取得了好評。（廣島縣立西部工業技術中心主任研究員=吳市）

綠地帶 3.10.5摘自中國新聞

修整銼

硬度測定銼 HARDNESS TESTER (HRC40~HRC65) 860



● 攜帶方便的工具箱 (6支一套) (6pcs/set)

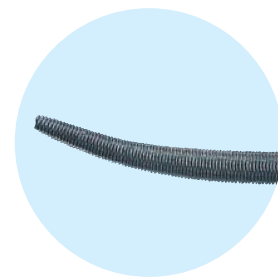

測定

Material : SKS-8 (JIS)



用途

- 能輕鬆測定硬度HRC40~65的測定工具。
- 可以放入口袋，能使用在大型工作物或室外特殊鋼材等不能置放實驗機の場合。
- 擁有這套檢驗工具，便能檢驗切削加工前的被切削材料的硬度和檢驗熱處理後的硬度情況。

特長

- 六支裝的套裝，硬度根據顏色區分。
- 把手部分防滑，操作方便。
- 能除去被檢驗材料的鏽斑。用測試工具測試時，若物件留下傷痕，責表示其硬度不夠。
- 若沒有傷痕，則用偏高一級的測試工具檢驗。因為測試工具的端部是彎曲加工的，所以可以檢驗平面，曲面，和內徑面的硬度。

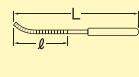
規格表 STANDARD TABLE

			ITEM No.
mm	mm	kg-1set	
175L	65L	φ 4.3	0.23
			MA 00600

顏色 COLOR	表示 INDICATION	測定銼的硬度表 FILE-HARDNESS	
赤 RED	HRC 40	HRC 40~42	HV 392~412
黃 YELLOW	HRC 45	HRC 45~47	HV 446~471
黃綠 LIGHT-GREEN	HRC 50	HRC 50~52	HV 513~544
綠 GREEN	HRC 55	HRC 55~57	HV 595~633
青 BLUE	HRC 60	HRC 60~62	HV 697~746
黑 BLACK	HRC 65	HRC 65~67	HV 800~865

- ※ 每個表示的硬度值允許存在HRC2的誤差。
- ※ Each indicated No .has the allowance at the rate of HRC2 highiy

Use : This new innovative file set provides a quick, inexpensive and simple way to check material hardness. No need to bring the material to be tested over to a hardness testing machine : Just bring this file set (6 files from 40 to 65 HRC) to the piece to be tested. Follow these simple steps to test your material :

1. Start with the BLACK handle file (65 HRC) and run the file over the test material. If it marks the material, the material is less than 65 HRC.
2. Try the BLUE handle file (60 HRC) : If it does not mark the material, the file is softer than the material. In this case the material is between 60 and 65 HRC.
3. If the BLUE handle file (60 HRC) did mark the material, simply try the GREEN file (55 HRC) , the LIGHT-GREEN handle file (50 HRC) , and continue until the material is not marked. The approximate hardness of the material is between the file that marks the material and the file that slips over the material.

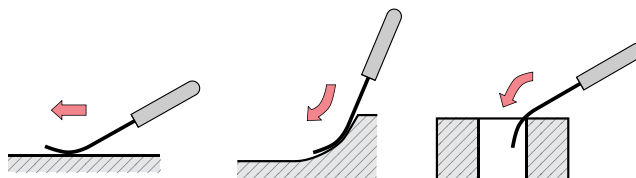

旋轉銼

ROTARY FILES

720

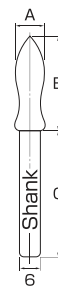

ITEM No.	RF 001	RF 002	RF 003	RF 004	RF 005	RF 006	RF 007	RF 008	RF 009	RF 010	RF 011	RF 012	RF 013	RF 014
A mm	φ7	φ7	φ7	φ7	φ7	φ7	φ4	φ7	φ11	φ13	φ13	φ13	φ13	φ13
B mm	28	28	28	18	28	13	4	7	11	13	18	18	30	30
C mm	40	40	40	50	40	55	64	61	57	55	50	50	40	40



ITEM No.	RF 015	RF 016	RF 017	RF 018
A mm	φ13	φ13	φ13	φ13
B mm	30	30	30	30
C mm	40	40	40	40



ITEM No.	CU 051	CU 053	CU 059	CU 075	CU 076	CU 077	CU 078	CU 101	CU 104	CU 105
A mm	φ6	φ6	φ10	φ10	φ10	φ10	φ10	φ6	φ6	φ6
B mm	20	20	10	25	25	25	25	10	10	6
C mm	40	40	50	35	35	35	35	Shank φ3 × 30		

■特長

- 是普通的銼刀。但適應作業困難的場所和形狀的研削作業。特別是TIN鍍層，不容易粘切屑。能廣泛使用于高硬度材料和鋁等材料。這裏僅舉一例，其他還能根據客戶要求定制，製作不同的齒的粗度和齒的形狀。

■Material : Carbonized Steel. (RF001~RF018)
H. S. S. & TIN. (CU051~CU105)

■Use : These Rotary files are fitted up with an electric powered tool and used in revolution. Any other shape and teeth can be made at your request.

金剛石磨棒

DIAMOND - BIT

481

30PCS.SET (30 shapes)

#200

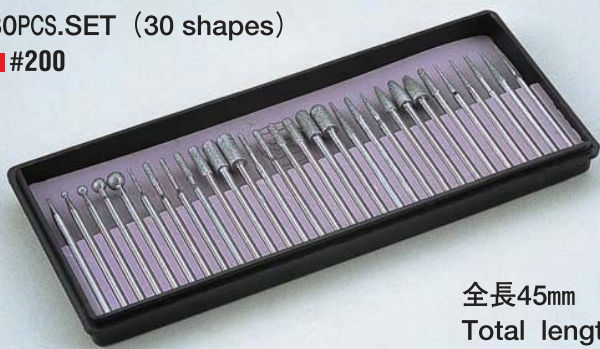

全長45mm
Total length

10PCS.SET (10 shapes)

#200



全長60mm
Total length

30PCS.SET(30 Shapes)

金剛石粒度 Grid No.	柄徑 Shank	套裝內容 Contents	kg-1 set	ITEM No.
#200	φ 2.35mm	DR0D11* DRY501*	0.13	DRST 13B
	φ 3.0 mm		0.15	DRST 13C

10PCS.SET(10 Shapes)

金剛石粒度 Grid No.	柄徑 Shank	套裝內容 Contents	kg-1 set	ITEM No.
#200	φ 6.0mm	DRT101F DRL801F	0.18	DRST 11F

■特長 (#200粒度)

●由於採用了鍍鉻技術，比以往的鍍鎳金剛石粒的保持力和剛性及耐高速旋轉性都有很大的提高。

■Use : This Diamond Grid are fixed by Cr-plating, that holding power is stronger than Ni-plating. So it's high holding endurance for high speed spinning!

柄徑 Shank	*
φ 2.35mm	B
φ 3.0mm	C

柄徑 Shank φ 2.35mm φ 3.0mm	ITEM No.														
	DR0D 11*	DR0D 21*	DR0D31*	DR0D41*	DR0D 51*	DRA 101*	DRA 151*	DRA 201*	DRA 251*	DRA 301*	DRA 401*	DRA 501*	DRA 151*	DRR 201*	DRA 251*
A mm	φ1	φ2	φ3	φ4	φ5	1	1.5	2	2.5	3	4	5	1.5	2	2.5
B mm						7	7	7	7	10	10	10	7	7	7
C mm	44	43	42	41	40	38	38	38	38	35	35	35	38	38	38

柄徑 Shank φ 2.35mm φ 3.0mm	ITEM No.														
	DRR 301*	DRR 401*	DRR 501*	DRR 311*	DRR 321*	DRC 201*	DRC 301*	DRC 401*	DRC 501*	DRL 321*	DR0T 71*	DRL 211*	DRT 101*	DR0T 31*	DRT 501*
A mm	3	4	5	3.3	3.3	2	3	4	5	3	2	3	2	2	5
B mm	7	10	10	15	10	10	10	10	10	10	10	17	14	11	2.3
C mm	38	35	35	30	35	35	35	35	35	35	35	28	31	34	35

柄徑 Shank φ 6.0mm	ITEM No.									
	DRT 101F	DRC 651F	DRL 841F	DRT 301F	DRK 101F	DRR 651F	DRA 801F	DRB 801F	DRD 801F	DRL 801F
A mm	6	6.5	8	7	10	10	8	10	10	8
B mm	25	22	15	15	1	15	15	5	10	15
C mm	35	38	45	45	59	45	45	55	50	45

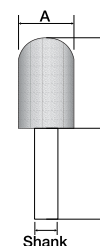

滲陶瓷機用銼

SUPER SAW (CERAMICS COATING FILES)

511



規格表 STANDARD TABLE

L mm		φA mm	套裝 SET	扁 HAND W × T mm	半圓 HALF ROUND W × T mm	圓 ROUND W mm	方 SQUARE W mm	三角 TRIANGULAR W mm	每箱數量 No./BOX
105L	φ5.0A	—	0.43	7.2 × 3.1	8.4 × 3.2	φ5.2	4.6	6.3	BOX 25 pcs
kg-	25pcs	0.43	0.45	0.39	0.43	0.40	0.40		
No./1set	5 (each 1)	5	5	5	5	5	5		
ITEM No.	ST 105C2	HI 105C2	HA 105C2	MA 105C2	KA 105C2	SA 105C2			

■裝在電動或氣動工具上使用。

■Use: By airforced or electric acting instruments.

鍍鈦機用銼

TIN SUPER HAND (Titanium Coated)

520



■行業內首次採用耐磨性，耐熱性卓越的高速鋼SKH-51，並覆蓋TIN鍍層。

■特長

●大幅提升使用壽命。

(使用電動、氣壓工具時能承受每分鐘3700衝程的切削速度。)

SKH-51種鋼

C	Cr	W	Mo	V
0.84%	4.03%	6.05%	5.10%	1.81%

■Material: SKH-51 (JIS) High Speed Steel

It's hardened under a vacuum environment, further more Tin (Titanium Nitride) is plated on the file-teeth.

■Use:

By the coating Tin, Both heat resisting and wear resistance grow up highly. It's superior to the high hardness, corrosion, Defacement, Clog.

It can endure the shaving speed at the rate of 3,700 strokes per min.

■電動・氣壓工具 BY AIR ACTING or ELECTRIC INSTRUMENTS

■手動 BY HAND 請使用手柄 (902)



規格表 STANDARD TABLE

L mm		φA mm	套裝 SET	扁 HAND W × T mm	半圓 HALF ROUND W × T mm	圓 ROUND W mm	方 SQUARE W mm	三角 TRIANGULAR W mm
150L	100ℓ	φ5.0A	—	7.0 × 2.5	8.2 × 2.8	φ5.0	5.5 × 3.2	6.0
kg-	5pcs	0.16	0.16	0.15	0.16	0.15	0.15	0.16
BOX	pcs	5 (each 1)	5	5	5	5	5	5
ITEM No.		ST 1550T	HI 1550T	HA 1550T	MA 1550T	KA 1550T	SA 1550T	

L mm		φA mm	套裝圓 R-SET	圓-3.0 ROUND-3.0 W mm	圓-3.5 ROUND-3.5 W mm	圓-4.0 ROUND-4.0 W mm	圓-4.5 ROUND-4.5 W mm	圓-5.0 ROUND-5.0 W mm
150L	75(100)ℓ	φ5.0A	—	φ3.0	φ3.5	φ4.0	φ4.5	φ5.0
kg-	5pcs	0.14	0.12	0.13	0.13	0.14	0.14	0.16
BOX	pcs	5 (each 1)	5	5	5	5	5	5
ITEM No.		ST 15MAT	MA 1530T	MA 1535T	MA 1540T	MA 1545T	MA 1550T	

■1套5支裝。

電動・氣動工具

機用銼

SUPER HAND FILES

381

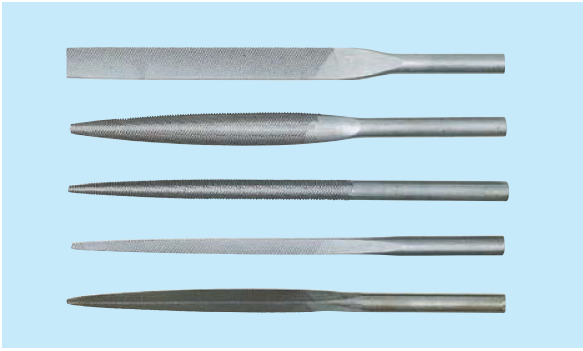

規格表 STANDARD TABLE

※使用銼刀鋼
(表面沒有特殊塗層)

		扁 HAND	半圓 HALF ROUND	圓 ROUND	方 SQUARE	三角 TRIANGULAR	每箱數量
mm		W × T mm	W × T mm	W mm	W mm	W mm	No./BOX
105L	φ 5.0A	7.0 × 3.0	8.0 × 3.2	5.0	4.0	6.5	BOX
kg-50pcs		0.90	0.78	0.86	0.80	0.80	pcs
ITEM No.		HI 10502	HA 10502	MA 10502	KA 10502	SA 10502	25

■用途

- 裝在電動或氣動工具上使用。
此外，若用其他銷售的塑膠手柄（902）也可使用。

■Use: By airforced or electric acting instruments.

Or can be used by hand with our special handle (902, ITEM NO. PE902S : page24)

■用途

- 滑雪底板和金屬稜邊的修整。

■Use : For repairing to sharpen SKI-edge, and to modify SKI-plates.

平扁型銼刀 HAND-TYPE SKI FILES

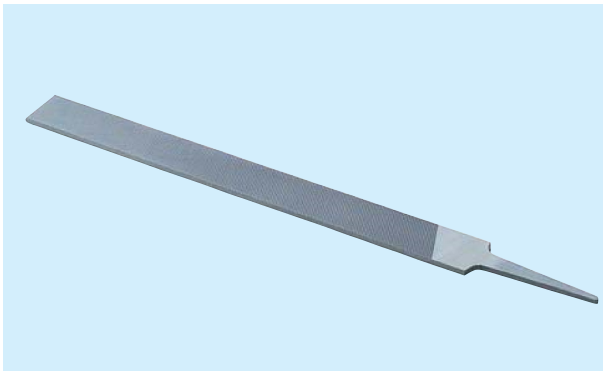

規格表 STANDARD TABLE

mm	W × T mm	kg-doz	齒紋粗度 (cuts/cm) Teeth Number	ITEM No.
150	15 × 2.5	0.60	中齒 14	SK 11
200	20 × 3.5	1.50	中齒 12.5	SK 12
250	24.5 × 4.5	2.52	中齒 10.5	SK 13
300	28 × 5.0	3.30	粗齒 8	SK 14
滲陶瓷 VC coating				
200	20 × 3.5	1.50	中齒 12.5	SK 15
250	24.5 × 4.0	2.52	中齒 10.5	SK 16

齒型銼刀 SQUARE SKI FILES

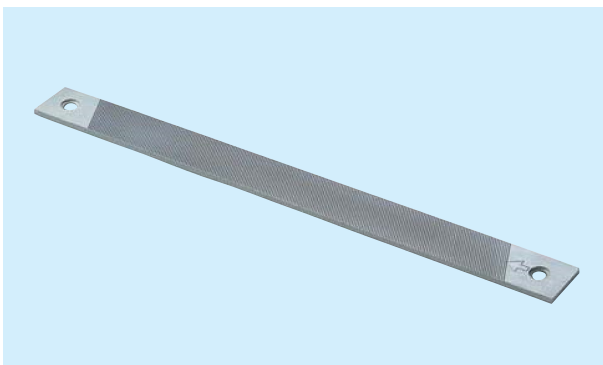

規格表 STANDARD TABLE

mm	mm	W × T mm	kg-doz	齒紋粗度 (cuts/cm) Teeth Number	ITEM No.
180	155	15 × 2.5	0.55	中齒 14	SK 21
200	無孔 (Non)	20 × 4.0	1.30	細齒 19.5	SK 22
230	205	20 × 3.5	1.32	中齒 12.5	SK 23
280	250	25 × 4.5	2.44	中齒 10.5	SK 24
330	300	28 × 5.0	4.38	粗齒 8	SK 25
355	325	34 × 5.0	4.94	粗齒 8	SK 26

滑雪板用銼片 SPARE SKI FILES

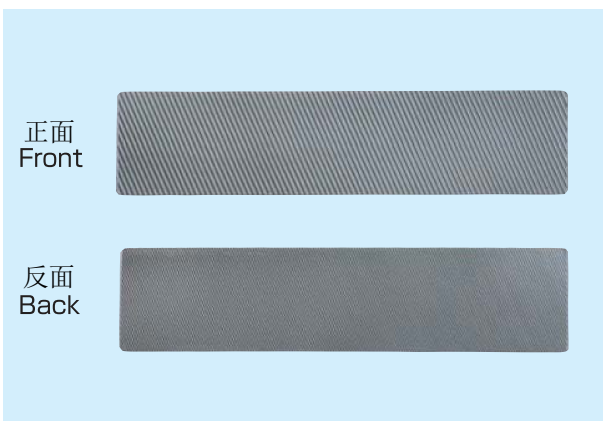

■用途

- 一面是粗加工，另一面是精加工用。
- 用於磨具的替刃。

■Use : A first finishing front on one side, and a final finishing (Back) on another one.
Used in a changeable blade.

規格表 STANDARD TABLE

mm	W × T mm	kg-doz	齒紋粗度 (cuts/cm) Teeth Number		ITEM No.
60	28 × 4.5	0.78	粗齒 8	細齒 14	SK 31
80	28 × 4.5	1.02	粗齒 8	細齒 14	SK 32
120	28 × 4.5	1.56	粗齒 8	細齒 14	SK 33

小型滑雪銼 MINI SKI FILES

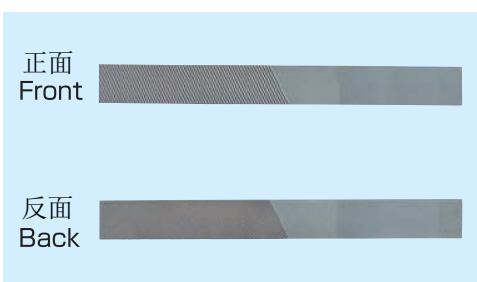

■用途

- 一面是粗加工，另一面是精加工用。

■Use : Two different cuts each side.

規格表 STANDARD TABLE

mm	mm	W × T mm	kg-doz	齒紋粗度 (cuts/cm) Teeth Number		ITEM No.
150	70	16 × 3.5	0.66	粗齒 8	中齒 13	SK 41

禮品&業餘愛好 GIFT & HOBBY

446

■用途

●禮品，業餘愛好，野外露營，釣魚等作為攜帶便利的室外工具使用。

■Use : For GIFT, HOBBY and OUTDOOR working.



ITEM No. TDUS1BU
釣具削刀 (固定型) S1
DIAMOND SHARPENER (Blue Grip)
(SOLID TYPE)



ITEM No. TDUG2RD (紅)
TDUG2BL (黑)
釣具削刀 (折疊型) G2
DIAMOND SHARPENER (RED or BLACK Grip)
(JACKKNIFE TYPE)



金剛石指甲銼 (附套)
NAIL DIAMOND FILE

■用途 Use



Ⓛ 釣鉤的刃部研磨，請使用#600面
#600 face for FISHHOOK

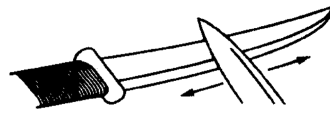

Ⓡ 刀的刃部研磨，請使用#300面
#300 face for KNIFE

■用途 Use

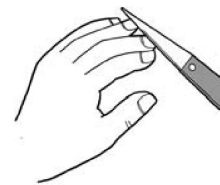

銼刀刷

BRUSH FOR FILES

970



規格表 STANDARD TABLE

TYPE	mm			kg-1p	ITEM NO.
小 (S)	215	80	25	0.06	BRS 215
中 (M)	225	80	40	0.10	BRS 225

皮革尖鑽

AWL

940



■特長

- 經油冷淬火處理，有堅韌硬度，經光澤塗層處理。
- 尖端部可穿線。

■用途

- 木柄為工業上使用。
- 塑膠柄為事務上使用。
- H類型 (有孔) 可穿繩子。

■Material : SKS-8, hardened by oil-quenching.

Cr plating.

Usable as a scribe, convenient in both office and factory.

ITEM No. * * assorted

	S-Type 無孔 Solid	H-Type 有孔 with a hole
*	S	H

規格表 STANDARD TABLE

TYPE	DIMENSION		BOX pcs	ITEM NO.
	A	B		
木柄 Wooden Handle	100A	85B	20	0.37 ALW 100 *
	150A			0.45 ALW 150 *
塑膠柄 Plastics Handle	100A	85B	20	0.59 ALP 100 *
	150A			0.65 ALP 150 *

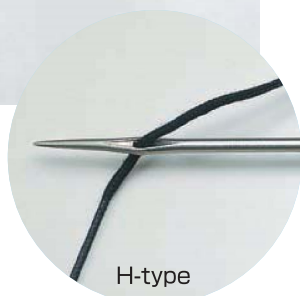



樂器製作用銼 STEELFILESFORMUSICINSTRUMENTS



磨刀棒

SHARPENING STEEL

835

■ 鏢身經磁化處理，切屑粉不會散落。Magnetized!!

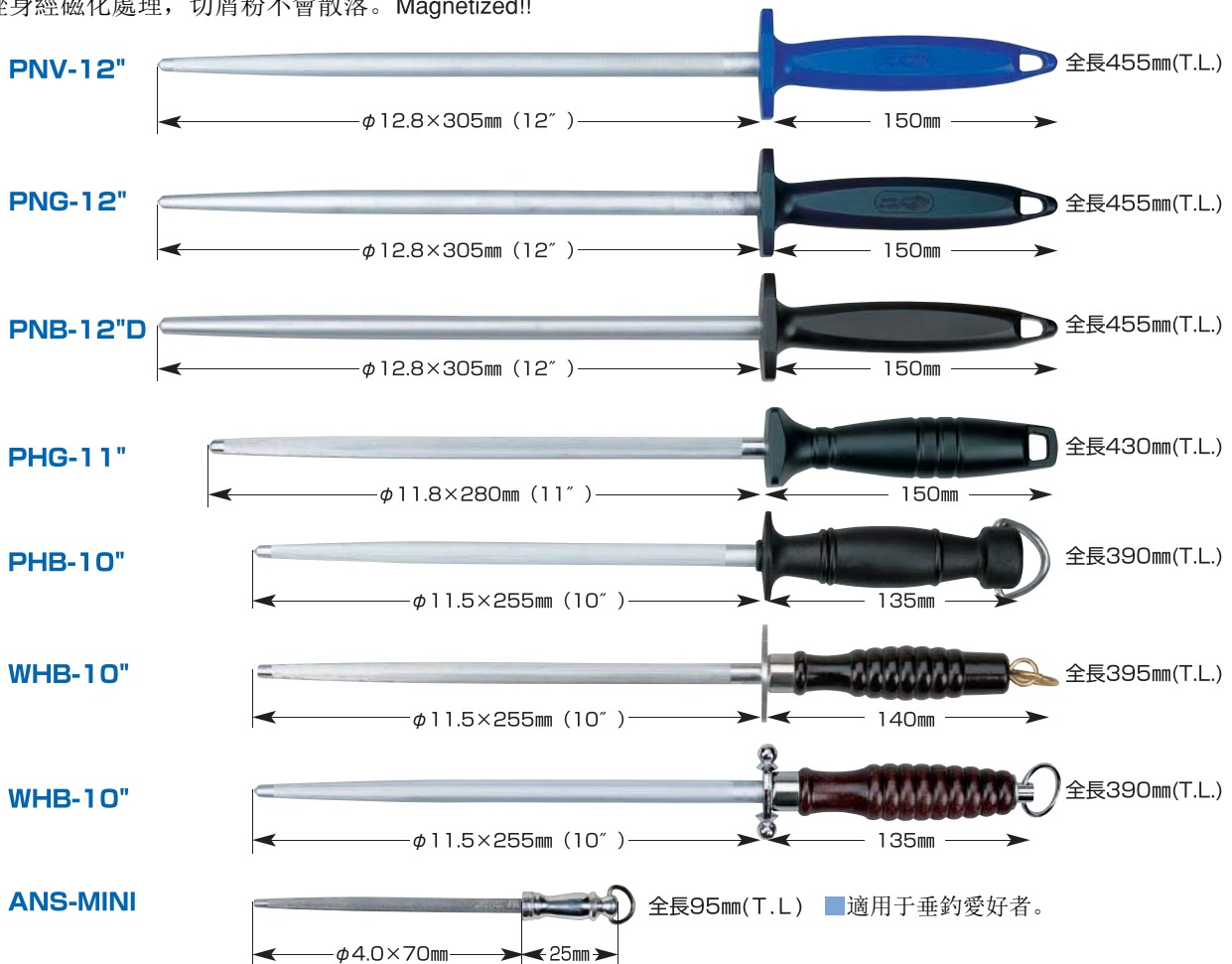

■ 使用方法 (其1) How to use (example1)

- ① 用布等擦淨菜刀上的汗跡。
- ② 左手持磨刀棒，右手持菜刀，把菜刀在磨刀棒上左右交互磨研。
 (研磨角度約20°-45°左右)
- ③ 從刀刀部的下端到前端，依次用磨刀棒研磨。(參照圖2-1，2-2)
- ④ 重複該動作4-5次。
- ⑤ 測試，可切削蔬果，若仍不鋒利，可重複②-④的動作。
 (鋒利的刀刃切洋蔥時眼睛不會刺痛)

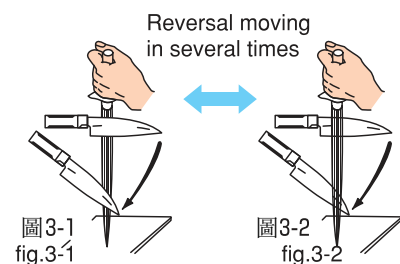
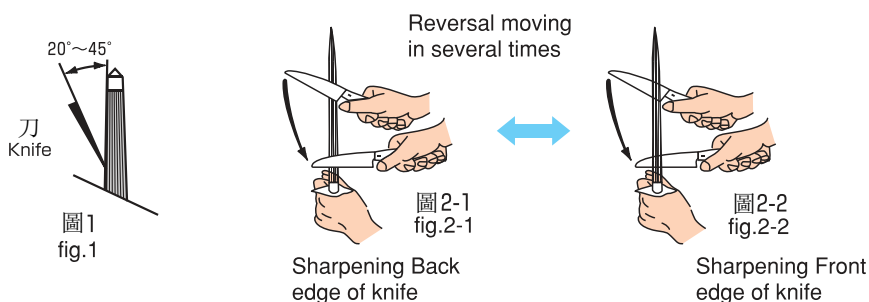

■ 使用方法 (其2) How to use (example2)

- ② 把磨刀棒直立在平坦處修整刀刃。使用方法請參照(圖3-1，圖3-2)。
 (研磨角度根據刃物形狀約20°-45°左右。)(參照圖1)
 ※①、③-⑤的操作方法同使用方法(其1)。

■ 使用注意

- 用布除去磨刀棒上粘附的鐵粉，保存在乾燥處。
- 注意刀，菜刀的刃部不要傷到手。
- 本製品用於刃部的修整，刀刃卷起時請用磨刀石。

■ caution !

- Not to cut your hands during sharpening knives.
- After sharpening knives, please wipe off steel powder magnetized on the sharpening steel by cloth and keep it dry.

磨刀棒

定制產品

SPECIAL ORDER

999

- 這裏舉例的是根據定單定制的銼刀。
- Any other type can be made at your request.

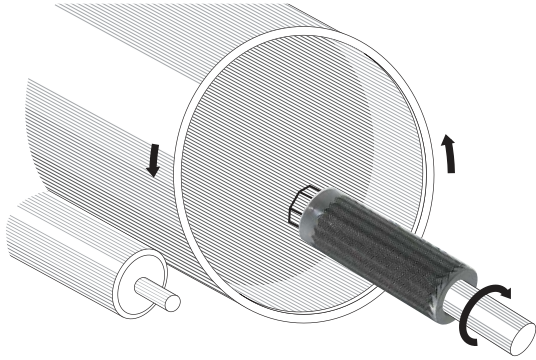

去除大口徑鋼管內的飛邊用的旋轉銼刀。
ROTARY FILE for the inner trimming
 on the side face of a large pipe.

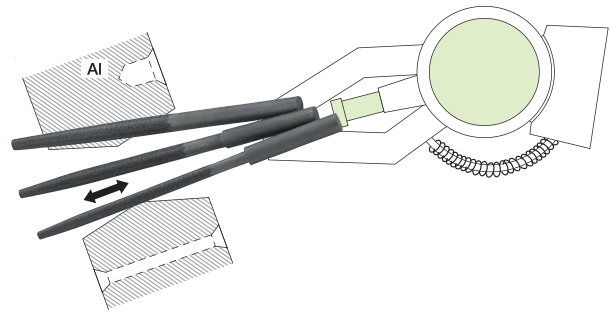

去除鋁型腔飛邊的銼。
 (裝置在機械手上使用)
TRIMMING FILE
 for AI Die Casting work (wheel) .



舟型 SHIP-type 曲型 CRANK-type

專業鐵工銼
PRO-TYPE (ENGINEER'S FILE)



齒紋修整工具
SCREW THREADS TOOL (OUTER)

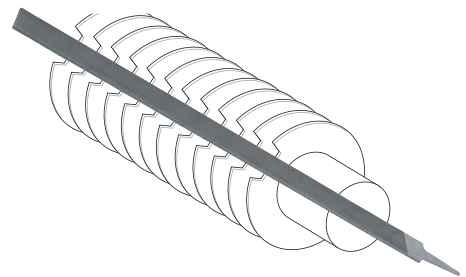

槽銼
Slotting Files
 Max. length 450mm
 加工工件附窄槽。



氣動工具規格
 By AIR ACTING TOOL

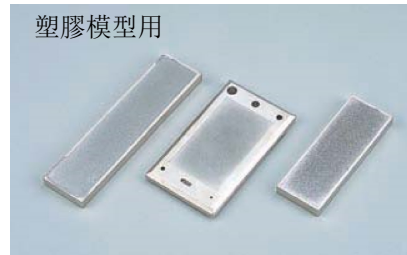

塑膠模型用
磨刀石類型 PLINTH type



塑膠模型用
橢圓型 OVAL type

Do It Yourself



變化豐富的包裝材料
Blister-Film-Package for DIY MARKET



■ 瑞士Vallorbe公司自1811年創立以來，譜寫了瑞士精密機械或手錶和寶飾等手工製作的歷史。其卓越的機能和造型至今仍獲好評。

此外，為適應市場的多種需求，製造了各種形狀，尺寸，齒紋粗度的製品。

※ Vallorbe公司的製品把齒紋粗度用編號表示。它沒有中齒，細齒等稱謂。定貨時請參照齒紋粗度表指定編號。

1 精密什錦銼 Precision Needle files with a round shank handles

SHAPE	ITEM NO. SHAPE	mm	W×T mm	齒紋粗度				kg-1set	BOX pcs
				#0	#2	#4	#6		
	LA2401 平扁 PILLAR	140	4.8×1.1	●	●	●	●	0.08	12
		160	5.4×1.2	●	●	●	●	0.12	
		180	6.0×1.3	●	●	●	●	0.15	
		200	6.5×1.3	●	●	●	●	0.20	
	LA2402 半圓 HALF ROUND	140	5.1×1.5	●	●	●	●	0.08	12
		160	5.6×1.7	●	●	●	●	0.12	
		180	5.9×2.0	●	●	●	●	0.15	
		200	6.3×2.0	●	●	●	●	0.20	
	LA2403 腹圓 CROSSING	140	4.4×1.8	●	●	●	●	0.08	12
		160	5.1×2.0	●	●	●	●	0.12	
		180	5.8×2.2	●	●	●	●	0.15	
		200	6.0×2.4	●	●	●	●	0.20	
	LA2405 刀口 KNIFE	140	5.0×1.4	●	●	●	●	0.08	12
		160	5.4×1.5	●	●	●	●	0.12	
		180	6.0×1.7	●	●	●	●	0.15	
		200	6.4×1.8	●	●	●	●	0.20	
	LA2406 尖扁 WARDING	140	4.8×1.1	●	●	●	●	0.08	12
		160	5.4×1.2	●	●	●	●	0.12	
		180	6.0×1.2	●	●	●	●	0.15	
		200	6.5×1.4	●	●	●	●	0.20	
	LA2407 三角 THREE SQUARE	140	△3.5	●	●	●	●	0.08	12
		160	△3.8	●	●	●	●	0.12	
		180	△4.2	●	●	●	●	0.15	
		200	△4.4	●	●	●	●	0.20	
	LA2408 方 SQUARE	140	□2.2	●	●	●	●	0.08	12
		160	□2.4	●	●	●	●	0.12	
		180	□2.6	●	●	●	●	0.15	
		200	□2.8	●	●	●	●	0.20	
	LA2409 橢圓 OVAL	140	3.5×2.4	●	●	●	●	0.08	12
		160	3.9×2.5	●	●	●	●	0.12	
		180	4.2×2.8	●	●	●	●	0.15	
		200	4.4×2.9	●	●	●	●	0.20	
	LA2410 圓 ROUND	140	φ2.8	●	●	●	●	0.08	12
		160	φ2.9	●	●	●	●	0.12	
		180	φ3.2	●	●	●	●	0.15	
		200	φ3.5	●	●	●	●	0.20	
	LA2411 竹葉 BARRETTE	140	4.7×1.7	●	●	●	●	0.08	12
		160	5.1×1.8	●	●	●	●	0.12	
		180	5.4×2.0	●	●	●	●	0.15	
		200	5.8×2.2	●	●	●	●	0.20	
	LA2415 雙圓邊尖扁 CROCHET	140	4.8×1.2	●	●	●	●	0.08	12
		160	5.4×1.3	●	●	●	●	0.12	
		180	5.9×1.4	●	●	●	●	0.15	
		200	6.5×1.5	●	●	●	●	0.20	
	LA2416 雙圓邊平扁 PILLAR ROUND EDGES	140	4.8×1.2	●	●	●	●	0.08	12
		160	5.4×1.3	●	●	●	●	0.12	
		180	6.0×1.4	●	●	●	●	0.15	
		200	6.5×1.5	●	●	●	●	0.20	

6支套裝

Set of 6files

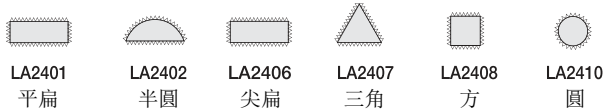

12支套裝

Set of 12files



ITEM NO.	mm	規格	齒紋粗度				kg-1set	BOX pcs
			#0	#2	#4	#6		
LA2452	140	6支套裝	●	●			0.04	6
LA2492		12支套裝	●	●	●		0.08	12
LA2453	160	6支套裝	●	●			0.06	6
LA2493		12支套裝	●	●	●		0.12	12
LA2454	180	6支套裝	●	●			0.08	6
LA2484		12支套裝	●	●	●		0.16	12
LA2485	200	12支套裝	●	●	●		0.20	12

■ 齒紋粗度 CUTTING NO.

- #0 : 25cuts/cm (相當於什錦銼的中齒-細齒)
- #2 : 38cuts/cm (相當於什錦銼的細齒-油光)
- #4 : 56cuts/cm (相當於精密銼的#6)
- #6 : 68cuts/cm

■ 最低定量 (Order lot) ... 1套 (1set)



2 精密銼・鐵工類型

SHAPE	ITEM No.	INCH		mm		齒紋粗度 Roughness										kg-doz	出貨單位 Order lot pcs.	BOX pcs
		mm	mm	W	T	00	0	1	2	3	4	5	6	0.44	0.66			
扁寬型 (常用品) HAND	LP1163	4	100	12.5	3.0	00	0	1	2	3	4	5	6	0.44	1	12		
		5	125	15.5	3.5	00	0	1	2	3	4	5	6	0.66				
		6	150	18.5	4.0	000	00	0	1	2	3	4	5	6			1.25	
		8	200	21.3	4.8	000	00	0	1	2	3	4	5	6			2.10	
		10	250	25.3	6.3	000	00	0	1	2	3	4	5	6			3.70	
		12	300	29.3	7.8	000	00	0	1	2	3	4	5	6			6.50	
扁窄型 REGULAR PILLAR 2 SIDES CUT	LP1132	6	150	12.0	4.0	00	0	1	2	3	4	5	6	0.75	1	12		
		8	200	14.5	4.5	00	0	1	2	3	4	5	6	1.23				
		10	250	17.5	5.3	00	0	1	2	3	4	5	6	2.32				
		12	300	19.3	6.3	00	0	1	2	3	4	5	6	3.60				
圓 ROUND POINTED	LP1660	6	150	φ5.85				1	2	3	4	5	6	0.40	1	12		
心形 PIPPIN	LP1730	6	150	10 × 4.4				0	2	3	4	5	6	0.44	1	12		
半圓 HALF ROUND	LP1560	4	100	12.7	3.5	00	0	1	2	3	4	5	6	0.30	1	12		
		5	125	13.1	4.1	00	0	1	2	3	4	5	6	0.49				
		6	150	15.1	4.7	000	00	0	1	2	3	4	5	6			0.77	
		8	200	21.1	6.3	000	00	0	1	2	3	4	5	6			1.72	
腹圓 CROSSING	LP1960	3.5	88	10.2	2.9			0	2	3	4	5	6	0.23	1	12		
		4	100	11.9	3.6			0	2	3	4	5	6	0.30				
		6	150	14.8	5.0	00	0	1	2	3	4	5	6	0.77				
		8	200	21.3	6.3	00	0	1	2	3	4	5	6	1.72				
萬能齒 扁 HAND	LQ5070	8	200	21.3	4.8	萬能齒 Multicut										1.25	1	12
		10	250	25.3	6.3											2.10		
		12	300	29.3	7.8											3.70		

- 這是一把可以從粗加工到細加工的萬能銼。
- This multicut are availed for both rough shaving and smooth shaving.

齒紋粗度表 CUTTING NO. TABLE

() 內表示每一釐米的齒的切紋。

	相當於粗齒 Rough	相當於中齒 Second	相當於細齒 Smooth	相當於油光齒 Dead-Smooth
150mm	000 (12)	00 (16)	1 (25)	3 (38)
200mm	000 (12)	00 (16)	0 or 1 (20 or 25)	2 (31)
250mm	000 (9)	0 (16)	1 (20)	2 or 3 (25 or 31)

Vallorbe公司的製品把齒紋粗度用編號表示，定購時請參照上表指定編號。

訂購例 (Order No. ex.)

相當於扁型150mm中齒
↓
Vallorbe LP1163 150mm#1
↓
編號 ← 尺寸 ← 齒紋粗度

外國制銼刀



3 異型銼 (模具用異形銼)

Rifflers

Vallorbe的異形銼能充分複雜的金屬模具形狀和齒紋粗度。

150mm 系列 (Total Length=150mm)		ITEM No.	齒長 mm	W × T mm	齒紋粗度 Roughness	kg-doz	BOX pcs
		LR 12910	14	2.4 × 1.2	0 2 4	0.15	6
		LR 12911	12	2.4 × 1.2	0 2 4	0.15	6
		LR 12930	30	□ 2.5	0 2 4	0.15	6
		LR 12940	15	△ 2.0	0 2 4	0.15	6
		LR 12952	17	4.5 × 1.3	0 2 4	0.15	6
		LR 12957	16	4.5 × 0.9	0 2 4	0.15	6
		LR 12965	17	5.0 × 1.7	0 2 4	0.15	6
		LR 12970	14	1.9 × 1.4	0 2 4	0.15	6
		LR 12972	27	3.5 × 2.0	0 2 4	0.15	6
		LR 12981	32	φ 2.0	0 2 4	0.15	6
		LR 12984	30	φ 2.1	0 2 4	0.15	6
		LR 12985	15	φ 2.1	0 2 4	0.15	6
12支套裝 12-pcs.SET	SET	LR 12197	each one		0 2 4	0.15	12(each1)

170mm 系列 (Total Length=170mm)		ITEM No.	齒長 mm	W × T mm	齒紋粗度 Roughness	kg-doz	BOX pcs
		LR 12813	18	3.0 × 1.6	0 2 4	0.19	6
		LR 12816	35	3.3 × 2.9	0 2 4	0.19	6
		LR 12830	32	□ 2.9	0 2 4	0.19	6
		LR 12843	30	△ 3.8	0 2 4	0.19	6
		LR 12855	17	4.7 × 1.7	0 2 4	0.19	6
		LR 12857	18	4.7 × 1.2	0 2 4	0.19	6
		LR 12865	20	5.5 × 1.9	0 2	0.19	6
		LR 12872	30	4.0 × 2.3	0 2 4	0.19	6
		LR 12874	27	4.7 × 2.0	0 2 4	0.19	6
		LR 12883	37	φ 3.2	0 2 4	0.19	6
		LR 12884	36	φ 2.5	0 2	0.19	6
		LR 12885	24	φ 2.2	0 2 4	0.19	6
12支套裝 12-pcs.SET	SET	LR 12187	each one		0 2	0.19	12(each1)

齒紋粗度 CUTTING NO.

- #0 : 25cuts/cm (相當於什錦銼的中齒-細齒)
- #2 : 38cuts/cm (相當於什錦銼的細齒-油光)
- #4 : 56cuts/cm (相當於精密銼的#6)

最低定量 (Order lot) : 1 小箱 (1box)

訂購例 (Order No. ex.)

相當於扁型150mm中齒
↓
Vallorbe LP1163 150mm#1
↓
編號 ← 尺寸 ← 齒紋粗度



180mm系列 (Total Length=180mm)		ITEM No.	齒長 mm	W × T mm	齒紋粗度 Roughness	kg-do2	BOX pcs
		LR 12711	40	8.8 × 2.5	0 2	0.37	6
		LR 12713	40	8.0 × 2.2	0 2	0.37	6
		LR 12731	40	□ 4.8	0 2	0.37	6
		LR 12732	40	□ 4.8	0 2	0.37	6
		LR 12741	40	△ 7.4	0 2	0.37	6
		LR 12750	40	9.7 × 2.5	0 2	0.37	6
		LR 12761	40	9.3 × 3.7	0 2	0.37	6
		LR 12763	40	9.5 × 3.5	0 2	0.37	6
		LR 12764	40	9.5 × 3.5	0 2	0.37	6
		LR 12771	40	9.0 × 4.0	0 2	0.37	6
		LR 12781	40	φ 5.4	0 2	0.37	6
		LR 12790	40	9.3 × 4.1	0 2	0.37	6
12支套裝 12-pcs.SET	SET	LR 12277	each one		0 2	0.37	12(each1)

■ 齒紋粗度 CUTTING NO.

#0 : 25cuts/cm (相當於什錦銼的中齒-細齒)

#2 : 38cuts/cm (相當於什錦銼的細齒-油光)

■ 最低定量 (Order lot) : 1 小箱 (1box)

4 組銼 Habilis

● 日本式的5支裝銼刀

形狀 SHAPE	ITEM No.	全長 mm	W × T mm	齒紋粗度 Roughness	kg-1set	BOX pcs
	LH 2601	215	10 × 2.6	00 1	0.23	5
	LH 2602	215	12.2 × 3.4	00 1	0.23	5
	LH 2607	215	△ 9.4	00 1	0.23	5
	LH 2608	215	□ 5.8	00 1	0.23	5
	LH 2610	215	φ 6.5	00 1	0.23	5
5支套裝 5-pcs.SET	SET	LH 2627	each one		00 1	5(each1)

■ 齒紋粗度 CUTTING NO.

#00 : 18cuts/cm (中齒)

1 : 25cuts/cm (細齒)

■ 最低定量 (Order lot) : 1 小箱 (1box)

訂購例 (Order No. ex.)

相當於扁型150mm中齒

Vallorbe LP1163 150mm#1
 ↓
 編號 ← 尺寸 ← 齒紋粗度



形狀 SHAPE	INCH		W × T mm	齒紋粗度 CUTTING Roughness			kg-doz	最低定量 Order lot pcs.	BOX pcs
		mm							
扁 HAND									
	6	150	15.0 × 3.8	粗齒 Bastard	中齒 Second	細齒 Smooth	0.80	1	12
	8	200	20.0 × 5.0	粗齒 Bastard	中齒 Second	細齒 Smooth	1.80	1	12
	10	250	24.5 × 6.5	粗齒 Bastard	中齒 Second	細齒 Smooth	3.40	1	6
	12	300	30.0 × 7.0	粗齒 Bastard	中齒 Second	細齒 Smooth	5.15	1	6
14	350	34.0 × 7.8	粗齒 Bastard	中齒 Second	—	7.80	1	6	
扁 萬能齒 HAND MAGICUT									
	6	150	15.0 × 3.8	萬能齒 magicut	—	—	0.70	1	12
	8	200	20.0 × 5.0	萬能齒 magicut	—	—	1.70	1	12
	10	250	25.0 × 6.5	萬能齒 magicut	—	—	3.25	1	6
12	300	34.0 × 7.8	萬能齒 magicut	—	—	5.10	1	6	
半圓 HALF ROUND									
	6	150	15.0 × 4.2	粗齒 Bastard	中齒 Second	細齒 Smooth	0.70	1	12
	8	200	19.0 × 5.0	粗齒 Bastard	中齒 Second	細齒 Smooth	1.50	1	12
	10	250	23.5 × 7.0	粗齒 Bastard	中齒 Second	細齒 Smooth	2.75	1	6
12	300	30.0 × 8.2	粗齒 Bastard	中齒 Second	細齒 Smooth	4.75	1	6	
圓 ROUND									
	6	150	φ 6.0	粗齒 Bastard	中齒 Second	細齒 Smooth	0.40	1	12
	8	200	φ 8.0	粗齒 Bastard	中齒 Second	細齒 Smooth	0.70	1	12
	10	250	φ 10.0	粗齒 Bastard	中齒 Second	細齒 Smooth	1.45	1	12
12	300	φ 13.0	粗齒 Bastard	中齒 Second	細齒 Smooth	3.10	1	6	
方 SQUARE									
	6	150	6.0	粗齒 Bastard	中齒 Second	細齒 Smooth	0.45	1	12
	8	200	7.7	粗齒 Bastard	中齒 Second	細齒 Smooth	0.90	1	12
	10	250	9.3	粗齒 Bastard	中齒 Second	細齒 Smooth	1.80	1	12
	12	300	12.2	粗齒 Bastard	中齒 Second	細齒 Smooth	3.80	1	6
14	350	16.0	粗齒 Bastard	—	—	6.70	1	6	
扁 單紋齒 MILL									
	6	150	15.0 × 2.6	粗齒 Bastard	中齒 Second	細齒 Smooth	0.55	1	12
	8	200	19.5 × 3.8	粗齒 Bastard	中齒 Second	細齒 Smooth	1.25	1	12
	10	250	25.0 × 4.5	粗齒 Bastard	中齒 Second	細齒 Smooth	2.45	1	6
	12	300	29.5 × 5.3	粗齒 Bastard	中齒 Second	細齒 Smooth	4.10	1	6
14	350	34.0 × 6.3	粗齒 Bastard	—	—	7.80	1	6	
5本組 扁 5-pcs HAND									
	—	215	11 × 3.2	萬能齒 magicut	中齒 Second	—	0.3	5	25

●什錦銼兼具了日本獨特的規格，由Nicholson公司製作的銼刀。



形狀 SHAPE	 mm	編號 ITEM No.	 W × T mm	齒紋粗度 Roughness	 kg-doz	最低定量 Order lot pcs	BOX pcs
平板 BLADE	350	299b Z-1	36.0 × 5.4	粗齒 Bastard (9cuts/inch)	3.35	1	50
		299b Z-1		中齒 Second (10cuts/inch)	3.35	1	50

- 齒紋間距非常大，不易積屑。在去除輕金屬上的塗裝皮膜，銅，鋁，橡膠，塑膠，木等容易積屑的被切削物時可以發揮其威力。
- CAR BODY FILES : Due to less clogs. this file is useful for Copper, Aluminum, Babbitt, Brass, etc.



形狀 SHAPE	 mm	編號 ITEM No.	 W × T mm	齒紋粗度 Roughness	 kg-doz	最低定量 Order lot pcs.	BOX pcs
平板 BLANDE	350	PF-101	35.0 × 4.5	粗齒 Bastard (9cuts/inch)	3.6	1	6
		PF-103		中齒 Second (12cuts/inch)	3.6	1	6
		PF-109		細齒 Smooth (15cuts/inch)	3.6	1	6

- 齒紋間距非常大，且用特殊化學研磨法進行表面處理，切屑不易附著。應用於特殊合成的鉻鋼，其耐久性卓越。
- CAR BODY FILES : Due to less clogs. this file is useful for Copper, Aluminum, Babbitt, Brass, Rubber, Plastics, Wood, etc.

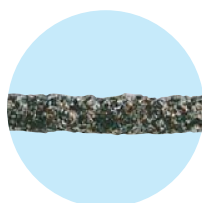

TYPE	Order No.	直徑		Grid No.	最低數量
		INCH	mm		
粗繩型 CORD 	46	φ 0.150	φ 3.8	#120	1卷 (22.75m)
	47	φ 0.125	φ 3.2	#120	
	48	φ 0.093	φ 2.3	#150	
	49	φ 0.082	φ 2.1	#120	
	50	φ 0.070	φ 1.8	#180	
	51	φ 0.055	φ 1.4	#120	
	52	φ 0.055	φ 1.4	#150	
	53	φ 0.040	φ 1.0	#180	
	54	φ 0.030	φ 0.8	#200	
	54-H	φ 0.025	φ 0.6	#200	
	55	φ 0.018	φ 0.5	#200	
	60	φ 0.015	φ 0.4	#200	
	66	φ 0.012	φ 0.3	#280	
	線帶型 TAPE 	01 Tape	2 / 32	1.59	
56 Tape		3 / 32	2.38	#180	
57 Tape		4 / 32	3.18	#180	
58 Tape		6 / 32	4.76	#150	
59 Tape		8 / 32	6.35	#150	

- 世界上唯一的繩狀銼。主要作為切斷作業的基礎上，還適應於手工不易處理的微小部分的研磨和方孔，溝部，彎曲部，手工雕刻部件的表面細加工作業。
- These Abrasive Cords & Tapes are served to cut off articles, to file a slit ditch, to grind off a curved surface of metals and ceramics.

- 因為生銹等原因，不能正確判斷銼刀名稱時，為確認銼刀名稱，請把實物對照圖紙進行確認。
- On the time when the customer missed "STEEL FILE NAME" due to RUSTY and BLACKENED DART, please put an unknown STEEL FILE on this paper in order to the confirmation of "STEEL FILE NAME".

精密銼 PRECISION NEEDLE FILES

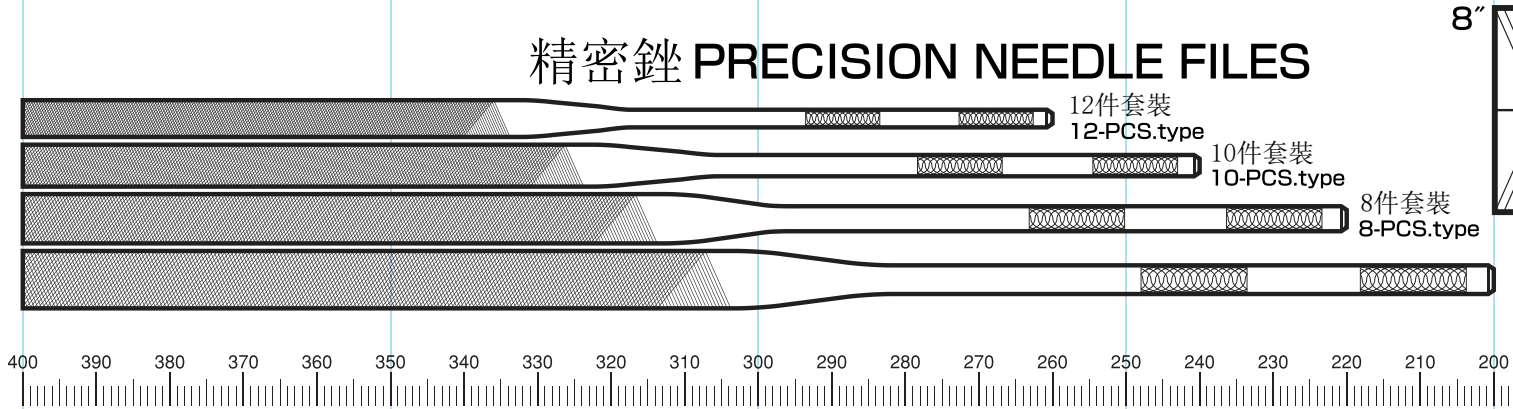

什錦銼 DIE SINKER'S ASSORTED FILES

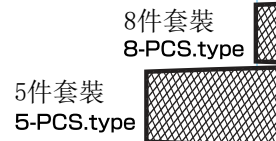

鐵工銼 ENGINEER'S FILES

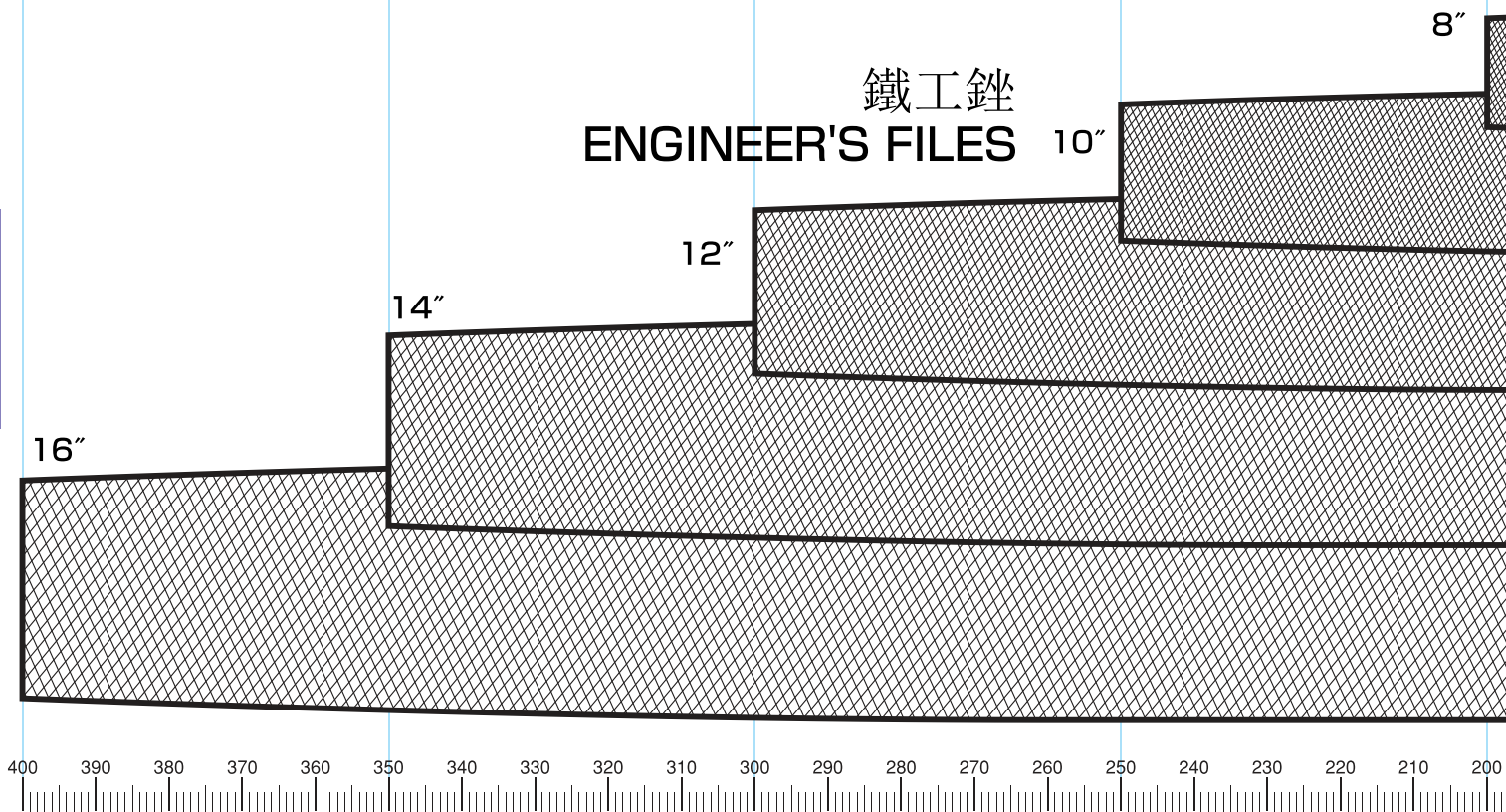

菱形鋸 FEATHER EDGE SAW FILES

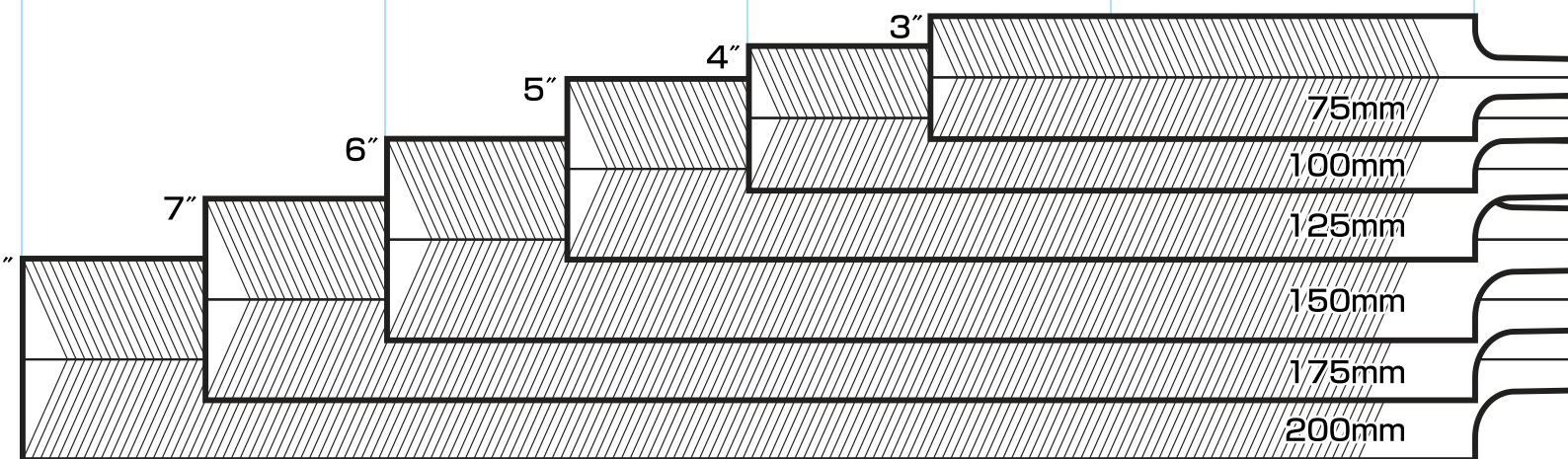

5件套裝
5-PCS.type

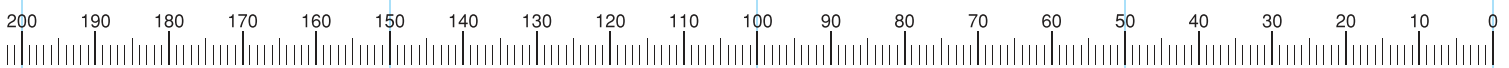

12件套裝
12-PCS.type

10件套裝
10-PCS.type

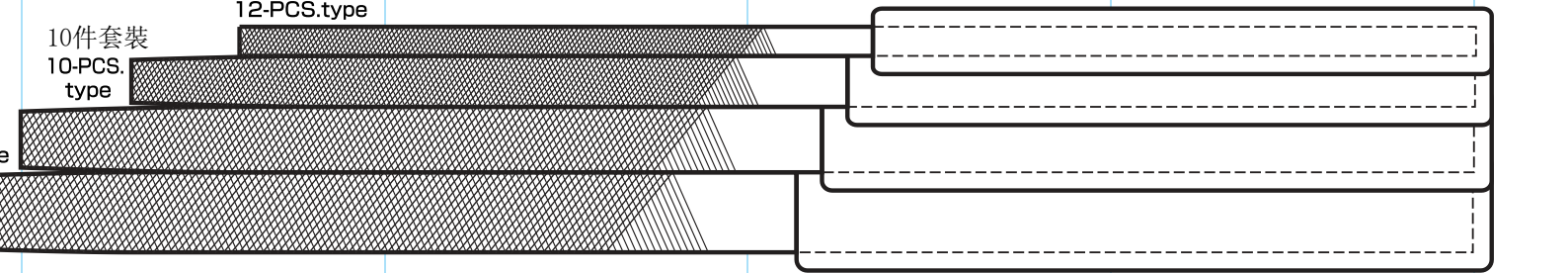

6"

150mm

200mm

250mm

300mm

350mm

400mm

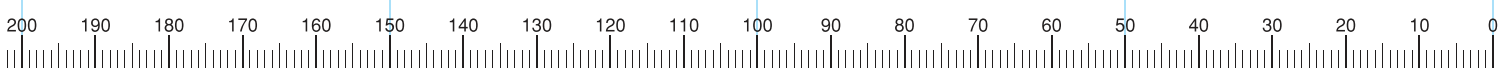

鐵工銼

什錦銼



圖1

※圖形中的數位表示銼刀尺寸。
 100 : 扁 100mm (HAND 100mm) 5P : 5支裝套裝半圓(5-pcs HALF ROUND)

15mm W						20mm W						25mm W						30mm W						35mm W						40mm W						頁碼 PAGE	名稱 NAME
150						200						250						300						350						400						7 }	鐵工銼
150						200						250						300						350						400							
400						400						250						300						350						400						11 }	
250						300						350						400																			
																														15 }	什錦銼						
																														25 }	精密銼						
5"						200																								29 }	金剛石銼						
5"						100						125						金剛石菱形銼																			
75						100						125						金剛石菱形銼												34 }							
150						300						200						250						300													
3"						4"相中						5"						6"7"8"												37 }	鋸銼						
150						200						250						300						350						39 }	鋁板銼						
200						200						250						250						300						41 }							
150						200						250						300						350						400						43 }	粗齒紋銼
400						半丸						馬蹄銼						300						350						350W							
平																														51 }	電動・氣動工具						
																														54 }							

● 電動・氣動工具用銼刀即便是相同寬度，也能夠選擇各種形狀，請參照第51頁和52頁。

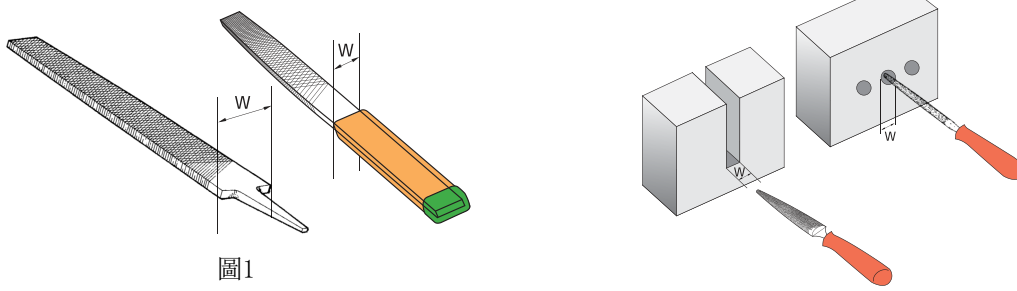
- 採用熱軋加工，能製成各種斷面形狀的鋼材。
- 除銼刀鋼 (SKS-8, SK-2) 外，還能熱軋加工 SCM 材, SCM 材和 SUS 材質的鋼材。
- 長度不到5米，重1噸以下。
- 特殊定制的話，最少批量20噸起。

- Hot Rolling BAR can be deformed as your request.
- Total length : Upto 5m, banded each 1ton.
- In the case of your special order, one lot is more than 20ton per one size.



扁 FLAT Bar

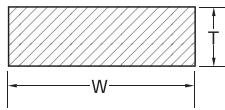

T × W mm	重量 kg/m
8.5 × 36.0	2.42
7.5 × 34.0	2.01
7.0 × 30.0	1.66
6.3 × 29.4	1.46
6.0 × 25.3	1.20
5.7 × 25.2	1.13
5.0 × 25.0	0.99
5.0 × 21.3	0.84
4.7 × 21.3	0.79
4.0 × 20.5	0.65
4.0 × 16.3	0.52
3.5 × 11.0	0.30
3.3 × 16.4	0.43
3.0 × 9.0	0.21
2.5 × 7.0	0.14
2.0 × 4.0	0.06

三角 TRIANGULAR Bar

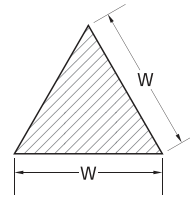

W mm	重量 kg/m
25.0	2.14
22.0	1.66
20.0	1.37
17.3	1.02
15.3	0.80
12.3	0.52
9.0	0.28
7.5	0.19
6.1	0.13
4.1	0.06

半圓 HALF ROUND Bar

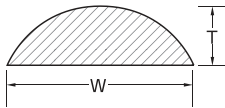

T × W mm	重量 kg/m
11.0 × 36.0	2.10
10.0 × 34.0	1.87
8.5 × 30.0	1.45
7.0 × 25.0	1.01
6.0 × 21.0	0.71
4.5 × 16.0	0.41

橢圓 OVAL Bar

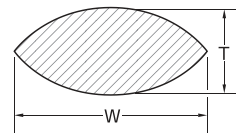

T × W mm	重量 kg/m
11.7 × 22.0	1.76
10.0 × 18.6	1.27
8.2 × 15.0	0.83
8.0 × 10.0	0.50

圓 ROUND Bar

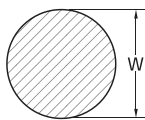

W mm	重量 kg/m
18.0	2.01
15.0	1.40
12.2	0.92
10.0	0.62
8.0	0.40
6.0	0.22

菱形 FEATHER EDGE Bar

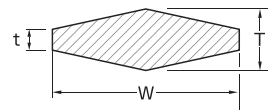

W × T × t mm	重量 kg/m
28.2 × 3.9 × 0.25	0.46
25.1 × 3.45 × 0.25	0.37
20.1 × 2.9 × 0.25	0.25
17.1 × 2.25 × 0.2	0.17

方 SQUARE Bar

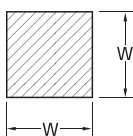

W mm	重量 kg/m
18.0	2.56
15.0	1.78
12.2	1.18
10.0	0.79
8.0	0.51
6.0	0.28
5.5	0.24
4.3	0.15
3.2	0.08
2.5	0.05

異型材 OTHERS

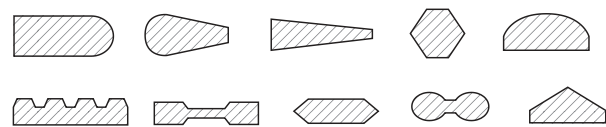

H 系列 (H-type)



CM-H03



CM-H07

規格 DESCRIPTION

TYPE	剝齒可動長度 基礎台有效長度 Cutting Length mm	打擊數 Stroke No. /min.	驅動馬達 Drive Motor	使用台數 1set of Machines
CM-H01	300~400	350	1.5kw 1130rpm/200V 60Hz	2 台
CM-H03	250~300	490	0.75kw 1130rpm/200V 60Hz	2 台
CM-H05	200~250	680	0.75kw 1700rpm/200V 60Hz	2 台
CM-H07	100~150	880	0.4kw 1710rpm/200V 60Hz	2 台

- 平面剝齒機械。
- For Flat surface.

M 系列 (M-type)



CM-M07

規格 DESCRIPTION

TYPE	剝齒可動長度 基礎台有效長度 Cutting Length mm	打擊數 Stroke No. /min.	驅動馬達 Drive Motor	使用台數 1set of Machines		
CM-M07	150~300	上齒用 Upcut	0.4kw 1710rpm/200V 60Hz	上齒用 Upcut	2	3 台
		下齒用 Overcut		1		
CM-M09	100~150	上齒用 Upcut	0.4kw 1710rpm/200V 60Hz	上齒用 Upcut	2	3 台
		下齒用 Overcut		1		

- 圓面剝齒機械。
- For Round surface.

銼刀八題 ⑧ 刈山 信行

一踏進銼刀工廠，空氣中瀰漫著豆醬味。豆醬用於銼刀的淬火。淬火即在銼刀表面塗上豆醬待其乾燥後，放入加溫至800℃的鉛中加熱後用水冷卻。800℃的銼刀放入20℃的水中的瞬間，銼刀的表面被水蒸氣所覆蓋，若被水蒸氣覆蓋狀態淬火的話，銼刀會斷裂。塗上豆醬後，就不會被水蒸氣所覆蓋，使銼刀獲得平均冷卻，便能夠完成淬火。

塗上豆醬的另一個效果是，可以防止銼刀上粘鉛及防止刃部的碳（碳是增加硬度的主要元素）流失。

在使用的豆醬裏，摻進鹽，硝酸鉀，骨粉等添加物。「舊時，將紅豆醬一貫目（日本的重量單位，約等於3.75公斤），鹽500匁（舊時日本重量單位，貫的千分之一，約等於3.75克），硝酸鉀250匁用茶磨壓碎，然後用水或鹽水或醬油稀釋後使用」。此外在其他的報告

塗豆醬

裏也有記載，「在上述的豆醬裏加入女發或牛骨粉，甚至加上氰化鉀使用」。

加入氰化鉀的作用是讓碳和氮進入銼刀的刃部，達到更加堅硬的目的。

在豆醬中摻入硝酸鉀後稱之為焰硝豆醬。在江戶時代的刀鍛冶，水心子正秀的『劍工秘傳志』中，也有在銼刀上塗焰硝豆醬後淬火的記錄。

除銼刀之外，塗上豆醬後進行淬火的刃物還有長野縣的信州鑱刀和愛知縣的豐橋鑱刀，以及鳥取縣的倉吉木赤杷等。

值得一提的是，外國的銼刀，有往加熱後的銼刀上塗馬糞，撒上牛角的粉末和鹽進行淬火的。在英國，還有把銼刀浸入啤酒的酵母中，然後塗滿海鹽和稻穀殼後進行淬火作業的。

（廣島縣立西部工業技術中心主任研究員=吳市）綠地帶 3. 10. 7 摘自中國新聞