

APEM

PBA series Piezo switches

- For hostile environments
- High sealing performance
- Easy to clean



Wide range of custom options

Vertical integration and high technical expertise

VERTICAL INTEGRATION

From raw material transformation to finished products, APEM controls all phases of production, including screw machining, moulding, plating, marking and reliability testing. Product tooling, assembly machinery and test equipment are manufactured in-house by APEM's manufacturing engineering team.

HIGH TECHNICAL EXPERTISE

With over 50 years of switch design and manufacturing experience, APEM has developed into a world leader in the field of switching. APEM's R&D and design engineering departments develop new and custom products using the leading CAD/CAM software (AutoCAD, CATIA, Pro/ENGINEER...).

MANUFACTURING



Screw machining



Strength/stroke
measuring equipment



Laser etching



Electrical test

QUALIFICATION



Salt spray



Temperature



Electrical/mechanical life

APEM's vertical integration and engineering expertise have led to the development of custom piezo switches, designed to specific customer specifications. All APEM's piezo switches are produced in-house using high speed screw machining, allowing the manufacture of an endless array of shapes with minimum investment.

Product description

PBA piezo switches are based on the principle of piezoelectricity. The piezoelectric effect is the ability of some materials to generate an electric potential in response to an applied mechanical stress. The piezoelectric effect is also reversible; when an electric field is applied, a strain is produced. This technology is at the core of many high-end applications, including laser mirror alignment, fuel injectors and ultrasonic submarine detectors.

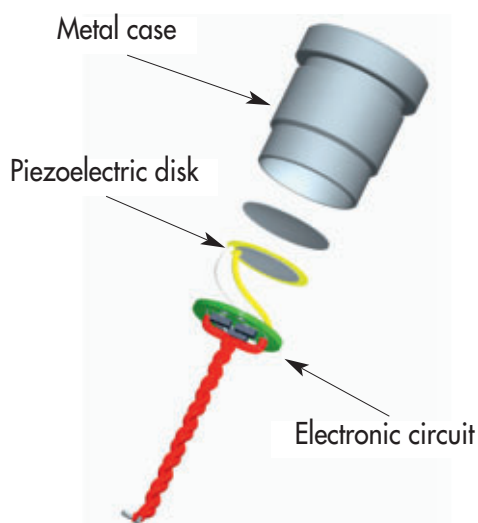

In APEM piezo switches, a force applied to the switch surface transfers to the piezo disk creating an electrical pulse. This electrical signal is converted to an expected electrical output through a customizable electronic circuit. The duration of the electrical signal depends on the speed, force and duration of actuation.

The output of the switch is closed for a specified pulse duration depending on the electrical function chosen (see next page).

Advantages

APEM piezo switches are based on a solid-state output allowing for a **very long life expectancy** (more than 50 millions cycles), ideal for demanding applications where reliability is most important.

The flat actuation surface is completely closed, preventing the intrusion of liquids or other contaminants, **perfect for surface cleaning** required in the medical and food-processing industries.

High performance sealing (IP68 and IP69K) is achieved due to the one-piece construction of the switch.

No external power supply is required.

The screw-machined metal housing construction and APEM's vertical integration allow for the manufacture of a **variety of shapes**.

A few applications



Medical
(sealing, no retention area)



Bath
(sealing)



 **Mining**
(ATEX versions)



Food-processing
(IP69K sealing)

PBA series

Piezo switches

Electrical functions

FINGER PRESSURE applied to switch

1 = pressure
0 = no pressure

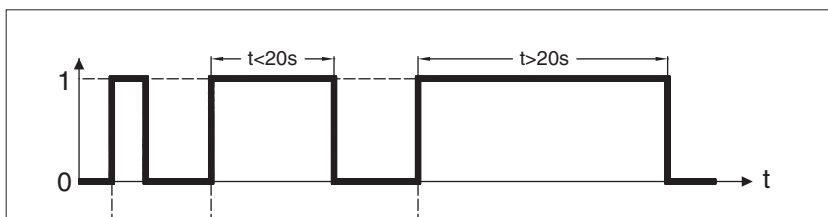

OUTPUT

- Momentary NO (pulse)
No external power supply required

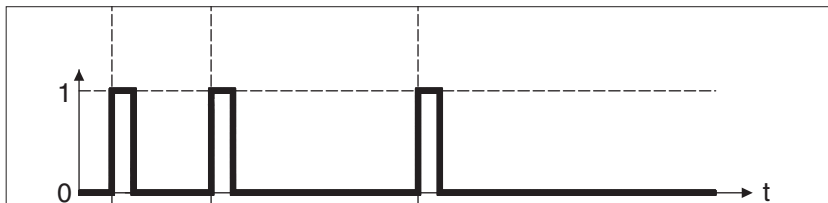

- Momentary NC (pulse)
No external power supply required

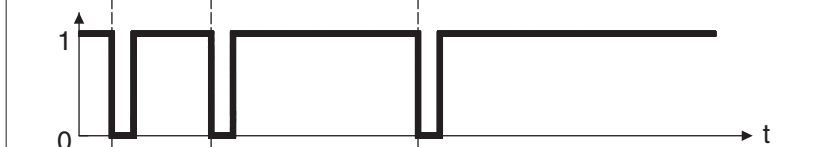

- Momentary NO prolonged pulse
No external power supply required

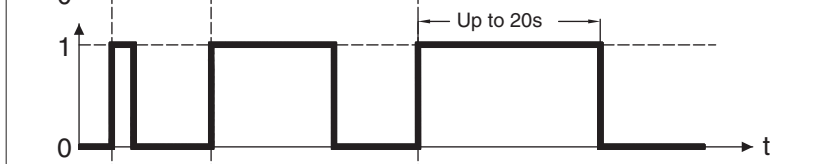

- Latching (ON - OFF)
Requires external power supply

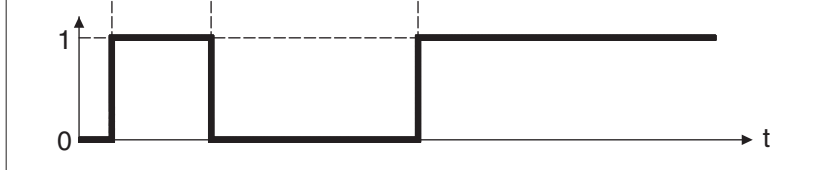

1 = closed output 0 = open output

Wiring diagrams

	Non-illuminated	1 LED *	2 LEDs	3 LEDs
Momentary NO				
Momentary NC				
Momentary NO prolonged pulse				
Latching (ON - OFF)				

Legend : C = yellow, D = blue, B = black, A = same colour as LED. * LED colour is indicated by the bottom of the product.

PBA series

Piezo switches

Custom configurations

Due to a modular construction, custom configurations can be produced using the following options, combined or not with standard elements, to meet your requirements.

☐ Shapes



☐ Materials, colours

Violet or dark grey anodized aluminium, gold plated...
Other : on request



☐ Marking

Laser etching on stainless steel and anodized aluminium
Other : on request



☐ Illumination

Other LED colours (pink, ice blue...)
Custom illumination control (LED connected to the load, blinking LED)
High intensity LEDs
Specific LED voltage
AC LED power supply



PBA series

Piezo switches

Custom configurations

□ Electrical functions

- Programmed pulse duration

FINGER PRESSURE
applied to switch

OUTPUT

1 = pressure,
0 = no pressure

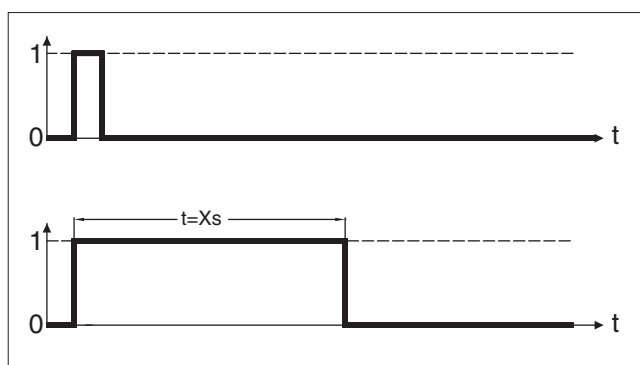

- Other : on request

□ Terminals

Screw or quick-connect/solder
Different wire lengths and colours
Cables and connectors on specifications (for example teflon)



□ Anti-vandal piezo switches

Impact resistance up to IK10

□ Specific mounting

Rear mounting, for flush version



PBA series

Piezo switches

Specifications

ENVIRONMENTAL SPECIFICATIONS

- Sealing : IP68 per IEC 529, IP69K per DIN 40050-9 (switches mounted on panel or not)
- Vibration resistance : 10-500 Hz / 10 g per IEC 60068-2-6
- Operating temperature : -40°C to +75°C
- EMC compatibility according to EN 61058-1 for the whole range
- EMC compatibility according to EN 61000-4 & EN61000-6-2 for model 1A (code 002)

MATERIALS

- Case : aluminium, anodized - or stainless steel 316L or brass, chrome plated
- Multi-wire leads section 0,22 mm² length 300 mm, twisted by pair
- Cable, length 300 mm, section depending on switch model
- PC terminals : bronze, tin plated

ELECTRICAL AND GENERAL SPECIFICATIONS

- Max. current/voltage rating : 1A 24VAC/DC or 200mA 24VAC/DC depending on version
- Switch resistance ON : 10Ω max.
- Switch resistance OFF : 5MΩ min.
- Operating force : 2 to 6N
- Life expectancy : 50 million cycles
- LED consumption : Illuminated dot : 10mA - Illuminated ring : 20mA

SEALING IP68

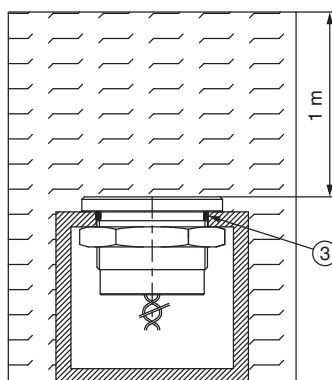

SEALING IP69K

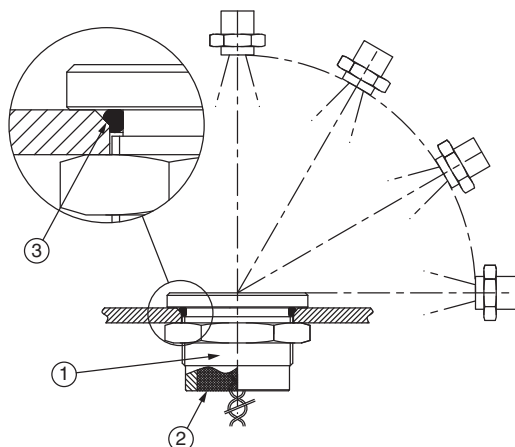

- ① One-piece bushing
- ② Epoxy sealed terminals
- ③ O-ring

Continuous immersion in water

IP68 test conditions

Continuous immersion in water
(1m, 24 hours)

High pressure, high temperature wash down

IP69K test conditions

- . Pressure : 80 - 120 bars
- . Distance : 15 cm
- . Temperature : 80°C ± 5°C
- . Flow : 14 - 16 l/mn
- . Duration : 30 seconds per position

Dimensions : first dimensions are in mm while inches are shown as bracketted numbers.

Tolerance : The general tolerance for dimensions in this brochure is ± 0,3 (.012).

Dimensions, specifications and data shown in this brochure are subject to change without notice.

PBA series

Piezo switches Ø 16 (.630)

Overview

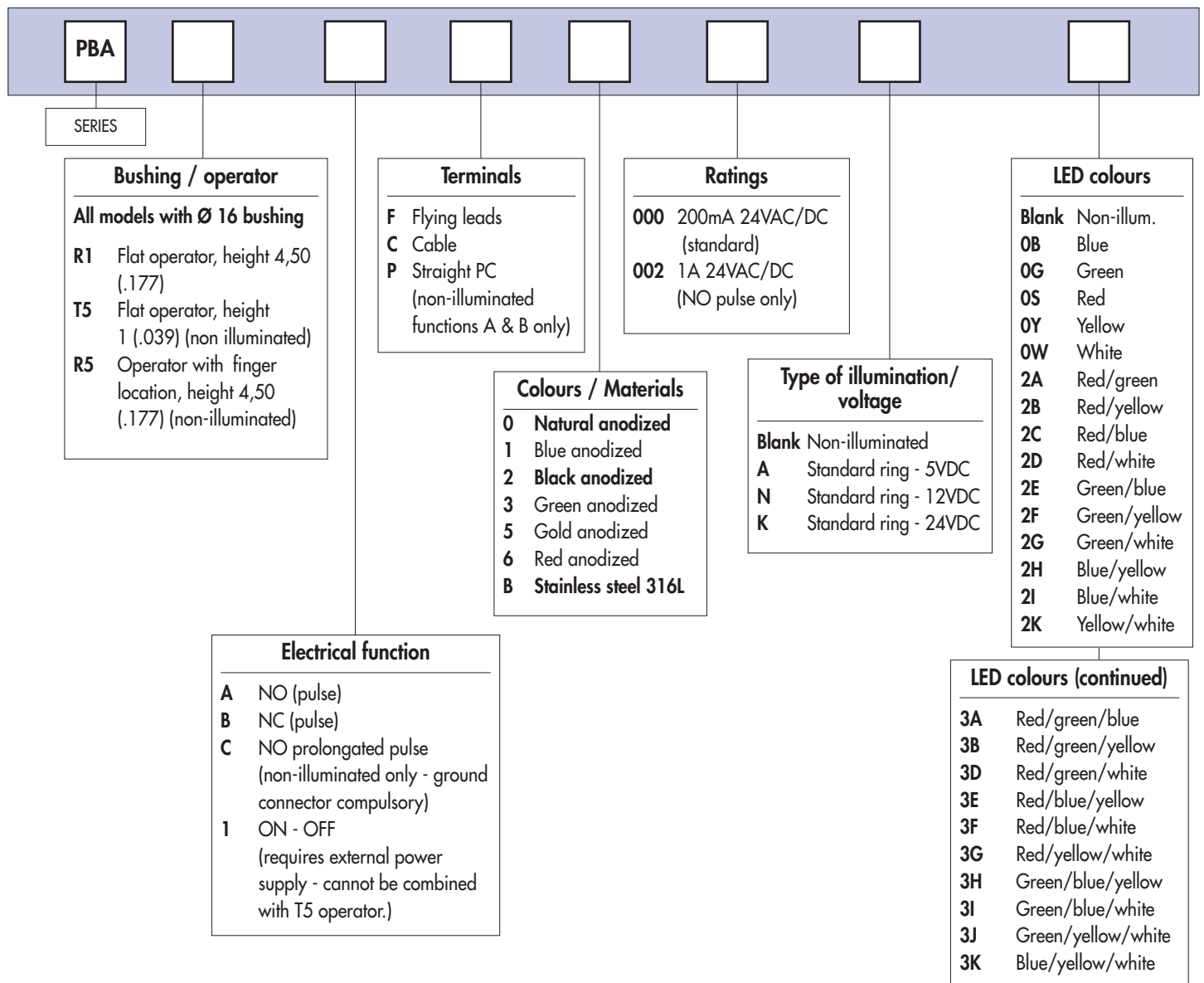

For options not listed above, please refer to our "Custom configurations" pages.



NOTICE : please note that not all combinations of above numbers are available. Refer to the following pages for further information.



Mounting accessories : standard hardware supplied : 1 hex nut U4116 (19 mm ac. flats) and 1 O-ring



Packaging unit : 20 or 40 pieces

PBA series

Piezo switches Ø 16 (.630)

Illuminated or non-illuminated

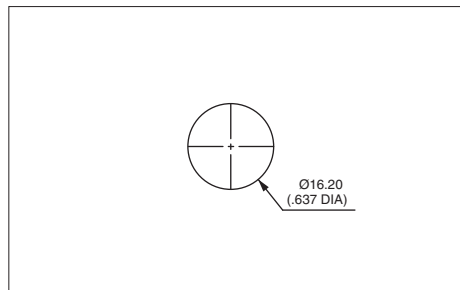

- Operator Ø 18 mm (.708)

Shown with flying lead terminals.

MODEL
STRUCTURE

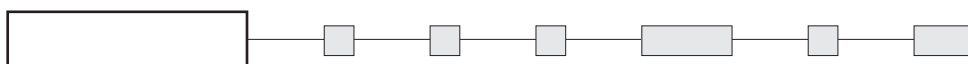

Non-illuminated, operator height 4,50 mm (.177)



PBAR1AF2000

Flat
PBAR1

With finger location
PBAR5

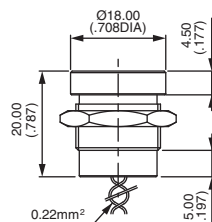

R1

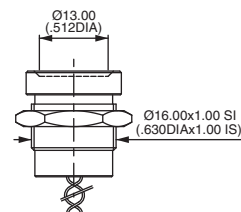

R5

Non-illuminated, operator height 1 mm (.039)



PBAT5AF0000

Flat
PBAT5

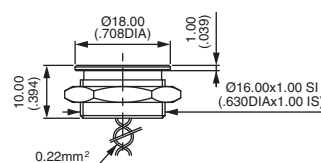

With standard illuminated ring



PBAR1AF000A0B

Flat operator, height 4,50 (.177)
PBAR1

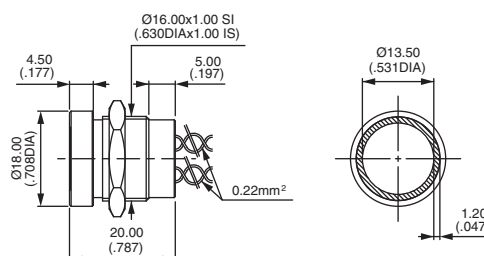

Wire colours : see "Electrical functions" page.

PBA series

Piezo switches Ø 16 (.630)

Options

ELECTRICAL FUNCTION

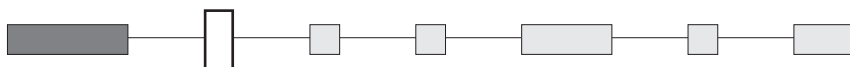

- A** NO pulse
- B** NC pulse
- C** NO prolonged pulse (non-illuminated models only) - Ground connector U5735 compulsory, order separately.
- 1** ON - OFF - Requires external power supply - Cannot be combined with T5 operator.

TERMINALS

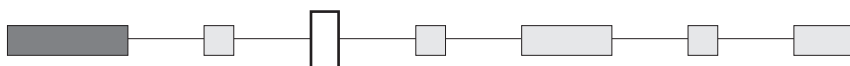

- F** Flying leads
- C** Cable
- P** Straight PC (non-illuminated models - functions A and B only)

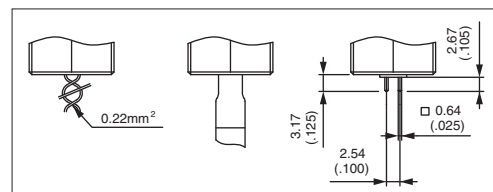

CASE COLOURS / MATERIALS

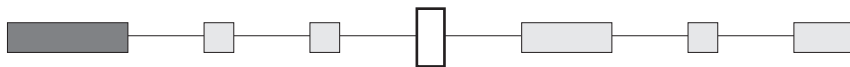

Code	Colour
0	Natural anodized aluminium
1	Blue anodized aluminium
2	Black anodised aluminium

Code	Colour
3	Green anodized aluminium
5	Gold anodized aluminium
6	Red anodised aluminium

Code	Colour
B	Stainless steel 316L



0 1 2 3 5 6 B

RATINGS

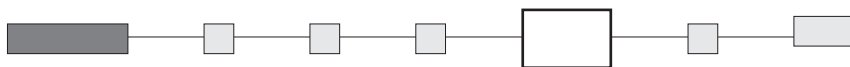

- 000** 200mA 24VAC or DC (standard)
- 002** 1A 24VAC or DC (NO pulse only)

PBA series

Piezo switches Ø 16 (.630)

Options

TYPE OF ILLUMINATION / VOLTAGE

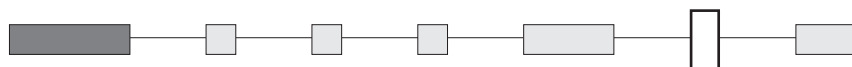

Blank : non-illuminated

	5VDC	12VDC	24VDC
○	A	N	K

LED COLOURS

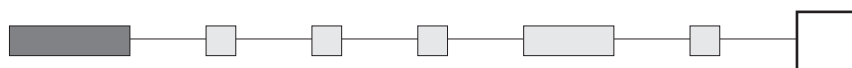

Integrated LED resistor

Blank : non-illuminated



Illuminated 1 LED *

0B : blue - **0G** : green - **0S** : red - **0Y** : yellow - **0W** : white

Illuminated 2 LEDs

2A : red/green - **2B** : red/yellow - **2C** : red/blue - **2D** : red/white - **2E** : green/blue - **2F** : green/yellow - **2G** : green/white
2H : blue/yellow - **2I** : blue/white - **2K** : yellow/white

Illuminated 3 LEDs

3A : red/green/blue - **3B** : red/green/yellow - **3D** : red/green/white - **3E** : red/blue/yellow - **3F** : red/blue/white
3G : red/yellow/white - **3H** : green/blue/yellow - **3I** : green/blue/white - **3J** : green/yellow/white - **3K** : blue/yellow/white

* LED colour is indicated by the bottom of the product.

PBA series

Piezo switches Ø 19 (.748)

Overview

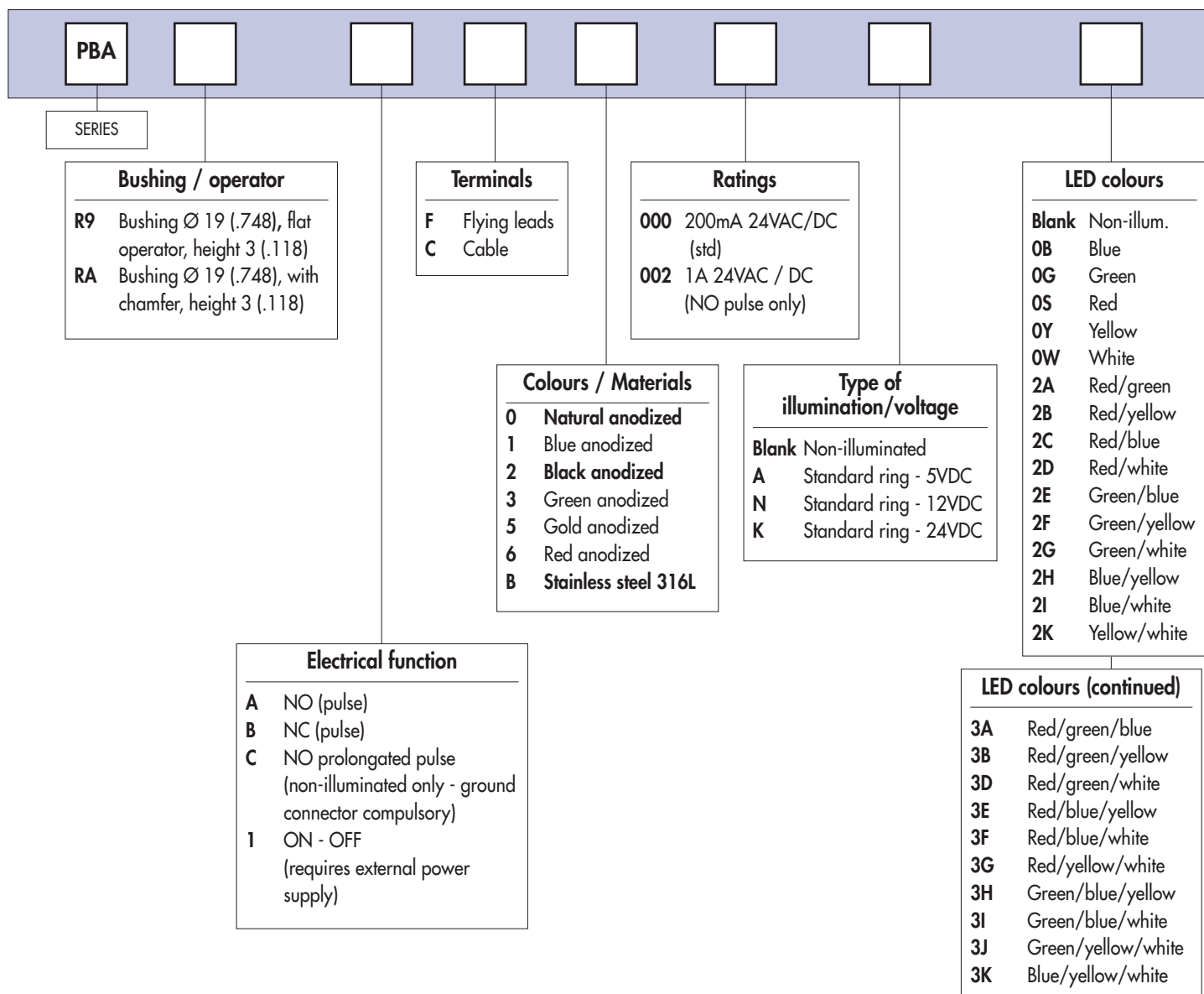

For options not listed above, please refer to our "Custom configurations" pages.



NOTICE : please note that not all combinations of above numbers are available. Refer to the following pages for further information.



Mounting accessories : standard hardware supplied : 1 hex nut U6450 (22 mm ac. flats) and 1 O-ring



Packaging unit : 20 pieces

PBA series

Piezo switches Ø 19 (.748)

Illuminated or non-illuminated

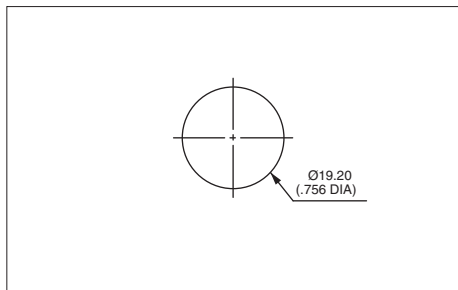

• Operator Ø 22 mm (.866)

Shown with flying lead terminals.

MODEL
STRUCTURE

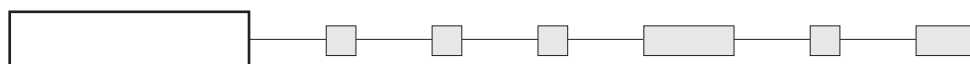

Non-illuminated - operator height 3 mm (.118)

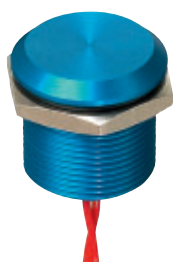

PBARAAF1000

Flat
PBAR9

With chamfer
PBARA

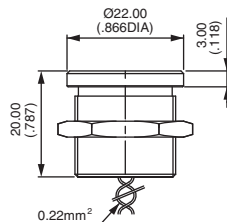

R9

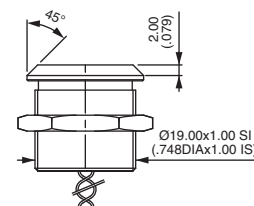

RA

With standard illuminated ring - operator height 3 mm



PBAR9AF0000A05

Flat
PBAR9

With chamfer
PBARA

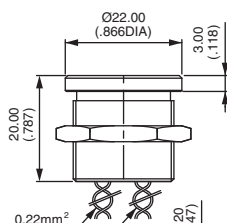

R9

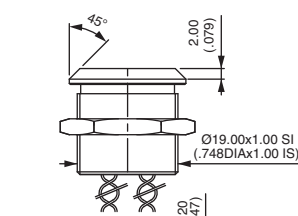

RA

Wire colours : see "Electrical functions" page.

ELECTRICAL FUNCTION

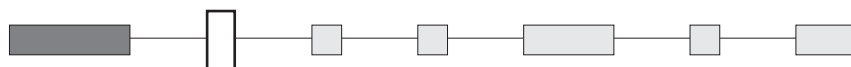

- A NO pulse
- B NC pulse
- C NO prolonged pulse (non-illuminated models only) - Ground connector U5736 compulsory, order separately.
- I ON - OFF - Requires external power supply.

PBA series

Piezo switches Ø 19 (.748)

Options

TERMINALS

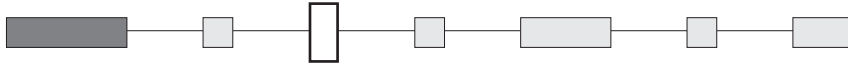

F Flying leads
C Cable

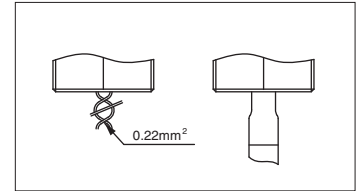

CASE COLOURS / MATERIALS

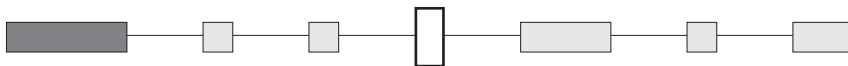

Code	Colour
0	Natural anodized aluminium
1	Blue anodized aluminium
2	Black anodised aluminium

Code	Colour
3	Green anodized aluminium
5	Gold anodized aluminium
6	Red anodised aluminium

Code	Colour
B	Stainless steel 316L

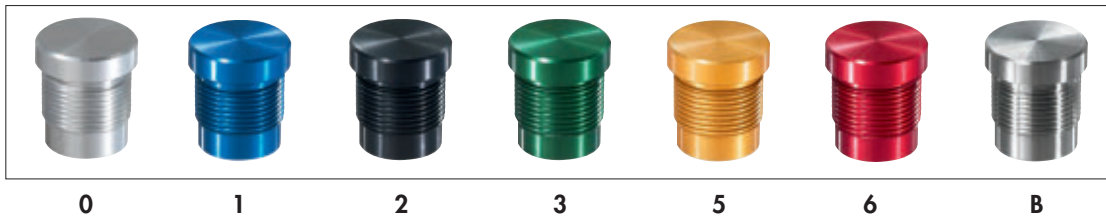

RATINGS

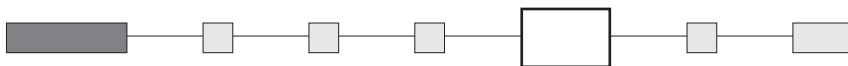

000 200mA 24VAC or DC (standard)
002 1A 24VAC or DC (NO pulse only)

TYPE OF ILLUMINATION / VOLTAGE

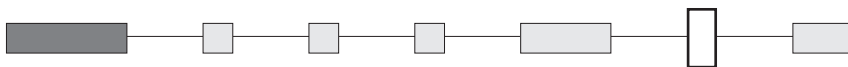

	5VDC	12VDC	24VDC
○	A	N	K

PBA series

Piezo switches Ø 19 (.748)

Options

LED COLOURS



Blank : non-illuminated



OB

OG

OS

OY

OW

Illuminated 1 LED *

OB : blue - **OG** : green - **OS** : red - **OY** : yellow - **OW** : white

Illuminated 2 LEDs

2A : red/green - **2B** : red/yellow - **2C** : red/blue - **2D** : red/white - **2E** : green/blue - **2F** : green/yellow - **2G** : green/white
2H : blue/yellow - **2I** : blue/white - **2K** : yellow/white

Illuminated 3 LEDs

3A : red/green/blue - **3B** : red/green/yellow - **3D** : red/green/white - **3E** : red/blue/yellow - **3F** : red/blue/white
3G : red/yellow/white - **3H** : green/blue/yellow - **3I** : green/blue/white - **3J** : green/yellow/white - **3K** : blue/yellow/white

* LED colour is indicated by the bottom of the product.

PBA series

Piezo switches Ø 22 (.866)

Overview

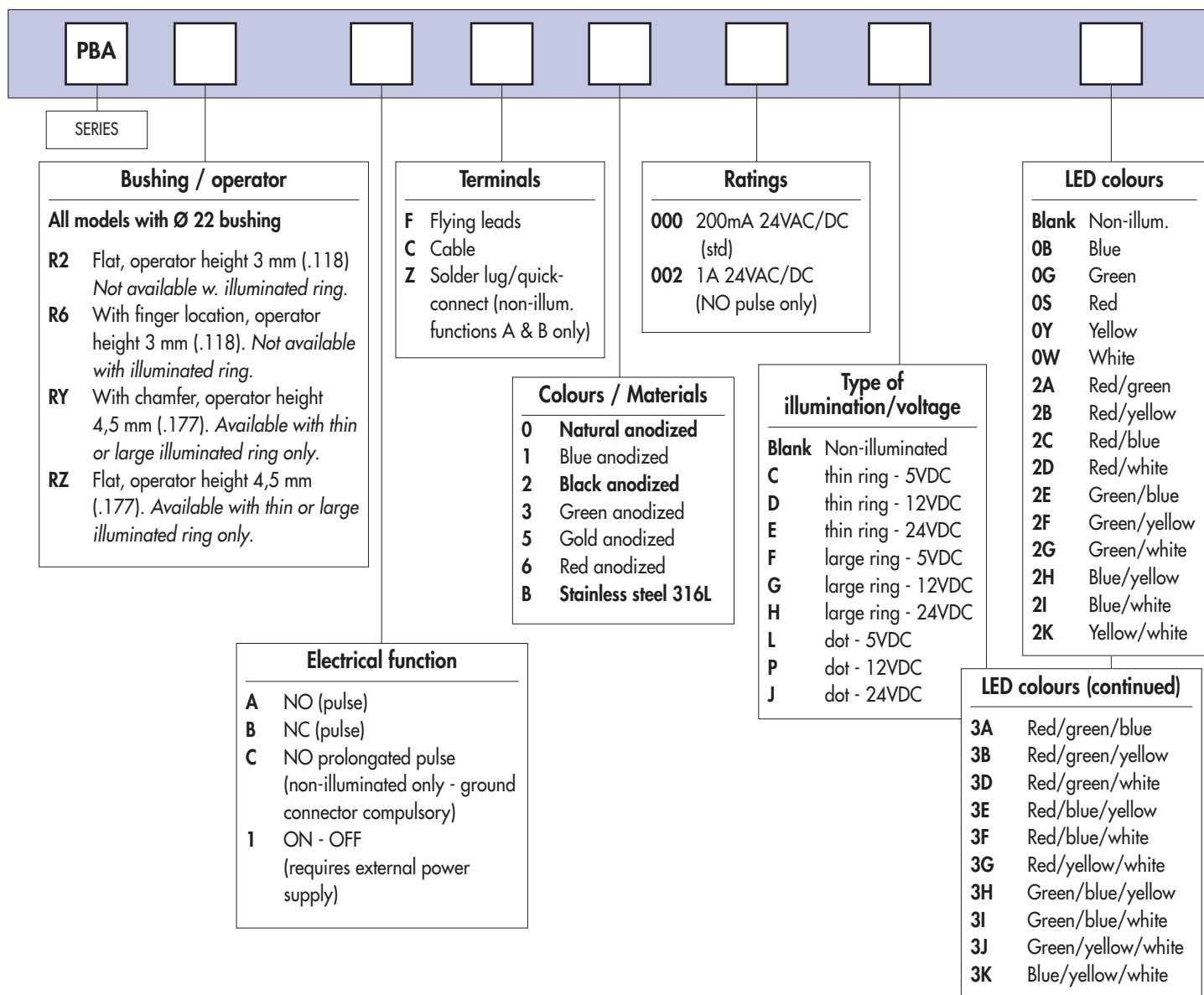

For options not listed above, please refer to our "Custom configurations" pages.



NOTICE : please note that not all combinations of above numbers are available. Refer to the following pages for further information.



Mounting accessories : standard hardware supplied : 1 hex nut U6440 (25 mm ac. flats) and 1 O-ring



Packaging unit : 20 pieces

PBA series

Piezo switches Ø 22 (.866)

Illuminated or non-illuminated

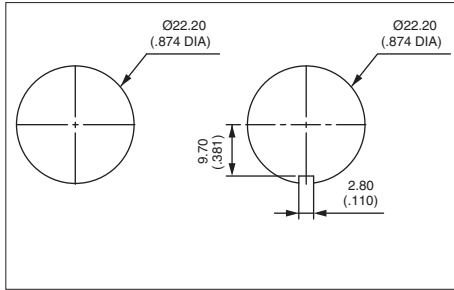

• Operator Ø 28 mm (1.102)

MODEL
STRUCTURE

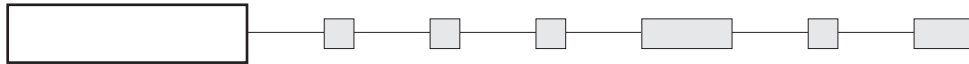

Wire colours : see "Electrical functions" page.

Non-illuminated - operator height 3 mm (.118)



PBAR2AF6000

Flat
PBAR2

With finger location
PBAR6

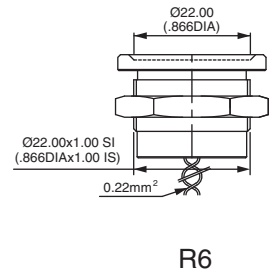
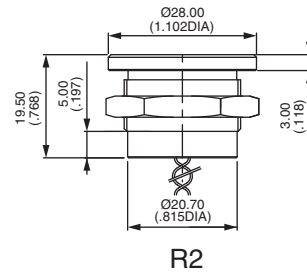

With illuminated dot - operator height 3 mm (.118)



PBAR6AF6000LOG

Flat
PBAR2

With finger location
PBAR6

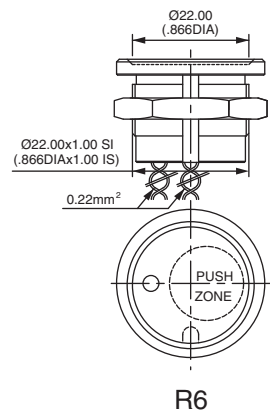
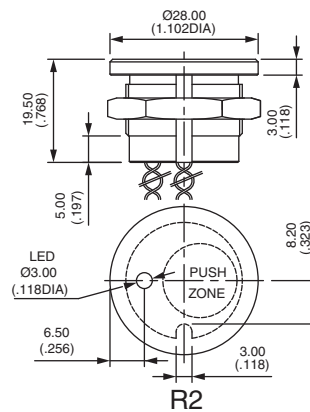

With thin illuminated ring - operator height 4,50 (.177)



PBARYAF0000COB

Flat
PBARZ

With chamfer
PBARY

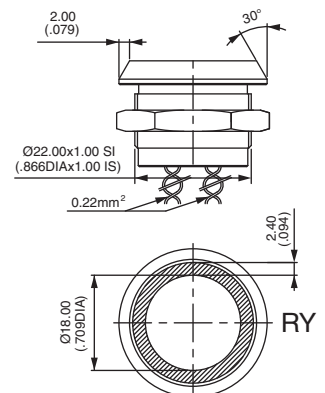
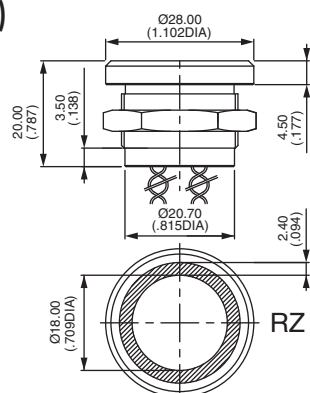

PBA series

Piezo switches Ø 22 (.866)

Illuminated or non-illuminated

With large illuminated ring - operator height 4,50 (.177)



PBARYAF0000FOB

Flat
PBARZ

With chamfer
PBARY

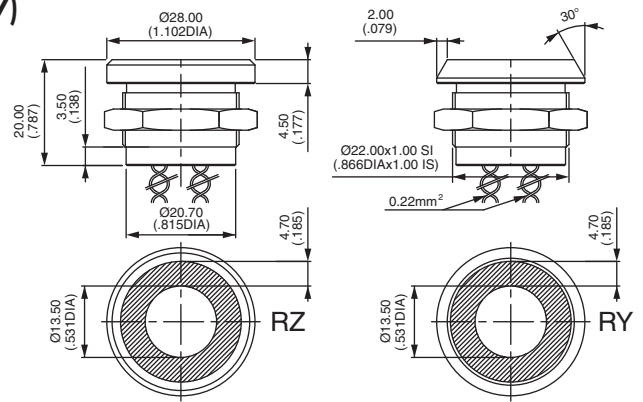

ELECTRICAL FUNCTION

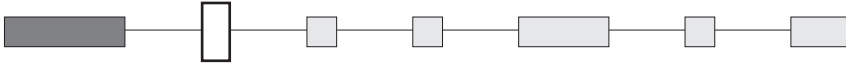

- A** NO pulse
- B** NC pulse
- C** NO prolonged pulse (non-illuminated only) - Ground connector U5737 compulsory, order separately.
- I** ON - OFF - Requires external power supply

TERMINALS

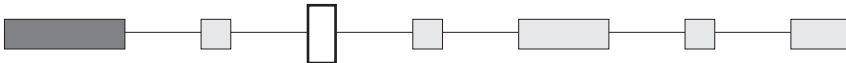

- F** Flying leads
- C** Cable
- Z** Solder lug / quick-connect (non-illuminated, functions A and B only)

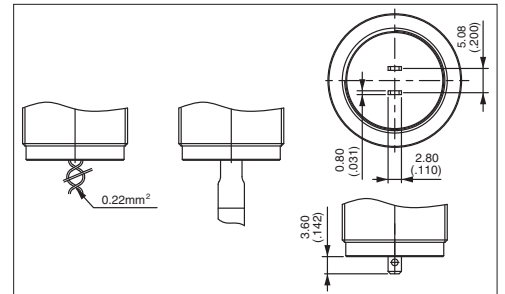

CASE COLOURS / MATERIALS



Code	Colour
0	Natural anodized aluminium
1	Blue anodized aluminium
2	Black anodised aluminium

Code	Colour
3	Green anodized aluminium
5	Gold anodized aluminium
6	Red anodised aluminium

Code	Colour
B	Stainless steel 316L



0 1 2 3 5 6 B

PBA series

Piezo switches Ø 22 (.866)

Options

RATINGS

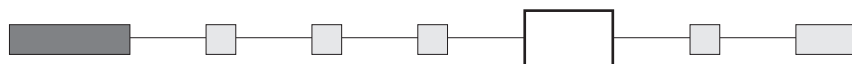

000 200mA 24VAC or DC (standard)
002 1A 24VAC or DC (NO pulse only)

TYPE OF ILLUMINATION / VOLTAGE

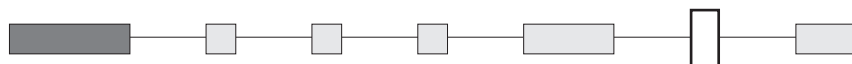

	5V	12V	24V
	C	D	E
	F	G	H
	L	P	J

LED COLOURS

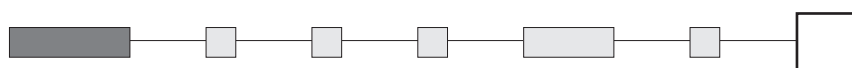

Integrated LED resistor

Blank : non-illuminated



OB

OG

OS

OY

OW

Illuminated 1 LED *

OB : blue - **OG** : green - **OS** : red - **OY** : yellow - **OW** : white

Illuminated 2 LEDs

2A : red/green - **2B** : red/yellow - **2C** : red/blue - **2D** : red/white - **2E** : green/blue - **2F** : green/yellow - **2G** : green/white
2H : blue/yellow - **2I** : blue/white - **2K** : yellow/white

Illuminated 3 LEDs

3A : red/green/blue - **3B** : red/green/yellow - **3D** : red/green/white - **3E** : red/blue/yellow - **3F** : red/blue/white
3G : red/yellow/white - **3H** : green/blue/yellow - **3I** : green/blue/white - **3J** : green/yellow/white - **3K** : blue/yellow/white

* LED colour is indicated by the bottom of the product.

PBA series

ATEX approved piezo switches

Distinctive features - Specifications - Overview



- Approved according to the ATEX 94/9/CE directive
- Sealed to IP66 (mounted on panel)
- Easy to clean metal surface
- Long life
- Illuminated models

ELECTRICAL SPECIFICATIONS

- Rated voltage : 5V to 24 VAC/DC max.
- Rated current : 200mA max. at 6VAC/DC
50mA max. at 24VAC/DC
(power limited to 1,2W for user group II)
- Contact resistance (ON) : 10Ω max.
- Insulation resistance (OFF) : 5MΩ min.
- Make impulse time : depending on actuating force and speed
- LED : 5VDC, 10mA to 20mA depending on model

MATERIALS

- Case : bright chrome plated brass or 316L stainless steel
- Terminals : multi-wire leads
0,22 mm², length 300 mm (11.81)

Standard hardware supplied: 1 hex nut U4116 (19 mm ac. flats), U6450 (22 mm ac. flats) or U6440 (25 mm ac. flats), 1 O-Ring and 1 ground connector U5735, U5736 or U5737.

GENERAL SPECIFICATIONS

- Operating force : 2 to 6N
- Torque : 2,5 Nm max.
- Life expectancy : 50 million cycles
- Operating temperature : -40°C to +55°C
- EMC compatibility according to EN 61058-1
- In accordance with EN 60079-0, EN 60079-11, EN 61241-0, EN 61241-11, EN 60079-26 and EN 50303
- Sealing : IP66 per IEC 60529 (switches mounted on panel)

Packaging units :

- bushing Ø 16 : 40 pieces
- illuminated bushing Ø 16 : 20 pieces
- bushing Ø 19 : 20 pieces
- bushing Ø 22 : 20 pieces

Instructions for use :

see instruction notice NTPBA006.

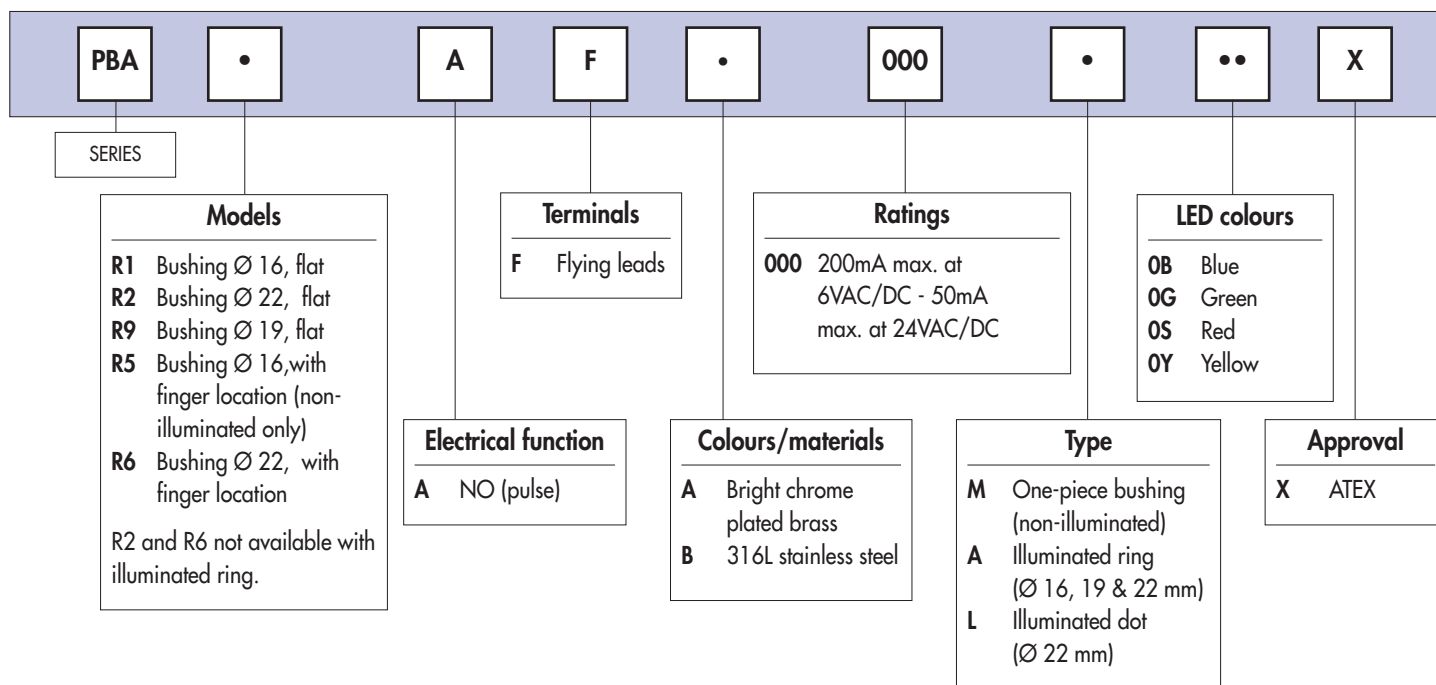

PBA series

ATEX approved piezo switches

Illuminated or non-illuminated



- Highest classifications
- Universal

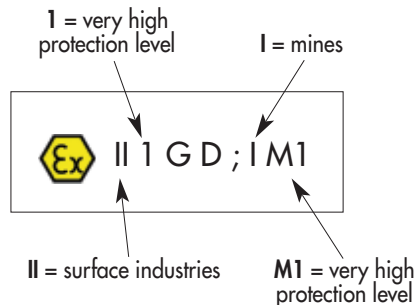

Dia. 16 (.630) bushing - illuminated ring



Stainless steel 316L, blue LED
PBAR1AFB000A0BX

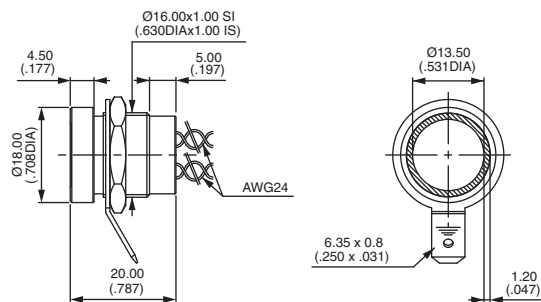

Dia. 19 (.748) bushing - illuminated ring



Stainless steel 316L, blue LED
PBAR9AFB000A0BX

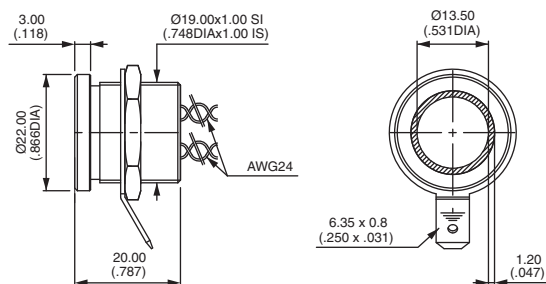

Dia. 22 (.866) bushing - non-illuminated



Stainless steel 316L
PBAR2AFB000MX

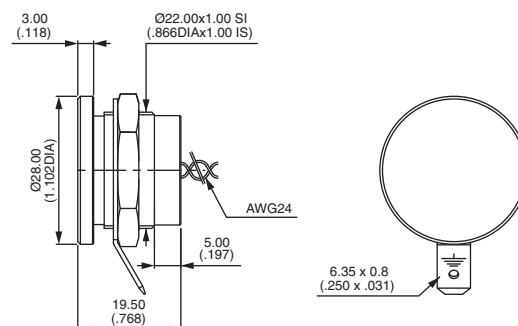

PBA series

ATEX approved piezo switches

Certificate



INERIS

(2) **Equipment or Protective Systems Intended for use
in Potentially explosive atmospheres
Directive 94/9/EC**

(1) **PRODUCTION QUALITY ASSURANCE
NOTIFICATION**

- (3) Notification number : INERIS 08ATEXQ408
- (4) Equipment or Components as listed : Electrical Equipment of categories 1 and M1 intended to be used in gaseous dust explosive atmospheres.
- (5) Manufacturer : APEM
55, avenue Edouard Herriot
BP 1
F-82303 CAUSSADE CEDEX
- (6) Place of production : APEM
55, avenue Edouard Herriot
BP 1
F-82303 CAUSSADE CEDEX
- (7) INERIS, notified body N°0080 for Annex IV in accordance with article 9 of the Council Directive 94/9/EC of 23 march 1994, notifies to the applicant that the actual manufacturer has a production quality system which complies to Annex IV of the Directive.
- (8) This notification is based on audit report N°P99823 issued on October 30th, 2008.
Results of periodical re-assessment of the quality system are a part of this notification.
- (9) This notification is valid until October 1st, 2011 and can be withdrawn if the manufacturer no longer satisfies the requirements of annex IV.
- (10) According to Article 10(1) of the Directive 94/9/EC, the CE marking shall be followed by the identification Number 0080 identifying the notified body involved in the production control stage.

Verneuil-en-Halatte, 2008.21.11



D Charpentier

The Director of the Organisation Certified,
By delegation
D. CHARPENTIER
Deputy Manager of Certification

This notification may only be reproduced in its entirety and without any change.

Folio 1 / 1

Parc Technologique Alata BP 2 F-60550 Verneuil-en-Halatte

tél + 33(0)3 44 55 66 77 fax + 33(0)3 44 55 66 99 internet www.ineris.fr

Institut national de l'environnement industriel et des risques

Etablissement public à caractère industriel et commercial - RCS Senlis B 381 984 921 - Siret 381 984 921 00019 - APE 743B

PBA series

Piezo switches

Main applications



Shower
(IP68 sealing)



Home automation
(design, customization)



Bath
(IP68 sealing, customization)



Car wash
(IP68 sealing, long life)



Marine
(IP68 sealing, design)



Medical
(easy to clean surface, no retention area)



Food processing
(IP69K sealing)



Mining
(ATEX versions)

APEM, a world of switching capabilities

The APEM group is one of the world's largest manufacturers of switches, LED indicators, joysticks and switch panels.

APEM manufactures switch products for multiple industrial markets including: instrumentation, medical, security, communications, industrial automation, military and transport.

Other APEM metallic products



Stainless steel keypads

Stainless steel keypads and keyboards are particularly resistant to harsh environments: extreme climatic conditions, vandalism, stains... They meet EMC international standards and feature good tactile feedback and IP65 front face sealing.



Custom switch panels

APEM provides custom solutions to specific panel requirements. Custom panels incorporate several technologies such as LED illumination and backlighting, ESD and EMC protection, IP67 sealing, custom mounting...

Applications for these products include transport and utility vehicles, agricultural equipment and boats.



AV pushbutton switches

The AV series is a range of very robust pushbutton switches consisting of 2 families: anti-vandal and security pushbutton switches. This range features a large variety of models, with different bushing diameters, numerous materials and many electrical functions. Marking and illumination options are also available.

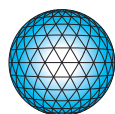

APEM