



## Technical Data Sheet

### 1.5mm Side Looking Phototransistor

---

#### PT928-6C

#### Features

- Fast response time
- High sensitivity
- Small junction capacitance
- Pb free
- The product itself will remain within RoHS compliant version.

#### Descriptions

PT928-6C is a phototransistor in miniature package which is molded in a water clear plastic with spherical top view lens. The device is spectrally matched to infrared emitting diode.



#### Applications

- Optoelectronic switch
- VCR , Video Camera
- Floppy disk drive
- Infrared applied system

#### Device Selection Guide

LED Part No.	Chip	Lens Color
	Material	
PT	Silicon	Water Clear

**Package Dimensions**

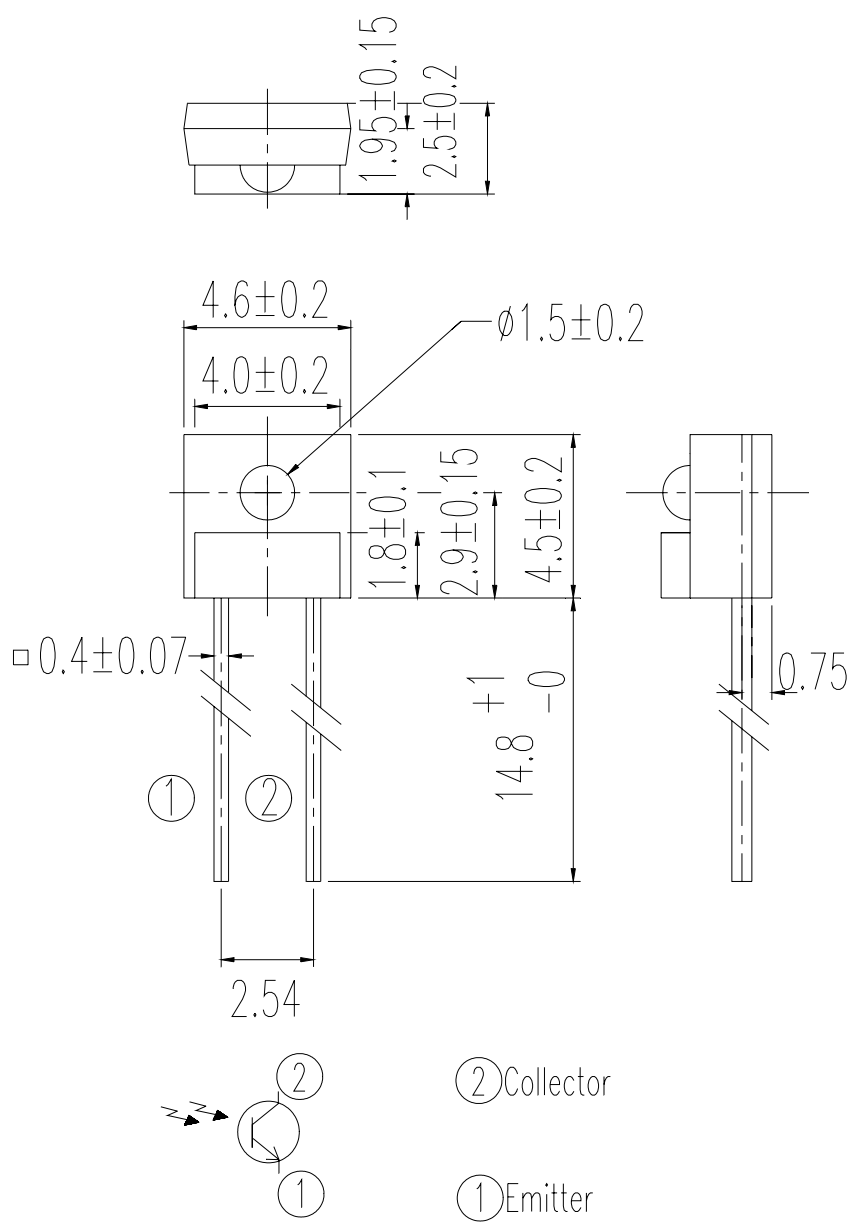

- Notes:**
1. All dimensions are in millimeters
  2. Tolerances unless dimensions  $\pm 0.1$  mm

### Absolute Maximum Ratings (Ta=25°C)

Parameter	Symbol	Rating	Units
Collector-Emitter Voltage	V <sub>CEO</sub>	30	V
Emitter-Collector-Voltage	V <sub>ECO</sub>	5	V
Collector Current	I <sub>C</sub>	20	mA
Operating Temperature	T <sub>opr</sub>	-25 ~ +85°C	°C
Storage Temperature	T <sub>stg</sub>	-40 ~ +85°C	°C
Lead Soldering Temperature	T <sub>sol</sub>	260	°C
Power Dissipation at (or below) 25°C Free Air Temperature	P <sub>c</sub>	75	mW

**Notes:** \*1:Soldering time ≤ 5 seconds.

### Electro-Optical Characteristics (Ta=25°C)

Parameter	Symbol	Condition	Min.	Typ.	Max.	Units
Collector-Emitter Saturation Voltage	V <sub>CE(sat)</sub>	I <sub>C</sub> =2mA Ee=1mW/cm <sup>2</sup>	---	---	0.4	V
Rise Time	t <sub>r</sub>	V <sub>CE</sub> =5V I <sub>C</sub> =1mA	---	15	---	μS
Fall Time	t <sub>f</sub>	RL=1000Ω	---	15	---	
Collector Dark Current	I <sub>CEO</sub>	Ee=0mW/cm <sup>2</sup> V <sub>CE</sub> =20V	---	---	100	nA
On State Collector Current	I <sub>C(on)</sub>	Ee=0.555mW/cm <sup>2</sup> V <sub>CE</sub> =5V	0.52		3.48	mA
Wavelength of Peak Sensitivity	λ <sub>p</sub>	---	---	860	---	nm
Rang of Spectral Bandwidth	λ <sub>0.5</sub>	---	400	---	1200	nm

### Typical Electro-Optical Characteristics Curves

Fig.1 Collector Power Dissipation vs. Ambient Temperature

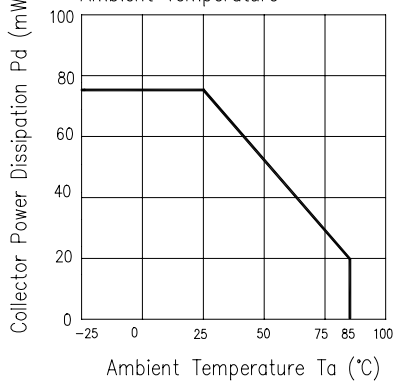

Fig.2 Collector Dark Current vs. Ambient Temperature

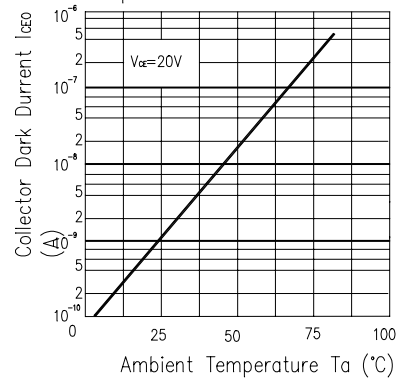

Fig.3 Relative Collector Current vs. Ambient Temperature

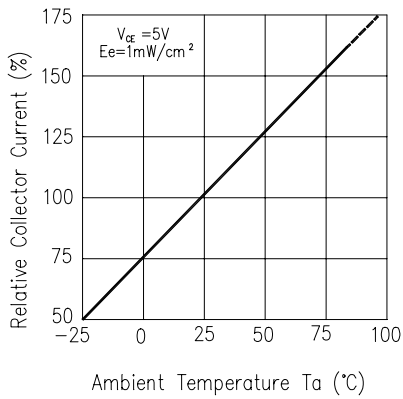

Fig.4 Collector Current vs. Irradiance

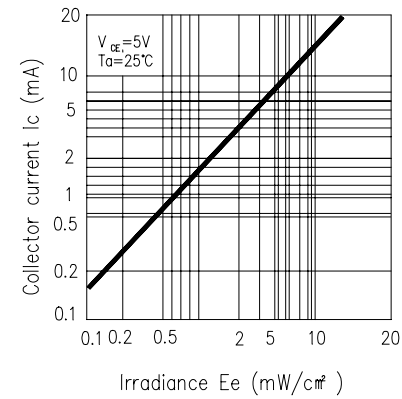

Fig.5 Spectral Sensitivity

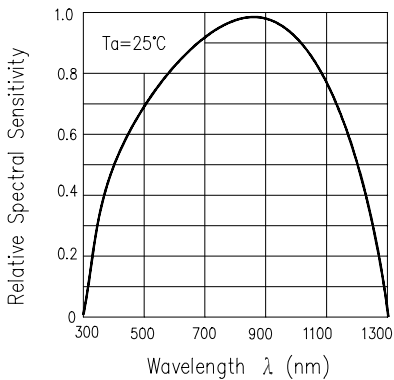
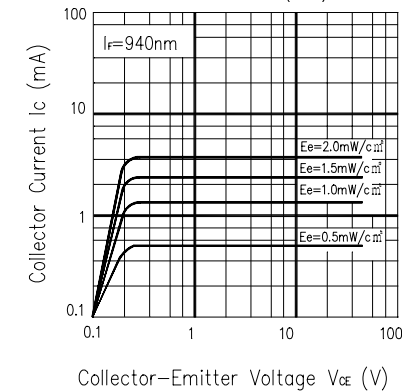

Fig.6 Collector Current vs. Collector Current I\_c (mA)



### Reliability Test Item And Condition

The reliability of products shall be satisfied with items listed below.

Confidence level : 90%

LTPD : 10%

NO.	Item	Test Conditions	Test Hours/ Cycles	Sample Sizes	Failure Judgement Criteria	Ac/Re
1	Solder Heat	TEMP:260°C±5°C	10sec	22pcs	More than 90% of lead to be covered by soldering	0/1
2	Temperature Cycle	H : +85°C    30mins ↕ 5mins L : -55°C    30mins	50Cycle	22pcs		0/1
3	Thermal Shock	H :+100°C    5mins ↕ 10secs L :-10°C    5mins	50Cycle	22pcs	I <sub>R</sub> ≥ U×2 E <sub>e</sub> ≤ L×0.8 V <sub>F</sub> ≥ U×1.2	0/1
4	High Temperature Storage	TEMP. : +100°C	1000hrs	22pcs		U : Upper
5	Low Temperature Storage	TEMP. : -55°C	1000hrs	22pcs	Specification Limit	0/1
6	DC Operating Life	V <sub>CE</sub> =5V	1000hrs	22pcs	L : Lower Specification Limit	0/1
7	High Temperature/ High Humidity	85°C / 85% R.H	1000hrs	22pcs		0/1