

# Zoom 6000

## High Mag Zoom Lens



- Dynamic magnification range of 0.09-393X offers incredible versatility.
- High contrast images and vivid colors help your equipment perform better.
- 0.01-125.68 mm field coverage allows you to view a wide range of parts.
- Working distance can be varied from 34 to 390 mm.
- Add infinity corrected objective lenses to achieve unmatched edge flatness and clarity.

# Zoom 6000



## Flexibility by Design

### A Workhorse to Fit Nearly Any Application

With a diverse selection of body tubes, accessory optics, motorized configurations, and lighting techniques, the Zoom 6000 is Navitar's workhorse with unbeatable versatility. This modular zoom lens system incorporates Navitar's world-renowned optics. This "building block design" can be configured to fit nearly any application.

### 6.5:1 Zoom Ratio, Long Working Distance and Large Field of View

The parfocal optical system of the Zoom 6000 has a 6.5:1 zoom ratio, a 0.7X to 4.5X zoom range, and total magnification (depending on lens adapters and attachments used) of 0.09X to 393X. The working distance can be varied from 34 mm (1.3") to 390 mm (15.4"). The achievable field of view can vary from 0.01 mm to 125.68 mm.



### Unsurpassed Optical Performance

The optical system of the Zoom 6000 produces images of the finest optical quality. Chromatic aberration and distortion have been virtually eliminated. With the Zoom 6000 lenses, images are crisp and clear and display optimum contrast with minimum flare over the entire field of view.

### Manual or Detented for Calibrated Repeatability

The Zoom 6000 lenses are available in a manual design, as well as a detented version for calibrated repeatability.

### Motorized for Automation

If you are building highly automated systems, Navitar can offer you a wide selection of motorized lenses and control equipment. Please see the motorized section of the catalog.

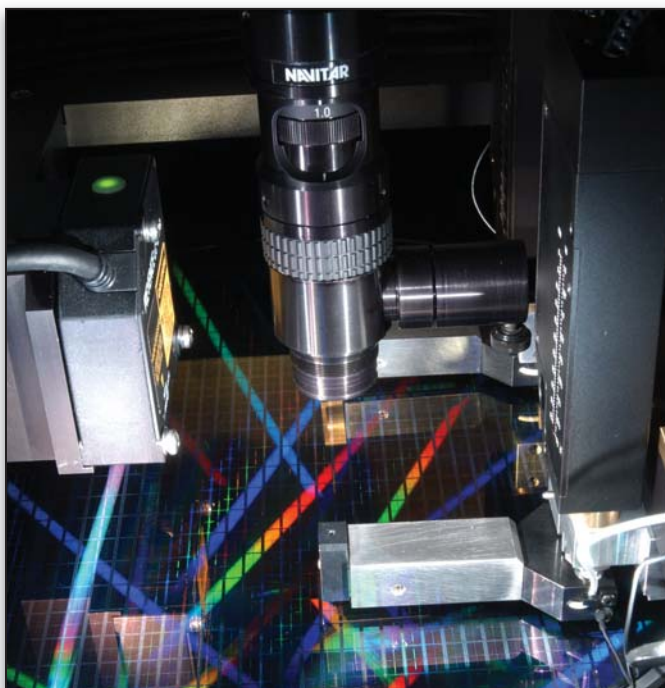

## Key Terms for Matrix Charts

### Depth of Field

The distance allowing acceptable image definition to be maintained without refocusing.

### Distortion

Distortion is a variation in magnification across the field of view.

### Field

Field of view for respective camera format (normally measured diagonally).

### Magnification

A measure of the apparent differences in size between the object and image.

### Matching Pixel Size

Matching pixel size is that which will permit the minimum feature size to overlap two pixels.

### MTF (lp/mm)

A measurement of the ability of an optical system to reproduce (transfer) various levels of detail from the object to the image, as shown by the degree of contrast (modulation) in the image.

### N.A. Image (high or low mag.)

Measurement at the image point of the largest cone of light rays that are exiting the optical system.

### N.A. Object (high or low mag.)

Measurement at the object point of the largest cone or number of light rays that are entering the optical system.

### Object to Image Distance (O-I)

Total distance from the object to the sensor inside the camera.

### Resolvable Features (microns)

Measurement of lens system's ability to image closely spaced points, lines and object surfaces as separate entities.

### Working Distance (W.D.)

Clearance between object and lowest mechanical part of the system.

# Zoom 6000 System Diagram .....

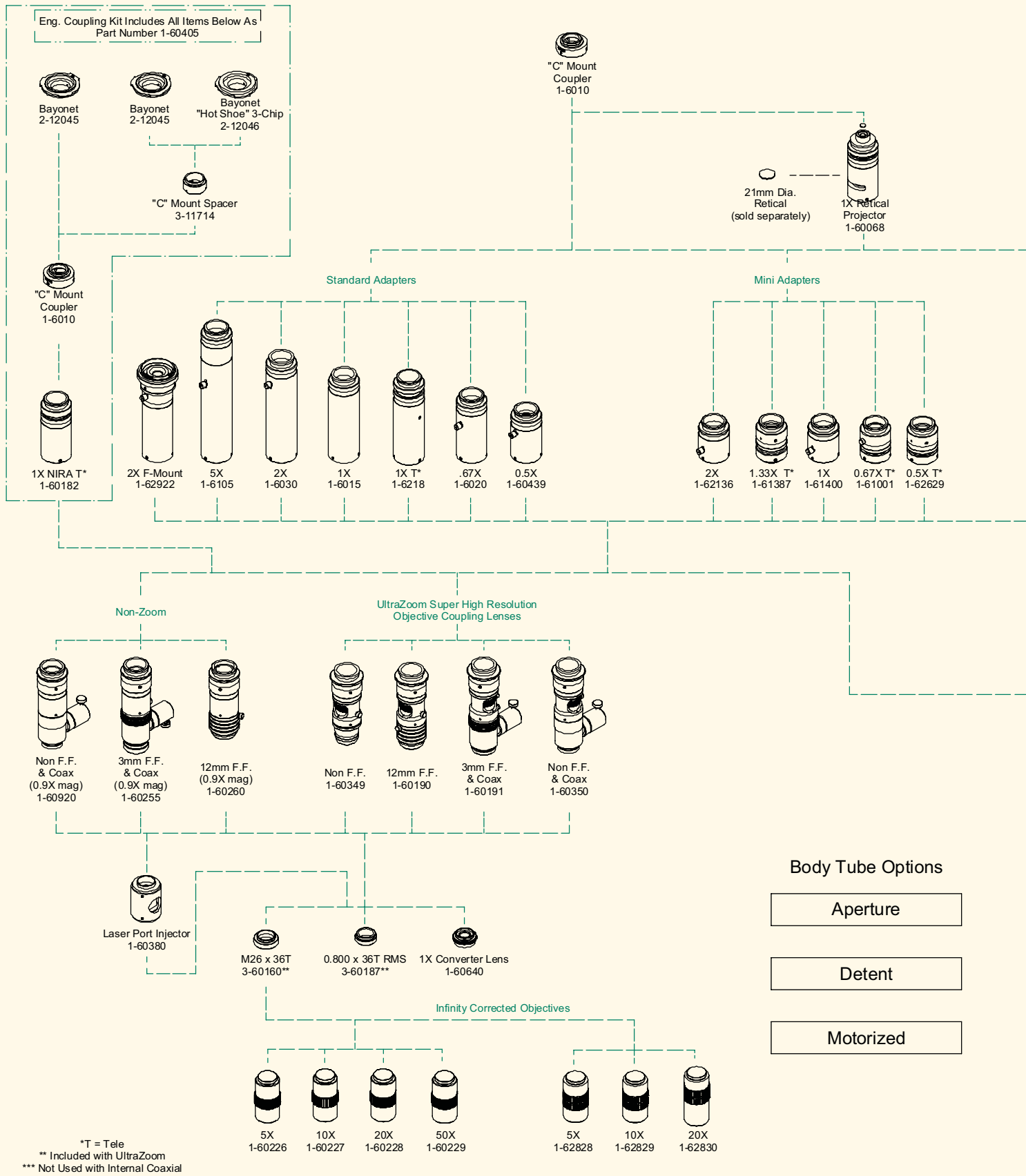

23mm  
Microscope  
Eye Piece  
(sold separately)



Eye Piece Holder  
1-6050

Adapter Plates

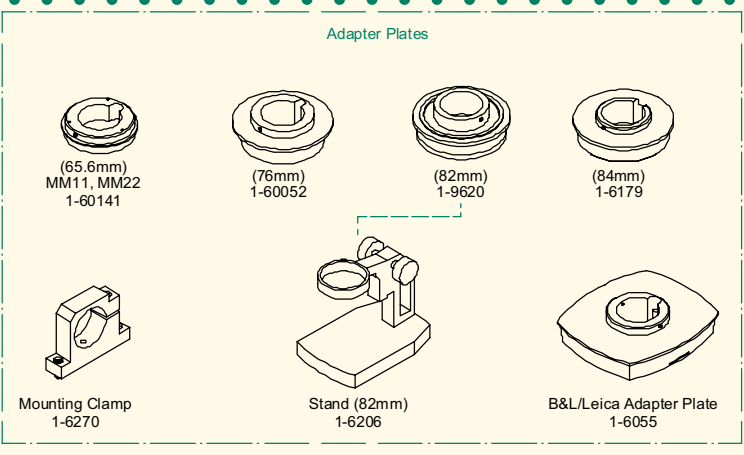

(65.6mm) MM11, MM22  
1-60141

(76mm)  
1-60052

(82mm)  
1-9620

(84mm)  
1-6179

Mounting Clamp  
1-6270

Stand (82mm)  
1-6206

B&L/Leica Adapter Plate  
1-6055

Short Adapters

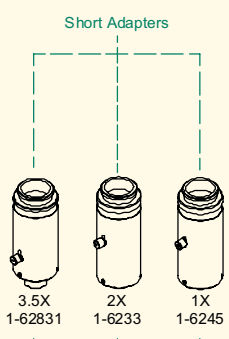

3.5X  
1-62831

2X  
1-6233

1X  
1-6245

Non-Inv. Right Angle Adapters

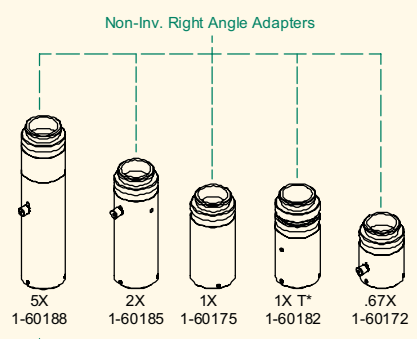

5X  
1-60188

2X  
1-60185

1X  
1-60175

1X T\*  
1-60182

.67X  
1-60172

Right Angle Adapters

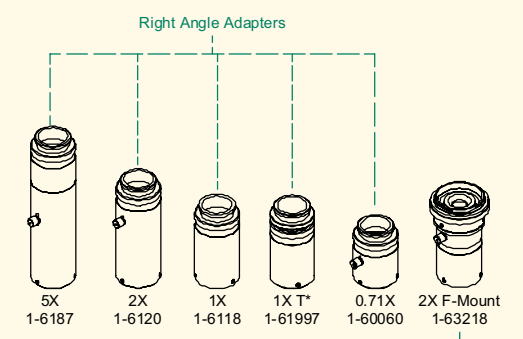

5X  
1-6187

2X  
1-6120

1X  
1-6118

1X T\*  
1-61997

0.71X  
1-60060

2X F-Mount  
1-63218

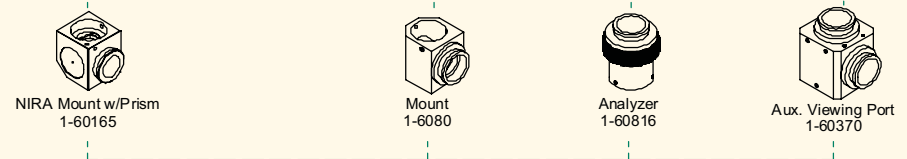

NIRA Mount w/Prism  
1-60165

Mount  
1-6080

Analyzer  
1-60816

Aux. Viewing Port  
1-60370

Zoom Lenses

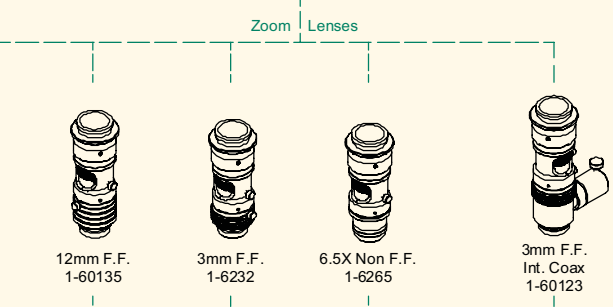

12mm F.F.  
1-60135

3mm F.F.  
1-6232

6.5X Non F.F.  
1-6265

3mm F.F.  
Int. Coax  
1-60123

NIRA Viewers\*\*\*

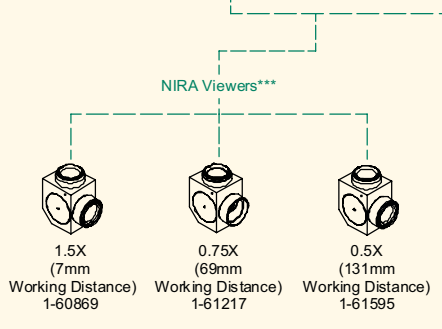

1.5X  
(7mm  
Working Distance)  
1-60869

0.75X  
(69mm  
Working Distance)  
1-61217

0.5X  
(131mm  
Working Distance)  
1-61595

Lens Attachments

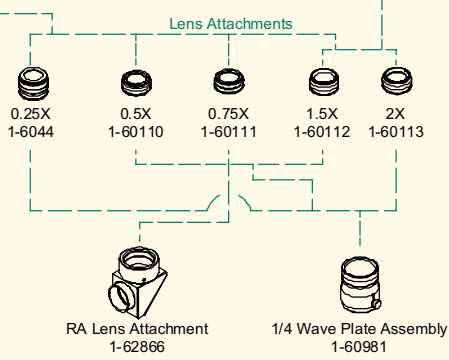

0.25X  
1-6044

0.5X  
1-60110

0.75X  
1-60111

1.5X  
1-60112

2X  
1-60113

RA Lens Attachment  
1-62866

1/4 Wave Plate Assembly  
1-60981

Rev. 031708



# Zoom 6000

## Zoom 6000 Field of View Matrix (in mm at nominal W.D.)

Lens Attachment	W.D. (mm)	Camera Format/Parameters	.5X Adapter Low - High	.67X Adapter Low - High	1X Adapter Low - High	1.33X Adapter Low - High	2X Adapter Low - High	3.5X Adapter Low - High	5X Adapter Low - High	Resolve Limit (microns) Low-High	Depth of Field (mm) Low-High
0.25X 0.006 - 0.018 1-6044	356 (nominal)  220-390 (1) W.D. range	Mag.	0.09X - 0.56X	0.12X - 0.75X	0.18X - 1.13X	.24X - 1.5X	0.35X - 2.25X	.63X - 3.95X	0.88X - 5.62X	27.78 - 9.26	13.89 - 1.54
		Field 1/4"	45.70 - 7.12	34.03 - 5.33	22.85 - 3.56	17.18 - 2.68	11.42 - 1.78	6.53 - 1.02	4.54 - 0.72	27.78 - 9.26	13.89 - 1.54
		Field 1/3"	68.64 - 10.64	51.12 - 8.04	34.32 - 5.32	25.80 - 4.0	17.16 - 2.66	9.8 - 1.52	6.88 - 1.08	27.78 - 9.26	13.89 - 1.54
		Field 1/2"	91.36 - 14.16	68.06 - 10.66	45.68 - 7.08	34.34 - 5.32	22.84 - 3.54	13.05 - 2.02	9.12 - 1.44	27.78 - 9.26	13.89 - 1.54
		Field 2/3"	91.40 - 19.52	93.62 - 14.66	62.84 - 9.76	47.25 - 7.34	31.42 - 4.88	17.95 - 2.79	12.56 - 1.96	27.78 - 9.26	13.89 - 1.54
0.5X 0.011 - 0.035 1-60110	175 (nominal)  143-187 (1) W.D. range	Mag.	0.18X - 1.13X	0.24X - 1.50X	0.35X - 2.25X	.46X - 2.99X	0.70X - 4.50X	1.22X - 7.87X	1.75X - 11.25X	15.15 - 4.76	4.13 - 0.41
		Field 1/4"	22.85 - 3.56	17.02 - 2.66	11.42 - 1.78	8.59 - 1.34	5.71 - 0.89	3.26 - .51	2.28 - 0.36	15.15 - 4.76	4.13 - 0.41
		Field 1/3"	34.32 - 5.32	25.56 - 4.0	17.16 - 2.67	12.90 - 2.01	8.58 - 1.33	4.90 - 0.76	3.43 - 0.53	15.15 - 4.76	4.13 - 0.41
		Field 1/2"	45.68 - 7.08	34.03 - 5.33	22.85 - 3.56	17.18 - 2.68	11.42 - 1.77	6.58 - 1.02	4.57 - 0.71	15.15 - 4.76	4.13 - 0.41
		Field 2/3"	45.70 - 9.76	46.81 - 7.33	31.43 - 4.89	23.63 - 3.68	15.71 - 2.44	8.98 - 1.40	6.29 - 0.98	15.15 - 4.76	4.13 - 0.41
0.75X 0.017 - 0.053 1-60111	113 (nominal)  100-119 (1) W.D. range	Mag.	0.27X - 1.69X	0.35X - 2.25X	0.53X - 3.38X	.70X - 4.49X	1.05X - 6.75X	1.85X - 11.83X	2.63X - 16.88X	9.80 - 3.14	1.73-0.18
		Field 1/4"	15.22 - 2.38	11.34 - 1.78	7.61 - 1.19	5.72 - .89	3.81 - 0.59	2.17 - .34	1.52 - 0.24	9.80 - 3.14	1.73-0.18
		Field 1/3"	22.86 - 3.56	17.04 - 2.67	11.43 - 1.78	8.59 - 1.34	5.72 - 0.89	3.26 - .51	2.29 - 0.35	9.80 - 3.14	1.73-0.18
		Field 1/2"	30.46 - 4.74	22.69 - 3.56	15.23 - 2.37	11.45 - 1.78	7.62 - 1.19	4.35 - .68	3.05 - 0.47	9.80 - 3.14	1.73-0.18
		Field 2/3"	30.50 - 6.52	31.21 - 4.89	20.95 - 3.26	15.75 - 2.45	10.48 - 1.63	5.98 - .93	4.19 - 0.65	9.80 - 3.14	1.73-0.18
None 0.023 - 0.071	92 (nominal)  81-93 (1) W.D. range	Mag.	0.35X - 2.25X	0.47X - 3.00X	0.70X - 4.50X	.93X - 5.89X	1.40X - 9.00X	2.45X - 15.75X	3.50X - 22.50X	7.25 - 2.35	0.95 - 0.10
		Field 1/4"	11.42 - 1.78	8.51 - 1.33	5.71 - 0.89	4.29 - .67	2.86 - 0.45	1.63 - .25	1.14 - 0.18	7.25 - 2.35	0.95 - 0.10
		Field 1/3"	17.16 - 2.67	12.77 - 2.01	8.58 - 1.33	6.45 - 1.0	4.29 - 0.67	2.45 - .38	1.72 - 0.27	7.25 - 2.35	0.95 - 0.10
		Field 1/2"	22.85 - 3.56	17.01 - 2.67	11.42 - 1.77	8.59 - 1.33	5.71 - 0.89	3.26 - .50	2.28 - 0.36	7.25 - 2.35	0.95 - 0.10
		Field 2/3"	22.90 - 4.89	23.40 - 3.65	15.71 - 2.44	11.81 - 1.83	7.86 - 1.22	4.49 - .70	3.14 - 0.49	7.25 - 2.35	0.95 - 0.10
1.5X 0.034 - 0.106 1-60112	51 (nominal)  48-52 (1) W.D. range	Mag.	0.53X - 3.38X	0.71X - 4.50X	1.05X - 6.75X	1.40 - 8.98	2.10X - 13.50X	3.67X - 23.62X	5.25X - 33.75X	4.90 - 1.57	0.43 - 0.04
		Field 1/4"	7.61 - 1.19	5.67 - 0.89	3.81 - 0.59	2.86 - .44	1.91 - 0.30	1.09 - .17	0.76 - 0.12	4.90 - 1.57	0.43 - 0.04
		Field 1/3"	11.43 - 1.78	8.52 - 1.33	5.72 - 0.89	4.3 - .67	2.86 - 0.44	1.63 - .25	1.14 - 0.18	4.90 - 1.57	0.43 - 0.04
		Field 1/2"	15.23 - 2.37	11.34 - 1.77	7.62 - 1.19	5.73 - .89	3.81 - 0.59	2.18 - .34	1.52 - 0.24	4.90 - 1.57	0.43 - 0.04
		Field 2/3"	15.00 - 3.26	15.60 - 2.44	10.48 - 1.63	7.88 - 1.22	5.24 - 0.81	2.99 - .46	2.10 - 0.33	4.90 - 1.57	0.43 - 0.04
2.0X 0.040 - 0.142 1-60113	36 (nominal)  34-37 (1) W.D. range	Mag.	0.70X - 4.50X	0.94X - 6.00X	1.40X - 9.00X	1.86X - 11.97X	2.80X - 18.00X	4.9X - 31.5X	7.00X - 45.00X	3.62 - 1.17	0.24 - 0.02
		Field 1/4"	5.71 - 0.89	4.26 - 0.67	2.86 - 0.45	2.15 - .34	1.43 - 0.23	.82 - .13	0.57 - 0.09	3.62 - 1.17	0.24 - 0.02
		Field 1/3"	8.58 - 1.33	6.39 - 1.00	4.29 - 0.67	3.22 - .50	2.15 - 0.33	1.22 - .19	0.86 - 0.13	3.62 - 1.17	0.24 - 0.02
		Field 1/2"	11.42 - 1.77	8.51 - 1.33	5.71 - 0.89	4.29 - .67	2.86 - 0.44	1.63 - .25	1.14 - 0.18	3.62 - 1.17	0.24 - 0.02
		Field 2/3"	11.40 - 2.44	11.70 - 1.83	7.86 - 1.22	5.91 - .92	3.93 - 0.61	2.24 - .35	1.57 - 0.24	3.62 - 1.17	0.24 - 0.02

### NOTES:

The above fields of view are measured diagonally in millimeters (Horizontal = Diagonal x 0.8 and Vertical = Diagonal x 0.6).

(1) Working distance range when using 12 mm fine focus. Field of view will change with shorter or longer working distances.

N.A. varies depending in system magnification.

# Zoom 6000 System Dimensions

\*All measurements are in mm unless otherwise specified.

Navitar offers a wide variety of lenses, adapters and attachments. Dimensions of a few examples are provided here. For a complete listing of lens dimensions, please visit [www.machinevision.navitar.com](http://www.machinevision.navitar.com).

## Lenses\*

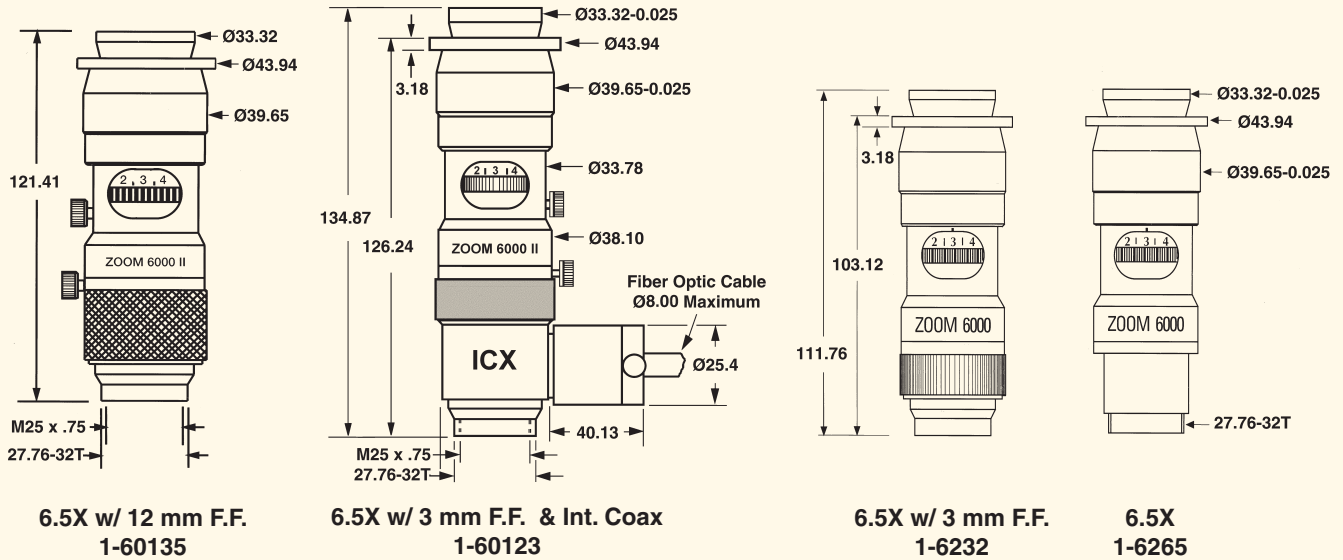

## Adapters\*

All adapters have a diameter of  $\text{Ø}40.64$  mm ( $\text{Ø}1.600$  inches)

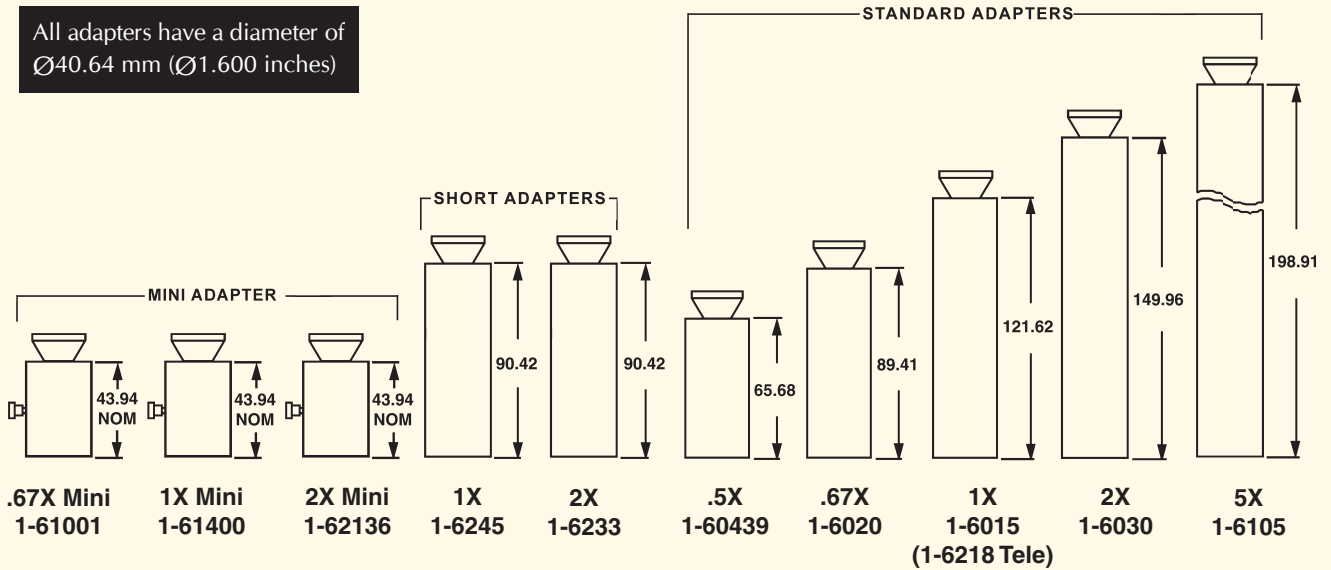

## Attachments\*

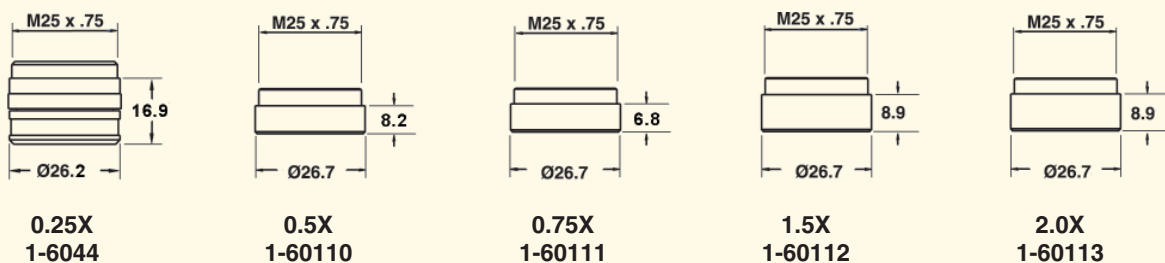

## Zoom 6000 Performance Specifications

Zoom 6000 Combinations Lens Attachment + Prime Lens + Adapter	W.D.	System Magnification		N.A.-obj-		Resolve Limit (microns)		Matching Pixel Size (microns)		Depth of Field	
		Low Mag.	High Mag.	Low Mag.	High Mag.	Low Mag.	High Mag.	Low Mag.	High Mag.	Low Mag.	High Mag.
0.25x + 6.5X Zoom + 0.5x	356	0.09	0.56	0.006	0.018	27.78	9.26	2.50	5.19	13.89	1.54
0.25x + 6.5X Zoom + 0.67x	356	0.12	0.75	0.006	0.018	27.78	9.26	3.33	6.95	13.89	1.54
0.25x + 6.5X Zoom + 1.0x	356	0.18	1.13	0.006	0.018	27.78	9.26	5.00	10.46	13.89	1.54
0.25x + 6.5X Zoom + 1.33x	356	0.23	1.51	0.006	0.018	27.78	9.26	6.65	13.91	13.89	1.54
0.25x + 6.5X Zoom + 2.0x	356	0.35	2.25	0.006	0.018	27.78	9.26	9.72	20.84	13.89	1.54
0.25x + 6.5X Zoom + 3.5x	356	0.61	3.98	0.006	0.018	27.78	9.26	17.50	36.61	13.89	1.54
0.25x + 6.5X Zoom + 5.0x	356	0.88	5.62	0.006	0.018	27.78	9.26	24.45	52.04	13.89	1.54
0.5x + 6.5X Zoom + 0.5x	175	0.18	1.13	0.011	0.035	15.15	4.76	2.73	5.38	4.13	0.41
0.5x + 6.5X Zoom + 0.67x	175	0.23	1.50	0.011	0.035	15.15	4.76	3.48	7.14	4.13	0.41
0.5x + 6.5X Zoom + 1.0x	175	0.35	2.25	0.011	0.035	15.15	4.76	5.30	10.71	4.13	0.41
0.5x + 6.5X Zoom + 1.33x	175	0.47	3.03	0.011	0.035	15.15	4.76	7.05	14.24	4.13	0.41
0.5x + 6.5X Zoom + 2.0x	175	0.70	4.50	0.011	0.035	15.15	4.76	10.61	21.42	4.13	0.41
0.5x + 6.5X Zoom + 3.5x	175	1.22	7.93	0.011	0.035	15.15	4.76	18.55	37.49	4.13	0.41
0.5x + 6.5X Zoom + 5.0x	175	1.75	11.25	0.011	0.035	15.15	4.76	26.51	53.55	4.13	0.41
0.75x + 6.5X Zoom + 0.5x	113	0.26	1.69	0.017	0.053	9.80	3.14	2.55	5.32	1.73	0.18
0.75x + 6.5X Zoom + 0.67x	113	0.35	2.25	0.017	0.053	9.80	3.14	3.43	7.08	1.73	0.18
0.75x + 6.5X Zoom + 1.0x	113	0.53	3.38	0.017	0.053	9.80	3.14	5.20	10.63	1.73	0.18
0.75x + 6.5X Zoom + 1.33x	113	0.70	4.54	0.017	0.053	9.80	3.14	6.92	14.13	1.73	0.18
0.75x + 6.5X Zoom + 2.0x	113	1.05	6.75	0.017	0.053	9.80	3.14	10.30	21.23	1.73	0.18
0.75x + 6.5X Zoom + 3.5x	113	1.86	12.06	0.017	0.053	9.80	3.14	18.20	37.21	1.73	0.18
0.75x + 6.5X Zoom + 5.0x	113	2.63	16.88	0.017	0.053	9.80	3.14	25.74	53.09	1.73	0.18
None + 6.5X Zoom + 0.5x	92	0.35	2.25	0.023	0.071	7.25	2.35	2.54	5.28	0.95	0.10
None + 6.5X Zoom + 0.67x	92	0.47	3.00	0.023	0.071	7.25	2.35	3.41	7.04	0.95	0.10
None + 6.5X Zoom + 1.0x	92	0.70	4.50	0.023	0.071	7.25	2.35	5.08	10.55	0.95	0.10
None + 6.5X Zoom + 1.33x	92	0.93	6.05	0.023	0.071	7.25	2.35	6.76	14.03	0.95	0.10
None + 6.5X Zoom + 2.0x	92	1.40	9.00	0.023	0.071	7.25	2.35	10.15	21.11	0.95	0.10
None + 6.5X Zoom + 3.5x	92	2.45	15.93	0.023	0.071	7.25	2.35	17.78	36.93	0.95	0.10
None + 6.5X Zoom + 5.0x	92	3.50	22.50	0.023	0.071	7.25	2.35	25.38	52.76	0.95	0.10
1.5x + 6.5X Zoom + 0.5x	51	0.53	3.38	0.034	0.106	4.90	1.57	2.60	5.32	0.43	0.04
1.5x + 6.5X Zoom + 0.67x	51	0.70	4.50	0.034	0.106	4.90	1.57	3.43	7.09	0.43	0.04
1.5x + 6.5X Zoom + 1.0x	51	1.05	6.75	0.034	0.106	4.90	1.57	5.15	10.63	0.43	0.04
1.5x + 6.5X Zoom + 1.33	51	1.40	9.08	0.034	0.106	4.90	1.57	6.85	14.14	0.43	0.04
1.5x + 6.5X Zoom + 2.0x	51	2.10	13.50	0.034	0.106	4.90	1.57	10.29	21.26	0.43	0.04
1.5x + 6.5X Zoom + 3.5x	51	3.68	23.89	0.034	0.106	4.90	1.57	18.03	37.21	0.43	0.04
1.5x + 6.5X Zoom + 5.0x	51	5.25	33.75	0.034	0.106	4.90	1.57	25.73	53.16	0.43	0.04
2.0x + 6.5X Zoom + 0.5x	36	0.70	4.50	0.046	0.142	3.62	1.17	2.54	5.29	0.24	0.02
2.0x + 6.5X Zoom + 0.67x	36	0.94	6.00	0.046	0.142	3.62	1.17	3.41	7.05	0.24	0.02
2.0x + 6.5X Zoom + 1.0x	36	1.40	9.00	0.046	0.142	3.62	1.17	5.08	10.58	0.24	0.02
2.0x + 6.5X Zoom + 1.33	36	1.86	12.10	0.046	0.142	3.62	1.17	6.76	14.07	0.24	0.02
2.0x + 6.5X Zoom + 2.0x	36	2.80	18.00	0.046	0.142	3.62	1.17	10.15	21.15	0.24	0.02
2.0x + 6.5X Zoom + 3.5x	36	4.90	31.85	0.046	0.142	3.62	1.17	17.78	37.03	0.24	0.02
2.0x + 6.5X Zoom + 5.0x	36	7.00	45.00	0.046	0.142	3.62	1.17	25.38	52.88	0.24	0.02

**Assumptions:**

1. Minimum resolvable feature size is half of the threshold line pair limit. Calculation =  $1/(3000 \times \text{Lens N.A.})$
2. Matching pixel size is that which will permit the minimum feature size to overlap two pixels. Calculation =  $1/2(\text{Feature Size} \times \text{System Magnification})$
3. If the matching pixel size is greater than the camera pixel size, the system is "lens limited."
4. If the matching pixel size is less than the camera pixel size, the system is "camera limited."



## Zoom 6000 Distortion Percentage

This data is plus-minus calibrated distortion based on best-fit magnification.

Magnification	% Distortion
0.700	0.113
0.800	0.093
0.900	0.071
1.000	0.051
1.100	0.036
1.250	0.022
1.500	0.008
1.750	0.002
2.000	0.002
2.250	0.004
2.500	0.007
2.750	0.010
3.000	0.009
3.250	0.010
3.499	0.012
3.749	0.014
3.999	0.016
4.249	0.019
4.499	0.021

### Zoom 6000 Distortion Values Over Zoom Range

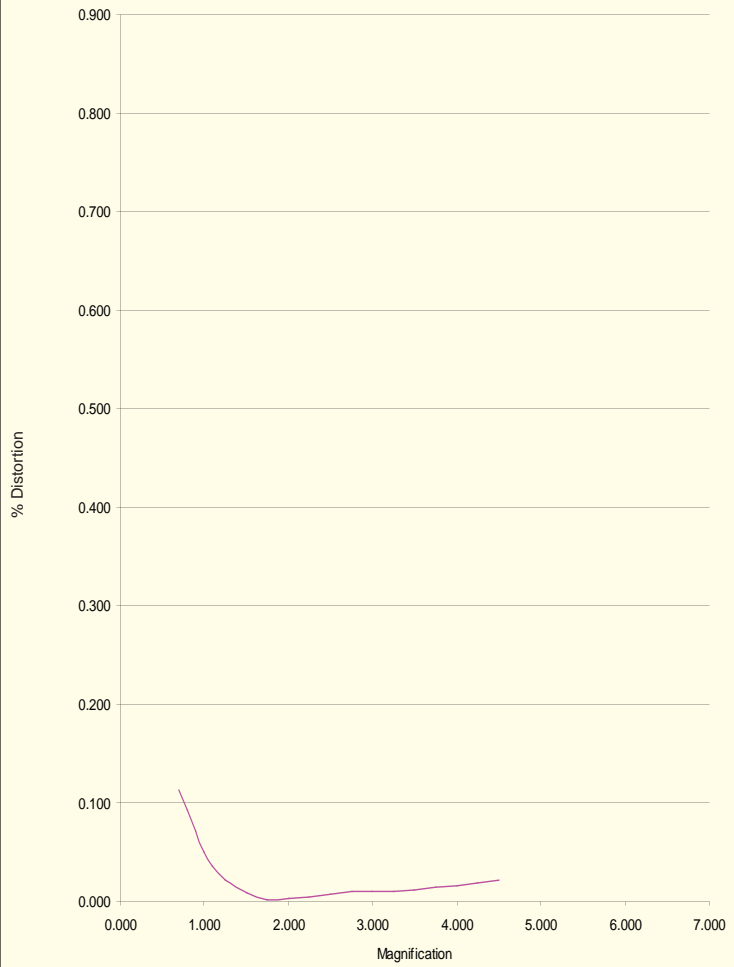



# Zoom 6000

## Internal Co-axial Zoom

Navitar's Zoom 6000 with Internal Co-axial Illumination (1-60123) is an ideal solution for applications involving highly reflective surfaces, such as wafers, polished samples, and fluids. Designed to provide even illumination for higher magnification applications, coaxial illumination provides extremely detailed resolution, particularly when a high resolution camera is used.

**Zoom 6000 Field of View Matrix for Internal Co-axial Zoom 1-60123 (in mm at nominal W.D.)**

Lens Attachment	W.D.(mm)	Camera Format/ Parameters	.5X Adapter Low - High	.67X Adapter Low - High	1X Adapter Low - High	1.33X Adapter Low - High	2X Adapter Low - High	3.5X Adapter Low - High	5X Adapter Low - High
None 0.023- 0.071	92 (nominal)	Mag.	0.35X - 2.25X	0.47X - 3.00X	0.70X - 4.50X	.93X - 6.0X	1.40X - 9.00X	2.45X - 15.75X	3.50X - 22.50X
		Field 1/4"	11.43 - 1.78	8.51 - 1.33	5.71 - 0.89	4.3X - 0.67	2.86 - 0.45	1.63 - 0.25	1.14 - 0.18
	90-93 (1) W.D. range	Field 1/3"	(2) 11.10 - 2.67	(2) 11.40 - 2.01	8.58 - 1.33	6.45 - 1.0	4.29 - 0.67	2.45 - 0.38	1.72 - 0.27
		Field 1/2"	(2) 11.20 - 3.56	(2) 11.46 - 2.62	11.42 - 1.77	8.6 - 1.33	5.71 - 0.89	3.27 - 0.51	2.28 - 0.36
		Field 2/3"	(2) 11.06 - 4.89	(2) 11.54 - 3.60	11.40 - 2.44	11.0 - 1.83	7.86 - 1.22	4.49 - 0.7	3.14 - 0.49
1.5X 0.034- 0.104 1-60112	51 (nominal)	Mag.	0.53X - 3.38X	0.71X - 4.50X	1.05X - 6.75X	1.4X - 9.0X	2.10X - 13.50X	3.7X - 23.6X	5.25X - 33.75X
		Field 1/4"	7.62 - 1.18	5.67 - 0.89	3.81 - 0.59	2.85 - 0.44	1.91 - 0.30	1.08 - 0.17	0.76 - 0.12
	51-53 (1) W.D. range	Field 1/3"	11.32 - 1.78	8.52 - 1.33	5.72 - 0.89	4.29 - 0.67	2.86 - 0.44	1.62 - 0.25	1.14 - 0.18
		Field 1/2"	(2) 11.20 - 2.37	11.34 - 1.77	7.62 - 1.19	5.71 - 0.89	3.81 - 0.59	2.16 - 0.34	1.52 - 0.24
		Field 2/3"	(2) 11.2 - 3.25	(2) 11.20 - 2.44	10.48 - 1.63	7.86 - 1.22	5.24 - 0.81	2.97 - 0.47	2.10 - 0.33
2.0X 0.046- 0.141 1-60113	36 (nominal)	Mag.	0.70X - 4.50X	0.94X - 6.00X	1.40X - 9.00X	1.86X-12.0X	2.80X - 18.00X	4.9X-31.5X	7.00X - 45.00X
		Field 1/4"	5.71 - 0.89	4.26 - 0.67	2.86 - 0.45	2.15 - 0.33	1.43 - 0.23	0.82 - 0.13	0.57 - 0.09
	36-37 (1) W.D. range	Field 1/3"	8.57 - 1.33	6.39 - 1.00	4.29 - 0.67	3.22 - 0.5	2.15 - 0.33	1.22 - 0.19	0.86 - 0.13
		Field 1/2"	(2) 11.2 - 1.77	8.51 - 1.33	5.71 - 0.89	4.30 - 0.67	2.86 - 0.44	1.63 - 0.25	1.14 - 0.18
		Field 2/3"	(2) 11.2 - 2.44	(2) 11.7 - 1.83	7.86 - 1.22	5.91 - 0.92	3.93 - 0.61	2.24 - 0.35	1.57 - 0.24

**NOTES:**

The internal coax will illuminate a circular area of about 11 mm in diameter. Any field of view larger than 11 mm will have darkened corners.

Low power lens attachments can be used but produce increasing vignetting.

(1) Working distance range when using 3 mm fine focus.

(2) Entire zoom range is not used.



# Zoom 6000 UltraZoom

## Combine Infinity-Corrected Objectives for Maximum Resolution and Magnification

Navitar's UltraZoom is a high-performance zoom lens system ideal for semiconductor inspection, flow cytometry, or other high magnification applications. Its advanced design offers high resolution and outstanding contrast. This system incorporates infinity corrected, plan-apochromatic objectives providing long working distances and excellent edge flatness and clarity. Resolution varies from 420 to 1,650 lines per mm, depending on the microscope objective used. The UltraZoom is also available with fine focus and/or co-axial illumination.

## Zoom 6000 UltraZoom Field of View Matrix for 1-60190, 1-60191, 1-60349 and 1-60350 (in mm)

Objective Lens (Mitutoyo) Long WD	W.D.	Camera Format/ Parameters	1X Adapter Low - High	1.33X Adapter Low - High	2X Adapter Low - High	3.5X Adapter Low - High
5X 0.14 NA* 1-60226	34	Mag.	1.74X - 11.43X	2.3X - 15.0X	3.48X - 22.86X	6.1X - 39.4X
		Field 1/4"	2.30 - 0.35	1.74 - 0.26	1.15 - 0.17	0.65 - 0.1
		Field 1/3"	3.45 - 0.52	2.61 - 0.40	1.72 - 0.26	0.98 - 0.15
		Field 1/2"	(1) 4.05 - 0.70	3.48 - 0.54	2.30 - 0.35	1.31 - 0.20
		Field 2/3"	(1) 4.02 - 0.96	4.0 - 0.74	3.16 - 0.48	1.80 - 0.28
10X 0.28 NA* 1-60227	33	Mag.	3.48X - 22.86X	4.63X - 29.9X	6.96X - 45.72X	12.3X - 78.8X
		Field 1/4"	1.15 - 0.17	0.86 - 0.13	0.57 - 0.09	0.33 - 0.05
		Field 1/3"	1.72 - 0.26	1.30 - 0.20	0.86 - 0.13	0.49 - 0.08
		Field 1/2"	(1) 2.10 - 0.35	1.73 - 0.27	1.15 - 0.17	0.66 - 0.10
		Field 2/3"	(1) 2.10 - 0.48	2.10 - 0.37	1.58 - 0.24	0.9 - 0.14
20X 0.42 NA* 1-60228	20	Mag.	6.96X - 45.72X	9.3X - 59.9X	13.92X - 91.40X	24.5X - 157.6X
		Field 1/4"	0.57 - 0.09	0.43 - 0.07	0.29 - 0.04	0.16 - 0.03
		Field 1/3"	0.86 - 0.13	0.65 - 0.10	0.43 - 0.07	0.25 - 0.04
		Field 1/2"	(1) 1.0 - 0.17	0.86 - 0.14	0.57 - 0.09	0.33 - 0.05
		Field 2/3"	(1) 1.03 - 0.24	1.0 - 0.19	0.79 - 0.12	0.45 - 0.07
50X 0.55 NA* 1-60229	13	Mag.	17.40X - 114.30X	23X-150X	34.80X - 228.60X	61X - 393.8X
		Field 1/4"	0.23 - 0.03	0.17 - 0.03	0.11 - 0.02	0.07 - 0.01
		Field 1/3"	0.30 - 0.05	0.26 - 0.04	0.17 - 0.03	0.10 - 0.015
		Field 1/2"	(1) 0.31 - 0.07	0.30 - 0.05	0.23 - 0.04	0.13 - 0.02
		Field 2/3"	(1) 0.30 - 0.10	0.30 - 0.07	(1) 0.30 - 0.05	0.18 - 0.03

(1) Entire zoom range is not used.  
\*N.A. at full zoom. N.A. varies with zoom settings.



Image provided courtesy of PVI Systems.

# Zoom 6000 NIR Lens System

Navitar's Zoom 6000 NIR lens system offers high resolution and unparalleled sensitivity for capturing microscopic images. We have specially coated the glass on our Zoom 6000 NIR lens systems to be optimized for imaging in the 700-1550nm (0.7-1.5 microns) wavelength range. Our Zoom 6000 NIR lens system is easy to configure and set up. Simply find the field of view and working distance required just as you would with any of our other standard 6X lenses.

For a complete listing of available Zoom 6000 NIR parts, please reference our website or contact your Navitar sales representative. Body tubes with detents, apertures or motorized are available by custom order.

## Applications Where NIR Optics are Useful

- Wafer characterization.
- Laser beam profiling.
- Optical component measurement and analysis.
- Fiber alignment and inspection.
- Assembly and monitoring.

## About Using NIR Lenses

The wavelength band just beyond the visible is known as Near Infrared (NIR). NIR is the electromagnetic band of wavelengths between 0.7-1.5 microns (700-1550nm). When light strikes a glass surface, a portion is bounced back, thereby reducing the strength of the transmitted image. Apply this behavior to a zoom lens with many glass surfaces, and the result is a severe reduction in image intensity. To counteract the loss, the lenses are coated with materials that minimize this effect.

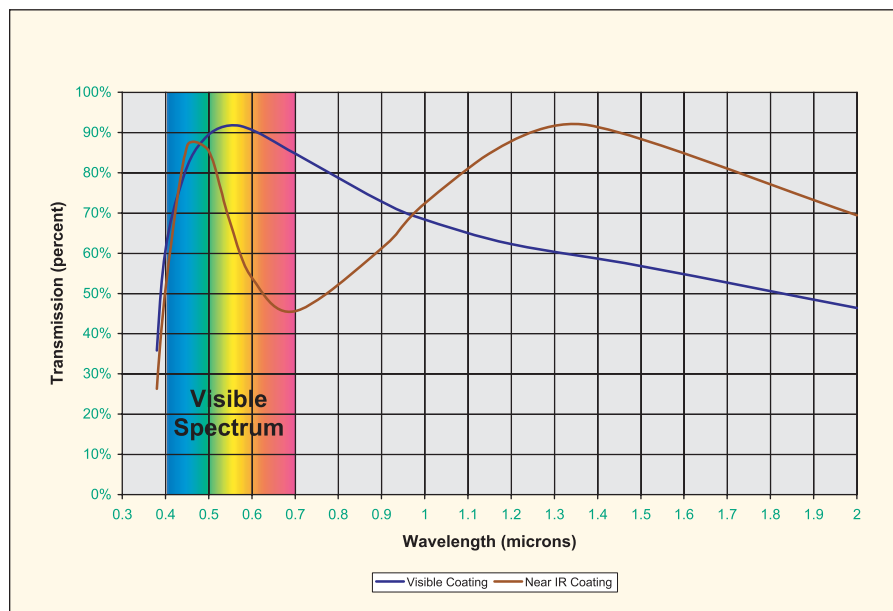

*Note:* Since NIR lenses are not operating within the visible spectrum, the resulting image is slightly different than when using a standard 6X system. The standard lens resolution limits of an NIR lens are based on an assumed average wavelength of 0.5 microns and is inversely proportional to wavelength (maximum MTF =  $3000 \times \text{NA}$  in the visible wavelength). Therefore, substituting a wavelength of 1.5 microns will reduce the maximum resolution by a factor of 3. In practice, this means a slight reduction of contrast at the higher wavelengths.

Lens focal lengths shift slightly with wavelength, which impacts the Numerical Aperture (NA), which affects the depth of field ( $.0005/\text{NA}^2$ ). Generally, the NA is reduced, which produces a greater depth of field, along with a reduction in maximum resolution. Standard NIR microscope objectives are usually lower in NA, also reducing maximum resolution values.



A list of all 6X NIR Zoom system components can be found on our website at [www.machinevision.navitar.com](http://www.machinevision.navitar.com)



# Zoom 6000 Detented Zoom

Navitar's Detented Zoom 6000 system provides four discrete detented positions in the zoom travel. Nominal positions at 0.7X, 1X, 2X, 3X and 4X, and 4.5X on the zoom scale allow the end user to make an exact calibration repeatable within 0.05%.

To order a detented zoom system, place a "D" after the standard part number.

# Reticle Projector

The Reticle Projector (1-60068) provides a means for superimposing a reticle (crosshair, micrometer scale, custom graphic) over the video image on the monitor. The information on the reticle must be contained to the size of the sensor. For example, if a 1/2" camera sensor is used, the reticle must have the information in a 4.8 x 6.4 mm area to be seen on the monitor. This reticle can then be used as a targeting device for measuring, machining, etc. Reticles must be 21 mm in diameter and are sold separately.

## Advantages of Using a Reticle

- Enables quick identification of minute dimensions in small parts.
- Costs less than an electronic crosshair generator.
- The lines can be calibrated at various magnifications and assigned measuring values.
- Reticle pattern can be rotated on its center line to align with workpiece.

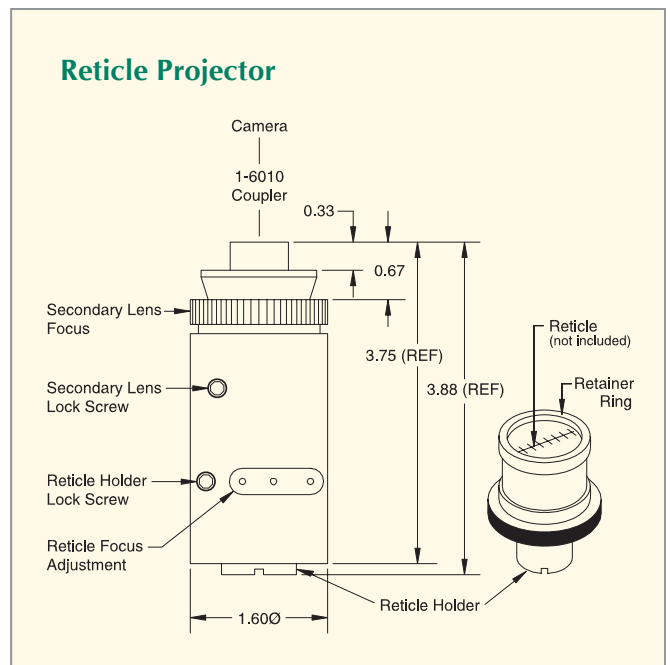

# Zoom 6000 Accessories



## Right Angle (RA) Accessories

The RA mount (1-6080) introduces a 90° bend in the optical axis, shortening the overall length of the system. The resulting image will be mirrored, thus erect and read backwards from right to left when viewed with a camera. The Zoom 6000 system uses the RA adapters 1-60060 (.71X), 1-6118 (1X), 1-61997 (adjustable 1X RA), 1-6120 (2X) and 1-6187 (5X).



## Non-Inverting Right Angle Accessories

The Non-Inverting RA mount (1-60165) introduces a 90° bend in the optical axis. The use of a penta prism results in an image that is erect and reads left to right. The Zoom 6000 system utilizes the NIRA adapters 1-60172 (.67X), 1-60182 (1X Tele), 1-60175 (1X), 1-60185 (2X) and 1-60188 (5X).

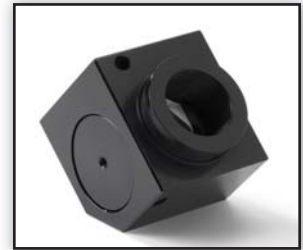

## Object Side Inverting and Non-Inverting Right Angle Attachments

Navitar offers a series of attachments that are fitted to the object side of our Zoom 6000 body tubes. Parts 1-60869, 1-61217, 1-61595 are NIRA based viewers for use with the Zoom 6000 series. Part 1-62866 is a right angle attachment designed with a mirror that can be used with all lens attachments except 2X (1-60113.)

## Adapter Plates

Navitar offers a variety of different microscope converter plates so you can use your zoom system with Nikon, Olympus, Meiji, and Leica focus mounts (see diagram at right for part numbers).

## Laser Injection Port

Navitar's Laser Injection Port (1-60380) provides a means of introducing a laser beam into the Zoom 6000 system. It is normally used between the end of the zoom lens and an infinity corrected objective so that the objective condenses the laser beam into a highly concentrated spot. A beamsplitter cube, rather than a plate, is used to minimize aberrations. The port is also useful for projecting targeting devices onto the object.

## Auxiliary Viewing Port

The Auxiliary Viewing Port (1-60370) provides a second output port for an additional camera or for direct vision using an eyepiece. A 50/50 beam splitter cube is used for minimal image degradation. This assembly uses the RA Adapters (1-60060, 1-6118, 1-6120, 1-6187) to provide a parfocal image. Adapters are required in both vertical and horizontal viewing axis.

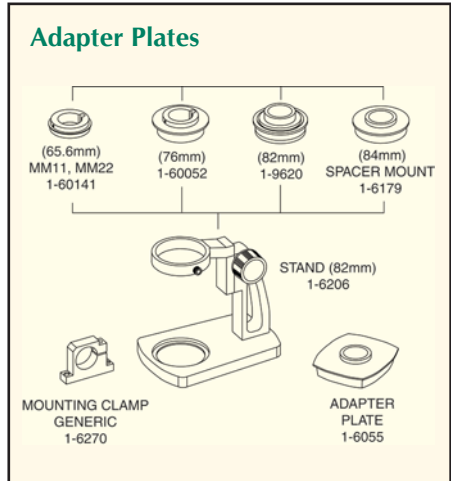

## 2X F-Mount Zoom Adapter

Navitar's 2X F-mount adapter (1-62922) is designed for larger format sensors (up to 30 mm diagonal). The adapter is configured as an F-mount, but its T-mount interface permits switching to other common flange formats. An RA version is available (1-63218). Not recommended for use with the 12X Zoom System with sensors over 16 mm.



## Zoom 6000 Field of View

Lens Attachment	Working Distance		2X F-Mount Zoom Adapter (Low-High)
0.25X 0.018 N.A. 1-6044	356	Mag	0.35X - 2.25X
		FOV	85-13.3*
0.5X 0.035 N.A. 1-60110	175	Mag	0.7X - 4.5X
		FOV	43-6.7*
0.75X 0.054 N.A. 1-60111	113	Mag	1.05X - 6.75X
		FOV	26 - 4.4*
NONE 0.071 N.A.	92	Mag	1.4X - 9.0X
		FOV	21 - 3.3*
1.5X 0.104 N.A. 1-60112	51	MAG	2.1X - 13.5X
		FOV	14.3 - 2.2*
2.0X 0.141 N.A. 1-60113	36	Mag	2.8X - 18.0X
		FOV	10.7 - 1.7*

\*FOV for 30mm (max) sensor.

## Zoom 6000 UltraZoom Field of View

Mitutoyo Objective Lens Long WD	Working Distance		2X F-Mount Zoom Adapter (Low-High)
5X 0.14 N.A.** 1-60226	34	Mag	3.5X - 22.5X
		FOV	8.6 - 1.33*
10X 0.28 N.A.** 1-60227	33	Mag	7.0X - 45.0X
		FOV	4.3 - 0.67*
20X 0.42 N.A.** 1-60228	20	MAG	14X - 90X
		FOV	2.14 - 0.33*
50X 0.55 N.A.** 1-60229	13	Mag	35X - 225X
		FOV	0.86 - 0.13*

\*FOV for 30mm (max) sensor.

Low mag value is increased (total range reduced) and FOV adjusted accordingly if coaxial illumination is required.

\*\*N.A. at full zoom. N.A. varies with zoom setting.



A complete listing of Zoom 6000 accessories can be found on our web site at [www.machinevision.navitar.com](http://www.machinevision.navitar.com)

# Accessories continued

## Differential Interference Contrast (DIC) Modules

Two Differential Interference Contrast (DIC) modules are available from Navitar:

- the DIC Assembly Nikon-High Resolution module (1-63726) and
- the original DIC Assembly module (1-63102).

Both modules can be used on any ultra coax version (zoom or non-zoom) of the Zoom 6000.

DIC, when used with reflected light, can often be interpreted as a true three-dimensional representation of the surface geometry. It provides a clear distinction between raised and lowered regions in the specimen being viewed.

### Using the DIC module in reflected light situations

Two polarizers, one in the illumination axis and one in the viewing axis, are crossed at 90 degrees such that when looking at a perfectly mirrored surface all light is extinguished by the second polarizer.

A prism, made from two pieces of quartz, is then placed between the illuminator beamsplitter and the objective. Due to the optical properties of the quartz, the polarized beam is split into two. The two beams, separated by a

minuscule amount, are polarized at 90 degrees to each other and one beam is shifted in relation to the other - a phase shift.

If the subject being viewed exhibits properties that change the length of the optical path of either beam (such as surface profiles, optical densities, etc.), both beams will experience further phase shifts.

With transverse movement of the prism the phase shifting performance of the prism may be accentuated and the final image is modified. By adding a polarization modifier, such as a 1/4 wave plate, after the illumination polarizer, the final effects are modified further.

The DIC module works with object side NAs ranging from 0.05 to 0.50, with optimum performance in the range from 0.15 to 0.4. Lens attachments, operating in the above range will serve for macro applications. Any infinity corrected objectives designed for incident light will suffice for micro applications. Operating parameters, such as magnification and FOV, will be the same as Navitar's existing tables for the Zoom 6000 system being used.

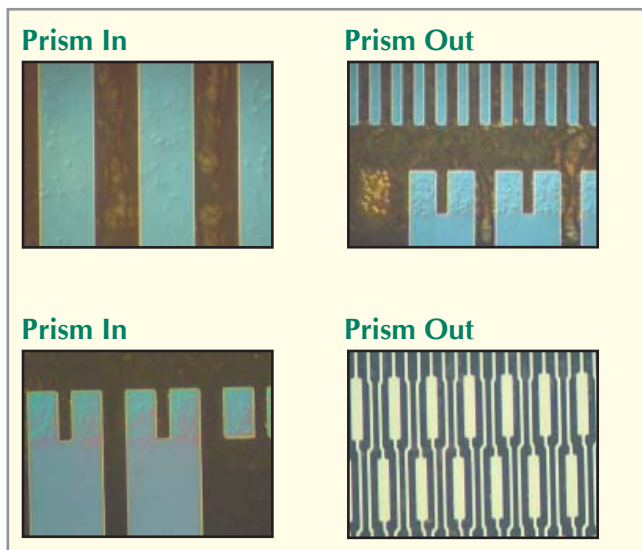

3D topography of a flat panel display circuit highlighted by employing differential interference contrast (DIC) and the Zoom 6000.





## DIC Module System Diagram

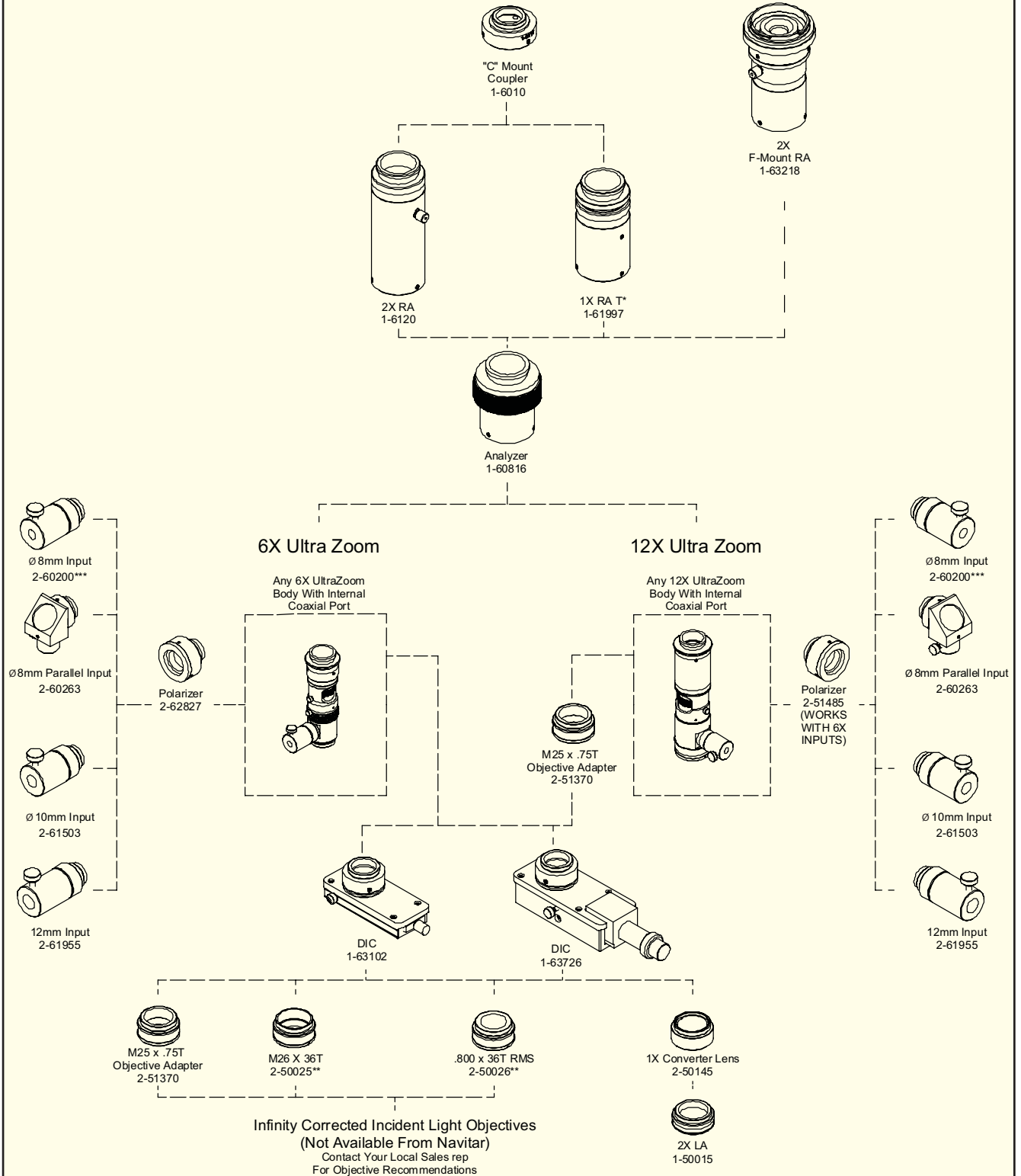

\*T = Tele

\*\* Included With 12X UltraZooms

\*\*\* Included With Manual 6000 UltraZooms

# Accessories continued

## Polarizers

Polarization is a contrast enhancement technique that can reduce back reflections and bring out salient features not readily visible with normal viewing.

If you choose to add a polarization option to your lens system, it requires an illumination polarizer (2-62827), an analyzer above the zoom, a quarter wave plate (optional), and a shorter version of an Adapter (RA) because the analyzer shortens the optical path by 50.8 mm.



## Quarter Wave Plate

A quarter wave plate (1-60981) has the unique feature of taking the polarized light and circularly polarizing the beam (sort of a spiraling effect). When this beam reflects off a specular object, the spiraling reverses, and upon re-striking the quarter wave plate, the beam is extinguished. This technique is useful in eliminating reflections from wafers and circuit boards. At other times, the quarter wave plate is used to add contrasting coloration to appropriate objects. For use with Zoom 6000 Coaxial lens.

## Analyzer

When used in conjunction with a polarized light source, an analyzer (1-60816) allows for cross polarization of the light in the imaging system. This reduces reflections that can deteriorate the image quality. The analyzer must be used in conjunction with the right angle adapters.



## Aperture Control

Lens systems can be designed with an internal iris that can be manipulated without cutting into the field of view. The iris permits the reduction of image intensity at the image plane, which reduces "blooming" and other damaging artifacts. The iris can also be closed down to essentially "stop down" the lens to reduce the Numerical Aperture of the lens. This narrowing of the light gathering cone produces a significant increase in the depth of field (the thickness of the envelope at the object, where various object heights are still in reasonable focus).

## Infinity Corrected Objectives

Infinity Corrected Objectives can be attached to the Zoom 6000 UltraZoom to increase the system magnification and decrease working distance. Navitar offers Mitutoyo long working distance objective lenses in magnifications of 5X, 10X, 20X, 50X (1-60226, 1-60227, 1-60228 and 1-60229) and Motic long working distance objective lenses in magnifications of 5X, 10X and 20X (1-62828, 1-62829, 1-62830).



To have an aperture control feature designed into your system place an "A" after the standard part number.

## Digital Camera Adapter

### Couple Your Digital Camera or Camcorder to any C-mount or Standard SLR Lens, Microscope or Telescope

Navitar's unique Digital Camera Adapter allows you to couple your digital camera or camcorder to any C-mount or standard SLR lens, microscope or telescope, permitting a digital recording of your subject matter.

The Digital Camera Adapter comes with a male M37 x 0.75 thread, a popular thread size used on a number of different cameras. If, however, your camera does not have the correct thread size, the required adapter is readily available from most aftermarket camera shops (recommended web sites are [www.dcpdirect.com](http://www.dcpdirect.com) or [www.steves-digicams.com](http://www.steves-digicams.com)).

- Attaches digital camera or camcorder to any C-mount or standard SLR lens.
- Permits digital recording of subject matter.
- Includes a male M37 x 0.75 thread.
- Fits any standard 30 mm microscope eyepiece port.
- Enables any lens to be used as a standard monocular for direct viewing with the eye.



### Outline Drawings & Dimensions

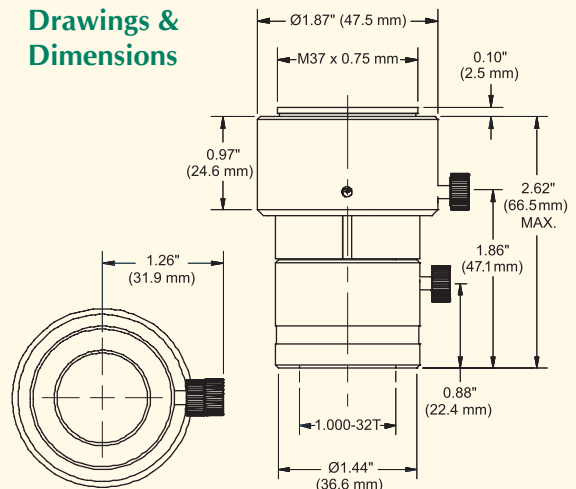

The Navitar Camera Adapter works beautifully with microscopes, fitting into any standard 30 mm eyepiece port. In the case of SLR lenses, the appropriate C-mount adapter will be needed (i.e. Pentax K-mount to C-mount adapter, T-mount to C-mount adapter, etc.). Telescopes require a 1¼" to C-mount adapter. All of these various adapters can be fitted to the Navitar Digital Camera Adapter to couple cameras and camcorders to virtually any lens, microscope or telescope.

In addition to allowing you to photograph and record digital images, this innovative camera adapter also enables any lens to be used as a standard monocular for direct viewing with the eye.

# Accessories continued

## Zoom Xtender

The Navitar Zoom Xtender (1-51560), with its 150 mm to infinity working distance, expands the versatility of your zoom system. It may be added to the Navitar Zoom 6000 system extending your reach by a meter, two meters, and further. The Xtender allows you to maintain your internal focus and parfocal zooming, as well as keep your computer controlled motorization and detents.

The Xtender is designed to offer working distances beyond that achievable with standard Navitar attachments.

### Zoom 6000 Typical Values (all dimensions in mm)

Working Distance	400	1000	2000
Mag. (min)	0.12	0.05	0.03
Mag. (max)	0.77	0.35	0.18
FOV (min)	8.3	18.4	35
FOV (max)	53	118	226
N.A. (min)	0.006	0.003	0.001
N.A. (max)	0.016	0.006	0.003
DOF (min)	1.9	11.7	47
DOF (max)	18.4	115	459

*Zoom 6000 with 12 mm fine focus  
Sensor Length - 6.4mm, 1x adapter,*

### Field of View Calculator Available Online

On the Navitar web site you will find an interactive Field of View Calculator. To use this calculator simply follow these easy steps:

1. Insert the applicable sensor dimension and the desired working distance in either or both zoom style columns.
2. Enter the extremes of zoom scale setting to determine the range of resulting performance. Note: The data presented assumes the use of a 1X adapter. The magnification may be increased with the use of a 2X adapter, with a resulting decrease in field of view and light level.
3. Pick the desired zoom system.
4. Choose a working distance range (1 of 2 for the Zoom 6000).
5. Read the required equipment to produce the final system.

### Product Installation

In any system, working distance is modified by varying the separation of the applicable lens attachments. In the initial setup, adjust the zoom's fine focus to mid range of travel. Loosen the locking thumb screw on the Xtender and slide it between extremes of motion. Usually, the greater the separation of the lens attachments, the longer the working distance. If necessary, adjust the position of the zoom's fine focus to further modify this distance.

