

30V Single P-Channel Enhancement-Mode MOSFET

General Description

- Low gate charge.
- Use as a load switch.
- Use in PWM applications

Product Summary

- BV_{DSS} -30V
- $R_{DS(on)}$ @VGS = -10V < 14mΩ
- $R_{DS(on)}$ @VGS = -4.5V < 24mΩ

DFN3X3EP-8L

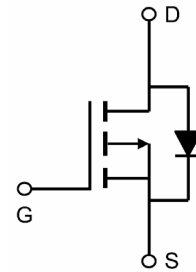
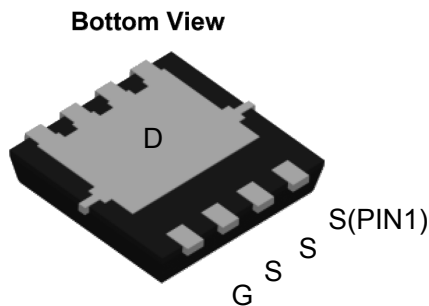
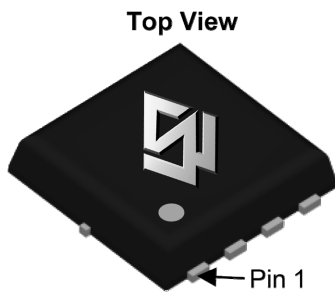

Absolute Maximum Ratings ($T_A = 25^\circ\text{C}$ unless otherwise noted)

Parameter	Symbol	Maximum	Units
Drain-Source Voltage	V_{DS}	-30	V
Gate-Source Voltage	V_{GS}	± 20	V
Drain Current ($T_A=25^\circ\text{C}$)	I_D	-14	A
Drain Current ($T_A=75^\circ\text{C}$)		-11	A
Pulsed Drain Current ^a	I_{DM}	-55	A
Avalanche Energy (L= 0.1 mH, -40A)	E_{AS}	100	mJ
Power Dissipation ^b ($T_C=25^\circ\text{C}$)	P_D	37	W
Power Dissipation ^b ($T_A=25^\circ\text{C}$)		1.67	W
Junction and Storage Temperature Range	T_J, T_{STG}	-55 ~ +150	$^\circ\text{C}$

Thermal Characteristics

Parameter	Symbol	Maximum	Units
Junction-to-Ambient ^a ($t \leq 10\text{s}$)	$R_{\theta JA}$	75	$^\circ\text{C/W}$
Junction-to-Ambient ^{a,d} (Steady-State)		30	$^\circ\text{C/W}$
Junction-to-Lead (Steady-State)	$R_{\theta JL}$	3.36	$^\circ\text{C/W}$

Electrical Characteristics ($T_A = 25^\circ\text{C}$ unless otherwise noted)						
Symbol	Parameter	Conditions	Min	Typ	Max	Units
Off Characteristics						
BV_{DSS}	Drain-Source Breakdown Voltage	$V_{GS} = 0V, I_D = -250\mu\text{A}$	-30			V
I_{DSS}	Zero Gate Voltage Drain Current	$V_{DS} = -30V, V_{GS} = 0V$			-1	μA
I_{GSS}	Gate-Body Leakage Current	$V_{GS} = \pm 20V, V_{DS} = 0V$			± 100	nA
On Characteristics						
$V_{GS(th)}$	Gate Threshold Voltage	$V_{DS} = V_{GS}, I_D = -250\mu\text{A}$	-1.0	-1.8	-2.5	V
$R_{DS(ON)}$	Drain-Source On-State Resistance	$V_{GS} = -10V, I_D = -20A$		11	14	$\text{m}\Omega$
		$V_{GS} = -4.5V, I_D = -10A$		18	24	$\text{m}\Omega$
g_{FS}	Forward Transconductance	$V_{DS} = -10V, I_D = -15A$		30		S
Drain-Source Diode Characteristics						
V_{SD}	Diode Forward Voltage	$V_{GS} = 0V, I_S = -1.0A$			-1.0	V
I_S	Maximum Body-Diode Continuous Current				-42	A
Dynamic Characteristics						
C_{iss}	Input Capacitance	$V_{DS} = -15V, V_{GS} = 0V$ $f = 1.0\text{MHz}$		2220		pF
C_{oss}	Output Capacitance			315		pF
C_{rss}	Reverse Transfer Capacitance			242		pF
Switching Characteristics						
Q_g	Total Gate Charge	$V_{DS} = -15V, I_D = -15A$ $V_{GS} = -4.5V$		23		nC
Q_{gs}	Gate-Source Charge			8.9		nC
Q_{gd}	Gate-Drain Charge			7.4		nC
$t_{D(ON)}$	Turn-On Delay Time	$V_{DD} = -15V, I_D = -15A$ $V_{GS} = -10V$ $R_{GEN} = -3.3\text{ohm}$		8		ns
t_r	Turn-On Rise Time			74.1		ns
$t_{D(OFF)}$	Turn-Off Delay Time			62.3		ns
t_f	Turn-Off Fall Time			25		ns

- Repetitive rating, Pulse width limited by junction temperature $T_{J(MAX)}=150^\circ\text{C}$. Ratings are based on low frequency and duty cycles to keep initial $T_J=25^\circ\text{C}$
- The power dissipation P_D is based on $T_{J(MAX)}=150^\circ\text{C}$, using $\leq 10\text{s}$ junction-to-ambient thermal resistance.
- The value of $R_{\theta JA}$ is measured with the device mounted on 1in^2 FR-4 board with 2oz. Copper, in a still air environment with $T_A = 25^\circ\text{C}$. The value in any given application depends on the user's specific board design.
- The $R_{\theta JA}$ is the sum of the thermal impedance from junction to lead $R_{\theta JL}$ and lead to ambient.

Typical Characteristics

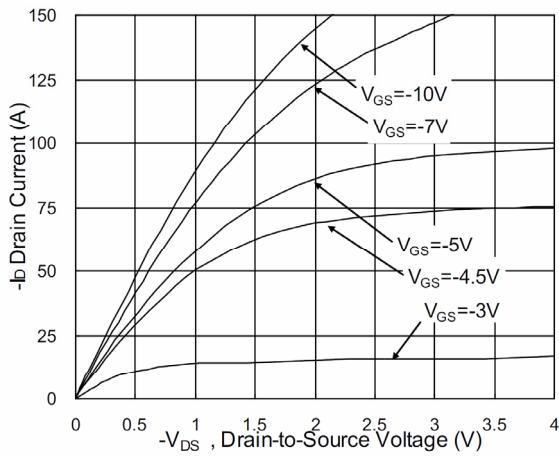

Fig.1 Typical Output Characteristics

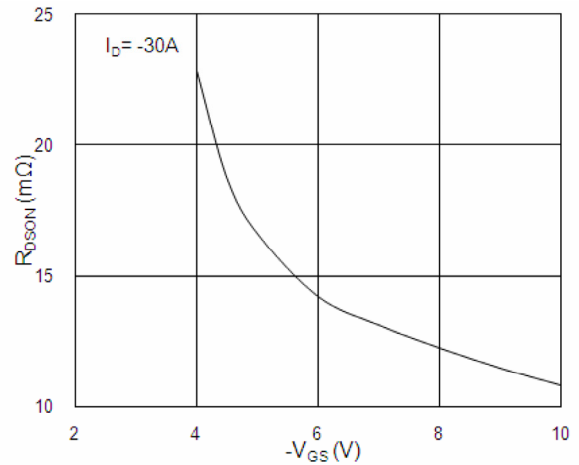

Fig.2 On-Resistance vs. G-S Voltage

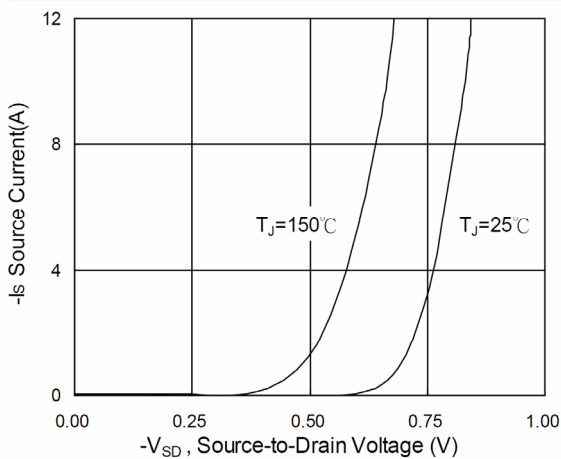

Fig.3 Forward Characteristics of Reverse

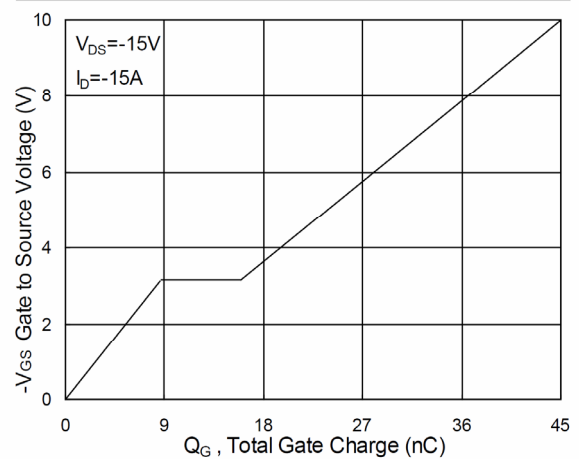

Fig.4 Gate-Charge Characteristics

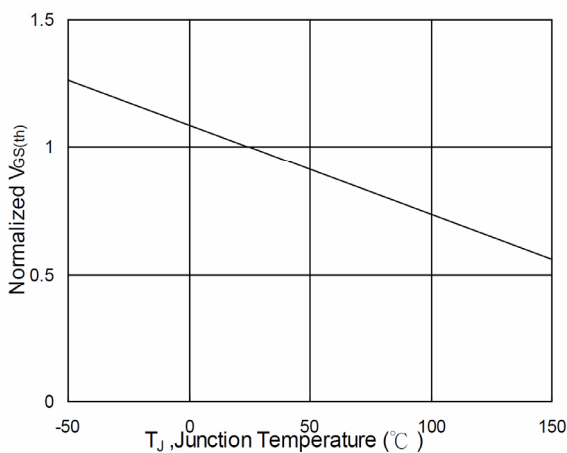

Fig.5 Normalized $V_{GS(th)}$ vs. T_J

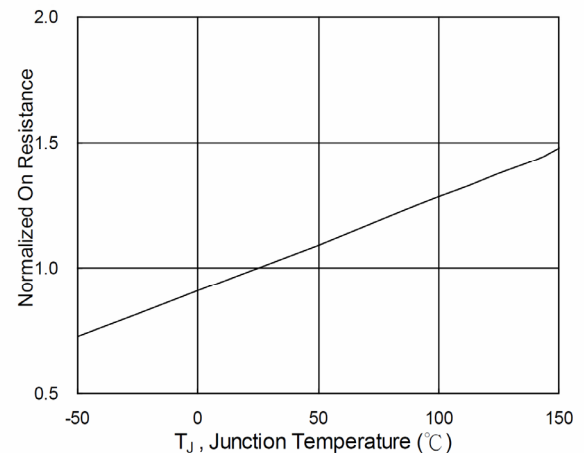

Fig.6 Normalized $R_{DS(on)}$ vs. T_J

Typical Characteristics

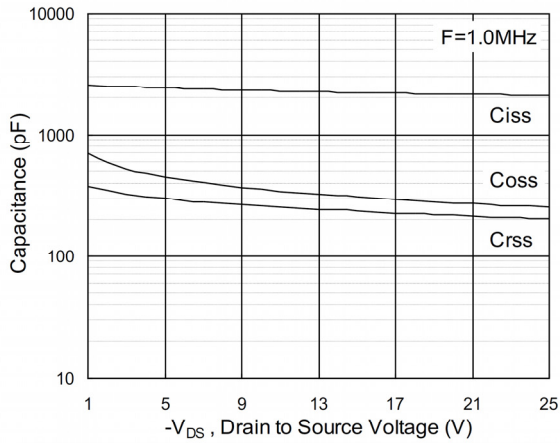

Fig.7 Capacitance

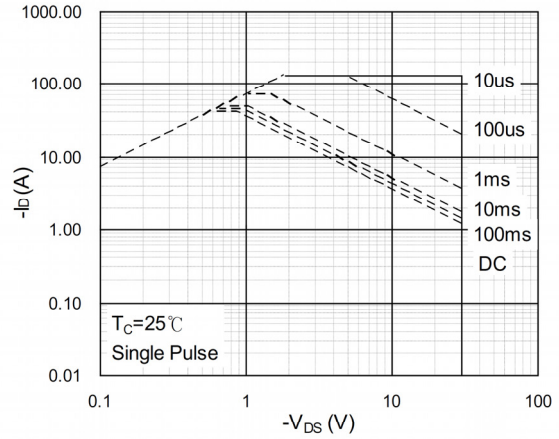

Fig.8 Safe Operating Area

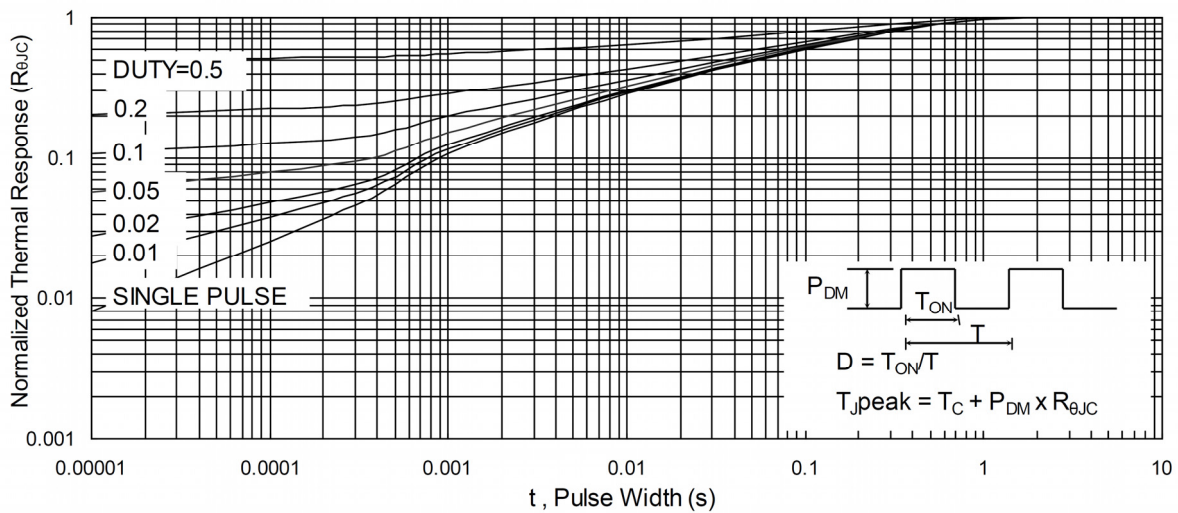

Fig.9 Normalized Maximum Transient Thermal Impedance

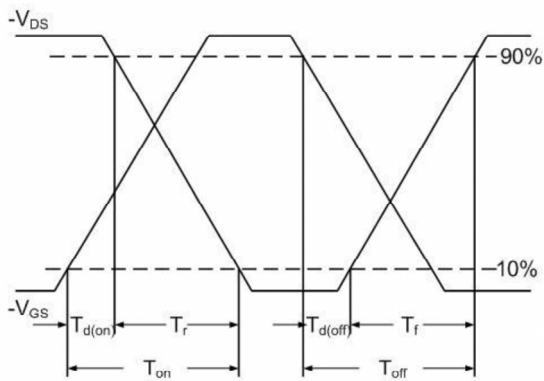

Fig.10 Switching Time Waveform

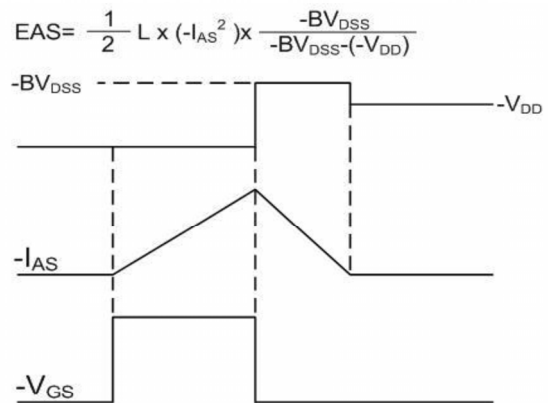
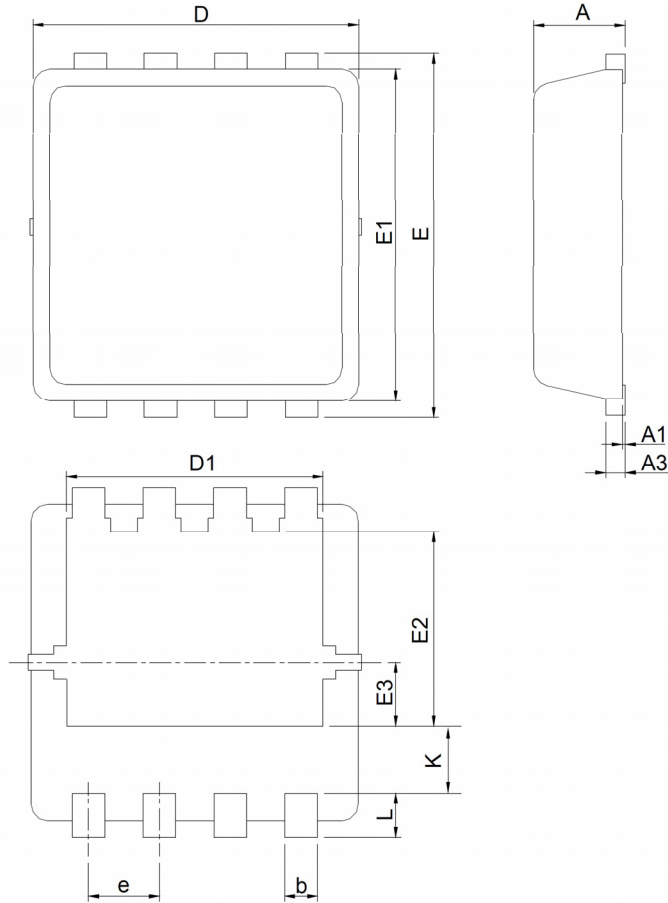

Fig.11 Unclamped Inductive Switching Waveform

DFN3x3EP-8L Package



SYMBOL	DFN3x3-8			
	MILLIMETERS		INCHES	
	MIN.	MAX.	MIN.	MAX.
A	0.80	1.00	0.031	0.039
A1	0.00	0.05	0.000	0.002
A3	0.10	0.25	0.004	0.010
b	0.24	0.35	0.009	0.014
D	2.90	3.10	0.114	0.122
D1	2.25	2.45	0.089	0.096
E	3.10	3.30	0.122	0.130
E1	2.90	3.10	0.114	0.122
E2	1.65	1.85	0.065	0.073
E3	0.56	0.58	0.022	0.023
e	0.65 BSC		0.026 BSC	
K	0.475	0.775	0.019	0.031
L	0.30	0.50	0.012	0.020

RECOMMENDED LAND PATTERN

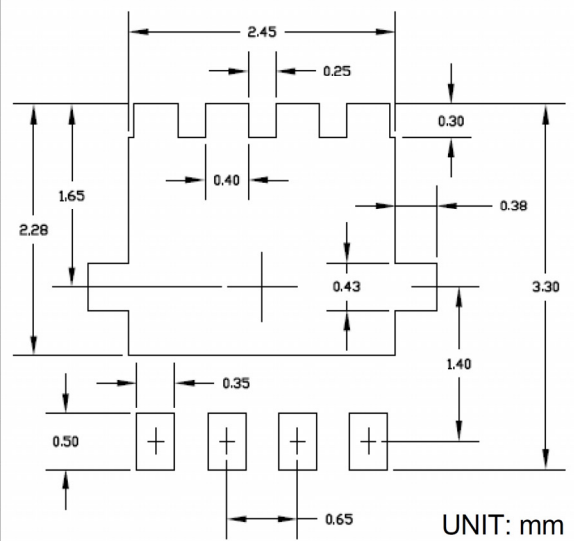

UNIT: mm