

R&S®FPS

Signal and Spectrum Analyzer

User Manual



1176.8445.02 – 09

This manual applies to the following R&S®FPS models with firmware version 1.50 and higher:

- R&S®FPS4 (1319.2008K04)
- R&S®FPS7 (1319.2008K07)
- R&S®FPS13 (1319.2008K13)
- R&S®FPS30 (1319.2008K30)
- R&S®FPS40 (1319.2008K40)

In addition to the base unit, the following options are described:

- R&S FPS-B4, OCXO (1321.4291.02)
- R&S FPS-B10, external generator control
- R&S FPS-B22, preamplifier (1321.4027.02)
- R&S FPS-B24, preamplifier (1321.4279.xx)
- R&S FPS-B25, electronic attenuator (1321.4033.02)
- R&S FPS-B40 bandwidth extension (1321.4040.02)
- R&S FPS-B160 bandwidth extension (1321.4285.xx)

Contents

1	Preface	15
1.1	About this Manual.....	15
1.2	Typographical Conventions.....	16
2	Documentation Overview	17
2.1	Getting Started Manual.....	17
2.2	User Manuals and Help.....	17
2.3	Service Manual.....	17
2.4	Instrument Security Procedures.....	18
2.5	Basic Safety Instructions.....	18
2.6	Data Sheets and Brochures.....	18
2.7	Release Notes and Open Source Acknowledgment (OSA).....	18
2.8	Application Notes, Application Cards, White Papers, etc.....	18
3	Welcome to the R&S FPS	19
4	Getting Started	20
4.1	Preparing for Use.....	20
4.1.1	Putting into Operation.....	20
4.1.2	Windows Operating System.....	25
4.1.3	Connecting USB Devices.....	30
4.1.4	Performing a Self Alignment and a Self Test.....	31
4.1.5	Checking the Supplied Options.....	33
4.1.6	Protecting Data Using the Secure User Mode.....	33
4.2	Instrument Tour	35
4.2.1	Front Panel View.....	35
4.2.2	Rear Panel View.....	37
4.2.3	Additional Hardware Options Without External Connectors.....	41
4.3	Miniature Display	41
4.3.1	Functions and Settings in the Mini Display Menu.....	42
4.3.2	Working with the Miniature Instrument Display.....	48
4.3.3	Configuring the Display Settings.....	49
4.4	Controlling the R&S FPS Remotely	50

4.4.1	Remote Control Interfaces and Protocols.....	51
4.4.2	How to Configure a Network.....	61
4.4.3	How to Log on to the Network.....	66
4.4.4	How to Share Directories (only with Microsoft Networks).....	69
4.4.5	How to Start a Remote Control Session from a PC.....	69
4.4.6	How to Set Up Remote Desktop.....	70
4.4.7	How to Control the R&S FPS via the Web Browser Interface.....	77
4.4.8	How to Deactivate the Web Browser Interface.....	79
4.5	Operating the Instrument in Manual Mode.....	80
4.5.1	Graphical User Interface Elements (Soft Front Panel).....	81
4.5.2	Understanding the Display Information.....	90
4.5.3	Changing the Focus.....	98
4.5.4	Entering Data.....	98
4.5.5	Displaying Results.....	100
4.5.6	Getting Help.....	107
5	Applications, Measurement Channels, and Operating Modes.....	110
5.1	Available Applications.....	111
5.2	R&S MultiView.....	116
5.3	Selecting the Operating Mode and Applications.....	117
5.4	Running a Sequence of Measurements.....	118
5.4.1	The Sequencer Concept.....	119
5.4.2	Sequencer Settings.....	121
5.4.3	How to Set Up the Sequencer.....	121
6	Measurements and Results.....	123
6.1	Basic Measurements.....	124
6.1.1	Basic Measurement Types.....	124
6.1.2	How to Perform a Basic Sweep Measurement.....	125
6.1.3	Measurement Examples - Measuring a Sinusoidal Signal.....	126
6.1.4	Measurement Example – Measuring Levels at Low S/N Ratios.....	129
6.1.5	Measurement Examples - Measuring Signal Spectra with Multiple Signals.....	132
6.1.6	Measurement Examples in Zero Span.....	139
6.2	Channel Power and Adjacent-Channel Power (ACLR) Measurement.....	145
6.2.1	About Channel Power Measurements.....	146

6.2.2	Channel Power Results.....	146
6.2.3	Channel Power Basics.....	148
6.2.4	Channel Power Configuration.....	159
6.2.5	MSR ACLR Configuration.....	169
6.2.6	How to Perform Channel Power Measurements.....	184
6.2.7	Measurement Examples.....	188
6.2.8	Optimizing and Troubleshooting the Measurement.....	192
6.2.9	Reference: Predefined CP/ACLR Standards.....	192
6.2.10	Reference: Predefined ACLR User Standard XML Files.....	193
6.3	Carrier-to-Noise Measurements.....	194
6.3.1	About the Measurement.....	194
6.3.2	Carrier-to-Noise Results.....	195
6.3.3	Carrier-to-Noise Configuration.....	196
6.3.4	How to Determine the Carrier-to-Noise Ratio.....	197
6.4	Occupied Bandwidth Measurement (OBW).....	198
6.4.1	About the Measurement.....	198
6.4.2	OBW Results.....	200
6.4.3	OBW Configuration.....	201
6.4.4	How to Determine the Occupied Bandwidth.....	203
6.4.5	Measurement Example.....	204
6.5	Spectrum Emission Mask (SEM) Measurement.....	205
6.5.1	About the Measurement.....	205
6.5.2	Typical Applications.....	205
6.5.3	SEM Results.....	206
6.5.4	SEM Basics.....	209
6.5.5	SEM Configuration.....	219
6.5.6	How to Perform a Spectrum Emission Mask Measurement.....	235
6.5.7	Measurement Example: Multi-SEM Measurement.....	240
6.5.8	Reference: SEM File Descriptions.....	241
6.6	Spurious Emissions Measurement.....	248
6.6.1	About the Measurement.....	248
6.6.2	Spurious Emissions Measurement Results.....	249
6.6.3	Spurious Emissions Basics.....	250

6.6.4	Spurious Emissions Measurement Configuration.....	252
6.6.5	How to Perform a Spurious Emissions Measurement.....	258
6.6.6	Reference: ASCII Export File Format (Spurious).....	259
6.7	Statistical Measurements (APD, CCDF).....	261
6.7.1	About the Measurements.....	261
6.7.2	Typical Applications.....	262
6.7.3	APD and CCDF Results.....	262
6.7.4	APD and CCDF Basics - Gated Triggering.....	265
6.7.5	APD and CCDF Configuration.....	266
6.7.6	How to Perform an APD or CCDF Measurement.....	272
6.7.7	Examples.....	273
6.7.8	Optimizing and Troubleshooting the Measurement.....	276
6.8	Time Domain Power Measurement.....	276
6.8.1	About the Measurement.....	276
6.8.2	Time Domain Power Results.....	276
6.8.3	Time Domain Power Basics - Range Definition Using Limit Lines.....	277
6.8.4	Time Domain Power Configuration.....	278
6.8.5	How to Measure Powers in the Time Domain.....	279
6.8.6	Measurement Example.....	279
6.9	Harmonic Distortion Measurement.....	280
6.9.1	About the Measurement.....	281
6.9.2	Harmonic Distortion Basics.....	281
6.9.3	Harmonic Distortion Results.....	283
6.9.4	Harmonic Distortion Configuration.....	284
6.9.5	How to Determine the Harmonic Distortion.....	286
6.10	Third Order Intercept (TOI) Measurement.....	286
6.10.1	About the TOI Measurement.....	287
6.10.2	TOI Basics.....	287
6.10.3	TOI Results.....	291
6.10.4	TOI Configuration.....	292
6.10.5	How to Determine the Third Order Intercept.....	293
6.10.6	Measurement Example – Measuring the R&S FPS's Intrinsic Intermodulation.....	293
6.11	AM Modulation Depth Measurement.....	296

6.11.1	About the Measurement.....	296
6.11.2	AM Modulation Depth Results.....	296
6.11.3	AM Modulation Depth Configuration.....	297
6.11.4	Optimizing and Troubleshooting the Measurement.....	298
6.11.5	How to Determine the AM Modulation Depth.....	299
7	Common Measurement Settings.....	300
7.1	Configuration Overview.....	300
7.2	Data Input and Output.....	302
7.2.1	Receiving Data Input and Providing Data Output.....	302
7.2.2	Input Source Settings.....	303
7.2.3	Power Sensors.....	305
7.2.4	External Generator Control.....	314
7.2.5	Output Settings.....	338
7.2.6	Trigger Input/Output Settings.....	340
7.2.7	How to Output a Trigger Signal.....	342
7.3	Frequency and Span Configuration.....	343
7.3.1	Impact of the Frequency and Span Settings.....	343
7.3.2	Frequency and Span Settings.....	345
7.3.3	Keeping the Center Frequency Stable - Signal Tracking.....	349
7.3.4	How To Define the Frequency Range.....	350
7.3.5	How to Move the Center Frequency through the Frequency Range.....	351
7.4	Amplitude and Vertical Axis Configuration.....	351
7.4.1	Impact of the Vertical Axis Settings.....	351
7.4.2	Amplitude Settings.....	354
7.4.3	Scaling the Y-Axis.....	358
7.4.4	How to Optimize the Amplitude Display.....	359
7.5	Bandwidth, Filter and Sweep Configuration.....	360
7.5.1	Impact of the Bandwidth, Filter and Sweep Settings.....	360
7.5.2	Bandwidth, Filter and Sweep Settings.....	366
7.5.3	Reference: List of Available RRC and Channel Filters.....	373
7.6	Trigger and Gate Configuration.....	375
7.6.1	Triggering.....	375
7.6.2	Gating.....	385

7.7	Adjusting Settings Automatically	389
8	Common Analysis and Display Functions	393
8.1	Result Display Configuration	393
8.1.1	Basic Evaluation Methods.....	393
8.1.2	Laying out the Result Display with the SmartGrid.....	395
8.2	Zoomed Displays	400
8.2.1	Single Zoom Versus Multiple Zoom.....	400
8.2.2	Zoom Functions.....	401
8.2.3	How to Zoom Into a Diagram.....	402
8.3	Marker Usage	404
8.3.1	Basics on Markers.....	405
8.3.2	Marker Settings.....	408
8.3.3	Marker Search Settings and Positioning Functions.....	413
8.3.4	Marker (Measurement) Functions.....	420
8.3.5	How to Work With Markers.....	438
8.3.6	Measurement Example: Measuring Harmonics Using Marker Functions.....	439
8.4	Display and Limit Lines	441
8.4.1	Display Lines.....	441
8.4.2	Limit Lines.....	443
8.5	Trace Configuration	459
8.5.1	Standard Traces.....	459
8.5.2	Spectrograms.....	471
8.5.3	Trace Math.....	486
8.6	Importing and Exporting Measurement Results for Evaluation	488
8.6.1	Displaying a Reference Trace - Importing Trace Data.....	489
8.6.2	Trace/Data Ex/Import.....	490
8.6.3	How to Import Traces.....	494
8.6.4	How to Export Trace Data and Numerical Results.....	494
8.6.5	How to Export a Peak List.....	495
8.6.6	Reference: ASCII File Export Format.....	495
9	Data Management	499
9.1	Restoring the Default Instrument Configuration (Preset)	499
9.2	Protecting Data Using the Secure User Mode	500

9.3	Storing and Recalling Instrument Settings and Measurement Data.....	502
9.3.1	Quick Save/Quick Recall.....	504
9.3.2	Configurable Storage and Recall.....	506
9.3.3	How to Save and Load Instrument Settings.....	511
9.4	Import/Export Functions.....	513
9.5	Creating Screenshots of Current Measurement Results and Settings.....	515
9.5.1	Print and Screenshot Settings.....	515
9.5.2	How to Store or Print Screenshots of the Display.....	526
9.5.3	Example for Storing Multiple Measurement Results to a PDF File.....	529
10	General Instrument Setup.....	532
10.1	Alignment.....	532
10.1.1	Basics on Alignment.....	532
10.1.2	Alignment Settings.....	533
10.1.3	How to Perform a Self-Test.....	534
10.1.4	How to Align the Instrument.....	535
10.2	Display Settings.....	535
10.2.1	Display Settings.....	535
10.2.2	External Monitor Settings.....	544
10.2.3	How to Configure the Colors for Display and Printing.....	545
10.3	Transducers.....	546
10.3.1	Basics on Transducer Factors.....	546
10.3.2	Transducer Settings.....	548
10.3.3	Reference: Transducer Factor File Format.....	553
10.3.4	How to Configure the Transducer.....	554
10.4	Reference Frequency Settings.....	558
10.5	System Configuration Settings.....	559
10.5.1	Hardware Information.....	560
10.5.2	Information on Versions and Options.....	560
10.5.3	System Messages.....	562
10.5.4	Firmware Updates.....	563
10.5.5	General Configuration Settings.....	564
10.6	Service Functions.....	566
10.6.1	R&S Support Information.....	567

10.6.2	Self-test Settings and Results.....	568
10.6.3	Calibration Signal Display.....	569
10.6.4	Service Functions.....	570
10.6.5	Hardware Diagnostics.....	572
11	Network and Remote Operation.....	574
11.1	Remote Control Basics.....	574
11.1.1	SCPI (Standard Commands for Programmable Instruments).....	574
11.1.2	Messages.....	575
11.1.3	SCPI Command Structure.....	576
11.1.4	Command Sequence and Synchronization.....	584
11.1.5	Status Reporting System.....	586
11.1.6	General Programming Recommendations.....	602
11.2	GPIB Languages.....	603
11.3	Network and Remote Control Settings.....	605
11.3.1	General Network Settings.....	605
11.3.2	GPIB Settings.....	607
11.3.3	Compatibility Settings.....	610
11.3.4	LXI Settings.....	612
11.3.5	Remote Errors.....	614
11.3.6	Returning to Manual Mode ("Local").....	616
12	Remote Commands.....	617
12.1	Conventions Used in SCPI Command Descriptions.....	617
12.2	Common Suffixes.....	618
12.3	Common Commands.....	618
12.4	Selecting the Operating Mode and Application.....	623
12.4.1	Selecting the Mode and Applications.....	623
12.4.2	Performing a Sequence of Measurements.....	628
12.4.3	Programming Example: Performing a Sequence of Measurements.....	631
12.5	Configuring and Performing Measurements.....	633
12.5.1	Performing Measurements.....	633
12.5.2	Configuring Power Measurements.....	636
12.5.3	Measuring the Channel Power and ACLR.....	641
12.5.4	Measuring the Carrier-to-Noise Ratio.....	677

12.5.5	Measuring the Occupied Bandwidth.....	678
12.5.6	Measuring the Spectrum Emission Mask.....	680
12.5.7	Measuring Spurious Emissions.....	715
12.5.8	Analyzing Statistics (APD, CCDF).....	728
12.5.9	Measuring the Time Domain Power.....	738
12.5.10	Measuring the Harmonic Distortion.....	748
12.5.11	Measuring the Third Order Intercept Point.....	752
12.5.12	Measuring the AM Modulation Depth.....	754
12.5.13	List Evaluations.....	756
12.5.14	Measuring the Pulse Power.....	761
12.6	Configuring the Result Display.....	765
12.6.1	General Window Commands.....	765
12.6.2	Working with Windows in the Display.....	766
12.6.3	Examples: Configuring the Result Display.....	773
12.7	Setting Basic Measurement Parameters.....	775
12.7.1	Defining the Frequency and Span.....	776
12.7.2	Configuring Bandwidth and Sweep Settings.....	785
12.7.3	Configuring the Vertical Axis (Amplitude, Scaling).....	792
12.7.4	Configuring Triggered and Gated Measurements.....	799
12.7.5	Adjusting Settings Automatically.....	809
12.7.6	Configuring the Data Input and Output.....	812
12.8	Analyzing Measurements (Basics).....	835
12.8.1	Zooming into the Display.....	835
12.8.2	Configuring the Trace Display and Retrieving Trace Data.....	837
12.8.3	Working with Markers.....	862
12.8.4	Configuring Display and Limit Lines.....	917
12.9	Managing Settings and Results.....	935
12.9.1	General Data Storage and Loading Commands.....	936
12.9.2	Selecting the Items to Store.....	943
12.9.3	Storing and Loading Instrument Settings.....	946
12.9.4	Storing or Printing Screenshots.....	951
12.9.5	Storing Measurement Results.....	962
12.9.6	Examples: Managing Data.....	966

12.10	Configuring the R&S FPS	969
12.10.1	Configuring the Reference Frequency.....	969
12.10.2	Calibration and Checks.....	971
12.10.3	Working with Transducers.....	974
12.10.4	Customizing the Screen Layout.....	978
12.10.5	Remote Commands for Language Settings.....	984
12.10.6	Configuring the Network and Remote Control.....	985
12.10.7	Checking the System Configuration.....	989
12.10.8	Using Service Functions.....	994
12.11	Using the Status Register	996
12.11.1	General Status Register Commands.....	997
12.11.2	Reading Out the CONDition Part.....	997
12.11.3	Reading Out the EVENT Part.....	998
12.11.4	Controlling the ENABLE Part.....	998
12.11.5	Controlling the Negative Transition Part.....	999
12.11.6	Controlling the Positive Transition Part.....	1000
12.12	Commands for Remote Instrument Operation	1000
12.13	Emulating Other Instruments' Commands	1001
12.13.1	Setting up Instrument Emulation.....	1001
12.13.2	Reference: GPIB Commands of Emulated HP Models.....	1004
12.13.3	Reference: Command Set of Emulated PSA Models.....	1032
12.13.4	Reference: Command Set of Emulated PXA Models.....	1036
12.14	Deprecated Commands	1039
12.15	Programming Examples	1041
12.15.1	Programming Example: Performing a Basic Frequency Sweep.....	1042
12.15.2	Service Request.....	1044
13	Maintenance	1052
13.1	Cleaning	1052
14	Troubleshooting	1054
14.1	Error Information	1054
14.2	Error Messages in Remote Control Mode	1055
14.3	Troubleshooting Remote Operation	1056
14.4	Miscellaneous Troubleshooting Hints	1058

14.5	Collecting Information for Technical Support.....	1058
	List of remote commands (base unit).....	1060
	Index.....	1078

1 Preface

1.1 About this Manual

This User Manual describes general instrument functions and settings common to all applications and operating modes in the R&S FPS. Furthermore, it provides all the information specific to **RF measurements in the Spectrum application**. All other operating modes and applications are described in the specific application manuals.

The main focus in this manual is on the measurement results and the tasks required to obtain them.



Manual operation

Although the R&S FPS does not have a built-in display, it is recommended that you connect an external monitor to the instrument initially to get familiar with the instrument and its manual operation before using it in pure remote mode. Thus, this manual starts with a detailed description on how to operate the instrument manually using an external monitor and mouse. The commands required for remote operation are provided as a reference at the end of this document.

The following topics are included:

- **Welcome to the R&S FPS**
Introduction to and getting familiar with the instrument
- **Operating Modes and Applications**
The concept of using multiple operating modes
- **Measurements**
Descriptions of the individual measurements in the Spectrum application, including result types and configuration settings.
- **Common Measurement Settings**
Description of the measurement settings common to all measurement types with their corresponding remote control commands
- **Common Measurement Analysis and Display Functions**
Description of the settings and functions provided to analyze results independently of the measurement type with their corresponding remote control commands
- **Data Management**
Description of general functions to handle data files (configuration and result data, not I/Q data)
- **General Instrument Setup**
Description of general instrument settings and functions that are independent of the current operating mode
- **Network and Remote Operation**
Detailed information on setting up the instrument in a network and operating it remotely.
- **Remote Commands**

Remote commands required to configure and perform measurements in a remote environment, sorted by tasks

Remote commands required to set up the environment and to perform common tasks on the instrument, sorted by tasks

Programming examples demonstrate the use of many commands and can usually be executed directly for test purposes

- **Maintenance**
Information on tasks required to maintain operability of the instrument
- **Troubleshooting**
Hints and tips on how to handle errors
- **List of Commands**
Alphabetical list of all remote commands described in the manual
- **Index**

1.2 Typographical Conventions

The following text markers are used throughout this documentation:

Convention	Description
"Graphical user interface elements"	All names of graphical user interface elements on the screen, such as dialog boxes, menus, options, buttons, and softkeys are enclosed by quotation marks.
KEYS	Key names are written in capital letters.
File names, commands, program code	File names, commands, coding samples and screen output are distinguished by their font.
<i>Input</i>	Input to be entered by the user is displayed in italics.
Links	Links that you can click are displayed in blue font.
"References"	References to other parts of the documentation are enclosed by quotation marks.

2 Documentation Overview

This section provides an overview of the R&S FPS user documentation. Unless specified otherwise, you find the documents on the R&S FPS product page at:

www.rohde-schwarz.com/manual/FPS

2.1 Getting Started Manual

Introduces the R&S FPS and describes how to set up and start working with the product. Includes basic operations, typical measurement examples, and general information, e.g. safety instructions, etc.

A printed version is delivered with the instrument. A PDF version is available for download on the Internet.

2.2 User Manuals and Help

Separate user manuals are provided for the base unit and the firmware applications:

- Base unit manual
Contains the description of all instrument modes and functions. It also provides an introduction to remote control, a complete description of the remote control commands with programming examples, and information on maintenance, instrument interfaces and error messages. Includes the contents of the getting started manual.
- Firmware application manual
Contains the description of the specific functions of a firmware application, including remote control commands. Basic information on operating the R&S FPS is not included.

The contents of the user manuals are available as help in the R&S FPS. The help offers quick, context-sensitive access to the complete information for the base unit and the firmware applications.

All user manuals are also available for download or for immediate display on the Internet.

2.3 Service Manual

Describes the performance test for checking the rated specifications, module replacement and repair, firmware update, troubleshooting and fault elimination, and contains mechanical drawings and spare part lists.

The service manual is available for registered users on the global Rohde & Schwarz information system (GLORIS):

<https://gloris.rohde-schwarz.com>

2.4 Instrument Security Procedures

Deals with security issues when working with the R&S FPS in secure areas. It is available for download on the Internet.

2.5 Basic Safety Instructions

Contains safety instructions, operating conditions and further important information. The printed document is delivered with the instrument.

2.6 Data Sheets and Brochures

The data sheet contains the technical specifications of the R&S FPS. It also lists the firmware applications and their order numbers, and optional accessories.

The brochure provides an overview of the instrument and deals with the specific characteristics.

See www.rohde-schwarz.com/brochure-datasheet/FPS

2.7 Release Notes and Open Source Acknowledgment (OSA)

The release notes list new features, improvements and known issues of the current firmware version, and describe the firmware installation.

The open source acknowledgment document provides verbatim license texts of the used open source software.

See www.rohde-schwarz.com/firmware/FPS

2.8 Application Notes, Application Cards, White Papers, etc.

These documents deal with special applications or background information on particular topics.

See www.rohde-schwarz.com/application/FPS

3 Welcome to the R&S FPS

The R&S FPS is a new high-performance Rohde & Schwarz signal and spectrum analyzer developed to meet demanding customer requirements. Offering low phase noise, wide analysis bandwidth and straightforward and intuitive operation, the analyzer makes measurements fast and easy.

This user manual contains a description of the functionality that the instrument provides, including remote control operation. The latest version is available for download at the product homepage (<http://www2.rohde-schwarz.com/product/FPS.html>).

4 Getting Started

Note: the following chapters are identical to those in the printed R&S FPS Getting Started manual.

- [Preparing for Use](#).....20
- [Instrument Tour](#).....35
- [Miniature Display](#).....41
- [Controlling the R&S FPS Remotely](#)..... 50
- [Operating the Instrument in Manual Mode](#).....80

4.1 Preparing for Use

- [Putting into Operation](#)..... 20
- [Windows Operating System](#).....25
- [Connecting USB Devices](#).....30
- [Performing a Self Alignment and a Self Test](#)..... 31
- [Checking the Supplied Options](#).....33
- [Protecting Data Using the Secure User Mode](#)..... 33

4.1.1 Putting into Operation

This section describes the basic steps to be taken when setting up the R&S FPS for the first time.

⚠ WARNING

Risk of injury due to disregarding safety information

Observe the information on appropriate operating conditions provided in the data sheet to prevent personal injury or damage to the instrument. Read and observe the basic safety instructions provided with the instrument, in addition to the safety instructions in the following sections. In particular:

- Do not open the instrument casing.

NOTICE

Risk of instrument damage due to inappropriate operating conditions

Specific operating conditions are required to ensure accurate measurements and to avoid damage to the instrument. Observe the information on appropriate operating conditions provided in the basic safety instructions and the instrument's data sheet.

NOTICE**Instrument damage caused by electrostatic discharge**

Electrostatic discharge (ESD) can damage the electronic components of the instrument and the device under test (DUT). Electrostatic discharge is most likely to occur when you connect or disconnect a DUT or test fixture to the instrument's test ports. To prevent electrostatic discharge, use a wrist strap and cord and connect yourself to the ground, or use a conductive floor mat and heel strap combination.

NOTICE**Risk of instrument damage due to inappropriate operating conditions**

An unsuitable operating site or test setup can damage the instrument and connected devices. Before switching on the instrument, observe the information on appropriate operating conditions provided in the data sheet. In particular, ensure the following:

- All fan openings are unobstructed and the airflow perforations are unimpeded. The minimum distance from the wall is 10 cm.
- The instrument is dry and shows no sign of condensation.
- The instrument is positioned as described in the following sections.
- The ambient temperature does not exceed the range specified in the data sheet.
- Signal levels at the input connectors are all within the specified ranges.
- Signal outputs are connected correctly and are not overloaded.

**EMI impact on measurement results**

Electromagnetic interference (EMI) may affect the measurement results.

To suppress generated electromagnetic interference (EMI):

- Use suitable shielded cables of high quality. For example, use double-shielded RF and LAN cables.
- Always terminate open cable ends.
- Note the EMC classification in the data sheet.

• Unpacking and Checking the Instrument	21
• Accessory List	22
• Placing or Mounting the Instrument	22
• Connecting the AC Power	24
• Switching the Instrument On and Off	24

4.1.1.1 Unpacking and Checking the Instrument

Check the equipment for completeness using the delivery note and the accessory lists for the various items. Check the instrument for any damage. If there is damage, immediately contact the carrier who delivered the instrument. Make sure not to discard the box and packing material.

**Packing material**

Retain the original packing material. If the instrument needs to be transported or shipped later, you can use the material to protect the control elements and connectors.

**WARNING****Risk of injury during transportation**

The carrying handles at the front and side of the casing are designed to lift or carry the instrument. Do not apply excessive force to the handles. If a handle is ripped off, the falling instrument can cause injury.

Be aware of the weight of the instrument when lifting it. Observe the information on transporting heavy instruments in the basic safety instructions provided with the instrument.

4.1.1.2 Accessory List

The instrument comes with the following accessories:

- Power cable
- "Getting Started" printed manual

4.1.1.3 Placing or Mounting the Instrument

The R&S FPS is designed for use under laboratory conditions, either on a bench top or in a rack.

Bench Top Operation

If the R&S FPS is operated on a bench top, the surface should be flat. The instrument can be used in horizontal position, standing on its feet, or with the support feet on the bottom extended.

⚠ WARNING**Risk of injury if feet are folded out**

The feet can fold in if they are not folded out completely or if the instrument is shifted. Collapsing feet can cause injury or damage the instrument.

- Fold the feet completely in or out to ensure stability of the instrument. Never shift the instrument when the feet are folded out.
- When the feet are folded out, do not work under the instrument or place anything underneath.
- The feet can break if they are overloaded. The overall load on the folded-out feet must not exceed 500 N.

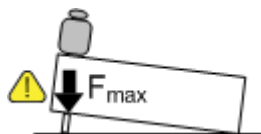
**⚠ WARNING****Risk of injury when stacking instruments**

A stack of instruments can tilt over and cause injury if not stacked correctly. Furthermore, the instruments at the bottom of the stack can be damaged due to the load imposed by the instruments on top.

Observe the following instructions when stacking instruments:

- Never stack more than three instruments. If you need to stack more than three instruments, install them in a rack.
- The overall load imposed on the lowest instrument must not exceed 500 N.
- It is best if all instruments have the same dimensions (width and length). If you need to stack smaller instruments on the top, the overall load imposed on the lowest instrument must not exceed 250 N.
- If the instruments have foldable feet, fold them in completely.

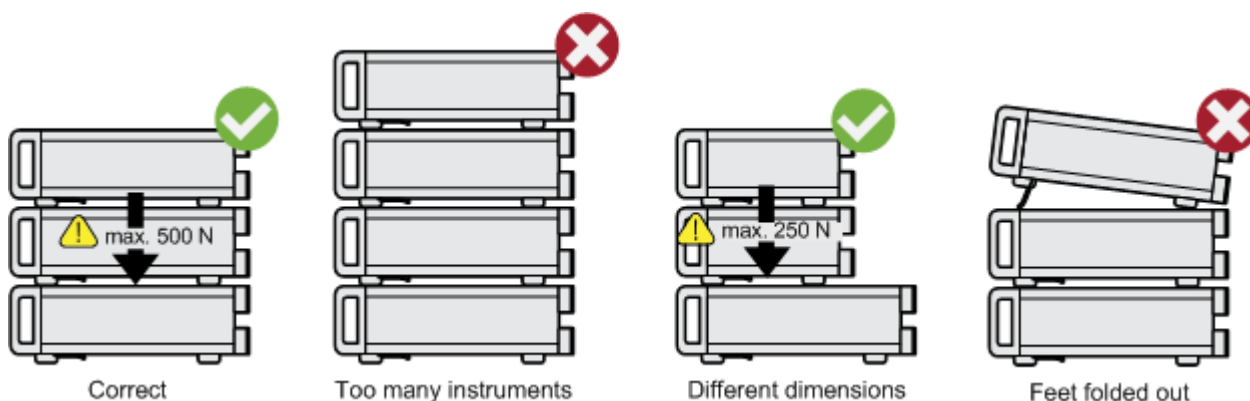

Rackmounting

The R&S FPS can be installed in a rack using a rack adapter kit (Order No. see data sheet). The installation instructions are part of the adapter kit.

NOTICE

Risk of instrument damage due to insufficient airflow in a rack

If the instrument is run with insufficient airflow for a longer period, the instrument overheats, which can disturb the operation and even cause damage.

Make sure that all fan openings are unobstructed, that the airflow perforations are unimpeded, and that the minimum distance from the wall is 10 cm.

4.1.1.4 Connecting the AC Power

In the standard version, the R&S FPS is equipped with an AC power supply connector. The R&S FPS can be used with different AC power voltages and adapts itself automatically to it. Refer to the datasheet for the requirements of voltage and frequency. The AC power connector is located on the rear panel of the instrument.

For details on the connector refer to [Chapter 4.2.2.10, "AC Power Supply Connection and Main Power Switch"](#), on page 40.



- ▶ Connect the R&S FPS to the AC power supply using the supplied power cable. Since the instrument is assembled in line with the specifications for safety class EN61010, it may only be connected to an outlet that has a ground contact.

4.1.1.5 Switching the Instrument On and Off

Switching the instrument on

- ▶ Press the AC power switch on the rear panel to position "I".
The instrument is supplied with AC power. After booting, the instrument is ready for operation. A green LED above the POWER key indicates this.



Warm-up time for OCXO

When the instrument is switched on, the OCXO requires an extended warm-up time (see data sheet).

Switching the instrument off

1. Press the POWER key on the front panel of the R&S FPS.
2. Change the AC power switch on the rear panel to position "O", or disconnect the instrument from the AC power supply.

The R&S FPS changes into off mode.

NOTICE**Risk of losing data**

If you switch off the running instrument using the rear panel switch or by disconnecting the power cord, the instrument loses its current settings. Furthermore, program data can be lost.

Press the Power key first to shut down the application properly.

4.1.2 Windows Operating System

The instrument contains the Windows 7 operating system which has been configured according to the instrument's features and needs. Changes in the system setup are only required when peripherals like keyboard or a printer are installed or if the network configuration does not comply with the default settings. After the R&S FPS is started, the operating system boots and the instrument firmware is started automatically.

To ensure that the instrument software functions properly, certain rules must be adhered to concerning the operating system.

NOTICE**Risk of rendering instrument unusable**

The instrument is equipped with the Windows 7 operating system. You can install additional software on the instrument, however, additional software can impair instrument function. Thus, run only programs that Rohde & Schwarz has tested for compatibility with the instrument software.

The drivers and programs used on the instrument under Windows 7 are adapted to the instrument. Only install update software released by Rohde & Schwarz to modify existing instrument software.

The following program packages have been tested:

- Symantec Endpoint Security – virus-protection software
- FileShredder - for reliable deletion of files on the hard disk

**Error message display**

Note that any error messages caused by the Windows 7 operating system are only visible on an external monitor or via Remote Desktop from a controller PC. Thus, if operation of the R&S FPS seems to fail for no obvious reason, try connecting a monitor or a controller PC to check for any messages awaiting confirmation or action.

(See [Chapter 4.1.3, "Connecting USB Devices"](#), on page 30 or [Chapter 4.4.6, "How to Set Up Remote Desktop"](#), on page 70)

4.1.2.1 Virus Protection

Take appropriate steps to protect your instruments from infection. Use strong firewall settings and scan any removable storage device used with a Rohde & Schwarz instrument regularly. It is also recommended that you install anti-virus software on the instrument. Rohde & Schwarz does NOT recommend running anti-virus software in the background ("on-access" mode) on Windows-based instruments, due to potentially degrading instrument performance. However, Rohde & Schwarz does recommend running it during non-critical hours.

For details and recommendations, see the following Rohde & Schwarz white paper:

- [1EF73: Malware Protection Windows XP](#)
- [1DC01: Malware Protection Windows 7](#)
- [1EF96: Malware Protection Windows 10](#)

4.1.2.2 Service Packs and Updates

Microsoft regularly creates security updates and other patches to protect Windows-based operating systems. These are released through the Microsoft Update website and associated update server. Instruments using Windows, especially those that connect to a network, should be updated regularly.

For details and recommendations, see the Rohde & Schwarz White Papers "[1DC01: Malware Protection](#)" or "[1EF73: Malware Protection](#)" (for Windows XP).

For details and recommendations, see the Rohde & Schwarz White Paper [1DC01: Malware Protection](#).

For details and recommendations, see the Rohde & Schwarz White Paper [1EF96: Malware Protection Windows 10](#)

4.1.2.3 Login

Windows 7 requires that users identify themselves by entering a user name and password in a login window. By default, the R&S FPS provides two user accounts:

- **"Instrument"**: an administrator account with unrestricted access to the computer/domain
- **"NormalUser"**: a standard user account with limited access

Some administrative tasks require administrator rights (e.g. the configuration of a LAN network). Refer to the description of the basic instrument setup (SETUP menu) to find out which functions are affected.



Secure user mode

If the secure user mode option (R&S FPS-K33) is installed, an additional account is provided: the **"SecureUser"**.

The "SecureUser" is a standard user account with limited functionality. In particular, administrative tasks such as LAN configuration or general instrument settings are not available. Furthermore, for a "SecureUser", data that the R&S FPS normally stores on the solid-state drive is redirected to volatile memory instead. You can access data that is stored in volatile memory during the current instrument session. However, when the instrument's power is removed, all data in volatile memory is erased.

For details, see [Chapter 4.1.6, "Protecting Data Using the Secure User Mode"](#), on page 33.

Automatic login

For the administrator account, an automatic login function is active by default. If activated, login is carried out automatically for the administrator (with full access) in the background when the R&S FPS is started, without having to enter a password. This function is active until you explicitly deactivate it or change the password.

For information on how to deactivate or reactivate the automatic login, refer to ["Automatic Login Function"](#) on page 27.

Passwords

For all default user accounts, the initial password is *894129*. Note that this password is very weak, and it is recommended that you change the password for both users after initial login.

You can change the password in Windows 7 for any user at any time via "Start > Control Panel > User Accounts".

You can change the password in Windows 7 for any user at any time via "Start > Settings > Account > SignIn Options > Password > Change".

NOTICE

Changing the password and use of auto-login function

Note that when you change the default passwords, the default auto-login function no longer works! Reactivate it manually as described in ["Reactivating the automatic login function"](#) on page 29.

Be aware if the auto-login function is deactivated and the R&S FPS is rebooted: since the R&S FPS has no real display, you require an external monitor and keyboard or a Remote Desktop access to the R&S FPS to enter the password. Otherwise, the Windows operating system does not complete login and the R&S FPS remains inoperable.

Automatic Login Function

When shipped, the instrument automatically logs on the default "Instrument" user to Windows 7 using the default password.



To change the settings for the automatic login function for the R&S FPS, a controller PC or an external monitor and keyboard must be connected to the R&S FPS. See [Chapter 4.4.6, "How to Set Up Remote Desktop"](#), on page 70.

If the auto-login function is deactivated and the R&S FPS is rebooted, you require an external monitor and keyboard or a Remote Desktop access on the R&S FPS to enter the password. Otherwise, the Windows operating system does not complete login and the R&S FPS remains inoperable.

Switching users when using the automatic login function

Which user account is used is defined during login. If automatic login is active, the login window is not displayed. However, you can also switch the user account to be used when the automatic login function is active.



1. Select the "Windows" icon in the toolbar to access the operating system of the R&S FPS (see also [Chapter 4.1.2.4, "Accessing the Start Menu"](#), on page 29).



2. Press CTRL + ALT + DEL, then select "Sign out".
In the "Start" menu, select the arrow next to the "Shut down" button and then "Log off".

The "Login" dialog box is displayed, in which you can enter the different user account name and password.

Deactivating the automatic login function

To deactivate the automatic login function, perform the following steps:



1. Select the "Windows" icon in the toolbar to access the operating system of the R&S FPS (see also [Chapter 4.1.2.4, "Accessing the Start Menu"](#), on page 29).



2. In the "Start" menu, select "Run".
In the "Start" menu, select "All applications > Windows System > Run".
The "Run" dialog box is displayed.
3. Enter the command `C:\R_S\INSTR\USER\NO_AUTOLOGIN.REG`.
4. Press the ENTER key to confirm.
This command deactivates the automatic login function. The next time you switch on the instrument, the operating system prompts you to enter your user name and password before it starts the firmware. (You must use an external monitor and keyboard or Remote Desktop from a controller PC, not the R&S FPS miniature display!)

Adapting the automatic login function to a new password

If you change the "Instrument" user's password, which is used during automatic login, this function no longer works. Adapt the settings for the command that activates the auto login function first.

If the SecureUser or the NormalUser are enabled, those passwords are used for auto-login. In that case, if you change any of the passwords, the autologin function must be adapted each time you change the user account.

1. Open the `C:\R_S\INSTR\USER\NO_AUTOLOGIN.REG` file in any text editor (e.g. Notepad).
2. In the line `"DefaultPassword"="894129"`, replace the default password (894129) by the new password for automatic login.
3. Save the changes to the file.

Reactivating the automatic login function



1. Select the "Windows" icon in the toolbar to access the operating system of the R&S FPS (see also [Chapter 4.1.2.4, "Accessing the Start Menu"](#), on page 29).



2. In the "Start" menu, select "Run".
In the "Start" menu, select "All applications > Windows System > Run".
The "Run" dialog box is displayed.
3. Enter the command `C:\R_S\INSTR\USER\AUTOLOGIN.REG`.
4. Press the ENTER key to confirm.
This command reactivates automatic login function. It is active the next time the instrument reboots.

4.1.2.4 Accessing the Start Menu

The Windows "Start" menu provides access to the Windows 7 functionality and installed programs.

To open the "Start" menu:



1. In Windows 10:
Press the "Windows" key or the CTRL + ESC key combination on your (external) keyboard.



2. In Windows 7:
Select the "Windows" icon on the R&S FPS toolbar, or press the "Windows" key or the CTRL + ESC key combination on the (external) keyboard.

All necessary system settings can be defined in the "Start > Control Panel" menu (for required settings refer to the Windows 7 documentation and to the hardware description).

All necessary system settings can be defined in the "Start > Settings" menu (for required settings refer to the Windows 7 documentation and to the hardware description).

4.1.2.5 Accessing the Windows Taskbar

The Windows taskbar also provides quick access to commonly used programs, for example Paint or WordPad. IECWIN, the auxiliary remote control tool provided free of charge and installed by Rohde & Schwarz, is also available from the taskbar.



For details on the IECWIN tool, see the "Network and Remote Control" chapter of the R&S FPS user manual.



To open the taskbar, select the "Windows" icon on the R&S FPS toolbar, or press the "Windows" key or the CTRL + ESC key combination on your (external) keyboard.

4.1.3 Connecting USB Devices

The USB interfaces of the R&S FPS allow you to connect USB devices directly to the instrument. Increase the number of possible connections using USB hubs. Due to the large number of available USB devices, there is almost no limit to the expansions that are possible with the R&S FPS.

The following list shows various USB devices that can be useful:

- Memory stick for easy transfer of data to/from a computer (e.g. firmware updates)
- CD-ROM drives for easy installation of firmware applications
- Keyboard or mouse to simplify the entry of data, comments, filenames, etc.
- Printer for printing measurement results

Installing USB devices is easy under Windows, because all USB devices are plug&play. After a device is connected to the USB interface, the operating system automatically searches for a suitable device driver.

If Windows does not find a suitable driver, it prompts you to specify a directory that contains the driver software. If the driver software is on a CD, connect a USB CD-ROM drive to the instrument before proceeding.

When a USB device is then disconnected from the R&S FPS, Windows immediately detects the change in hardware configuration and deactivates the corresponding driver.

All USB devices can be connected to or disconnected from the instrument during operation.

Connecting a memory stick or CD-ROM drive

If installation of a memory stick or CD-ROM drive is successful, Windows informs you that the device is ready to use. The device is made available as a new drive and is displayed in Windows Explorer. The name of the drive depends on the manufacturer.

Connecting a keyboard

The keyboard is detected automatically when it is connected. The default input language is English – US.

Select "Start > Control Panel > Clock, Language, and Region > Change keyboards or other input methods" to configure the keyboard properties. To access the Windows operating system, press the Windows key on the external keyboard.

Select "Start > Settings > Time & language > Region & language > Add a language" to configure the keyboard language. To access the Windows operating system, press the Windows key on the external keyboard.

Connecting a mouse

The mouse is detected automatically when it is connected.

Select "Start > Control Panel > Devices and Printers > Mouse" to configure the mouse properties. To access the Windows operating system, press the Windows key on the external keyboard.

Select "Start > Settings > Devices > Mouse & touchpad" to configure the mouse properties. To access the Windows operating system, press the Windows key on the external keyboard.

Connecting a printer

When printing a file, the instrument checks whether a printer is connected and turned on and whether the appropriate printer driver is installed. If necessary, printer driver installation is initiated. You only have to install a printer driver once.

To install a printer, select "Start > Control Panel > Devices and Printers > Add a printer". To access the Windows operating system, press the Windows key on the external keyboard.

To install a printer, select "Start > Settings > Devices > Add a printer or scanner". To access the Windows operating system, press the Windows key on the external keyboard.

You can load updated and improved driver versions or new drivers from an installation disk, USB memory stick or another external storage medium. If the instrument is integrated in a network, you can also install driver data stored in a network directory.

Select "Start > Control Panel > Devices and Printers > Device Manager > Update Device drivers" to install the driver.

Select "Start > Settings > Devices > Device Manager > Update Device drivers" to install the driver.

4.1.4 Performing a Self Alignment and a Self Test



During instrument start, the installed hardware is checked against the current firmware version to ensure the hardware is supported. If not, an error message is displayed ("WRONG_FW") and you are asked to update the firmware. Until the firmware version is updated, self-alignment fails.

(For details refer to the R&S FPS User Manual).

Furthermore, it may be necessary to align the data to a reference source by performing a self alignment when strong temperature changes occur.



Operating temperature

Before performing this functional test, make sure that the instrument has reached its operating temperature (for details, refer to the data sheet).

To perform a self alignment directly on the R&S FPS

- ▶ In the R&S FPS's mini display, navigate to "System commands" > "Self align". For details on working with the mini display, see [Chapter 4.3, "Miniature Display"](#), on page 41.

To perform a self alignment via Remote Desktop

Performing a self alignment via Remote Desktop requires a controller PC to be connected, see [Chapter 4.4.6, "How to Set Up Remote Desktop"](#), on page 70.

1. Select the SETUP key in the soft front panel on the Remote Desktop.
2. Select the "Alignment" softkey.
3. Select the "Start Self Alignment" button in the "Alignment" dialog box.

Once the system correction values have been calculated successfully, a message is displayed.



To display the alignment results again later

- Select the SETUP key in the soft front panel on the Remote Desktop.
- Select the "Alignment" softkey.

Self tests

The self test does not need to be repeated every time the instrument is switched on. It is only necessary when instrument malfunction is suspected.

To perform a self test directly on the R&S FPS

- ▶ In the R&S FPS's mini display, navigate to "System commands" > "Selftest". For details on working with the mini display, see [Chapter 4.3, "Miniature Display"](#), on page 41.

To perform a self test via Remote Desktop

Performing a self alignment via Remote Desktop requires a controller PC to be connected, see [Chapter 4.4.6, "How to Set Up Remote Desktop"](#), on page 70.

1. Select the SETUP key in the soft front panel on the Remote Desktop.
2. Select the "Service" softkey.
3. Switch to the "Selftest" tab in the "Service" dialog box.

4. Select the "Start Selftest" button.

Once the instrument modules have been checked successfully, a message is displayed.

4.1.5 Checking the Supplied Options

The instrument may be equipped with both hardware and firmware options. In order to check whether the installed options correspond to the options indicated on the delivery note, proceed as follows.

Checking the supplied options via Remote Desktop requires a controller pc or an external monitor, mouse and keyboard to be connected, see [Chapter 4.4.6, "How to Set Up Remote Desktop"](#), on page 70.

1. Select the SETUP key in the soft front panel on the Remote Desktop.
2. Select the "System Config" softkey.
3. Switch to the "Versions + Options" tab in the "System Configuration" dialog box.
A list with hardware and firmware information is displayed.
4. Check the availability of the hardware options as indicated in the delivery note.

4.1.6 Protecting Data Using the Secure User Mode

During normal operation, the R&S FPS uses a solid-state drive to store its operating system, instrument firmware, instrument self-alignment data, and any user data created during operation. If necessary, the solid-state drive can be removed from the R&S FPS and locked in a secure place to protect any classified data it may contain.

Redirecting storage to volatile memory

Alternatively, to avoid storing any sensitive data on the R&S FPS permanently, the *secure user mode* was introduced (option R&S FPS-K33). In secure user mode the instrument's solid-state drive is write-protected so that no information can be written to memory permanently. Data that the R&S FPS normally stores on the solid-state drive is redirected to volatile memory instead, which remains available only until the instrument is switched off. This data includes:

- Windows 7 operating system files
- Firmware shutdown files containing information on last instrument state
- Self-alignment data
- General instrument settings such as the IP address
- Measurement settings
- User data created during operation
(see also [Table 9-1](#))
- Any data created by other applications installed on the R&S FPS, for example text editors (Notepad), the Clipboard, drawing tools, etc.

Users can access data that is stored in volatile memory just as in normal operation. However, when the instrument's power is switched off, all data in this memory is cleared. Thus, in secure user mode, the instrument always starts in a defined, fixed state when switched on.

To store data such as measurement results permanently, it must be stored to an external storage device, such as a memory stick.



Limited storage space

The volatile memory used to store data in secure user mode is restricted to 256 MB. Thus, a "Memory full" error can occur although the hard disk indicates that storage space is still available.

Storing required data permanently

Any data that is to be available for subsequent sessions with the R&S FPS must be stored on the instrument permanently, *before activating the secure user mode*. This includes predefined instrument settings, transducer factors and self-alignment data.



Self-alignment data

Note that self-alignment data becomes invalid with time and due to temperature changes. Therefore, to achieve optimal accuracy, it may be preferable to perform a new self-alignment at the start of each new session on the R&S FPS.

Restricted operation

Since permanent storage is not possible, the following functions are not available in secure user mode:

- Firmware update
- Activating a new option key

Furthermore, since the "SecureUser" used in secure user mode does not have administrator rights, **administrative tasks** such as LAN configuration and some general instrument settings are not available. Refer to the description of the basic instrument setup (SETUP menu) to find out which functions are affected.



Remote Desktop restricted for "SecureUser" by default

For security reasons, the "SecureUser" is not allowed Remote Desktop access to the R&S FPS by default. You must explicitly add the "SecureUser" to the Remote Desktop group (see [Chapter 4.4.6.5, "How to Add or Remove Users to the Remote Desktop Users Group"](#), on page 75). If you do not allow this user Remote Desktop access, the "SecureUser" can only operate the R&S FPS using remote commands or via the miniature display.

Activating and deactivating secure user mode

Only a user with administrator rights can activate (and deactivate) the secure user mode. Once activated, a restart is required. The special user "SecureUser" is then log-

ged on to the R&S FPS automatically (using the automatic login function, see "[Automatic Login Function](#)" on page 27). While the secure user mode is active, a message is displayed in the status bar at the bottom of the screen, and in the miniature display "SecUsr" is displayed.

To deactivate the secure user mode, the "SecureUser" must log off and the "Instrument" user (administrator) must log on.



Switching users when using the automatic login function

In the "Start" menu, select the arrow next to the "Shut down" button and then "Log off". The "Login" dialog box is displayed, in which you can enter the different user account name and password.

The secure user mode setting and automatic login is automatically deactivated when the "Instrument" user logs on. The "SecureUser" is no longer available.

For administrators ("Instrument" user), the secure user mode setting is available in the general system configuration settings (see "[SecureUser Mode](#)" on page 565).

Alternatively, you can activate or deactivate the secure user function via the miniature display (see "[Enable SecureUser/Disable SecureUser](#)" on page 45. In this case, enter the administrator ("Instrument" user) password.

Remote control

Initially after installation of the R&S FPS-K33 option, secure user mode must be enabled manually once before remote control is possible.

(See `SYSTEM:SECURITY[:STATE]`.)

4.2 Instrument Tour

4.2.1 Front Panel View

This chapter describes the front panel, including all function keys and connectors.

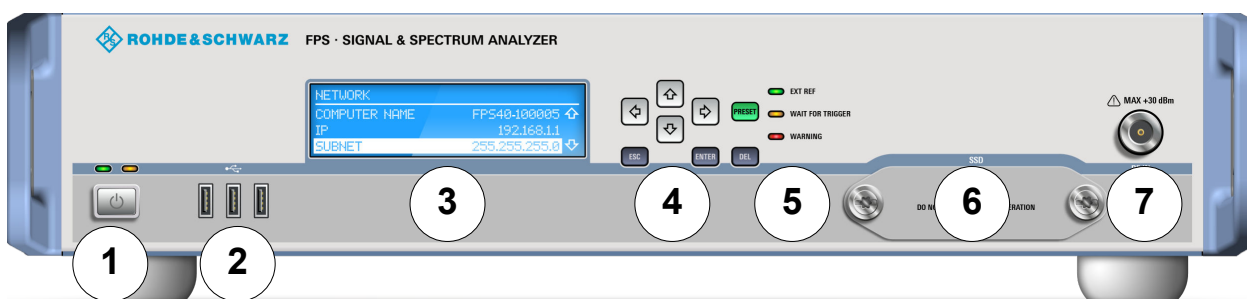

Figure 4-1: Front panel view

- 1 = On/Off button
- 2 = USB connectors
- 3 = Mini display
- 4 = Navigation and data input controls
- 5 = Status LEDs
- 6 = Solid State Disk (SSD) containing instrument firmware
- 7 = RF Input 50 Ω connector (optionally front or rear panel)

NOTICE

Instrument damage caused by cleaning agents

Cleaning agents contain substances such as solvents (thinners, acetone, etc.), acids, bases, or other substances. Solvents can damage the front panel labeling, plastic parts, or screens, for example.

Never use cleaning agents to clean the outside of the instrument. Use a soft, dry, lint-free dust cloth instead.

On / off button

The POWER key is located on the lower left corner of the front panel. It starts up and shuts down the instrument.

See also [Chapter 4.1.1.5, "Switching the Instrument On and Off"](#), on page 24.

Mini display



The R&S FPS is equipped with a miniature display on the front panel that provides basic information and allows for very basic instrument configuration (such as changing the IP address). For details see [Chapter 4.3, "Miniature Display"](#), on page 41.

USB

The front panel provides three female USB connectors (USB-A) to connect devices like an external monitor, a mouse or a keyboard. In addition, a memory stick can be connected to store and reload instrument settings and measurement data.



The rear panel provides further USB connectors, including a male (USB-B) connector. See [Chapter 4.2.2.9, "USB"](#), on page 40.

Navigation Keys

The navigation keys can be used to navigate through menus or entries in the display.

Data Input Controls

Type of key	Description
ESC key	Exits the current function without storing changes
ENTER key	Stores the current entry and closes the edit mode
DEL key	Deletes the character to the left of the cursor

Status LEDs

Indicate the instrument's operating status:

Table 4-1: Status LEDs

Label	Description
EXT REF	External reference connected and active
WAIT FOR TRIGGER	Measurement waiting for trigger
WARNING	Warning or system error

Removable Solid State Disk (SSD)

The removable solid state disk contains the instrument firmware and all measurement data from the R&S FPS, allowing you to store the data securely in an external location.

RF INPUT 50Ω

A device under test (DUT) can be connected to the R&S FPS to provide RF input which is then analyzed. The DUT is connected to the instrument's RF INPUT via a cable equipped with an appropriate connector.

The RF Input connector may be provided on the front or rear panel, as requested by the customer.

NOTICE

Risk of instrument damage

Do not overload the input. For maximum allowed values, see the data sheet. For AC-coupling, a DC input voltage of 50 V must never be exceeded. For DC-coupling, DC voltage must not be applied at the input. In both cases, noncompliance will destroy the input mixers.

4.2.2 Rear Panel View

This figure shows the rear panel view of the R&S FPS. The individual elements are described in more detail in the subsequent sections.

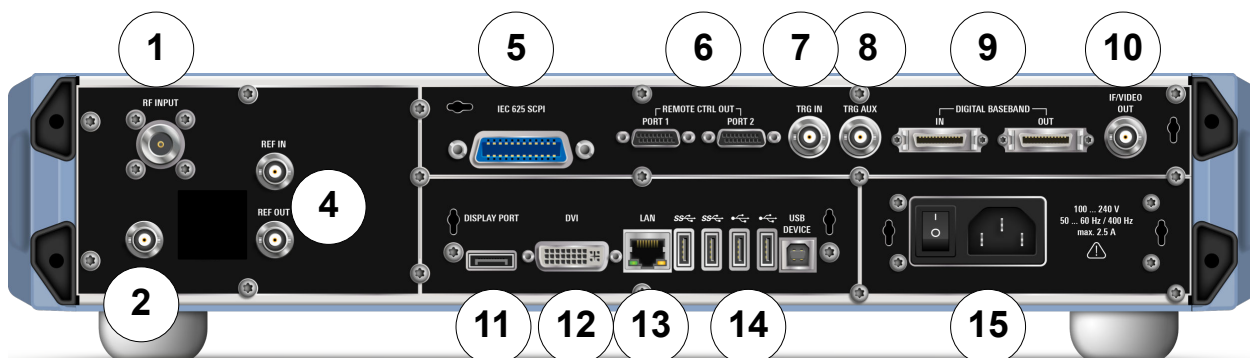

Figure 4-2: Rear panel view

- 1 = RF Input 50 Ω connector (optionally front or rear panel)
- 2 = NOISE SOURCE CONTROL
- 4 = REF INPUT/OUTPUT connectors
- 5 = IEC 625 (GPIB) SCPI interface
- 6 = Remote Control Out Ports 1/2 (currently not available)
- 7 = TRG IN connector
- 8 = TRG AUX connector
- 9 = DIGITAL BASEBAND INPUT/OUTPUT connectors (option B17, currently not available)
- 10 = IF/VIDEO out connector
- 11 = DISPLAY PORT for external display
- 12 = DVI connector for external display
- 13 = LAN connector
- 14 = USB (DEVICE) connectors
- 15 = AC Power Supply Connection and Main Power Switch

4.2.2.1 RF INPUT 50 Ω

A device under test (DUT) can be connected to the R&S FPS to provide RF input which is then analyzed. The DUT is connected to the instrument's RF INPUT via a cable equipped with an appropriate connector.

The RF Input connector may be provided on the front or rear panel, as requested by the customer.

NOTICE

Risk of instrument damage

Do not overload the input. For maximum allowed values, see the data sheet. For AC-coupling, a DC input voltage of 50 V must never be exceeded. For DC-coupling, DC voltage must not be applied at the input. In both cases, noncompliance will destroy the input mixers.

4.2.2.2 NOISE SOURCE CONTROL

The noise source control female connector is used to provide the supply voltage for an external noise source, e.g., to measure the noise figure and gain of amplifiers and frequency converting devices.

Conventional noise sources require a voltage of +28 V in order to be switched on and 0 V to be switched off. The output supports a maximum load of 100 mA.

4.2.2.3 REF INPUT / REF OUTPUT

The REF INPUT connector is used to provide an external reference signal to the R&S FPS.

The REF OUTPUT connector can be used to provide an external reference signal (or the OCXO reference signal) from the R&S FPS to other devices that are connected to this instrument.

Connector	Reference signal	Usage
REF INPUT	1...20 MHz 0...10 dBm	To provide an external reference signal on the R&S FPS.
REF OUTPUT	10 MHz 10 dBm	To provide the internal reference signal from the R&S FPS to another device continuously. Also used to provide OCXO reference signal to another device.

4.2.2.4 GPIB (SCPI) Remote Control Connector

The IEC 625 GPIB interface is in compliance with IEEE488 and SCPI. A computer for remote control of the R&S FPS can be connected via this interface. For more details refer to [Chapter 4.4, "Controlling the R&S FPS Remotely"](#), on page 50.

4.2.2.5 TRIGGER INPUT / OUTPUT

The female TRG IN connector for external trigger or gate input is used to control the measurement by means of an external signal. The voltage levels can range from 0.5 to 3.5 V. The default value is 1.4 V. The typical input impedance is 10 k Ω .

The female BNC TRG AUX connector can be used to receive a second external signal or to provide a signal to another device. The signal is TTL compatible (0 V / 5 V). You can control the connector usage in the "Trigger" settings (TRIG key).

4.2.2.6 IF/VIDEO OUTPUT

The female BNC connector can be used for various outputs:

- Intermediate frequency (IF) output of approximately 20 MHz
- Video output (1V)

Which output is provided is defined in the software (INPUT/OUTPUT key). For details see the User Manual.

4.2.2.7 DISPLAY PORT and DVI

You can connect an external monitor or other display device to the R&S FPS to operate the instrument from a remote PC (see also [Chapter 4.4.6, "How to Set Up Remote Desktop"](#), on page 70).

Two different types of connectors are provided for this purpose:

- DISPLAY PORT
- DVI (Digital visual interface)

4.2.2.8 LAN

The LAN interface can be used to connect the R&S FPS to a local network for remote control, printouts and data transfer. The assignment of the RJ-45 connector supports twisted-pair category 5 UTP/STP cables in a star configuration (UTP stands for *unshielded twisted pair*, and STP for *shielded twisted pair*).

For details see [Chapter 11, "Network and Remote Operation"](#), on page 574.

4.2.2.9 USB

The rear panel provides four additional female USB (USB-A) connectors to connect devices like a keyboard, a mouse or a memory stick (see also ["USB"](#) on page 36). The two left-most connectors provide USB 3.0 interfaces.

Furthermore, a male USB DEVICE connector (USB-B) is provided, for example to connect a printer.

4.2.2.10 AC Power Supply Connection and Main Power Switch

An AC power supply connector and main power switch are located in a unit on the rear panel of the instrument.

Main power switch function:

Position 1: The instrument is in operation.

Position O: The entire instrument is disconnected from the AC power supply.

For details refer to [Chapter 4.1.1.4, "Connecting the AC Power"](#), on page 24.

4.2.3 Additional Hardware Options Without External Connectors

Some additional hardware options are available which have no external connectors and are not visible on the outside of the R&S FPS.

- [OCXO Option \(R&S FPS-B4\)](#).....41
- [Bandwidth Extension 160 MHz \(R&S FPS-B160\)](#).....41

4.2.3.1 OCXO Option (R&S FPS-B4)

This option generates a 10 MHz reference signal with a very precise frequency. If installed, and if no external signal is used, this signal is used as an internal reference.



Warm-up time for OCXO

When the instrument is switched on, the OCXO requires an extended warm-up time (see data sheet).

4.2.3.2 Bandwidth Extension 160 MHz (R&S FPS-B160)

The signal analysis bandwidth of the R&S FPS can be extended by a hardware option (R&S FPS-B160). The bandwidth extension allows for a linear bandwidth up to a maximum of 160 MHz with an output sample rate of up to 10 GHz. While the extension can be activated or deactivated manually in the R&S FPS base unit (I/Q Analyzer application), it is activated automatically in some applications that also support I/Q data analysis. See the application-specific documentation for details.

4.3 Miniature Display

The R&S FPS is equipped with a miniature display on the front panel (see also "[Mini display](#)" on page 36).

The display provides the following information:

- The serial number, firmware version and model of the instrument
- The IP address of the instrument
- The GPIB address of the instrument
- System messages, for example when errors occur

Furthermore, it provides the following functions directly on the instrument:

- Configuring network settings, including LXI and GPIB parameters
- Performing selftests, self alignment
- Resetting the instrument to a predefined state
- Changing display settings



The miniature front panel display is meant as a service interface, not for measurement display. If the display fails for any reason, switch the instrument off and back on again to restore the display.

Note that any error messages *caused by the Windows 7 operating system* are not displayed on the miniature front panel display. They are only visible on an external monitor or via RemoteDesktop from a controller PC. Thus, if operation of the R&S FPS seems to fail for no obvious reason, try connecting a monitor or a controller PC to check for any messages awaiting confirmation or action.

(See [Chapter 4.1.3, "Connecting USB Devices"](#), on page 30 or [Chapter 4.4.6, "How to Set Up Remote Desktop"](#), on page 70)

4.3.1 Functions and Settings in the Mini Display Menu

The following functions and settings are available via the menu in the R&S FPS's mini display.



Some of the following functions are also available in manual mode via the soft front panel, see [Chapter 11, "Network and Remote Operation"](#), on page 574 and [Chapter 10, "General Instrument Setup"](#), on page 532.

Network.....	43
L Computer Name.....	43
L DHCP.....	43
L IP Address.....	43
L Subnet Mask.....	43
System commands.....	44
L Preset.....	44
L Self align.....	44
L Selftest.....	44
L LAN Reset.....	44
L Clear All Messages	45
L Reboot.....	45
L Enable NormalUser/Disable NormalUser.....	45
L Enable SecureUser/Disable SecureUser.....	45
GPIB.....	46
L GPIB Address.....	46
LXI parameters.....	46
L Version.....	46
L Features.....	47
L Computer Name.....	47
L MAC.....	47
L IP.....	47
L ICMP/VXI-11 Discovery.....	47
System messages.....	47
Display.....	47
L Backlight saving.....	47
L Normal/inverse color.....	47

Info.....	48
L Serial.....	48
L FW version.....	48
L Model.....	48
L uC version.....	48

Network

Configures the settings for operation in a local area network (LAN), for example to control the instrument from a remote PC or use a network printer.

NOTICE! Risk of network problems. All network parameters can be edited by the administrator ("Instrument" user) only. Beware that changing the computer name has major effects in a network.

For details, see [Chapter 4.4, "Controlling the R&S FPS Remotely"](#), on page 50.

Computer Name ← Network

Each instrument is delivered with an assigned computer name, but this name can be changed. The naming conventions of Windows apply. If too many characters and/or numbers are entered, an error message is displayed in the status line.

The default instrument name is a non-case-sensitive string with the following syntax:

<Type><variant>-<serial_number>

For example FPS13-123456

The serial number can be found on the rear panel of the instrument. It is the third part of the device ID printed on the bar code sticker:



DHCP ← Network

Switches between DHCP server available (On) or not available (Off). If a DHCP server is available in the network, the IP address and subnet mask of the instrument are obtained automatically from the DHCP server.

IP Address ← Network

Defines the IP address. The TCP/IP protocol is preinstalled with the IP address 10.0.0.10. If the DHCP server is available ("DHCP On"), the setting is read-only.

The IP address consists of four number blocks separated by dots. Each block contains 3 numbers in maximum (e.g. 100.100.100.100), but also one or two numbers are allowed in a block (as an example see the preinstalled address).

Subnet Mask ← Network

Defines the subnet mask. The TCP/IP protocol is preinstalled with the subnet mask 255.255.255.0. If the DHCP server is available ("DHCP On"), this setting is read-only.

The subnet mask consists of four number blocks separated by dots. Each block contains 3 numbers in maximum (e.g. 100.100.100.100), but also one or two numbers are allowed in a block (as an example see the preinstalled address).

System commands

Provides basic system functions.

Preset ← System commands

When delivered, the R&S FPS has a default configuration. You can restore this defined initial state at any time as a known starting point for measurements. This is often recommendable as a first step in troubleshooting when unusual measurement results arise.

Remote command:

*RST or SYSTem:PRESet

Self align ← System commands

Starts recording correction data for the instrument. If the correction data acquisition fails or if the correction values are deactivated, a corresponding message is displayed in the status field.

For details see [Chapter 10.1.1, "Basics on Alignment"](#), on page 532.

Remote command:

*CAL? on page 619, see also CALibration[:ALL]? on page 971

Selftest ← System commands

If the R&S FPS fails you can perform a self test of the instrument to identify any defective modules.

Once the self test is started, all modules are checked consecutively and the test result is displayed.

Remote command:

*TST? on page 622

DIAGnostic:SERVice:STEST:RESult? on page 974

LAN Reset ← System commands

Resets the LAN configuration to its default settings (LCI function).

According to the LXI standard, an LCI must set the following parameters to a default state.

Parameter	Value
TCP/IP Mode	DHCP + Auto IP Address
Dynamic DNS	Enabled
ICMP Ping	Enabled
Password for LAN configuration	LxiWebIfc

The LAN configuration can be reset to its default settings directly on the instrument via the R&S FPS's mini display ("System commands" > "LAN reset"), or in the "Network" tab of the "Network + Remote" dialog box or using the instrument's LXI Browser interface.

Remote command:

[SYSTem:LXI:LANReset](#) on page 988

Clear All Messages ← System commands

Deletes all system messages.

Remote command:

[SYSTem:ERRor:CLEar:ALL](#) on page 991

Reboot ← System commands

Reboots the instrument, including the operating system.

Remote command:

[SYSTem:REBoot](#) on page 1001

Enable NormalUser/Disable NormalUser ← System commands

Activates or deactivates the "NormalUser" account.

The NormalUser can only be activated by a user with administrator rights.

If enabled, the R&S FPS requires a reboot and then automatically logs in using the "NormalUser" account (indicated by "NormUsr" in the miniature display.).

The "NormalUser" is a standard user account with limited functionality. In particular, administrative tasks such as LAN configuration or general instrument settings are not available. Refer to the description of the basic instrument setup (SETUP menu) to find out which functions are affected.

If disabled, the R&S FPS requires a reboot. The R&S FPS attempts to login using the "Instrument" (administrator) account. You must enter the administrator ("Instrument" user) password on the R&S FPS (default: "894129"). For details see ["To enter a password"](#) on page 49.

Note: Deactivated auto-login function. If the auto-login function is deactivated and the R&S FPS is rebooted, you require an external monitor and keyboard and a Remote-Desktop access on the R&S FPS to enter the password. Otherwise, the Windows operating system will not complete login and the R&S FPS remains inoperable.

For details see ["Automatic Login Function"](#) on page 27

Enable SecureUser/Disable SecureUser ← System commands

Activates or deactivates the secure user mode.

The secure user mode can only be activated or deactivated by a user with administrator rights. You must enter the administrator ("Instrument" user) password on the R&S FPS (default: "894129"). For details see ["To enter a password"](#) on page 49.

If enabled, the R&S FPS requires a reboot and then automatically logs in using the "SecureUser" account (indicated by "SecUsr" in the miniature display.)

For a "SecureUser", data that the R&S FPS normally stores on the solid-state drive is redirected to volatile memory instead. Data that is stored in volatile memory can be accessed by the user during the current instrument session; however, when the instrument's power is removed, all data in volatile memory is erased. Administrative tasks are not allowed by the "SecureUser".

Before you activate secure user mode, store any instrument settings that are required beyond the current session, such as predefined instrument settings, transducer files, or self-alignment data.

If disabled, the R&S FPS requires a reboot and then automatically logs in using the "Instrument" (administrator) account.

Note: Deactivated auto-login function. If the auto-login function is deactivated and the R&S FPS is rebooted, you require an external monitor and keyboard and a Remote-Desktop access on the R&S FPS to enter the password. Otherwise, the Windows operating system will not complete login and the R&S FPS remains inoperable.

For details see ["Automatic Login Function"](#) on page 27

For details on the secure user mode see [Chapter 4.1.6, "Protecting Data Using the Secure User Mode"](#), on page 33.

Remote command:

`SYSTem:SECurity[:STATe]` on page 994

Note: Initially after installation of the R&S FPS-K33 option, secure user mode must be enabled manually once before remote control is possible.

GPIO

Alternatively to connecting the R&S FPS to a LAN, the GPIO interface can be used to connect a remote PC.

For details see [Chapter 4.4.1.2, "GPIO Interface \(IEC 625/IEEE 418 Bus Interface\)"](#), on page 56).

GPIO Address ← GPIO

Defines the GPIO address. Values from 0 to 30 are allowed. The default address is 20.

Remote command:

`SYSTem:COMMunicate:GPIO[:SELF]:ADDRess` on page 985

LXI parameters

On the R&S FPS the LXI Class C functionality is already installed and enabled; thus, the instrument can be accessed via any web browser (e.g. the Microsoft Internet Explorer), for example to change the LAN settings using the LXI Web browser interface.

Note that LXI parameters are not available for the "SecureUser" or "NormalUser" accounts (see ["Enable NormalUser/Disable NormalUser"](#) on page 45 and ["Enable SecureUser/Disable SecureUser"](#) on page 45). See also the restrictions mentioned in ["LXI Web Browser Interface"](#) on page 54.

Version ← LXI parameters

Displays the current LXI version on the R&S FPS (read-only).

Features ← LXI parameters

Displays the extended LXI features installed on the R&S FPS (read-only).

Computer Name ← LXI parameters

Each instrument is delivered with an assigned computer name, but this name can be changed. The naming conventions of Windows apply. If too many characters and/or numbers are entered, an error message is displayed in the status line.

The default instrument name is a non-case-sensitive string with the following syntax:

<Type><variant>-<serial_number>

For example FPS13-123456

The serial number can be found on the rear panel of the instrument. It is the third part of the device ID printed on the bar code sticker:

**MAC ← LXI parameters**

Media Access Control address (MAC address), a unique identifier for the network card in the R&S FPS

IP ← LXI parameters

IP address of the R&S FPS as defined in the operating system (see also "IP Address" on page 43).

ICMP/VXI-11 Discovery ← LXI parameters

"ICMP" indicates whether the ping responder is active or not.

If "VXI-11 Discovery" is enabled, connected devices are detected automatically using the VXI-11 protocol.

(See "VXI-11 Protocol" on page 53).

System messages

Displays the system messages generated by the R&S FPS.

The messages are displayed in the order of their occurrence; the most recent messages are placed at the top of the list.

Display

Provides functions for the display itself.

Backlight saving ← Display

If enabled, the backlight of the display is turned off to save energy.

Normal/inverse color ← Display

Switches between a display with light characters on a dark background (normal) or dark characters on a light background (inverted).

Info

Provides information on the R&S FPS installation.

This information can be useful when problems occur with the instrument and you require support from Rohde & Schwarz.

Serial ← Info

Serial number of the R&S FPS

FW version ← Info

Currently installed firmware version

Model ← Info

Instrument model

uC version ← Info

Microcontroller version

4.3.2 Working with the Miniature Instrument Display

Using the miniature display on the front panel of the R&S FPS you can change basic instrument settings and perform hardware functions directly on the instrument, without additional devices such as a controller PC or external monitor.

To display a particular setting in the menu

The information and configuration settings are displayed in a hierarchical menu structure.

- ▶ To navigate within the menu structure, do one of the following:
 - Press the <Up Arrow> and <Down Arrow> keys to scroll through the menus.
 - Press the ENTER key to select a particular menu item (either to edit a setting or to select the submenu).
 - Press the ESC key to move back up in the menu structure.

To edit a configuration value

1. Navigate to the required menu item as described in "[To display a particular setting in the menu](#)" on page 48.
2. Press the ENTER key to select the displayed configuration setting and switch to edit mode.
3. To change the value, do one of the following:
 - Press the <Up Arrow> and <Down Arrow> keys to scroll through the available entry values (e.g. digits in an IP address).
 - Press the <Left Arrow> and <Right Arrow> keys to scroll within the entry (e.g. to the second or third part of the IP address).
 - Press the DEL key to delete the character to the left of the cursor.
4. Press the ENTER key again to store the entry and exit the edit mode.

To enter a password

For some functions you must enter the administrator ("Instrument" user) password on the R&S FPS (default: "894129").

1. Navigate to the required menu item as described in ["To display a particular setting in the menu"](#) on page 48.
2. Press the ENTER key to select the function.
3. For each character in the password:
 - a) Press the <Up Arrow> and <Down Arrow> keys to scroll through the available characters.
 - b) When the required character appears, press the <Right Arrow> key to move to the next character.
The currently selected character is displayed normally, all others are hidden by asterisks (*) for discretion.
4. When the password is complete, press the ENTER key again to store the entry and exit the edit mode.

4.3.3 Configuring the Display Settings

This section describes how to configure basic display settings on the R&S FPS. For further basic instrument settings see the R&S FPS User Manual.

To change the display colors

You can switch between a display with light characters on a dark background (normal) or dark characters on a light background (inverted).

1. In the R&S FPS's mini display menu, navigate to "Display" > "Normal/inverse colors" and press the ENTER key.
2. Use the <Left Arrow> and <Right Arrow> keys to toggle the setting.
3. Press the ENTER key again to store the entry and exit the edit mode.

To turn off the display backlight

You can turn off the backlight of the display to save energy.

1. In the R&S FPS's mini display menu, navigate to "Display" > "Backlight saving" and press the ENTER key.
2. Use the <Left Arrow> and <Right Arrow> keys to toggle the setting.
3. Press the ENTER key again to store the entry and exit the edit mode.

4.4 Controlling the R&S FPS Remotely

Since the R&S FPS was designed without a screen (except for the mini display for basic information and settings), it will typically be used to perform measurements under remote control. However, the developers of such programs will find it convenient to get familiar with the instrument and its functions using manual operation initially, and then design the programs accordingly. Once developed and tested, the programs can be executed from a remote PC, with no manual interaction required. The computer that is used for remote control is called "controller" here.



All instrument functions and settings, as well as any background information, are described for manual operation, assuming an external keyboard, mouse and monitor are connected, or a controller PC with Remote Desktop is being used.

Various methods for remote control are supported:

- Connecting the instrument to a (LAN) network (see [Chapter 4.4.2, "How to Configure a Network"](#), on page 61)
- Using the LXI browser interface in a LAN network (see [Chapter 4.4.2.3, "How to Configure the LAN Using the LXI Web Browser Interface"](#), on page 63)
- Using the Windows Remote Desktop application in a LAN network (see [Chapter 4.4.6, "How to Set Up Remote Desktop"](#), on page 70)

For details on remote control interfaces see [Chapter 4.4.1, "Remote Control Interfaces and Protocols"](#), on page 51

Remote operation

Remote operation of the instrument from a connected computer is possible using SCPI commands. Sending remote commands requires the instrument to be configured in a LAN network or connected to a PC via the GPIB interface as described in [Chapter 4.4.2, "How to Configure a Network"](#), on page 61 and [Chapter 4.4.5, "How to Start a Remote Control Session from a PC"](#), on page 69.

Manual operation via Remote Desktop

Remote Desktop is a Windows application which can be used to access and control the instrument from a remote computer through a LAN connection. While the R&S FPS is in operation, the instrument's graphical results and control elements are displayed on the remote computer, and Remote Desktop provides access to all of the applications, files, and network resources of the instrument. Thus, remote (manual) operation of the instrument is possible. The following tasks can be performed using Remote Desktop:

- Access to the control functions via a virtual front panel
- Printout of measurement results directly from the controller
- Storage of measured data on the controller's hard disk

This documentation provides basic instructions on setting up the Remote Desktop for the R&S FPS. For details refer to the Windows 7 operating system documentation.

4.4.1 Remote Control Interfaces and Protocols

The instrument supports different interfaces and protocols for remote control. The following table gives an overview.

Table 4-2: Remote control interfaces and protocols

Interface	Protocols, VISA ^{*)} address string	Remarks
Local Area Network (LAN)	<ul style="list-style-type: none"> • HiSLIP High-Speed LAN Instrument Protocol (IVI-6.1) TCPIP::host address::hislip0[::INSTR] • VXI-11 TCPIP::host address::inst0[::INSTR] Library: VISA • socket communication (Raw Ethernet, simple Telnet) TCPIP::host address[::LAN device name]::<port>::SOCKET Library: VISA or socket controller 	<p>A LAN connector is located on the rear panel of the instrument.</p> <p>The interface is based on TCP/IP and supports various protocols.</p> <p>For a description of the protocols refer to:</p> <p>VXI-11 Protocol</p> <p>HiSLIP Protocol</p> <p>Socket Communication</p>
GPIB (IEC/IEEE Bus Interface)	<p>VISA^{*)} address string:</p> <p>GPIB::primary address[::INSTR]</p> <p>(no secondary address)</p>	<p>A GPIB bus interface according to the IEC 625.1/IEEE 488.1 standard is located on the rear panel of the instrument.</p> <p>For a description of the interface refer to 4.4.1.2 GPIB Interface (IEC 625/IEEE 418 Bus Interface).</p>
USB	<p>VISA^{*)} address string:</p> <p>USB::<vendor ID>::<product_ID>::<serial_number>[::INSTR]</p>	<p>USB connectors are located on the front and rear panel of the instrument.</p> <p>For a description of the interface refer to 4.4.1.3 USB Interface.</p>

^{*)} VISA is a standardized software interface library providing input and output functions to communicate with instruments. A VISA installation on the controller is a prerequisite for remote control using the indicated interfaces.
(See also [Chapter 4.4.1.4, "VISA Libraries"](#), on page 60).



Within this interface description, the term GPIB is used as a synonym for the IEC/IEEE bus interface.

4.4.1.1 LAN Interface

To be integrated in a LAN, the instrument is equipped with a LAN interface, consisting of a connector, a network interface card and protocols. The network card can be operated with the following interfaces:

- 10 Mbit/s Ethernet IEEE 802.3
- 100 Mbit/s Ethernet IEEE 802.3u
- 1Gbit/s Ethernet IEEE 802.3ab

For remote control via a network, the PC and the instrument must be connected via the LAN interface to a common network with TCP/IP network protocol. They are connected using a commercial RJ45 cable (shielded or unshielded twisted pair category 5). The TCP/IP network protocol and the associated network services are preconfigured on the

instrument. Software for instrument control and the VISA program library must be installed on the controller.

VISA library

Instrument access is usually achieved from high level programming platforms using VISA as an intermediate abstraction layer. VISA encapsulates the low level VXI, GPIB, LAN or USB function calls and thus makes the transport interface transparent for the user. See [Chapter 4.4.1.4, "VISA Libraries"](#), on page 60 for details.

The R&S FPS supports various LAN protocols such as LXI, RSIB, raw socket or the newer HiSLIP protocol.

IP address

Only the IP address or a valid DNS host name is required to set up the connection. The host address is part of the "VISA resource string" used by the programs to identify and control the instrument.

The VISA resource string has the form:

```
TCPIP::host address[::LAN device name][::INSTR]
```

or

```
TCPIP::host address::port::SOCKET
```

where:

- **TCPIP** designates the network protocol used
- **host address** is the IP address or host name of the device
- **LAN device name** defines the protocol and the instance number of a sub-instrument;
 - `inst0` selects the VXI-11 protocol (default)
 - `hislip0` selects the newer HiSLIP protocol
- **INSTR** indicates the instrument resource class (optional)
- **port** determines the used port number
- **SOCKET** indicates the raw network socket resource class

Example:

- Instrument has the IP address `192.1.2.3`; the valid resource string using VXI-11 protocol is:

```
TCPIP::192.1.2.3::INSTR
```
- A raw socket connection can be established using:

```
TCPIP::192.1.2.3::5025::SOCKET
```



Identifying instruments in a network

If several instruments are connected to the network, each instrument has its own IP address and associated resource string. The controller identifies these instruments by means of the resource string.

For details on configuring the LAN connection, see [Chapter 4.4.2, "How to Configure a Network"](#), on page 61.

• VXI-11 Protocol	53
• HiSLIP Protocol	53
• Socket Communication	53
• LXI Web Browser Interface	54

VXI-11 Protocol

The VXI-11 standard is based on the ONC RPC (Open Network Computing Remote Procedure Call) protocol which in turn relies on TCP/IP as the network/transport layer. The TCP/IP network protocol and the associated network services are preconfigured. TCP/IP ensures connection-oriented communication, where the order of the exchanged messages is adhered to and interrupted links are identified. With this protocol, messages cannot be lost.

HiSLIP Protocol

The HiSLIP (**H**igh **S**peed **L**AN **I**nstrument **P**rotocol) is the successor protocol for VXI-11 for TCP-based instruments specified by the IVI foundation. The protocol uses two TCP sockets for a single connection - one for fast data transfer, the other for non-sequential control commands (e.g. `Device Clear` or `SRQ`).

HiSLIP has the following characteristics:

- High performance as with raw socket network connections
- Compatible IEEE 488.2 support for Message Exchange Protocol, Device Clear, Serial Poll, Remote/Local, Trigger, and Service Request
- Uses a single IANA registered port (4880), which simplifies the configuration of firewalls
- Supports simultaneous access of multiple users by providing versatile locking mechanisms
- Usable for IPv6 or IPv4 networks



Using VXI-11, each operation is blocked until a VXI-11 device handshake returns. However, using HiSLIP, data is sent to the device using the "fire and forget" method with immediate return. Thus, a successful return of a VISA operation such as `viWrite()` does not guarantee that the instrument has finished or started the requested command, but is delivered to the TCP/IP buffers.

For more information see also the application note:

[1MA208: Fast Remote Instrument Control with HiSLIP](#)

Socket Communication

An alternative way for remote control of the software is to establish a simple network communication using sockets. The socket communication, also referred to as "Raw Ethernet communication", does not necessarily require a VISA installation on the remote controller side. It is available by default on all operating systems.

The simplest way to establish socket communication is to use the built-in telnet program. The telnet program is part of every operating system and supports a communication with the software on a command-by-command basis. For more convenience and to enable automation by means of programs, user-defined sockets can be programmed.

Socket connections are established on a specially defined port. The socket address is a combination of the IP address or the host name of the instrument and the number of the port configured for remote-control. All R&S FPS use port number 5025 for this purpose. The port is configured for communication on a command-to-command basis and for remote control from a program.

LXI Web Browser Interface

LAN eXtensions for Instrumentation (LXI) is an instrumentation platform for measuring instruments and test systems that is based on standard Ethernet technology. LXI is intended to be the LAN-based successor to GPIB, combining the advantages of Ethernet with the simplicity and familiarity of GPIB. The LXI browser interface allows for easy configuration of the LAN and remote control of the R&S FPS without additional installation requirements.

The instrument's LXI web browser interface works correctly with all W3C compliant browsers.

Via the LXI browser interface to the R&S FPS you can control the instrument remotely from another PC. Manual instrument controls are available via the front panel simulation. File upload and download between the instrument and the remote PC is also available. Using this feature, several users can access *and operate* the R&S FPS simultaneously. This is useful for troubleshooting or training purposes.

For details, see [Chapter 4.4.2.3, "How to Configure the LAN Using the LXI Web Browser Interface"](#), on page 63 and [Chapter 4.4.7, "How to Control the R&S FPS via the Web Browser Interface"](#), on page 77.



If you do not want other users in the LAN to be able to access and operate the R&S FPS you can deactivate this function.

See [Chapter 4.4.8, "How to Deactivate the Web Browser Interface"](#), on page 79.



Restrictions

Only user accounts with administrator rights can use the LXI functionality.

For details, see [Chapter 4.1.2.3, "Login"](#), on page 26.

To configure the LAN interface using the LXI web browser Interface, a controller PC or an external monitor, mouse and keyboard must be connected to the R&S FPS. The settings required to set up this function are available directly on the R&S FPS, via the mini display.

If no external monitor is connected to the R&S FPS, an additional driver is required on the instrument in order to control the R&S FPS via its web browser interface. If the driver is not available, the browser shows only a black screen.

Download the **TightVNC DFMirage driver** from the official TightVNC website (<http://www.tightvnc.com/download.php>) and install it on the R&S FPS as described on the website.

The current R&S FPS firmware was tested with the TightVNC DFMirage driver version 2.0.301.

To display the LXI web browser interface

- ▶ Type the host name or IP address of the instrument in the address field of the browser on your PC, for example "http://10.113.10.203".

The instrument home page (welcome page) opens.

Note: If only a black screen is displayed in the browser, install the required driver (see ["Restrictions"](#) on page 55).

The screenshot displays the LXI web browser interface. The browser address bar shows the URL <http://10.113.10.203/web/html/ihp.php>. The page title is "Instrument Home Page". The interface features the Rohde & Schwarz logo and the LXI logo. A navigation menu on the left includes sections for LXI (Home, Lan Configuration, Status, Utilities), Instrument Control (Web Control, File Download, File Upload), License Manager (Manage Licenses), and Help (Glossary, www.rohde-schwarz.com). The main content area is titled "Instrument Properties" and displays the following information:

Instrument Model	R&S FPS Spectrum Analyzer
Manufacturer	Rohde & Schwarz GmbH & Co. KG
Serial Number	100005
Description	R&S FPS-100005
LXI Version	1.4 LXI Core 2011
LXI Extended Features	LXI HISLIP
DNS Host Name(s)	[REDACTED]
MAC Address	[REDACTED]
IP Address	10. [REDACTED]
Firmware Revision	1.40a 28 Beta
Current Time	Wednesday, 2015/06/03, 10:36:46
Current Time source	Operating System
VISA resource string	TCPIP::10.[REDACTED]:inst0::INSTR TCPIP::10.[REDACTED]:hislip0::INSTR
Device Indicator	<input type="button" value="INACTIVE (press to toggle)"/>

At the bottom of the page, the status is "No error" and the copyright notice reads "© 2015 ROHDE&SCHWARZ. All rights reserved."

The navigation pane of the browser interface contains the following elements:

- "LXI"
 - "Home" opens the instrument home page.
The home page displays the device information required by the LXI standard, including the VISA resource string in read-only format.
The "Device Indicator" button allows you to physically identify the instrument. This is useful if you have several instruments and want to know which instrument the LXI home page belongs to. To identify the instrument, activate the "Device Indicator" . Then check the "LAN Status" indicator of the instruments.
 - "LAN Configuration" allows you to configure LAN parameters and to initiate a ping.
(See ["Ping Client"](#) on page 65.)
(See
 - "Status Bar" displays information about the LXI status of the instrument.
 - "Utilities" provides access to the LXI event log functionality required by the LXI standard.
- "Instrument Control"
 - "Web Control" provides remote access to the instrument via VNC (no installation required). Manual instrument controls are available via the front panel simulation.
 - "File Download" downloads files from the instrument.
 - "File Upload" uploads files to the instrument.

(See [Chapter 4.4.7, "How to Control the R&S FPS via the Web Browser Interface"](#), on page 77.)
- "License Manager"
 - "License Manager" allows you to install or uninstall license keys and to activate, register or unregister licenses.
- "Help"
 - "Glossary" explains terms related to the LXI standard.
 - "www.rohde-schwarz.com" opens the Rohde & Schwarz home page.

4.4.1.2 GPIB Interface (IEC 625/IEEE 418 Bus Interface)

By connecting a PC to the R&S FPS via the GPIB connection you can send remote commands to control and operate the instrument.

To be able to control the instrument via the GPIB bus, the instrument and the controller must be linked by a GPIB bus cable. A GPIB bus card, the card drivers and the program libraries for the programming language used must be provided in the controller. The controller must address the instrument with the GPIB bus address (see [Chapter 4.4.2.4, "How to Change the GPIB Instrument Address"](#), on page 66). You can set the GPIB address and the ID response string. The GPIB language is set as SCPI by default and cannot be changed for the R&S FPS.

Notes and Conditions

In connection with the GPIB interface, note the following:

- Up to 15 instruments can be connected
- The total cable length is restricted to a maximum of 15 m or 2 m times the number of devices, whichever is less; the cable length between two instruments should not exceed 2 m.
- A wired "OR"-connection is used if several instruments are connected in parallel.
- Any connected IEC-bus cables should be terminated by an instrument or controller.

GPIB Interface Messages

Interface messages are transmitted to the instrument on the data lines, with the attention line (ATN) being active (LOW). They are used for communication between the controller and the instrument and can only be sent by a computer which has the function of a GPIB bus controller. GPIB interface messages can be further subdivided into:

- **Universal commands:** act on all instruments connected to the GPIB bus without previous addressing
- **Addressed commands:** only act on instruments previously addressed as listeners

The following figure provides an overview of the available communication lines used by the GPIB interface.

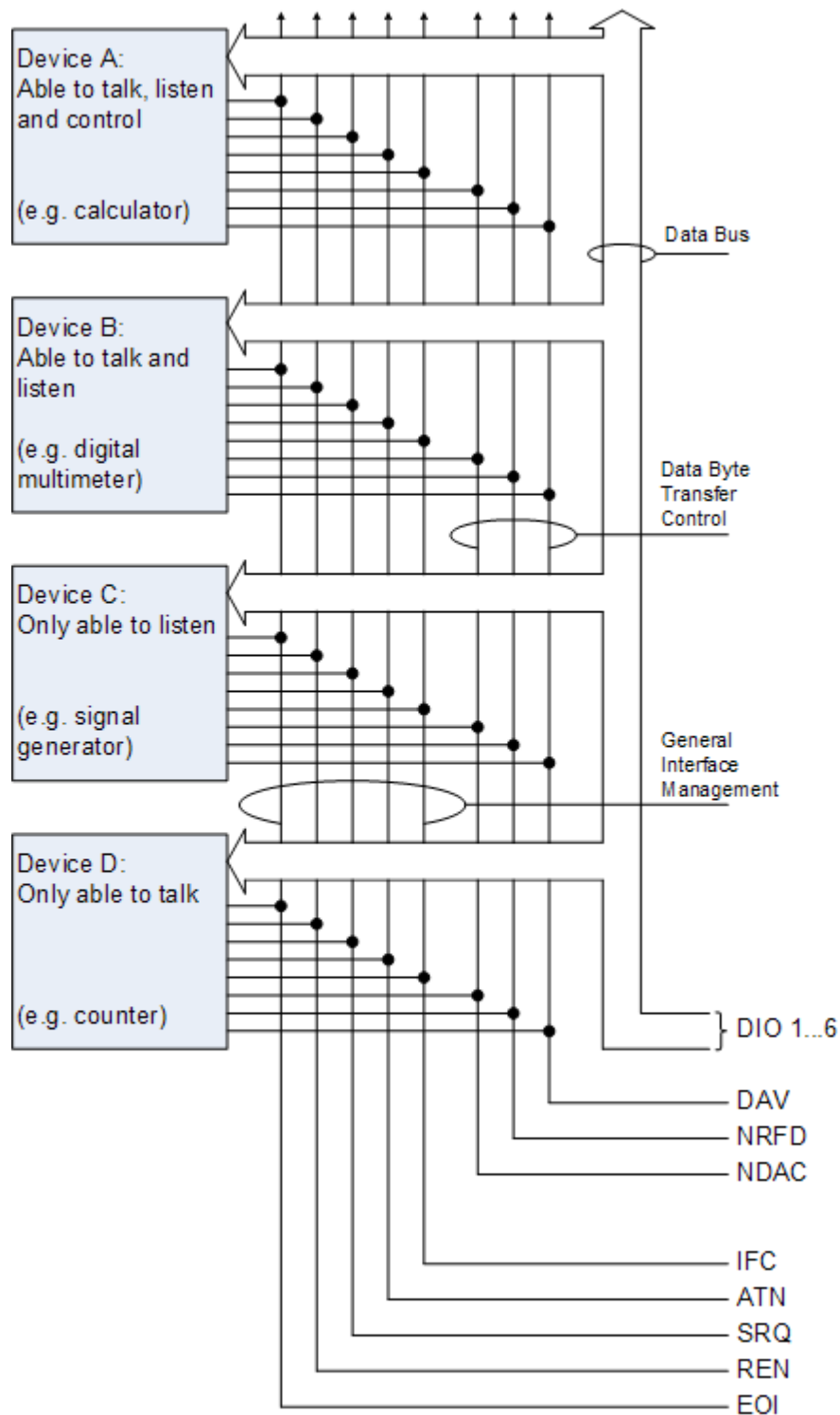

Figure 4-3: Communication lines used by the GPIB interface

Universal Commands

Universal commands are encoded in the range 10 through 1F hex. They affect all instruments connected to the bus and do not require addressing.

Command	Effect on the instrument
DCL (Device Clear)	Aborts the processing of the commands just received and sets the command processing software to a defined initial state. Does not change the instrument settings.
IFC (Interface Clear *)	Resets the interfaces to the default setting.
LLO (Local Lockout)	The "Local" softkey is disabled. Manual operation is no longer available until <code>GTL</code> is executed.
SPE (Serial Poll Enable)	Ready for serial poll.
SPD (Serial Poll Disable)	End of serial poll.
PPU (Parallel Poll Unconfigure)	End of the parallel-poll state.
*) IFC is not a real universal command, it is sent via a separate line; however, it also affects all instruments connected to the bus and does not require addressing	

Addressed Commands

Addressed commands are encoded in the range 00 through 0F hex. They only affect instruments addressed as listeners.

Command	Effect on the instrument
GET (Group Execute Trigger)	Triggers a previously active instrument function (e.g. a sweep). The effect of the command is the same as with that of a pulse at the external trigger signal input.
GTL (Go to Local)	Transition to the "local" state (manual control).
GTR (Go to Remote)	Transition to the "remote" state (remote control).
PPC (Parallel Poll Configure)	Configures the instrument for parallel poll.
SDC (Selected Device Clear)	Aborts the processing of the commands just received and sets the command processing software to a defined initial state. Does not change the instrument setting.

4.4.1.3 USB Interface

For remote control via the USB connection, the PC and the instrument must be connected via the USB type B interface. A USB connection requires the VISA library to be installed. VISA detects and configures the R&S instrument automatically when the USB connection is established. You do not have to enter an address string or install a separate driver.

USB address

The used USB address string is:

```
USB::::<product ID>::[::INSTR]
```

where:

- <vendor ID> is the vendor ID for Rohde & Schwarz (0x0AAD)
- <product ID> is the product ID for the Rohde & Schwarz instrument
- <serial number> is the individual serial number on the rear of the instrument

Table 4-3: Product IDs for R&S FPS

Instrument model	Product ID
FPS4	F9
FPS7	FA
FPS13	FB
FPS30	FC
FPS40	FD

Example:

```
USB::0x0AAD::0x00FB::100001::INSTR
```

0x0AAD is the vendor ID for Rohde&Schwarz

0x00FB is the product ID for the R&S FPS13

100001 is the serial number of the particular instrument

4.4.1.4 VISA Libraries

VISA is a standardized software interface library providing input and output functions to communicate with instruments. The I/O channel (LAN or TCP/IP, USB, ...) is selected at initialization time by one of the following:

- The channel-specific address string ("VISA resource string") indicated in [Table 4-2](#)
- An appropriately defined VISA alias (short name).

A VISA installation is a prerequisite for remote control using the following interfaces:

- [Chapter 4.4.1.2, "GPIB Interface \(IEC 625/IEEE 418 Bus Interface\)"](#), on page 56
- [Chapter 4.4.1.1, "LAN Interface"](#), on page 51
- [Chapter 4.4.1.3, "USB Interface"](#), on page 59

For more information about VISA, refer to the user documentation.

4.4.2 How to Configure a Network

NOTICE

Risk of network failure

Consult your network administrator before performing the following tasks:

- Connecting the instrument to the network
- Configuring the network
- Changing IP addresses
- Exchanging hardware

Errors can affect the entire network.

The R&S FPS is equipped with a network interface and can be connected to an Ethernet LAN (local area network). Provided the appropriate rights have been assigned by the network administrator and the Windows 7 firewall configuration is adapted accordingly, the interface can be used, for example:

- To transfer data between a controller and the tester, e.g. in order to run a remote control program; see the "Remote Control" chapter in the R&S FPS User Manual
- To access or control the measurement from a remote computer using the "Remote Desktop" application (or a similar tool); see [Chapter 4.4.6, "How to Set Up Remote Desktop"](#), on page 70
- To connect external network devices (e.g. printers)
- To transfer data from a remote computer and back, e.g. using network folders

A precondition for operating or monitoring the R&S FPS remotely is that it is connected to a LAN network or a PC connected to the GPIB interface. This is described here.



Windows Firewall Settings

A firewall protects an instrument by preventing unauthorized users from gaining access to it through a network. Rohde & Schwarz highly recommends the use of the firewall on your instrument. R&S instruments are shipped with the Windows firewall enabled and preconfigured in such a way that all ports and connections for remote control are enabled. For more details on firewall configuration see the Rohde & Schwarz White Paper [1DC01: Malware Protection](#) and the Windows 7 help system.

4.4.2.1 How to Connect the Instrument to the Network

There are two methods to establish a LAN connection to the instrument:

- A non-dedicated network (Ethernet) connection from the instrument to an existing network made with an ordinary RJ-45 network cable. The instrument is assigned an IP address and can coexist with a computer and with other hosts on the same network.

- A dedicated network connection (Point-to-point connection) between the instrument and a single computer made with a (crossover) RJ-45 network cable. The computer must be equipped with a network adapter and is directly connected to the instrument. The use of hubs, switches, or gateways is not required, however, data transfer is still performed using the TCP/IP protocol. An IP address has to be assigned to the instrument and the computer, see [Chapter 4.4.2.2, "How to Assign the IP Address"](#), on page 62.

Note: As the R&S FPS uses a 1 GBit LAN, a crossover cable is not necessary (due to Auto-MDI(X) functionality).

- ▶ To establish a non-dedicated network connection, connect a commercial RJ-45 cable to one of the LAN ports.
To establish a dedicated connection, connect a (crossover) RJ-45 cable between the instrument and a single PC.

If the instrument is connected to the LAN, Windows 7 automatically detects the network connection and activates the required drivers.

The network card can be operated with a 1 GBit Ethernet IEEE 802.3u interface.

4.4.2.2 How to Assign the IP Address

Depending on the network capacities, the TCP/IP address information for the instrument can be obtained in different ways.

- If the network supports dynamic TCP/IP configuration using the Dynamic Host Configuration Protocol (DHCP), all address information can be assigned automatically.
- If the network does not support DHCP, or if the instrument is set to use alternate TCP/IP configuration, the addresses must be set manually.

By default, the instrument is configured to use dynamic TCP/IP configuration and obtain all address information automatically. This means that it is safe to establish a physical connection to the LAN without any previous instrument configuration.

NOTICE

Risk of network errors

Connection errors can affect the entire network. If your network does not support DHCP, or if you choose to disable dynamic TCP/IP configuration, you must assign valid address information before connecting the instrument to the LAN. Contact your network administrator to obtain a valid IP address.

Assigning the IP address directly on the R&S FPS

1. In the R&S FPS's mini display, navigate to "Network" > "DHCP".
2. If DHCP is "Off", you must enter the IP address manually, as described in the following steps.

Note: When DHCP is changed from "On" to "Off", the previously set IP address and subnet mask are retrieved.

If DHCP is "On", the IP address of the DHCP server is obtained automatically. The configuration is saved, and you are prompted to restart the instrument. You can skip the remaining steps.

Note: When a DHCP server is used, a new IP address may be assigned each time the instrument is restarted. This address must first be determined on the instrument itself. Thus, when using a DHCP server, it is recommended that you use the permanent computer name, which determines the address via the DNS server.

3. In the R&S FPS's mini display, navigate to "Network" > "IP".
4. Enter the "IP Address", for example *10.0.0.10*. The IP address consists of four number blocks separated by dots. Every block contains 3 numbers in maximum. Enter the required address: Use the <Up Arrow> and <Down Arrow> keys to scroll through the digits 1-10 and the <Left Arrow> and <Right Arrow> keys to move between the individual numbers and blocks.
5. Enter the "Subnet Mask", for example *255.255.255.0*. The subnet mask consists of four number blocks separated by dots. Every block contains 3 numbers in maximum.
6. Press the ENTER key to store the entry and exit the edit mode.
7. In the R&S FPS's mini display, navigate to "System commands" > "Reboot system" to restart the system.

4.4.2.3 How to Configure the LAN Using the LXI Web Browser Interface

The instrument's LXI browser interface works correctly with all W3C compliant browsers.



If no external monitor is connected to the R&S FPS, an additional driver is required on the instrument in order to control the R&S FPS via its web browser interface. If the driver is not available, the browser shows only a black screen.

Download the **TightVNC DFMirage driver** from the official TightVNC website (<http://www.tightvnc.com/download.php>) and install it on the R&S FPS as described on the website.

The current R&S FPS firmware was tested with the TightVNC DFMirage driver version 2.0.301.

- ▶ In the web browser, open the `http://<instrument-hostname>` or `http://<instrument-ip-address>` page, e.g. `http://10.113.10.203`. The default password to change LAN configurations is *LxiWebIfc*. The "Instrument Home Page" (welcome page) opens.

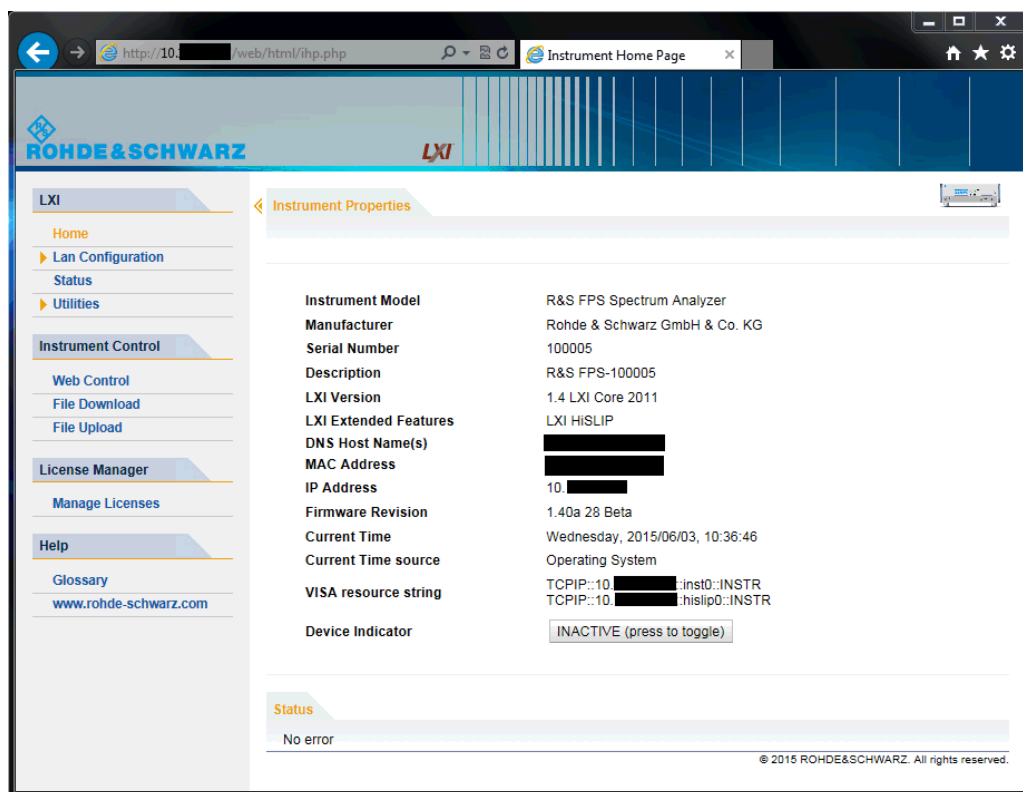

The instrument home page displays the device information required by the LXI standard including the VISA resource string in read-only format.



- ▶ Press the "Device Indicator" button on the "Instrument Home Page" to activate or deactivate the LXI status icon on the status bar of the R&S FPS. A green LXI status symbol indicates that a LAN connection has been established; a red symbol indicates an error, for example, that no LAN cable is connected. When a device is connecting to the instrument, the LXI logo blinks. The "Device Indicator" setting is not password-protected.

The most important control elements in the navigation pane of the browser interface are the following:

- "LAN Configuration" opens the menu with configuration pages.
- "Status" displays information about the LXI status of the instrument.
- "Help > Glossary" opens a document with a glossary of terms related to the LXI standard.

LAN Configuration

The LAN configuration consists of three parts:

- "IP configuration" provides all mandatory LAN parameters.
- "Advanced LAN Configuration" provides LAN settings that are not declared mandatory by the LXI standard.

- "Ping Client" provides the ping utility to verify the connection between the instrument and other devices.

IP Configuration

The "LAN Configuration > IP configuration" web page displays all mandatory LAN parameters and allows their modification.

The "TCP/IP Mode" configuration field controls how the IP address for the instrument gets assigned (see also [Chapter 4.4.2.2, "How to Assign the IP Address"](#), on page 62).

For the manual configuration mode, the static IP address, subnet mask, and default gateway are used to configure the LAN. The automatic configuration mode uses DHCP server or Dynamic Link Local Addressing (Automatic IP) to obtain the instrument IP address.



Changing the LAN configuration is password-protected. The default password is *Lxi-WebIfc* (notice upper and lower case characters).

Advanced LAN Configuration

The "LAN Configuration > Advanced LAN Configuration" parameters are used as follows:

- The "Negotiation" configuration field provides different Ethernet speed and duplex mode settings. In general, the "Auto Detect" mode is sufficient.
- "ICMP Ping" must be enabled to use the ping utility.
- "VXI-11" is the protocol that is used to detect the instrument in the LAN. According to the standard, LXI devices must use VXI-11 to provide a detection mechanism; other additional detection mechanisms are permitted.
- mDNS and DNS-SD are two additional protocols: Multicast DNS and DNS Service Discovery. They are used for device communication in zero configuration networks working without DNS and DHCP

Ping Client

Ping is a utility that verifies the connection between the LXI-compliant instrument and another device. The ping command uses the `ICMP` echo request and echo reply packets to determine whether the LAN connection is functional. Ping is useful for diagnosing IP network or router failures. The ping utility is not password-protected.

To initiate a ping between the LXI-compliant instrument and a second connected device:

1. Enable "ICMP Ping" on the "Advanced LAN Configuration" page (enabled after an LCI).
2. Enter the IP address of the second device **without the ping command and without any further parameters** into the "Destination Address" field (e.g. `10.113.10.203`).

3. Select "Submit".

4.4.2.4 How to Change the GPIB Instrument Address

In order to operate the instrument via remote control, it must be addressed using the GPIB address. The remote control address is factory-set to 20, but it can be changed if it does not fit in the network environment. For remote control, addresses 0 through 30 are allowed. The GPIB address is maintained after a reset of the instrument settings.

To change the GPIB address

1. In the R&S FPS's mini display menu, navigate to "GPIB" > "GPIB address" and press the ENTER key.
2. Enter the required address: Use the <Up Arrow> and <Down Arrow> keys to scroll through the digits 1-10 and the <Left Arrow> and <Right Arrow> keys to move between the first and second digits.
3. Press the ENTER key again to store the entry and exit the edit mode.

Remote command:

```
SYST:COMM:GPIB:ADDR 18
```

4.4.3 How to Log on to the Network

Windows 7 requires that users identify themselves by entering a user name and password in a login window. You can set up two types of user accounts, either an administrator account with unrestricted access to the computer/domain or a standard user account with limited access. The instrument provides an auto-login function for the administrator account, i.e. login with unrestricted access is carried out automatically in the background. By default, the user name for the administrator account is "Instrument", and the user name for the standard user account is "NormalUser". In both cases the initial password is "894129". You can change the password in Windows 7 for any user at any time. Some administrative tasks require administrator rights (e.g. firmware updates or the configuration of a LAN network).

Refer to [Chapter 10, "General Instrument Setup"](#), on page 532 to find out which functions are affected.

At the same time you log on to the operating system, you are automatically logged on to the network. As a prerequisite, the user name and the password must be identical on the instrument and on the network.

4.4.3.1 How to Create Users

After the software for the network has been installed, the instrument issues an error message the next time it is switched on because there is no user named "instrument" (= default user ID for Windows 7 automatic login) in the network. Thus, a matching user must be created in the R&S FPS and in the network, the password must be adap-

ted to the network password, and the automatic login mechanism must then be deactivated.



In order to configure users for the R&S FPS, a controller pc or an external monitor, mouse and keyboard must be connected to the R&S FPS. See [Chapter 4.4.6, "How to Set Up Remote Desktop"](#), on page 70.

The network administrator is responsible for creating new users in the network. A new user can be created on the instrument using the "User Account" dialog box:

1. 
Select the "Windows" icon in the toolbar to access the operating system of the R&S FPS.
 2. In the "Start" menu, select "Control Panel" and then select "User Accounts."
 3. Select "Give other users access to this computer" and then "Add".
The "Add New User" dialog box is displayed.
 4. Enter the name of the new user in the text field and select "Next".
 5. Define the level of access you want to allow the new user:
 - Select "Standard" to create an account with limited rights.
 - Select "Administrator" to create an account with administrator rights.
- Note:** Full firmware functionality requires administrator rights.
6. Select the "Finish" button.
The new user is created.

4.4.3.2 How to Change the User Password



In order to change the user passwords for the R&S FPS, a controller pc or an external monitor, mouse and keyboard must be connected to the R&S FPS. See [Chapter 4.4.6, "How to Set Up Remote Desktop"](#), on page 70.

After the new user has been created on the instrument, the password must be adapted to the network password. This is also done using the "User Accounts" dialog box.

1. 
Select the "Windows" icon in the toolbar to access the operating system of the R&S FPS.
2. Select CTRL + ALT + DELETE, then select "Change a password".
3. Enter the user account name.
4. Enter the old password.

5. Enter the new password in the upper text line and repeat it in the following line.
6. Select ENTER.
The new password is now active.

4.4.3.3 How to Activate or Deactivate the Automatic Login Mechanism



In order to activate or deactivate the automatic login mechanism on the R&S FPS, a controller pc or an external monitor, mouse and keyboard must be connected to the R&S FPS. See [Chapter 4.4.6, "How to Set Up Remote Desktop"](#), on page 70.

Deactivating the automatic login mechanism

When shipped, the instrument is already configured to automatically log on under Windows 7. To deactivate the automatic login mechanism, perform the following steps:

1. 
Select the "Windows" icon in the toolbar to access the operating system of the R&S FPS.
2. In the "Start" menu, select "Run".
The "Run" dialog box is displayed.
3. Enter the command `C:\R_S\INSTR\USER\NO_AUTOLOGIN.REG`.
4. Select the ENTER key to confirm.
The automatic login mechanism is deactivated. The next time you switch on the instrument, you are prompted to enter your user name and password before the firmware is started.

Reactivating the automatic login mechanism

1. 
Select the "Windows" icon in the toolbar to access the operating system of the R&S FPS.
2. In the "Start" menu, select "Run".
The "Run" dialog box is displayed.
3. Enter the command `C:\R_S\INSTR\USER\AUTOLOGIN.REG`.
4. Select the ENTER key to confirm.
The automatic login mechanism is reactivated. It will be applied the next time the instrument is switched on.

4.4.4 How to Share Directories (only with Microsoft Networks)

Sharing directories makes data available for other users. This is only possible in Microsoft networks. Sharing is a property of a file or directory.



In order to configure shared directories on the R&S FPS, a controller pc or an external monitor, mouse and keyboard must be connected to the R&S FPS. See [Chapter 4.4.6, "How to Set Up Remote Desktop"](#), on page 70.

- Select the "Windows" icon in the toolbar to access the operating system of the R&S FPS.
- In the "Start" menu, select "Programs", "Accessories" and then select "Windows Explorer".
- Select the desired folder with the right mouse button.
- In the context menu, select "Sharing with > Specific people".
The dialog box for sharing a directory is displayed.
- Select a user from the list or add a new name and select the "Add" button.
- Select the "Share" button.
- Select "Done" to close the dialog box.
The drive is shared and can be accessed by the selected users.

4.4.5 How to Start a Remote Control Session from a PC

When you switch on the instrument, it is always in manual operation state ("local" state) and can be operated via Remote Desktop from an external PC.

- Send an addressed command (`GTR` - Go to Remote) from a controller to the instrument.

The instrument is switched to remote control ("remote" state). Operation via the soft front panel (on the Remote Desktop) is disabled. (The keys on the R&S FPS remain enabled.) The instrument remains in the remote state until it is reset to the manual state via the remote control interface.
Switching from manual operation to remote control and vice versa does not affect the other instrument settings.
- To obtain optimum performance during remote control, send the `SYSTEM:DISPlay:UPDate OFF` command to hide the display of results and diagrams on the controller PC or external monitor (default setting in remote control).

3. To enable manual operation via the soft front panel on the Remote Desktop again, switch the instrument to local mode using the remote command `GTL` (Go to Local), that is, deactivate the `REN` line of the remote control interface.

4.4.6 How to Set Up Remote Desktop

Remote Desktop is a Windows application which can be used to access and control the instrument from a remote computer through a LAN connection. While the instrument is in operation, the instrument uses the display on the remote computer, and Remote Desktop provides access to all of the applications, files, and network resources of the instrument. Thus, remote operation of the R&S FPS is possible.

With Windows 7, Remote Desktop Client is part of the operating system. For other versions of Windows, Microsoft offers the Remote Desktop Client as an add-on.

This section provides basic instructions on setting up the Remote Desktop for the R&S FPS. For details refer to the Windows 7 operating system documentation.

4.4.6.1 How to Configure the R&S FPS for Remote Operation via Remote Desktop



By default, the R&S FPS is configured to allow Remote Desktop access by any user (except for the "SecureUser", see [Chapter 4.4.6.5, "How to Add or Remove Users to the Remote Desktop Users Group"](#), on page 75), and to use a fixed IP address.

To change the settings for remote operation, you must connect an external monitor, mouse and keyboard, or connect a controller PC and set up a Remote Desktop connection with the default settings as described in [Chapter 4.4.6.3, "How to Start and Close the Remote Desktop"](#), on page 73.

To change the settings for Remote Desktop access



To avoid problems, use a fixed IP address (see [Chapter 4.4.2.2, "How to Assign the IP Address"](#), on page 62).

When a DHCP server is used, a new IP address is assigned each time the instrument is restarted. This address must first be determined on the instrument itself. Thus, using a DHCP server is not suitable for remote operation of the R&S FPS via Remote Desktop.

1. 

Select the "Windows" icon in the toolbar to access the operating system of the R&S FPS.

2. In the "Start" menu, select the "Control Panel" and then "System and Security".
3. In the "System" area, select "Allow remote access".

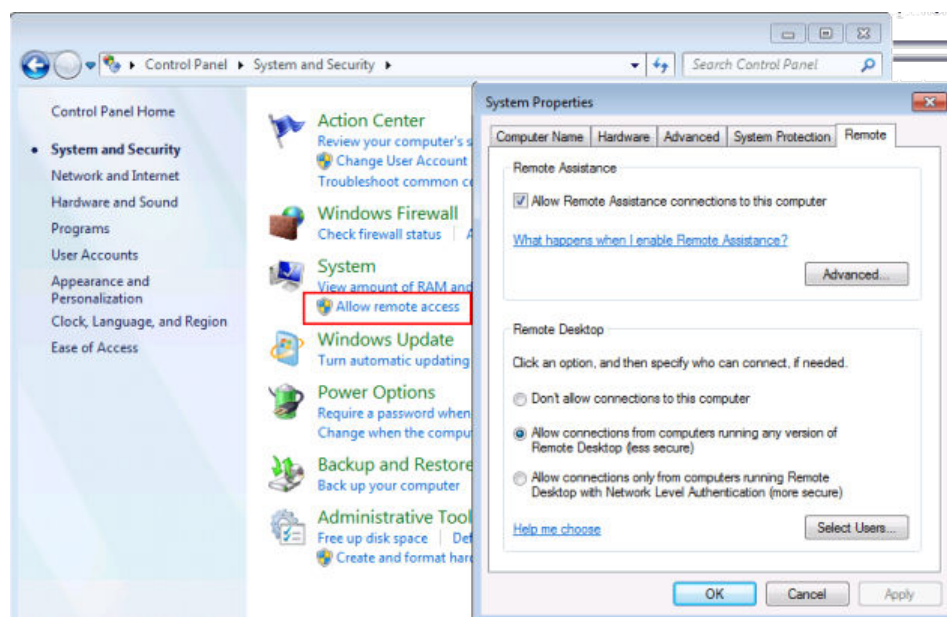

4. In the "Remote" tab, in the "Remote Desktop" area, activate the "Allow connections from computers running Remote Desktop" option.
5. Define which users are to be given access to the R&S FPS via Remote Desktop. If the secure user mode is deactivated, the "SecureUser" account is also deactivated. Thus, the procedure described here will not work for the "SecureUser". Instead, see [Chapter 4.4.6.5, "How to Add or Remove Users to the Remote Desktop Users Group"](#), on page 75.

Note: Administrator user accounts (e.g. "Instrument") are automatically enabled for Remote Desktop.

 - a) Select the "Select Users" button.
 - b) Select the users or create new user accounts as described in [Chapter 4.4.3.1, "How to Create Users"](#), on page 66.
 - c) Select "OK" to confirm the settings.
6. The R&S FPS is now ready for connection setup with the Remote Desktop program of the controller.

4.4.6.2 How to Configure the Controller



Remote Desktop Client

With Windows 7, Remote Desktop Client is part of the operating system and can be accessed via "Start > Programs > Accessories > Remote Desktop Connection".

For other versions of Windows, Microsoft offers the Remote Desktop Client as an add-on.

1. In the "Start" menu of the controller, select "All Programs > Accessories > Remote Desktop Connection".
The "Remote Desktop Connection" dialog box is displayed.
2. Select the "Options >>" button.
The dialog box is expanded to display the configuration data.

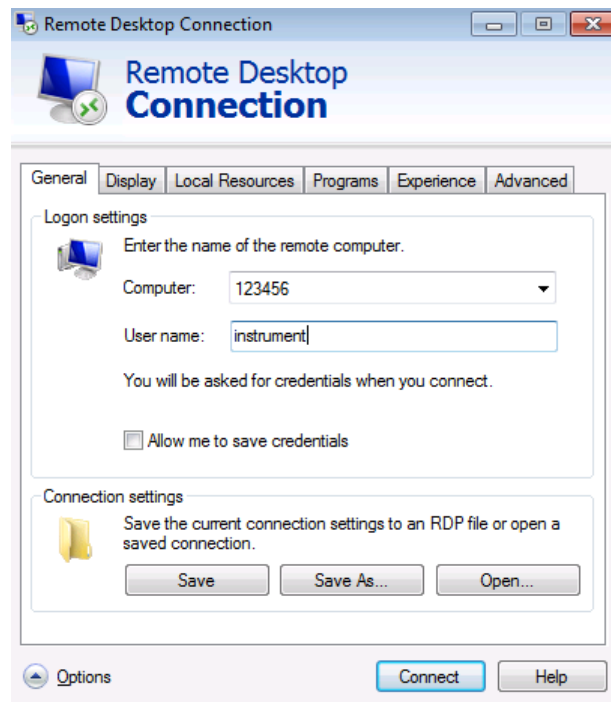

3. Open the "Experience" tab.
The settings on this tab are used to select and optimize the connection speed.
4. In the list, select the appropriate connection (for example: LAN (10 Mbps or higher)).
Depending on your selection (and how powerful the connection is), the options are activated or deactivated.
5. To improve the performance, you can deactivate the "Desktop background", "Show window contents while dragging" and "Menu and window animation" options.
6. Open the "Local Resources" tab to enable printers, local drives and serial interfaces.
7. If you will need to access drives of the controller from the R&S FPS (e.g. in order to store settings or to copy files from the controller to the R&S FPS), activate the "Disk drives" option.
Windows will then map drives of the controller to the corresponding network drives.
8. To use printers connected to the controller while accessing them from the R&S FPS, activate the "Printers" options. Do not change the remaining settings.
9. Open the "Display" tab.
The options to configure the R&S FPS screen display are displayed.

10. Under "Remote desktop size", you can set the size of the R&S FPS window on the desktop of the controller.
11. Under "Colors", do not change the settings.
12. Set the "Display the connection bar when I use the full screen" option:
If activated, a bar showing the network address of the R&S FPS will appear at the top edge of the screen. You can use this bar to reduce, minimize or close the window.
If deactivated, the only way you can return to the controller desktop from the R&S FPS screen in full screen mode is to select "Disconnect" from the "Start" menu.

4.4.6.3 How to Start and Close the Remote Desktop

To set up a connection from the controller to the R&S FPS

1. On the controller, in the "Remote Desktop Connection" dialog box (see [Chapter 4.4.6.2, "How to Configure the Controller"](#), on page 71), open the "General" tab.
2. In the "Computer" field, enter the IP address of the R&S FPS (see [Chapter 4.4.2.2, "How to Assign the IP Address"](#), on page 62 to determine the IP address).
In the "User name" field, enter *instrument* to log in as an administrator, or *Normal User* to log in as a standard user.
In the "Password" field, enter *894129*.
3. To save the connection configuration for later use:
 - a) Select the "Save As" button.
The "Save As" dialog box is displayed.
 - b) Enter the name for the connection information (*.RDP).
4. To load an existing connection configuration:
 - a) Select the "Open" button.
The "Open" dialog box is displayed.
 - b) Select the *.RDP file.
5. Select the "Connect" button.
The connection is set up.
6. If the "Disk drives" option is activated on the "Local Resources" tab, a warning is displayed indicating that the drives are enabled for access from the R&S FPS.
Select "OK" to confirm the warning.
7. After a few moments, the R&S FPS screen is displayed and manual operation is possible.
For details on manual operation see [Chapter 4.5, "Operating the Instrument in Manual Mode"](#), on page 80.

- If a dark screen appears or a dark square appears in the upper left-hand corner of the screen, you must restart the R&S FPS in order to see the modified screen resolution.

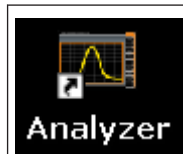

- Select the key combination ALT + F4.
- The R&S FPS firmware is shut down, which may take a few seconds.
- On the desktop, double-click the "Analyzer" icon.

The firmware restarts and then automatically opens the graphical user interface from which you can access all instrument functions and settings.

For more information see [Chapter 4.5.1.3, "Front Panels"](#), on page 83.

- After the connection is established, the R&S FPS screen is displayed in the "Remote Desktop" application window.

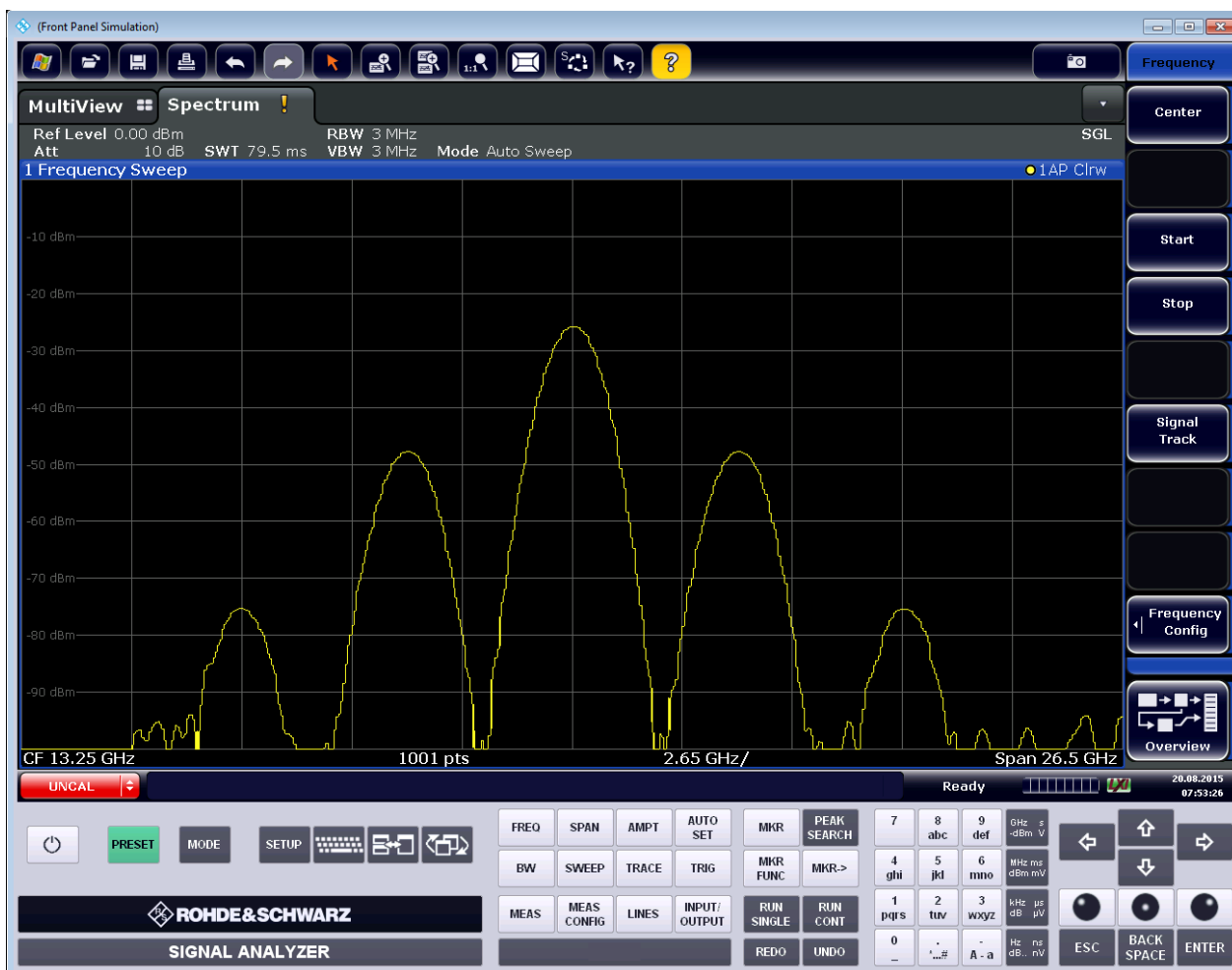

To terminate Remote Desktop control

- On the controller, close the "Remote Desktop" window at any time. The connection to the R&S FPS is terminated.

Restoring the connection to the R&S FPS

Follow the instructions above for setting up a connection to the R&S FPS. If the connection is terminated and then restored, the R&S FPS remains in the same state.

4.4.6.4 How to Shut Down the R&S FPS via Remote Desktop

1. Select the R&S FPS's soft front panel on the Remote Desktop and close the application with the key combination ALT + F4.

A safety query is displayed to warn you that the instrument cannot be reactivated via remote operation and asks you whether you want to continue the shutdown process.

2. Confirm the safety query with "Yes".
The connection with the controller is terminated and the R&S FPS is shut down.

4.4.6.5 How to Add or Remove Users to the Remote Desktop Users Group

Only users in the Remote Desktop Users Group are allowed to connect to the R&S FPS via Remote Desktop. You can add the users to this group directly when you allow remote access on the R&S FPS, as described in [Chapter 4.4.6, "How to Set Up Remote Desktop"](#), on page 70. Furthermore, you can add or remove users to this group at any time.



In order to add or remove users to the Remote Desktop users group for the R&S FPS, a controller pc or an external monitor, mouse and keyboard must be connected to the R&S FPS. See [Chapter 4.4.6, "How to Set Up Remote Desktop"](#), on page 70.



Secure User Mode

For security reasons, the "SecureUser" used in secure user mode is not allowed Remote Desktop access to the R&S FPS by default (see [Chapter 4.1.6, "Protecting Data Using the Secure User Mode"](#), on page 33). You must explicitly add the "SecureUser" to the Remote Desktop group. If you do not allow this user RemoteDesktop access, the "SecureUser" will only be able to operate the R&S FPS using remote commands or via the miniature display.

1. If necessary, disable the "SecureUser" on the R&S FPS (miniature display: "System commands > Disable SecureUser").
2. Login using the administrator ("Instrument" user) account.
3. Start a RemoteDesktop connection to the R&S FPS as described in ["To set up a connection from the controller to the R&S FPS"](#) on page 73.



Select the "Windows" icon in the toolbar to access the operating system of the R&S FPS.

5. Open the Windows Explorer.
6. Select the directory:
Control Panel\All Control Panel Items\Administrative Tools.
7. Double-click "Computer Management".

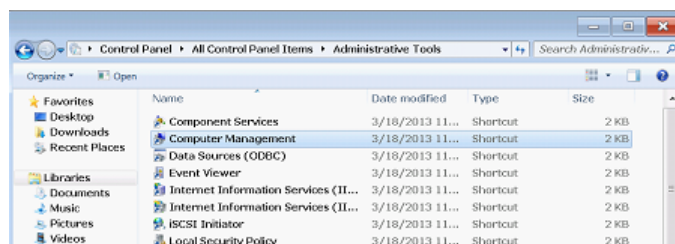

8. In the "Computer Management" dialog box, select "Local Users and Groups\Users" on the left side.

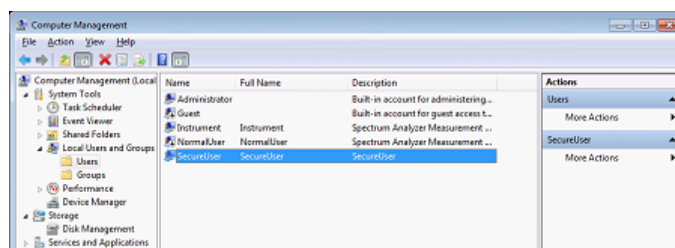

9. Double-click the user to be added, for example: "SecureUser".

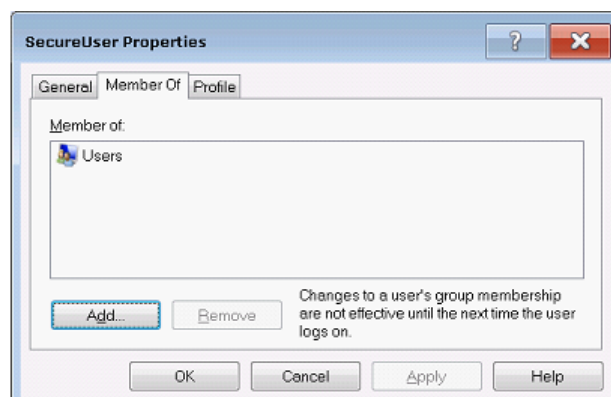

10. In the "SecureUser Properties" dialog box, switch to the "Member of" tab and click "Add".

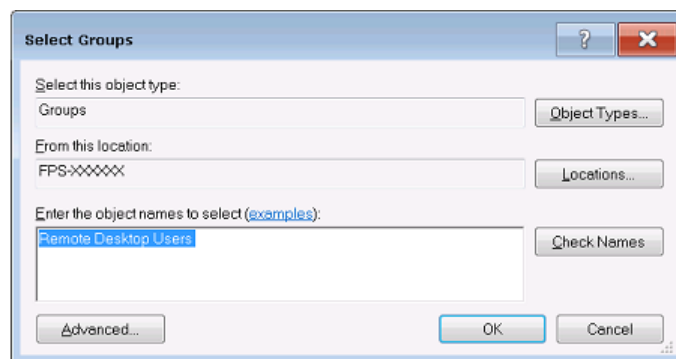

11. In the "Select Groups" dialog box, enter the "Remote Desktop Users" group and select "OK".

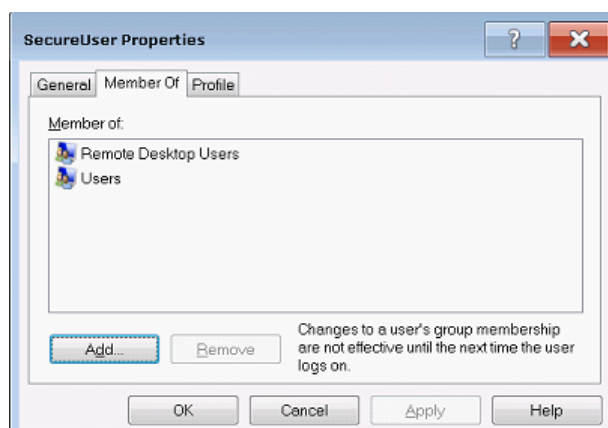

12. Select "Apply".
13. Select "OK" and close all dialog boxes.
14. Reboot the R&S FPS firmware so the changes become effective.

The new user (e.g. "SecureUser") should now be able to access the R&S FPS via RemoteDesktop.

4.4.7 How to Control the R&S FPS via the Web Browser Interface

Via the LXI browser interface to the R&S FPS one or more users can control the instrument remotely from another PC without additional installation. Most instrument controls are available via the front panel simulation. File upload and download between the instrument and the remote PC is also available.



If no external monitor is connected to the R&S FPS, an additional driver is required on the instrument in order to control the R&S FPS via its web browser interface. If the driver is not available, the browser shows only a black screen.

Download the **TightVNC DFMirage driver** from the official TightVNC website (<http://www.tightvnc.com/download.php>) and install it on the R&S FPS as described on the website.

The current R&S FPS firmware was tested with the TightVNC DFMirage driver version 2.0.301.

To access the R&S FPS via the web browser interface

1. Start a web browser that supports html5 (W3C compliant).
2. Enter the IP address of the R&S FPS in the browser's address bar.
The R&S FPS's Welcome page is displayed.
3. In the navigation pane, select "Instrument Control > Web Control".
The instrument's display is shown in a new browser window, with a software front panel displayed beside or below it.
4. Use the mouse cursor to access the functionality in the software front panel or in the display as you would directly on the instrument's front panel.

To exchange files with the R&S FPS

You can download files, for example stored measurement data, from the R&S FPS to the remote PC, or upload files, for example limit line definitions, from the PC to the R&S FPS.

1. In the web browser, select the Welcome page window.
2. In the navigation pane, select "Instrument Control" > "File Upload" or "File Download".

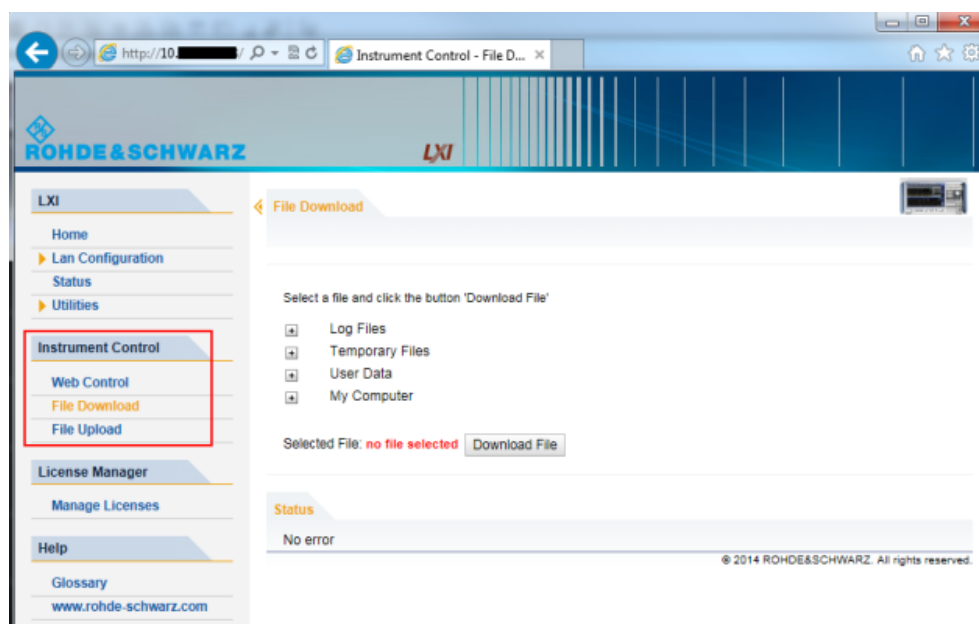

The most commonly used folders on the instrument are displayed, for example those that contain user data, as well as the top-most *My Computer* folder, from which you can access all other folders on the instrument.

3. To download a file from the R&S FPS, select the file from the displayed folders and then select "Download File".
4. To upload a file to the R&S FPS:
 - a) From the displayed folders in the web browser window, select the folder on the R&S FPS to which you want to copy a file.
 - b) Under "File to Upload", select "Browse" to open a file selection dialog box and select the required file on the PC.
 - c) Select "Upload" to copy the file from the PC to the defined folder on the R&S FPS.

4.4.8 How to Deactivate the Web Browser Interface

If you want to prevent other users in the LAN from accessing or operating the R&S FPS via its LXI web browser interface, you must deactivate this function. Note that **after a firmware update** the function is **automatically active** again until you deactivate it manually.

To deactivate the LXI web browser interface

1. 

Select the "Windows" icon in the toolbar to access the operating system.

2. In the "Start" menu, select "Control Panel".

3. Select "System and Security" > "Administrative Tools".
4. From the list on the right, select "Services".
5. From the list of local services, select "R&S TightVNC Server".

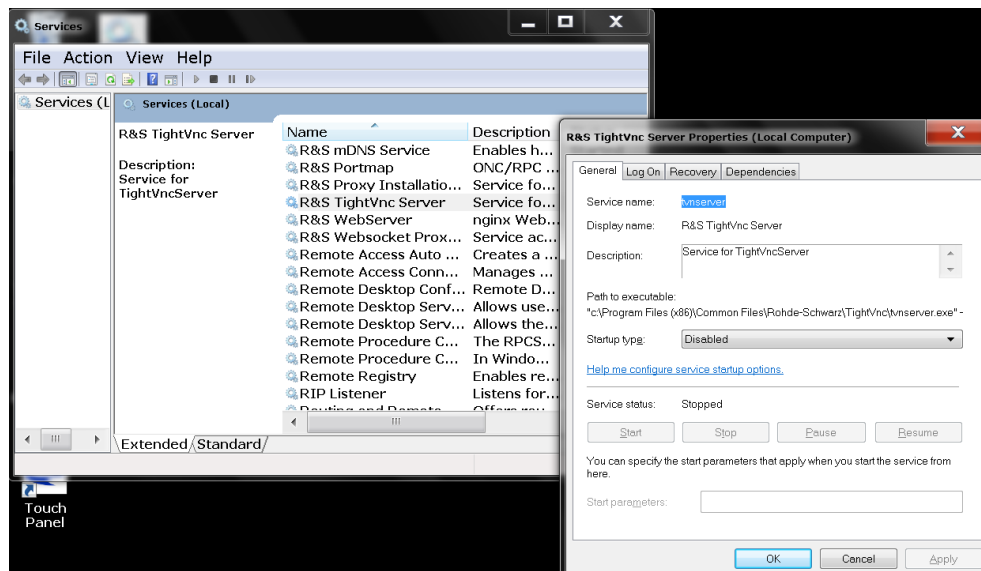

6. Set "Startup type" to "Disabled".
7. Select "Stop".
8. Select "Apply".

The next time a user enters the IP address of the instrument in a web browser, an error message is displayed:

```
Failed to connect to server (code. 1006)
```

4.5 Operating the Instrument in Manual Mode

The R&S FPS is completely remote-controlled; it does not provide a display for manual measurement control. The miniature display on the front panel of the R&S FPS allows only for very basic instrument configuration (see [Chapter 4.3, "Miniature Display"](#), on page 41).

However, although the R&S FPS does not have a built-in display for manual measurement control, it is possible to operate it interactively in manual mode using a graphical user interface on an external monitor or a controller PC.

It is recommended that you use the manual mode initially to get familiar with the instrument and its functions before using it in pure remote mode. Thus, this section describes in detail how to operate the instrument manually using a controller PC and mouse, or an external monitor, mouse and keyboard. It describes what kind of information is displayed in the diagram area, how to use the soft front panel keys and other interface elements, and how to use the Online Help.

- Graphical User Interface Elements (Soft Front Panel).....81
- Understanding the Display Information.....90
- Changing the Focus.....98
- Entering Data.....98
- Displaying Results.....100
- Getting Help.....107

4.5.1 Graphical User Interface Elements (Soft Front Panel)

All tasks necessary to operate the instrument can be performed using the graphical user interface provided by the soft front panel, a virtual front panel displayed on the external monitor or the Remote Desktop.

All measurement results are displayed. Additionally, the display provides status and setting information, allows you to switch between various measurement tasks, and provides access to all measurement functions.

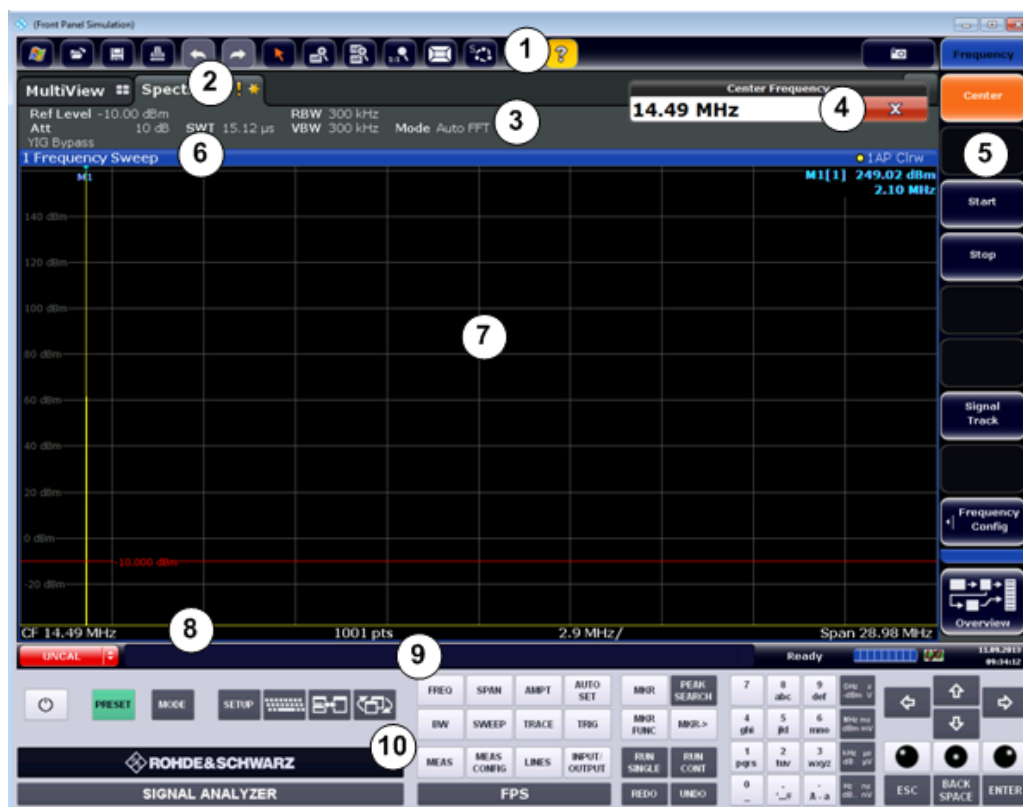

Figure 4-4: Graphical user interface elements in the R&S FPS's soft front panel

- 1 = Toolbar with standard application functions, e.g. print, save/open file etc.
- 2 = Tabs for individual measurement channels
- 3 = Channel bar for firmware and measurement settings
- 4 = Input field for measurement setting
- 5 = Softkeys for function access
- 6 = Window title bar with diagram-specific (trace) information
- 7 = Measurement results area

- 8 = Diagram footer with diagram-specific information, depending on application
- 9 = Instrument status bar with error messages, progress bar and date/time display
- 10 = Front panel with keys, keypad, navigation elements

4.5.1.1 Toolbar

Standard functions can be performed via the icons in the toolbar at the top of the screen.







You can hide the toolbar display in order to enlarge the display area for the measurement results ("Setup > Display > Displayed Items"). See the R&S FPS User Manual for details.



The following functions are available:

Table 4-4: Standard Application Functions in the Toolbar

Icon	Description
	Windows: displays the Windows "Start" menu and task bar
	Open: opens a file from the instrument ("Save/Recall" menu)
	Store: stores data on the instrument ("Save/Recall" menu)
	Print: defines print settings ("Print" menu)
	Undo: reverts last operation
	Redo: repeats previously reverted operation
	Selection mode: the cursor can be used to select (and move) markers in a zoomed display
	Zoom mode: displays a dotted rectangle in the diagram that can be expanded to define the zoom area
	Multiple zoom mode: multiple zoom areas can be defined for the same diagram
	Zoom off: displays the diagram in its original size
	SmartGrid: activates "SmartGrid" mode to configure the screen layout

Icon	Description
	Sequencer: opens the "Sequencer" menu to perform consecutive measurements
	Help (+ Select): allows you to select an object for which context-specific help is displayed
AL	Analysis line (MSRA mode only): opens a dialog box to display and position an analysis line in MSRA measurements (see R&S FPS MSRA User Manual)
	Help: displays context-sensitive help topic for currently selected element
	Print immediately: prints the current display (screenshot) as configured
In "SmartGrid" mode only:	
	Exit "SmartGrid" mode

4.5.1.2 Softkeys

Softkeys are virtual keys provided by the software. Softkeys are dynamic, i.e. depending on the selected function key, a different list of softkeys is displayed on the right side of the screen.

A list of softkeys for a certain function key is also called a menu. Softkeys can either perform a specific function or open a dialog box.

The "More" softkey indicates that the menu contains more softkeys than can be displayed at once on the screen. When selected, it displays the next set of softkeys.

Recognizing the softkey status by color

A softkey is highlighted orange when its associated dialog box is open. If it is a toggle softkey, the current state is highlighted blue. If an instrument function is not available temporarily due to a specific setting, the associated softkey is deactivated and its text is colored gray.

Some softkeys belong to a certain (firmware) option. If this option is not installed in your instrument, the associated softkeys are not displayed.



You can hide the softkey display in order to enlarge the display area for the measurement results ("Setup > Display > Displayed Items"). See the User Manual for details.

4.5.1.3 Front Panels

The virtual "Front Panel" provides (static) function keys to access basic instrument functions and softkey menus, as well as a keypad and navigation keys.

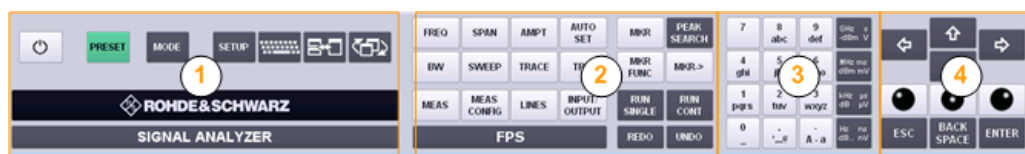

Figure 4-5: Front panel elements

- 1 = System keys
- 2 = Function keys
- 3 = Keypad
- 4 = Navigation keys

The measurement and instrument functions and settings can be accessed by selecting the corresponding keys in the front panel. To activate a key, select the key in the display using the mouse pointer.

The virtual front panel is displayed by default when you connect an external monitor or use Remote Desktop with the R&S FPS.

To toggle the front panel display, press the F6 key on the controller PC or an external keyboard.

Mini Front Panel

The Mini Front Panel displays only the basic system and function keys in a detached dialog box that can be moved around the screen.

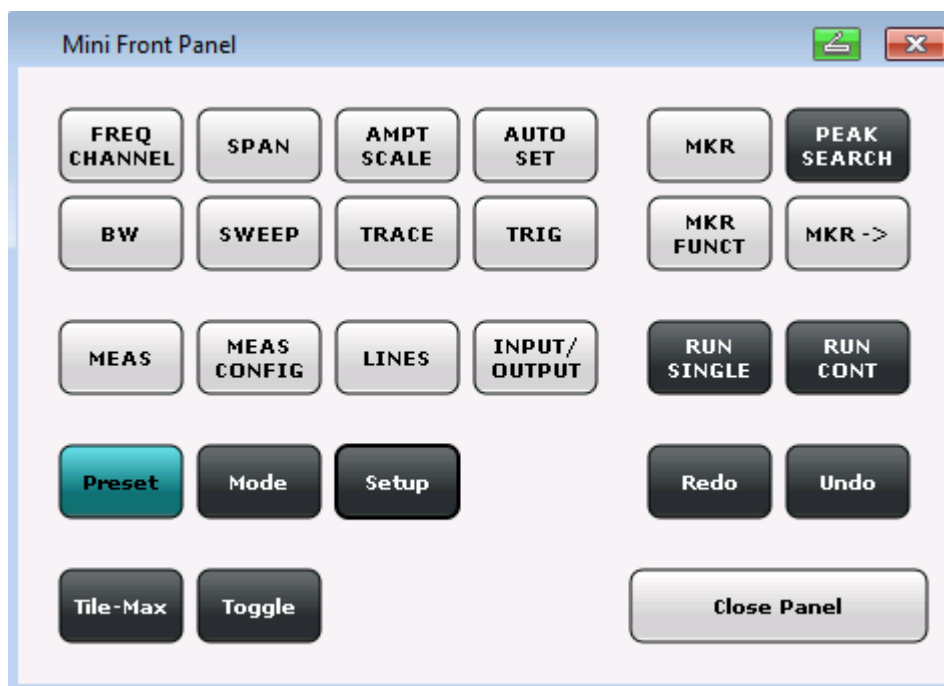

Figure 4-6: Mini Front Panel

You can close the window by selecting "Close Panel" or the key combination ALT + M (be aware of the keyboard language defined in the operating system!).

To display the front panel or mini front panel

1. If neither the default front panel nor the mini front panel are displayed, press the F6 key on the controller pc or external keyboard to access the virtual system keys.
2. Select the SETUP key and then the "Display" softkey.
3. Select the "Displayed Items" tab.
4. Select "Front Panel: On" or "Mini Front Panel: On".



- [SYSTEM Keys](#)..... 85
- [Function Keys](#)..... 85
- [Keypad](#)..... 87
- [Navigation Controls](#)..... 88

SYSTEM Keys

The virtual SYSTEM keys set the instrument to a defined state, change basic settings, and provide print and display functions.

A detailed description of the corresponding functions is provided in the R&S FPS User Manual.

Table 4-5: SYSTEM keys

SYSTEM key	Assigned functions
PRESET	Resets the instrument to the default state.
MODE	Provides the selection between applications
SETUP	Provides basic instrument configuration functions, e.g.: <ul style="list-style-type: none"> • Reference frequency (external/internal) • Date, time, display configuration • Firmware update and enabling of options • Information about instrument configuration incl. firmware version and system error messages • Service support functions
	Switches between the on-screen keyboard display: <ul style="list-style-type: none"> at the top of the screen at the bottom of the screen off
 (Tile-Max)	Switches between maximized and split (tiled) display of the focused area
 (Toggle)	Toggles the focus area between windows.

Function Keys

The virtual function keys provide access to the most common measurement settings and functions.

A detailed description of the corresponding functions is provided in the R&S FPS User Manual.

Table 4-6: Function keys

Function key	Assigned functions
Basic measurement settings	
FREQ	Sets the center frequency as well as the start and stop frequencies for the frequency range under consideration. This key is also used to set the frequency offset and the signal track function.
SPAN	Sets the frequency span to be analyzed.
AMPT	Sets the reference level, the displayed dynamic range, the RF attenuation and the unit for the level display. Sets the level offset and the input impedance. Activates the preamplifier (option RF Preamplifier, R&S FPS-B22).
AUTO SET	Enables automatic settings for level, frequency or sweep type mode.
BW	Sets the resolution bandwidth and the video bandwidth.
SWEEP	Sets the sweep time and the number of measurement points. Selects continuous measurement or single measurement.
TRACE	Configures the measured data acquisition and the analysis of the measurement data.
TRIG	Sets the trigger mode, the trigger threshold, the trigger delay, and the gate configuration in the case of gated sweep.
Marker functions	
MKR	Sets and positions the absolute and relative measurement markers (markers and delta markers).
PEAK SEARCH	Performs a peak search for active marker. If no marker is active, normal marker 1 is activated and the peak search is performed for it.
MKR FUNC	Provides additional analysis functions of the measurement markers: Frequency counter (Sig Count) Fixed reference point for relative measurement markers (Ref Fixed) Noise marker (Noise Meas) Phase noise (Phase Noise) n dB down function Peak list
MKR->	Used for search functions of the measurement markers (maximum/minimum of the trace). Assigns the marker frequency to the center frequency, and the marker level to the reference level. Restricts the search area (Search Limits) and characterizes the maximum points and minimum points (Peak Excursion).
Measurement and evaluation functions	

Function key	Assigned functions
MEAS	Provides the measurement functions. Measurement of multicarrier adjacent channel power (Ch Power ACLR) Carrier to noise spacing (C/N C/No) Occupied bandwidth (OBW) Spectrum emission mask measurement (Spectrum Emission Mask) Spurious emissions (Spurious Emissions) Measurement of time domain power (Time Domain Power) Signal statistics: amplitude probability distribution (APD) and cumulative complementary distribution function (CCDF) Third-order intercept point (TOI) AM modulation depth (AM Mod Depth)
MEAS CONFIG	Provides access to measurement configuration.
LINES	Configures display lines and limit lines.
INPUT/OUTPUT	Displays softkeys for input/output functions.
Measurement start functions	
RUN SINGLE	Starts a single new measurement (Single Sweep Mode).
RUN CONT	Starts a continuous measurement (Continuous Sweep Mode).
Function execution	
UNDO	Reverts last operation
REDO	Repeats previously reverted operation.

UNDO/REDO keys

- The virtual UNDO key reverts the previously performed action, i.e. the status before the previous action is retrieved.
The undo function is useful, for example, if you are performing a zero span measurement with several markers and a limit line defined and accidentally click the "ACP" softkey. In this case, very many settings would be lost. However, if you select UNDO immediately afterwards, the previous status is retrieved, i.e. the zero span measurement and all settings.
- The virtual REDO key repeats the previously reverted action, i.e. the most recently performed action is repeated.



The UNDO function is not available after a PRESET or "RECALL" operation. When these functions are used, the history of previous actions is deleted.

The UNDO/REDO functions are not available for some applications; see Release Notes for details.

Keypad

The virtual keypad is used to enter alphanumeric parameters, including the corresponding units (see also [Chapter 4.5.4, "Entering Data"](#), on page 98). It contains the following keys:

Table 4-7: Keys on the keypad

Type of key	Description
Alphanumeric keys	Enter numbers and (special) characters in edit dialog boxes.
Decimal point	Inserts a decimal point "." at the cursor position.
Sign key	Changes the sign of a numeric parameter. In the case of an alphanumeric parameter, inserts a "-" at the cursor position.
Unit keys (GHz/-dBm MHz/dBm, kHz/dB and Hz/dB)	These keys add the selected unit to the entered numeric value and complete the entry. In the case of level entries (e.g. in dB) or dimensionless values, all units have the value "1" as multiplying factor. Thus, they have the same function as an ENTER key.

Navigation Controls

The navigation controls include a virtual rotary knob, navigation keys, and data input function keys. They allow you to navigate within the display or within dialog boxes.



Rotary knob simulation

The virtual rotary knob has several functions:

- Increments (clockwise direction) or decrements (counter-clockwise direction) the instrument parameter at a defined step width in the case of a numeric entry.
- Shifts the selection bar within focussed areas (e.g. lists).
- Shifts markers, limit lines, etc on the screen.
- Moves the scroll bar vertically, if the scroll bar is focussed.
- Acts like the ENTER key, when it is selected.

To simulate the use of a rotary knob, use the keys displayed beneath the arrow keys:

Table 4-8: Rotary knob simulation keys

Icon	Function
	Turn left
	Enter
	Turn right

Navigation keys

The virtual navigation keys can be used alternatively to the rotary knob to navigate through dialog boxes, diagrams or tables.

Arrow Up/Arrow Down Keys

The <arrow up> or <arrow down> keys do the following:

- In a numeric edit dialog box, increase or decrease the instrument parameter.
- In a list, scroll forward and backward through the list entries.
- In a table, move the selection bar vertically.

- In windows or dialog boxes with vertical scroll bar, move the scroll bar.

Arrow Left/Arrow Right Keys

The <arrow left> or <arrow right> keys do the following:

- In an alphanumeric edit dialog box, move the cursor.
- In a list, scroll forward and backward through the list entries.
- In a table, move the selection bar horizontally.
- In windows or dialog boxes with horizontal scroll bar, move the scroll bar.

Data input keys

Some additional virtual keys are provided for data input in dialog boxes and input fields.

Table 4-9: Data input keys

Type of key	Description
ESC key	<p>Closes all kinds of dialog boxes, if the edit mode is not active. Quits the edit mode, if the edit mode is active. In dialog boxes that contain a "Cancel" button it activates that button.</p> <p>For "Edit" dialog boxes the following mechanism is used:</p> <ul style="list-style-type: none"> • If data entry has been started, it retains the original value and closes the dialog box. • If data entry has not been started or has been completed, it closes the dialog box.
BACKSPACE key	<p>If an alphanumeric entry has already been started, this key deletes the character to the left of the cursor.</p>
ENTER key	<ul style="list-style-type: none"> • Concludes the entry of dimensionless entries. The new value is accepted. • With other entries, this key can be used instead of the "Hz/dB" unit key. • In a dialog box, selects the default or focussed element.

4.5.1.4 On-screen Keyboard

The on-screen keyboard is an additional means of interacting with the instrument without having to connect an external keyboard.

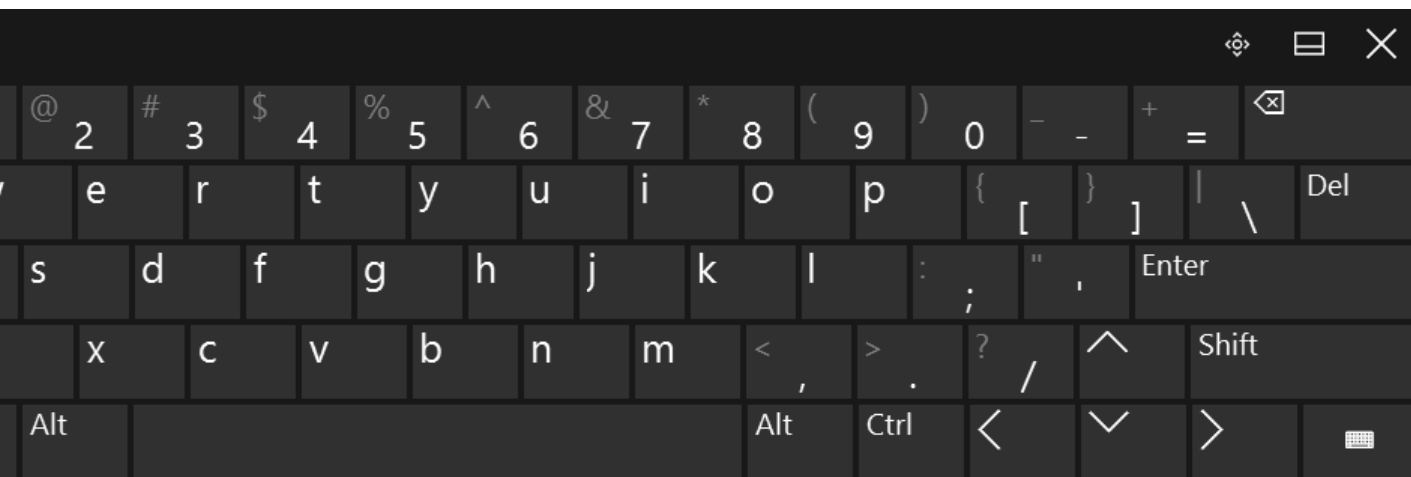

The on-screen keyboard display can be switched on and off as desired using the "On-Screen Keyboard" function key beneath the screen.



When you press this key, the display switches between the following options:

- Keyboard displayed at the top of the screen
- Keyboard displayed at the bottom of the screen
- No keyboard displayed



You can use the TAB key on the on-screen keyboard to move the focus from one field to another in dialog boxes.

4.5.2 Understanding the Display Information

The following figure shows a measurement diagram during manual analyzer operation. All different information areas are labeled. They are explained in more detail in the following sections.

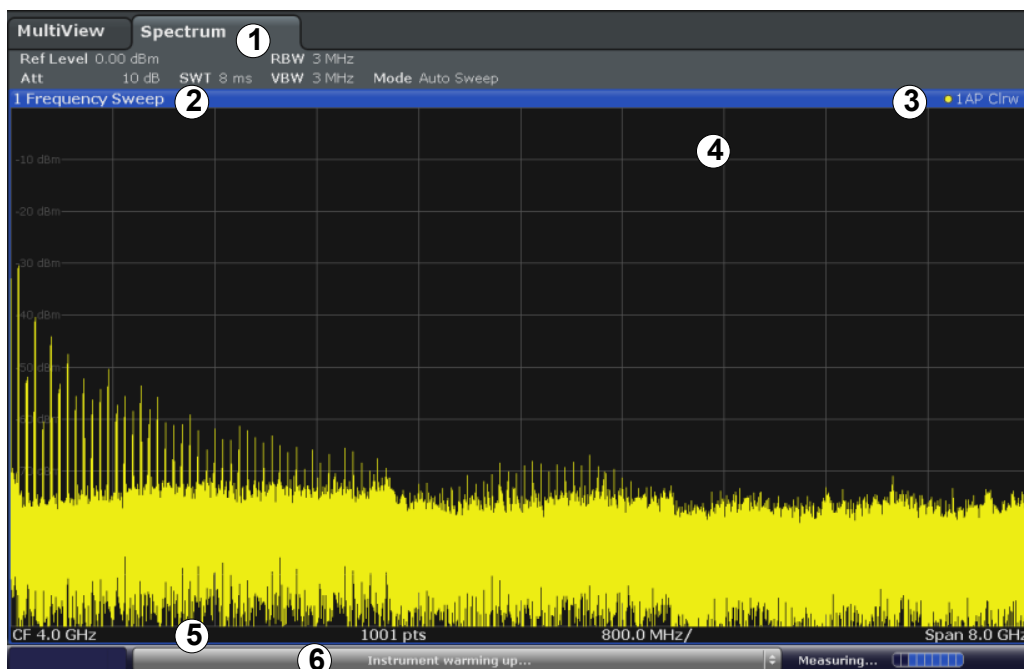

- 1 = Channel bar for firmware and measurement settings
- 2+3 = Window title bar with diagram-specific (trace) information
- 4 = Diagram area with marker information
- 5 = Diagram footer with diagram-specific information, depending on measurement application
- 6 = Instrument status bar with error messages, progress bar and date/time display

- [Channel Bar](#)..... 91
- [Window Title Bar](#)..... 94
- [Trace Information in Window Title Bar](#)..... 94
- [Marker Information](#)..... 94
- [Frequency and Span Information in Diagram Footer](#)..... 95
- [Instrument and Status Information](#)..... 96
- [Error Information](#)..... 97

4.5.2.1 Channel Bar

Using the R&S FPS you can handle several different measurement tasks (channels) at the same time (although they can only be performed asynchronously). For each channel, a separate tab is displayed on the screen. In order to switch from one channel display to another, simply select the corresponding tab.

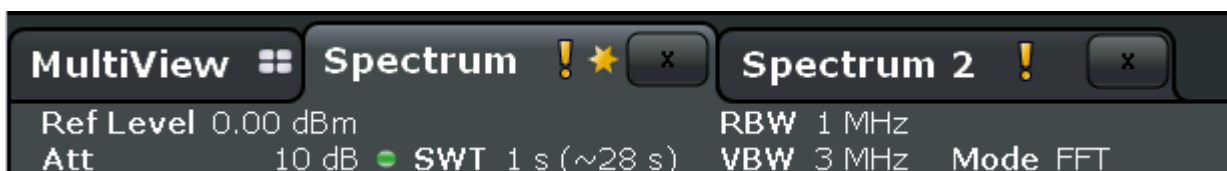



The  icon on the tab label indicates that the displayed trace no longer matches the current instrument settings. This may be the case, for example, if a trace is frozen and the instrument settings are changed. As soon as a new measurement is performed, the icon disappears.

An orange "IQ" (in MSRA mode only) indicates that the results displayed in the MSRA slave application(s) no longer match the data captured by the MSRA Master. The "IQ" disappears after the results in the slave application(s) are refreshed.

Alternatively, if many tabs are displayed, select the tab selection list icon at the right end of the channel bar and select the channel you want to switch to from the list.

Channel-specific settings

Beneath the channel name, information on channel-specific settings for the measurement are displayed in the **channel bar**. A bullet next to the setting indicates that user-defined settings are used, not automatic settings. A green bullet indicates this setting is valid and the measurement is correct. A red bullet indicates an invalid setting that does not provide useful results. Channel information varies depending on the active application.

In the Spectrum application, the R&S FPS shows the following settings:

Table 4-10: Channel settings displayed in the channel bar in the Spectrum application

Ref Level	Reference level
m.+el.Att	Mechanical and electronic RF attenuation that has been set.
Ref Offset	Reference level offset
SWT	Sweep time that has been set. If the sweep time does not correspond to the value for automatic coupling, a bullet is displayed in front of the field. The color of the bullet turns red if the sweep time is set below the value for automatic coupling. In addition, the UNCAL flag is shown. In this case, the sweep time must be increased.
Meas Time	Measurement time, calculated from analysis bandwidth and number of samples (for statistics measurements)
RBW	Resolution bandwidth that has been set. If the bandwidth does not correspond to the value for automatic coupling, a green bullet appears in front of the field.
VBW	Video bandwidth that has been set. If the bandwidth does not correspond to the value for automatic coupling, a green bullet is displayed in front of the field.
AnBW	Analysis bandwidth (for statistics measurements)
Compatible	Compatible device mode (default not displayed)
Mode	Indicates which sweep mode type is selected: <ul style="list-style-type: none"> • "Auto FFT": automatically selected FFT sweep mode • "Auto sweep": automatically selected swept sweep mode • "Sweep": manually selected frequency sweep mode • "FFT": manually selected FFT sweep mode

Common settings

In addition to the channel-specific settings, the channel bar above the diagram also displays information on instrument settings that affect the measurement results even though this is not immediately apparent from the display of the measured values. This information is displayed in gray font and only when applicable for the current measurement, as opposed to the channel-specific settings that are always displayed.

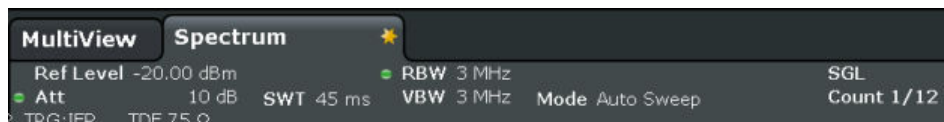

The following types of information may be displayed, if applicable.

Table 4-11: Common settings displayed in the channel bar

SGL	The sweep is set to single sweep mode.
Sweep Count	The current signal count for measurement tasks that involve a specific number of subsequent sweeps see " Sweep/Average Count " on page 370
TRG	Trigger source see " Trigger Source " on page 381 <ul style="list-style-type: none"> • EXT: External • IFP: IF power (+trigger bandwidth) • RFP: RF power • VID: Video
6dB/RRC/CHN	Filter type for sweep bandwidth see " Filter Type " on page 369
YIG Bypass	The YIG filter is deactivated.
PA	The preamplifier is activated.
GAT	The frequency sweep is controlled via the TRIGGER INPUT connector.
TDF	A transducer factor is activated.
75 Ω	The input impedance of the instrument is set to 75 Ω.
FRQ	A frequency offset ≠ 0 Hz is set.
DC/AC	An external DC or AC calibration signal is in use.
<NOR APR> Ext. Gen	An external generator is being controlled by the R&S FPS. NOR : the measurements are normalized with the results of the external generator calibration APR (approximation): the measurements are normalized with the results of the external generator calibration; however, the measurement settings have been changed since calibration If neither label is displayed, no calibration has been performed yet or normalization is not active. For details see Chapter 7.2.4, "External Generator Control" , on page 314 .
LVL	A level offset is applied to the external generator signal (only if external generator control is active).

4.5.2.2 Window Title Bar

Each channel in the R&S FPS display may contain several windows. Each window can display either a graph or a table as a result of the channel measurement. Which type of result evaluation is displayed in which window is defined in the display configuration (see [Chapter 4.5.5, "Displaying Results"](#), on page 100). The window's title bar indicates which type of evaluation is displayed.

4.5.2.3 Trace Information in Window Title Bar

Information on the displayed traces is indicated in the window title bar.

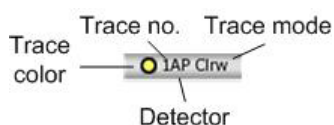

Trace color		Color of trace display in diagram
Trace no.		Trace number (1 to 6)
Detector		Selected detector:
	AP	AUTOPEAK detector
	Pk	MAX PEAK detector
	Mi	MIN PEAK detector
	Sa	SAMPLE detector
	Av	AVERAGE detector
	Rm	RMS detector
Trace Mode		Sweep mode:
	Clrw	CLEAR/WRITE
	Max	MAX HOLD
	Min	MIN HOLD
	Avg	AVERAGE (Lin/Log/Pwr)
	View	VIEW
Norm/NCor		Correction data is not used.

4.5.2.4 Marker Information

Marker information is provided either in the diagram grid or in a separate marker table, depending on the configuration.

Marker information in diagram grid

Within the diagram grid, the x and y-axis positions of the last 2 markers or delta markers that were set, if available, as well as their index are displayed. The value in the square brackets after the index indicates the trace to which the marker is assigned. (Example: M2[1] defines marker 2 on trace 1.) For more than 2 markers, a separate marker table is displayed beneath the diagram by default.

Marker information in marker table

In addition to the marker information displayed within the diagram grid, a separate marker table may be displayed beneath the diagram. This table provides the following information for all active markers:

Type	Marker type: N (normal), D (delta), T (temporary, internal)
Ref	Reference (for delta markers)
Trc	Trace to which the marker is assigned
X-value	x-value of the marker
Y-value	y-value of the marker
Func	Activated marker or measurement function
Func. Result	Result of the active marker or measurement function

The functions are indicated with the following abbreviations:

FXD	Fixed reference marker
PHNoise	Phase noise measurement
CNT	Signal count
TRK	Signal tracking
NOIse	Noise measurement
MDepth	AM modulation depth
TOI	Third order intercept measurement

4.5.2.5 Frequency and Span Information in Diagram Footer

The diagram footer (beneath the diagram) contains the following information, depending on the current application:

Label	Information
CF	Center frequency
Span	Frequency span (frequency domain display)

Label	Information
ms/	Time per division (time domain display)
Pts	Number of sweep points or (rounded) number of currently displayed points in zoom mode

4.5.2.6 Instrument and Status Information

Global instrument settings, the instrument status and any irregularities are indicated in the status bar beneath the diagram.



Hiding the status bar

You can hide the status bar display, e.g. in order to enlarge the display area for the measurement results ("Setup > Display > Displayed Items").

See [Chapter 12.10.4.1, "General Display Settings and Items"](#), on page 979.

The following information is displayed:

Instrument status

	The instrument is configured for operation with an external reference.
---	--

Progress

The progress of the current operation is displayed in the status bar.



Date and time

The date and time settings of the instrument are displayed in the status bar.



You can hide the date and time display in the status bar, or the entire status bar ("Setup > Display > Displayed Items").

For details see the R&S FPS User Manual.

Error messages

If errors or irregularities are detected, a keyword and an error message, if available, are displayed in the status bar.

4.5.2.7 Error Information

If errors or irregularities are detected, a keyword and an error message, if available, are displayed in the status bar.



Note that the status bar is only visible on an external monitor or via RemoteDesktop from a controller PC (see [Chapter 4.1.3, "Connecting USB Devices"](#), on page 30 or [Chapter 4.4.6, "How to Set Up Remote Desktop"](#), on page 70).

Depending on the type of message, the status message is indicated in varying colors.

Table 4-12: Status bar information - color coding

Color	Type	Description
red	Fatal	A serious error occurred in the application; regular operation is no longer possible.
red	Error	An error occurred during a measurement, e.g. due to missing data or wrong settings, so that the measurement cannot be completed correctly.
orange	Warning	An irregular situation occurred during measurement, e.g. the settings no longer match the displayed results, or the connection to an external device was interrupted temporarily.
gray	Information	Information on the status of individual processing steps.
gray	Message	An event or state has occurred that may lead to an error during further operation.
green	No errors	No messages displayed.



If any error information is available for a measurement channel, the  icon is displayed next to the channel name.

This is particularly useful when the MultiView tab is displayed, as the status bar in the MultiView tab always displays the information for the currently selected measurement only.

Furthermore, a status bit is set in the `STATUS:QUESTIONABLE:EXTENDED:INFO` register for the application concerned (see ["STATUS:QUESTIONABLE:EXTENDED:INFO Register"](#) on page 595). Messages of a specific type can be queried using the `SYST:ERR:EXT?` command, see [SYSTEM:ERROR:EXTENDED?](#) on page 991.

The following keywords are used:

IF OVLD	Overload of the IF signal path after the input mixer. <ul style="list-style-type: none"> Increase the reference level.
INPUT OVLD	The signal level at the RF input connector exceeds the maximum. The RF input is disconnected from the input mixer to protect the device. In order to re-enable measurement, decrease the level at the RF input connector and reconnect the RF input to the mixer input.
LOUNL	Error in the instrument's frequency processing hardware was detected.

NO REF	Instrument was set to an external reference but no signal was detected on the reference input.
OVEN	OCXO reference frequency (option R&S FPS-B4) has not yet reached its operating temperature. The message usually disappears a few minutes after power has been switched on.
RF OVLD	Overload of the input mixer. <ul style="list-style-type: none"> • Increase the RF attenuation (for RF input). • Reduce the input level (for digital input)
UNCAL	One of the following conditions applies: <ul style="list-style-type: none"> • Correction data has been switched off. • No correction values are available, for example after a firmware update. • Record the correction data by performing a self alignment (For details refer to Chapter 10.1.4, "How to Align the Instrument", on page 535).
WRONG_FW	The firmware version is out-of-date and does not support the currently installed hardware. Until the firmware version is updated, this error message is displayed and self-alignment fails. (For details refer to Chapter 10.5.4, "Firmware Updates" , on page 563).

4.5.3 Changing the Focus

Any selected function is always performed on the currently focused element in the display, e.g. a dialog field, diagram, or table row. Which element is focused is indicated by a blue frame (diagram, window, table) or is otherwise highlighted (softkey, marker etc.). Moving the focus is most easily done by selecting the element in the display using the mouse pointer. Alternatively, use the "Tab" key on the on-screen keyboard to move the focus from one element to the next on the display.



To move the focus between any displayed diagrams or tables in a window, select the "Change focus" key. The focus moves from the diagram to the first table to the next table etc. and then back to the diagram, within the same window.

4.5.4 Entering Data

Data can be entered in dialog boxes using an external keyboard or the keyboard of the controller PC.

4.5.4.1 Entering Numeric Parameters

If a field requires numeric input, the keypad provides only numbers.

1. Enter the parameter value using the keypad, or change the currently used parameter value by using the rotary knob (small steps) or the UP or DOWN keys (large steps) in the soft front panel.
2. After entering the numeric value via keypad, select the corresponding unit key. The unit is added to the entry.

3. If the parameter does not require a unit, confirm the entered value by selecting the ENTER key or any of the unit keys.
The editing line is highlighted in order to confirm the entry.

4.5.4.2 Entering Alphanumeric Parameters

If a field requires alphanumeric input, you can use the on-screen keyboard to enter numbers and (special) characters (see [Chapter 4.5.1.4, "On-screen Keyboard"](#), on page 89).

Alternatively, you can use the virtual keypad. Every alphanumeric key represents several characters and one number. The decimal point key (.) represents special characters, and the sign key (-) toggles between capital and small letters. For the assignment refer to [Table 4-13](#). In principle, the input of alphanumeric parameters works like writing an SMS on your cell phone.

To enter numbers and (special) characters via the virtual keypad

1. Select the key once to enter the first possible value.
All characters available via this key are displayed in a popup.
2. To choose a different value provided by this key, select the key again, until your desired value is displayed.
With each key stroke the next possible value of this key is displayed. If all possible values have been displayed, the series starts with the first value again. For information on the series refer to [Table 4-13](#).
3. To change from capital to small letters and vice versa, select the sign key (-).
4. After entering a value, wait for 2 seconds (to use the same key again), or start the next entry by selecting another key.

To enter a blank

- ▶ Select the "Space" bar, or select the "0" key and wait 2 seconds.

To correct an entry

1. Using the arrow keys, move the cursor to the right of the entry you want to delete.
2. Select the BACKSPACE key.
The entry to the left of the cursor is deleted.
3. Enter your correction.

To complete the entry

- ▶ Select the ENTER key or the rotary knob.

To cancel the entry

- ▶ Select the ESC key.

The dialog box is closed without changing the settings.

Table 4-13: Keys for alphanumeric parameters

Key name (upper inscription)	Series of (special) characters and number provided
7	7 μ Ω ° € ¥ \$ ¢
8	A B C 8 Å Æ Ä Ç
9	D E F 9 É
4	G H I 4
5	J K L 5
6	M N O 6 Ñ Ö
1	P Q R S 1
2	T U V 2 Ü
3	W X Y Z 3
0	<blank> 0 – @ + / \ < > = % &
.	. * : _ , ; " ' ? () #
–	<toggles between capital and small letters>

4.5.5 Displaying Results

The R&S FPS provides several instrument applications for different analysis tasks and different types of signals, e.g. 3G FDD, I/Q analysis or basic spectrum analysis. For each application, a new measurement channel is created and displayed in a separate tab on the screen.

The results of a measurement channel can be evaluated in many different ways, both graphically and numerically. For each evaluation method the results are displayed in a separate window in the tab.

The R&S FPS allows you to configure the display to suit your specific requirements and optimize analysis.

4.5.5.1 Activating channels

When you activate an application, a new measurement channel is created which determines the measurement settings for that application. The same application can be activated with different measurement settings by creating several channels for the same application. Whenever you switch channels, the corresponding measurement settings are restored. Each channel is displayed in a separate tab on the screen.

An additional tab ("MultiView") provides an overview of all currently active channels at once.

Only one measurement can be performed at any time, namely the one in the currently active channel. However, in order to perform the configured measurements consecutively, a Sequencer function is provided.

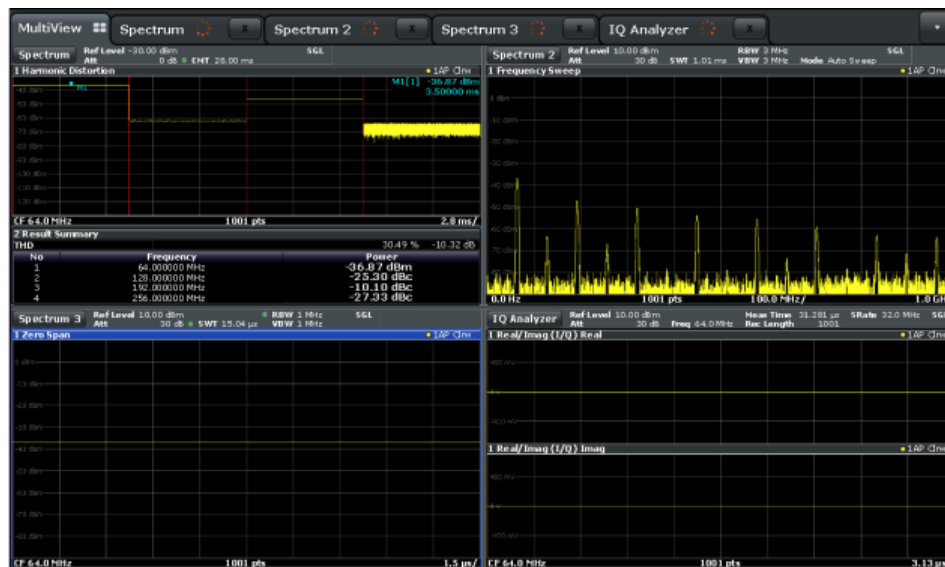

To start a new channel

1. Select the MODE key in the soft front panel.
2. In the "Mode" dialog box, select the required application on the "New Channel" tab. A new tab is displayed for the new channel.

To change the application in an active channel

1. Select the tab of the channel you want to change.
2. Select the MODE key.
3. In the "Mode" dialog box, select the new application to be displayed on the "Replace Current Channel" tab.
The selected application is displayed in the current channel.

4.5.5.2 Laying out the Result Display with the SmartGrid

Measurement results can be evaluated in many different ways, for example graphically, as summary tables, statistical evaluations etc. Each type of evaluation is displayed in a separate window in the channel tab. Up to 16 individual windows can be displayed per channel (i.e. per tab). To arrange the diagrams and tables on the screen, the Rohde & Schwarz SmartGrid function helps you find the target position simply and quickly.

Principally, the layout of the windows on the screen is based on an underlying grid, the SmartGrid. However, the SmartGrid is dynamic and flexible, allowing for many different layout possibilities. The SmartGrid functionality provides the following basic features:

- Windows can be arranged in columns or in rows, or in a combination of both.

- Windows can be arranged in up to four rows and four columns.
 - Windows are moved simply by dragging them to a new position on the screen, possibly changing the layout of the other windows, as well.
 - All evaluation methods available for the currently selected measurement are displayed as icons in the evaluation bar. If the evaluation bar contains more icons than can be displayed at once on the screen, it can be scrolled vertically. The same evaluation method can be displayed in multiple windows simultaneously.
 - New windows are added by dragging an evaluation icon from the evaluation bar to the screen. The position of each new window depends on where you drop the evaluation icon in relation to the existing windows.
 - All display configuration actions are only possible in SmartGrid mode. When SmartGrid mode is activated, the evaluation bar replaces the current softkey menu display. When the SmartGrid mode is deactivated again, the previous softkey menu display is restored.
- [Background Information: The SmartGrid Principle](#)..... 102
 - [How to Activate SmartGrid Mode](#)..... 103
 - [How to Add a New Result Window](#)..... 104
 - [How to Close a Result Window](#)..... 104
 - [How to Arrange the Result Windows](#)..... 105

Background Information: The SmartGrid Principle

SmartGrid display

During any positioning action, the underlying SmartGrid is displayed. Different colors and frames indicate the possible new positions. The position in the SmartGrid where you drop the window determines its position on the screen.

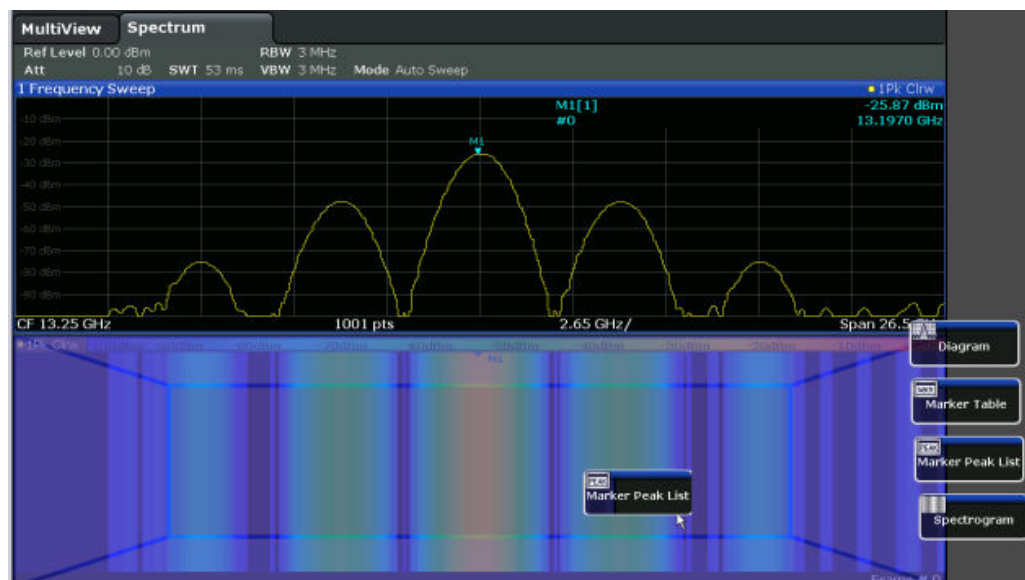

Figure 4-7: Moving a window in SmartGrid mode

The brown area indicates the possible "drop area" for the window, i.e. the area in which the window can be placed. A blue area indicates the (approximate) layout of the window as it would be if the icon were dropped at the current position. The frames indicate the possible destinations of the new window with respect to the existing windows: above/below, right/left or replacement (as illustrated in [Figure 4-8](#)). If an existing window would be replaced, the drop area is highlighted in a darker color shade.

Positioning the window

The screen can be divided into up to four rows. Each row can be split into up to four columns, where each row can have a different number of columns. However, rows always span the entire width of the screen and may not be interrupted by a column. A single row is available as the drop area for the window in the SmartGrid. The row can be split into columns, or a new row can be inserted above or below the existing row (if the maximum of 4 has not yet been reached).

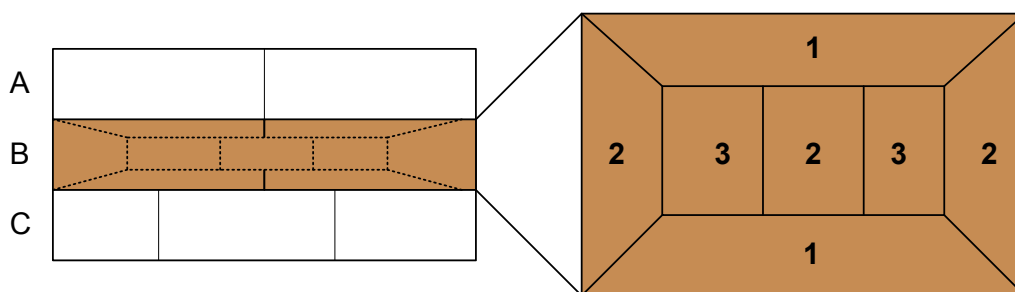

Figure 4-8: SmartGrid window positions

- 1 = Insert row above or below the existing row
- 2 = Create a new column in the existing row
- 3 = Replace a window in the existing row

SmartGrid functions

Once the evaluation icon has been dropped, icons in each window provide delete and move functions.



The "Move" icon allows you to move the position of the window, possibly changing the size and position of the other displayed windows.



The "Delete" icon allows you to close the window, enlarging the display of the remaining windows.

How to Activate SmartGrid Mode

All display configuration actions are only possible in SmartGrid mode. In SmartGrid mode the evaluation bar replaces the current softkey menu display. When the SmartGrid mode is deactivated again, the previous softkey menu display is restored.

- ▶ To activate SmartGrid mode, do one of the following:



Select the "SmartGrid" icon from the toolbar.

- Select the "Display Config" button in the configuration "Overview" .
- Select the "Display Config" softkey from the MEAS CONFIG menu.

The SmartGrid functions and the evaluation bar are displayed.



To close the SmartGrid mode and restore the previous softkey menu select the "Close" icon in the right-hand corner of the toolbar, or press any key.

How to Add a New Result Window

Each type of evaluation is displayed in a separate window. Up to 16 individual windows can be displayed per channel (i.e. per tab).

1. Activate SmartGrid mode.

All evaluation methods available for the currently selected measurement are displayed as icons in the evaluation bar.

2. Select the icon for the required evaluation method from the evaluation bar.

If the evaluation bar contains more icons than can be displayed at once on the screen, it can be scrolled vertically. Set the mouse pointer in the evaluation bar between the icons and move it up or down until the required icon appears.

3. Drag the required icon from the evaluation bar to the SmartGrid, which is displayed in the diagram area, and drop it at the required position. (See ["How to Arrange the Result Windows"](#) on page 105 for more information on positioning the window).

Remote command:

[LAYout:ADD\[:WINDow\]?](#) on page 767 / [LAYout:WINDow<n>:ADD?](#) on page 771

How to Close a Result Window

- ▶ To close a window, activate SmartGrid mode and select the "Delete" icon for the window.



Remote command:

[LAYout:REMove\[:WINDow\]](#) on page 769 / [LAYout:WINDow<n>:REMove](#) on page 772

How to Arrange the Result Windows

1. Select an icon from the evaluation bar or the "Move" icon for an existing evaluation window.



2. Drag the evaluation over the SmartGrid.
A blue area shows where the window will be placed.
3. Move the window until a suitable area is indicated in blue.
4. Drop the window in the target area.
The windows are rearranged to the selected layout, and "Delete" and "Move" icons are displayed in each window.
5. To close a window, select the corresponding "Delete" icon.



Remote command:

[LAYout:REPLace\[:WINDow\]](#) on page 769 / [LAYout:WINDow<n>:REPLace](#)
on page 772

4.5.5.3 Changing the Size of Windows

Each channel tab may contain several windows to evaluate the measurement results using different methods. A "splitter" allows you to change the size of neighboring windows.

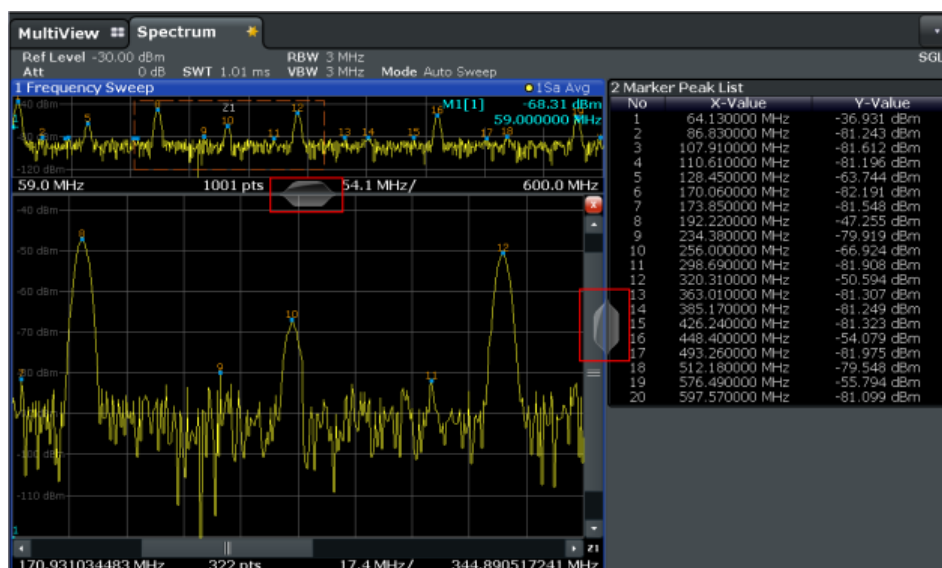

The splitters are not available in SmartGrid mode.

- ▶ To change the size of two neighboring windows, drag the splitter between the windows in either direction.

4.5.5.4 Switching Between a Split and Maximized Window Display

To get an overview of the results, displaying several windows at the same time may be helpful. However, the individual windows may become rather small. In this case it is useful to maximize an individual window to the entire screen temporarily in order to analyze the results in more detail.



To switch between a split and a maximized display without having to close and re-open windows, select the SPLIT/MAXIMIZE key. In maximized display, the currently focused window is maximized. In split display, all active windows are displayed.

4.5.5.5 Changing the Display

The display can be optimized for your individual needs. The following display functions are available and are described in detail in [Chapter 12.10.4.1, "General Display Settings and Items"](#), on page 979 and [Chapter 8, "Common Analysis and Display Functions"](#), on page 393.

- Displaying or hiding a simulation of the entire front panel of the instrument on the screen ("Soft Front Panel")
- Displaying the main function hardkeys in a separate window on the screen ("Mini Front Panel")

- Hiding or showing various screen elements
- Selecting a display theme and colors
- Changing the display update rate
- Zooming into the diagram

4.5.6 Getting Help

If any questions or problems concerning the R&S FPS arise, an extensive online help system is provided on the instrument and can be consulted at any time. The help system is context-sensitive and provides information specifically for the current operation or setting to be performed. In addition, general topics provide an overview on complete tasks or function groups as well as background information.

4.5.6.1 Calling Up Help

The online help can be opened at any time by selecting one of the "Help" icons on the toolbar or by selecting the F1 key on an external or the online keyboard.

Calling context-sensitive help

- ▶ To display the "Help" dialog box for the currently focused screen element, e.g. a softkey or a setting in an opened dialog box, select the "Help" icon on the toolbar.



The "Help" dialog box "View" tab is displayed. A topic containing information about the focused screen element is displayed.

If no context-specific help topic is available, a more general topic or the "Contents" tab is displayed.



For standard Windows dialog boxes (e.g. File Properties, Print dialog etc.), no context-sensitive help is available.

- ▶ To display a help topic for a screen element not currently focused:
 - a) Select the "Help pointer" icon on the toolbar.



The pointer changes its shape to a "?" and an arrow.

- b) Select the screen element to change the focus.

A topic containing information about the selected (now focused) screen element is displayed.

4.5.6.2 Using the Help Window

The Help window contains several tabs:

- "View" - shows the selected help topic
- "Contents" - contains a table of help contents
- "Index" - contains index entries to search for help topics
- "Search" - provides text search



The Help toolbar provides some buttons:

- To browse the topics in the order of the table of contents: Up arrow = previous topic, Down arrow = next topic
- To browse the topics visited before: Left arrow = back, Right arrow = forward
- To increase or decrease the font



To search for a topic in the index

The index is sorted alphabetically. You can browse the list, or search for entries in the list.

1. Switch to the "Index" tab.
2. Select the "Keyboard" icon besides the entry field.
3. Enter the first characters of the keyword you are interested in.
The entries containing these characters are displayed.
4. Double-click the suitable index entry.
The "View" tab with the corresponding help topic is displayed.

To search topics for a text string

1. Switch to the "Search" tab.
2. Select the "Keyboard" icon besides the entry field.
3. Enter the string you want to find.
If you enter several strings with blanks between, topics containing all words are found (same as AND operator).

For advanced search, consider the following:

- To find a defined string of several words, enclose it in quotation marks. For example, a search for *"trigger qualification"* finds all topics with exactly *"trigger qualification"*. A search for *trigger qualification* finds all topics that contain the words *trigger* and *qualification*.
- Use "Match whole word" and "Match case" to refine the search.
- Use operators AND, OR, and NOT.

To close the Help window

- ▶ Select the "Close" icon in the upper right corner of the help window.
Or: Press the ESC key.

5 Applications, Measurement Channels, and Operating Modes

The R&S FPS allows you to perform all sorts of different analysis tasks on different types of signals, e.g. W-CDMA, I/Q analysis or basic spectrum analysis. Depending on the task or type of signal, a different set of measurement functions and parameters are required. Therefore, the R&S FPS provides various applications - some of which are included in the base unit, others are optional. The default application when you start the R&S FPS is "Spectrum", for basic spectrum analysis measurements on any type of signal.

For each application, a separate measurement channel is created, which determines the measurement settings for that application. The same application can be activated with different measurement settings by creating several channels for the same application. Each channel is displayed in a separate tab on the screen.



The maximum number of measurement channels may be limited by the available memory on the instrument.

By default, each application operates independently of the others, measuring and analyzing its own distinct data. However, the R&S FPS also provides other operating modes, in which the individual applications are correlated and analyze the same set of data.

Signal and Spectrum Analyzer Mode

With the **conventional R&S FPS Signal and Spectrum Analyzer** mode, you can perform several different measurements almost simultaneously. However, the individual measurements are independent of each other - **each application captures and evaluates its own set of data**, regardless of what the other applications do.

In some cases it may be useful to **analyze the exact same input data using different applications**. For example, imagine capturing data from a base station and analyzing the RF spectrum in the Analog Demodulation application. If a spur or an unexpected peak occurs, you may want to analyze the same data in the I/Q Analyzer to see the real and imaginary components of the signal and thus detect the reason for the irregular signal. Normally when you switch to a different application, evaluation is performed on the data that was captured by that application, and not the previous one. In our example that would mean the irregular signal would be lost. Therefore, a second operating mode is available in the R&S FPS: Multi-Standard Radio Analyzer (MSRA) mode.

Multi-Standard Radio Analyzer mode

In **Multi-Standard Radio Analyzer (MSRA) mode**, data acquisition is performed once as an I/Q measurement in a master application, and the captured data is then evaluated by any number of slave applications for different radio standards. Data acquisition and global configuration settings are controlled globally, while the evaluation and display settings can be configured individually for each slave application. Using the Multi-Standard Radio Analyzer, unwanted correlations between different signal components

using different transmission standards can be detected. Thus, for example, an irregularity in a GSM burst can be examined closer in the R&S FPS 3G FDD BTS (W-CDMA) slave application to reveal dependencies like a change in the EVM value.

Distinct operating modes

Although the applications themselves are identical in all operating modes, the handling of the data between applications is not. Thus, the operating mode determines which slave applications are available and active. Whenever you change the operating mode, the currently active measurement channels are closed. The default operating mode is Signal and Spectrum Analyzer mode; however, the presetting can be changed.

Remote command:

INST:MODE SAN, see INSTRUMENT:MODE on page 626

Switching between slave applications

When you switch to a new slave application, a set of parameters is passed on from the current slave application to the new one:

- center frequency and frequency offset
- reference level and reference level offset
- attenuation

After initial setup, the parameters for the measurement channel are stored upon exiting and restored upon re-entering the channel. Thus, you can switch between slave applications quickly and easily.

5.1 Available Applications

Access: MODE

The R&S FPS provides some applications in the base unit while others are available only if the corresponding firmware options are installed. Not all R&S FPS applications are supported in MSRA mode.

For details on the MSRA operating mode, see the R&S FPS MSRA User Manual.



Spectrogram application

Spectrogram measurements are not a separate application, but rather a trace evaluation method, thus they are available as an evaluation method for the Display Configuration, not by creating a new channel. Spectrograms are configured and activated in the "Trace" settings. See [Chapter 8.5.2.1, "Working with Spectrograms"](#), on page 471 for details.

Spectrum.....	112
1xEV-DO BTS.....	112
1xEV-DO MS.....	112
3G FDD BTS.....	113

3G FDD UE.....	113
Amplifier.....	113
Analog Demodulation.....	113
cdma2000 BTS.....	113
cdma2000 MS.....	114
GSM.....	114
I/Q Analyzer.....	114
LTE.....	114
NB-IoT.....	114
Noise Figure.....	114
Phase Noise.....	115
Pulse Measurements.....	115
TD-SCDMA BTS.....	115
TD-SCDMA UE.....	115
Verizon 5GTF Measurement Application (V5GTF).....	115
Vector Signal Analysis (VSA).....	116
WLAN.....	116

Spectrum

In the Spectrum application the provided functions correspond to those of a conventional spectrum analyzer. The analyzer measures the frequency spectrum of the RF input signal over the selected frequency range with the selected resolution and sweep time, or, for a fixed frequency, displays the waveform of the video signal. This application is used in the initial configuration.

For details see [Chapter 6, "Measurements and Results"](#), on page 123.

Remote command:

INST:SEL SAN, see [INSTrument\[:SElect\]](#) on page 627

1xEV-DO BTS

The 1xEV-DO BTS application requires an instrument equipped with the 1xEV-DO BTS Measurements option, R&S FPS-K84. This application provides test measurements for 1xEV-DO BTS downlink signals (base station signals) according to the test specification.

For details see the R&S FPS-K84/-K85 User Manual.

Remote command:

INST:SEL BDO, see [INSTrument\[:SElect\]](#) on page 627

1xEV-DO MS

The 1xEV-DO MS application requires an instrument equipped with the 1xEV-DO MS Measurements option, R&S FPS-K85. This application provides test measurements for 1xEV-DO MS uplink signals (mobile signals) according to the test specification.

For details see the R&S FPS-K84/-K85 User Manual.

Remote command:

INST:SEL MDO, see [INSTrument\[:SElect\]](#) on page 627

3G FDD BTS

The 3G FDD BTS application requires an instrument equipped with the 3GPP Base Station Measurements option, R&S FPS-K72. This application provides test measurements for W-CDMA downlink signals (base station signals) according to the test specification.

For details see the R&S FPS-K72/-K73 User Manual.

Remote command:

INST:SEL BWCD, see [INSTrument\[:SElect\]](#) on page 627

3G FDD UE

The 3G FDD UE application requires an instrument equipped with the 3GPP User Equipment Measurements option, R&S FPS-K73. This application provides test measurements for W-CDMA uplink signals (mobile signals) according to the test specification.

For details see the R&S FPS-K72/-K73 User Manual.

Remote command:

INST:SEL MWCD, see [INSTrument\[:SElect\]](#) on page 627

Amplifier

The Amplifier Measurement application requires an instrument equipped with the Amplifier Measurement option R&S FPS-K18. This application provides measurements to measure the efficiency of traditional amplifiers and amplifiers that support envelope tracking with the R&S FPS.

Also available is option R&S FPS-K18D, which provides direct DPD functionality.

For details see the R&S FPS-K18 User Manual (also contains information about R&S FPS-K18D).

Remote command:

INST:SEL AMPL, see [INSTrument\[:SElect\]](#) on page 627

Analog Demodulation

The Analog Demodulation application requires an instrument equipped with the corresponding optional software. This application provides measurement functions for demodulating AM, FM, or PM signals.

For details see the R&S FPS-K7 User Manual.

Remote command:

INST:SEL ADEM, see [INSTrument\[:SElect\]](#) on page 627

cdma2000 BTS

The cdma2000 BTS application requires an instrument equipped with the cdma2000 BTS Measurements option, R&S FPS-K82. This application provides test measurements for cdma2000 BTS downlink signals (base station signals) according to the test specification.

For details see the R&S FPS-K82/-K83 User Manual.

Remote command:

INST:SEL BC2K, see [INSTrument\[:SElect\]](#) on page 627

cdma2000 MS

The cdma2000 MS application requires an instrument equipped with the cdma2000 MS Measurements option, R&S FPS-K83. This application provides test measurements for cdma2000 MS uplink signals (mobile signals) according to the test specification.

For details see the R&S FPS-K82/-K83 User Manual.

Remote command:

INST:SEL MC2K, see [INSTrument\[:SElect\]](#) on page 627

GSM

The GSM application requires an instrument equipped with the GSM Measurements option R&S FPS-K10. This application provides GSM measurements.

For details see the R&S FPS-K10 User Manual.

Remote command:

INST:SEL GSM, see [INSTrument\[:SElect\]](#) on page 627

I/Q Analyzer

The I/Q Analyzer application provides measurement and display functions for I/Q data.

For details see the R&S FPS I/Q Analyzer User Manual.

Remote command:

INST:SEL IQ, see [INSTrument\[:SElect\]](#) on page 627

LTE

The LTE application requires an instrument equipped with the LTE Measurements option R&S FPS-K10x. This application provides LTE measurements.

For details see the R&S FPS-K10x User Manuals (one for downlink, one for uplink).

Remote command:

INST:SEL LTE, see [INSTrument\[:SElect\]](#) on page 627

NB-IoT

The NB-IoT application requires an instrument equipped with the NB-IoT measurements option R&S FPS-K106. This application provides NB-IoT measurements in the downlink.

For details see the R&S FPS-K106 (NB-IoT Downlink) User Manual.

Remote command:

INST:SEL NIOT, see [INSTrument\[:SElect\]](#) on page 627

Noise Figure

The Noise Figure application requires an instrument equipped with the Noise Figure Measurements option R&S FPS-K30. This application provides noise figure measurements.

For details see the R&S FPS-K30 User Manual.

Remote command:

INST:SEL NOISE, see [INSTrument\[:SElect\]](#) on page 627

Phase Noise

The Phase Noise application requires an instrument equipped with the Phase Noise Measurements option, R&S FPS-K40. This application provides measurements for phase noise tests.

For details see the R&S FPS-K40 User Manual.

Remote command:

INST:SEL PNOISE, see [INSTrument\[:SElect\]](#) on page 627

Pulse Measurements

The Pulse application requires an instrument equipped with the Pulse Measurements option, R&S FPS-K6. This application provides measurement functions for pulsed signals.

For details see the R&S FPS-K6 User Manual.

Remote command:

INST:SEL PULSE, see [INSTrument\[:SElect\]](#) on page 627

TD-SCDMA BTS

The TD-SCDMA BTS application requires an instrument equipped with the TD-SCDMA Base Station Measurements option, R&S FPS-K76. This application provides test measurements for TD-SCDMA downlink signals (base station signals) according to the test specification.

For details see the R&S FPS-K76/-K77 User Manual.

Remote command:

INST:SEL BTDS, see [INSTrument\[:SElect\]](#) on page 627

TD-SCDMA UE

The TD-SCDMA UE application requires an instrument equipped with the TD-SCDMA User Equipment Measurements option, R&S FPS-K77. This application provides test measurements for TD-SCDMA uplink signals (mobile signals) according to the test specification.

For details see the R&S FPS-K76/-K77 User Manual.

Remote command:

INST:SEL MTDS, see [INSTrument\[:SElect\]](#) on page 627

Verizon 5GTF Measurement Application (V5GTF)

The Verizon 5GTF measurement application requires an instrument equipped with the V5GTF option, R&S FPS-K118/K119. This application provides measurements and evaluations for uplink and downlink signals according to the Verizon 5G technical forum (TS V5G.211 standard).

For details see the R&S FPS-K118/-K119 User Manual.

Remote command:

INST:SEL V5GT, see [INSTrument\[:SElect\]](#) on page 627

Vector Signal Analysis (VSA)

The VSA application requires an instrument equipped with the Vector Signal Analysis option, R&S FPS-K70. This application provides measurements and evaluations for single-carrier digitally modulated signals.

For details see the R&S FPS-K70 User Manual.

Remote command:

INST:SEL DDEM, see [INSTrument\[:SElect\]](#) on page 627

WLAN

The WLAN application requires an instrument equipped with the WLAN option, R&S FPS-K91/91n. This application provides measurements and evaluations according to the WLAN IEEE 802.11 standards.

For details see the R&S FPS-K91 User Manual.

Remote command:

INST:SEL WLAN, see [INSTrument\[:SElect\]](#) on page 627

5.2 R&S MultiView

Each application is displayed in a separate tab. An additional tab ("MultiView") provides an overview of all currently active channels at a glance. In the "MultiView" tab, each individual window contains its own channel bar with an additional button. Select this button to switch to the corresponding channel display quickly.

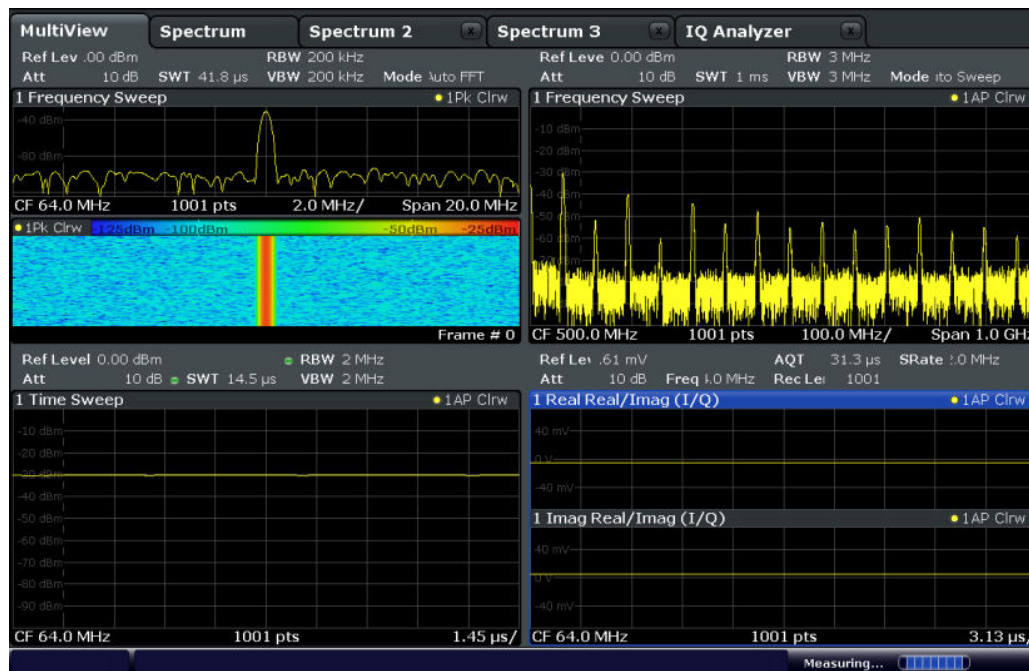

Remote command:

DISPlay:FORMat on page 766

5.3 Selecting the Operating Mode and Applications

Access: MODE

The default operating mode is Signal and Spectrum Analyzer mode, however, the pre-setting can be changed (see "Preset Mode" on page 565).

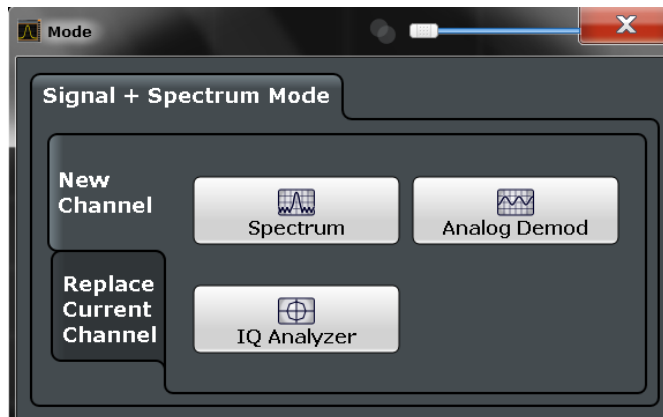

The default application in Signal and Spectrum Analyzer mode is a Spectrum measurement.

Switching between applications

When you switch to a new application, a set of parameters is passed on from the current application to the new one:

- center frequency and frequency offset
- reference level and reference level offset
- attenuation

After initial setup, the parameters for the measurement channel are stored upon exiting and restored upon re-entering the channel. Thus, you can switch between applications quickly and easily.

Switching the operating mode.....	117
Selecting an application.....	117
L New Channel.....	118
L Replace Current Channel.....	118
L Duplicate Current Channel	118
Closing an application.....	118

Switching the operating mode

To switch the operating mode, select the corresponding tab.

Remote command:

`INSTRument:MODE` on page 626

Selecting an application

To start a new or replace an existing application, select the corresponding button in the correct tab.

Note: The measurement channels are labeled with their default name. If that name already exists, a sequential number is added. You can change the name of the measurement channel by double-tapping the name in the channel bar and entering a new name.

For an overview of default names see [Table 12-2](#).

Remote command:

[INSTRument\[:SElect\]](#) on page 627

New Channel ← Selecting an application

The applications selected on this tab are started in a new measurement channel, i.e. a new tab in the display.

Remote command:

[INSTRument:CREate\[:NEW\]](#) on page 624

[INSTRument\[:SElect\]](#) on page 627

Replace Current Channel ← Selecting an application

The applications selected on this tab are started in the currently displayed measurement channel, replacing the current application.

Remote command:

[INSTRument:CREate:REPLace](#) on page 625

Duplicate Current Channel ← Selecting an application

The currently active channel can be duplicated, i.e. a new channel of the same type and with the identical measurement settings is started. The name of the new channel is the same as the copied channel, extended by a consecutive number (e.g. "Spectrum" -> "Spectrum 2").

This command is not available if the MSRA Master channel is selected.

Remote command:

[INSTRument:CREate:DUPLicate](#) on page 624

Closing an application

To close an application, simply close the corresponding tab by selecting the "x" next to the channel name.

Remote command:

[INSTRument:DELeTe](#) on page 625

5.4 Running a Sequence of Measurements

Only one measurement can be performed at any time, namely the one in the currently active channel. However, in order to perform the configured measurements consecutively, a Sequencer function is provided.

- [The Sequencer Concept](#)..... 119
- [Sequencer Settings](#).....121
- [How to Set Up the Sequencer](#).....121

5.4.1 The Sequencer Concept

The instrument can only activate one specific channel at any time. Thus, only one measurement can be performed at any time, namely the one in the currently active channel. However, in order to perform the configured measurements consecutively, a Sequencer function is provided, which changes the channel of the instrument as required. If activated, the measurements configured in the currently defined "Channel" s are performed one after the other in the order of the tabs.

For each individual measurement, the sweep count is considered. Thus, each measurement may consist of several sweeps. The currently active measurement is indicated by a  symbol in the tab label.

The result displays of the individual channels are updated in the tabs as the measurements are performed. Sequential operation itself is independent of the currently *displayed* tab.

Sequencer modes

Three different Sequencer modes are available:

- **Single Sequence**
Similar to single sweep mode; each measurement is performed once, until all measurements in all defined "Channel" s have been performed.
- **Continuous Sequence**
Similar to continuous sweep mode; the measurements in each defined "Channel" are performed one after the other, repeatedly, in the same order, until sequential operation is stopped. This is the default Sequencer mode.
- **Channel-defined Sequence**
First, a single sequence is performed. Then, only "Channel" s in continuous sweep mode are repeated continuously.

Example: Sequencer procedure

Assume the following active channel definition:

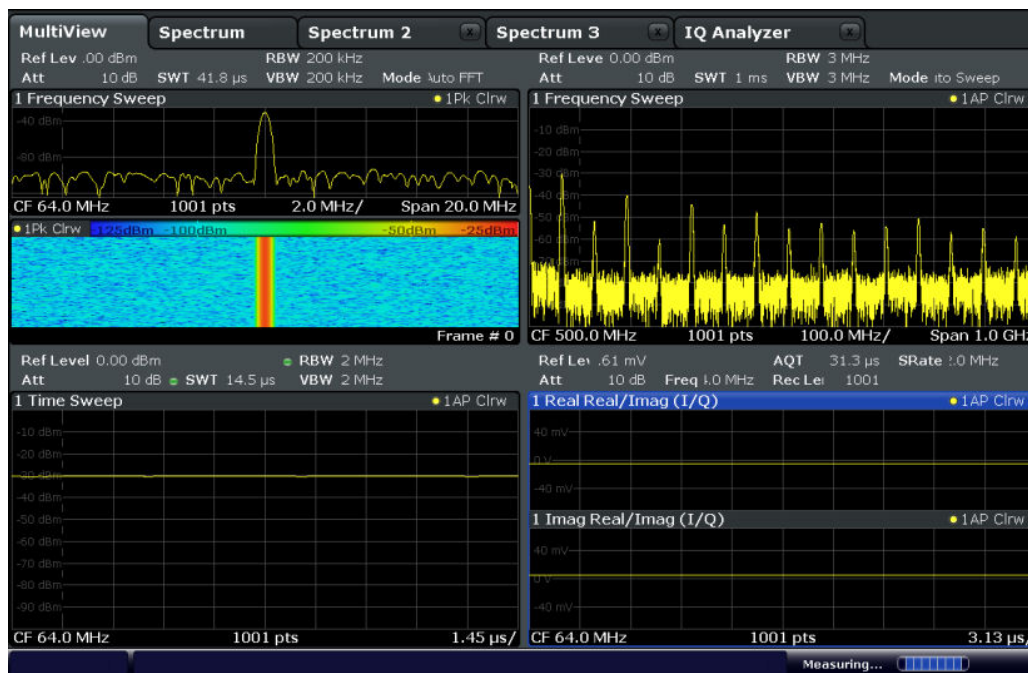

Tab name	Application	Sweep mode	Sweep count
Spectrum	Spectrum	Cont. Sweep	5
Spectrum 2	Spectrum	Single Sweep	6
Spectrum 3	Spectrum	Cont. Sweep	2
IQ Analyzer	IQ Analyzer	Single Sweep	7

For **Single Sequence**, the following sweeps will be performed:

5x Spectrum, 6x Spectrum 2, 2 x Spectrum 3, 7x IQ Analyzer

For **Continuous Sequence**, the following sweeps will be performed:

5x Spectrum, 6x Spectrum 2, 2 x Spectrum 3, 7x IQ Analyzer,
 5x Spectrum, 6x Spectrum 2, 2 x Spectrum 3, 7x IQ Analyzer,

...

For **Channel-defined Sequence**, the following sweeps will be performed:

5x Spectrum, 6x Spectrum 2, 2 x Spectrum 3, 7x IQ Analyzer,
 5x Spectrum, 2 x Spectrum 3,
 5x Spectrum, 2 x Spectrum 3,

...

RUN SINGLE/RUN CONT and Single Sweep/Sweep Continuous keys

While the Sequencer is active, the RUN SINGLE and RUN CONT keys control the Sequencer, not individual sweeps. RUN SINGLE starts the Sequencer in single mode, while RUN CONT starts the Sequencer in continuous mode.

The "Single Sweep" and "Continuous Sweep" *softkeys* control the sweep mode for the currently selected channel only; the sweep mode only has an effect the next time the Sequencer activates that channel, and only for a channel-defined sequence. In this case, a channel in single sweep mode is swept only once by the Sequencer. A channel in continuous sweep mode is swept repeatedly.

5.4.2 Sequencer Settings



The "Sequencer" menu is available from the toolbar.

Sequencer State	121
Sequencer Mode	121

Sequencer State

Activates or deactivates the Sequencer. If activated, sequential operation according to the selected Sequencer mode is started immediately.

Remote command:

`SYSTem:SEQuencer` on page 630

`INITiate<n>:SEQuencer:IMMediate` on page 629

`INITiate<n>:SEQuencer:ABORt` on page 628

Sequencer Mode

Defines how often which measurements are performed. The currently selected mode softkey is highlighted blue. During an active Sequencer process, the selected mode softkey is highlighted orange.

"Single Sequence"

Each measurement is performed once, until all measurements in all active channels have been performed.

"Continuous Sequence"

The measurements in each active channel are performed one after the other, repeatedly, in the same order, until sequential operation is stopped.

This is the default Sequencer mode.

"Channel Defined Sequence"

First, a single sequence is performed. Then, only channels in continuous sweep mode are repeated.

Remote command:

`INITiate<n>:SEQuencer:MODE` on page 629

5.4.3 How to Set Up the Sequencer

In order to perform the configured measurements consecutively, a Sequencer function is provided.

1. Configure a channel for each measurement configuration as required, including the sweep mode.

- In the toolbar, select the "Sequencer" icon.



The "Sequencer" menu is displayed.

- Toggle the "Sequencer" softkey to "On" .
A continuous sequence is started immediately.
- To change the Sequencer mode and start a new sequence immediately, select the corresponding mode softkey, or press the RUN SINGLE or RUN CONT key.

The measurements configured in the currently active channels are performed one after the other in the order of the tabs until the Sequencer is stopped.
The result displays in the individual channels are updated as the measurements are performed.

To stop the Sequencer

- ▶ To stop the Sequencer temporarily, press the highlighted RUN SINGLE or RUN CONT key (not for a channel-defined sequence). To continue the Sequencer, press the key again.
To stop the Sequencer permanently, select the "Sequencer" icon in the toolbar and toggle the "Sequencer" softkey to "Off" .

6 Measurements and Results

Access: "Overview" > "Select Measurement"

Or: MEAS

In the Spectrum application, the R&S FPS provides a variety of different measurement functions.

- **Basic measurements** - measure the spectrum of your signal or watch your signal in time domain
- **Power measurements** - calculate the powers involved in modulated carrier signals
- **Emission measurements** - detect unwanted signal emission
- **Statistic measurements** - evaluate the spectral distribution of the signal
- **Special measurements** - provide characteristic values of the signal

The individual functions are described in detail in the following chapters.

The measurement function determines which settings, functions and evaluation methods are available in the R&S FPS. The various measurement functions are described in detail here.

When you select a measurement function, the measurement is started with its default settings immediately and the corresponding measurement configuration menu is displayed. The measurement configuration menu can be displayed at any time by pressing the MEAS CONFIG key.

The easiest way to configure measurements is using the configuration "Overview" , see [Chapter 7.1, "Configuration Overview"](#), on page 300.

In addition to the measurement-specific parameters, the general parameters can be configured as usual, see [Chapter 7, "Common Measurement Settings"](#), on page 300. Many measurement functions provide special result displays or evaluation methods; however, in most cases the general evaluation methods are also available, see [Chapter 8, "Common Analysis and Display Functions"](#), on page 393.

After a preset, and when all other functions are switched off ("All Functions Off" in the "Select Measurement" dialog) the R&S FPS performs a basic frequency sweep.

The remote commands required to retrieve measurement results are described in [Chapter 12.8.2.4, "Retrieving Trace Results"](#), on page 853.



Measurements on I/Q-based data

The I/Q Analyzer application (*not Master*) in **MSRA mode** can also perform measurements on the captured I/Q data in the time and frequency domain.

The measurements are configured using the same settings as described here for the Spectrum application.

The results, however, may differ slightly as hardware settings are not adapted automatically as for the Spectrum application. Additionally, the analysis interval used for the measurement is indicated as in all MSRA applications.

For more information see the R&S FPS MSRA User Manual.

• Basic Measurements.....	124
• Channel Power and Adjacent-Channel Power (ACLR) Measurement.....	145
• Carrier-to-Noise Measurements.....	194
• Occupied Bandwidth Measurement (OBW).....	198
• Spectrum Emission Mask (SEM) Measurement.....	205
• Spurious Emissions Measurement.....	248
• Statistical Measurements (APD, CCDF).....	261
• Time Domain Power Measurement.....	276
• Harmonic Distortion Measurement.....	280
• Third Order Intercept (TOI) Measurement.....	286
• AM Modulation Depth Measurement.....	296

6.1 Basic Measurements

Basic measurements are common sweeps in the time or frequency domain which provide an overview of the basic input signal characteristics.

If no other measurement function is selected, or if all measurement functions are switched off, the R&S FPS performs a basic frequency or time sweep.

After a preset, a frequency sweep is performed.

Use the general measurement settings to configure the measurement, e.g. via the "Overview" (see [Chapter 7, "Common Measurement Settings"](#), on page 300).

6.1.1 Basic Measurement Types

Frequency Sweep	124
Zero Span	125
All Functions Off	125

Frequency Sweep

A common frequency sweep of the input signal over a specified span. Can be used for general purposes to obtain basic measurement results such as peak levels and spectrum traces. The "Frequency" menu is displayed. This is the default measurement if no other function is selected.

Use the general measurement settings to configure the measurement, e.g. via the "Overview" (see [Chapter 7, "Common Measurement Settings"](#), on page 300).

Remote command:

`[SENSe:] FREQuency: START` on page 780, `[SENSe:] FREQuency: STOP` on page 780

`INITiate<n>[:IMMediate]` on page 636

`INITiate<n>:CONTInuous` on page 635

Zero Span

A sweep in the time domain at the specified (center) frequency, i.e. the frequency span is set to zero. The display shows the time on the x-axis and the signal level on the y-axis, as on an oscilloscope. On the time axis, the grid lines correspond to 1/10 of the current sweep time.

Use the general measurement settings to configure the measurement, e.g. via the "Overview" (see [Chapter 7, "Common Measurement Settings"](#), on page 300).

Most result evaluations can also be used for zero span measurements, although some functions (e.g. markers) may work slightly differently and some may not be available. If so, this will be indicated in the function descriptions (see [Chapter 8, "Common Analysis and Display Functions"](#), on page 393).

Remote command:

`[SENSe:] FREQuency: SPAN` on page 779

`INITiate<n>[:IMMediate]` on page 636

`INITiate<n>:CONTInuous` on page 635

All Functions Off

Switches off all measurement functions and returns to a basic frequency sweep.

Selecting "Frequency Sweep" has the same effect.

6.1.2 How to Perform a Basic Sweep Measurement

The following step-by-step instructions demonstrate how to perform basic sweep measurements.



For remote operation, see [Chapter 12.15.1, "Programming Example: Performing a Basic Frequency Sweep"](#), on page 1042.

To perform one or more single sweeps

1. Configure the frequency and span to be measured ("Frequency" dialog box, see [Chapter 7.3, "Frequency and Span Configuration"](#), on page 343).
2. Configure the number of sweeps to be performed in a single measurement ("Sweep Config" dialog box, see [" Sweep/Average Count "](#) on page 370).
3. If necessary, configure how the signal is processed internally ("Bandwidth" dialog box, see [" Sweep Type "](#) on page 371).

4. If necessary, configure a trigger for the measurement ("Trigger/ Gate Config" dialog box, see [Chapter 7.6, "Trigger and Gate Configuration"](#), on page 375).
5. Define how the results are evaluated for display ("Trace" dialog box, see [Chapter 8.5.1.2, "Trace Settings"](#), on page 465).
6. If necessary, configure the vertical axis of the display ("Amplitude" dialog box, see [Chapter 7.4, "Amplitude and Vertical Axis Configuration"](#), on page 351).
7. To start the measurement, select one of the following:
 - RUN SINGLE key
 - "Single Sweep" softkey in the "Sweep" menu

The defined number of sweeps are performed, then the measurement is stopped. While the measurement is running, the RUN SINGLE key is highlighted. To abort the measurement, press the RUN SINGLE key again. The key is no longer highlighted. The results are not deleted until a new measurement is started.
8. To repeat the same number of sweeps without deleting the last trace, select the "Continue Single Sweep" softkey in the "Sweep" menu.

To start continuous sweeping

1. If you want to average the trace or search for a maximum over more (or less) than 10 sweeps, configure the "Sweep/Average Count" ("Sweep Config" dialog box, see [" Sweep/Average Count "](#) on page 370).
2. To start the measurement, select one of the following:
 - RUN CONT key
 - "Continuous Sweep" softkey in the "Sweep" menu

After each sweep is completed, a new one is started automatically. While the measurement is running, the RUN CONT key is highlighted. To stop the measurement, press the RUN CONT key again. The key is no longer highlighted. The results are not deleted until a new measurement is started.

6.1.3 Measurement Examples - Measuring a Sinusoidal Signal

One of the most common measurement tasks that can be handled using a signal analyzer is determining the level and frequency of a signal. When measuring an unknown signal, you can usually start with the presettings.

NOTICE

High input values

If levels higher than +30 dBm (=1 W) are expected or are possible, a power attenuator must be inserted before the RF input of the analyzer. Otherwise, signal levels exceeding 30 dBm can damage the RF attenuator or the input mixer. The total power of all occurring signals must be taken into account.

Test setup

- Connect the RF output of the signal generator to the RF input of the R&S FPS.

Table 6-1: Signal generator settings (e.g. R&S SMW)

Frequency	128 MHz
Level	-30 dBm

- [Measuring the Level and Frequency Using Markers](#).....127
- [Measuring the Signal Frequency Using the Signal Counter](#)..... 128

6.1.3.1 Measuring the Level and Frequency Using Markers

The level and frequency of a sinusoidal signal can be measured easily using the marker function. The R&S FPS always displays its amplitude and frequency at the marker position. The frequency measurement uncertainty is determined by the reference frequency of the R&S FPS, the resolution of the marker frequency display and the number of sweep points.

1. Select PRESET to reset the instrument.
2. Connect the signal to be measured to the RF INPUT connector on the R&S FPS.
3. Set the center frequency to *128 MHz*.
4. Reduce the frequency span to *1 MHz*.

Note: Coupled settings. When the frequency span is defined, the resolution bandwidth, the video bandwidth and the sweep time are automatically adjusted, because these functions are defined as coupled functions in the presets.

5. Select MKR to activate marker 1 and automatically set it to the maximum of the trace.

The level and frequency values measured by the marker are displayed in the marker information at the top of the display.

Note: Performing a peak search. When a marker is initially activated, it automatically performs the peak search function (as shown in the example).

If a marker was already active, select the PEAK SEARCH key or the "Peak" soft-key in the MKR > menu in order to set the currently active marker to the maximum of the displayed signal.

Increasing the Frequency Resolution

The frequency resolution of the marker is determined by the resolution of the trace. A trace consists of 1001 trace points, i.e. if the frequency span is 1 MHz, each trace point represents a span of approximately 1 kHz. This corresponds to a maximum uncertainty of +/- 0.5 kHz.

You can increase the resolution of the trace by reducing the frequency span.

Reducing the frequency span to 10 kHz

- ▶ Reduce the frequency span to *10 kHz*.

The resolution of the trace is now approximately 10 Hz (10 kHz span / 1001 trace points), thus, the precision of the marker frequency display increases to approximately ± 5 Hz.

Setting the Reference Level

The reference level is the level at the upper limit of the diagram. To achieve the widest dynamic range possible for a spectrum measurement, use the entire level span of the R&S FPS. In other words, the highest level that occurs in the signal should be located at the top edge of the diagram (= reference level) or immediately below it.



Low Reference Levels

If the selected reference level is lower than the highest signal that occurs in the spectrum, the signal path in the R&S FPS is overloaded.

In this case, the message "IFOVL" is displayed in the error message field.

In the presettings, the value of the reference level is 0 dBm. If the input signal is -30 dBm, the reference level can be reduced by 30 dB without causing the signal path to be overloaded.

Reducing the reference level by 30 dB

- ▶ Set the reference level to *-30 dBm*.

The maximum of the trace is near the maximum of the measurement diagram. The increase in the displayed noise is not substantial. Thus, the distance between the signal maximum and the noise display (=dynamic range) has increased.

Setting the reference level with the help of a marker

You can also use a marker to shift the maximum value of the trace directly to the top edge of the diagram. If the marker is located at the maximum level of the trace (as in this example), the reference level can be moved to the marker level as follows:

1. Press the MKR -> key.
2. Select "Ref Lvl = Mkr Lvl" .

The reference level is set to the current marker level.

6.1.3.2 Measuring the Signal Frequency Using the Signal Counter

The built-in signal counter allows you to measure the frequency more accurately than measuring it with the marker. The frequency sweep is stopped at the marker, and the R&S FPS measures the frequency of the signal at the marker position (see also [Chapter 8.3.4.1, "Precise Frequency \(Signal Count\) Marker"](#), on page 421).

In the following example, the frequency of the generator at 128 MHz is shown using the marker.

Prerequisite

Precise frequency measurements require a precise reference frequency. Therefore, an external reference frequency from the signal generator is used. Connect the signal generator's REF OUT connector to the analyzer's REF IN connector.

1. Select PRESET to reset the instrument.
2. Set the center frequency to *128 MHz*.
3. Set the frequency span to *1 MHz*.
4. Select "Setup" > "Reference" > "External Reference 10 MHz" to activate the external reference frequency.
5. Select MKR to activate marker 1 and automatically set it to the maximum of the trace.

The level and the frequency of the marker are displayed in the marker results in the diagram or the marker table.

6. Select MKR FUNC > "Signal Count" to activate the signal counter.
The result of the signal counter is displayed in the marker results.
7. If necessary, increase the resolution of the signal counter by selecting "Signal Count Resolution" (in the "Signal Count" menu).



Prerequisites for using the internal signal counter

In order to obtain a correct result when measuring the frequency with the internal signal counter, an RF sinusoidal signal or a spectral line must be available. The marker must be located more than 25 dB above the noise level to ensure that the specified measurement accuracy is adhered to.

6.1.4 Measurement Example – Measuring Levels at Low S/N Ratios

The minimum signal level a signal analyzer can measure is limited by its intrinsic noise. Small signals can be swamped by noise and therefore cannot be measured. For signals that are just above the intrinsic noise, the accuracy of the level measurement is influenced by the intrinsic noise of the R&S FPS.

The displayed noise level of a signal analyzer depends on its noise figure, the selected RF attenuation, the selected reference level, the selected resolution and video bandwidth and the detector.

For details see:

- [Chapter 7.4.1.2, "RF Attenuation"](#), on page 353
- [Chapter 7.4.1.1, "Reference Level"](#), on page 352
- [Chapter 7.5.1.1, "Separating Signals by Selecting an Appropriate Resolution Bandwidth"](#), on page 361
- [Chapter 7.5.1.2, "Smoothing the Trace Using the Video Bandwidth"](#), on page 362

- ["Mapping Samples to sweep Points with the Trace Detector"](#) on page 459

This measurement example shows the different factors influencing the S/N ratio.

Table 6-2: Signal generator settings (e.g. R&S SMW)

Frequency	128 MHz
Level	-95 dBm

1. Preset the R&S FPS.
2. Set the center frequency to *128 MHz*.
3. Set the span to *100 MHz*.
4. Set the reference level to *-30 dBm*.

The signal is measured with the auto peak detector and is completely hidden in the intrinsic noise of the R&S FPS.

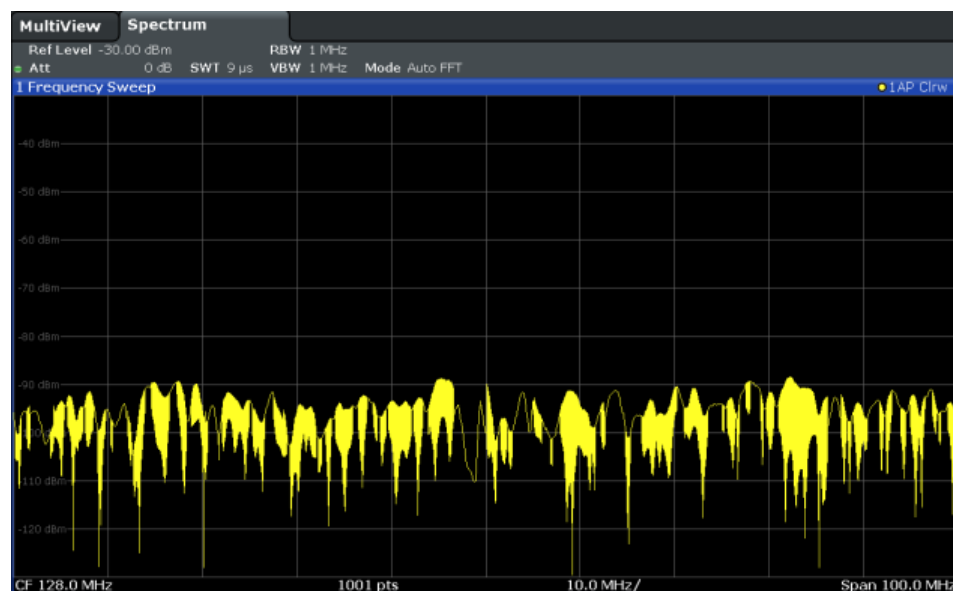

Figure 6-1: Sine wave signal with low S/N ratio

5. To suppress noise spikes, average the trace. In the "Traces" configuration dialog, set the "Trace Mode" to "Average" (see ["Trace Mode"](#) on page 466).

The traces of consecutive sweeps are averaged. To perform averaging, the R&S FPS automatically switches on the sample detector. The RF signal, therefore, can be more clearly distinguished from noise.

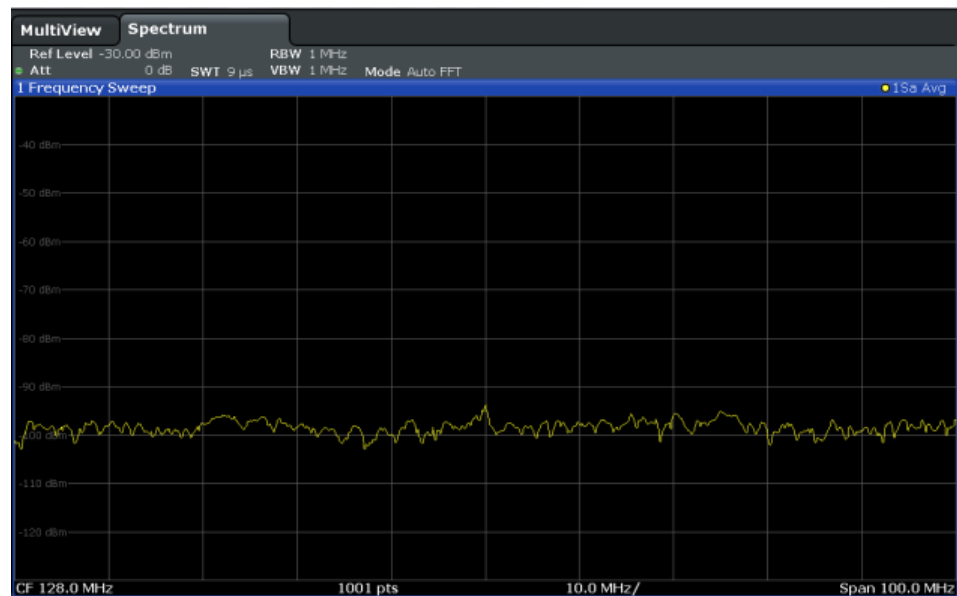

Figure 6-2: RF sine wave signal with low S/N ratio with an averaged trace

6. Instead of trace averaging, you can select a video filter that is narrower than the resolution bandwidth. Set the trace mode back to "Clear/ Write" , then set the VBW to 10 kHz manually in the "Bandwidth" configuration dialog.

The RF signal can be distinguished from noise more clearly.

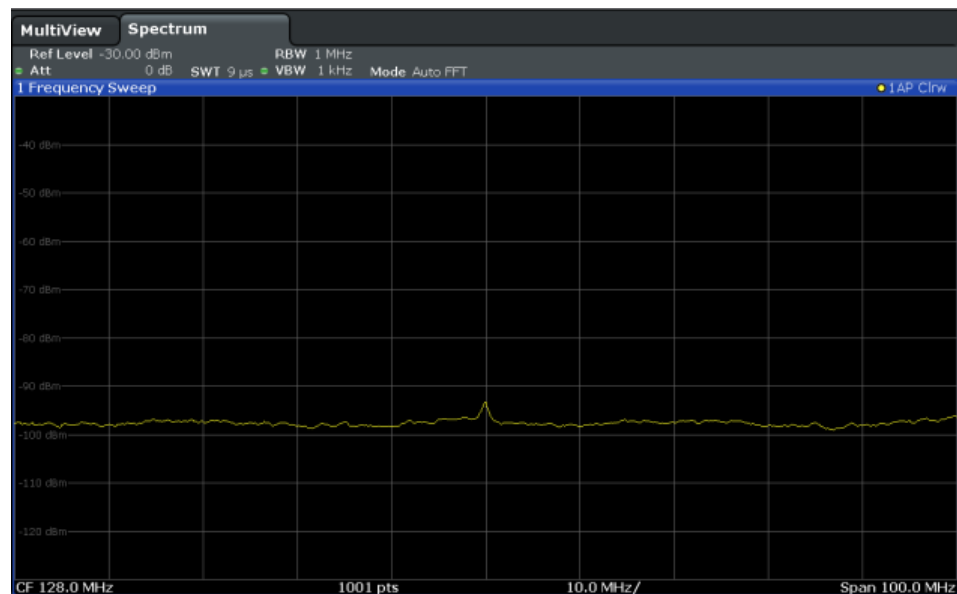

Figure 6-3: RF sine wave signal with low S/N ratio with a smaller video bandwidth

7. By reducing the resolution bandwidth by a factor of 10, the noise is reduced by 10 dB. Set the RBW to 100 kHz.

The displayed noise is reduced by approximately 10 dB. The signal, therefore, emerges from noise by about 10 dB. Compared to the previous setting, the video bandwidth has remained the same, i.e. it has increased relative to the smaller resolution bandwidth. The averaging effect of the video bandwidth is therefore reduced. The trace will be noisier.

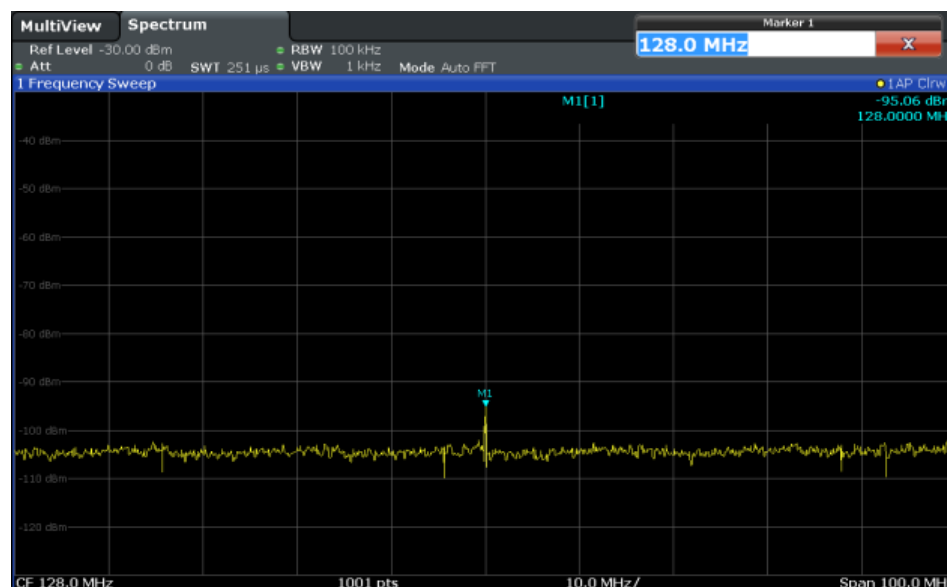

Figure 6-4: Reference signal at a smaller resolution bandwidth

6.1.5 Measurement Examples - Measuring Signal Spectra with Multiple Signals

- [Separating Signals by Selecting the Resolution Bandwidth](#)..... 132
- [Measuring the Modulation Depth of an AM-Modulated Carrier in the Frequency Domain](#).....136
- [Measuring AM-Modulated Signals](#)..... 137

6.1.5.1 Separating Signals by Selecting the Resolution Bandwidth

A basic feature of a Signal and Spectrum Analyzer is the ability to separate the spectral components of a mixture of signals. The resolution at which the individual components can be separated is determined by the resolution bandwidth. Selecting a resolution bandwidth that is too large may make it impossible to distinguish between spectral components, i.e. they are displayed as a single component (see also [Chapter 7.5.1.1, "Separating Signals by Selecting an Appropriate Resolution Bandwidth"](#), on page 361).

Two signals with the same amplitude can be resolved if the resolution bandwidth is smaller than or equal to the frequency spacing of the signal. If the resolution bandwidth is equal to the frequency spacing, the spectrum display shows a level drop of 3 dB precisely in the center of the two signals. Decreasing the resolution bandwidth makes the level drop larger, which thus makes the individual signals clearer.

In this measurement example we will analyze two signals with a level of -30 dBm each and a frequency spacing of 30 kHz.

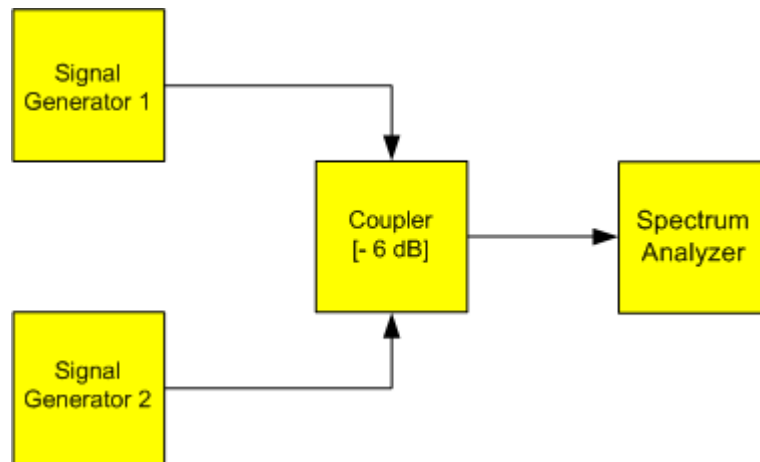

Figure 6-5: Test setup

Table 6-3: Signal generator settings (e.g. R&S SMW)

	Level	Frequency
Signal generator 1	-30 dBm	128,00 MHz
Signal generator 2	-30 dBm	128,03 MHz

1. Select PRESET to reset the instrument.
2. Set the center frequency to *128.015 MHz*.
3. Set the frequency span to *300 kHz*.
4. Set the resolution bandwidth to *30 kHz* and the video bandwidth to *1 kHz*.

Note: Larger video bandwidths. The video bandwidth is set to 1 kHz in order to make the level drop in the center of the two signals clearly visible. At larger video bandwidths, the video voltage that results from envelope detection is not sufficiently suppressed. This produces additional voltages, which are visible in the trace, in the transition area between the two signals.

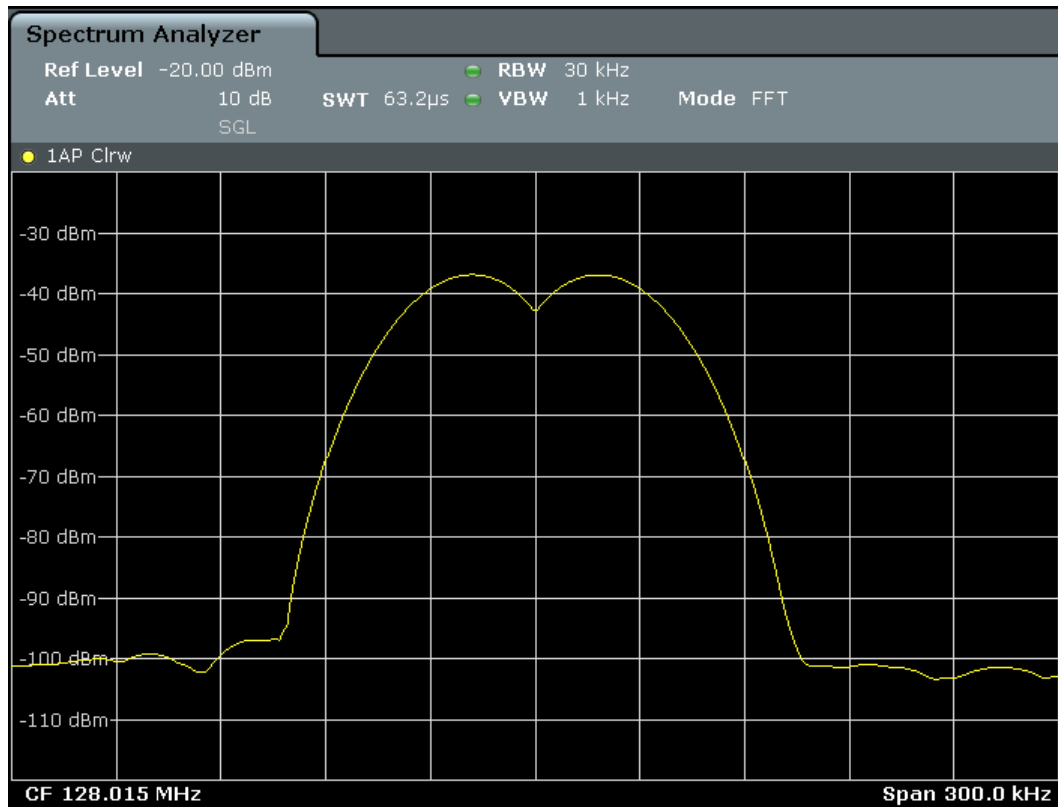

Figure 6-6: Measurement of two equally-leveled RF sinusoidal signals with the resolution bandwidth which corresponds to the frequency spacing of the signals

Matching generator and R&S FPS frequencies

The level drop is located exactly in the center of the display only if the generator frequencies match the frequency display of the R&S FPS exactly. To achieve exact matching, the frequencies of the generators and the R&S FPS must be synchronized.

- Set the resolution bandwidth to 100 kHz.

It is no longer possible to clearly distinguish the two generator signals.

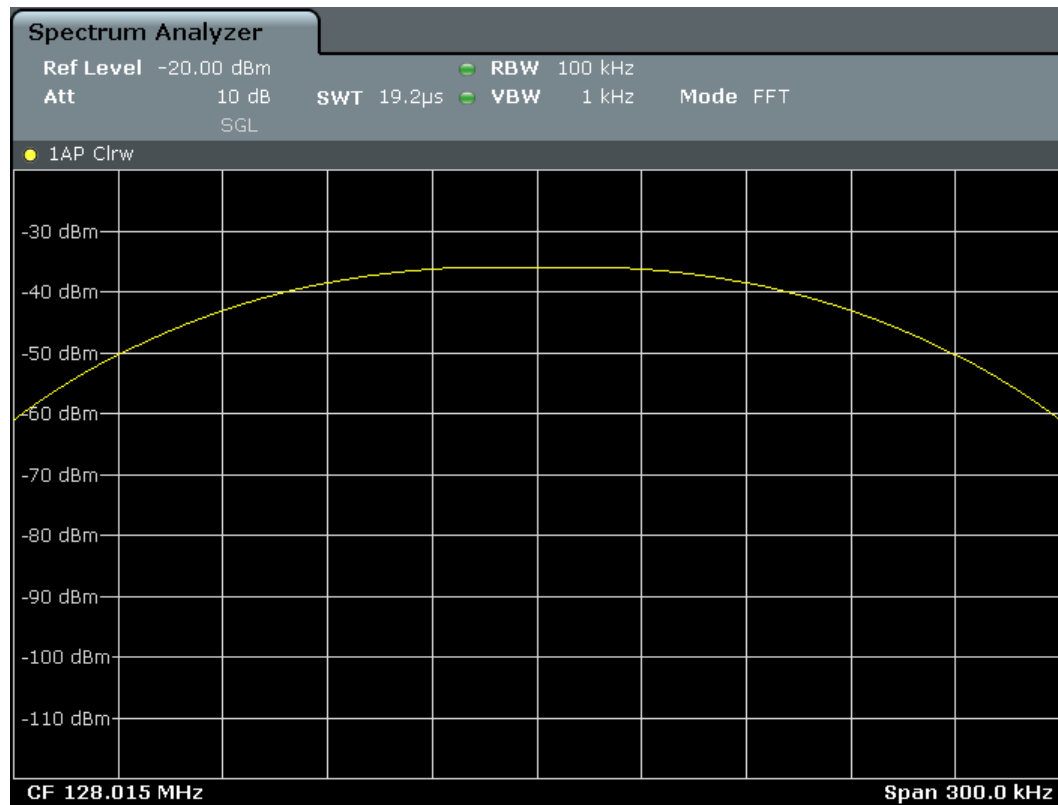

Figure 6-7: Measurement of two equally-leveled RF sinusoidal signals with a resolution bandwidth which is larger than their frequency spacing

- Set the resolution bandwidth to 1 kHz.

The two generator signals are shown with high resolution. However, the sweep time becomes longer. At smaller bandwidths, the noise display decreases simultaneously (10 dB decrease in noise floor for a decrease in bandwidth by a factor of 10).

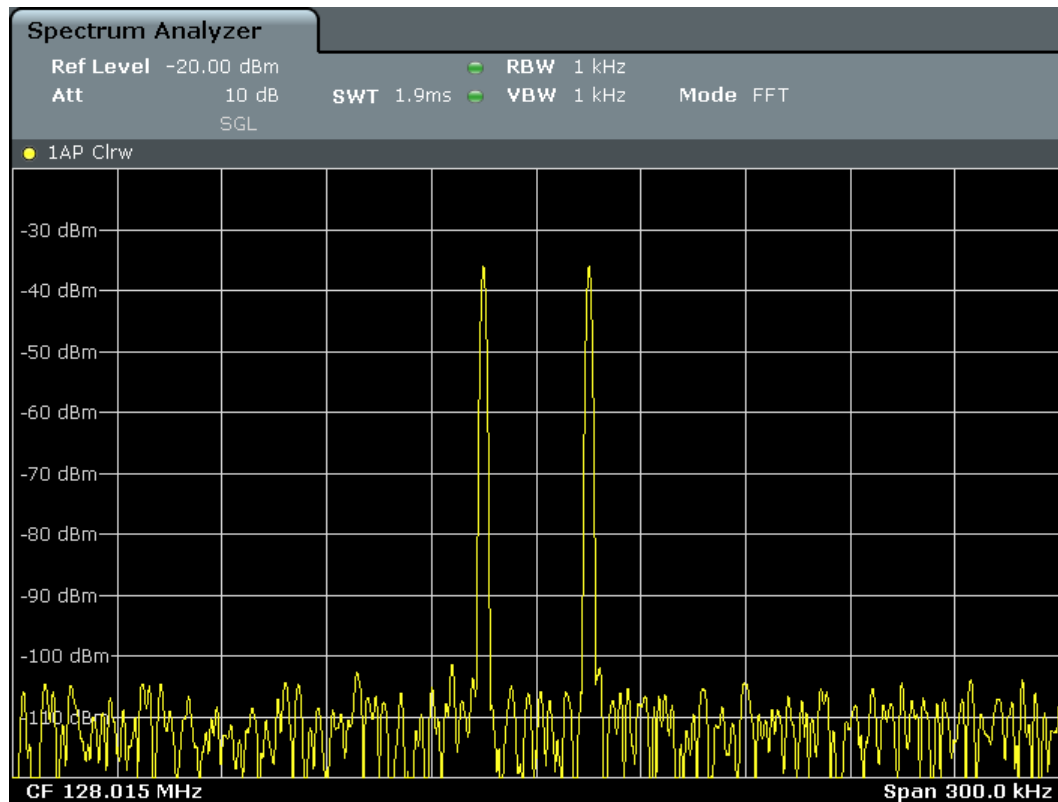

Figure 6-8: Measurement of two equally-leveled RF sinusoidal signals with a resolution bandwidth (1 kHz) which is significantly smaller than their frequency spacing

6.1.5.2 Measuring the Modulation Depth of an AM-Modulated Carrier in the Frequency Domain

In the frequency range display, the AM side bands can be resolved with a narrow bandwidth and measured separately. The modulation depth of a carrier modulated with a sinusoidal signal can then be measured. Since the dynamic range of a signal analyzer is very large, extremely small modulation depths can also be measured precisely. For this purpose, the R&S FPS provides measurement routines that output the modulation depth numerically in percent directly.

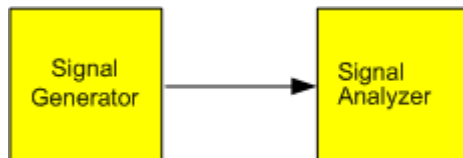

Figure 6-9: Test setup

Table 6-4: Signal generator settings (e.g. R&S SMW)

Frequency	128 MHz
Level	-30 dBm
Modulation	50 % AM, 10 kHz AF

1. Select PRESET to reset the instrument.
2. Set the center frequency to 128 MHz.
3. Set the frequency span to 50 kHz.
4. Select MEAS > "AM Modulation Depth" to activate the modulation depth measurement.

The R&S FPS automatically sets a marker to the carrier signal in the center of the diagram and one delta marker each to the upper and lower AM sidebands. The R&S FPS calculates the AM modulation depth from the level differences of the delta markers to the main marker and outputs the numeric value in the marker information.

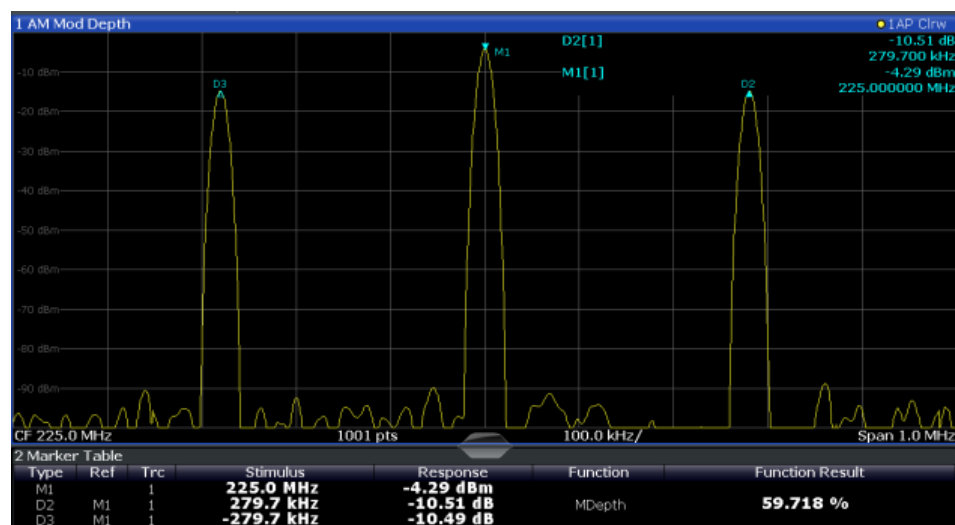

Figure 6-10: Measurement of the AM modulation depth

The modulation depth is displayed as "MDepth". The frequency of the AF signal can be obtained from the frequency display of the delta marker.

6.1.5.3 Measuring AM-Modulated Signals

The R&S FPS rectifies the RF input signal (that is, removes the negative parts) and displays it as a magnitude spectrum. The rectification also demodulates AM-modulated signals. The AF voltage can be displayed in zero span if the modulation sidebands fall within the resolution bandwidth.

Displaying the AF of an AM-modulated signal (Zero Span)

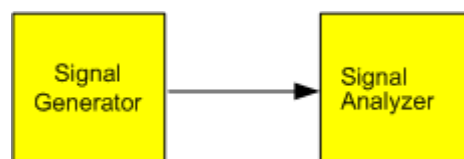

Figure 6-11: Test setup

Table 6-5: Signal generator settings (e.g. R&S SMW)

Frequency	128 MHz
Level	-30 dBm
Modulation	50 % AM, 1 kHz AF

1. Select PRESET to reset the instrument.
2. Set the center frequency to *128 MHz*.
3. Set the frequency span to *0 Hz* or select "Zero Span" .
4. Set the sweep time to *2.5 ms*.
5. Set the reference level to *6 dBm* and the display range to linear (AMPT > "Scale Config" > "Scaling" : "Linear Percent").
6. Define triggering in response to the AF signal using the video trigger to produce a static image.
 - a) Press the TRIG key.
 - b) Select "Video" .
 - c) Set the "Trg/Gate Level" to *50%*.

The trigger level is displayed as a horizontal line across the entire measurement diagram. The R&S FPS displays the 1 kHz AF signal as a static image in zero span.

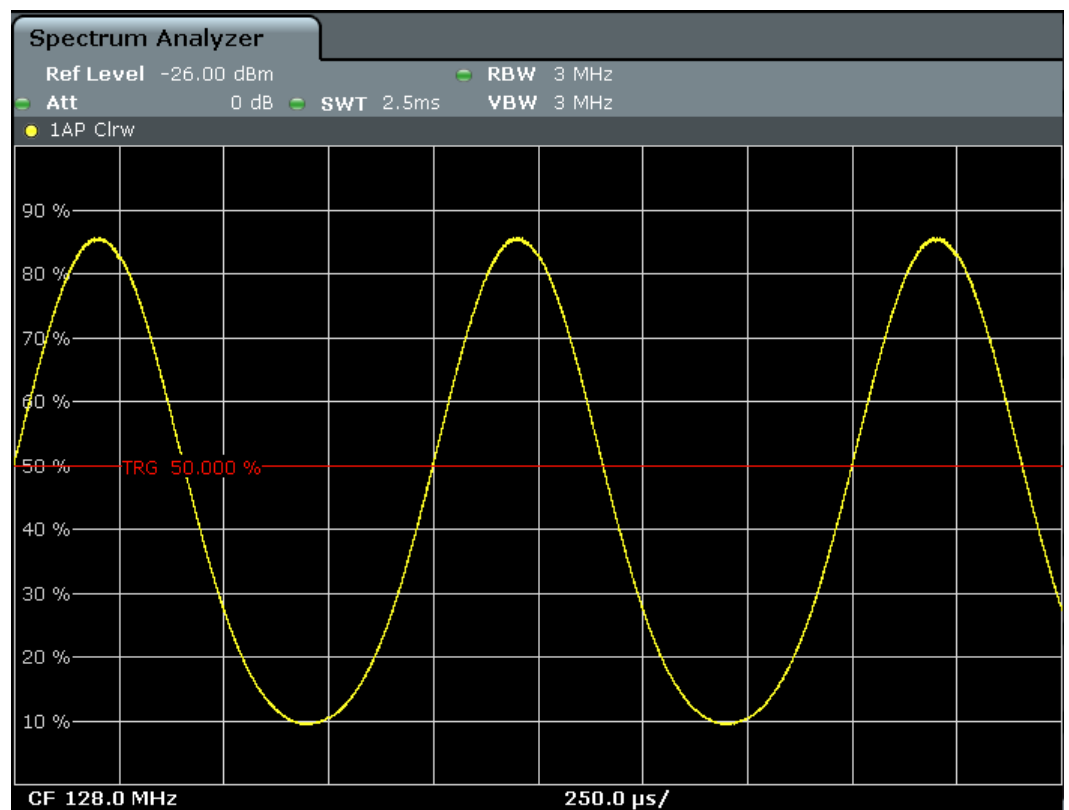

Figure 6-12: Measurement of the AF signal of a carrier that is AM-modulated with 1 kHz

6.1.6 Measurement Examples in Zero Span

For radio transmission systems that use the TDMA method (for example, GSM), transmission quality is determined not only by spectral characteristics but also by characteristics in zero span. A timeslot is assigned to each user since several users share the same frequency. Smooth operation is ensured only if all users adhere exactly to their assigned timeslots.

Both the power during the send phase as well as the timing and duration of the TDMA burst, and rise and fall times of the burst, are important.

- [Measuring the Power Characteristic of Burst Signals](#)..... 139
- [Measuring the Signal-to-Noise Ratio of Burst Signals](#)..... 143

6.1.6.1 Measuring the Power Characteristic of Burst Signals

To measure power in zero span, the R&S FPS offers easy-to-use functions that measure the power over a predefined time.

Measuring the Power of a GSM Burst During the Activation Phase

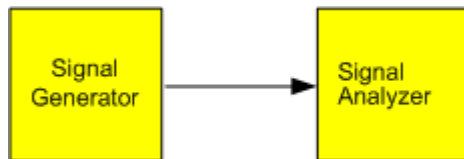

Figure 6-13: Test setup

Table 6-6: Signal generator settings (e.g. R&S SMW)

Frequency	890 MHz
Level	0 dBm
Modulation	GSM, one timeslot activated

1. Select PRESET to reset the instrument.
2. Set the center frequency to *890 MHz* (FREQ).
3. Set the frequency span to *0 Hz* (SPAN > "Zero Span").
4. Set the reference level to *10 dBm* (= level of the signal generator +10 dB) (AMPT).
5. Set the attenuation to *20 dB* (AMPT > "RF Atten Manual").
6. Set the resolution bandwidth to *1 MHz* (BW > "Res BW").
7. Set the sweep time to *1 ms* (SWEEP > "Sweep Time Manual").
The R&S FPS shows the GSM burst continuously across the display.
8. Using the video trigger, set triggering on the rising edge of the burst.
 - a) Press the TRIG key.
 - b) Set the "Trg Source" to "Video" .
 - c) Set the "Trg/Gate Level" to *70%*.

The R&S FPS shows a static image with the GSM burst at the start of the trace.
The trigger level is displayed as a horizontal line labeled with the absolute level for the trigger threshold in the measurement diagram.
9. Activate power measurement within the activation phase of the burst in zero span.
 - a) Press the MEAS key.
 - b) Select "Time Domain Power" .
 - c) Select "Time Dom Power Config" .
 - d) Set the "Limits" state to "On" .
 - e) Select the "Left Limit" input field.
 - f) Using the navigation keys, move the vertical line "S1" to the start of the burst.
 - g) Select the "Right Limit" input field.
 - h) Using the navigation keys, move the vertical line "S2" to the end of the burst.

The R&S FPS displays the average (mean) power during the activation phase of the burst.

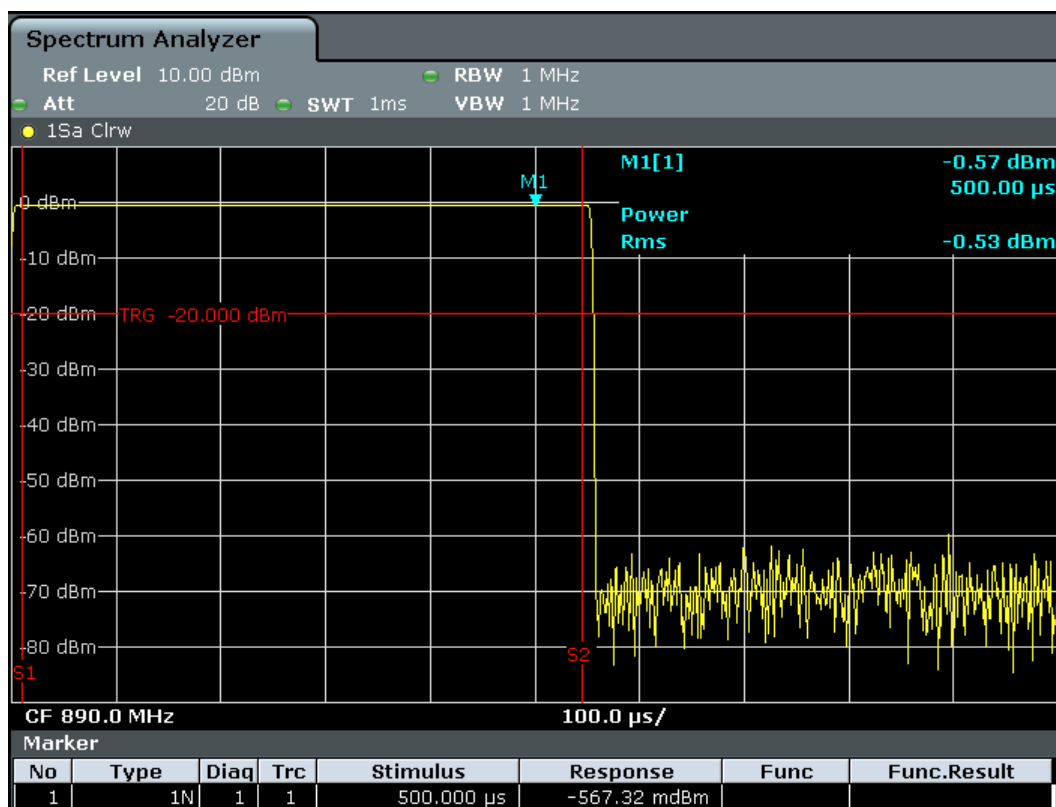

Figure 6-14: Measurement of the average power during the burst of a GSM signal

Measuring the Edges of a GSM Burst with High Time Resolution

Due to the high time resolution of the R&S FPS at the 0 Hz display range, the edges of TDMA bursts can be measured precisely. The edges can be shifted to the display area using the trigger offset.

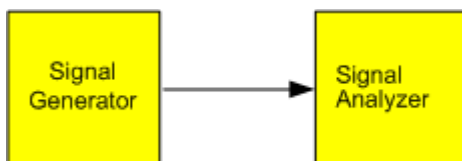

Figure 6-15: Test setup

Table 6-7: Signal generator settings (e.g. R&S SMW)

Frequency	890 MHz
Level	0 dBm
Modulation	GSM, one timeslot activated

The measurement is based on the example ["Measuring the Power of a GSM Burst During the Activation Phase"](#) on page 140.

1. Switch off the power measurement.

- a) Press the MEAS key.
 - b) Select "All Functions Off" .
2. Increase the time resolution to $100\ \mu\text{s}$ (SWEEP > "Sweep Time Manual").
 3. Shift the rising edge of the GSM burst to the center of the display by defining a trigger offset.
 - a) Press the TRIG key.
 - b) Select "Trigger Offset" .
 - c) Using the navigation key (Down), reduce the trigger offset until the burst edge is displayed in the center of the display, or enter $-50\ \mu\text{s}$.
The R&S FPS displays the rising edge of the GSM burst.

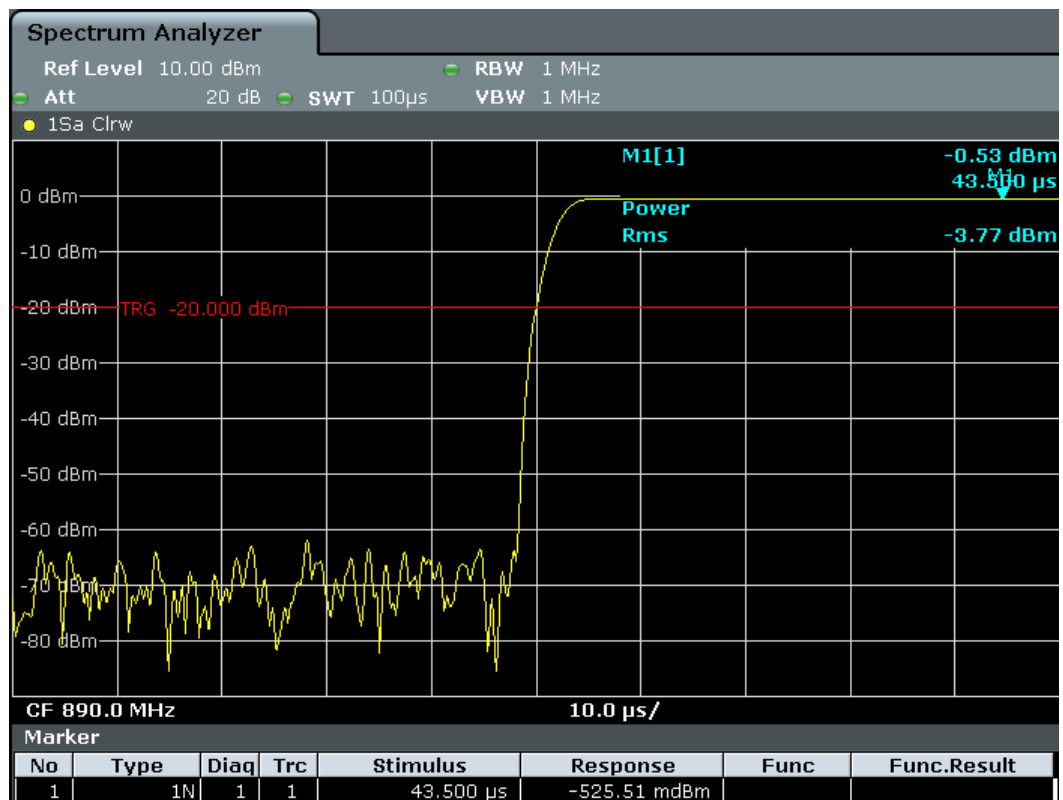

Figure 6-16: Rising edge of the GSM burst displayed with high time resolution

4. Move the falling edge of the burst to the center of the display. To do so, switch the trigger "Slope" to "Falling" (TRIG > "Trigger/ Gate Config").
The R&S FPS displays the falling edge of the GSM burst.

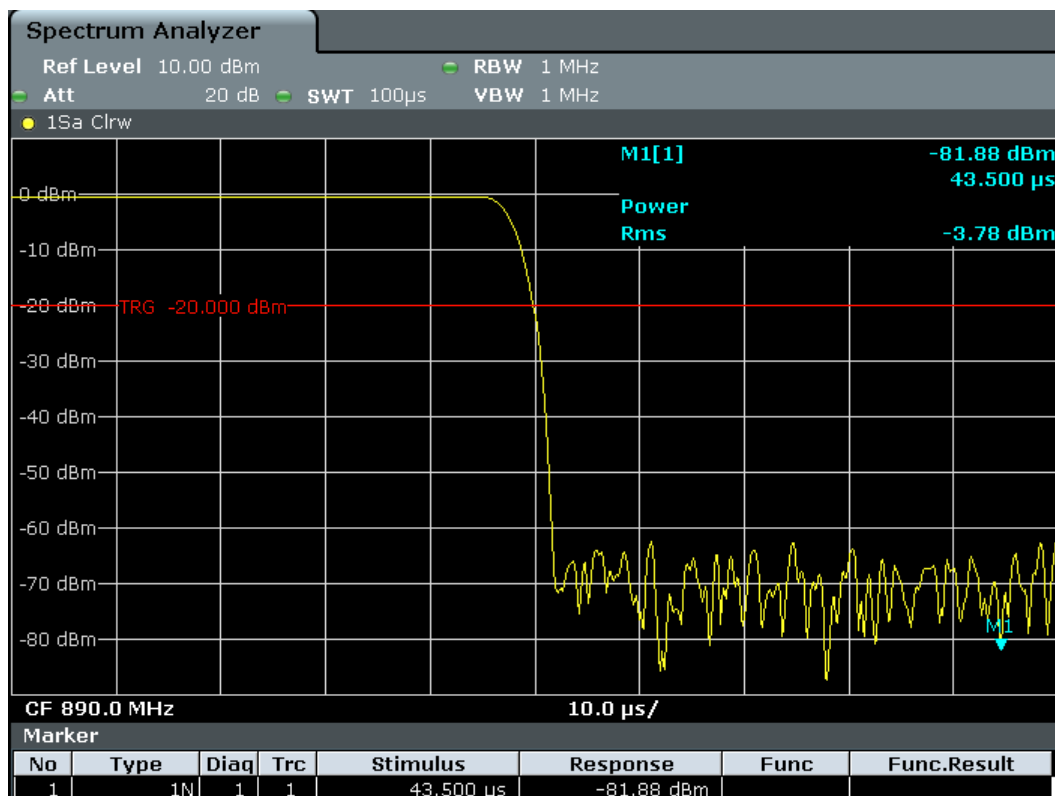

Figure 6-17: Falling edge of the GSM burst displayed with high time resolution

6.1.6.2 Measuring the Signal-to-Noise Ratio of Burst Signals

When TDMA transmission methods are used, the signal-to-noise ratio or the dynamic range for deactivation can be measured by comparing the power values during the activation phase and the deactivation phase of the transmission burst. Therefore, the R&S FPS provides a measurement for absolute and relative power in zero span. In the following example, the measurement is performed using a GSM burst.

Signal-to-Noise Ratio of a GSM Signal

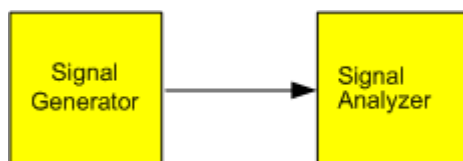

Figure 6-18: Test setup

Table 6-8: Signal generator settings (e.g. R&S SMW)

Frequency	890 MHz
Level	0 dBm
Modulation	GSM, one time slot is switched on

1. Select PRESET to reset the instrument.
2. Set the center frequency to *890 MHz*.
3. Set the frequency span to *0 Hz*.
4. Set the resolution bandwidth to *1 MHz*.
5. Set the reference level to *0 dBm* (= level of the signal generator).
6. Set the sweep time to *2 ms* (SWEEP > "Sweep Time Manual").
The R&S FPS shows the GSM burst continuously across the display.
7. Use the trigger source "Video" and the trigger slope "Rising" to trigger on the rising edge of the burst and shift the start of the burst to the center of the display (see [step 3 in "Measuring the Edges of a GSM Burst with High Time Resolution"](#) on page 141).
8. Activate power measurement within the activation phase of the burst in zero span.
 - a) Press the MEAS key.
 - b) Select "Time Domain Power" .
 - c) Select "Time Dom Power Config" .
 - d) Set the "Limits" state to "On" .
 - e) Select the "Left Limit" input field.
 - f) Using the navigation keys, move the vertical line "S1" to the start of the burst.
 - g) Select the "Right Limit" input field.
 - h) Using the navigation keys, move the vertical line "S2" to the end of the burst.
9. Measure the power during the deactivation phase of the burst by switching the trigger slope to "Falling" (TRIG > "Trigger/ Gate Config").

The R&S FPS initiates triggering in response to the falling edge of the burst. This shifts the burst to the left-hand side of the measurement diagram. The power is measured in the deactivation phase.

Channel Power and Adjacent-Channel Power (ACLR) Measurement

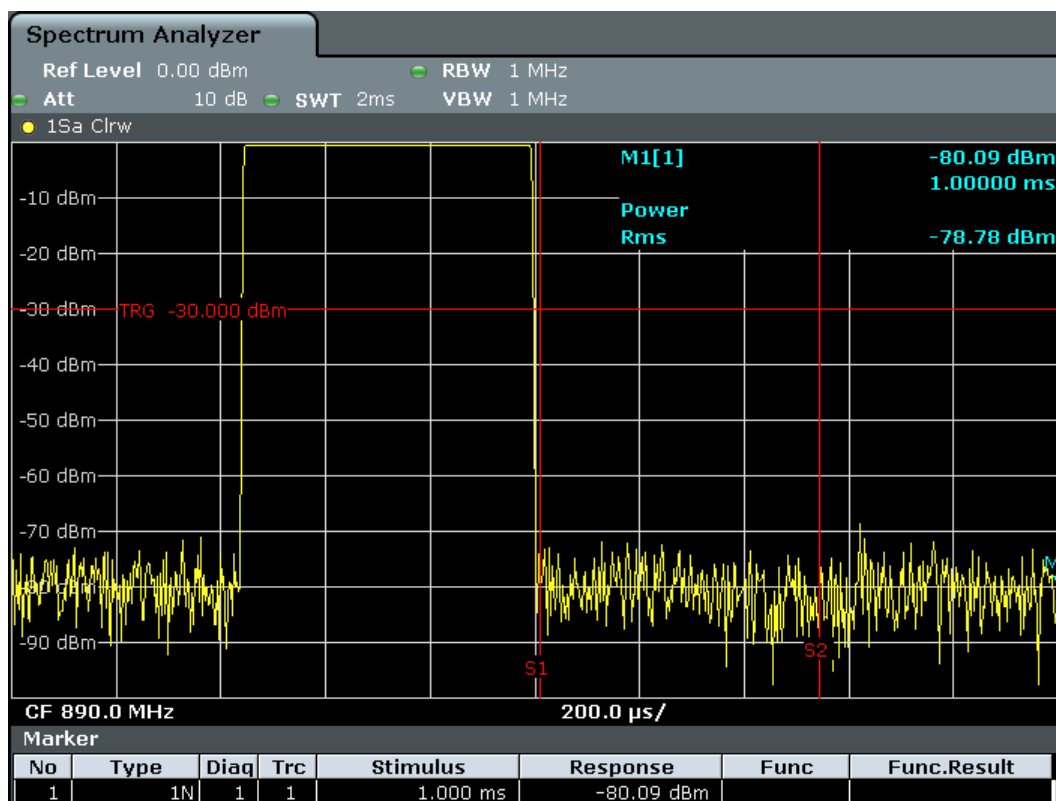

Figure 6-19: Measurement of the signal-to-noise ratio of a GSM burst signal in zero span

6.2 Channel Power and Adjacent-Channel Power (ACLR) Measurement

Measuring the power in channels adjacent to the carrier or transmission channel is useful to detect interference. The results are displayed as a bar chart for the individual channels.

- [About Channel Power Measurements](#)..... 146
- [Channel Power Results](#)..... 146
- [Channel Power Basics](#)..... 148
- [Channel Power Configuration](#)..... 159
- [MSR ACLR Configuration](#)..... 169
- [How to Perform Channel Power Measurements](#)..... 184
- [Measurement Examples](#)..... 188
- [Optimizing and Troubleshooting the Measurement](#)..... 192
- [Reference: Predefined CP/ACLR Standards](#)..... 192
- [Reference: Predefined ACLR User Standard XML Files](#)..... 193

6.2.1 About Channel Power Measurements

Measuring channel power and adjacent channel power is one of the most important tasks during signal analysis with the necessary test routines in the field of digital transmission. Theoretically, a power meter could be used to measure channel power at highest accuracy. However, its low selectivity means that it is not suitable for measuring adjacent channel power as an absolute value or relative to the transmit channel power. Only a selective power meter can measure the power in the adjacent channels.

A signal analyzer cannot be classified as a true power meter, because it displays the IF envelope voltage. However, it is calibrated such as to display the power of a pure sine wave signal correctly, irrespective of the selected detector. This calibration cannot be applied for non-sinusoidal signals. Assuming that the digitally modulated signal has a Gaussian amplitude distribution, the signal power within the selected resolution bandwidth can be obtained using correction factors. The internal power measurement routines in a signal analyzer normally use these correction factors to determine the signal power from IF envelope measurements. These factors apply if and only if the assumption of a Gaussian amplitude distribution is correct.

Apart from this common method, the R&S FPS also has a true power detector, i.e. an RMS detector. It displays the power of the test signal within the selected resolution bandwidth correctly, irrespective of the amplitude distribution, without additional correction factors being required.

The R&S FPS software allows you to perform ACLR measurements on input containing multiple signals for different communication standards. A measurement standard is provided that allows you to define multiple discontinuous transmit channels at specified frequencies, independent from the selected center frequency. The ACLR measurement determines the power levels of the individual transmit, adjacent, and gap channels, as well as the total power for each sub block of transmit channels.

A detailed measurement example is provided in [Chapter 6.2.7, "Measurement Examples"](#), on page 188.

6.2.2 Channel Power Results

For channel or adjacent-channel power measurements, the individual channels are indicated by different colored bars in the diagram. The height of each bar corresponds to the measured power of that channel. In addition, the name of the channel ("Adj" , "Alt %1" , "Tx %1" , etc., or a user-defined name) is indicated above the bar (separated by a line which has no further meaning).

For "Fast ACLR" measurements, which are performed in the time domain, the power versus time is shown for each channel.



Multi-standard radio (MSR) channel power results

The channel power results for MSR signals are described in [Chapter 6.2.3.4, "Measurement on Multi-Standard Radio \(MSR\) Signals"](#), on page 155.

Channel Power and Adjacent-Channel Power (ACLR) Measurement

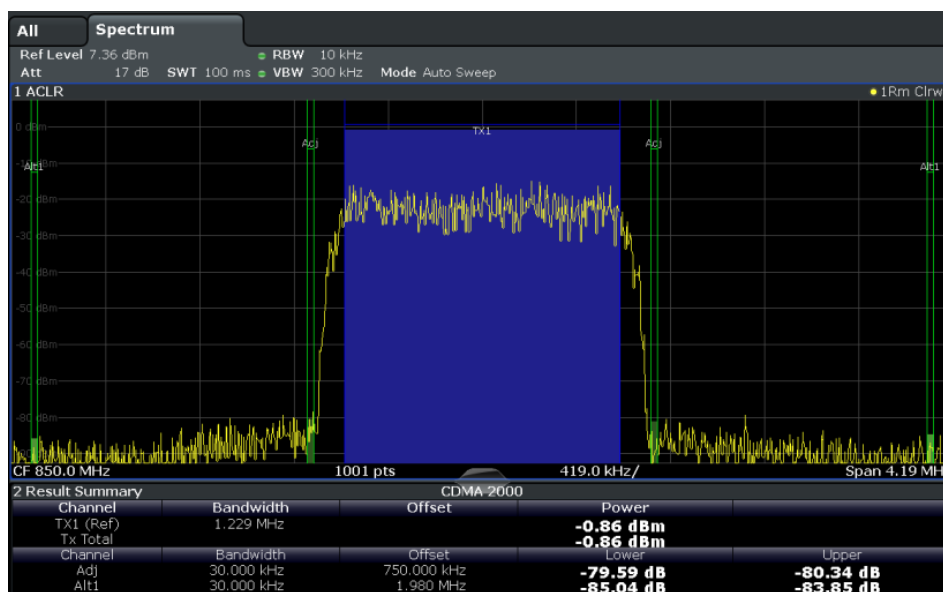

Results are provided for the TX channel and the number of defined adjacent channels *above and below* the TX channel. If more than one TX channel is defined, you must specify the channel to which the relative adjacent-channel power values refer. By default, it is the TX channel with the maximum power.

Table 6-9: Measurements performed depending on the number of adjacent channels

Number of adj. chan.	Measurement results
0	Channel powers
1	<ul style="list-style-type: none"> Channel powers Power of the upper and lower adjacent channel
2	<ul style="list-style-type: none"> Channel powers Power of the upper and lower adjacent channel Power of the next higher and lower channel (alternate channel 1)
3	<ul style="list-style-type: none"> Channel powers Power of the upper and lower adjacent channel Power of the next higher and lower channel (alternate channel 1) Power of the second next higher and lower adjacent channel (alternate channel 2)
...	...
12	<ul style="list-style-type: none"> Channel powers Power of the upper and lower adjacent channel Power of all the higher and lower channels (alternate channels 1 to 11)



In the R&S FPS display, only the first neighboring channel of the carrier (TX) channel is labeled "Adj" (adjacent) channel; all others are labeled "Alt" (alternate) channels. In this manual, "Adjacent" refers to both adjacent and alternate channels.

The measured power values for the TX and adjacent channels are also output as a table in the Result Summary window. Which powers are measured depends on the number of configured channels.

For each channel, the following values are displayed:

Label	Description
Channel	Channel name as specified in the "Channel Settings" (see " Channel Names " on page 168).
Bandwidth	Configured channel bandwidth (see " Channel Bandwidth " on page 166)
Offset	Offset of the channel to the TX channel (configured channel spacing, see " Channel Bandwidth " on page 166)
Power (Lower/Upper)	The measured power values for the TX and lower and upper adjacent channels. The powers of the transmission channels are output in dBm or dBm/Hz, or in dBc, relative to the specified reference TX channel.

Retrieving Results via Remote Control

All or specific channel power measurement results can be retrieved using the `CALC:MARK:FUNC:POW:RES?` command from a remote computer (see [CALCulate<n>:MARKer<m>:FUNCTion:POWer<sb>:RESult?](#) on page 637). Alternatively, the results can be output as channel power density, i.e. in reference to the measurement bandwidth.

Furthermore, the measured power values of the displayed trace can be retrieved as usual using the `TRAC:DATA?` commands (see [TRACe<n>\[:DATA\]](#) on page 854). In this case, the measured power value for each sweep point (by default 1001) is returned.

6.2.3 Channel Power Basics

Some background knowledge on basic terms and principles used in channel power measurements is provided here for a better understanding of the required configuration settings.

- [Measurement Methods](#)..... 148
- [Measurement Repeatability](#)..... 150
- [Recommended Common Measurement Parameters](#).....151
- [Measurement on Multi-Standard Radio \(MSR\) Signals](#)..... 155

6.2.3.1 Measurement Methods

The channel power is defined as the integration of the power across the channel bandwidth.

The **Adjacent Channel Leakage Power Ratio (ACLR)** is also known as the **Adjacent Channel Power Ratio (ACPR)**. It is defined as the ratio between the total power of the adjacent channel to the power of the carrier channel. An ACLR measurement with several carrier channels (also known as transmission or TX channels) is also possible and is referred to as a *multicarrier ACLR measurement*.

There are two possible methods for measuring channel and adjacent channel power with a signal analyzer:

- **IBW method** (Integration **B**and**W**idth method)
- **Fast ACLR** (Zero-span method), i.e. using a channel filter

IBW method

When measuring the channel power, the R&S FPS integrates the linear power which corresponds to the levels of the measurement points within the selected channel. The signal analyzer uses a resolution bandwidth which is far smaller than the channel bandwidth. When sweeping over the channel, the channel filter is formed by the pass-band characteristics of the resolution bandwidth.

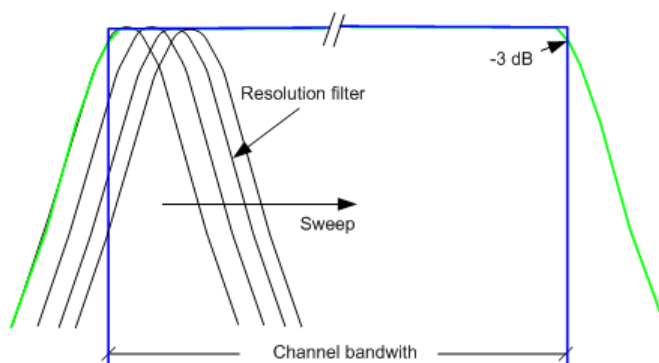

Figure 6-20: Approximating the channel filter by sweeping with a small resolution bandwidth

The following steps are performed:

1. The linear power of all the trace points within the channel is calculated.

$$P_i = 10^{(L_i/10)}$$
 Where P_i = power of the trace pixel i
 L_i = displayed level of trace point i
2. The powers of all trace points within the channel are summed up and the sum is divided by the number of trace points in the channel.
3. The result is multiplied by the quotient of the selected channel bandwidth and the noise bandwidth of the resolution filter (RBW).

Since the power calculation is performed by integrating the trace within the channel bandwidth, this method is called the IBW method (**I**ntegration **B**and**W**idth method).

Fast ACLR

The integrated bandwidth method (IBW) calculates channel power and ACLR from the trace data obtained during a continuous sweep over the selected span. Most parts of this sweep are not part of the channel itself or the defined adjacent channels. Therefore, most of the samples taken during the sweep time cannot be used for channel power or ACLR calculation.

Channel Power and Adjacent-Channel Power (ACLR) Measurement

To decrease the measurement times, the R&S FPS offers a "Fast ACLR" mode. In Fast ACLR mode, the power of the frequency range between the channels of interest is not measured, because it is not required for channel power or ACLR calculation. The measurement time per channel is set with the sweep time. It is equal to the selected measurement time divided by the selected number of channels.

In the "Fast ACLR" mode, the R&S FPS measures the power of each channel in the time domain, with the defined channel bandwidth, at the center frequency of the channel in question. The digital implementation of the resolution bandwidths makes it possible to select filter characteristics that are precisely tailored to the signal. For CDMA2000, for example, the power in the useful channel is measured with a bandwidth of 1.23 MHz. The power of the adjacent channels is measured with a bandwidth of 30 kHz. Therefore the R&S FPS changes from one channel to the other and measures the power at a bandwidth of 1.23 MHz or 30 kHz using the RMS detector.



Figure 6-21: Measuring the channel power and adjacent channel power ratio for CDMA2000 signals with zero span (Fast ACLR)

6.2.3.2 Measurement Repeatability

The repeatability of the results, especially in the narrow adjacent channels, strongly depends on the measurement time for a given resolution bandwidth. A longer sweep time can increase the probability that the measured value converges to the true value of the adjacent channel power, but obviously increases measurement time.

Assume a measurement with five channels (1 channel plus 2 lower and 2 upper adjacent channels) and a sweep time of 100 ms. This measurement requires a measurement time per channel of 20 ms. To calculate the power in one channel, the analyzer considers the following number of effective samples:

$$\langle \text{sweep time in channel} \rangle * \langle \text{selected resolution bandwidth} \rangle$$

For example, for a sweep time of 100 ms the analyzer considers $(30 \text{ kHz} / 4.19 \text{ MHz}) * 100 \text{ ms} * 10 \text{ kHz} \approx 7$ samples. Whereas in Fast ACLR mode, it considers $(100 \text{ ms} / 5) *$

Channel Power and Adjacent-Channel Power (ACLR) Measurement

30 kHz \approx 600 samples. If you compare these numbers, you understand the increase of repeatability with a 95 % confidence level (2σ). It rises from ± 2.8 dB in normal mode to ± 0.34 dB in Fast ACLR mode for a sweep time of 100 ms.

For the same repeatability, the integration method requires a sweep time of 8.5 s. The [Figure 6-22](#) shows the standard deviation of the results as a function of the sweep time.

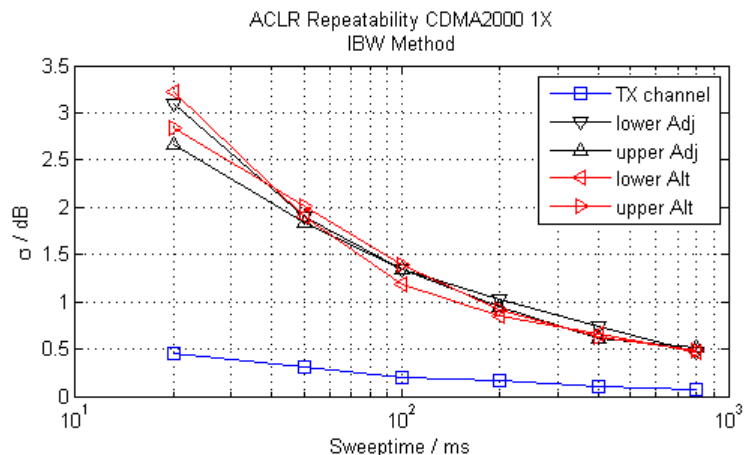

Figure 6-22: Repeatability of adjacent channel power measurement on CDMA2000 standard signals if the integration bandwidth method is used

The [Figure 6-23](#) shows the repeatability of power measurements in the transmit channel and of relative power measurements in the adjacent channels as a function of sweep time. The standard deviation of measurement results is calculated from 100 consecutive measurements. Consider the scaling when you compare power values.

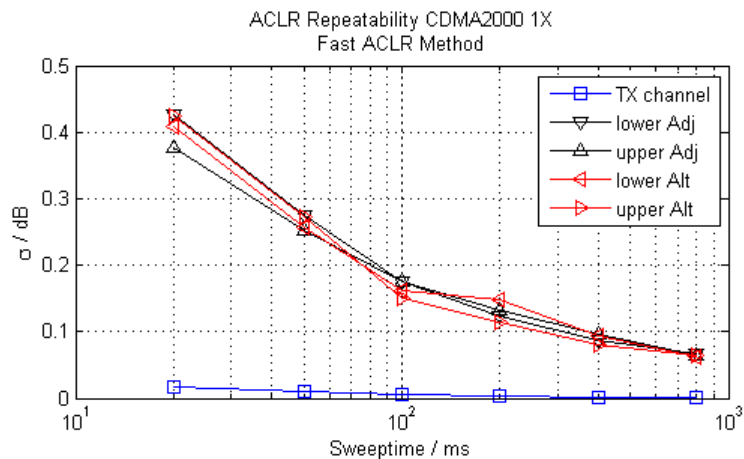

Figure 6-23: Repeatability of adjacent channel power measurements on CDMA2000 signals in the fast ACLR mode

6.2.3.3 Recommended Common Measurement Parameters

The following sections provide recommendations on the most important measurement parameters for channel power measurements.



All instrument settings for the selected channel setup (channel bandwidth, channel spacing) can be optimized automatically using the "Adjust Settings" function (see "[Optimized Settings \(Adjust Settings \)](#)" on page 165).

The easiest way to configure a measurement is using the configuration "Overview", see [Chapter 7.1, "Configuration Overview"](#), on page 300.

• Sweep Time	152
• Frequency Span	153
• Resolution Bandwidth (RBW)	153
• Video Bandwidth (VBW)	154
• Detector	154
• Trace Averaging	155
• Reference Level	155

Sweep Time

The "Sweep Time" is selected depending on the desired reproducibility of results. Reproducibility increases with "Sweep Time" since power measurement is then performed over a longer time period. As a general approach, approximately 500 non-correlated measured values are required for a reproducibility of 0.5 dB. (That means: 95 % of the measurements are within 0.5 dB of the true measured value). Approximately 5000 measured values are required for a reproducibility of 0.1 dB (99 %). These values are valid for white noise. The measured values are considered as non-correlated if their time interval corresponds to the reciprocal of the measured bandwidth.

The number of A/D converter values, N, used to calculate the power, is defined by the "Sweep Time". The time per trace pixel for power measurements is directly proportional to the selected "Sweep Time".

If the sample detector is used, it is best to select the smallest "Sweep Time" possible for a given span and resolution bandwidth. The minimum time is obtained if the setting is coupled, that is: the time per measurement is minimal. Extending the measurement time does not have any advantages. The number of samples for calculating the power is defined by the number of trace points in the channel.

If the RMS detector is used, the selection of "Sweep Time" s can affect the repeatability of the measurement results. Repeatability is increased at longer "Sweep Time" s.

If the RMS detector is used, the number of samples can be estimated as follows:

Since only uncorrelated samples contribute to the RMS value, the number of samples can be calculated from the "Sweep Time" and the resolution bandwidth.

Samples can be assumed to be uncorrelated if sampling is performed at intervals of 1/ RBW. The number of uncorrelated samples is calculated as follows:

$$N_{\text{decorr}} = \text{SWT} * \text{RBW}$$

(N_{decorr} means uncorrelated samples)

The number of uncorrelated samples per trace pixel is obtained by dividing N_{decorr} by 1001 (= pixels per trace).

The "Sweep Time" can be defined using the softkey in the "Ch Power" menu or in the "Sweep" configuration dialog box (see "[Sweep Time](#)" on page 165).

Frequency Span

The frequency span must cover at least the channels to be measured plus a measurement margin of approximately 10 %.

If the frequency span is large in comparison to the channel bandwidth (or the adjacent-channel bandwidths) being analyzed, only a few points on the trace are available per channel. The calculated waveform for the used channel filter is less accurate, which has a negative effect on the measurement accuracy. It is therefore strongly recommended that you consider the described formulas when you select the frequency span.

The frequency span for the defined channel settings can be optimized. Use the "Adjust Settings" function in the "Ch Power" menu or the "General Settings" tab of the "ACLR Setup" dialog box (see "[Optimized Settings \(Adjust Settings \)](#)" on page 165). You can set the frequency span manually in the "Frequency" configuration dialog box.

(See [Chapter 7.3.4, "How To Define the Frequency Range"](#), on page 350.)

For channel power measurements the "Adjust Settings" function sets the frequency span as follows:

"(No. of transmission channels – 1) x transmission channel spacing + 2 x transmission channel bandwidth + measurement margin"

For adjacent-channel power measurements, the "Adjust Settings" function sets the frequency span as a function of the following parameters:

- Number of transmission channels
- Transmission channel spacing
- Adjacent-channel spacing
- Bandwidth of one of adjacent-channels ADJ, ALT1 or ALT2, whichever is furthest away from the transmission channels

"(No. of transmission channels – 1) * (transmission channel spacing + 2) * (adjacent-channel spacing + adjacent-channel bandwidth) + measurement margin"

The measurement margin is approximately 10 % of the value obtained by adding the channel spacing and the channel bandwidth.

Resolution Bandwidth (RBW)

It is important to suppress spectral components outside the channel to be measured, especially of the adjacent channels. At the same time, you expect an acceptable measurement speed. To fulfill both these requirements, the appropriate resolution bandwidth is essential. As a general approach, set the resolution bandwidth to values between 1 % and 4 % of the channel bandwidth.

If the spectrum within the channel to be measured and the spectrum around the channel has a flat characteristic, you can select a larger resolution bandwidth. In the standard setting, e.g. for standard IS95A REV at an adjacent channel bandwidth of 30 kHz, a resolution bandwidth of 30 kHz is used. This yields correct results since the spectrum near the adjacent channels normally has a constant level.

You can optimize the resolution bandwidth for the defined channel settings. Use the "Adjust Settings" function in the "Ch Power" menu or the "General Settings" tab of the "ACLR Setup" dialog box (see ["Optimized Settings \(Adjust Settings \)"](#) on page 165). You can set the RBW manually in the "Bandwidth" configuration dialog box, see [" RBW "](#) on page 368.

Except for the IS95 CDMA standards, the "Adjust Settings" function sets the resolution bandwidth (RBW) as a function of the channel bandwidth:

$$\text{"RBW"} \leq 1/40 \text{ of "Channel Bandwidth"}$$

The maximum resolution bandwidth (concerning the requirement $\text{RBW} \leq 1/40$) resulting from the available RBW steps (1, 3) is selected.

Video Bandwidth (VBW)

For a correct power measurement, the video signal must not be limited in bandwidth. A restricted bandwidth of the logarithmic video signal causes signal averaging and thus results in a too low indication of the power (-2.51 dB at very low video bandwidths). Thus, select the video bandwidth at least three times the resolution bandwidth:

$$\text{VBW} \geq 3 \cdot \text{RBW}$$

For FFT sweeps, instead of increasing the VBW, you can also select the trace average mode "Power" to ensure correct power measurements (see [" Average Mode "](#) on page 468). Note that in power measurements this setting affects the VBW regardless of whether or not a trace is actually averaged.

The video bandwidth for the defined channel settings can be optimized. Use the "Adjust Settings" function in the "Ch Power" menu or the "General Settings" tab of the "ACLR Setup" dialog box (see ["Optimized Settings \(Adjust Settings \)"](#) on page 165). You can set the VBW manually in the "Bandwidth" configuration dialog box, see [" VBW "](#) on page 368.

The video bandwidth (VBW) is set as a function of the channel bandwidth (see formula above) and the smallest possible VBW with regard to the available step size is selected.

Detector

The RMS detector correctly indicates the power irrespective of the characteristics of the signal to be measured. The whole IF envelope is used to calculate the power for each measurement point. The IF envelope is digitized using a sampling frequency which is at least five times the resolution bandwidth which has been selected. Based on the sample values, the power is calculated for each measurement point using the following formula:

$$P_{RMS} = \sqrt{\frac{1}{N} \cdot \sum_{i=1}^N s_i^2}$$

Where:

s_i = linear digitized video voltage at the output of the A/D converter

N = number of A/D converter values per measurement point

P_{RMS} = power represented by a measurement point

When the power has been calculated, the power units are converted into decibels and the value is displayed as a measurement point.

In principle, the sample detector would be possible as well. Due to the limited number of measurement points used to calculate the power in the channel, the sample detector would yield less stable results.

The RMS detector can be set for the defined channel settings automatically. Use the "Adjust Settings" function in the "Ch Power" menu or the "General Settings" tab of the "ACLR Setup" dialog box (see ["Optimized Settings \(Adjust Settings \)"](#) on page 165). You can set the detector manually in the "Traces" configuration dialog box, see ["Detector "](#) on page 467.

Trace Averaging

Avoid averaging, which is often performed to stabilize the measurement results but leads to a level indication that is too low. The reduction in the displayed power depends on the number of averages and the signal characteristics in the channel to be measured.

The "Adjust Settings" function switches off trace averaging. You can deactivate the trace averaging manually in the "Traces" configuration dialog box, see [" Average Mode "](#) on page 468.

Reference Level

To achieve an optimum dynamic range, set the reference level so that the signal is as close to the reference level as possible without forcing an overload message. However, if the signal-to-noise ratio becomes too small, the dynamic range is also limited. The measurement bandwidth for channel power measurements is significantly smaller than the signal bandwidth. Thus, the signal path can be overloaded although the trace is still significantly below the reference level.



Selecting a predefined standard or automatically adjusting settings does not affect the reference level. The reference level can be set automatically using the "Auto Level" function in the AUTO SET menu, or manually in the "Amplitude" menu.

6.2.3.4 Measurement on Multi-Standard Radio (MSR) Signals

Modern base stations can contain multiple signals for different communication standards. A new measurement standard is provided for the R&S FPS ACLR measurement that allows you to measure such MSR signals, including non-contiguous setups. Multiple (also non-) contiguous transmit channels can be specified at absolute frequencies, independent from the common center frequency selected for display.

Signal structure

Up to 18 transmit channels can be grouped in a maximum of 5 *sub blocks*. Between two sub blocks, two gaps are defined: a *lower gap* and an *upper gap*. Each gap in turn contains two channels (*gap channels*). The channels in the upper gap are identical to

Channel Power and Adjacent-Channel Power (ACLR) Measurement

those in the lower gap, but inverted. To either side of the outermost transmit channels, lower and upper adjacent channels can be defined as in common ACLR measurement setups.

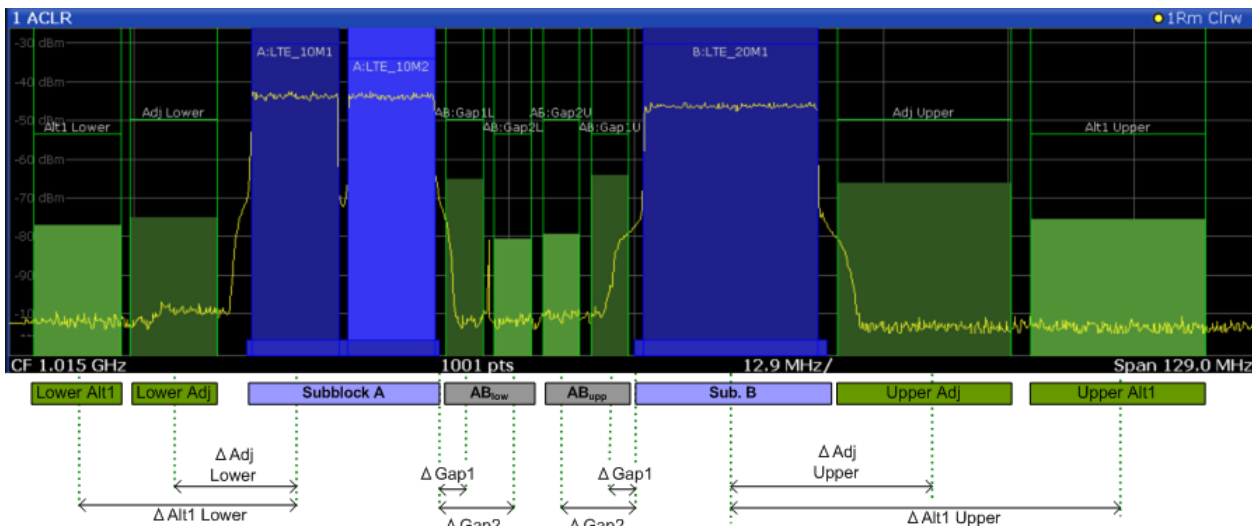

Figure 6-24: MSR signal structure

Sub block and channel definition

The sub blocks are defined by a specified center frequency, RF bandwidth, and number of transmit channels.

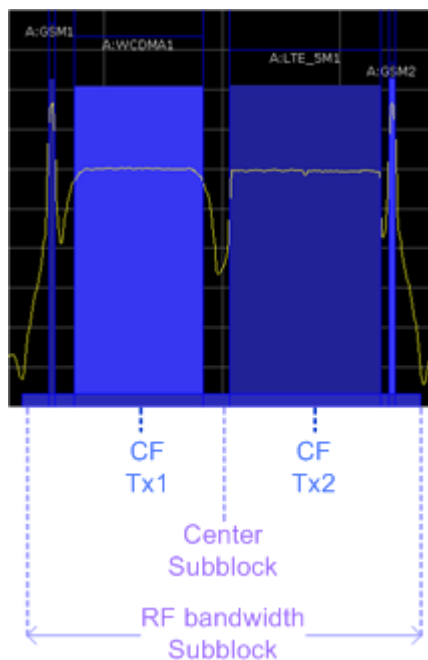

Figure 6-25: Sub block definition

As opposed to common ACLR channel definitions, the Tx channels are defined at absolute frequencies, rather than by a spacing relative to the (common) center fre-

quency. Each transmit channel can be assigned a different technology, used to pre-define the required bandwidth.

Gap channels and CACLR

If two or more sub blocks are defined, the power in the gaps between the sub blocks must also be measured. Gap channels are defined using bandwidths and spacings, relative to the outer edges of the surrounding sub blocks. Since the upper and lower gap channels are symmetrical, only two gap channels must be configured. The required spacing can be determined according to the following formula (indicated for lower channels):

$$\text{Spacing} = [\text{CF of the gap channel}] - [\text{left sub block center}] + ([\text{RF bandwidth of left sub block}] / 2)$$

Figure 6-26: Gap channel definition for lower gap

According to the MSR standard, the **Cumulative Adjacent Channel Leakage Ratio (CACLR)** power must be determined for the gap channels. The CACLR power is measured in the two gap channels for the upper and lower gap. The power in the gap channels is then set in relation to the power of the two closest transmission channels to either side of the gap. The CACLR power for the gap channels is indicated in the Result Summary.

In addition, the ACLR power for the individual gap channels is indicated in the Result Summary. The ACLR power of the lower gap channels refers to the TX channel to the left of the gap. The ACLR power of the upper gap channels refers to the TX channel to the right of the gap. A separate relative limit value can be defined for the ACLR power.

Adjacent channels

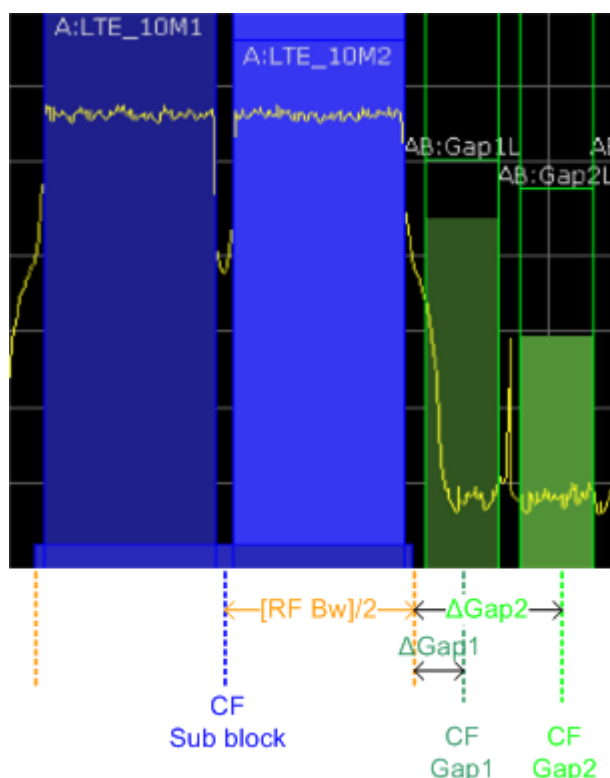
Adjacent channels are defined as in common ACLR measurements using bandwidths and spacings, relative to the uppermost or lowermost transmit channels in the sub blocks (see also [Figure 6-24](#)):

- The spacing of the lower adjacent channels refers to the CF of the first Tx channel in the first sub block.
- The spacing of the upper adjacent channels refers to the CF of the last Tx channel in the last sub block.



The upper and lower adjacent channels can also be defined asymmetrically (see "[Symmetrical Adjacent Setup](#)" on page 174). This is particularly useful if the lowest Tx channel and highest Tx channel use different standards and thus require different bandwidths for adjacent channel power measurement.

Channel display for MSR signals

As in common ACLR measurements, the individual channels are indicated by different colored bars in the diagram. The height of each bar corresponds to the measured power of that channel. In addition, the name of the channel is indicated above the bar. Sub blocks are named A,B,C,D,E and are also indicated by a slim blue bar along the frequency axis.

Tx channel names correspond to the specified technology (for LTE including the bandwidth), followed by a consecutive number. (If the channel is too narrow to display the channel name, "..." is displayed instead.) The assigned sub block is indicated with the channel name, e.g. "B: LTE_5M1" for the first Tx channel in sub block B that uses the LTE 5 MHz bandwidth technology.

Adjacent and alternate channels are displayed as in common ACLR measurements.

Gap channels are indicated using the following syntax:

- The names of the surrounding sub blocks (e.g. "AB" for the gap between sub blocks A and B),
- The channel name ("Gap1" or "Gap2")
- "L" (for lower) or "U" (for upper)

For example: "ABGap1L" indicates the first lower gap channel between sub blocks A and B

Both the lower and upper gap channels are displayed.



The gap channels can be hidden if they do not reach a minimum size, or deactivated entirely. This enhances the result display, as fewer lines and bars are displayed. If gap channels are deactivated, the power results are not calculated and thus are not shown in the Result Summary table.

Furthermore, channel names for all TX, adjacent, and alternate channels are now user-definable.

Channel power results

The Result Summary for MSR signal measurements is similar to the table for common signals (see [Chapter 6.2.2, "Channel Power Results"](#), on page 146). However, the Tx channel results are grouped by sub blocks, and sub block totals are provided instead of a total Tx channel power. Instead of the individual channel frequency offsets, the absolute center frequencies are indicated for the transmit channels.

The CACLR and ACLR power results for each gap channel are appended at the end of the table. The CACLR results are calculated as the power in the gap channel divided by the power sum of the two closest transmission channels to either side of it.

2 Result Summary		Multi-Standard Radio		
Channel	Bandwidth	Frequency	Power	
A:LTE_10M1	9.015 MHz	980.000 MHz	-19.11 dBm	
A:LTE_10M2	9.015 MHz	990.000 MHz	-19.21 dBm	
Sub Block A Total			-16.15 dBm	
Channel	Bandwidth	Frequency	Power	
B:LTE_20M1 (Ref)	18.015 MHz	1.025 GHz	-18.72 dBm	
Sub Block B Total			-18.72 dBm	
Adj Channels	Bandwidth	Offset	ACLR Power	
Adj Lower	9.015 MHz	12.500 MHz	-56.31 dB	
Adj Upper	18.015 MHz	20.000 MHz	-47.50 dB	
Alt1 Lower	9.015 MHz	22.500 MHz	-58.46 dB	
Alt1 Upper	18.015 MHz	40.000 MHz	-56.97 dB	
Gap Channels	Bandwidth	Offset	ACLR Power	CACLR Power
AB:Gap1L	3.840 MHz	2.500 MHz	-45.85 dB	-49.11 dB
AB:Gap1U	3.840 MHz	2.500 MHz	-45.30 dB	-48.07 dB
AB:Gap2L	3.840 MHz	7.500 MHz	-61.51 dB	-64.78 dB
AB:Gap2U	3.840 MHz	7.500 MHz	-60.62 dB	-63.39 dB

Figure 6-27: Result summary for asymmetrical channel definition

Remote command:

```
CALCulate:MARKer:FUNCTION:POWER<sb>:RESult? GACLR OR
CALCulate:MARKer:FUNCTION:POWER<sb>:RESult? MACM , see
CALCulate<n>:MARKer<m>:FUNCTION:POWER<sb>:RESult? on page 637
```

Restrictions and dependencies

As the signal structure in multi-standard radio signals can vary considerably, you can define the channels very flexibly for the ACLR measurement with the R&S FPS. No checks or limitations are implemented concerning the channel definitions, apart from the maximum number of channels to be defined. Thus, you are not notified if transmit channels for a specific sub block lie outside the defined frequency range for the sub block, or if transmit and gap channels overlap.

6.2.4 Channel Power Configuration

Access: "Overview" > "Select Measurement" > "Channel Power ACLR" > "CP / ACLR Config"

Both Channel Power (CP) and Adjacent-Channel Power (ACLR) measurements are available.



If the "Multi-Standard Radio" standard is selected (see ["Standard"](#) on page 161), the "ACLR Setup" dialog box is replaced by the "MSR ACLR Setup" dialog box. See [Chapter 6.2.5, "MSR ACLR Configuration"](#), on page 169 for a description of these settings.

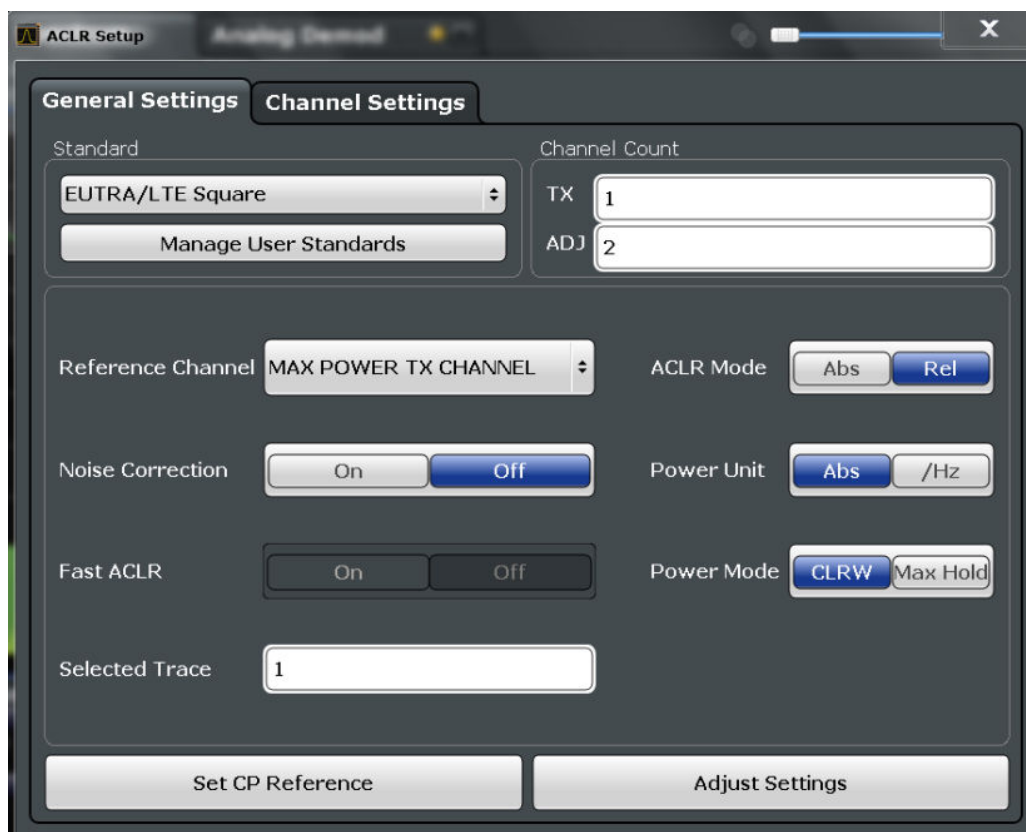

The remote commands required to perform these tasks are described in [Chapter 12.5.3, "Measuring the Channel Power and ACLR"](#), on page 641.

- [General CP/ACLR Measurement Settings](#)..... 160
- [Channel Setup](#)..... 165

6.2.4.1 General CP/ACLR Measurement Settings

General measurement settings are defined in the "ACLR Setup" dialog, in the "General Settings" tab.

Standard	161
L Predefined Standards	161
L User Standards	161
Number of channels: Tx , Adj	162
Reference Channel	163
Noise Cancellation	163
Fast ACLR	163
Selected Trace	164
Absolute and Relative Values (ACLR Mode)	164
Channel power level and density (Power Unit)	164
Power Mode	164
Setting a fixed reference for Channel Power measurements (Set CP Reference) ...	164
Optimized Settings (Adjust Settings)	165
Sweep Time	165

Standard

The main measurement settings can be stored as a standard file. When such a standard is loaded, the required channel and general measurement settings are automatically set on the R&S FPS. However, the settings can be changed. Predefined standards are available for standard measurements, but standard files with user-defined configurations can also be created.

Note: If the "Multi-Standard Radio" standard is selected, the "ACLR Setup" dialog box is replaced by the "MSR ACLR Setup" dialog box (see [Chapter 6.2.5, "MSR ACLR Configuration"](#), on page 169).

If any other predefined standard (or "NONE") is selected, the "ACLR Setup" dialog box is restored (see [Chapter 6.2.4, "Channel Power Configuration"](#), on page 159).

Note that changes in the configuration are not stored when the dialog boxes are exchanged.

Predefined Standards ← Standard

Predefined standards contain the main measurement settings for standard measurements. When such a standard is loaded, the required channel settings are automatically set on the R&S FPS. However, the settings can be changed.

The predefined standards contain the following settings:

- Channel bandwidths
- Channel spacings
- Detector
- Trace Average setting
- Resolution Bandwidth (RBW)
- Weighting Filter

Predefined standards can be selected via the "CP / ACLR Standard" softkey in the "Ch Power" menu or in the "General Settings" tab of the "CP / ACLR Config" dialog box.

For details on the available standards, see [Chapter 6.2.9, "Reference: Predefined CP/ ACLR Standards"](#), on page 192.

Remote command:

`CALCulate<n>:MARKer<m>:FUNCTION:POWER:PRESet` on page 642

User Standards ← Standard

Access: "CP / ACLR Config" > "General Settings" tab > "Manage User Standards"

In addition to the predefined standards, you can save your own standards with your specific measurement settings in an XML file so you can use them again later. User-defined standards are stored on the instrument in the `C:\R_S\INSTR\acp_std` directory.

A set of predefined XML files for common ACLR measurements are provided in this directory (see [Chapter 6.2.10, "Reference: Predefined ACLR User Standard XML Files"](#), on page 193).

A sample file is provided for an MSR ACLR measurement (`MSR_ACLRExample.xml`). It sets up the measurement for the MSR signal generator waveform described in the file `C:\R_S\INSTR\USER\waveform\MSRA_GSM_WCDMA_LTE_GSM.wv`.

Note that ACLR user standards are not supported for Fast ACLR and multicarrier ACLR measurements.

Note: User standards created on an analyzer of the R&S FSP family are compatible to the R&S FPS. User standards created on an R&S FPS, however, are not necessarily compatible to the analyzers of the R&S FSP family and may not work there.

The following parameter definitions are saved in a user-defined standard:

- Number of adjacent channels
- Channel bandwidth of transmission (Tx), adjacent (Adj) and alternate (Alt) channels
- Channel spacings
- Weighting filters
- Resolution bandwidth
- Video bandwidth
- Detector
- ACLR limits and their state
- "Sweep Time" and "Sweep Time" coupling
- Trace and power mode
- (MSR only: sub block and gap channel definition)

Save the current measurement settings as a user-defined standard, load a stored measurement configuration, or delete an existing configuration file.

For details see [Chapter 6.2.6.4, "How to Manage User-Defined Configurations"](#), on page 187.

Remote command:

To query all available standards:

`CALCulate<n>:MARKer<m>:FUNCTION:POWER:STANDARD:CATALOG?`

on page 642

To load a standard:

`CALCulate<n>:MARKer<m>:FUNCTION:POWER:PRESet` on page 642

To save a standard:

`CALCulate<n>:MARKer<m>:FUNCTION:POWER:STANDARD:SAVE` on page 643

To delete a standard:

`CALCulate<n>:MARKer<m>:FUNCTION:POWER:STANDARD:DELETE` on page 642

Number of channels: Tx , Adj

Up to 18 carrier channels and up to 12 adjacent channels can be defined.

Results are provided for the Tx channel and the number of defined adjacent channels *above and below* the Tx channel. If more than one Tx channel is defined, the carrier channel to which the relative adjacent-channel power values should be referenced must be defined (see "[Reference Channel](#)" on page 163).

Note: If several carriers (Tx channels) are activated for the measurement, the number of sweep points is increased to ensure that adjacent-channel powers are measured with adequate accuracy.

For more information on how the number of channels affects the measured powers, see [Chapter 6.2.2, "Channel Power Results"](#), on page 146.

Remote command:

Number of Tx channels:

`[SENSe:]POWER:ACHannel:TXChannel:COUNT` on page 647

Number of Adjacent channels:

`[SENSe:]POWER:ACHannel:ACPairs` on page 643

Reference Channel

The measured power values in the adjacent channels can be displayed relative to the transmission channel. If more than one Tx channel is defined, define which one is used as a reference channel.

Tx Channel 1	Transmission channel 1 is used. (Not available for MSR ACLR)
Min Power Tx Channel	The transmission channel with the lowest power is used as a reference channel.
Max Power Tx Channel	The transmission channel with the highest power is used as a reference channel (Default).
Lowest & Highest Channel	The outer left-hand transmission channel is the reference channel for the lower adjacent channels, the outer right-hand transmission channel that for the upper adjacent channels.

Remote command:

[\[SENSe:\] POWER:ACHannel:REference:TXChannel:MANual](#) on page 650

[\[SENSe:\] POWER:ACHannel:REference:TXChannel:AUTO](#) on page 650

Noise Cancellation

The R&S FPS can correct the results by removing the inherent noise of the analyzer, which increases the dynamic range.

In this case, a reference measurement of the inherent noise of the analyzer is carried out. The measured noise power is then subtracted from the power in the channel that is being analyzed (first active trace only).

The inherent noise of the instrument depends on the selected center frequency, resolution bandwidth and level setting. Therefore, the correction function is disabled whenever one of these parameters is changed. A disable message is displayed on the screen. To enable the correction function after changing one of these settings, activate it again. A new reference measurement is carried out.

Noise cancellation is also available in zero span.

Currently, noise cancellation is only available for the following trace detectors (see "[Detector](#)" on page 467):

- RMS
- Average
- Sample
- Positive peak

Remote command:

[\[SENSe:\] POWER:NCORrection](#) on page 794

Fast ACLR

If activated, instead of using the IBW method, the R&S FPS sets the center frequency to the different channel center frequencies consecutively and measures the power with the selected measurement time (= sweep time/number of channels).

Remote command:

[\[SENSe:\] POWER:HSPeed](#) on page 657

Selected Trace

The CP/ACLR measurement can be performed on any active trace.

Remote command:

[\[SENSe:\] POWer:TRACe](#) on page 641

Absolute and Relative Values (ACLR Mode)

The powers of the adjacent channels are output in dBm or dBm/Hz (absolute values), or in dBc, relative to the specified reference Tx channel.

"Abs" The absolute power in the adjacent channels is displayed in the unit of the y-axis, e.g. in dBm, dBμV.

"Rel" The level of the adjacent channels is displayed relative to the level of the transmission channel in dBc.

Remote command:

[\[SENSe:\] POWer:ACHannel:MODE](#) on page 672

Channel power level and density (Power Unit)

By default, the channel power is displayed in absolute values. If "/Hz" is activated, the channel power density is displayed instead. Thus, the absolute unit of the channel power is switched from dBm to dBm/Hz.

Note: The channel power density in dBm/Hz corresponds to the power inside a bandwidth of 1 Hz and is calculated as follows:

"channel power density = channel power – log₁₀(channel bandwidth)"

Thus you can measure the signal/noise power density, for example, or use the additional functions [Absolute and Relative Values \(ACLR Mode\)](#) and [Reference Channel](#) to obtain the signal to noise ratio.

Remote command:

[CALCulate<n>:MARKer<m>:FUNCTION:POWer:RESult:PHZ](#) on page 672

Power Mode

The measured power values can be displayed directly for each trace ("Clear/ Write"), or only the maximum values over a series of measurements can be displayed ("Max Hold"). In the latter case, the power values are calculated from the current trace and compared with the previous power value using a maximum algorithm. The higher value is retained. If "Max Hold" mode is activated, "Pwr Max" is indicated in the table header. Note that the *trace* mode remains unaffected by this setting.

Remote command:

[CALCulate<n>:MARKer<m>:FUNCTION:POWer:MODE](#) on page 637

Setting a fixed reference for Channel Power measurements (Set CP Reference)

If only one Tx channel and no adjacent channels are defined, the currently measured channel power can be used as a fixed reference value for subsequent channel power measurements.

When you select this button, the channel power currently measured on the Tx channel is stored as a fixed reference power. In the following channel power measurements, the power is indicated relative to the fixed reference power. The reference value is displayed in the "Reference" field (in relative ACLR mode); the default value is 0 dBm.

Note: In adjacent-channel power measurement, the power is always referenced to a transmission channel (see " [Reference Channel](#) " on page 163), thus, this function is not available.

Remote command:

[SENSe:]POWER:ACHannel:REference:AUTO ONCE on page 650

Optimized Settings (Adjust Settings)

All instrument settings for the selected channel setup (channel bandwidth, channel spacing) can be optimized automatically.

The adjustment is carried out only once. If necessary, the instrument settings can be changed later.

The following settings are optimized by "Adjust Settings" :

- "Frequency Span" on page 153
- "Resolution Bandwidth (RBW)" on page 153
- "Video Bandwidth (VBW)" on page 154
- "Detector" on page 154
- "Trace Averaging" on page 155

Note: The reference level is not affected by this function. To adjust the reference level automatically, use the [Setting the Reference Level Automatically \(Auto Level \)](#) function in the AUTO SET menu.

Remote command:

[SENSe:]POWER:ACHannel:PRESet on page 640

Sweep Time

With the RMS detector, a longer "Sweep Time" increases the stability of the measurement results. For recommendations on setting this parameter, see " [Sweep Time](#) " on page 152.

The "Sweep Time" can be set via the softkey in the "Ch Power" menu and is identical to the general setting in the "Sweep" configuration dialog box.

Remote command:

[SENSe:]SWEep:TIME on page 790

6.2.4.2 Channel Setup

The "Channel Settings" tab in the "ACLR Setup" dialog box provides all the channel settings to configure the channel power or ACLR measurement. You can define the channel settings for all channels, independent of the defined number of *used* Tx or adjacent channels (see " [Number of channels: Tx , Adj](#) " on page 162).

For details on setting up channels, see [Chapter 6.2.6.2, "How to Set Up the Channels"](#), on page 185.



In addition to the specific channel settings, the general settings " [Standard](#) " on page 161 and " [Number of channels: Tx , Adj](#) " on page 162 are also available in this tab.

The following settings are available in individual subtabs of the "Channel Settings" tab.

Channel Bandwidth 166
 Channel Spacings 167
 Limit Check 167
 Weighting Filters 168
 Channel Names 168

Channel Bandwidth

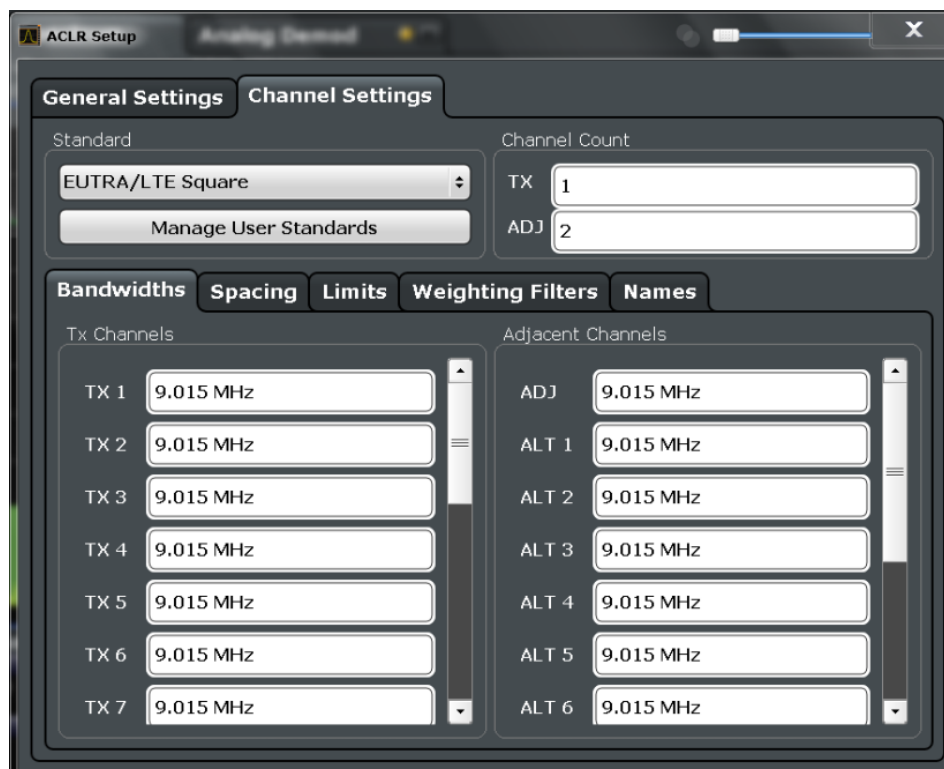

The Tx channel bandwidth is normally defined by the transmission standard.

The correct bandwidth is set automatically for the selected standard. The bandwidth for each channel is indicated by a colored bar in the display.

For measurements that require channel bandwidths which deviate from those defined in the selected standard, use the IBW method ("Fast ACLR" "Off"). With the IBW method, the channel bandwidth borders are right and left of the channel center frequency. Thus, you can visually check whether the entire power of the signal under test is within the selected channel bandwidth.

The value entered for any Tx channel is automatically also defined for all subsequent Tx channels. Thus, only enter one value if all Tx channels have the same bandwidth.

The value entered for any ADJ or ALT channel is automatically also defined for all alternate (ALT) channels. Thus, only enter one value if all adjacent channels have the same bandwidth.

Remote command:

[SENSe:] POWER:ACHannel:BANDwidth[:CHANnel<ch>] on page 644

[SENSe:] POWER:ACHannel:BANDwidth:ACHannel on page 644

[SENSe:] POWER:ACHannel:BANDwidth:ALternate<ch> on page 644

Channel Spacings

Channel spacings are normally defined by the transmission standard but can be changed.

If the spacings are not equal, the channel distribution in relation to the center frequency is as follows:

Odd number of Tx channels	The middle Tx channel is centered to center frequency.
Even number of Tx channels	The two Tx channels in the middle are used to calculate the frequency between those two channels. This frequency is aligned to the center frequency.

The spacings between all Tx channels can be defined individually. When you change the spacing for one channel, the value is automatically also defined for all subsequent Tx channels. This allows you to set up a system with equal Tx channel spacing quickly. For different spacings, set up the channels from top to bottom.

Tx1-2	Spacing between the first and the second carrier
Tx2-3	Spacing between the second and the third carrier
...	...

If you change the adjacent-channel spacing (ADJ), all higher adjacent channel spacings (ALT1, ALT2, ...) are multiplied by the same factor (new spacing value/old spacing value). Again, only enter one value for equal channel spacing. For different spacing, configure the spacings from top to bottom.

For details, see [Chapter 6.2.6.2, "How to Set Up the Channels"](#), on page 185

Remote command:

[SENSe:] POWER:ACHannel:SPACing:CHANnel<ch> on page 647

[SENSe:] POWER:ACHannel:SPACing[:ACHannel] on page 646

[SENSe:] POWER:ACHannel:SPACing:ALternate<ch> on page 646

Limit Check

During an ACLR measurement, the power values can be checked whether they exceed user-defined or standard-defined limits. A relative or absolute limit can be defined, or both. Both limit types are considered, regardless whether the measured levels are absolute or relative values. The check of both limit values can be activated independently. If any active limit value is exceeded, the measured value is displayed in red and marked by a preceding asterisk in the result table.

Channel Power and Adjacent-Channel Power (ACLR) Measurement

Tx Power 30.54 dBm			Tx Bandwidth 3.840 MHz		W-CDMA 3GPP DL	
Range Low	Range Up	RBW	Frequency	Power Abs	Power Rel	ΔLimit
-12.750 MHz	-8.000 MHz	1.000 MHz	2.09053 GHz	-40.68 dBm	-71.22 dB	-17.18 dB
-8.000 MHz	-4.000 MHz	1.000 MHz	2.09268 GHz	-40.13 dBm	-70.67 dB	-20.63 dB
-4.000 MHz	-3.515 MHz	30.000 kHz	2.09647 GHz	-52.60 dBm	-83.14 dB	-20.10 dB
-3.515 MHz	-2.715 MHz	30.000 kHz	2.09652 GHz	-54.30 dBm	-84.84 dB	-22.38 dB
-2.715 MHz	-2.515 MHz	30.000 kHz	2.09728 GHz	-51.51 dBm	-82.05 dB	-31.01 dB
2.515 MHz	2.715 MHz	30.000 kHz	2.10270 GHz	-54.13 dBm	-84.67 dB	-33.63 dB
2.715 MHz	3.515 MHz	30.000 kHz	2.10299 GHz*	-17.29 dBm*	-47.83 dB*	7.27 dB*
3.515 MHz	4.000 MHz	30.000 kHz	2.10355 GHz	-51.94 dBm	-82.48 dB	-19.44 dB
4.000 MHz	8.000 MHz	1.000 MHz	2.10725 GHz	-40.01 dBm	-70.55 dB	-20.51 dB
8.000 MHz	12.750 MHz	1.000 MHz	2.10911 GHz	-40.28 dBm	-70.82 dB	-16.78 dB

The results of the power limit checks are also indicated in the `STAT:QUES:ACPL` status registry (see "[STATus:QUESTIONable:ACPLimit Register](#)" on page 594).

Remote command:

`CALCulate<n>:LIMit<k>:ACPowEr[:STATe]` on page 656

`CALCulate<n>:LIMit<k>:ACPowEr:ACHannel:ABSolute:STATe` on page 651

`CALCulate<n>:LIMit<k>:ACPowEr:ACHannel:ABSolute` on page 651

`CALCulate<n>:LIMit<k>:ACPowEr:ACHannel[:RELative]:STATe`

on page 653

`CALCulate<n>:LIMit<k>:ACPowEr:ACHannel[:RELative]` on page 652

`CALCulate<n>:LIMit<k>:ACPowEr:ALternate<ch>:ABSolute:STATe`

on page 654

`CALCulate<n>:LIMit<k>:ACPowEr:ALternate<ch>:ABSolute` on page 653

`CALCulate<n>:LIMit<k>:ACPowEr:ALternate<ch>[:RELative]:STATe`

on page 655

`CALCulate<n>:LIMit<k>:ACPowEr:ALternate<ch>[:RELative]` on page 654

`CALCulate<n>:LIMit<k>:ACPowEr:ACHannel:RESult?` on page 652

Weighting Filters

Weighting filters allow you to determine the influence of individual channels on the total measurement result. For each channel you can activate or deactivate the use of the weighting filter and define an individual weighting factor ("Alpha:" value).

Weighting filters are not available for all supported standards and cannot always be defined manually where they are available.

Remote command:

Activating/Deactivating:

`[SENSe:]POWEr:ACHannel:FILTer[:STATe]:CHANnel<ch>` on page 649

`[SENSe:]POWEr:ACHannel:FILTer[:STATe]:ACHannel` on page 648

`[SENSe:]POWEr:ACHannel:FILTer[:STATe]:ALternate<ch>` on page 649

Alpha value:

`[SENSe:]POWEr:ACHannel:FILTer:ALPHa:CHANnel<ch>` on page 648

`[SENSe:]POWEr:ACHannel:FILTer:ALPHa:ACHannel` on page 647

`[SENSe:]POWEr:ACHannel:FILTer:ALPHa:ALternate<ch>` on page 648

Channel Names

In the R&S FPS's display, carrier channels are labeled "Tx" by default; the first neighboring channel is labeled "Adj" (adjacent) channel; all others are labeled "Alt" (alternate) channels. You can define user-specific channel names for each channel which are displayed in the result diagram and result table.

Remote command:

[SENSe:] POWer:ACHannel:NAME:ACHannel on page 645

[SENSe:] POWer:ACHannel:NAME:ALternate<ch> on page 645

[SENSe:] POWer:ACHannel:NAME:CHANnel<ch> on page 645

6.2.5 MSR ACLR Configuration

Access: "Overview" > "Select Measurement" > "Channel Power ACLR" > "CP / ACLR Standard" > "Standard" : "Multi-Standard Radio" > "CP / ACLR Config"

ACLR measurements can also be performed on input containing multiple signals for different communication standards. A new measurement standard is provided that allows you to define multiple discontinuous transmit channels at specified frequencies, independent from the selected center frequency. If the "Multi-Standard Radio" standard is selected (see "Standard" on page 161), the "ACLR Setup" dialog box is replaced by the "MSR ACLR Setup" dialog box.

For more information, see [Chapter 6.2.3.4, "Measurement on Multi-Standard Radio \(MSR\) Signals"](#), on page 155.

The remote commands required to perform these tasks are described in [Chapter 12.5.3, "Measuring the Channel Power and ACLR"](#), on page 641.

- [General MSR ACLR Measurement Settings](#)..... 169
- [MSR Sub Block and Tx Channel Definition](#)..... 175
- [MSR Adjacent Channel Setup](#)..... 177
- [MSR Gap Channel Setup](#)..... 180
- [MSR Channel Names](#)..... 183

6.2.5.1 General MSR ACLR Measurement Settings

Access: "Overview" > "Select Measurement" > "Channel Power ACLR" > "CP / ACLR Standard" > "Standard" : "Multi-Standard Radio" > "CP / ACLR Config" > "MSR General Settings" tab

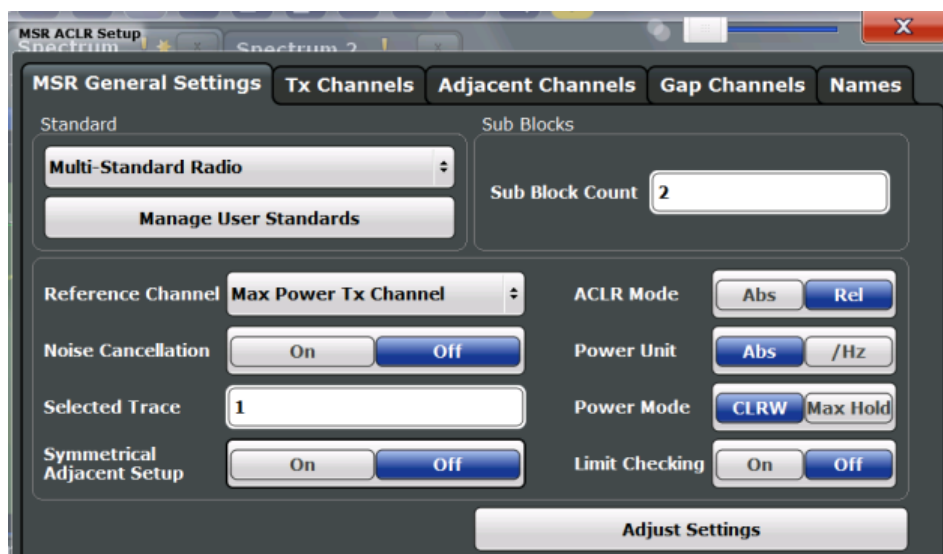

Standard170

- L Predefined Standards170
- L User Standards171

Number of Sub Blocks172

Reference Channel172

Noise Cancellation172

Selected Trace173

Absolute and Relative Values (ACLR Mode)173

Channel power level and density (Power Unit).....173

Power Mode174

Optimized Settings (Adjust Settings).....174

Symmetrical Adjacent Setup174

Limit Checking174

Standard

The main measurement settings can be stored as a standard file. When such a standard is loaded, the required channel and general measurement settings are automatically set on the R&S FPS. However, the settings can be changed. Predefined standards are available for standard measurements, but standard files with user-defined configurations can also be created.

Note: If the "Multi-Standard Radio" standard is selected, the "ACLR Setup" dialog box is replaced by the "MSR ACLR Setup" dialog box (see Chapter 6.2.5, "MSR ACLR Configuration", on page 169).

If any other predefined standard (or "NONE") is selected, the "ACLR Setup" dialog box is restored (see Chapter 6.2.4, "Channel Power Configuration", on page 159).

Note that changes in the configuration are not stored when the dialog boxes are exchanged.

Predefined Standards ← Standard

Predefined standards contain the main measurement settings for standard measurements. When such a standard is loaded, the required channel settings are automatically set on the R&S FPS. However, the settings can be changed.

The predefined standards contain the following settings:

- Channel bandwidths
- Channel spacings
- Detector
- Trace Average setting
- Resolution Bandwidth (RBW)
- Weighting Filter

Predefined standards can be selected via the "CP / ACLR Standard" softkey in the "Ch Power" menu or in the "General Settings" tab of the "CP / ACLR Config" dialog box.

For details on the available standards, see [Chapter 6.2.9, "Reference: Predefined CP/ ACLR Standards"](#), on page 192.

Remote command:

`CALCulate<n>;MARKer<m>;FUNCTION:POWer:PRESet` on page 642

User Standards ← Standard

Access: "CP / ACLR Config" > "General Settings" tab > "Manage User Standards"

In addition to the predefined standards, you can save your own standards with your specific measurement settings in an XML file so you can use them again later. User-defined standards are stored on the instrument in the `C:\R_S\INSTR\acp_std` directory.

A set of predefined XML files for common ACLR measurements are provided in this directory (see [Chapter 6.2.10, "Reference: Predefined ACLR User Standard XML Files"](#), on page 193).

A sample file is provided for an MSR ACLR measurement (`MSR_ACLRExample.xml`). It sets up the measurement for the MSR signal generator waveform described in the file `C:\R_S\INSTR\USER\waveform\MSRA_GSM_WCDMA_LTE_GSM.wv`.

Note that ACLR user standards are not supported for Fast ACLR and multicarrier ACLR measurements.

Note: User standards created on an analyzer of the R&S FSP family are compatible to the R&S FPS. User standards created on an R&S FPS, however, are not necessarily compatible to the analyzers of the R&S FSP family and may not work there.

The following parameter definitions are saved in a user-defined standard:

- Number of adjacent channels
- Channel bandwidth of transmission (Tx), adjacent (Adj) and alternate (Alt) channels
- Channel spacings
- Weighting filters
- Resolution bandwidth
- Video bandwidth
- Detector
- ACLR limits and their state
- "Sweep Time" and "Sweep Time" coupling
- Trace and power mode
- (MSR only: sub block and gap channel definition)

Save the current measurement settings as a user-defined standard, load a stored measurement configuration, or delete an existing configuration file.

For details see [Chapter 6.2.6.4, "How to Manage User-Defined Configurations"](#), on page 187.

Remote command:

To query all available standards:

`CALCulate<n>:MARKer<m>:FUNCTION:POWER:STANDARD:CATALOG?`

on page 642

To load a standard:

`CALCulate<n>:MARKer<m>:FUNCTION:POWER:PRESet` on page 642

To save a standard:

`CALCulate<n>:MARKer<m>:FUNCTION:POWER:STANDARD:SAVE` on page 643

To delete a standard:

`CALCulate<n>:MARKer<m>:FUNCTION:POWER:STANDARD:DELETE` on page 642

Number of Sub Blocks

Defines the number of sub blocks, i.e. groups of transmission channels in an MSR signal.

For more information, see [Chapter 6.2.3.4, "Measurement on Multi-Standard Radio \(MSR\) Signals"](#), on page 155.

Remote command:

`[SENSe:] POWER:ACHannel:SBCount` on page 659

Reference Channel

The measured power values in the adjacent channels can be displayed relative to the transmission channel. If more than one Tx channel is defined, define which one is used as a reference channel.

Tx Channel 1	Transmission channel 1 is used. (Not available for MSR ACLR)
Min Power Tx Channel	The transmission channel with the lowest power is used as a reference channel.
Max Power Tx Channel	The transmission channel with the highest power is used as a reference channel (Default).
Lowest & Highest Channel	The outer left-hand transmission channel is the reference channel for the lower adjacent channels, the outer right-hand transmission channel that for the upper adjacent channels.

Remote command:

`[SENSe:] POWER:ACHannel:REFERENCE:TXChannel:MANual` on page 650

`[SENSe:] POWER:ACHannel:REFERENCE:TXChannel:AUTO` on page 650

Noise Cancellation

The R&S FPS can correct the results by removing the inherent noise of the analyzer, which increases the dynamic range.

In this case, a reference measurement of the inherent noise of the analyzer is carried out. The measured noise power is then subtracted from the power in the channel that is being analyzed (first active trace only).

Channel Power and Adjacent-Channel Power (ACLR) Measurement

The inherent noise of the instrument depends on the selected center frequency, resolution bandwidth and level setting. Therefore, the correction function is disabled whenever one of these parameters is changed. A disable message is displayed on the screen. To enable the correction function after changing one of these settings, activate it again. A new reference measurement is carried out.

Noise cancellation is also available in zero span.

Currently, noise cancellation is only available for the following trace detectors (see "[Detector](#)" on page 467):

- RMS
- Average
- Sample
- Positive peak

Remote command:

[\[SENSe:\]POWer:NCORrection](#) on page 794

Selected Trace

The CP/ACLR measurement can be performed on any active trace.

Remote command:

[\[SENSe:\]POWer:TRACe](#) on page 641

Absolute and Relative Values (ACLR Mode)

The powers of the adjacent channels are output in dBm or dBm/Hz (absolute values), or in dBc, relative to the specified reference Tx channel.

"Abs" The absolute power in the adjacent channels is displayed in the unit of the y-axis, e.g. in dBm, dBμV.

"Rel" The level of the adjacent channels is displayed relative to the level of the transmission channel in dBc.

Remote command:

[\[SENSe:\]POWer:ACHannel:MODE](#) on page 672

Channel power level and density (Power Unit)

By default, the channel power is displayed in absolute values. If "/Hz" is activated, the channel power density is displayed instead. Thus, the absolute unit of the channel power is switched from dBm to dBm/Hz.

Note: The channel power density in dBm/Hz corresponds to the power inside a bandwidth of 1 Hz and is calculated as follows:

"channel power density = channel power – log₁₀(channel bandwidth)"

Thus you can measure the signal/noise power density, for example, or use the additional functions [Absolute and Relative Values \(ACLR Mode\)](#) and [Reference Channel](#) to obtain the signal to noise ratio.

Remote command:

[CALCulate<n>:MARKer<m>:FUNCTION:POWer:RESult:PHZ](#) on page 672

Power Mode

The measured power values can be displayed directly for each trace ("Clear/ Write"), or only the maximum values over a series of measurements can be displayed ("Max Hold"). In the latter case, the power values are calculated from the current trace and compared with the previous power value using a maximum algorithm. The higher value is retained. If "Max Hold" mode is activated, "Pwr Max" is indicated in the table header. Note that the *trace* mode remains unaffected by this setting.

Remote command:

`CALCulate<n>:MARKer<m>:FUNCTION:POWER:MODE` on page 637

Optimized Settings (Adjust Settings)

All instrument settings for the selected channel setup (channel bandwidth, channel spacing) can be optimized automatically.

The adjustment is carried out only once. If necessary, the instrument settings can be changed later.

The following settings are optimized by "Adjust Settings" :

- "Frequency Span" on page 153
- "Resolution Bandwidth (RBW)" on page 153
- "Video Bandwidth (VBW)" on page 154
- "Detector" on page 154
- "Trace Averaging" on page 155

Note: The reference level is not affected by this function. To adjust the reference level automatically, use the [Setting the Reference Level Automatically \(Auto Level \)](#) function in the AUTO SET menu.

Remote command:

`[SENSe:] POWER:ACHannel:PRESet` on page 640

Symmetrical Adjacent Setup

If enabled, the upper and lower adjacent and alternate channels are defined symmetrically. This is the default behavior.

If disabled, the upper and lower channels can be configured differently. This is particularly useful if the lowest Tx channel and highest Tx channel use different standards and thus require different bandwidths for adjacent channel power measurement.

Remote command:

`[SENSe:] POWER:ACHannel:SSETup` on page 663

Limit Checking

Activates or deactivates limit checks globally for all adjacent and gap channels. In addition to this setting, limits must be defined and activated individually for each channel.

The results of the power limit checks are also indicated in the `STAT:QUES:ACPL` status registry (see ["STATus:QUESTIONable:ACPLimit Register"](#) on page 594).

Remote command:

`CALCulate<n>:LIMIT<k>:ACPower[:STATe]` on page 656

6.2.5.2 MSR Sub Block and Tx Channel Definition

Access: "Overview" > "Select Measurement" > "Channel Power ACLR" > "CP / ACLR Standard" > "Standard" : "Multi-Standard Radio" > "CP / ACLR Config" > "Tx Channels" tab

The "Tx Channels" tab provides all the channel settings to configure sub blocks and Tx channels in MSR ACLR measurements.

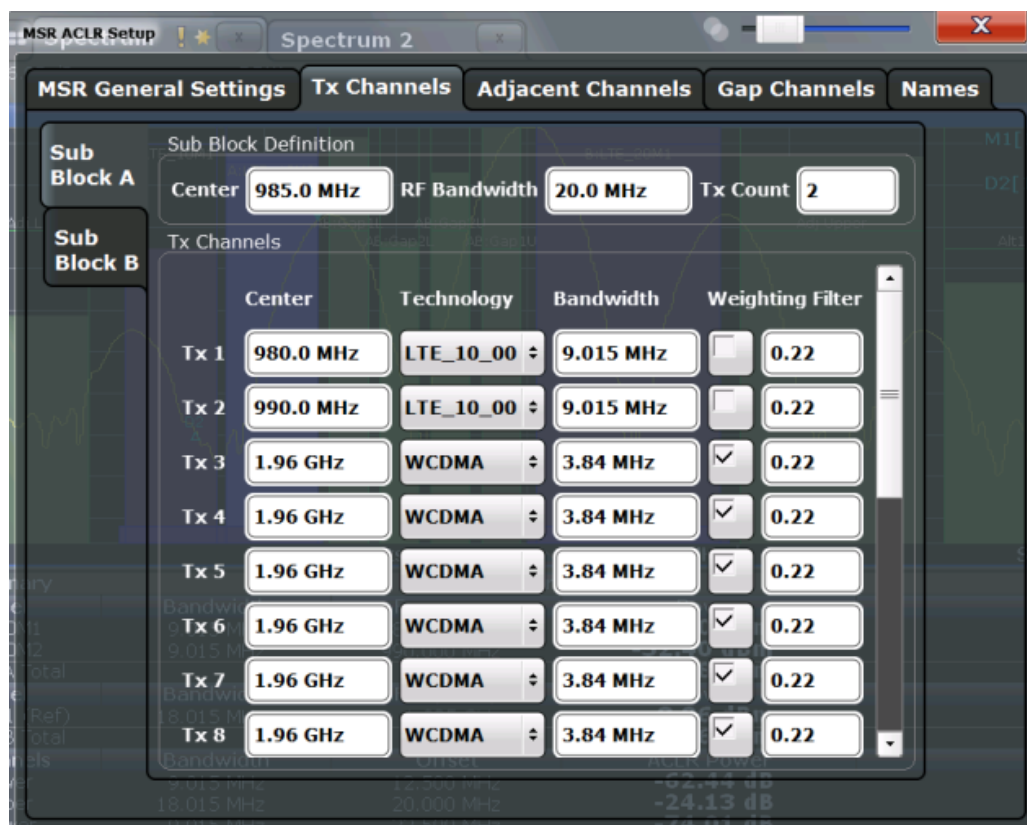

For details on MSR signals, see [Chapter 6.2.3.4, "Measurement on Multi-Standard Radio \(MSR\) Signals"](#), on page 155.

For details on setting up channels, see [Chapter 6.2.6.3, "How to Configure an MSR ACLR Measurement"](#), on page 186.

The Tx channel settings for the individual sub blocks are configured in individual sub-tabs of the "Tx Channel Settings" tab.

Sub Block Definition	176
L Sub Block / Center Freq	176
L RF Bandwidth	176
L Number of Tx Channels (Tx Count)	176
Tx Channel Definition	176
L Tx Center Frequency	176
L Technology Used for Transmission	177
L Tx Channel Bandwidth	177
L Weighting Filters	177

Sub Block Definition

Sub blocks are groups of transmit channels in an MSR signal. Up to five sub blocks can be defined. They are defined as an RF bandwidth around a center frequency with a specific number of transmit channels (max. 18).

Sub blocks are named A,B,C,D,E and are indicated by a slim blue bar along the frequency axis.

Sub Block / Center Freq ← Sub Block Definition

Defines the center of an MSR sub block. Note that the position of the sub block also affects the position of the adjacent gap channels.

Remote command:

`[SENSe:] POWER:ACHannel:SBLOCK<sb>:FREQUENCY:CENTer` on page 660

RF Bandwidth ← Sub Block Definition

Defines the bandwidth of the individual MSR sub block. Note that sub block ranges also affect the position of the adjacent gap channels.

Remote command:

`[SENSe:] POWER:ACHannel:SBLOCK<sb>:RFBWidth` on page 661

Number of Tx Channels (Tx Count) ← Sub Block Definition

Defines the number of transmit channels the specific sub block contains. The maximum is 18 Tx channels.

Remote command:

`[SENSe:] POWER:ACHannel:SBLOCK<sb>:TXCHANNEL:COUNT` on page 662

Tx Channel Definition

As opposed to common ACLR channel definitions, the Tx channels are defined at absolute frequencies, rather than by a spacing relative to the (common) center frequency. Each transmit channel can be assigned a different technology, used to predefine the required bandwidth.

The Tx channel settings for the individual sub blocks are configured in individual sub-tabs of the "Tx Channel Settings" tab.

For details on configuring MSR Tx channels, see [Chapter 6.2.6.3, "How to Configure an MSR ACLR Measurement"](#), on page 186.

Remote command:

`[SENSe:] POWER:ACHannel:SBLOCK<sb>:NAME[:CHANNEL<ch>]` on page 670

Tx Center Frequency ← Tx Channel Definition

Defines the (absolute) center frequency of an MSR Tx channel. Each Tx channel is defined independently of the others; automatic spacing as in common ACLR measurements is not performed.

Note that the position of the adjacent channels is also affected by:

- The position of the first Tx channel in the first sub block
- The position of last Tx channel in the last sub block

Remote command:

`[SENSe:] POWER:ACHannel:SBLOCK<sb>:CENTer[:CHANNEL<ch>]` on page 659

Technology Used for Transmission ← Tx Channel Definition

The technology used for transmission by the individual channel can be defined for each channel. The required channel bandwidth and use of a weighting filter are pre-configured automatically according to the selected technology standard.

"GSM"	Transmission according to GSM standard
"W-CDMA"	Transmission according to W-CDMA standard
"LTE_xxx"	Transmission according to LTE standard for different channel bandwidths
"USER"	User-defined transmission; no automatic preconfiguration possible

Remote command:

```
[SENSe:]POWer:ACHannel:SBLOCK<sb>:TECHnology[:CHANnel<ch>]
on page 661
```

Tx Channel Bandwidth ← Tx Channel Definition

The Tx channel bandwidth is normally defined by the transmission technology standard. The correct bandwidth is predefined automatically for the selected technology. Each Tx channel is defined independently of the others; automatic bandwidth configuration for subsequent channels as in common ACLR measurements is not performed.

The bandwidth for each channel is indicated by a colored bar in the display.

Remote command:

```
[SENSe:]POWer:ACHannel:SBLOCK<sb>:BANDwidth[:CHANnel<ch>]
on page 659
```

Weighting Filters ← Tx Channel Definition

Weighting filters allow you to determine the influence of individual channels on the total measurement result. For each channel, you can activate or deactivate the use of the weighting filter and define an individual weighting factor ("Alpha:" value).

Remote command:

Activating/Deactivating:

```
[SENSe:]POWer:ACHannel:FILTer[:STATe]:SBLOCK<sb>:CHANnel<ch>
on page 658
```

Alpha value:

```
[SENSe:]POWer:ACHannel:FILTer:ALPHa:SBLOCK<sb>:CHANnel<ch>
on page 658
```

6.2.5.3 MSR Adjacent Channel Setup

Access: "Overview" > "Select Measurement" > "Channel Power ACLR" > "CP / ACLR Standard" > "Standard" : "Multi-Standard Radio" > "CP / ACLR Config" > "Adjacent Channels" tab

The "Adjacent Channels" tab provides all the channel settings to configure adjacent and gap channels in MSR ACLR measurements.



For symmetrical channel definition (see " [Symmetrical Adjacent Setup](#) " on page 174), the dialog box is reduced as the upper and lower channels are identical.

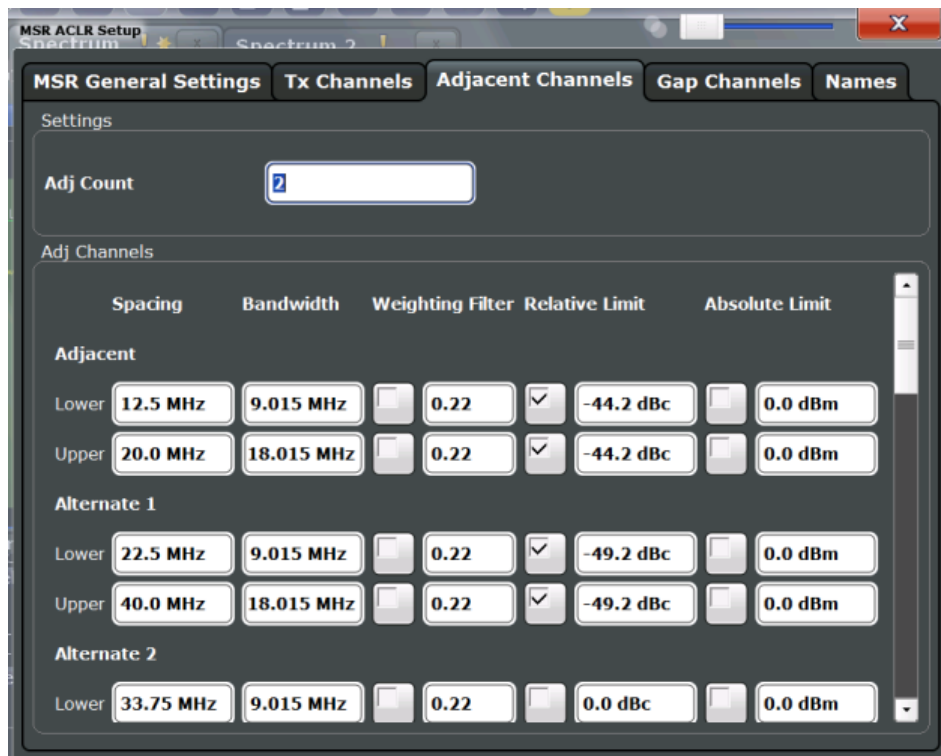

Figure 6-28: Asymmetrical adjacent channel definition

For details on setting up channels, see [Chapter 6.2.6.3, "How to Configure an MSR ACLR Measurement"](#), on page 186.

Number of Adjacent Channels (Adj Count)	178
Adjacent Channel Definition	178
L Adjacent Channel Spacings	179
L Adjacent Channel Bandwidths	179
L Weighting Filters	179
L Limit Checking	180

Number of Adjacent Channels (Adj Count)

Defines the number of adjacent channels *above and below* the Tx channel block in an MSR signal. You must define the carrier channel to which the relative adjacent-channel power values refer (see " [Reference Channel](#) " on page 163).

Remote command:

`[SENSe:]POWER:ACHannel:ACPairs` on page 643

Adjacent Channel Definition

Defines the channels adjacent to the transmission channel block in MSR signals. A maximum of 12 adjacent channels can be defined.

For MSR signals, adjacent channels are defined in relation to the center frequency of the first and last transmission channel in the entire block, i.e.:

- The lower adjacent channels are defined in relation to the CF of the first Tx channel in the first sub block.
- The upper adjacent channels are defined in relation to the CF of the last Tx channel in the last sub block.

Adjacent channels are named "Adj" and "Alt1" to "Alt11" by default; the names can be changed manually (see [Chapter 6.2.5.5, "MSR Channel Names"](#), on page 183).

In all other respects, channel definition is identical to common ACLR measurements.

Adjacent Channel Spacings ← Adjacent Channel Definition

Channel spacings are normally predefined by the selected technology but can be changed.

For MSR signals, adjacent channels are defined in relation to the center frequency of the first and last transmission channel in the entire block, i.e.:

- The spacing of the lower adjacent channels refers to the CF of the first Tx channel in the first sub block.
- The spacing of the upper adjacent channels refers to the CF of the last Tx channel in the last sub block.

For details, see [Chapter 6.2.6.3, "How to Configure an MSR ACLR Measurement"](#), on page 186

Remote command:

`[SENSe:] POWER:ACHannel:SPACing[:ACHannel]` on page 646

`[SENSe:] POWER:ACHannel:SPACing:ALternate<ch>` on page 646

`[SENSe:] POWER:ACHannel:SPACing:UACHannel` on page 662

`[SENSe:] POWER:ACHannel:SPACing:UALternate<ch>` on page 662

Adjacent Channel Bandwidths ← Adjacent Channel Definition

The adjacent channel bandwidth is normally predefined by the transmission technology standard. The correct bandwidth is set automatically for the selected technology. The bandwidth for each channel is indicated by a colored bar in the display.

Remote command:

`[SENSe:] POWER:ACHannel:BANDwidth:ACHannel` on page 644

`[SENSe:] POWER:ACHannel:BANDwidth:ALternate<ch>` on page 644

`[SENSe:] POWER:ACHannel:BANDwidth:UACHannel` on page 663

`[SENSe:] POWER:ACHannel:BANDwidth:UALternate<ch>` on page 663

Weighting Filters ← Adjacent Channel Definition

Weighting filters allow you to determine the influence of individual channels on the total measurement result. For each channel, you can activate or deactivate the use of the weighting filter and define an individual weighting factor ("Alpha:" value).

Remote command:

Activating/Deactivating:

`[SENSe:] POWER:ACHannel:FILTer[:STATe]:ACHannel` on page 648

`[SENSe:] POWER:ACHannel:FILTer[:STATe]:ALternate<ch>` on page 649

`[SENSe:] POWER:ACHannel:FILTer[:STATe]:UACHannel` on page 664

`[SENSe:] POWER:ACHannel:FILTer[:STATe]:UALternate<ch>` on page 665

Alpha value:

[SENSe:] POWer:ACHannel:FILTer:ALPHa:ACHannel on page 647

[SENSe:] POWer:ACHannel:FILTer:ALPHa:ALternate<ch> on page 648

[SENSe:] POWer:ACHannel:FILTer:ALPHa:UACHannel on page 664

[SENSe:] POWer:ACHannel:FILTer:ALPHa:UALternate<ch> on page 664

Limit Checking ← Adjacent Channel Definition

During an ACLR measurement, the power values can be checked whether they exceed user-defined or standard-defined limits. A relative or absolute limit can be defined, or both, for each individual adjacent channel. Both limit types are considered, regardless whether the measured levels are absolute or relative values. The check of both limit values can be activated independently. If any active limit value is exceeded, the measured value is displayed in red and marked by a preceding asterisk in the result table.

Note that in addition to activating limit checking for individual channels, limit checking must also be activated globally for the MSR ACLR measurement (see " [Limit Checking](#) " on page 174).

2 Result Summary		Multi-Standard Radio		
Channel	Bandwidth	Frequency	Power	
B: GSM2	200.000 kHz	1.020 GHz	-80.44 dBm	
Sub Block B Total			-29.15 dBm	
Channel	Bandwidth	Offset	Lower	Upper
Act*	3.840 MHz	5.000 MHz	-33.27 dB *	-32.63 dB *
Alt1	3.840 MHz	10.000 MHz	-49.76 dB	-50.37 dB

Remote command:

CALCulate<n>:LIMit<k>:ACPowEr[:STATe] on page 656

CALCulate<n>:LIMit<k>:ACPowEr:ACHannel:ABSolute:STATe on page 651

CALCulate<n>:LIMit<k>:ACPowEr:ACHannel:ABSolute on page 651

CALCulate<n>:LIMit<k>:ACPowEr:ACHannel[:RELative]:STATe

on page 653

CALCulate<n>:LIMit<k>:ACPowEr:ACHannel[:RELative] on page 652

CALCulate<n>:LIMit<k>:ACPowEr:ALternate<ch>:ABSolute:STATe

on page 654

CALCulate<n>:LIMit<k>:ACPowEr:ALternate<ch>:ABSolute on page 653

CALCulate<n>:LIMit<k>:ACPowEr:ALternate<ch>[:RELative]:STATe

on page 655

CALCulate<n>:LIMit<k>:ACPowEr:ALternate<ch>[:RELative] on page 654

CALCulate<n>:LIMit<k>:ACPowEr:ACHannel:RESult? on page 652

6.2.5.4 MSR Gap Channel Setup

Access: "Overview" > "Select Measurement" > "Channel Power ACLR" > "CP / ACLR Standard" > "Standard" : "Multi-Standard Radio" > "CP / ACLR Config" > "Gap Channels" tab

The "Gap Channels" tab provides all the channel settings to configure adjacent and gap channels in MSR ACLR measurements.

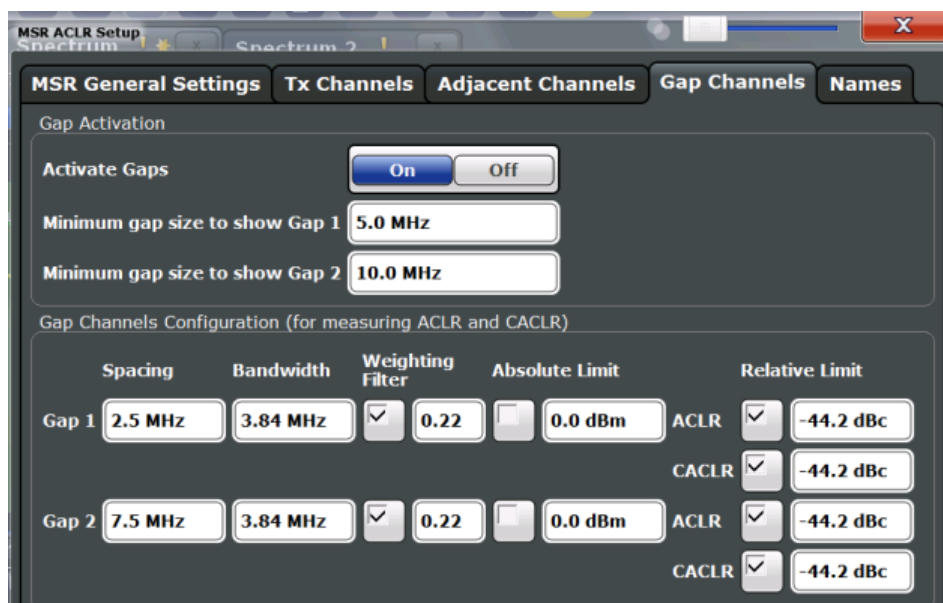

For details on MSR signals, see [Chapter 6.2.3.4, "Measurement on Multi-Standard Radio \(MSR\) Signals"](#), on page 155.

For details on setting up channels, see [Chapter 6.2.6.3, "How to Configure an MSR ACLR Measurement"](#), on page 186.

- [Activate Gaps](#) 181
- [Minimum gap size to show Gap 1 / Minimum gap size to show Gap 2](#) 181
- [Gap Channel Definition](#) 181
 - [L Gap Channel Spacing](#) 182
 - [L Gap Channel Bandwidths](#) 182
 - [L Weighting Filters](#) 182
 - [L Limit Checking](#) 182

Activate Gaps

If enabled, the gap channels are displayed and channel power results are calculated and displayed in the Result Summary.

Remote command:

```
[SENSe:] POWER:ACHannel:AGChannels on page 668
```

Minimum gap size to show Gap 1 / Minimum gap size to show Gap 2

If the gap between the sub blocks does not exceed the specified bandwidth, the gap channels are not displayed in the diagram. The gap channel results are not calculated in the result summary.

Remote command:

```
[SENSe:] POWER:ACHannel:GAP<gap>:MSIZE on page 669
```

Gap Channel Definition

Between two sub blocks in an MSR signal, two gaps are defined: a *lower gap* and an *upper gap*. Each gap in turn contains two channels, the *gap channels*. The channels in the upper gap are identical to those in the lower gap, but inverted. Thus, in the R&S FPS MSR ACLR measurement, only two gap channels are configured.

Gap channels are indicated using the following syntax:

- The names of the surrounding sub blocks (e.g. "AB" for the gap between sub blocks A and B),
- The channel name ("Gap1" or "Gap2")
- "L" (for lower) or "U" (for upper)

Gap Channel Spacing ← Gap Channel Definition

Gap channel spacings are normally predefined by the MSR standard but can be changed.

Gap channels are defined using bandwidths and spacings, relative to the outer edges of the surrounding sub blocks. Since the upper and lower gap channels are identical, only two channels must be configured. The required spacing can be determined according to the following formula (indicated for lower channels):

$$\text{Spacing} = [\text{CF of the gap channel}] - [\text{left sub block center}] + ([\text{RF bandwidth of left sub block}] / 2)$$

(See also [Figure 6-25](#) and [Figure 6-26](#).)

For details, see [Chapter 6.2.6.3, "How to Configure an MSR ACLR Measurement"](#), on page 186.

Remote command:

`[SENSe:] POWER:ACHannel:SPACing:GAP<gap>` on page 669

Gap Channel Bandwidths ← Gap Channel Definition

The gap channel bandwidth is normally predefined by the transmission technology standard. The correct bandwidth is set automatically for the selected technology. The bandwidth for each channel is indicated by a colored bar in the display (if the gap is not too narrow, see ["Channel display for MSR signals"](#) on page 158).

Remote command:

`[SENSe:] POWER:ACHannel:BANDwidth:GAP<gap>` on page 668

Weighting Filters ← Gap Channel Definition

Weighting filters allow you to determine the influence of individual channels on the total measurement result. For each channel, you can activate or deactivate the use of the weighting filter and define an individual weighting factor ("Alpha:" value).

Remote command:

`[SENSe:] POWER:ACHannel:FILTer[:STATe]:GAP<gap>` on page 669

`[SENSe:] POWER:ACHannel:FILTer:ALPHa:GAP<gap>` on page 668

Limit Checking ← Gap Channel Definition

During an ACLR measurement, the power values can be checked whether they exceed user-defined or standard-defined limits. A relative or absolute limit can be defined, or both, for each individual gap channel. Both limit types are considered, regardless whether the measured levels are absolute or relative values. The check of both limit values can be activated independently. Furthermore, relative limits can be defined and activated individually for ACLR or CACLR power levels.

If any active limit value is exceeded, the measured value is displayed in red and marked by a preceding asterisk in the result table.

Channel Power and Adjacent-Channel Power (ACLR) Measurement

Note that in addition to activating limit checking for individual channels, limit checking must also be activated globally for the MSR ACLR measurement (see " [Limit Checking](#) " on page 174).

Remote command:

`CALCulate<n>:LIMit<k>:ACPower[:STATE]` on page 656

`CALCulate<n>:LIMit<k>:ACPower:GAP<gap>:ABSolute:STATE` on page 666

`CALCulate<n>:LIMit<k>:ACPower:GAP<gap>:ACLR[:RELative]:STATE`
on page 666

`CALCulate<n>:LIMit<k>:ACPower:GAP<gap>[:CACLR][:RELative]:STATE`
on page 667

`CALCulate<n>:LIMit<k>:ACPower:GAP<gap>:ABSolute` on page 665

`CALCulate<n>:LIMit<k>:ACPower:GAP<gap>:ACLR[:RELative]` on page 666

`CALCulate<n>:LIMit<k>:ACPower:GAP<gap>[:CACLR][:RELative]`
on page 667

`CALCulate<n>:LIMit<k>:ACPower:GAP<gap>[:CACLR]:RESult?` on page 671

6.2.5.5 MSR Channel Names

Access: "Overview" > "Select Measurement" > "Channel Power ACLR" > "CP / ACLR Standard" > "Standard" : "Multi-Standard Radio" > "CP / ACLR Config" > "Names" tab

Channel names for all TX, adjacent, and alternate channels are user-definable.

In the "Names" tab, you can define a customized name for each channel in each sub block. Note that the names are not checked for uniqueness.

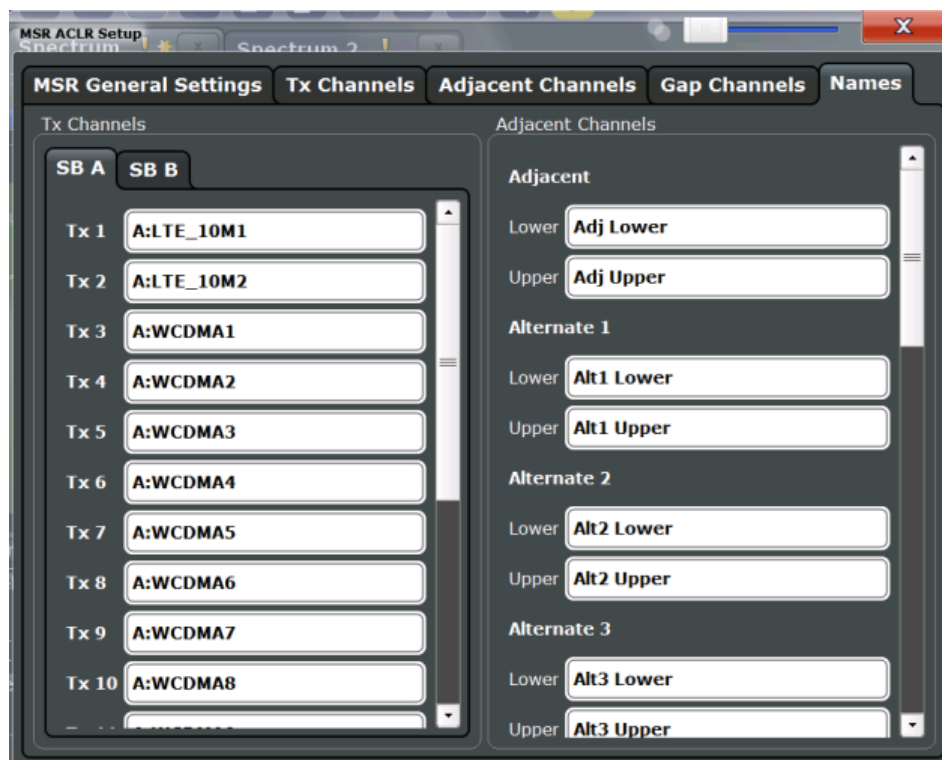

Figure 6-29: Channel name definition for asymmetric adjacent channels

Remote command:

[SENSe:] POWER:ACHannel:SBLOCK<sb>:NAME[:CHANnel<ch>] on page 670

[SENSe:] POWER:ACHannel:NAME:ACHannel on page 645

[SENSe:] POWER:ACHannel:NAME:ALternate<ch> on page 645

[SENSe:] POWER:ACHannel:NAME:UACHannel on page 670

[SENSe:] POWER:ACHannel:NAME:UALternate<ch> on page 670

6.2.6 How to Perform Channel Power Measurements

The following step-by-step instructions demonstrate the most common tasks when performing channel power measurements.



For remote operation, see [Chapter 12.5.3.10, "Programming Examples for Channel Power Measurements"](#), on page 673.

- [How to Perform a Standard Channel Power Measurement](#)..... 184
- [How to Set Up the Channels](#)..... 185
- [How to Configure an MSR ACLR Measurement](#)..... 186
- [How to Manage User-Defined Configurations](#)..... 187
- [How to Compare the Tx Channel Power in Successive Measurements](#)..... 188

6.2.6.1 How to Perform a Standard Channel Power Measurement

Performing a channel power or ACLR measurement according to common standards is a very easy and straightforward task with the R&S FPS.

1. Press the MEAS key or select "Select Measurement" in the "Overview" .
2. Select "Channel Power ACLR" .
The measurement is started immediately with the default settings.
3. Select the "CP / ACLR Standard" softkey.
4. Select a standard from the list.
The measurement is restarted with the predefined settings for the selected standard.
5. If necessary, edit the settings for your specific measurement as described in [Chapter 6.2.6.2, "How to Set Up the Channels"](#), on page 185, or load a user-defined configuration (see ["To load a user-defined configuration"](#) on page 188).

6.2.6.2 How to Set Up the Channels

Channel definition is the basis for measuring power levels in certain frequency ranges. Usually, the power levels in one or more carrier (Tx) channels and possibly the adjacent channels are of interest. Up to 18 carrier channels and up to 12 adjacent channels can be defined.

When a measurement standard is selected, all settings including the channel bandwidths and channel spacings are set according to the selected standard. Select a standard in the "Ch Power" menu or the "ACLR Setup" dialog box. You can adjust the settings afterwards.

Channel setup consists of the following settings:

- The number of transmission (Tx) and adjacent channels
- The bandwidth of each channel
- For multicarrier ACLR measurements: which Tx channel is used as a reference
- The spacing between the individual channels
- Optionally: the names of the channels displayed in the diagram and result table
- Optionally: the influence of individual channels on the total measurement result ("Weighting Filter")
- Optionally: limits for a limit check on the measured power levels



Changes to an existing standard can be stored as a user-defined standard, see [Chapter 6.2.6.4, "How to Manage User-Defined Configurations"](#), on page 187.

- ▶ To configure the channels in the "Ch Power" dialog box, select "Ch Power" > "CP / ACLR Config" > "Channel Settings" tab.



In the "Channel Setup" dialog box, you can define the channel settings for all channels, independent of the defined number of *used* Tx or adjacent channels.

To define channel spacings

Channel spacings are normally defined by the selected standard but can be changed.

- ▶ In the "Channel Settings" tab of the "ACLR Setup" dialog box, select the "Spacing" subtab.

The value entered for any Tx channel is automatically also defined for all subsequent Tx channels. Thus, only enter one value if all Tx channels have the same spacing.

If the channel spacing for the adjacent or an alternate channel is changed, all higher alternate channel spacings are multiplied by the same factor (new spacing value/old spacing value). The lower adjacent-channel spacings remain unchanged. Only enter one value for equal channel spacing.

Example: Defining channel spacing

In the default setting, the adjacent channels have the following spacing: 20 kHz ("ADJ"), 40 kHz ("ALT1"), 60 kHz ("ALT2"), 80 kHz ("ALT3"), 100 kHz ("ALT4"), ...

Set the spacing of the first adjacent channel ("ADJ") to 40 kHz. For all other adjacent channels, the spacing is multiplied by factor 2: 80 kHz ("ALT1"), 120 kHz ("ALT2"), 160 kHz ("ALT3"), ...

Starting from the default setting, set the spacing of the fifth adjacent channel ("ALT4") to 150 kHz. For all higher adjacent channels, the spacing is multiplied by factor 1.5: 180 kHz ("ALT5"), 210 kHz ("ALT6"), 240 kHz ("ALT7"), ...

6.2.6.3 How to Configure an MSR ACLR Measurement

You configure ACLR measurements on MSR signals in a special configuration dialog box on the R&S FPS.

1. Press the MEAS key or select "Select Measurement" in the "Overview" .
2. Select "Channel Power ACLR" .
The measurement is started immediately with the default settings.
3. Select the "CP / ACLR Standard" softkey.
4. Select the "Multi-Standard Radio" standard from the list.
5. Select the "CP / ACLR Config" softkey to configure general MSR settings, including the number of sub blocks (up to 5).
To configure asymmetric adjacent channels, deactivate the "Symmetrical" option in the general MSR settings.
6. Select the "Tx Channels" tab to configure the sub blocks and transmission channels.
For each sub block:
 - a) Define the (center frequency) position and bandwidth of the sub block, as well as the number of transmission channels it contains.
 - b) For each transmission channel in the sub block:
 - Define the center frequency.
 - Select the technology used for transmission.
 - Check the bandwidth.
 - If necessary, define the use of a weighting filter for the channel.
7. Select the "Adjacent Channels" tab to configure the adjacent channels.
8. Define the number of adjacent channels and the settings for each channel:
 - The spacing, defined as the distance of the center frequency from the center frequency of the first transmission channel in the first sub block.
For asymmetrical channels, define the upper adjacent channel spacing as the distance from the center frequency of the last transmission channel in the last sub block.
 - The bandwidth

Channel Power and Adjacent-Channel Power (ACLR) Measurement

- If necessary, a weighting filter
 - Optionally, define *and activate* relative or absolute limits, or both, against which the power levels of the channel are to be checked.
9. Select the "Gap Channels" tab to configure the gap channels.
 10. Define the following settings for the two (upper or lower) gap channels. Since the upper and lower channels are identical, it is only necessary to configure two channels.
 - The spacing, defined as the distance of the center frequency from the outer edge of the sub block to the left or right of the gap. You can determine the required spacing as follows:

$$\text{Spacing} = [\text{CF of the gap channel}] - [\text{left sub block center}] + ([\text{RF bandwidth of left sub block}] / 2)$$
 - The bandwidth
 - If necessary, a weighting filter
 - Optionally, define *and activate* relative or absolute limits, or both, against which the power levels of the channel are to be checked.
 11. If power limits are defined and activated, activate global limit checking for the measurement on the "MSR General Settings" tab.
 12. Optionally, store the settings for the MSR ACLR measurement as a user-defined standard as described in ["To store a user-defined configuration"](#) on page 187. Otherwise the configuration is lost when you select a different measurement standard.

6.2.6.4 How to Manage User-Defined Configurations

You can define measurement configurations independently of a predefined standard and save the current ACLR configuration as a "user standard" in an XML file. You can then load the file and thus the settings again later.

User-defined standards are not supported for "Fast ACLR" and multicarrier ACLR measurements.



Compatibility to R&S FSP

User standards created on an analyzer of the R&S FSP family are compatible to the R&S FPS. User standards created on an R&S FPS, however, are not necessarily compatible to the analyzers of the R&S FSP family and may not work there.

To store a user-defined configuration

1. In the "Ch Power" menu, select the "CP / ACLR Config" softkey to display the "ACLR Setup" dialog box.
2. Configure the measurement as required (see also [Chapter 6.2.6.2, "How to Set Up the Channels"](#), on page 185).
3. In the "General Settings" tab, select the "Manage User Standards" button to display the "Manage" dialog box.

4. Define a filename and storage location for the user standard.
By default, the XML file is stored in C:\R_S\INSTR\acp_std\. However, you can define any other storage location.
5. Select "Save" .

To load a user-defined configuration

1. In the "General Settings" tab of the "ACLR Setup" dialog box, select the "Manage User Standards" button to display the "Manage" dialog box.
2. Select the user standard file.
3. Select "Load" .

The stored settings are automatically set on the R&S FPS and the measurement is restarted with the new parameters.

6.2.6.5 How to Compare the Tx Channel Power in Successive Measurements

For power measurements with only one Tx channel and no adjacent channels, you can define a fixed reference power and compare subsequent measurement results to the stored reference power.

1. Configure a measurement with only one Tx channel and no adjacent channels (see also [Chapter 6.2.6.2, "How to Set Up the Channels"](#), on page 185).
2. In the "ACLR Setup" dialog box, select the "Set CP Reference" button.
The channel power currently measured on the Tx channel is stored as a fixed reference power. The reference value is displayed in the "Reference" field of the result table (in relative ACLR mode).
3. Start a new measurement.
The resulting power is indicated relative to the fixed reference power.
4. Repeat this for any number of measurements.
5. To start a new measurement without the fixed reference, temporarily define a second channel or preset the instrument.

6.2.7 Measurement Examples

The R&S FPS has test routines for simple channel and adjacent channel power measurements. These routines give quick results without any complex or tedious setting procedures.



A programming example demonstrating an ACLR measurement in a remote environment is provided in [Chapter 12.5.3.10, "Programming Examples for Channel Power Measurements"](#), on page 673.

- [Measurement Example 1 – ACPR Measurement on a CDMA2000 Signal](#)..... 189
- [Measurement Example 3 – Measuring the Intrinsic Noise of the R&S FPS with the Channel Power Function](#)..... 190

6.2.7.1 Measurement Example 1 – ACPR Measurement on a CDMA2000 Signal

Test setup:

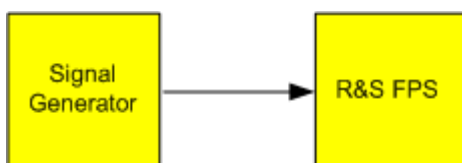

Signal generator settings (e.g. R&S SMW):

Frequency:	850 MHz
Level:	0 dBm
Modulation:	CDMA2000

Procedure:

1. Preset the R&S FPS.
2. Set the center frequency to *850 MHz*.
3. Set the span to *4 MHz*.
4. Set the reference level to *+10 dBm*.
5. Press the MEAS key or select "Select Measurement" in the "Overview" .
6. Select the "Channel Power ACLR" measurement function.
7. Set the "CDMA2000 1X" standard for adjacent channel power measurement in the "ACLR Setup" dialog box.

The R&S FPS sets the channel configuration according to the 2000 standard with two adjacent channels above and 2 below the transmit channel. The spectrum is displayed in the upper part of the screen, the numeric values of the results and the channel configuration in the lower part of the screen. The various channels are represented by vertical lines on the graph.

Channel Power and Adjacent-Channel Power (ACLR) Measurement

The frequency span, resolution bandwidth, video bandwidth and detector are selected automatically to give correct results. To obtain stable results – especially in the adjacent channels (30 kHz bandwidth) which are narrow in comparison with the transmission channel bandwidth (1.23 MHz) – the RMS detector is used.

8. Set the optimal reference level and RF attenuation for the applied signal level using the "Auto Level" function in the AUTO SET menu.
9. Activate "Fast ACLR" mode in the "ACLR Setup" dialog box to increase the repeatability of results.

The R&S FPS sets the optimal RF attenuation and the reference level based on the transmission channel power to obtain the maximum dynamic range. The [Figure 6-30](#) shows the result of the measurement.

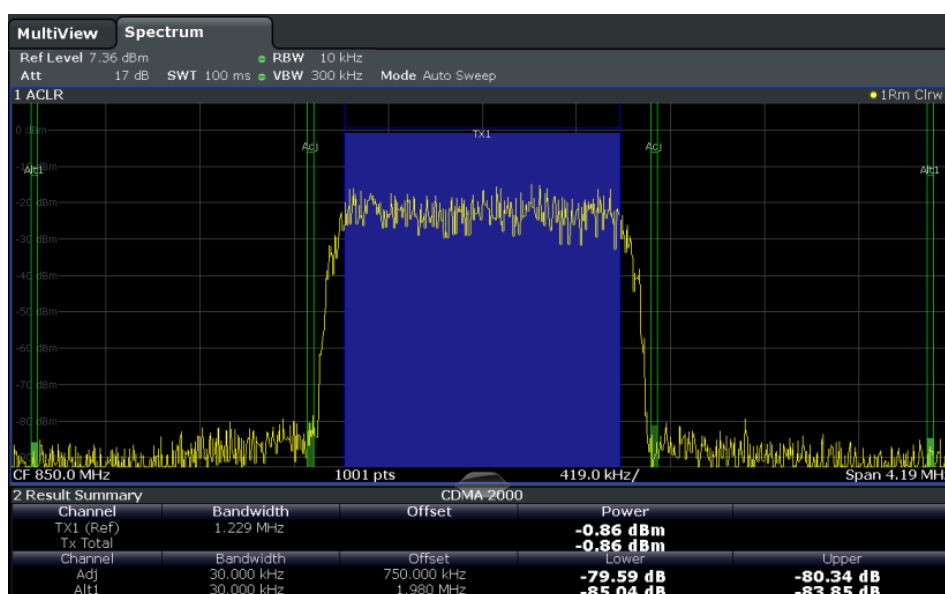

Figure 6-30: Adjacent channel power measurement on a CDMA2000 1x signal

6.2.7.2 Measurement Example 3 – Measuring the Intrinsic Noise of the R&S FPS with the Channel Power Function

Noise in any bandwidth can be measured with the channel power measurement functions. Thus the noise power in a communication channel can be determined, for example.

If the noise spectrum within the channel bandwidth is flat, the noise marker can be used to determine the noise power in the channel by considering the channel bandwidth. However, in the following cases, the channel power measurement method must be used to obtain correct measurement results:

- If phase noise and noise that normally increases towards the carrier is dominant in the channel to be measured
- If there are discrete spurious signals in the channel

Channel Power and Adjacent-Channel Power (ACLR) Measurement

Test setup:

- ▶ Leave the RF input of the R&S FPS open-circuited or terminate it with 50 Ω .

Procedure:

1. Preset the R&S FPS.
2. Set the center frequency to 1 GHz and the span to 1 MHz.
3. To obtain maximum sensitivity, set RF attenuation to 0 dB and the reference level to -40 dBm.
4. Select the "Channel Power ACLR" measurement function from the "Select Measurement" dialog box.
5. In the "ACLR Setup" dialog box, set up a single Tx channel with the channel bandwidth 1.23 MHz.
6. Select the "Adjust Settings" softkey.
The settings for the frequency span, the bandwidth (RBW and VBW) and the detector are automatically set to the optimum values required for the measurement.
7. Stabilize the measurement result by increasing the "Sweep Time" .
Set the "Sweep Time" to 1 s.

The trace becomes much smoother because of the RMS detector and the channel power measurement display is much more stable.

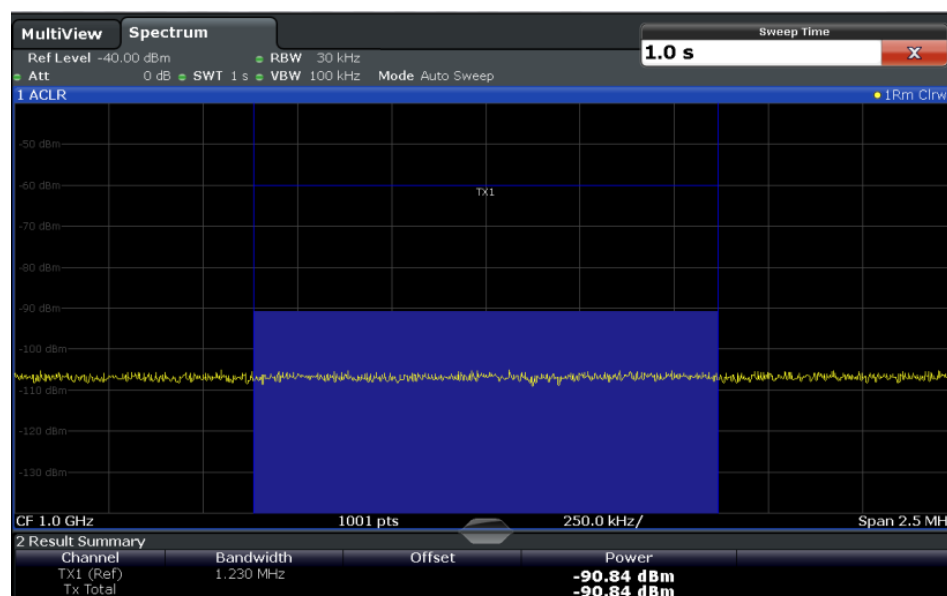

Figure 6-31: Measurement of the R&S FPS's intrinsic noise power in a 1.23 MHz channel bandwidth.

6.2.8 Optimizing and Troubleshooting the Measurement

If the results do not meet your expectations, or if you want to minimize the measurement duration, try the following methods to optimize the measurement:

- Only activate as many **adjacent channels** as necessary to minimize the required span and thus the required measurement time for the measurement.
- Increase the **RBW** to minimize the measurement time; however, consider the requirements of the standard if you need to measure according to standard! The automatic settings are always according to standard.
- Reduce the **"Sweep Time"** and thus the amount of data to be captured and calculated; however, consider the requirements regarding the standard deviation.
- To improve the **stability of the measured results**, increase the "Sweep Time" , which also leads to more averaging steps.
- Instead of **trace averaging**, use an RMS detector with a higher "Sweep Time" to obtain better average power results in less time.
- To determine a **channel power level** quickly, use the **Time Domain Power Measurement** (TDP) rather than a Channel Power measurement. The TDP measurement is a zero span measurement where the sweep time determines the measurement time. Due to the FFT measurement, duplicate averaging is performed, providing very stable results very quickly.
Note, however, that for TDP measurements, channel filters are not available and a fixed RBW is used. Thus, the measurement may not be according to standard for some test cases.

6.2.9 Reference: Predefined CP/ACLR Standards

When using predefined standards for ACLR measurement, the test parameters for the channel and adjacent-channel measurements are configured automatically.

You can select a predefined standard via the "CP / ACLR Standard" softkey in the "Ch Power" menu or the selection list in the "General Settings" tab of the "ACLR Setup" dialog box (see "[Standard](#)" on page 161).

Table 6-10: Predefined CP / ACLR standards with remote command parameters

Standard	Remote parameter
None	NONE
Multi-Standard Radio	MSR
EUTRA/LTE Square	EUTRa
EUTRA/LTE Square/RRC	REUTra
W-CDMA 3GPP FWD	FW3Gppcdma
W-CDMA 3GPP REV	RW3Gppcdma
CDMA IS95A FWD	F8CDma
CDMA IS95A REV	R8CDma
CDMA IS95C Class 0 FWD*)	FIS95c0

Channel Power and Adjacent-Channel Power (ACLR) Measurement

Standard	Remote parameter
CDMA IS95C Class 0 REV*)	RIS95c0
CDMA J-STD008 FWD	F19Cdma
CDMA J-STD008 REV	R19Cdma
CDMA IS95C Class 1 FWD*)	FIS95c1
CDMA IS95C Class 1 REV*)	RIS95c1
CDMA2000	S2CDma
TD-SCDMA FWD	FTCDma
TD-SCDMA REV	TRCDma
WLAN 802.11A	AWLAN
WLAN 802.11B	BWLAN
WIMAX	WIMax
WIBRO	WIBRo
GSM	GSM
RFID 14443	RFID14443
TETRA	TETRa
PDC	PDC
PHS	PHS
CDPD	CDPD
APCO-25 P2	PAPCo25
User Standard	USER
Customized Standard	<string>



For the R&S FPS, the channel spacing is defined as the distance between the center frequency of the adjacent channel and the center frequency of the transmission channel. The definition of the adjacent-channel spacing in standards IS95C and CDMA 2000 is different. These standards define the adjacent-channel spacing from the center of the transmission channel to the closest border of the adjacent channel. This definition is also used by the R&S FPS for the standards marked with an asterisk *).

6.2.10 Reference: Predefined ACLR User Standard XML Files

In addition to the predefined standards, some user standards with specific measurement settings for common ACLR measurements are provided in XML files on the instrument in the `C:\R_S\INSTR\acp_std` directory.

In particular, a sample file (`MSR_ACLRExample.xml`) is provided for an MSR ACLR measurement. It sets up the measurement for the MSR signal generator waveform

described in the file

C:\R_S\INSTR\USER\waveform\MSRA_GSM_WCDMA_LTE_GSM.wv.

Furthermore, the following XML files are provided:

LTE\DL

- LTE\DL\LTE_DL_5MHZ.XML
- LTE\DL\LTE_DL_10MHZ.XML
- LTE\DL\LTE_DL_15MHZ.XML
- LTE\DL\LTE_DL_20MHZ.XML

LTE\UL

- LTE\UL\LTE_UL_5MHZ.XML
- LTE\UL\LTE_UL_10MHZ.XML
- LTE\UL\LTE_UL_15MHZ.XML
- LTE\UL\LTE_UL_20MHZ.XML

WLAN

- WLAN\802_11ac\802_11ac_20MHZ.XML
- WLAN\802_11ac\802_11ac_40MHZ.XML
- WLAN\802_11ac\802_11ac_80MHZ.XML
- WLAN\802_11ac\802_11ac_160MHZ.XML



To load a stored measurement configuration, in the "General Settings" tab of the "ACLR Setup" dialog box, select the "Manage User Standards" button to display the "Manage" dialog box. Select the user standard file, then "Load" .

The stored settings are automatically set on the R&S FPS and the measurement is restarted with the new parameters.

For details, see [Chapter 6.2.6.4, "How to Manage User-Defined Configurations"](#), on page 187.

6.3 Carrier-to-Noise Measurements

Measures the carrier-to-noise ratio. C/No measurements normalize the ratio to a 1 Hz bandwidth.

- [About the Measurement](#)..... 194
- [Carrier-to-Noise Results](#)..... 195
- [Carrier-to-Noise Configuration](#)..... 196
- [How to Determine the Carrier-to-Noise Ratio](#)..... 197

6.3.1 About the Measurement

The largest signal in the frequency span is the carrier. It is searched when the C/N or C/N₀ function is activated and is marked using a fixed reference marker ("FXD").

To determine the noise power, a channel with a defined bandwidth at the defined center frequency is analyzed. The power within this channel is integrated to obtain the noise power level. (If the carrier is within this channel, an extra step is required to determine the correct noise power level, see below.)

The noise power of the channel is subtracted from the maximum carrier signal level, and in the case of a C/N_0 measurement, it is referred to a 1 Hz bandwidth.



For this measurement, the RMS detector is activated.

The carrier-to-noise measurements are only available in the frequency domain (span >0).

Measurement process

Depending on whether the carrier is inside or outside the analyzed channel, the measurement process for the carrier-to-noise ratio varies:

- The carrier is outside the analyzed channel: In this case, it is sufficient to switch on the desired measurement function and to set the channel bandwidth. The carrier/noise ratio is displayed on the screen.
- The carrier is inside the analyzed channel: In this case, the measurement must be performed in two steps:
 - First, perform the reference measurement by switching on either the C/N or the C/N_0 measurement and waiting for the end of the next measurement run. The fixed reference marker is set to the maximum of the measured carrier signal.
 - Then, switch off the carrier so that only the noise of the test setup is active in the channel. The carrier-to-noise ratio is displayed after the subsequent measurement has been completed.

Frequency Span

The frequency span should be set to approximately 4 times the channel bandwidth in order to measure the carrier-to-noise ratio correctly. This setting is defined automatically by the "Adjust Settings" function.

6.3.2 Carrier-to-Noise Results

As a result of the carrier-to-noise measurement the evaluated bandwidth and the calculated C/N ratio are displayed in the result window. The fixed reference marker is indicated in the diagram.

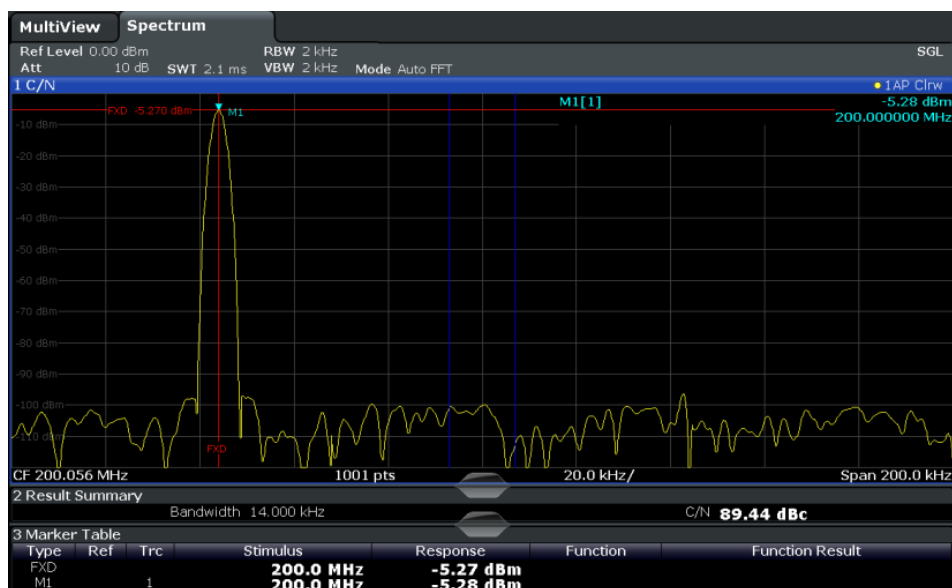

Remote command:

You can also query the determined carrier-to-noise ratio via the remote command `CALC:MARK:FUNC:POW:RES? CN` or `CALC:MARK:FUNC:POW:RES? CN0`, see [CALCulate<n>:MARKer<m>:FUNCTION:POWER<sb>:RESult?](#) on page 637.

6.3.3 Carrier-to-Noise Configuration

Access: "Overview" > "Select Measurement" > "C/N" / "C/N0" > "Carrier Noise Config"

Both a carrier-to-noise ratio (C/N) and a carrier-to-noise ratio in relation to the bandwidth (C/N₀) measurement are available.

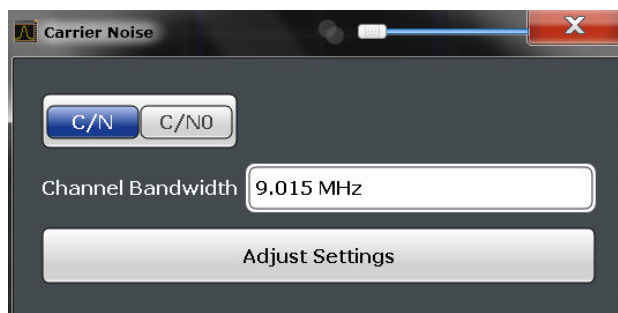

Carrier-to-noise measurements are not available in zero span mode.



The easiest way to configure a measurement is using the configuration "Overview", see [Chapter 7.1, "Configuration Overview"](#), on page 300.

The remote commands required to perform these tasks are described in [Chapter 12.5.4, "Measuring the Carrier-to-Noise Ratio"](#), on page 677.

C/N	197
C/NO	197
Channel Bandwidth	197
Adjust Settings	197

C/N

Switches the measurement of the carrier/noise ratio on or off. If no marker is active, marker 1 is activated.

The measurement is performed on the trace that marker 1 is assigned to. To shift marker 1 and measure another trace, use the "Marker To Trace" softkey in the "Marker" menu (see "Assigning the Marker to a Trace" on page 410).

Remote command:

`CALCulate<n>:MARKer<m>:FUNCTION:POWER:SElect` on page 639

`CALCulate<n>:MARKer<m>:FUNCTION:POWER<sb>:RESult?` on page 637

`CALCulate<n>:MARKer<m>:FUNCTION:POWER[:STATe]` on page 639

C/NO

Switches the measurement of the carrier/noise ratio with reference to a 1 Hz bandwidth on or off. If no marker is active, marker 1 is activated.

The measurement is performed on the trace that marker 1 is assigned to. To shift marker 1 and measure another trace, use the "Marker To Trace" softkey in the "Marker" menu (see "Assigning the Marker to a Trace" on page 410).

Remote command:

`CALCulate<n>:MARKer<m>:FUNCTION:POWER:SElect` on page 639

`CALCulate<n>:MARKer<m>:FUNCTION:POWER<sb>:RESult?` on page 637

`CALCulate<n>:MARKer<m>:FUNCTION:POWER[:STATe]` on page 639

Channel Bandwidth

Defines the channel bandwidth.

The default setting is 14 kHz.

Remote command:

`[SENSe:] POWER:ACHannel: BANDwidth[:CHANnel<ch>]` on page 644

Adjust Settings

Enables the RMS detector and adjusts the span to the selected channel bandwidth according to:

"4 x channel bandwidth + measurement margin"

The adjustment is performed once; if necessary, the setting can be changed later on.

Remote command:

`[SENSe:] POWER:ACHannel:PRESet` on page 640

6.3.4 How to Determine the Carrier-to-Noise Ratio

The following step-by-step instructions demonstrate how to determine the carrier-to-noise ratio.



For remote operation, see "[Programming example: Measuring the carrier-to-noise ratio](#)" on page 677.

1. Press the "C/N" , "C/N0" softkey to configure the carrier-to-noise ratio measurement.
2. To change the channel bandwidth to be analyzed, press the "Channel Bandwidth" softkey.
3. To optimize the settings for the selected channel configuration, press the "Adjust Settings" softkey.
4. To activate the measurements without reference to the bandwidth, press the "C/N" softkey.
To activate the measurements with reference to the bandwidth, press the "C/N₀" softkey .
5. If the carrier signal is located within the analyzed channel bandwidth, switch off the carrier signal so that only the noise is displayed in the channel and perform a second measurement.

The carrier-to-noise ratio is displayed after the measurement has been completed.

6.4 Occupied Bandwidth Measurement (OBW)

An important characteristic of a modulated signal is its occupied bandwidth, that is: the bandwidth which must contain a defined percentage of the power. In a radio communications system, for instance, the occupied bandwidth must be limited to enable distortion-free transmission in adjacent channels.

- [About the Measurement](#).....198
- [OBW Results](#).....200
- [OBW Configuration](#).....201
- [How to Determine the Occupied Bandwidth](#).....203
- [Measurement Example](#).....204

6.4.1 About the Measurement

The occupied bandwidth is defined as the bandwidth containing a defined percentage of the total transmitted power. A percentage between 10 % and 99.9 % can be set.

Measurement principle

The bandwidth containing 99% of the signal power is to be determined, for example. The algorithm first calculates the total power of all displayed points of the trace. In the next step, the points from the right edge of the trace are summed up until 0.5 % of the total power is reached. Auxiliary marker 1 is positioned at the corresponding frequency. Then the points from the left edge of the trace are summed up until 0.5 % of the power

is reached. Auxiliary marker 2 is positioned at this point. 99 % of the power is now between the two markers. The distance between the two frequency markers is the occupied bandwidth which is displayed in the marker field.



OBW within defined search limits - multicarrier OBW measurement in one sweep

The occupied bandwidth of the signal can also be determined within defined search limits instead of for the entire signal. Thus, only a single sweep is required to determine the OBW for a multicarrier signal. To do so, search limits are defined for an individual carrier and the OBW measurement is restricted to the frequency range contained within those limits. Then the search limits are adapted for the next carrier and the OBW is automatically recalculated for the new range.

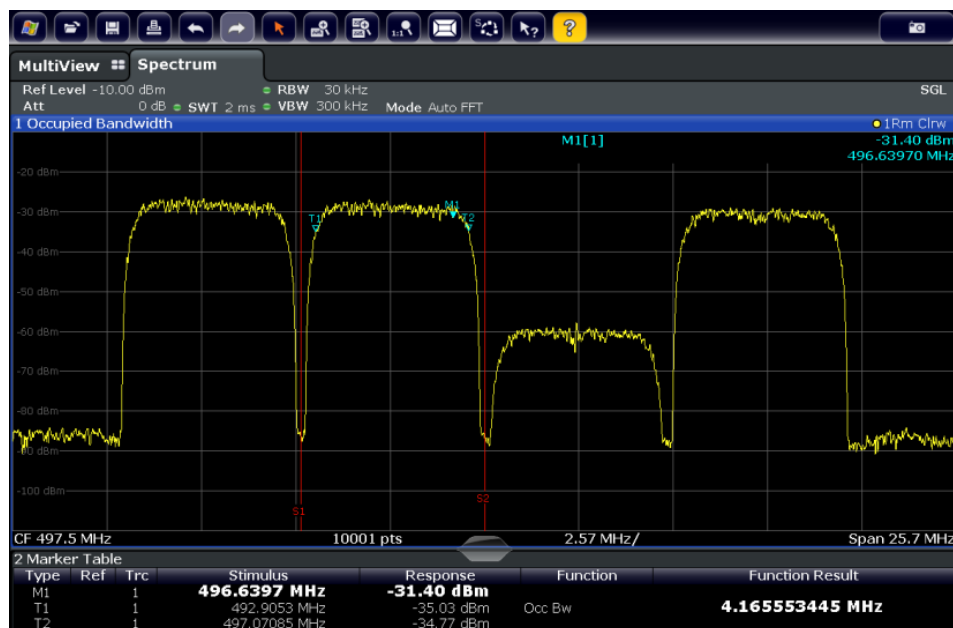

For step-by-step instructions, see ["How to determine the OBW for a multicarrier signal using search limits"](#) on page 203.

Prerequisites

To ensure correct power measurement, especially for noise signals, and to obtain the correct occupied bandwidth, the following prerequisites and settings are necessary:

- Only the signal to be measured is displayed in the window, or search limits are defined to include only one (carrier) signal. An additional signal would falsify the measurement.
- $RBW \ll$ occupied bandwidth (approx. 1/20 of occupied bandwidth, for voice communication type: 300 Hz or 1 kHz)
- $VBW \geq 3 \times RBW$
- RMS detector
- $Span \geq 2$ to 3 x occupied bandwidth

Occupied Bandwidth Measurement (OBW)

Some of the measurement specifications (e.g. PDC, RCR STD-27B) require measurement of the occupied bandwidth using a peak detector. The detector setting of the R&S FPS has to be changed accordingly then.

6.4.2 OBW Results

As a result of the OBW measurement the occupied bandwidth ("Occ Bw") is indicated in the marker results. Furthermore, the marker at the center frequency and the temporary markers are indicated.

The measurement is performed on the trace with marker 1. In order to evaluate another trace, marker 1 must be placed on another trace (see [Assigning the Marker to a Trace](#)).



The OBW calculation is repeated if the [Search Limits](#) are changed, without performing a new sweep. Thus, the OBW for a multicarrier signal can be determined using only one sweep.

Centroid frequency

The centroid frequency is defined as the point in the center of the occupied bandwidth, calculated using the temporary OBW markers T1 and T2. This frequency is indicated as a function result ("Occ Bw Centroid") in the marker table.

Frequency offset

The offset of the calculated centroid frequency to the defined center frequency of the R&S FPS is indicated as a function result ("Occ Bw Freq Offset") in the marker table.

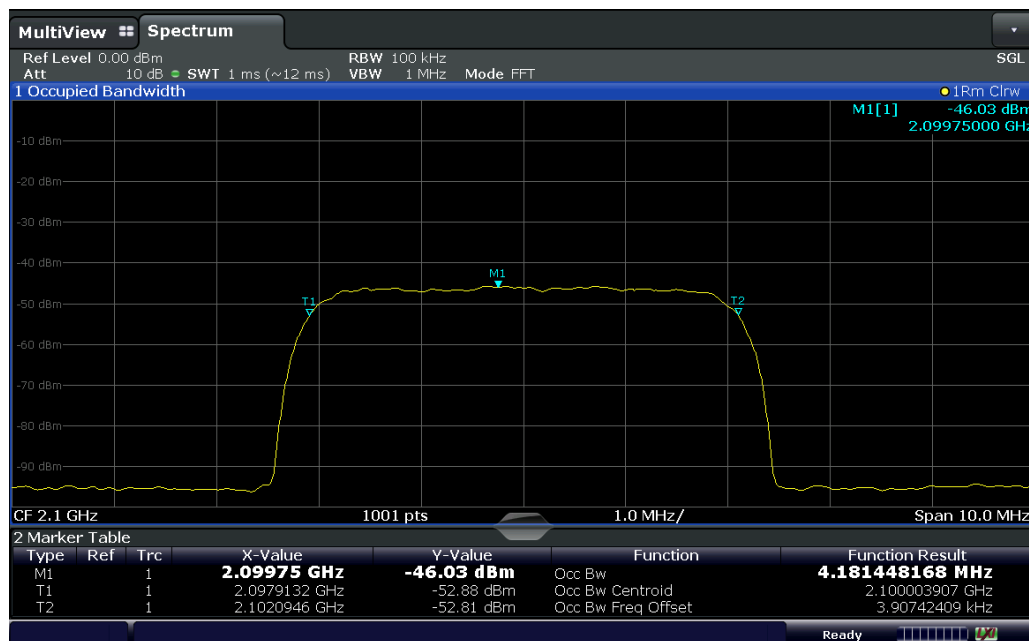

Remote command:

The determined occupied bandwidth can also be queried using the remote command `CALC:MARK:FUNC:POW:RES? OBW` or `CALC:MARK:FUNC:POW:RES? AOBW`. While the `OBW` parameter returns only the occupied bandwidth, the `AOBW` parameter also returns the position and level of the temporary markers T1 and T2 used to calculate the occupied bandwidth.

`CALC:MARK:FUNC:POW:SEL OBW`, see [CALCulate<n>:MARKer<m>:FUNction:POWer:SElect](#) on page 639

[CALCulate<n>:MARKer<m>:FUNction:POWer\[:STATe\]](#) on page 639

`CALC:MARK:FUNC:POW:RES? OBW`, see [CALCulate<n>:MARKer<m>:FUNction:POWer<sb>:RESult?](#) on page 637

`CALC:MARK:FUNC:POW:RES? COBW`, see [CALCulate<n>:MARKer<m>:FUNction:POWer<sb>:RESult?](#) on page 637

6.4.3 OBW Configuration

Access: "Overview" > "Select Measurement" > "OBW" > "OBW Config"

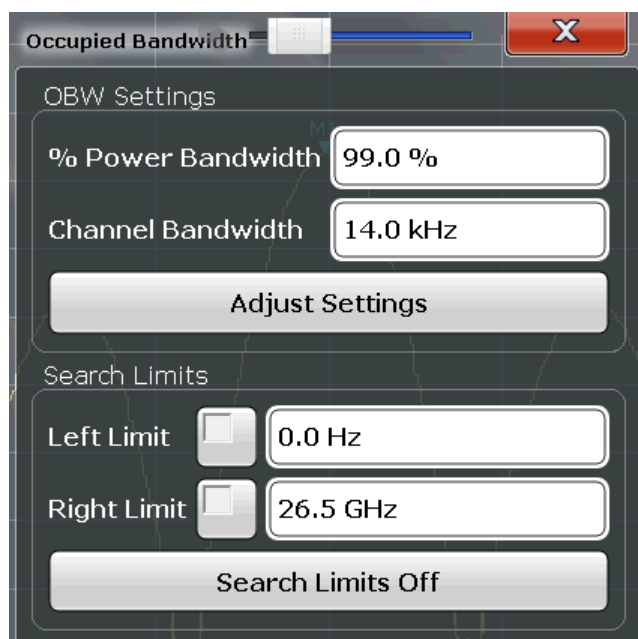

This measurement is not available in zero span.

**Configuring search limits for OBW measurement**

The OBW measurement uses the same search limits as defined for marker search (see "[Search Limits](#)" on page 415). However, only the left and right limits are considered.

The remote commands required to perform these tasks are described in [Chapter 12.5.5, "Measuring the Occupied Bandwidth"](#), on page 678.

% Power Bandwidth	202
Channel Bandwidth	202
Adjust Settings	202
Search Limits (Left / Right)	202
Deactivating All Search Limits	203

% Power Bandwidth

Defines the percentage of total power in the displayed frequency range which defines the occupied bandwidth. Values from 10 % to 99.9 % are allowed.

Remote command:

`[SENSe:]POWER:BANDwidth` on page 679

Channel Bandwidth

Defines the channel bandwidth for the transmission channel in single-carrier measurements. This bandwidth is used to optimize the test parameters (for details see "[Adjust Settings](#)" on page 202). The default setting is 14 kHz.

For measurements according to a specific transmission standard, define the bandwidth specified by the standard for the transmission channel.

For multicarrier measurements, this setting is irrelevant.

Remote command:

`[SENSe:]POWER:ACHannel:BANDwidth[:CHANnel<ch>]` on page 644

Adjust Settings

Optimizes the instrument settings for the measurement of the occupied bandwidth according to the specified channel bandwidth.

This function is only useful for single carrier measurements.

All instrument settings relevant for power measurement within a specific frequency range are optimized:

- Frequency span: $3 \times$ channel bandwidth
- RBW $\leq 1/40$ of channel bandwidth
- VBW $\geq 3 \times$ RBW
- Detector: RMS

The reference level is not affected by "Adjust Settings". For an optimum dynamic range, select the reference level such that the signal maximum is close to the reference level.

(See "[Setting the Reference Level Automatically \(Auto Level \)](#)" on page 356).

The adjustment is carried out only once. If necessary, the instrument settings can be changed later.

Remote command:

`[SENSe:]POWER:ACHannel:PRESet` on page 640

Search Limits (Left / Right)

If activated, limit lines are defined and displayed for the search. Only results within the limited search range are considered.

For details on limit lines for searches, see ["Peak search limits"](#) on page 434.

Remote command:

[CALCulate<n>:MARKer<m>:X:SLIMits\[:STATe\]](#) on page 870

[CALCulate<n>:MARKer<m>:X:SLIMits:LEFT](#) on page 871

[CALCulate<n>:MARKer<m>:X:SLIMits:RIGHT](#) on page 871

Deactivating All Search Limits

Deactivates the search range limits.

Remote command:

[CALCulate<n>:MARKer<m>:X:SLIMits\[:STATe\]](#) on page 870

[CALCulate<n>:THReshold:STATe](#) on page 873

6.4.4 How to Determine the Occupied Bandwidth

The following step-by-step instructions demonstrate how to determine the occupied bandwidth.



For remote operation, see [Chapter 12.5.5.2, "Programming Example: OBW Measurement"](#), on page 679.

How to determine the OBW for a single signal

1. Press the MEAS key or select "Select Measurement" in the "Overview" .
2. Select the "OBW" measurement function.
The measurement is started immediately with the default settings.
3. Select the "OBW Config" softkey.
The "Occupied Bandwidth" configuration dialog box is displayed.
4. Define the percentage of power ("% Power Bandwidth") that defines the bandwidth to be determined.
5. If necessary, change the channel bandwidth for the transmission channel.
6. To optimize the settings for the selected channel configuration, select "Adjust Settings" .
7. Start a sweep.
The result is displayed as OBW in the marker results.

How to determine the OBW for a multicarrier signal using search limits

1. Press the MEAS key or select "Select Measurement" in the "Overview" .
2. Select the "OBW" measurement function.
3. Select the "OBW Config" softkey.

4. Define the percentage of power ("% Power Bandwidth") that defines the bandwidth to be determined.
5. Define search limits so the search area contains only the first carrier signal:
 - a) Enter values for the left or right limits, or both.
 - b) Enable the use of the required limits.
6. Start a sweep.

The result for the first carrier is displayed as OBW in the marker results.
7. Change the search limits so the search area contains the next carrier signal as described in [step 5](#).

The OBW is recalculated and the result for the next carrier is displayed. A new sweep is not necessary!
8. Continue in this way until all carriers have been measured.

6.4.5 Measurement Example

In the following example, the bandwidth that occupies 99 % of the total power of a PDC signal at 800 MHz, level 0 dBm is measured.



A programming example demonstrating an OBW measurement in a remote environment is provided in [Chapter 12.5.6.11, "Example: SEM Measurement"](#), on page 712.

1. Preset the R&S FPS.
2. Set the "Center Frequency" to *800 MHz*.
3. Set the "Reference Level" to *-10 dBm*.
4. Press the MEAS key or select "Select Measurement" in the "Overview" .
5. Select the "OBW" measurement function.
6. Select the "OBW Config" softkey.
7. Set the "% Power Bandwidth" to *99 %*.
8. Set the "Channel Bandwidth" to *21 kHz* as specified by the PDC standard.
9. Optimize the settings for the selected channel configuration by selecting "Adjust Settings" .
10. Adjust the reference level to the measured total power by selecting "Auto Level" in the AUTO SET menu.
11. The PDC standard requires the peak detector for OBW measurement. In the "Traces" configuration dialog, set the trace detector to "PositivePeak" .

12. Start a sweep.

The result is displayed as OBW in the marker results.

6.5 Spectrum Emission Mask (SEM) Measurement

Spectrum Emission Mask (SEM) measurements monitor compliance with a spectral mask.

• About the Measurement	205
• Typical Applications	205
• SEM Results	206
• SEM Basics	209
• SEM Configuration	219
• How to Perform a Spectrum Emission Mask Measurement	235
• Measurement Example: Multi-SEM Measurement	240
• Reference: SEM File Descriptions	241

6.5.1 About the Measurement

The Spectrum Emission Mask (SEM) measurement defines a measurement that monitors compliance with a spectral mask. The mask is defined with reference to the input signal power. The R&S FPS allows for a flexible definition of all parameters in the SEM measurement. The analyzer performs measurements in predefined frequency ranges with settings that can be specified individually for each of these ranges.

In the basic Spectrum application, spectrum emissions can be measured for multiple sub blocks of channels, where the sub blocks can include gaps or overlap, and define separate masks. Radio signals using multiple standards can also be analyzed.

SEM measurement configurations can be saved to an XML file which can then be exported to another application or loaded on the R&S FPS again later. Some predefined XML files are provided that contain ranges and parameters according to the selected standard.

To improve the performance of the R&S FPS for spectrum emission mask measurements, a "Fast SEM" mode is available.

A special limit check for SEM measurements allows for monitoring compliance of the spectrum.

6.5.2 Typical Applications

Spectrum Emission Mask measurements are typically performed to ensure that modulated signals remain within the valid signal level ranges. These ranges are defined by a particular transmission standard, both in the transmission channel and neighboring channels. Any violations of the mask can interfere with other transmissions.

The 3GPP TS 34.122 standard, for example, defines a mask for emissions outside the transmission channel. This mask is defined relative to the input signal power. Three frequency ranges to each side of the transmission channel are defined.

6.5.3 SEM Results

As a result of the Spectrum Emission Mask measurement, the following results are displayed in a diagram (see also [Chapter 6.5.4.2, "Limit Lines in SEM Measurements"](#), on page 211):

- The measured signal levels
- The result of the limit check (mask monitoring)
- The defined limit lines
- TX channel power "P"
- The used power class



Multi-SEM measurements

Multi-SEM measurements are SEM measurements with more than one sub block. In these measurements, each sub block has its own power class definitions. In this case, the power class is not indicated in the graphical result displays.

Example:

For example, in [Figure 6-32](#), "31 < P < 39" is indicated as the used power class is defined from 31 to 39.

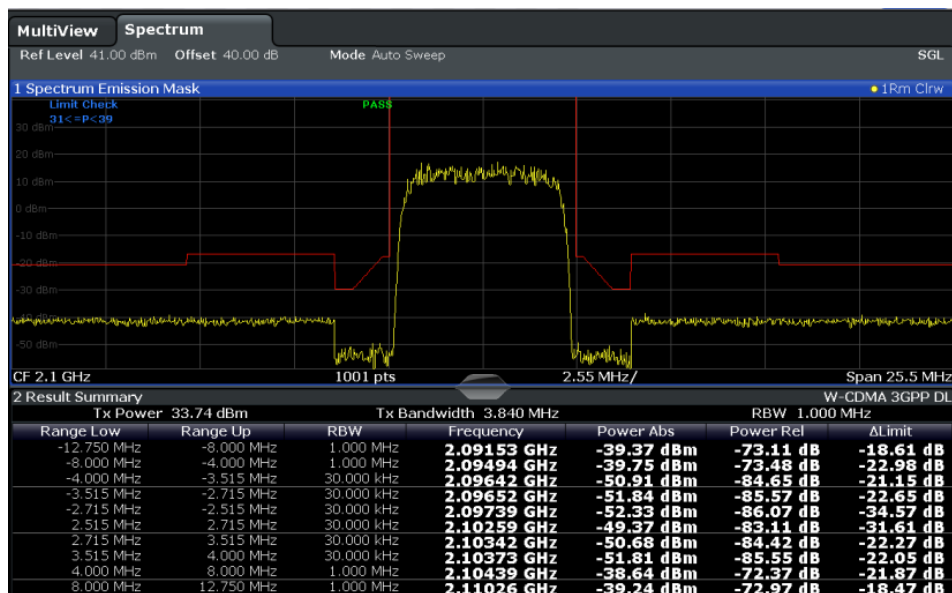

Figure 6-32: Spectrum Emission Mask result displays

In addition to the graphical results of the SEM measurement displayed in the diagram, a result summary is displayed to evaluate the limit check results (see also [Chapter 6.5.4.2, "Limit Lines in SEM Measurements"](#), on page 211).

The following information is provided in the result summary:

Label	Description
General information	
"Standard"	Loaded standard settings
"Tx Power"	Power of the reference range
"Tx Bandwidth"	Tx bandwidth used by the reference range
"RBW"	RBW used by the reference range
Range results	
"Range Low"	Start of the frequency range the peak value was found in
"Range Up"	Frequency range end the peak value was found in
"RBW"	RBW of the range
"Frequency"	Frequency of the peak power level
"Power Abs"	Absolute peak power level within the range
"Power Rel"	Peak power level within the range, relative to the "Tx Power"
"ΔLimit"	Deviation of the peak power level from the limit line

You can define in which detail the data is displayed in the result summary in the "List Evaluation" settings (see [Chapter 6.5.5.7, "List Evaluation \(Results Configuration\)"](#), on page 234). By default, one peak per range is displayed. However, you can change the settings to display only peaks that exceed a threshold ("Margin").

Detected peaks are not only listed in the Result Summary, they are also indicated by blue squares in the diagram (optionally, see [Show Peaks](#) in the "List Evaluation" settings).

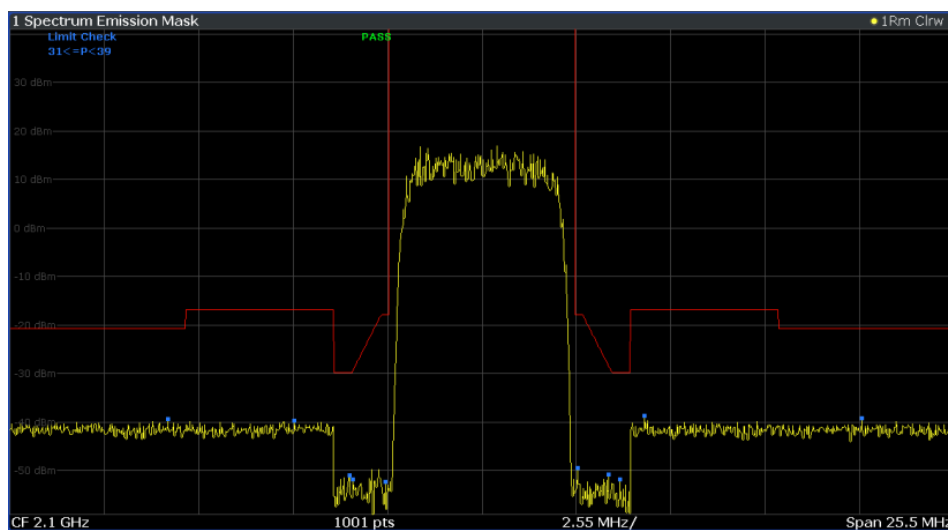

Figure 6-33: Detected peak display in SEM measurement

Furthermore, you can export the results of the result summary to a file which can be exported to another application for further analysis.

Results for SEM with multiple sub blocks

In the Spectrum application only, spectrum emissions can be measured for multiple sub blocks of channels (see [Chapter 6.5.4.5, "SEM with Multiple Sub Blocks \("Multi-SEM"\)](#)", on page 215 for details). Up to three sub blocks (with two gaps) can be defined. For each sub block and each gap, the results described above are provided individually in the result summary.

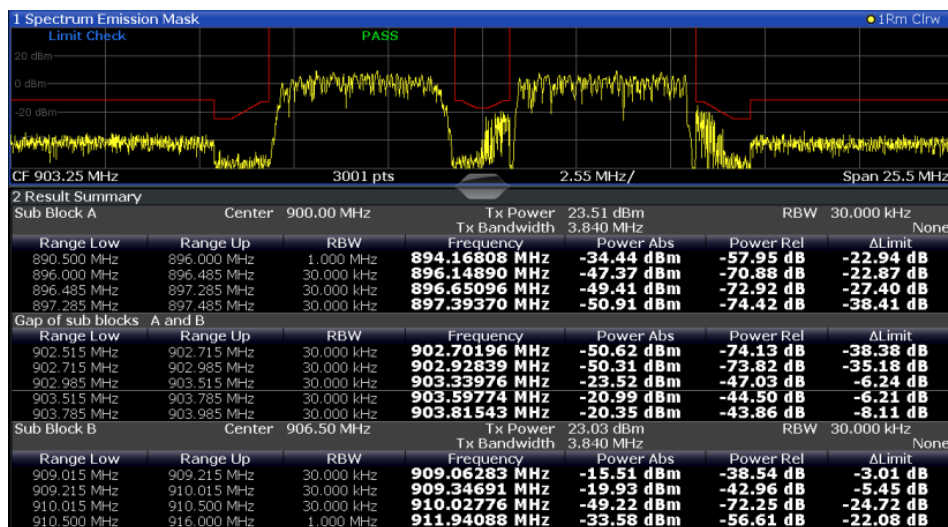

Figure 6-34: SEM results for multiple sub blocks

Retrieving results via remote control

The measurement results of the spectrum emission mask *test* can be retrieved using the `CALC:LIM:FAIL?` command from a remote computer; see `CALCulate<n>:LIMit<k>:FAIL?` on page 932 for a detailed description.

The *power* result for the reference range can be queried using `CALC:MARK:FUNC:POW:RES? CPOW`;

The *peak* power for the reference range can be queried using `CALC:MARK:FUNC:POW:RES? PPOW`, see `CALCulate<n>:MARKer<m>:FUNCTION:POWER<sb>:RESULT?` on page 637.

The measured power *trace* can be queried using `TRAC:DATA?` and `TRAC:DATA:X?`, see `TRACe<n>[:DATA]` on page 854 and `TRACe<n>[:DATA]:X?` on page 856:

The measured *peak power list* can be queried using `TRAC:DATA? LIST`, see `TRACe<n>[:DATA]` on page 854.

6.5.4 SEM Basics

Some background knowledge on basic terms and principles used in SEM measurements is provided here for a better understanding of the required configuration settings.

- [Ranges and Range Settings](#)..... 209
- [Limit Lines in SEM Measurements](#).....211
- [Fast SEM Measurements](#).....213
- [Multi-Standard Radio \(MSR\) SEM Measurements](#)..... 215
- [SEM with Multiple Sub Blocks \("Multi-SEM"\)](#)..... 215

6.5.4.1 Ranges and Range Settings

In the Spectrum Emission Mask measurements, a range defines a segment for which you can define the following parameters separately:

- Start and stop frequency
- RBW
- VBW
- "Sweep Time"
- "Sweep Points"
- Reference level
- Attenuator settings
- Preamplifier settings
- Transducer settings
- Limit values

Via the sweep list, you define the ranges and their settings. For details on settings, refer to [Chapter 6.5.5.1, "Sweep List"](#), on page 220.

For details on defining the limits (masks), see [Chapter 6.5.4.2, "Limit Lines in SEM Measurements"](#), on page 211.

For details on defining the limits (masks), see the base unit description "Working with Lines in SEM".

Range definition

After a preset, the sweep list contains a set of default ranges and parameters. For each range, you can change the parameters listed above. You can insert or delete ranges.

The changes of the sweep list are only kept until you load another parameter set (by pressing PRESET or by loading an XML file). If you want a parameter set to be available permanently, create an XML file for this configuration (for details refer to ["How to save a user-defined SEM settings file"](#) on page 239).

If you load one of the provided XML files, the sweep list contains ranges and parameters according to the selected standard.

Reference range

The range containing the center frequency is defined as the reference range for all other ranges in the sweep list. All range limits are defined in relation to the reference range. The TX power used as a reference for all power level results in the result summary is also calculated for this reference range. You can define whether the power used for reference is the peak power level or the integrated power of the reference range. In the "Sweep List", the reference range is highlighted in blue and cannot be deleted.

Rules

The following rules apply to ranges:

- The minimum span of a range is 20 Hz.
- The individual ranges must not overlap (but can have gaps).
- The maximum number of ranges is 30.
- The minimum number of ranges is 3.
- The reference range cannot be deleted.
- Center the reference range on the center frequency.
- The current "Tx Bandwidth" defines the minimum span of the reference range (see ["Channel Power Settings"](#) on page 227).
- Define frequency values for each range relative to the center frequency.

To change the start frequency of the first range or the stop frequency of the last range, select the appropriate span with the SPAN key. You can define a span that is smaller than the combined span of all ranges. In this case, the measurement includes only the ranges that lie within the defined span and have a minimum span of 20 Hz. The first and last ranges are adapted to the given span as long as the minimum span of 20 Hz is not violated.

Sweep points

You can define a minimum number of sweep points for each range. The total number of available sweep points is then distributed among the ranges in consideration of the minimum values. If the total number of sweep points is not enough to satisfy the minimum sweep point requirements in all ranges, the R&S FPS adjusts the global number of [Sweep Points](#) accordingly. By default, each range has a minimum of one sweep point.

This allows you to increase the resolution within a specific range for detailed analysis. You do not have to increase the overall number of sweep points and thus the measurement time for the SEM measurement.

Symmetrical ranges

You can easily define a sweep list with symmetrical range settings, i.e. the ranges to the left and right of the reference range are defined symmetrically. When symmetrical setup is activated, the current sweep list configuration is changed to define a symmetrical setup regarding the reference range. The number of ranges to the left of the reference range is reflected to the right, i.e. any missing ranges on the right are inserted, while superfluous ranges are removed. The values in the ranges to the right of the reference range are adapted symmetrically to those in the left ranges.

Symmetrical ranges fulfill the conditions required for "Fast SEM" mode (see [Chapter 6.5.4.3, "Fast SEM Measurements"](#), on page 213).

Power classes

If the signal power level to be monitored varies and the limits vary accordingly, you can define power classes, which can then be assigned to the frequency ranges. Thus, the limits for the signal levels can be defined differently for varying input levels. For instance, for higher input levels a transmission standard can allow for higher power levels in adjacent channels, whereas for lower input levels the allowed deviation can be stricter. Up to four different power classes can be defined.

6.5.4.2 Limit Lines in SEM Measurements

For the R&S FPS, the spectrum emission mask is defined using limit lines. Limit lines allow you to check the measured data (that is, the trace results) against specified limit values. Generally, it is possible to define limit lines for any measurement in the Spectrum application application using the LINES function. For SEM measurements, however, special limit lines are available via the "Sweep List", and it is strongly recommended that you use only these limit line definitions.

In the "Sweep List", you can define a limit line for each power class that varies its level according to the specified frequency ranges. Special limit lines are automatically defined for each power class according to the current "Sweep List" settings every time the settings change. These limit lines are labeled "_SEM_LINE_<xxx>_ABS<0...3>" and "_SEM_LINE_<xxx>_REL<0...3>", where <xxx> is an index to distinguish limit lines between different channels.

The limit line defined for the currently used power class is indicated by a red line in the display. The result of the limit check is indicated at the top of the diagram. Note that

Spectrum Emission Mask (SEM) Measurement

only "Pass" or "Fail" is indicated; a "Margin" function as for general limit lines is not available.

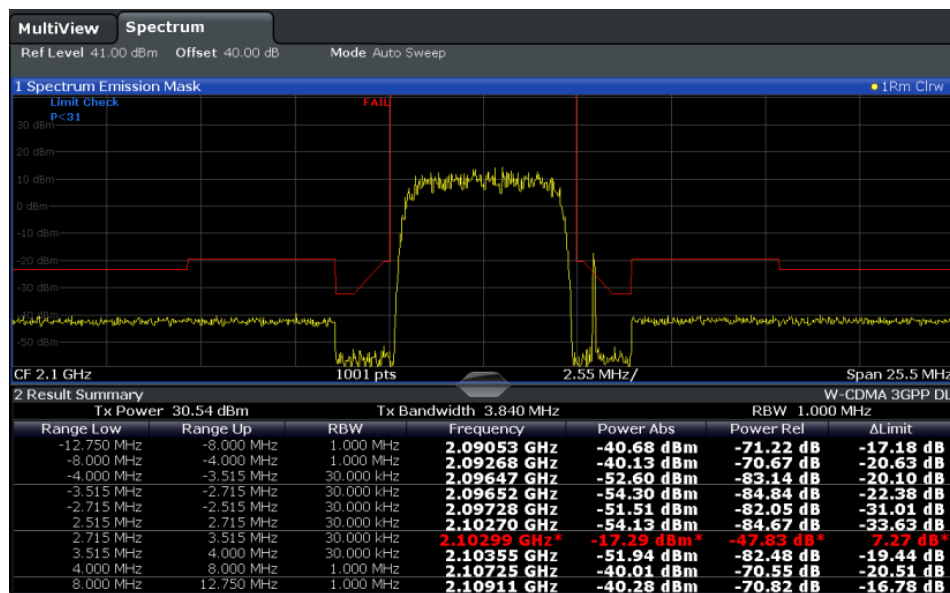

The indicated limit line depends on the settings in the "Sweep List" . Several types of limit checks are possible:

Table 6-11: Limit check types

Limit check type	Pass/fail criteria	Limit line definition
"Absolute"	Absolute power levels must not exceed limit line	Defined by the "Abs Limit Start" / "Abs Limit Stop" values for each range
"Relative"	Power deviations relative to the TX channel power must not exceed limit line	Defined by the "Rel Limit Start" / "Rel Limit Stop" values (relative to the TX channel power), fixed for each range.
"Relative with function f(x)"	If the power exceeds both the absolute and the relative limits, the check fails (see Relative limit line functions below)	Defined by the maximum of the absolute or relative start and stop limit values for each range. Thus, the start or stop point of the limit range, or both, are variable (since the maximum can vary).
"Abs and Rel"	If the power exceeds both the absolute and the relative limits, the check fails.	The less strict (higher) limit line is displayed for each range. If you use a function to define the relative limit start or stop value, the signal is checked against an additional condition: the power must exceed the absolute limit, as well as the absolute and relative function values.
"Abs or Rel"	If the power exceeds either the absolute or the relative limits, the check fails.	The stricter (lower) limit line is displayed for each range. If you use a function to define the relative limit start or stop value, the signal is checked against an additional condition: if the power exceeds the absolute limit, or the higher of the absolute and relative function values, the check fails.

Relative limit line functions

A new function allows you to define limit lines whose start or end points (or both) are variable, depending on the carrier power. Thus, the resulting limit line can change its slope within the range, depending on the carrier power. Common relative limit lines are calculated once for the defined start and end points and maintain a constant slope.

If the relative limit value function is used in combination with the "Abs and Rel" or "Abs or Rel" limit check types, an additional condition is considered for the limit check (see [Table 6-11](#)).

Limit check results in the result summary

For each range, the peak measured value and the deviation of these values from the limit line are displayed in the result summary. If the limit check is passed for the range, the deviation represents the closest value to the limit line. If the limit check is passed for the range, the deviation represents the closest value to the limit line. If the limit check for the range fails, the deviation represents the maximum violation against the limit line. Furthermore, the absolute power levels and the relative deviation of the peaks from the TX channel power are displayed. Values that exceed the limit are indicated in red and by an asterisk (*).

A2 Spectrum Emission Mask				W-CDMA 3GPP (31,39)dBm DL		
Tx Power: -28.10 dBm		Tx Bandwidth: 3.840 MHz		RBW: 1.000 MHz		
Range Low	Range Up	RBW	Frequency	Power Abs	Power Rel	ΔLimit
-12.750 MHz	-8.000 MHz	1.000 MHz	13.24173 GHz*	-47.08 dBm*	-18.98 dB*	38.52 dB*
-8.000 MHz	-4.000 MHz	1.000 MHz	13.24364 GHz*	-25.01 dBm*	3.08 dB*	53.59 dB*
-4.000 MHz	-3.515 MHz	30.000 kHz	13.24619 GHz	-100.18 dBm	-72.08 dB	-8.58 dB
-3.515 MHz	-2.715 MHz	30.000 kHz	13.24668 GHz	-105.92 dBm	-77.83 dB	-17.23 dB



Although a margin functionality is not available for the limit check, a margin (threshold) for the peak values to be displayed in the Result Summary can be defined. (In the "List Evaluation" settings, see [Chapter 6.5.5.7, "List Evaluation \(Results Configuration\)"](#), on page 234).

6.5.4.3 Fast SEM Measurements

To improve the performance of the R&S FPS for spectrum emission mask measurements, a "Fast SEM" mode is available. If this mode is activated, several consecutive ranges with identical sweep settings are combined to one sweep internally, which makes the measurement considerably faster. The displayed results remain unchanged and still consist of several ranges. Thus, measurement settings that apply only to the results, such as limits, can nevertheless be defined individually for each range.

Prerequisites

"Fast SEM" mode is available if the following criteria apply:

- The frequency ranges are consecutive, without frequency gaps
- The following sweep settings are identical (for details see [Chapter 6.5.5.1, "Sweep List"](#), on page 220):
 - "Filter Type"
 - "RBW"
 - "VBW"

- "Sweep Time Mode"
- "Reference Level"
- "RF Attenuation Mode"
- "RF Attenuation"
- "Preamplifier"

Activating Fast SEM mode

"Fast SEM" mode is activated in the sweep list (see [Chapter 6.5.5.1, "Sweep List"](#), on page 220) or using a remote command. Activating the mode for one range automatically activates it for all ranges in the sweep list.

Remote command:

[SENSe:]ESpectrum<sb>:HighSPeed on page 684



Fast SEM not supported for multiple sub blocks

For SEM with multiple sub blocks, fast SEM is not available. If more than one sub block is defined and a standard is loaded which contains an active fast SEM setting, this setting is disabled.

For more information on multi-SEM measurements, see [Chapter 6.5.4.5, "SEM with Multiple Sub Blocks \("Multi-SEM"\)"](#), on page 215.

Consequences

When the "Fast SEM" mode is activated, the ranges for which these criteria apply are displayed as one single range. The sweep time is defined as the sum of the individual sweep times, initially, but can be changed.



If "Symmetrical Setup" mode is active when "Fast SEM" mode is activated, not all sweep list settings can be configured symmetrically automatically (see also "[Symmetrical Setup](#)" on page 225).

Any other changes to the sweep settings of the combined range are applied to each included range and remain changed even after deactivating "Fast SEM" mode.

Example

Sweep List	Reference Range	Power Classes	Standard Files		
	Range 1	Range 2	Range 3	Range 4	Range 5
Range Start	-13.25 GHz	-12.75 MHz	-2.515 MHz	2.515 MHz	12.75 MHz
Range Stop	-12.75 MHz	-2.515 MHz	2.515 MHz	12.75 MHz	13.25 GHz
Fast SEM	On	On	On	On	On
Filter Type	Normal(3...	---	Channel	---	---
Res BW	3 MHz	---	30 kHz	---	---
Video BW	3 MHz	---	3 MHz	---	---
Sweep Time Mode	---	---	---	---	---
Sweep Time	27.5 ms	---	37.5 ms	---	---
Ref. Level	0 dBm	---	0 dBm	---	---
RF Att. Mode	Auto	---	Auto	---	---
RF Attenuator	10 dB	---	10 dB	---	---
Transducer	None	None	None	None	None
Limit Check 1	Relative	Relative	Relative	Relative	Relative
Abs Limit Start 1	-13 dBm	-13 dBm	-13 dBm	-13 dBm	-13 dBm
Abs Limit Stop 1	-13 dBm	-13 dBm	-13 dBm	-13 dBm	-13 dBm
Rel Limit Start 1	-50 dBc	-50 dBc	300 dBc	-50 dBc	-50 dBc
Rel Limit Stop 1	-50 dBc	-50 dBc	300 dBc	-50 dBc	-50 dBc

Figure 6-35: Sweep list using Fast SEM mode

In Figure 6-35, a sweep list is shown for which Fast SEM is activated. The formerly five separately defined ranges are combined to two sweep ranges internally.

6.5.4.4 Multi-Standard Radio (MSR) SEM Measurements

Multi-standard radio (MSR) measurements allow you to perform SEM tests on signals with multiple carriers using different digital standards. MSR measurements are described in the specification 3GPP TS 37.141. Various typical combinations of standards for base station tests are described, e.g. LTE FDD and W-CDMA carriers. By performing an MSR SEM measurement you can determine if or how the different carriers affect each other, i.e. if unwanted emissions occur. On the R&S FPS, the MSR SEM measurement is a standard measurement as for single carriers. The MSR settings merely provide a convenient way of configuring the sweep list for all required ranges according to the specification quickly.

Refined settings allow the R&S FPS to calculate the SEM limits according to standard 3GPP 37.141 V12.2.0, which distinguishes between base station configurations and power values.

6.5.4.5 SEM with Multiple Sub Blocks ("Multi-SEM")

In the Spectrum application application only, spectrum emissions can be measured for multiple sub blocks of channels (also referred to as a "Multi-SEM" measurement). Sub blocks are a set of multiple ranges around a defined center frequency (carrier). Multiple sub blocks can include gaps or overlap, and each sub block defines a separate mask. In the overlapping masks, multi-limit lines are calculated. Up to three sub blocks (with

two gaps) can be defined. For each sub block, the familiar configuration settings concerning ranges, limit lines etc. can be defined individually.

Comparison to "traditional" SEM measurement

The default SEM measurement is simply a special case of "*Multi-SEM*" - consisting of one single block. Only if the number of sub blocks in the basic SEM configuration is larger than 1, multiple sub blocks are inserted in the configuration settings and result tables.

Particular features of configuring multiple sub blocks

The sub blocks are independent of the global start, stop, center and span frequencies for the complete SEM measurement. Thus, there can be gaps that can even include other carrier ranges, but are not configured for the SEM measurement.

For each sub block, you define:

- The center frequency of the reference range of the sub block; center frequencies must be defined in ascending order for sub blocks A,B,C
- The reference range; note that although individual ranges of different sub blocks can overlap, reference ranges for different sub blocks *cannot*; they must define distinct frequency ranges
- The sweep list, including the limit lines
- Optionally: a standard file or MSR settings to be used for measurement (if one is selected, the other is disabled)



Fast SEM not supported for multiple sub blocks

For SEM with multiple sub blocks, fast SEM is not available. If more than one sub block is defined and a standard is loaded which contains an active fast SEM setting, this setting is disabled.

Absolute vs relative frequencies

In the default configuration with only one sub block, frequencies are defined relative to the center frequency; this is the familiar configuration.

For setups with more than one sub block, frequencies are defined relative to the center frequency of the reference ranges for the individual sub blocks. However, in the result summary, frequencies are indicated as absolute values. Relative frequencies that refer to different reference ranges would be inconvenient and difficult to analyze.

Limit check behavior for overlapping masks

Since spectrum emission masks are defined individually for each sub block, and sub blocks can overlap, the question arises what happens during the limit check in the overlapping regions? To answer this question, we must distinguish the following cases:

- For the reference range, no limit checking is performed, as the reference range contains the carrier
- For other ranges, only the limit lines defined for ranges between the carriers, that is the reference ranges to either side, are significant. In other words: if a limit line def-

initiation covers the frequency area of several carriers, only the limit lines for ranges between the corresponding reference range and the next closest reference range are significant.

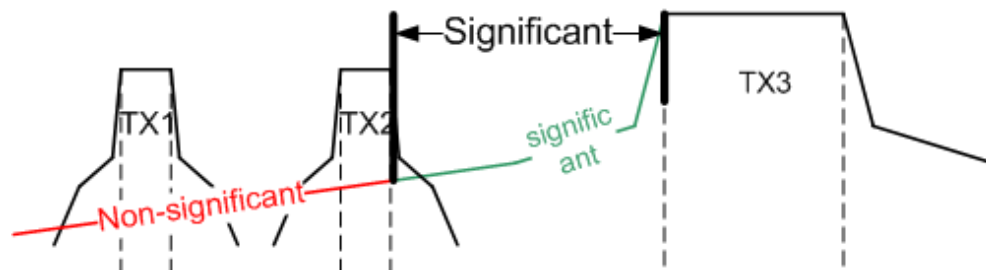

Figure 6-36: Behavior for overlapping masks

- For the ranges in which multiple limit lines are significant, a range-specific function determines the behavior of the limit check

Limit calculation for individual ranges

For each range a function can be defined that determines the behavior of the limit check if there are multiple limit lines:

- **"NONE"** : In reference ranges no limit check is performed; Reference ranges always use the function "NONE" . For other ranges, see the combinations for overlapping ranges below.
- **"SUM"** : sum of the two limit lines (calculated for linear powers) is used
- **"MAX"** : maximum of the two limit lines is used

This leads to the following **combinations for overlapping ranges**:

- **"MAX" + "MAX"** : maximum of the two limit lines is used
- **"MAX" + "SUM"** : maximum of the two limit lines is used
- **"SUM" + "SUM"** : sum of the two limit lines (calculated for linear powers) is used
- **"NONE" + "MAX" / "NONE" + "SUM"** : limit line (and parameters) of the "NONE" range are ignored
- **"NONE" + "NONE"** : depends on the position of the overlapping ranges in relation to the mid-frequency between the two neighboring sub blocks:
 - Overlap is completely *below* the mid-frequency: limits and parameters of the left sub block are used
 - Overlap is completely *above* the mid-frequency: limits and parameters of the right sub block are used
 - Overlap crosses the mid-frequency: new subranges are created: one to the left of the mid-frequency, one to the right of the mid-frequency. The left subrange uses the limits and parameters of the left sub block, the right subrange uses the limits and parameters of the right sub block.



Different RBWs in overlapping ranges

If different RBWs are defined for the overlapping ranges, the following parameters from the range with the smaller RBW are considered for both ranges:

- RBW
- VBW
- Attenuation
- Reference level
- Transducer
- Filter type
- (proportional) sweep time

In the range with the higher RBW, the following offset is applied to the limit line:

$$-10 \cdot \log(RBW_{large} / RBW_{small})$$

Table 6-12: Limit lines in overlapping ranges crossing the mid-frequency

<p>Initial situation: overlapping ranges Range 4 ("None") + Range 5 ("None") overlap and cross the mid-frequency between sub blocks 1 and 2</p>	<p>Result: Subranges 4a and 5a are created left and right of the mid-frequency; For subrange 4a: limit line and parameters of range 4 apply For subrange 5a: limit line and parameters of range 5 apply</p>

Global SEM limit check

For the complete SEM measurement, which can consist of multiple sub blocks, only one single limit check is performed. A single limit line is calculated according to the individual range limit lines and the defined functions for overlapping ranges. The measured values are then compared with this single limit line. If the limit is exceeded in any range, the result of the limit check is . " failed!"

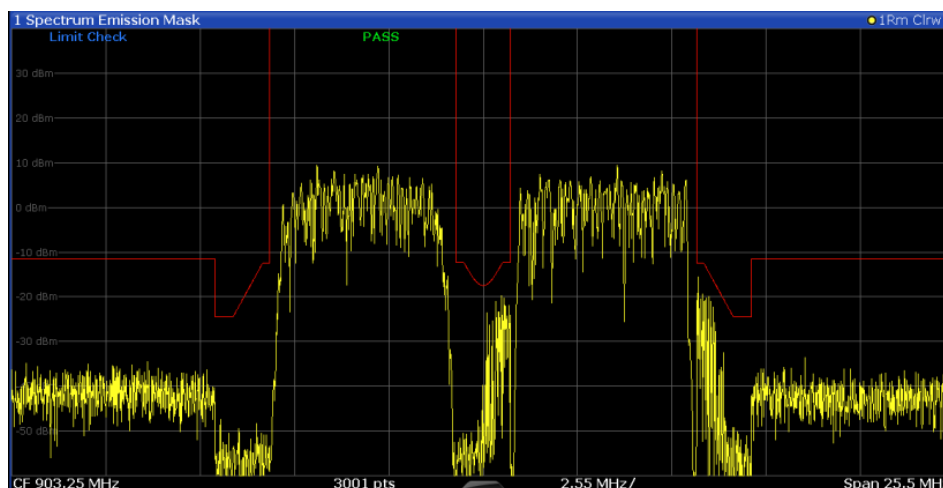

Figure 6-37: Summarized limit line for multiple sub blocks

6.5.5 SEM Configuration

Access: "Overview" > "Select Measurement" > "Spectrum Emission Mask"

The SEM measurement is started immediately with the default settings.

The remote commands required to perform these tasks are described in [Chapter 12.5.6, "Measuring the Spectrum Emission Mask"](#), on page 680.



Global span settings

The span of the signal to be monitored is configured in the general span settings (see [Chapter 7.3.2, "Frequency and Span Settings"](#), on page 345). Only ranges within this global span are considered for the SEM measurement.



Multi-SEM configuration

In the Spectrum application application only, spectrum emissions can be measured for multiple sub blocks of channels (see [Chapter 6.5.4.5, "SEM with Multiple Sub Blocks \("Multi-SEM"\)"](#), on page 215). Up to three sub blocks (with two gaps) can be defined. For each sub block, the familiar configuration settings concerning ranges, limit lines etc. can be defined in individual tabs. In addition, settings on the sub blocks themselves must be configured in the "Sub Block" tab of the "Spectrum Emission Mask" configuration dialog box (see [Chapter 6.5.5.2, "Multi-SEM \(Sub Block\) Settings"](#), on page 225).

The following settings are available in individual tabs of the "Spectrum Emission Mask" configuration dialog box.

- [Sweep List](#)220
- [Multi-SEM \(Sub Block\) Settings](#)225
- [Reference Range](#).....226
- [Power Classes](#).....227

- [MSR Settings](#)..... 229
- [Standard Files](#)..... 232
- [List Evaluation \(Results Configuration\)](#)..... 234

6.5.5.1 Sweep List

Access: "Overview" > "Select Measurement" > "Spectrum Emission Mask" > "Sweep List"



If you edit the sweep list, always follow the rules and consider the limitations described in [Chapter 6.5.4.1, "Ranges and Range Settings"](#), on page 209.

	Range 1	Range 2	Range 3
Sub Block A			
Range Start	-12.75 MHz	2.515 MHz	2.515 MHz
Range Stop	-2.515 MHz	2.515 MHz	12.75 MHz
Sub Block B			
Filter Type	Normal(3...	Normal(3...	Normal(3...
RBW	30 kHz	30 kHz	30 kHz
Sub Block C			
VBW	3 MHz	3 MHz	3 MHz
Sweep Time Mode	Auto	Auto	Auto
Sweep Time	140 µs	140 µs	140 µs
Ref Level	0 dBm	0 dBm	0 dBm
RF Att Mode	Auto	Auto	Auto
RF Attenuation	10 dB	10 dB	10 dB
Preamp	Off	Off	Off
Transducer	None	None	None
Multi Limit Calc	SUM	NONE	SUM
Limit Check 1	Relative	Relative	Relative
Rel Limit Start 1	-50 dBc	300 dBc	-50 dBc

- [Range Start / Range Stop](#) 221
- [Fast SEM](#) 221
- [Filter Type](#) 221
- [RBW](#) 221
- [VBW](#) 221
- [Sweep Time Mode](#) 222
- [Sweep Time](#) 222
- [Ref Level](#) 222
- [RF Att Mode](#) 222
- [RF Attenuation](#) 222
- [Transducer Factor](#) 222
- [Limit Check <n>](#) 223
- [Abs Limit Start / Stop <n>](#) 223
- [Rel Limit Start / Stop <n>](#) 223
- [Multi-Limit Calc <n>](#) 224
- [Min Sweep Points](#) 224

Insert before Range / Insert after Range	224
Delete Range	224
Symmetrical Setup	225

Range Start / Range Stop

Sets the start frequency/stop frequency of the selected range.

To change the start/stop frequency of the first or last range, respectively, select the appropriate span in the SPAN configuration dialog. You can set a span that is smaller than the overall span of the ranges. In this case, the measurement includes only the ranges that lie within the defined span and have a minimum span of 20 Hz. The first and last ranges are adapted to the given span as long as the minimum span of 20 Hz is not violated.

Define frequency values for each range relative to the center frequency. Center the reference range on the center frequency. The current "Tx Bandwidth" defines the minimum span of the reference range (see "[Channel Power Settings](#)" on page 227).

Remote command:

`[SENSe:]ESpectrum<sb>:RANGe<range>[:FREQuency]:START` on page 687

`[SENSe:]ESpectrum<sb>:RANGe<range>[:FREQuency]:STOP` on page 687

Fast SEM

Activates "Fast SEM" mode for all ranges in the sweep list. For details, see [Chapter 6.5.4.3, "Fast SEM Measurements"](#), on page 213.

Note: If you deactivate "Fast SEM" mode while "Symmetrical Setup" mode is on, "Symmetrical Setup" mode is automatically also deactivated.

If you activate "Fast SEM" mode while "Symmetrical Setup" mode is on, not all range settings can be configured symmetrically automatically.

Remote command:

`[SENSe:]ESpectrum<sb>:HighSPeed` on page 684

Filter Type

Sets the filter type for this range.

For details on filter types, see [Chapter 7.5.1.6, "Which Data May Pass: Filter Types"](#), on page 364.

Remote command:

`[SENSe:]ESpectrum<sb>:RANGe<range>:FILTer:TYPE` on page 686

RBW

Sets the resolution bandwidth for this range.

For details on the RBW, see [Chapter 7.5.1.1, "Separating Signals by Selecting an Appropriate Resolution Bandwidth"](#), on page 361.

Remote command:

`[SENSe:]ESpectrum<sb>:RANGe<range>:BANDwidth:RESolution`
on page 685

VBW

Sets the video bandwidth for this range.

For details on the VBW, see [Chapter 7.5.1.2, "Smoothing the Trace Using the Video Bandwidth"](#), on page 362.

Remote command:

`[SENSe:]ESpectrum<sb>:RANGe<range>:BANDwidth:VIDeo` on page 685

Sweep Time Mode

Activates or deactivates the auto mode for the sweep time.

For details on the sweep time mode, see [Chapter 7.5.1.7, "How Long the Data is Measured: Sweep Time"](#), on page 365

Remote command:

`[SENSe:]ESpectrum<sb>:RANGe<range>:SWEep:TIME:AUTO` on page 697

Sweep Time

Sets the sweep time value for the range.

For details on the sweep time, see [Chapter 7.5.1.7, "How Long the Data is Measured: Sweep Time"](#), on page 365

Remote command:

`[SENSe:]ESpectrum<sb>:RANGe<range>:SWEep:TIME` on page 696

Ref Level

Sets the reference level for the range.

For details on the reference level, see [Chapter 7.4.1.1, "Reference Level"](#), on page 352.

Remote command:

`[SENSe:]ESpectrum<sb>:RANGe<range>:RLEVel` on page 696

RF Att Mode

Activates or deactivates the auto mode for RF attenuation.

For details on attenuation, see [Chapter 7.4.1.2, "RF Attenuation"](#), on page 353.

Remote command:

`[SENSe:]ESpectrum<sb>:RANGe<range>:INPut:ATTenuation:AUTO` on page 688

RF Attenuation

Sets the attenuation value for the range.

For details on attenuation, see [Chapter 7.4.1.3, "Scaling"](#), on page 354.

Remote command:

`[SENSe:]ESpectrum<sb>:RANGe<range>:INPut:ATTenuation` on page 688

Transducer Factor

Sets a transducer for the specified range. You can only choose a transducer that fulfills the following conditions:

- The transducer overlaps or equals the span of the range.
- The x-axis is linear.
- The unit is dB.

For details on transducers, see [Chapter 10.3.1, "Basics on Transducer Factors"](#), on page 546.

Remote command:

[\[SENSe:\]ESpectrum<sb>:RANGe<range>:TRANsducer](#) on page 697

Limit Check <n>

Sets the type of limit check for the n-th power class in the range. Up to four limits are possible.

For details on limit checks, see [Chapter 6.5.4.2, "Limit Lines in SEM Measurements"](#), on page 211.

The limit state affects the availability of all limit settings.

Remote command:

[\[SENSe:\]ESpectrum<sb>:RANGe<range>:LIMit<PClass>:STATe](#) on page 694
[CALCulate<n>:LIMit<k>:FAIL?](#) on page 932

Abs Limit Start / Stop <n>

Sets an absolute limit value for the n-th power class at the start or stop frequency of the range [dBm].

Remote command:

[\[SENSe:\]ESpectrum<sb>:RANGe<range>:LIMit<PClass>:ABSolute:START](#) on page 689
[\[SENSe:\]ESpectrum<sb>:RANGe<range>:LIMit<PClass>:ABSolute:STOP](#) on page 690

Rel Limit Start / Stop <n>

Sets a relative limit value for the n-th power class at the start or stop frequency of the range [dBc].

By default, this value is a fixed relative limit, i.e. no function is defined. To define a function for the relative limit, select the input field for "Rel Limit Start" or "Rel Limit Stop" and then the "f(x)" icon that appears.

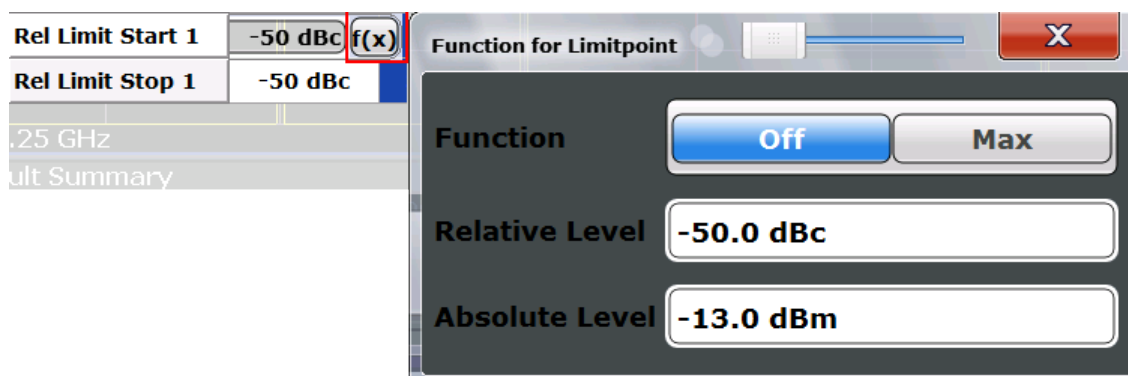

If the function is set to "Max", you can define a relative *and* an absolute limit level. In this case, the maximum of the two values is used as the limit level.

For more information, see ["Relative limit line functions"](#) on page 213.

Remote command:

[SENSe:]ESpectrum<sb>:RANGe<range>:LIMit<PClass>:RELative:START
on page 690

[SENSe:]ESpectrum<sb>:RANGe<range>:LIMit<PClass>:RELative:STOP
on page 692

[SENSe:]ESpectrum<sb>:RANGe<range>:LIMit<PClass>:RELative:START:
FUNction on page 692

[SENSe:]ESpectrum<sb>:RANGe<range>:LIMit<PClass>:RELative:STOP:
FUNction on page 694

[SENSe:]ESpectrum<sb>:RANGe<range>:LIMit<PClass>:RELative:START:
ABS on page 691

[SENSe:]ESpectrum<sb>:RANGe<range>:LIMit<PClass>:RELative:STOP:
ABS on page 693

Multi-Limit Calc <n>

Defines the function used to calculate the limit line for the n-th power class for overlapping ranges in Multi-SEM measurements. For details, see "[Limit calculation for individual ranges](#)" on page 217.

"NONE" (reference ranges only:) the limit of the reference range is used

"SUM" Sum of the two limit lines (calculated for linear powers) is used

"MAX" Maximum of the two limit lines is used

Remote command:

[SENSe:]ESpectrum<sb>:RANGe<range>:MLCalc on page 695

Min Sweep Points

Defines the minimum number of sweep points for the range.

If necessary to fulfill all minimum sweep point requirements in all ranges, the global [Sweep Points](#) setting is increased. By default, each range is supplied with a minimum of one sweep point.

For details, see "[Sweep points](#)" on page 211

Remote command:

[SENSe:]ESpectrum<sb>:RANGe<range>:POINts:MINimum[:VALue]
on page 695

Insert before Range / Insert after Range

Inserts a new range to the left (before) or to the right (after) of the range in which the cursor is currently displayed. The range numbers of the currently focused range and all higher ranges are increased accordingly. The maximum number of ranges is 30.

Remote command:

[SENSe:]ESpectrum<sb>:RANGe<range>:INSert on page 689

Delete Range

Deletes the currently focused range, if possible. (The reference range cannot be deleted. A minimum of three ranges is required.) The range numbers are updated accordingly.

Remote command:

[SENSe:]ESpectrum<sb>:RANGe<range>:DELeTe on page 686

Symmetrical Setup

Any changes to the range settings in active "Symmetrical Setup" mode lead to symmetrical changes in the other ranges (where possible). In particular, this means:

- Inserting ranges: a symmetrical range is inserted on the other side of the reference range
- Deleting ranges: the symmetrical range on the other side of the reference range is also deleted
- Editing range settings: the settings in the symmetrical range are adapted accordingly

Note: If "Fast SEM" mode is deactivated while "Symmetrical Setup" mode is on, "Sym Setup" mode is automatically also deactivated.

If "Fast SEM" mode is activated while "Symmetrical Setup" mode is on, not all range settings can be set automatically.

6.5.5.2 Multi-SEM (Sub Block) Settings

Access: "Overview" > "Select Measurement" > "Spectrum Emission Mask" > "Sub Blocks"

In the Spectrum application application only, spectrum emissions can be measured for multiple sub blocks of channels (see Chapter 6.5.4.5, "SEM with Multiple Sub Blocks ("Multi-SEM)", on page 215). Sub blocks are a set of multiple ranges around a defined center frequency (carrier).

By default, a single sub block is assumed. If more than one sub blocks are defined, additional tabs are inserted for each sub block in the individual tabs of the "Spectrum Emission Mask" configuration dialog box.

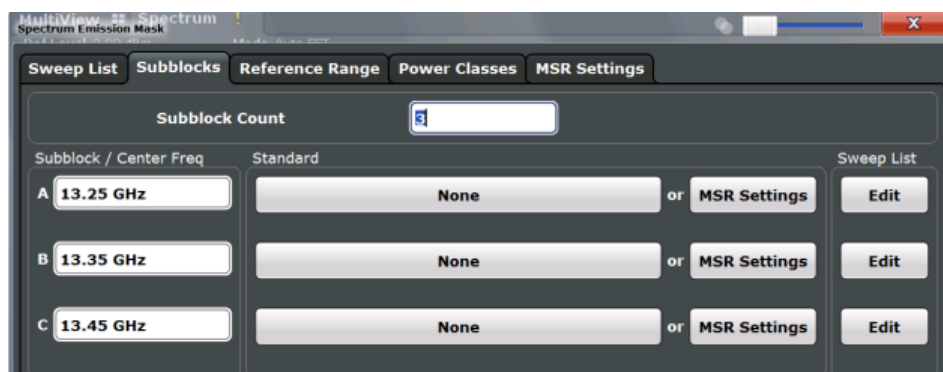

Sub Block Count 225

Sub Block / Center Freq 226

Standard / MSR Settings 226

Edit Sweep List 226

Sub Block Count

Defines the number of sub blocks. By default, the familiar SEM measurement with just one single block of ranges is configured.

Remote command:

[SENSe:]ESpectrum<sb>:SCount on page 683

Sub Block / Center Freq

Defines the center frequency for an individual sub block. The center frequency determines the reference range used for each block.

For measurements with only one sub block, this setting corresponds to the global setting in the "Frequency" settings (see [Center Frequency](#)).

Remote command:

[SENSe:]ESpectrum<sb>:SCENter on page 683

Standard / MSR Settings

Defines the use of a standard settings file or a multi-standard radio configuration for a particular sub block. For details, see [Chapter 6.5.5.6, "Standard Files"](#), on page 232 and [Chapter 6.5.5.5, "MSR Settings"](#), on page 229.

Note that *either* a standard *or* an MSR setting can be selected; if one is selected, the other is disabled.

Remote command:

[SENSe:]ESpectrum<sb>:PRESet[:STANdard] on page 681

Edit Sweep List

Switches to the "Sweep List" tab of the "Spectrum Emission Mask" dialog box to configure the individual frequency ranges and mask limits for the corresponding sub block. See [Chapter 6.5.5.1, "Sweep List"](#), on page 220.

6.5.5.3 Reference Range

Access: "Overview" > "Select Measurement" > "Spectrum Emission Mask" > "Reference Range"

The range around the center frequency is defined as the reference range for all other ranges in the sweep list.

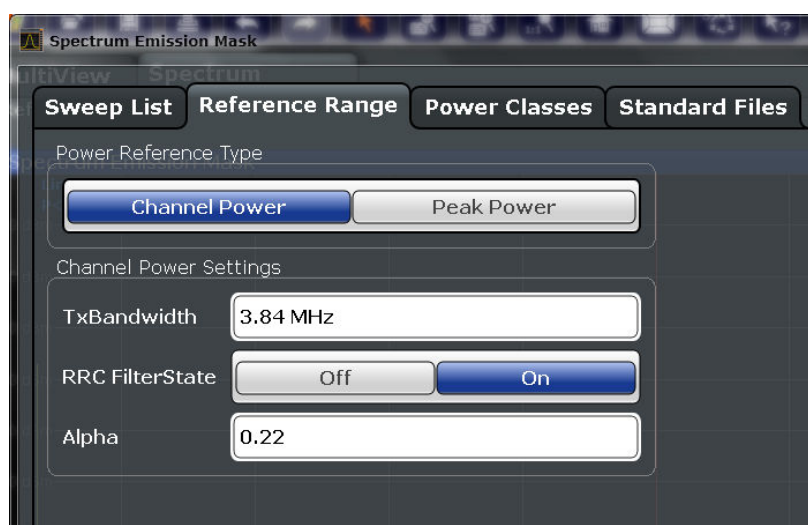

Power Reference Type	227
Channel Power Settings	227
L Tx Bandwidth	227
L RRC Filter State	227
L Alpha:	227

Power Reference Type

Defines how the reference power is calculated.

"Channel Power"

Measures the channel power within the reference range using the integration bandwidth method. Additional settings can be configured for this method.

(See also "IBW method" on page 149)

"Peak Power"

Determines the peak power within the reference range.

Remote command:

[SENSe:]ESpectrum<sb>:RTYPE on page 699

Channel Power Settings

If the "Power Reference Type:" "Channel Power" was selected, additional parameters can be configured.

Tx Bandwidth ← Channel Power Settings

Defines the bandwidth used for measuring the channel power, with:

Minimum span ≤ "Tx Bandwidth" ≤ of reference range

Remote command:

[SENSe:]ESpectrum<sb>:BWID on page 698

RRC Filter State ← Channel Power Settings

Activates or deactivates the use of an RRC filter.

Remote command:

[SENSe:]ESpectrum<sb>:FILTer[:RRC][:STATe] on page 698

Alpha: ← Channel Power Settings

Sets the alpha value of the RRC filter (if activated).

Remote command:

[SENSe:]ESpectrum<sb>:FILTer[:RRC]:ALPHa on page 698

6.5.5.4 Power Classes

Access: "Overview" > "Select Measurement" > "Spectrum Emission Mask" > "Power Classes"

You can configure power classes which you can then assign to sweep list ranges. For details, see "Power classes" on page 211.

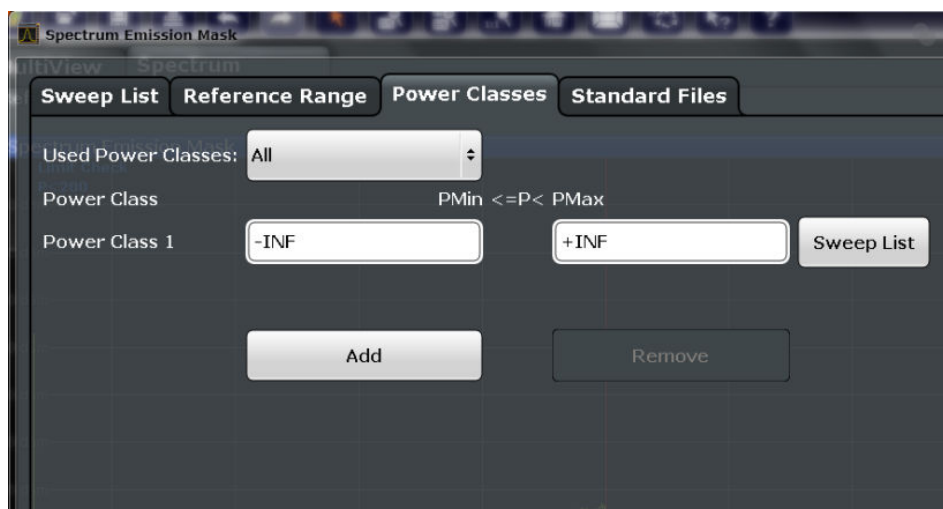

Used Power Classes:228
 PMin / PMax228
 Sweep List229
 Adding or Removing a Power Class 229

Used Power Classes:

Defines which power classes are considered for the SEM measurement. Limits can be defined only for used power classes. It is only possible to select either one specific power class or all the defined power classes.

If "All" is selected, the power class that corresponds to the currently measured power in the reference range is used for monitoring. The limits assigned to that power class are applied (see " Abs Limit Start / Stop <n> " on page 223 and " Rel Limit Start / Stop <n> " on page 223).

Remote command:

```
CALCulate<n>:LIMit<k>:ESpectrum<sb>:PCLass<PClass>[:EXCLusive]
on page 702
```

To define all limits in one step:

```
CALCulate<n>:LIMit<k>:ESpectrum<sb>:PCLass<PClass>:LIMit[:STATe]
on page 702
```

PMin / PMax

Defines the power limits for each power class. The first range always starts at -200 dBm (-INF) and the last range always stops at 200 dBm (+INF). These fields cannot be modified. If more than one power class is defined, the value of "PMin" must be equal to the value of "PMax" of the previous power class and vice versa.

Note that the power level can be equal to the lower limit(s), but must be lower than the upper limit(s):

$$P_{min} \leq P < P_{max}$$

Otherwise the ranges are corrected automatically.

Remote command:

`CALCulate<n>:LIMit<k>:ESpectrum<sb>:PCLass<PClass>:MINimum`
on page 703

`CALCulate<n>:LIMit<k>:ESpectrum<sb>:PCLass<PClass>:MAXimum`
on page 703

Sweep List

Switches to the "Sweep List" tab of the "Spectrum Emission Mask" dialog box and focuses the "Limit Check" setting for the corresponding power class (1-4) in the reference range (see " [Limit Check <n>](#) " on page 223).

Adding or Removing a Power Class

Adds a new power class at the end of the list or removes the last power class. After adding or removing, the last power class is adapted to end at "+INF" . Note that a maximum of four power classes are available.

Remote command:

`CALCulate<n>:LIMit<k>:ESpectrum<sb>:PCLass:COUNT` on page 701

6.5.5.5 MSR Settings

Access: "Overview" > "Select Measurement" > "Spectrum Emission Mask" > "MSR Settings"

Multi-standard radio (MSR) measurements allow you to perform SEM tests on multiple carriers using different digital standards.

For details, see [Chapter 6.5.4.4, "Multi-Standard Radio \(MSR\) SEM Measurements"](#), on page 215.

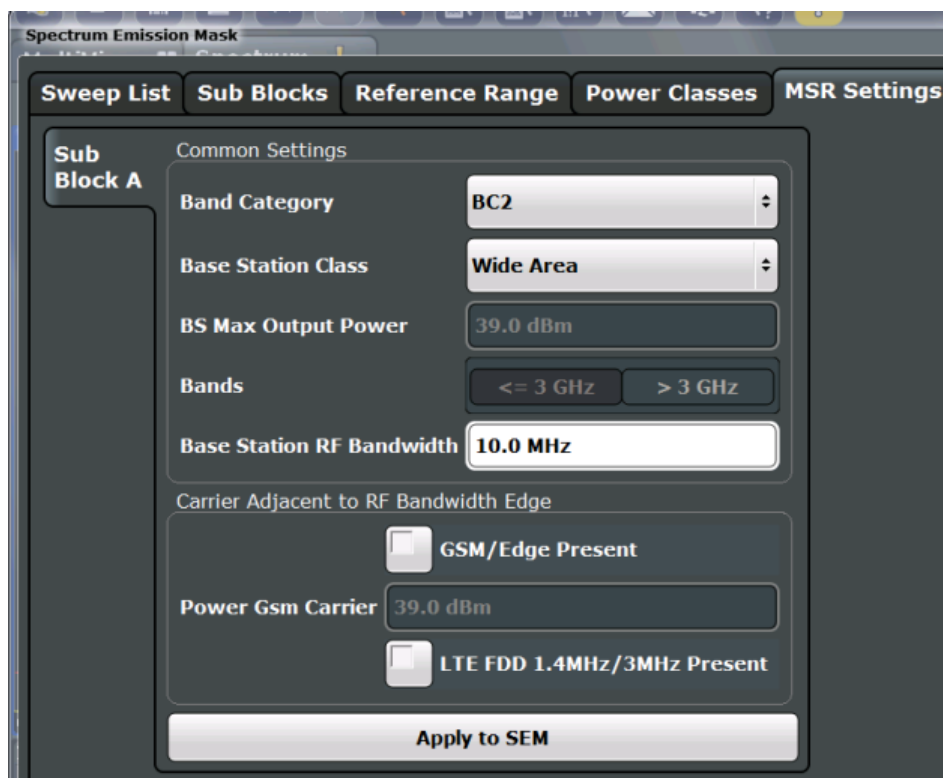

Band Category 230
 Base Station Class 230
 Base Station Maximum Output Power 231
 Bands 231
 Base Station RF Bandwidth 231
 Carrier Adjacent to RF Bandwidth Edge 231
 Power Gsm Carrier 231
 Apply to SEM 232

Band Category

Defines the band category for MSR measurements, i.e. the combination of available carriers to measure.

- "BC1" LTE FDD and W-CDMA
- "BC2" LTE FDD, W-CDMA and GSM/EDGE
- "BC3" LTE TDD and TD-SCDMA

Remote command:

[SENSe:]ESpectrum<sb>:MSR:BCATegory on page 705

Base Station Class

Defines the class of the base station according to its sending range.

This setting is required to calculate the SEM limits according to standard 3GPP 37.141 V12.2.0.

Remote command:

[SENSe:]ESpectrum<sb>:MSR:CLASs on page 706

Base Station Maximum Output Power

Defines the maximum output power of the base station. Possible values are from 0 dBm to 100 dBm in 1 dB steps.

This setting is only available for base stations with a medium range [Base Station Class](#).

This value is required to calculate the SEM limits according to standard 3GPP 37.141 V12.2.0.

Remote command:

`[SENSe:]ESpectrum<sb>:MSR:MPOWer` on page 709

Bands

Defines the frequency range of the bands used by the base station.

This setting is only available for [Band Category](#) 1 or 3.

This setting is required to calculate the SEM limits according to standard 3GPP 37.141 V12.2.0.

Remote command:

`[SENSe:]ESpectrum<sb>:MSR:BAND` on page 705

Base Station RF Bandwidth

Defines the relevant RF bandwidth (span) required to measure all available carriers in MSR SEM measurements.

Remote command:

`[SENSe:]ESpectrum<sb>:MSR:RFBWidth` on page 709

Carrier Adjacent to RF Bandwidth Edge

For particular measurement setups, the specification demands specific limits for the SEM ranges.

These settings are only available for [Band Category](#) 2.

"GSM/Edge Present"

A GSM/EDGE carrier is located at the edge of the RF band.
In this case, the power of the GSM carrier must be specified (see "[Power Gsm Carrier](#)" on page 231).

"LTE FDD 1.4MHz/3MHz Present"

An LTE FDD 1.4 MHz or 3 MHz carrier is located at the edge of the RF band.

Remote command:

`[SENSe:]ESpectrum<sb>:MSR:GSM:CPResent` on page 708

`[SENSe:]ESpectrum<sb>:MSR:LTE:CPResent` on page 708

Power Gsm Carrier

Defines the power of the GSM carrier (if available, see "[Carrier Adjacent to RF Bandwidth Edge](#)" on page 231). Possible values are from 0 dBm to 100 dBm in 1 dB steps.

This setting is only available for [Band Category](#) 2.

This setting is required to calculate the SEM limits according to standard 3GPP 37.141 V12.2.0.

Remote command:

[SENSe:]ESpectrum<sb>:MSR:GSM:CARRier on page 707

Apply to SEM

Configures the SEM sweep list according to the specified MSR settings.

Remote command:

[SENSe:]ESpectrum<sb>:MSR:APPLY on page 704

6.5.5.6 Standard Files

Access: "Overview" > "Select Measurement" > "Spectrum Emission Mask" > "Standard Files"

You can save the current measurement settings as a user-defined standard (XML file), or load stored measurement settings. Furthermore, you can delete an existing settings file.

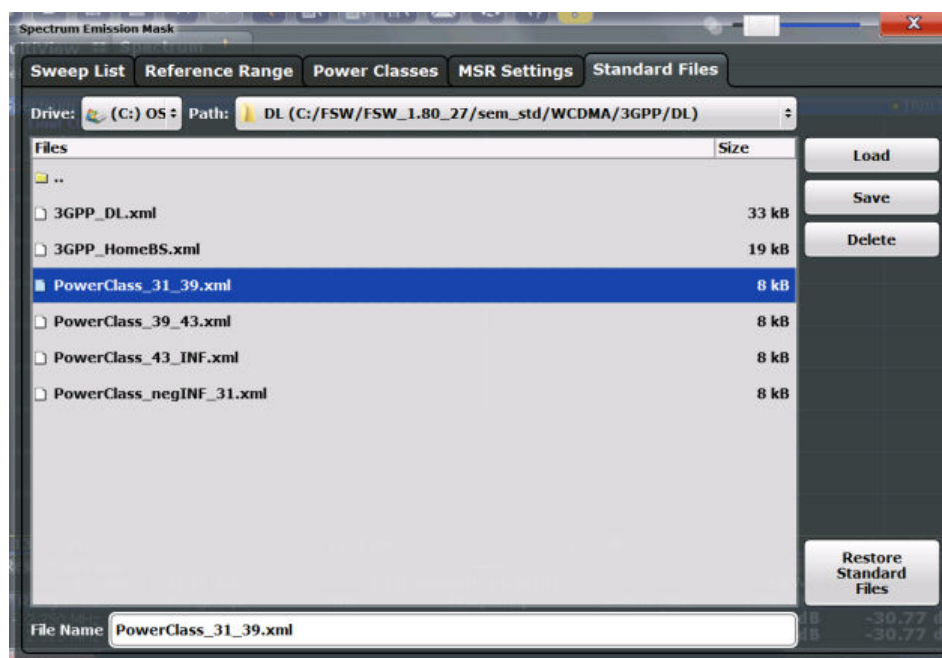

For details, see [Chapter 6.5.6.1, "How to Manage SEM Settings Files"](#), on page 238.



Standard files for sub blocks (Multi-SEM measurements)

If more than one sub blocks are defined, the "Standard Files" tab and softkey are not available. To load a standard file for an individual sub block, use the [Standard / MSR Settings](#) setting in the "Sub Blocks" tab.

Selecting Storage Location - Drive/ Path/ Files	233
File Name	233
Load Standard	233

Save Standard	233
Delete Standard	233
Restore Standard Files	234

Selecting Storage Location - Drive/ Path/ Files

Select the storage location of the file on the instrument or an external drive.

The default storage location for the SEM settings files is: C:\R_S\INSTR\sem_std.

Note: Saving instrument settings in secure user mode.

In secure user mode, settings that are stored on the instrument are stored to volatile memory, which is restricted to 256 MB. Thus, a "memory limit reached" error can occur although the hard disk indicates that storage space is still available.

To store data permanently, select an external storage location such as a USB memory device.

For details, see [Chapter 4.1.6, "Protecting Data Using the Secure User Mode"](#), on page 33.

Remote command:

[MMEMemory:CATalog?](#) on page 937

File Name

Contains the name of the data file without the path or extension.

By default, the name of a user file consists of a base name followed by an underscore. Multiple files with the same base name are extended by three numbers, e.g.

limit_lines_005.

For details on the filename and location, see [Chapter 9.3.2.2, "Storage Location and Filename"](#), on page 507.

Load Standard

Loads the selected measurement settings file.

Remote command:

[\[SENSe:\]ESpectrum<sb>:PRESet\[:STANdard\]](#) on page 681

Save Standard

Saves the current measurement settings for a specific standard as a file with the defined name.

Remote command:

[\[SENSe:\]ESpectrum<sb>:PRESet:STORe](#) on page 681

Delete Standard

Deletes the selected standard. Standards predefined by Rohde & Schwarz can also be deleted. A confirmation query is displayed to avoid unintentional deletion of the standard.

Note: Restoring predefined standard files. The standards predefined by Rohde & Schwarz available at the time of delivery can be restored using the "Restore Standard Files" function (see ["Restore Standard Files"](#) on page 234).

Restore Standard Files

Restores the standards predefined by Rohde & Schwarz available at the time of delivery.

The XML files from the C:\R_S\INSTR\sem_backup folder are copied to the C:\R_S\INSTR\sem_std folder.

Note that this function will overwrite customized standards that have the same name as predefined standards.

Remote command:

[SENSe:]ESpectrum<sb>:PRESet:REStore on page 681

6.5.5.7 List Evaluation (Results Configuration)

Access: "Overview" > "Select Measurement" > "Spectrum Emission Mask" > "List Evaluation"

In the "List Evaluation" dialog box, you configure the contents and display of the SEM results.

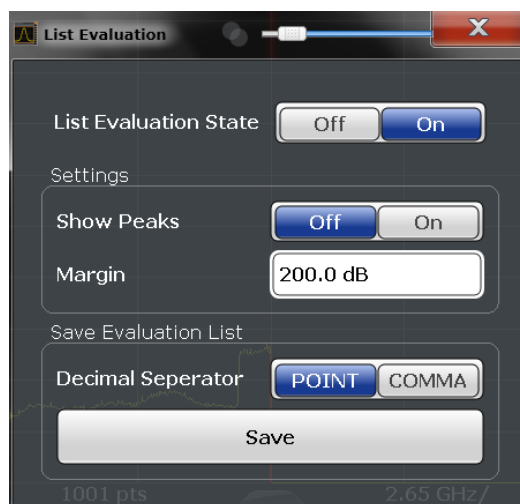

List Evaluation State (Result Summary).....	234
Show Peaks	234
Margin	235
Saving the Result Summary (Evaluation List) to a File	235

List Evaluation State (Result Summary)

Activates or deactivates the Result Summary.

Remote command:

CALCulate<n>:ESpectrum:PEAKsearch:AUTO on page 710

TRACe<n>[:DATA] on page 854

Show Peaks

If activated, all peaks that have been detected during an active SEM measurement are marked with blue squares in the Spectrum diagram.

Remote command:

[CALCulate<n>:ESpectrum:PEAKsearch:PSHow](#) on page 711

Margin

Although a margin functionality is not available for the limit check, you can define a margin (or: *threshold*) for the peak values to be displayed in the result summary. Only peaks that exceed the margin value are displayed (also in the diagram, if activated).

Remote command:

[CALCulate<n>:ESpectrum:PEAKsearch:MARGIN](#) on page 711

Saving the Result Summary (Evaluation List) to a File

Exports the Result Summary of the SEM measurement to an ASCII file for evaluation in an external application. If necessary, change the decimal separator for evaluation in other languages.

Define the filename and storage location in the file selection dialog box that is displayed when you select the "Save" function.

For details, see [Chapter 6.5.8.2, "ASCII File Export Format \(Spectrum Emission Mask\)"](#), on page 247.

Remote command:

[MMEMemory:STORE<n>:LIST](#) on page 963

[FORMat:DEXPort:DSEPARATOR](#) on page 937

6.5.6 How to Perform a Spectrum Emission Mask Measurement

SEM measurements can be performed according to a specific standard or freely configured. Configuration for signals with a regular channel definition can be configured quickly and easily. Selecting the SEM measurement is a prerequisite for all other tasks.

For signals with multiple carriers, also in non-contiguous ranges, an SEM measurement with multiple sub blocks can be configured.

For multi-standard radio SEM measurements, configuration for specified scenarios can be done automatically.

The following tasks are described:

- ["To select an SEM measurement"](#) on page 235
- ["To perform an SEM measurement according to a standard"](#) on page 236
- ["To configure a user-defined SEM measurement"](#) on page 236
- ["To perform an MSR SEM measurement"](#) on page 237
- ["To perform a Multi-SEM measurement"](#) on page 238



For remote operation, see [Chapter 12.5.6.11, "Example: SEM Measurement"](#), on page 712.

To select an SEM measurement

- ▶ Press the MEAS key, then select the "Spectrum Emission Mask" measurement.

To perform an SEM measurement according to a standard

- ▶ Load the settings file as described in ["How to load an SEM settings file"](#) on page 238 and start a measurement.

To configure a user-defined SEM measurement

1. Define the span of the signal you want to monitor in the general span settings.
2. Split the frequency span of the measurement into ranges for signal parts with similar characteristics.
Starting from the center frequency, determine which sections of the signal to the left and right can be swept and monitored using the same parameters. Criteria for such a range definition may be, for example:
 - The signal power level
 - The required resolution bandwidth or sweep time
 - Transducer factors
 - Permitted deviation from the defined signal level, i.e. the required limit values for monitoringIf the signal consists of a transmission channel and adjacent channels, the channel ranges can usually be used for the range definition.
3. If the signal power level to be monitored varies and the limits vary, define power classes. For each range of levels that can be monitored in the same way, define a power class.
 - a) Select the "Overview" softkey.
 - b) Select the "SEM Setup" button.
 - c) Switch to the "Power Classes" tab.
 - d) To add a power class, select the "Add" button.
 - e) Enter the start and stop power levels to define the class.
 - f) Select the power classes to be used for the current measurement:
 - a specific class
 - all classes, to have the required class selected automatically according to the input level measured in the reference range
4. Select the "Sweep List" tab of the "Spectrum Emission Mask" dialog box.
5. Insert the required ranges using the "Insert before Range" and "Insert after Range" buttons, which refer to the currently selected range (the reference range by default).
If the signal trace is symmetric to the center frequency, activate the "Sym Setup" option to make setup easier and quicker.
6. Define the measurement parameters for each range as required. If symmetrical setup is activated, you only have to configure the ranges to one side of the center range.
In particular, define the limits for each range of the signal, i.e. the area in which the signal level can deviate without failing the limit check. If several power classes were defined (see [step 3](#)), define limits for each power class.

- a) Define the type of limit check, i.e. whether absolute values or relative values are checked, or both. The type of limit check is identical for all power classes.
 - b) Define the limit start and stop values.
7. If the sweep list settings - other than the limit and transducer values - are identical for several adjacent ranges, activate "Fast SEM" mode to speed up the measurement. You only have to activate the mode for one range, the others are adapted automatically.
 8. If necessary, change the settings for the reference power to which all SEM results refer in the "Reference Range" tab.
 9. To indicate the determined peaks in the display during an SEM measurement, select "Overview" > "Analysis" > "Show Peaks" .
 10. To save the current SEM measurement settings to a file to re-use them later, save a settings file as described in ["How to save a user-defined SEM settings file"](#) on page 239.
 11. Start a sweep.
The determined powers and limit deviations for each range are indicated in the Result Summary. If activated, the peak power levels for each range are also indicated in the Spectrum diagram.
 12. To save the Result Summary, export the results to a file as described in [Chapter 6.5.6.2, "How to Save SEM Result Files"](#), on page 239.

To perform an MSR SEM measurement

1. Select the "MSR Config" softkey.
2. Select the band category that determines the digital standards used in the measurement setup (see [" Band Category "](#) on page 230).
3. Define the bandwidth that contains all relevant carrier signals to be measured.
4. For measurements with GSM/EDGE, LTE FDD and W-CDMA carriers (BC2), define whether a GSM/EDGE or an LTE FDD carrier, or both, are located at the edge of the bandwidth.
5. Select the "Apply to SEM" button.
The sweep list is configured according to the MSR specification, with the required number of ranges and defined limits.
6. Start a sweep.
The determined powers and limit deviations for each range are indicated in the Result Summary. If activated, the peak power levels for each range are also indicated in the Spectrum diagram.
7. To save the Result Summary, export the results to a file as described in [Chapter 6.5.6.2, "How to Save SEM Result Files"](#), on page 239.

To perform a Multi-SEM measurement

1. Define the span of the signal to be monitored in the general span settings.
2. Select the "Multi-SEM Config" softkey.
3. Define the number of sub blocks (up to 3) that contain the relevant carriers.
4. For each sub block, define the center frequency, that is, the frequency of the TX carrier or a frequency in the dedicated reference range.
5. For each sub block, do one of the following:
 - Select a standard settings file to be used.
 - Select the "MSR Settings" button and define the MSR configuration as described in ["To perform an MSR SEM measurement"](#) on page 237.
 - Select the "Edit" button and configure the sweep list manually as defined in ["To configure a user-defined SEM measurement"](#) on page 236. Be sure to select the correct vertical tab for the corresponding sub block within each subtab of the "Spectrum Emission Mask" configuration dialog.
Define a function to be used for overlapping ranges in the "Multi-Limit Calc" field of the sweep list.
6. Start a sweep.

The determined powers and limit deviations for each sub block, each gap, and each range are indicated in the Result Summary. If activated, the peak power levels for each range are also indicated in the Spectrum diagram.
7. To save the Result Summary, export the results to a file as described in [Chapter 6.5.6.2, "How to Save SEM Result Files"](#), on page 239.

6.5.6.1 How to Manage SEM Settings Files

SEM measurement settings can be saved to an XML file which can then be exported to another application or loaded on the R&S FPS again later. Some predefined XML files are provided that contain ranges and parameters according to the selected standard. All XML files are stored under `C:\R_S\INSTR\sem_std`.

For details on the file format of the SEM settings file, see [Chapter 6.5.8.1, "Format Description of SEM XML Files"](#), on page 241.

SEM settings or standard files are managed in the "Standard" tab of the "Spectrum Emission Mask" dialog box. To display this dialog box, select the "Overview" softkey and then the "SEM Setup" button.

How to load an SEM settings file

1. From the file selection dialog box, select the settings file (with a `.xml` extension).
2. Select the "Load" button.

The settings from the selected file are restored to the R&S FPS and you can repeat the SEM measurement with the stored settings.

How to save a user-defined SEM settings file

1. Configure the SEM measurement as required (see [Chapter 6.5.6, "How to Perform a Spectrum Emission Mask Measurement"](#), on page 235).
2. In the "Standard Files" tab of the "Spectrum Emission Mask" dialog box, define a filename and storage location for the settings file.
3. Select the "Save" button.

The settings are stored to a file with the extension `.xml` as specified.

How to delete an SEM settings file

1. In the "Standard Files" tab of the "Spectrum Emission Mask" dialog box, select the file you want to delete.
2. Select the "Delete" button.
3. Confirm the message.

The settings file is removed from the R&S FPS.

How to restore default SEM settings files

The R&S FPS is delivered with predefined settings files which can be edited and overwritten. However, you can restore the original files.

- ▶ In the "Standard Files" tab of the "Spectrum Emission Mask" dialog box, select the "Restore Standard Files" button.

The original predefined settings files are available for selection on the R&S FPS.

6.5.6.2 How to Save SEM Result Files

The Result Summary from an SEM measurement can be saved to a file, which can be exported to another application for further analysis, for example.

For details on the file format of the SEM export file, see [Chapter 6.5.8.2, "ASCII File Export Format \(Spectrum Emission Mask\)"](#), on page 247.

1. Configure and perform an SEM measurement as described in [Chapter 6.5.6, "How to Perform a Spectrum Emission Mask Measurement"](#), on page 235.
2. In the "Overview" , select the "Analysis" button.
3. If necessary, change the "Decimal Separator" to "COMMA" for evaluation in other languages.
4. Select the "Save" button.
5. In the file selection dialog box, select a storage location and filename for the result file.

6. Select the "Save" button.

The file with the specified name and the extension `.dat` is stored in the defined storage location.

6.5.7 Measurement Example: Multi-SEM Measurement

The following measurement example demonstrates an SEM measurement for a signal with multiple sub blocks.



A programming example demonstrating a SEM measurement in a remote environment is provided in [Chapter 12.5.6.11, "Example: SEM Measurement"](#), on page 712.

Test setup:

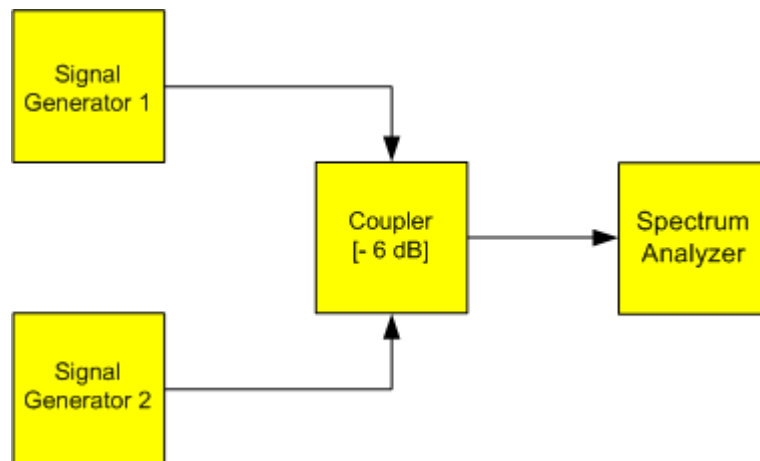

Signal generator settings (e.g. R&S FPS SMW):

Device	Standard	Center frequency	Level	Test model
SigGen 1	3GPP/FDD	900 MHz	0 dBm	1-16
SigGen 2	EUTRALTE	906.5 MHz	0 dBm	1_1_5MHz

Setting up the measurement

1. Preset the R&S FPS.
2. Set the center frequency to *903.25 MHz*.
3. Set the reference level to *10 dBm* with an offset of to *30 dB*.
4. Press the MEAS key or select "Select Measurement" in the "Overview" .
5. Select the "SEM" measurement function.
6. Select the "Sub Blocks" softkey and enter "Sub Block Count" of 2.

7. For "Sub Block A" , define the settings for the 3GPP/FDD signal:
 - Set the "Center Frequency" to 900 MHz
 - Select "MSR Settings" .
 - Set the "Base Station RF Bandwidth" to 5 MHz.
 - Select "Apply to SEM" .
8. For "Sub Block B" , define the settings for the EUTRA/LTE signal:
 - Set the "Center Frequency" to 906.5 MHz
 - Select "MSR Settings" .
 - Set the "Base Station RF Bandwidth" to 5 MHz.
 - Select "Apply to SEM" .
9. Select RUN SINGLE to perform a measurement with the new settings.

The results of the measurement for each sub block are displayed in the Result Summary. The summarized limit line is indicated in the Spectrum graph.

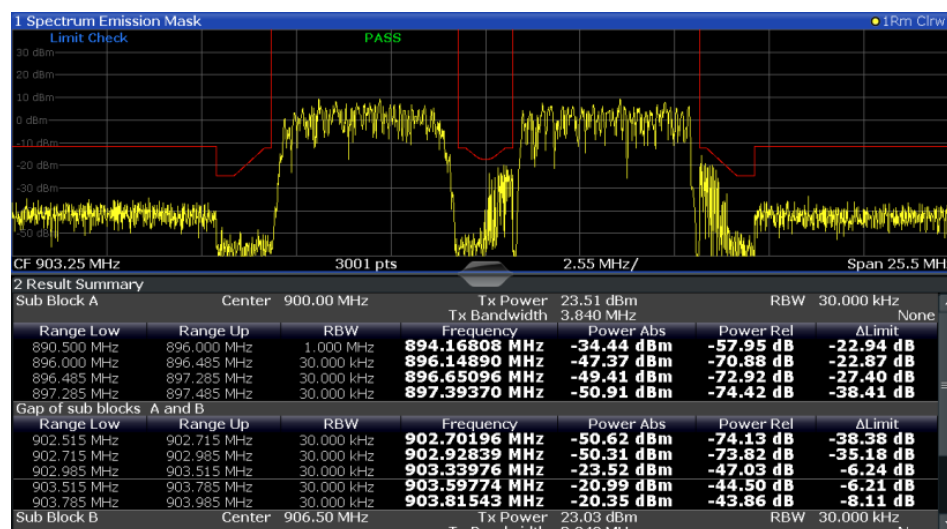

Figure 6-38: Multi-SEM measurement: results of the measurement for each sub block

6.5.8 Reference: SEM File Descriptions

This reference provides details on the format of the SEM settings and result files.

- [Format Description of SEM XML Files](#).....241
- [ASCII File Export Format \(Spectrum Emission Mask\)](#).....247

6.5.8.1 Format Description of SEM XML Files

The SEM XML files offer a quick way to change the measurement settings. A set of predefined XML files for different standards is already provided. You can also create and use your own XML files. Alternatively, edit the settings directly in the "Spectrum Emission Mask" dialog box and save the XML file afterwards. This way, you do not have to modify the XML file itself.

In addition to saving the current settings to a file, settings files can also be created independently of the R&S FPS, in an external application. When creating your own XML files, be sure to comply with the following conventions because the R&S FPS can only interpret XML files of a known structure. For sample files, see the `C:\R_S\INSTR\sem_std` directory of the R&S FPS.

To load a settings file, use the "Load" function in the "Standard Files" tab of the "Spectrum Emission Mask" dialog box (see ["How to load an SEM settings file"](#) on page 238). All XML files are stored under `C:\R_S\INSTR\sem_std`.

The files for importing range settings obey the rules of the XML standard. The child nodes, attributes, and structure defined for the data import are described here.



Be sure to follow the structure exactly as shown below or else the R&S FPS is not able to interpret the XML file and error messages are shown on the screen. It is recommended that you make a copy of an existing file and edit the copy of the file.

Basically, the file consists of three elements that can be defined:

- The `BaseFormat` element
- The `PowerClass` element
- The `Range` element

The "BaseFormat" element

It carries information about basic settings. In this element, only the `ReferencePower` child node has any effects on the measurement itself. The other attributes and child nodes are used to display information about the Spectrum Emission Mask standard on the measurement screen. The child nodes and attributes of this element are shown in [Table 6-13](#).

Example:

In the sample file `PowerClass_39_43.xml` under `C:\R_S\INSTR\sem_std\WCDMA\3GPP`, these attributes are defined as follows:

- `Standard="W-CDMA 3GPP"`
- `LinkDirection="DL"`
- `PowerClass="(39,43)dBm"`

The "PowerClass" element

It is embedded in the `BaseFormat` element and contains settings information about the power classes. Up to four different power classes can be defined. For details, refer to [Chapter 6.5.5.4, "Power Classes"](#), on page 227. The child nodes and attributes of this element are shown in [Table 6-14](#).

The "Range" element

This element is embedded in the `PowerClass` element. It contains the settings information of the range. There have to be at least three defined ranges: one reference range and at least one range to either side of the reference range. The maximum num-

ber of ranges is 30. Note that the R&S FPS uses the same ranges in each power class. Therefore, the contents of the ranges of each defined power class have to be identical to the first power class. The `Start` and `Stop` values of the two `Limit` nodes that are used to determine the power class are an exception. Note also that you must define two limit nodes: one that defines the limit in absolute values and one in relative values. Make sure units for the `Start` and `Stop` nodes are identical for each `Limit` node.

For details, refer to [Chapter 6.5.5.1, "Sweep List"](#), on page 220. The child nodes and attributes of this element are shown in [Table 6-15](#).

The following tables show the child nodes and attributes of each element and show if a child node or attribute is mandatory for the R&S FPS to interpret the file or not. The hierarchy of the XML cannot be seen in the tables. View one of the predefined files already stored on the R&S FPS in the "C:\R_S\INSTR\sem_std" directory, or check the structure as shown below.

Below, a basic example of the structure of the file is shown, containing all mandatory attributes and child nodes. Note that the `PowerClass` element and the `Range` element are themselves elements of the `BaseFormat` element. They must be inserted where noted. They are separated here simply to provide a better overview. Also, no example values are given here to allow a quick reference to the tables above. *Italic font* shows the placeholders for the values.

- The `BaseFormat` element is structured as follows:
 - `<RS_SEM_ACP_FileFormat Version="1.0.0.0">`
`<Name>"Standard"</Name>`
`<Instrument>`
`<Type>"Instrument Type"</Type>`
`<Application>"Application"</Application>`
`</Instrument>`
`<LinkDirection Name="Name">`
`<ReferencePower>`
`<Method>"Method"</Method>`
`</ReferencePower>`
`<PowerClass Index="n">`
`<!-- For contents of the PowerClass node, see Table 6-14 -->`
`<!-- Define up to four PowerClass nodes -->`
`</PowerClass>`
`</LinkDirection>`
`</RS_SEM_ACP_File>`
- The "PowerClass" element is structured as follows:
 - `<PowerClass Index="n">`
`<StartPower Unit="dBm" InclusiveFlag="true" Value="StartPowerValue"/>`
`<StopPower Unit="dBm" InclusiveFlag="false" Value="StopPowerValue"/>`
`<DefaultLimitFailMode>"Limit Fail Mode"</DefaultLimitFailMode>`
`<Range Index="n">`
`<!-- For contents of the Range node, see Table 6-15 -->`
`<!-- Define up to twenty Range nodes -->`
`</Range>`
`...`

- ```

</PowerClass>

```
- The "Range" element is structured as follows:
    - <Range Index="n">
      - <Name="Name">
      - <ChannelType>"Channel Type"</Channel Type>
      - <WeightingFilter>
        - <Type>"FilterType"</Type>
        - <RollOffFactor>"Factor"</RollOffFactor>
        - <Bandwith>"Bandwidth"</Bandwidth>
      - </WeightingFilter>
      - <FrequencyRange>
        - <Start>"RangeStart"</Start>
        - <Stop>"RangeStop"</Stop>
      - </FrequencyRange>
      - <Limit>
        - <Start Unit="Unit" Value="Value"/>
        - <Stop Unit="Unit" Value="Value"/>
      - </Limit>
      - <Limit>
        - <Start Unit="Unit" Value="Value"/>
        - <Stop Unit="Unit" Value="Value"/>
      - </Limit>
      - <RBW Bandwidth="Bandwidth" Type="FilterType"/>
      - <VBW Bandwidth="Bandwidth"/>
      - <Detector>"Detector"</Detector>
      - <Sweep Mode="SweepMode" Time="SweepTime"/>
      - <Amplitude>
        - <ReferenceLevel Unit="dBm" Value="Value"/>
        - <RFAttenuation Mode="Auto" Unit="dB" Value="Value"/>
        - <Preamplifier State="State"/>
      - </Amplitude>
      - <MeasPointsMin>1</MeasPointsMin>
      - <CalcRuleMulti>Sum</CalcRuleMulti>
    - </Range>

Table 6-13: Attributes and child nodes of the BaseFormat element

| Child Node    | Attribute         | Value                       | Parameter Description   | Mand. |
|---------------|-------------------|-----------------------------|-------------------------|-------|
|               | FileFormatVersion | 1.0.0.0                     |                         | Yes   |
|               | Date              | YYYY-MM-DD<br>HH:MM:SS      | Date in ISO 8601 format | No    |
| Name          |                   | <string>                    | Name of the standard    | Yes   |
| Instrument    | Type              | FSL                         | Name of the instrument  | No    |
|               | Application       | SA   K72   K82              | Name of the application | No    |
| LinkDirection | Name              | Downlink   Uplink  <br>None |                         | Yes   |
|               | ShortName         | DL   UL                     |                         | No    |

| Child Node        | Attribute                                | Value | Parameter Description | Mand. |
|-------------------|------------------------------------------|-------|-----------------------|-------|
| Reference-Power   |                                          |       |                       | Yes   |
| Method            | TX Channel Power   TX Channel Peak Power |       |                       | Yes   |
| Reference-Channel | <string>                                 |       |                       | No    |

**Table 6-14: Attributes and child nodes of the PowerClass element**

| Child Node           | Attribute     | Value                                                              | Parameter description                                                                                                        | Mand. |
|----------------------|---------------|--------------------------------------------------------------------|------------------------------------------------------------------------------------------------------------------------------|-------|
| StartPower           | Value         | <power in dBm>                                                     | The start power must be equal to the stop power of the previous power class. The StartPower value of the first range is -200 | Yes   |
|                      | Unit          | dBm                                                                |                                                                                                                              | Yes   |
|                      | InclusiveFlag | true                                                               |                                                                                                                              | Yes   |
| StopPower            | Value         | <power in dBm>                                                     | The stop power must be equal to the start power of the next power class. The StopPower value of the last range is 200        | Yes   |
|                      | Unit          | dBm                                                                |                                                                                                                              |       |
|                      | InclusiveFlag | false                                                              |                                                                                                                              | Yes   |
| DefaultLimitFailMode |               | Absolute   Relative   Absolute and Relative   Absolute or Relative |                                                                                                                              | Yes   |

**Table 6-15: Attributes and child nodes of the Range element (normal ranges)**

| Child node      | Attribute  | Value         | Parameter description                           | Mand.                                                                                  |
|-----------------|------------|---------------|-------------------------------------------------|----------------------------------------------------------------------------------------|
|                 | Index      | 0...19        | Indices are continuous and have to start with 0 | Yes                                                                                    |
|                 | Name       | <string>      | Name of the range                               | Only if ReferenceChannel contains a name and the range is the reference range          |
|                 | Short-Name | <string>      | Short name of the range                         | No                                                                                     |
| ChannelType     |            | TX   Adjacent |                                                 | Yes                                                                                    |
| WeightingFilter |            |               |                                                 | Only if ReferencePower method is TX Channel Power and the range is the reference range |

## Spectrum Emission Mask (SEM) Measurement

| Child node      | Attribute | Value                                                              | Parameter description                                                                                                                                            | Mand.                                         |
|-----------------|-----------|--------------------------------------------------------------------|------------------------------------------------------------------------------------------------------------------------------------------------------------------|-----------------------------------------------|
| Type            |           | RRC   CFilter                                                      | Type of the weighting filter                                                                                                                                     | Yes                                           |
| Roll Off Factor |           | 0...1                                                              | Excess bandwidth of the filter                                                                                                                                   | Only if the filter type is RRC                |
| Bandwidth       |           | <bandwidth in Hz>                                                  | Filter bandwidth                                                                                                                                                 | Only if the filter type is RRC                |
| FrequencyRange  |           |                                                                    |                                                                                                                                                                  | Yes                                           |
| Start           |           | <frequency in Hz>                                                  | Start value of the range                                                                                                                                         | Yes                                           |
| Stop            |           | <frequency in Hz>                                                  | Stop value of the range                                                                                                                                          | Yes                                           |
| Limit           |           | dBm/Hz   dBm   dBc   dBr   dB                                      | A Range must contain exactly two limit nodes; one of the limit nodes has to have a relative unit (e.g. dBc), the other one must have an absolute unit (e.g. dBm) | Yes                                           |
| Start           | Value     | <numeric_value>                                                    | Power limit at start frequency                                                                                                                                   | Yes                                           |
|                 | Unit      | dBm/Hz   dBm   dBc   dBr   dB                                      | Sets the unit of the start value                                                                                                                                 |                                               |
| Stop            | Value     | <numeric_value>                                                    | Power limit at stop frequency                                                                                                                                    |                                               |
|                 | Unit      | dBm/Hz   dBm   dBc   dBr   dB                                      | Sets the unit of the stop value                                                                                                                                  |                                               |
| LimitFailMode   |           | Absolute   Relative   Absolute and Relative   Absolute or Relative | If used, it has to be identical to DefaultLimitFailMode                                                                                                          | No                                            |
| RBW             | Bandwidth | <bandwidth in Hz>                                                  | " RBW " on page 221                                                                                                                                              | Yes                                           |
|                 | Type      | NORM   PULS   CFIL   RRC                                           |                                                                                                                                                                  | No                                            |
| VBW             | Bandwidth | <bandwidth in Hz>                                                  | " VBW " on page 221                                                                                                                                              | Yes                                           |
| Detector        |           | NEG   POS   SAMP   RMS   AVER   QUAS                               | If used, it has to be identical in all ranges.                                                                                                                   | No                                            |
| Sweep           | Mode      | Manual   Auto                                                      | " Sweep Time Mode " on page 222                                                                                                                                  | Yes                                           |
|                 | Time      | <time in sec>                                                      | " Sweep Time " on page 222                                                                                                                                       | No                                            |
| Amplitude       |           |                                                                    |                                                                                                                                                                  | No                                            |
| ReferenceLevel  | Value     | <power in dBm>                                                     | " Ref Level " on page 222                                                                                                                                        | Yes, if the ReferenceLevel child node is used |

| Child node    | Attribute | Value         | Parameter description       | Mand.                                         |
|---------------|-----------|---------------|-----------------------------|-----------------------------------------------|
|               | Unit      | dBm           | Defines dBm as unit         | Yes, if the ReferenceLevel node is used       |
| RFAttenuation | Mode      | Manual   Auto | " RF Att Mode " on page 222 | Yes, if the ReferenceLevel child node is used |

### 6.5.8.2 ASCII File Export Format (Spectrum Emission Mask)

When trace data from an SEM measurement is exported, the data is stored in ASCII format as described below. The first part of the file lists information about the signal analyzer and the general setup.

| File contents                     | Explanation                             |
|-----------------------------------|-----------------------------------------|
| <b>File header</b>                |                                         |
|                                   | Model                                   |
| Version;1.00;                     | Firmware version                        |
| Date;31.Mar 17;                   | Storage date of data set                |
| Mode;ANALYZER;SEM;                | Operating mode and measurement function |
| Center Freq;13250000000.000000;Hz | X-axis settings                         |
| Freq Offset;0.000000;Hz           |                                         |
| Span;255000000.000000;Hz          |                                         |
| x-Axis;LIN;                       |                                         |
| Start;13237250000.000000;Hz       |                                         |
| Stop;13262750000.000000;Hz        |                                         |
| Level Offset;0.000000;dB          | Y-axis settings                         |
| Ref Position;100.000000;%         |                                         |
| y-Axis;LOG;                       |                                         |
| Level Range;100.000000;dB         |                                         |
| <b>Trace settings</b>             |                                         |
| Trace Mode;CLR/WRITE;             |                                         |
| Detector;RMS;                     |                                         |
| Sweep Count;0;                    |                                         |
| Trace 1.;                         |                                         |
| x-Unit;Hz;                        |                                         |
| y-Unit;dBm;                       |                                         |
| <b>List evaluation settings</b>   |                                         |

| File contents                                                                                            | Explanation                                                                                                                                                                                                                                                                                                                                                               |
|----------------------------------------------------------------------------------------------------------|---------------------------------------------------------------------------------------------------------------------------------------------------------------------------------------------------------------------------------------------------------------------------------------------------------------------------------------------------------------------------|
| Margin;200;                                                                                              | Peak List margin                                                                                                                                                                                                                                                                                                                                                          |
| <b>Reference range settings</b>                                                                          |                                                                                                                                                                                                                                                                                                                                                                           |
| RefType; CPOWER;                                                                                         | Reference power type                                                                                                                                                                                                                                                                                                                                                      |
| TxBandwidth;3840000;;Hz                                                                                  | Channel power settings                                                                                                                                                                                                                                                                                                                                                    |
| Filter State; ON;                                                                                        |                                                                                                                                                                                                                                                                                                                                                                           |
| Alpha;0.22;                                                                                              |                                                                                                                                                                                                                                                                                                                                                                           |
| PeaksPerRange;1;                                                                                         | Max. number of peaks per range to be detected                                                                                                                                                                                                                                                                                                                             |
| Values;2;                                                                                                | Number of detected peaks                                                                                                                                                                                                                                                                                                                                                  |
| <b>File data section</b>                                                                                 |                                                                                                                                                                                                                                                                                                                                                                           |
| 0;-12750000;-2515000;30000;13242367500;-43.844722747802734;-0.33028793334960938;49.669712066650391;FAIL; | Measured peak values:<br><range number>;<br><start frequency>;<br><stop frequency>;<br><resolution bandwidth of range>;<br><frequency of peak>;<br><absolute power in dBm of peak>;<br><relative power in dBc of peak>; (related to the channel power)<br><distance to the limit line in dB>; (positive value means above the limit)<br><limit fail (pass = 0, fail =1)>; |
| 2;2515000;12750000;30000;13257632500;-43.844722747802734;-0.33028793334960938;49.669712066650391;FAIL;   |                                                                                                                                                                                                                                                                                                                                                                           |

## 6.6 Spurious Emissions Measurement

Spurious Emissions measurements monitor unwanted RF products outside the assigned frequency band generated by an amplifier.

- [About the Measurement](#).....248
- [Spurious Emissions Measurement Results](#).....249
- [Spurious Emissions Basics](#).....250
- [Spurious Emissions Measurement Configuration](#).....252
- [How to Perform a Spurious Emissions Measurement](#).....258
- [Reference: ASCII Export File Format \(Spurious\)](#).....259

### 6.6.1 About the Measurement

The Spurious Emissions measurement monitors unwanted RF products outside the assigned frequency band generated by an amplifier. The spurious emissions are usually measured across a wide frequency range. The Spurious Emissions measurement allows a flexible definition of all parameters. A result table indicates the largest devia-



tions of the absolute power from the limit line for each range, and the results can be checked against defined limits automatically.

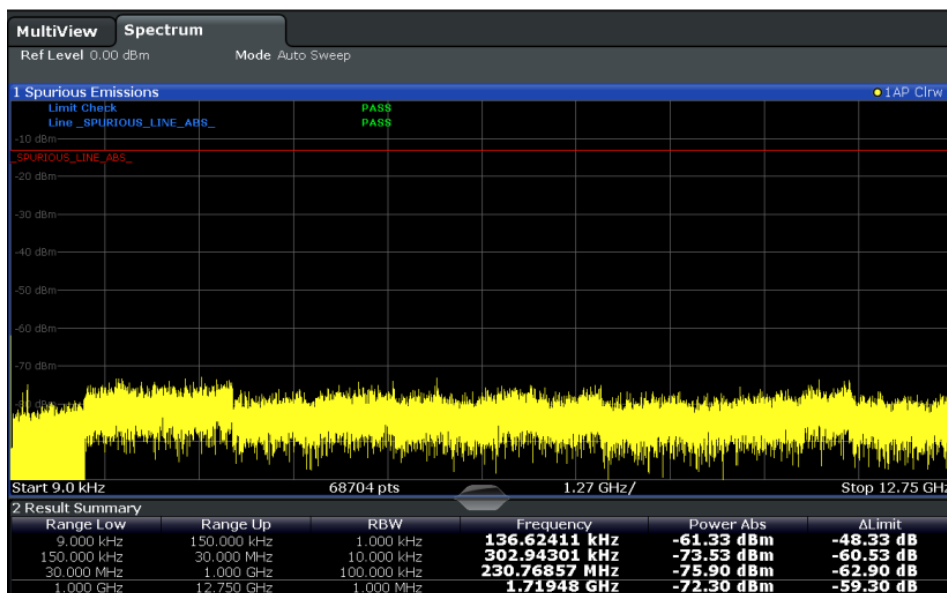

### 6.6.2 Spurious Emissions Measurement Results

The measured signal, including any spurious emissions, and optionally the detected peaks are displayed in the Spurious Emissions measurement diagram. If defined, the limit lines and the limit check results are also indicated. In addition to the graphical results, a result table can be displayed to evaluate the measured powers and limit check results (see also [Chapter 6.6.3.2, "Limit Lines in Spurious Measurements"](#), on page 251). The details of the evaluation list can be configured.

| Range Low   | Range Up    | RBW         | Frequency     | Power Abs  | ΔLimit    |
|-------------|-------------|-------------|---------------|------------|-----------|
| 9.000 kHz   | 150.000 kHz | 1.000 kHz   | 136.62411 kHz | -61.33 dBm | -48.33 dB |
| 150.000 kHz | 30.000 MHz  | 10.000 kHz  | 302.94301 kHz | -73.53 dBm | -60.53 dB |
| 30.000 MHz  | 1.000 GHz   | 100.000 kHz | 230.76857 MHz | -75.90 dBm | -62.90 dB |
| 1.000 GHz   | 12.750 GHz  | 1.000 MHz   | 1.71948 GHz   | -72.30 dBm | -59.30 dB |

The following information is provided in the evaluation list for each range:

| Column    | Description                                                                     |
|-----------|---------------------------------------------------------------------------------|
| Range Low | Frequency range start for the range the peak value belongs to                   |
| Range Up  | Frequency range end for the range the peak value belongs to                     |
| RBW       | RBW of the range                                                                |
| Frequency | Frequency at the peak value                                                     |
| Power Abs | Absolute power level at the peak value                                          |
| ΔLimit    | Deviation of the absolute power level from the defined limit for the peak value |

By default, one peak per range is displayed. However, you can change the settings to:

- Display all peaks
- Display a certain number of peaks per range
- Display only peaks that exceed a threshold ( "Margin" )
- Display detected peaks as blue squares in the diagram, as well as in the peak list

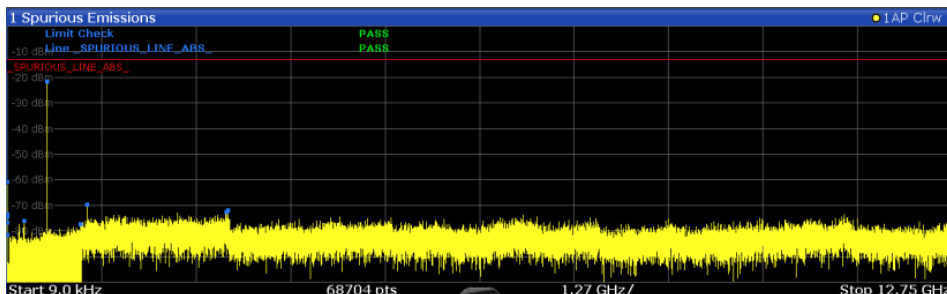

Furthermore, you can save the evaluation list to a file.

### Retrieving Results via Remote Control

The measured spurious values of the displayed trace can be retrieved using the TRAC:DATA? SPUR command (see TRACe<n> [ :DATA] on page 854).

## 6.6.3 Spurious Emissions Basics

Some background knowledge on basic terms and principles used in Spurious Emissions measurements is provided here for a better understanding of the required configuration settings.

- [Ranges and Range Settings](#)..... 250
- [Limit Lines in Spurious Measurements](#)..... 251

### 6.6.3.1 Ranges and Range Settings

#### Conditions for ranges

The following rules apply to ranges:

- The minimum span of a range is 20 Hz.
- The individual ranges must not overlap (but can have gaps).
- The maximum number of ranges is 30
- The maximum number of sweep points in all ranges is limited to 100001.

You can define a span that is smaller than the combined span of the ranges. In this case, the measurement includes only the ranges that lie within the defined span and have a minimum span of 20 Hz.



### Defining ranges by remote control

In Spurious Emissions measurements, there are no remote commands to insert new ranges between existing ranges directly. However, you can delete or redefine the existing ranges to create the required order.

A remote command example for defining parameters and ranges in Spurious Emissions measurements is described in [Chapter 12.5.7.6, "Programming Example: Spurious Emissions Measurement"](#), on page 726.

### 6.6.3.2 Limit Lines in Spurious Measurements

Limit lines allow you to check the measured data against specified limit values. Generally, it is possible to define limit lines for any measurement in the Spectrum application using the LINES key. For Spurious measurements, however, a special limit line is available via the "Sweep List", and it is strongly recommended that you use only this limit line definition.

In the "Sweep List", you can define a limit line that varies its level according to the specified frequency ranges. A distinguished limit line is automatically defined according to the current "Sweep List" settings every time the settings change. This limit line is labeled "\_SPURIOUS\_LINE\_ABS\_<xxx>", where <xxx> is an index to distinguish limit lines between different channels.

If a limit check is activated in the "Sweep List", the "\_SPURIOUS\_LINE\_ABS\_<xxx>" limit line is indicated by a red line in the display. The result of the limit check is indicated at the top of the diagram. Note that only "Pass" or "Fail" is indicated; a margin function as for general limit lines is not available. Also, only absolute limits can be checked, not relative ones.

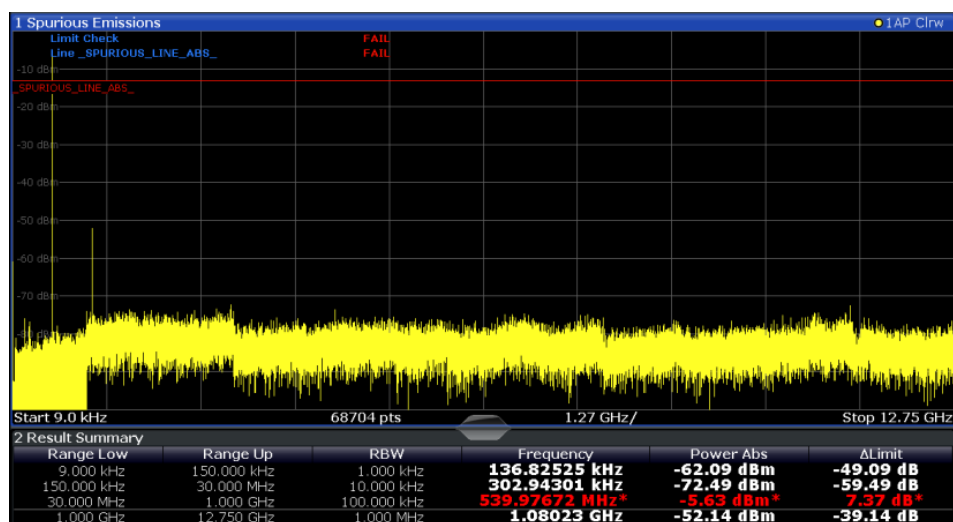

As for general limit lines, the results of each limit line check are displayed (here: "\_SPURIOUS\_LINE\_ABS\_<xxx>"), as well as the combined result for all defined limit lines ("Limit Check").

The limit check is considered to be "failed!" if any signal level outside the absolute limits is measured.

If the limit check is activated, the limit line values for each range are displayed in the evaluation list. Furthermore, the largest deviations of the absolute power from the limit line for each range are displayed. Values that exceed the limit are indicated in red and by an asterisk (\*).



Although a margin functionality is not available for the limit check, a margin (threshold) for the peak values to be displayed in the evaluation list can be defined. Furthermore, you can define how many peaks per range are listed. For details, see [Chapter 6.6.4.3, "List Evaluation"](#), on page 256.

## 6.6.4 Spurious Emissions Measurement Configuration

**Access:** "Overview" > "Select Measurement" > "Spurious Emissions"

The spurious emissions measurement is started immediately with the default settings.

The remote commands required to perform these tasks are described in [Chapter 12.5.7, "Measuring Spurious Emissions"](#), on page 715.

- [Sweep List](#).....252
- [Adjusting the X-Axis to the Range Definitions](#).....256
- [List Evaluation](#).....256

### 6.6.4.1 Sweep List

**Access:** "Overview" > "Select Measurement" > "Spurious Emissions" > "Sweep List"

For Spurious Emissions measurements, the input signal is split into several frequency ranges which are swept individually and for which different limitations apply.



If you edit the sweep list, always follow the rules and consider the limitations described in [Chapter 6.6.3.1, "Ranges and Range Settings"](#), on page 250.

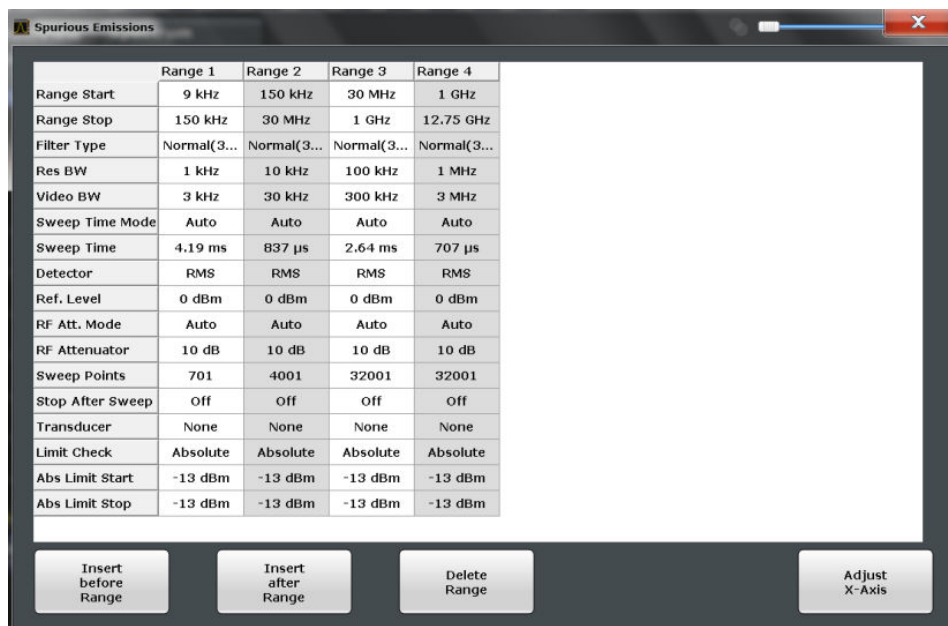

Range Start / Range Stop ..... 253

Filter Type ..... 253

RBW ..... 254

VBW ..... 254

Sweep Time Mode ..... 254

Sweep Time ..... 254

Detector ..... 254

Reference Level ..... 254

RF Attenuation Mode ..... 255

RF Attenuation ..... 255

Sweep Points ..... 255

Stop After Sweep ..... 255

Transducer ..... 255

Limit Check ..... 255

Abs Limit Start / Abs Limit Stop ..... 256

Insert before Range / Insert after Range ..... 256

Delete Range ..... 256

**Range Start / Range Stop**

Sets the start frequency/stop frequency of the selected range.

You can define a span that is smaller than the overall span of the ranges. In this case, the measurement includes only the ranges that lie within the defined span and have a minimum span of 20 Hz.

Remote command:

[SENSe:] LIST:RANGe<range> [:FREQuency] :START on page 719

[SENSe:] LIST:RANGe<range> [:FREQuency] :STOP on page 719

**Filter Type**

Sets the filter type for this range.

For details on filter types, see [Chapter 7.5.1.6, "Which Data May Pass: Filter Types"](#), on page 364.

Remote command:

[\[SENSe:\]LIST:RANGe<range>:FILTer:TYPE](#) on page 718

### **RBW**

Sets the RBW value for this range.

For details on the RBW, see [Chapter 7.5.1.1, "Separating Signals by Selecting an Appropriate Resolution Bandwidth"](#), on page 361.

Remote command:

[\[SENSe:\]LIST:RANGe<range>:BANDwidth:RESolution](#) on page 716

### **VBW**

Sets the VBW value for this range.

For details on the VBW, see [Chapter 7.5.1.2, "Smoothing the Trace Using the Video Bandwidth"](#), on page 362.

Remote command:

[\[SENSe:\]LIST:RANGe<range>:BANDwidth:VIDeo](#) on page 717

### **Sweep Time Mode**

Activates or deactivates the auto mode for the sweep time.

For details on the sweep time mode, see [Chapter 7.5.1.7, "How Long the Data is Measured: Sweep Time "](#), on page 365

Remote command:

[\[SENSe:\]LIST:RANGe<range>:SWEep:TIME:AUTO](#) on page 722

### **Sweep Time**

Sets the sweep time value for the range.

For details on the sweep time, see [Chapter 7.5.1.7, "How Long the Data is Measured: Sweep Time "](#), on page 365

Remote command:

[\[SENSe:\]LIST:RANGe<range>:SWEep:TIME](#) on page 722

### **Detector**

Sets the detector for the range.

For details, refer to ["Mapping Samples to sweep Points with the Trace Detector"](#) on page 459.

Remote command:

[\[SENSe:\]LIST:RANGe<range>:DETector](#) on page 718

### **Reference Level**

Sets the reference level for the range.

For details on the reference level, see [Chapter 7.4.1.1, "Reference Level"](#), on page 352.

Remote command:

[\[SENSe:\] LIST:RANGe<range>:RLEVel](#) on page 722

### RF Attenuation Mode

Activates or deactivates the auto mode for RF attenuation.

For details on attenuation, see [Chapter 7.4.1.2, "RF Attenuation"](#), on page 353.

Remote command:

[\[SENSe:\] LIST:RANGe<range>:INPut:ATTenuation:AUTO](#) on page 720

### RF Attenuation

Sets the attenuation value for that range.

For details on attenuation, see [Chapter 7.4.1.2, "RF Attenuation"](#), on page 353.

Remote command:

[\[SENSe:\] LIST:RANGe<range>:INPut:ATTenuation](#) on page 720

### Sweep Points

Sets the number of sweep points for the specified range.

For details on sweep points, see [Chapter 7.5.1.8, "How Much Data is Measured: Sweep Points and Sweep Count"](#), on page 365.

Remote command:

[\[SENSe:\] LIST:RANGe<range>:POINts](#) on page 721

### Stop After Sweep

This command configures the sweep behavior.

"On"                    The R&S FPS stops after one range is swept and continues only if you confirm (a message box is displayed).

"Off"                   The R&S FPS sweeps all ranges in one go.

Remote command:

[\[SENSe:\] LIST:RANGe<range>:BREak](#) on page 717

### Transducer

Sets a transducer for the specified range. You can only choose a transducer that fulfills the following conditions:

- The transducer overlaps or equals the span of the range.
- The x-axis is linear.
- The unit is dB.

For details on transducers, see [Chapter 10.3.1, "Basics on Transducer Factors"](#), on page 546.

Remote command:

[\[SENSe:\] LIST:RANGe<range>:TRANsducer](#) on page 723

### Limit Check

Activates or deactivates the limit check for all ranges.

For details on limit checks, see [Chapter 6.6.3.2, "Limit Lines in Spurious Measurements"](#), on page 251.

"ABSOLUTE" Signal is checked against absolute limit values

"NONE" No limit check is performed.

Remote command:

[SENSe:]LIST:RANGe<range>:LIMit:STATe on page 721

CALCulate<n>:LIMit<k>:FAIL? on page 932

#### Abs Limit Start / Abs Limit Stop

Sets an absolute limit value at the start or stop frequency of the range [dBm].

Remote command:

[SENSe:]LIST:RANGe<range>:LIMit:START on page 720

[SENSe:]LIST:RANGe<range>:LIMit:STOP on page 721

#### Insert before Range / Insert after Range

Inserts a new range to the left of the currently focused range (before) or to the right (after). The range numbers of the currently focused range and all higher ranges are increased accordingly. The maximum number of ranges is 30.

#### Delete Range

Deletes the currently focused range. The range numbers are updated accordingly.

### 6.6.4.2 Adjusting the X-Axis to the Range Definitions

**Access:** "Overview" > "Select Measurement" > "Spurious Emissions" > "Adjust X-Axis"

The frequency axis of the measurement diagram can be adjusted automatically so that the span of all sweep list ranges corresponds to the displayed span. Thus, the x-axis range is set from the start frequency of the first sweep range to the stop frequency of the last sweep range.

### 6.6.4.3 List Evaluation

**Access:** "Overview" > "Select Measurement" > "Spurious Emissions" > "List Evaluation"

Configure the contents and display of the result list.



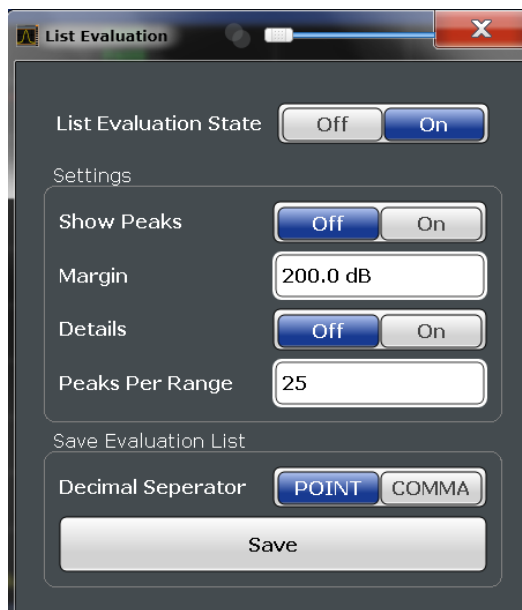

List Evaluation State ..... 257  
 Show Peaks ..... 257  
 Margin ..... 257  
 Details ..... 257  
 Peaks per Range ..... 258  
 Save Evaluation List ..... 258

**List Evaluation State**

Activates or deactivates the list evaluation.

Remote command:

[CALCulate<n>:ESpectrum:PEAKsearch:AUTO](#) on page 710  
[TRACe<n>\[:DATA\]](#) on page 854

**Show Peaks**

If activated, all peaks that have been detected during an active list evaluation are marked with blue squares in the diagram.

Remote command:

[CALCulate<n>:ESpectrum:PEAKsearch:PSHow](#) on page 711

**Margin**

A margin functionality is not available for the limit check. However, you can define a margin (=threshold) for the peak values to be displayed in the evaluation list. Only peaks that exceed the margin value are displayed (also in the diagram, if activated).

Remote command:

[CALCulate<n>:ESpectrum:PEAKsearch:MARGin](#) on page 711

**Details**

Configures how detailed the list in the Result Summary is.

|     |                                                                              |
|-----|------------------------------------------------------------------------------|
| On  | Includes all detected peaks (up to a maximum defined by "Peaks per Range" ). |
| Off | Includes only one peak per range.                                            |

Remote command:

[CALCulate<n>:ESpectrum:PEAKsearch:DEtails](#) on page 724

### Peaks per Range

Defines the maximum number of peaks per range that are stored in the list. Once the selected number of peaks has been reached, the peak search is stopped in the current range and continued in the next range. The maximum value is 50.

Remote command:

[CALCulate<n>:PEAKsearch:SUBRanges](#) on page 725

### Save Evaluation List

Exports the evaluation list of the Spurious Emissions measurement to an ASCII file for evaluation in an external application. If necessary, change the decimal separator for evaluation in other languages.

Define the file name and storage location in the file selection dialog box that is displayed when you select the "Save" function.

For details, see ["How to Save the Spurious Emissions Evaluation List"](#) on page 259.

Remote command:

[MMEMory:STORe<n>:LIST](#) on page 963

[FORMat:DEXPort:DSEParator](#) on page 937

## 6.6.5 How to Perform a Spurious Emissions Measurement

The following step-by-step instructions demonstrate how to perform spurious emissions measurements.



For remote operation, see [Chapter 12.5.7.6, "Programming Example: Spurious Emissions Measurement"](#), on page 726.

1. Press the MEAS key, then select the "Spurious Emissions" measurement.
2. Define the span of the signal to be monitored in the general span settings.
3. Select the "Overview" softkey, then select the "Spurious Setup" button.  
The "Spurious Emissions" dialog box is displayed.
4. Split the frequency span of the measurement into ranges for signal parts with similar characteristics.  
Define the required ranges in the "Sweep List" using the "Insert before Range" and "Insert after Range" buttons, which refer to the currently selected range.
5. Define the measurement parameters for each range as required.
6. Optionally, define a limit check.

- a) Activate the limit check by setting "Limit Check" to "ABSOLUTE" . The limit check is always activated or deactivated for all ranges simultaneously.
  - b) Define the limit line's start and stop values for each range of the signal. If a signal level higher than the defined limit is measured, the limit check fails, which may indicate a spurious emission.
7. Configure the peak detection during a Spurious Emissions measurement: select the "Evaluations" button in the "Overview" .
    - To indicate the determined peaks in the display, activate the "Show Peaks" option.
    - To restrict peak detection, define a "Margin" . Only peaks that exceed this value are detected.
    - To allow for more peaks per range to be detected than the default 1, increase the "Peaks per Range" value and set "Details" to "On" .
  8. Start a sweep.

The determined powers and limit deviations for each range are indicated in the evaluation list. If activated, the peak power levels for each range are also indicated in the diagram.
  9. To save the evaluation list, export the results to a file as described in ["How to Save the Spurious Emissions Evaluation List"](#) on page 259.

#### How to Save the Spurious Emissions Evaluation List

The evaluation list from a Spurious Emissions measurement can be saved to a file, which can be exported to another application for further analysis, for example.

1. Configure and perform a Spurious Emissions measurement as described in [Chapter 6.6.5, "How to Perform a Spurious Emissions Measurement"](#), on page 258.
2. Select the "Evaluations" button in the "Overview" .
3. If necessary, change the "Decimal Separator" to "COMMA" for evaluation in other languages.
4. Select the "Save" button.
5. In the file selection dialog box, select a storage location and file name for the result file.
6. Select the "Save" button.

The file with the specified name and the extension `.dat` is stored in the defined storage location.

#### 6.6.6 Reference: ASCII Export File Format (Spurious)

The file has a header containing important parameters for scaling, several data sections containing the sweep settings per range, and a data section containing the peak list.

The header data is made up of three columns, separated by ';', with the syntax:

Parameter name; numeric value; basic unit

| File contents                                     | Explanation                                   |
|---------------------------------------------------|-----------------------------------------------|
| <b>File header</b>                                |                                               |
| Type;FPS-13;                                      | Model                                         |
| Version;1.00;                                     | Firmware version                              |
| Date;31.Mar 11;                                   | Storage date of data set                      |
| Mode;ANALYZER; SPURIOUS;                          | Operating mode and measurement function       |
| Center Freq;13250000000.000000;Hz                 | X-axis settings                               |
| Freq Offset;0.000000;Hz                           |                                               |
| Span;26499982000.000000;Hz                        |                                               |
| x-Axis;LIN;                                       |                                               |
| Start;9000.000000;Hz<br>Stop;8000000000.000000;Hz |                                               |
| Level Offset;0.000000;dB                          | Y-axis settings                               |
| Ref Position;100.000000;%                         |                                               |
| y-Axis;LOG;                                       |                                               |
| Level Range;100.000000;dB                         |                                               |
| <b>Trace settings</b>                             |                                               |
| Trace Mode;CLR/WRITE;                             |                                               |
| Sweep Count;1;                                    |                                               |
| TRACE 1:                                          |                                               |
| Trace Mode;CLR/WRITE;                             |                                               |
| x-Unit;Hz;                                        |                                               |
| y-Unit;dBm;                                       |                                               |
| <b>List evaluation settings</b>                   |                                               |
| Margin;6.000000;s                                 | Peak List margin                              |
| PeaksPerRange;25;                                 | Max. number of peaks per range to be detected |
| Values;3;                                         | Number of detected peaks                      |

| File contents                                                                       | Explanation                                                                |
|-------------------------------------------------------------------------------------|----------------------------------------------------------------------------|
| <b>File data section</b>                                                            |                                                                            |
| 0;9000;150000;1000;79500;-25.006643295288086;-12.006643295288086;PASS;              | Measured peak values:                                                      |
| 0;9000;150000;1000;101022.11126961483;-47.075111389160156;-34.075111389160156;PASS; | <range number>;                                                            |
| 0;9000;150000;1000;58380.171184022824;-47.079341888427734;-34.079341888427734;PASS; | <start frequency>;                                                         |
|                                                                                     | <stop frequency>;                                                          |
|                                                                                     | <resolution bandwidth of range>;                                           |
|                                                                                     | <frequency of peak>;                                                       |
|                                                                                     | <absolute power in dBm of peak>;                                           |
|                                                                                     | <distance to the limit line in dB>; (positive value means above the limit) |
|                                                                                     | <limit fail (pass = 0, fail =1)>;                                          |

## 6.7 Statistical Measurements (APD, CCDF)

To measure the amplitude distribution, the R&S FPS has simple measurement functions to determine both the Amplitude Probability Distribution (APD) and the Complementary Cumulative Distribution Function (CCDF). Only one of the signal statistic functions can be switched on at a time.

- [About the Measurements](#)..... 261
- [Typical Applications](#)..... 262
- [APD and CCDF Results](#)..... 262
- [APD and CCDF Basics - Gated Triggering](#)..... 265
- [APD and CCDF Configuration](#)..... 266
- [How to Perform an APD or CCDF Measurement](#)..... 272
- [Examples](#)..... 273
- [Optimizing and Troubleshooting the Measurement](#)..... 276

### 6.7.1 About the Measurements

The probability of amplitude values can be measured with the Amplitude Probability Distribution function (APD). During a selectable measurement time all occurring amplitude values are assigned to an amplitude range. The number of amplitude values in the individual ranges is counted and the result is displayed as a histogram.

Alternatively, the Complementary Cumulative Distribution Function (CCDF) can be displayed. It shows the probability that the mean signal power amplitude will be exceeded in percent.

Only one of the signal statistic functions can be switched on at a time. When a statistic function is switched on, the R&S FPS is set into zero span mode automatically. The R&S FPS measures the statistics of the signal applied to the RF input with the defined analysis bandwidth. To avoid affecting the peak amplitudes the video bandwidth is automatically set to 10 times the analysis bandwidth. The sample detector is used for detecting the video voltage.

Statistic measurements on pulsed signals can be performed using a gated trigger. For details see [Chapter 6.7.4, "APD and CCDF Basics - Gated Triggering"](#), on page 265.

## 6.7.2 Typical Applications

Digital modulated signals are similar to white noise within the transmit channel, but are different in their amplitude distribution. In order to transmit the modulated signal without distortion, all amplitudes of the signal have to be transmitted linearly from the output power amplifier. Most critical are the peak amplitude values. Degradation in transmit quality caused by a transmitter two port network is dependent on the amplitude of the peak values as well as on their probability.

If modulation types are used that do not have a constant envelope in zero span, the transmitter has to handle peak amplitudes that are greater than the average power. This includes all modulation types that involve amplitude modulation, QPSK for example. CDMA transmission modes in particular may have power peaks that are large compared to the average power.

For signals of this kind, the transmitter must provide large reserves for the peak power to prevent signal compression and thus an increase of the bit error rate at the receiver. The peak power or the crest factor of a signal is therefore an important transmitter design criterion. The crest factor is defined as the peak power to mean power ratio or, logarithmically, as the peak level minus the average level of the signal. To reduce power consumption and cut costs, transmitters are not designed for the largest power that could ever occur, but for a power that has a specified probability of being exceeded (e.g. 0.01 %).

The statistical functions provide information on such signal criteria.

## 6.7.3 APD and CCDF Results

### Amplitude Probability Distribution (APD)

As a result of the Amplitude Probability Distribution (APD) function, the probability of measured amplitude values is displayed. During a selectable measurement time all measured amplitude values are assigned to an amplitude range (*bin*). The number of amplitude values in the individual ranges is counted and the result is displayed as a histogram. Each bar of the histogram represents the percentage of measured amplitudes within the specific amplitude range. The x-axis represents the amplitude values and is scaled in absolute values (dBm).



The size of each amplitude range (bin) determines the resolution of the histogram and is indicated in the channel bar, for example / 0.10 dB. In this case, a single bar in the histogram represents an amplitude range of 0.10 dB.

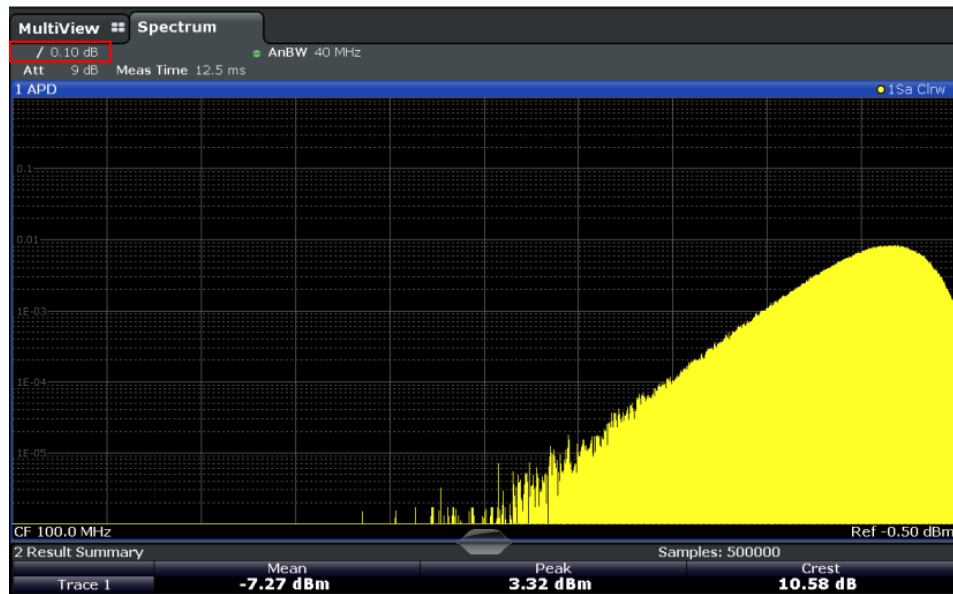

In addition to the histogram, a result table is displayed containing the following information:

- Number of samples used for calculation
- For each displayed trace:
  - Mean amplitude
  - Peak amplitude
  - Crest factor

The crest factor is defined as the peak power to mean power ratio or, logarithmically, as the peak level minus the average level of the signal.

### Complementary Cumulative Distribution Function (CCDF)

The Complementary Cumulative Distribution Function (CCDF) shows the probability that the mean signal power amplitude will be exceeded in percent. The level above the mean power is plotted along the x-axis of the graph. The origin of the axis corresponds to the mean power level. The probability that a level will be exceeded is plotted along the y-axis.

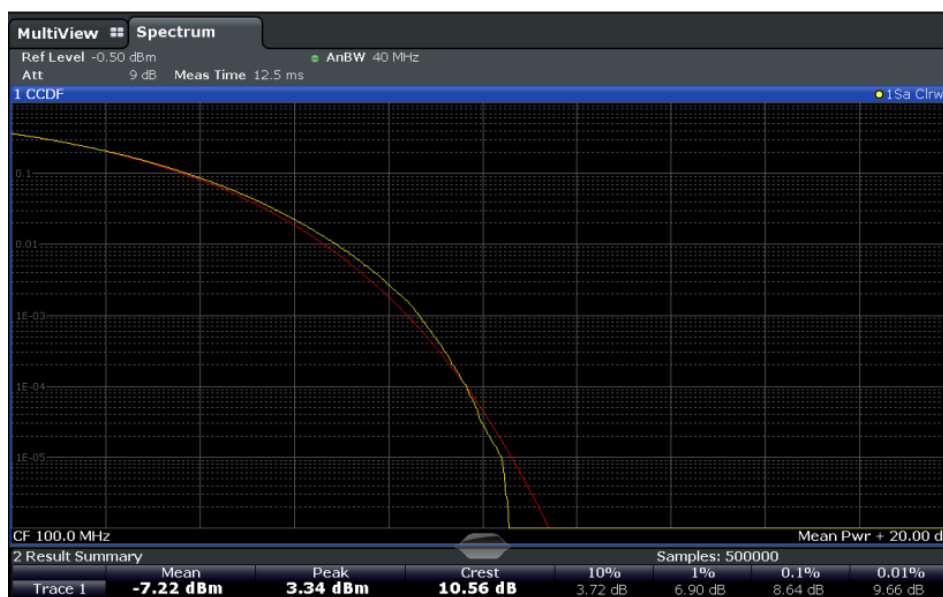

A red line indicates the ideal Gaussian distribution for the measured amplitude range.

The displayed amplitude range is indicated as "Mean Pwr" + "<x dB>"

In addition to the histogram, a result table is displayed containing the following information:

- Number of samples used for calculation
- For each displayed trace:

|        |                                           |
|--------|-------------------------------------------|
| Mean   | Mean power                                |
| Peak   | Peak power                                |
| Crest  | Crest factor (peak power – mean power)    |
| 10 %   | Level values over 10 % above mean power   |
| 1 %    | Level values over 1 % above mean power    |
| 0,1 %  | Level values over 0,1 % above mean power  |
| 0,01 % | Level values over 0,01 % above mean power |

### Percent marker

In addition to the results for specific percentages in the table, a percent marker can be activated for a freely selectable percentage. This marker indicates how many level values are over <x> % above the mean power.





### Percent marker

As all markers, the percent marker can be moved simply by selecting it with a finger or mouse cursor and dragging it to the desired position.

### Diagram Scaling

The scaling for both the x-axis and y-axis of the statistics diagram can be configured. In particular, you can restrict the range of amplitudes to be evaluated and the probabilities to be displayed.

### Remote commands:

`CALCulate<n>:STATistics:CCDF:X<t>?` on page 735

`CALCulate<n>:STATistics:RESult<t>?` on page 736

## 6.7.4 APD and CCDF Basics - Gated Triggering

Statistic measurements on pulsed signals can be performed using a gated trigger. An external frame trigger is required as a time (frame) reference.

The gate ranges define the part of the measured data taken into account for the statistics calculation. These ranges are defined relative to a reference point  $T=0$ . The gate interval is repeated for each period until the end of the capture buffer.

The reference point  $T=0$  is defined by the external trigger event and the instrument's trigger offset.

For each trace you can define up to 3 separate ranges of a single period to be traced.

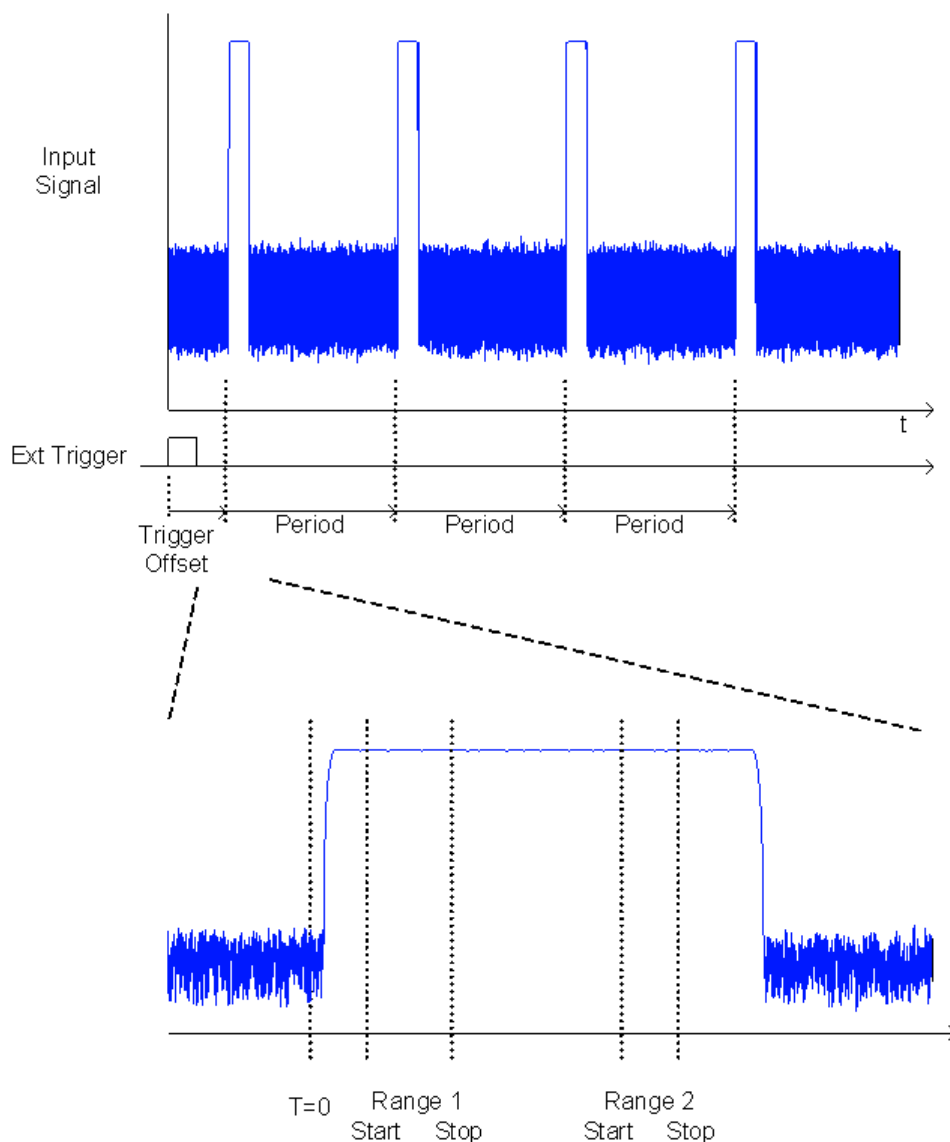

### 6.7.5 APD and CCDF Configuration

Configuration consists of the following settings:

- [Basic Settings](#)..... 266
- [Gate Range Definition for APD and CCDF](#) ..... 268
- [Scaling for Statistics Diagrams](#)..... 270

#### 6.7.5.1 Basic Settings

**Access:** "Overview" > "Select Measurement" > "APD" / "CCDF" > "APD Config" / "CCDF Config"

The remote commands required to perform these tasks are described in [Chapter 12.5.8, "Analyzing Statistics \(APD, CCDF\)"](#), on page 728.

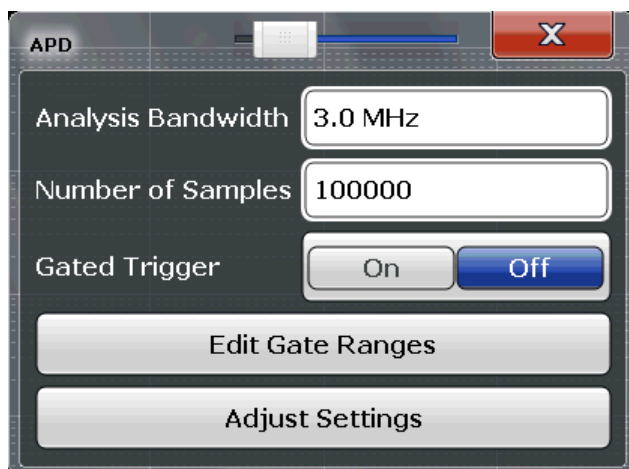

Both dialog boxes are identical except for the "Percent Marker" setting, which is only available for CCDF measurements.

|                                                  |     |
|--------------------------------------------------|-----|
| <a href="#">Percent Marker (CCDF only)</a> ..... | 267 |
| <a href="#">Analysis Bandwidth</a> .....         | 267 |
| <a href="#">Number of Samples</a> .....          | 267 |
| <a href="#">Gated Trigger</a> .....              | 268 |
| <a href="#">Edit Gate Ranges</a> .....           | 268 |
| <a href="#">Adjust Settings</a> .....            | 268 |

#### Percent Marker (CCDF only)

Defines a probability value. Thus, the power which is exceeded with a given probability can be determined very easily. If marker 1 is deactivated, it is switched on automatically.

Remote command:

[CALCulate<n>:MARKer<m>:Y:PERCent](#) on page 729

#### Analysis Bandwidth

Defines the analysis bandwidth.

For correct measurement of the signal statistics, the analysis bandwidth has to be wider than the signal bandwidth in order to measure the peaks of the signal amplitude correctly. To avoid influencing the peak amplitudes, the video bandwidth is automatically set to 10 MHz. The sample detector is used for detecting the video voltage.

The calculated measurement time is displayed for reference only.

Remote command:

[\[SENSe:\]BANDwidth\[:RESolution\]](#) on page 785

#### Number of Samples

Defines the number of power measurements that are taken into account for the statistics.

For statistics measurements with the R&S FPS, the number of samples to be measured is defined instead of the sweep time. Since only statistically independent samples contribute to statistics, the sweep or measurement time is calculated automatically and displayed in the channel bar ( "Meas Time" ). The samples are statistically independent if the time difference is at least 1/RBW. The measurement time is, therefore, expressed as follows:

$$\text{Meas Time} = N_{\text{Samples}}/\text{RBW}$$

Remote command:

[CALCulate<n>:STATistics:NSAMples](#) on page 729

### Gated Trigger

Activates and deactivates gating for statistics functions for the ACP and the CCDF measurements. If activated, the trigger source is changed to "External Trigger 1" . The gate ranges are defined using the [Edit Gate Ranges](#) function.

Remote command:

[\[SENSe:\]SWEep:EGATe:TRACe<t>\[:STATe<range>\]](#) on page 731

### Edit Gate Ranges

Opens a dialog box to configure up to 3 gate ranges for each trace. For details see [Chapter 6.7.5.2, "Gate Range Definition for APD and CCDF"](#), on page 268.

### Adjust Settings

Adjusts the level settings according to the measured difference between peak and minimum power for APD measurement or peak and mean power for CCDF measurement in order to obtain maximum power resolution. Adjusts the reference level to the current input signal.

Remote command:

[CALCulate<n>:STATistics:SCALE:AUTO ONCE](#) on page 733

## 6.7.5.2 Gate Range Definition for APD and CCDF

**Access:** "Overview" > "Select Measurement" > "APD" / "CCDF" > "APD Config" / "CCDF Config" > "Edit Gate Ranges"

You can configure gate ranges for gated triggering in statistical measurements.

For background information on defining gate ranges see [Chapter 6.7.4, "APD and CCDF Basics - Gated Triggering"](#), on page 265.

The remote commands required to perform these tasks are described in [Chapter 12.5.8.3, "Using Gate Ranges for Statistical Measurements"](#), on page 730.

|               | Trace 1 | Trace 2 | Trace 3 | Trace 4 | Trace 5 | Trace 6 |
|---------------|---------|---------|---------|---------|---------|---------|
| Comment       |         |         |         |         |         |         |
| Period        | 2 ms    | 2 ms    | 2 ms    | 2 ms    | 2 ms    | 2 ms    |
| Range 1 Use   | On      | Off     | Off     | Off     | Off     | Off     |
| Range 1 Start | 0 s     | 0 s     | 0 s     | 0 s     | 0 s     | 0 s     |
| Range 1 Stop  | 1 ms    | 1 ms    | 1 ms    | 1 ms    | 1 ms    | 1 ms    |
| Range 2 Use   | Off     | Off     | Off     | Off     | Off     | Off     |
| Range 2 Start | 2 ms    | 2 ms    | 2 ms    | 2 ms    | 2 ms    | 2 ms    |
| Range 2 Stop  | 3 ms    | 3 ms    | 3 ms    | 3 ms    | 3 ms    | 3 ms    |
| Range 3 Use   | Off     | Off     | Off     | Off     | Off     | Off     |
| Range 3 Start | 4 ms    | 4 ms    | 4 ms    | 4 ms    | 4 ms    | 4 ms    |
| Range 3 Stop  | 5 ms    | 5 ms    | 5 ms    | 5 ms    | 5 ms    | 5 ms    |

Up to three ranges can be defined for each of the six available traces.

Comment .....269  
 Period .....269  
 Range <x> Use .....269  
 Range <x> Start/Stop .....269

**Comment**

An optional comment can be defined for the gate range settings of each trace.

Remote command:

```
[SENSe:] SWEep:EGATe:TRACe<t>:COMMeNt on page 730
```

**Period**

Length of the period to be traced. The period is the same for all traces. If you change the period for one trace, it is automatically changed for all traces.

Make sure the defined period is not longer than the total measurement time of the current measurement. Keep in mind that the measurement time depends on the bandwidth and the number of samples (see "Number of Samples" on page 267). The current measurement time is indicated as "Meas Time" in the channel bar.

Remote command:

```
[SENSe:] SWEep:EGATe:TRACe:PERIoD on page 730
```

**Range <x> Use**

Activates tracing of the defined range during a gated measurement.

Remote command:

```
[SENSe:] SWEep:EGATe:TRACe<t>[:STATe<range>] on page 731
```

**Range <x> Start/Stop**

Defines the start and stop points of the range within the tracing period. Make sure the value for the stopping time is smaller than the length of the period.

**Note:** You can define the time values with a greater numerical resolution than is displayed; the values are only rounded for display.

Remote command:

[SENSe:] SWEep:EGATe:TRACe<t>:START<range> on page 730

[SENSe:] SWEep:EGATe:TRACe<t>:STOP<range> on page 731

### 6.7.5.3 Scaling for Statistics Diagrams

**Access:** "Overview" > "Amplitude" > "Scale" tab

**Or:** AMPT > "Scale Config"

For statistics displays, scale settings are available for both the y-axis and the x-axis.

The remote commands required to perform these tasks are described in [Chapter 12.5.8.4, "Scaling the Diagram"](#), on page 732.

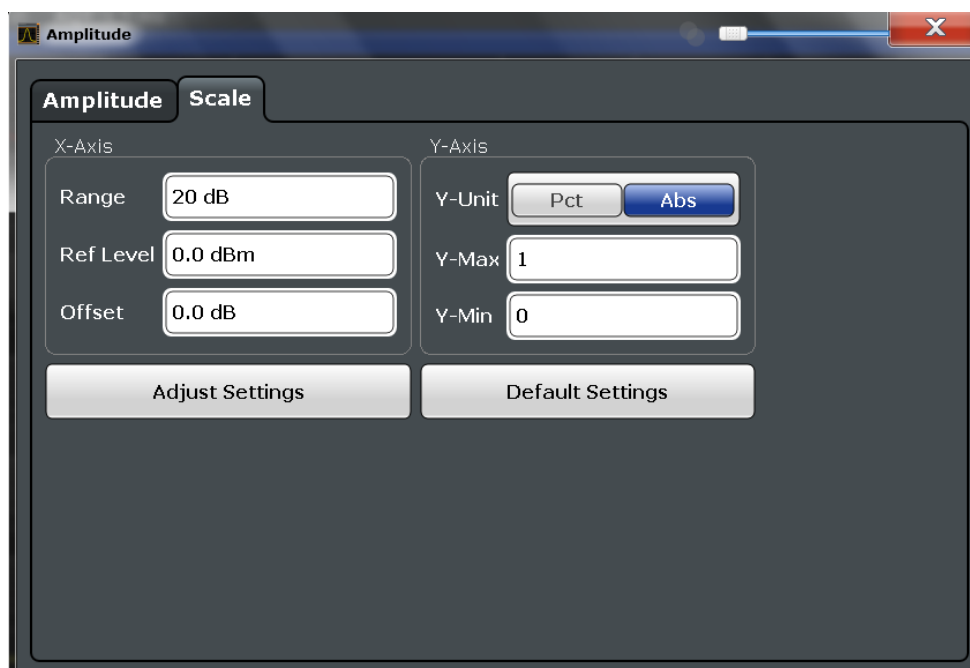

Figure 6-39: Scale settings for CCDF diagram



In statistical diagrams, the x-axis displays the signal level values (= y-axis in standard display), while the y-axis displays the probability of the values.

|                                         |     |
|-----------------------------------------|-----|
| X-Axis .....                            | 271 |
| L Ref Level .....                       | 271 |
| L Range .....                           | 271 |
| L Shifting the Display ( Offset ) ..... | 271 |
| Y-Axis .....                            | 271 |
| L Y-Unit .....                          | 271 |
| L Y-Max / Y-Min .....                   | 271 |
| Default Settings .....                  | 271 |
| Adjust Settings .....                   | 272 |

**X-Axis**

Defines the scaling settings for signal level values.

**Ref Level ← X-Axis**

Defines the reference level for the signal levels in the currently active unit (dBm, dBμV, etc.).

For the APD function this value corresponds to the right diagram border. For the CCDF function there is no direct representation of this value on the diagram as the x-axis is scaled relatively to the measured mean power.

Remote command:

[CALCulate<n>:STATistics:SCALE:X:RLEVel](#) on page 733

**Range ← X-Axis**

Defines the level range in dB to be evaluated by the statistics measurement.

Remote command:

[CALCulate<n>:STATistics:SCALE:X:RANGE](#) on page 733

**Shifting the Display ( Offset ) ← X-Axis**

Defines an arithmetic level offset. This offset is added to the measured level irrespective of the selected unit. The scaling of the x-axis is changed accordingly. The setting range is ±200 dB in 0.1 dB steps.

Remote command:

[DISPlay\[:WINDow<n>\]:TRACe<t>:Y\[:SCALE\]:RLEVel:OFFSet](#) on page 793

**Y-Axis**

Defines the scaling settings for the probability distribution.

**Y-Unit ← Y-Axis**

Defines the scaling type of the y-axis as either percentage or absolute. The default value is absolute scaling.

Remote command:

[CALCulate<n>:STATistics:SCALE:Y:UNIT](#) on page 734

**Y-Max / Y-Min ← Y-Axis**

Defines the upper (max) and lower (min) limit of the displayed probability range. Values on the y-axis are normalized which means that the maximum value is 1.0. The minimum value must be in the range:

$$1E-9 < Y\text{-Min} < 0.1$$

The distance between "Y-Max" and "Y-Min" must be at least one decade.

Remote command:

[CALCulate<n>:STATistics:SCALE:Y:UPPer](#) on page 734

[CALCulate<n>:STATistics:SCALE:Y:LOWer](#) on page 734

**Default Settings**

Resets the x- and y-axis scalings to their preset values.

|                     |         |
|---------------------|---------|
| X-axis ref level:   | -10 dBm |
| X-axis range APD:   | 100 dB  |
| X-axis range CCDF:  | 20 dB   |
| Y-axis upper limit: | 1.0     |
| Y-axis lower limit: | 1E-6    |

Remote command:

[CALCulate<n>:STATistics:PRESet](#) on page 732

### Adjust Settings

Adjusts the level settings according to the measured difference between peak and minimum power for APD measurement or peak and mean power for CCDF measurement in order to obtain maximum power resolution. Adjusts the reference level to the current input signal.

Remote command:

[CALCulate<n>:STATistics:SCALE:AUTO ONCE](#) on page 733

## 6.7.6 How to Perform an APD or CCDF Measurement

The following step-by-step instructions demonstrate how to perform basic statistic measurements.



For remote operation, see [Chapter 12.5.8.7, "Programming Example: Measuring Statistics"](#), on page 736.

### To start a basic statistic measurement

1. Press the MEAS key, then select the "APD" or "CCDF" measurement.
2. Start a sweep.

As soon as the defined number of samples have been measured, the statistical evaluation is displayed.

### To perform a statistic measurement using gate ranges

For pulsed signals, the transmission intervals should not be included in the statistical evaluation. Thus, you must define gate ranges to be included in the measurement.

1. Press the MEAS CONFIG key, then select the "APD Config" or "CCDF Config" softkey.  
The "APD" "APD" or "CCDF" dialog box is displayed.
2. Select the "Edit Gate Ranges" button.
3. Define the time period for which the input signal is to be analyzed, for example the duration of 3 signal pulses.



4. For each active trace, define up to three ranges within the time period to be measured. In the example covering 3 pulses, you could define one range for each pulse.
  - a) Assuming the external trigger determines  $T=0$  as the start of the first pulse, define the start time of range 1 at 0 s.
  - b) Define the stop time of range 1 at the duration of the first pulse.
  - c) Activate range 1 by setting "Range 1 Use" to *On*.
  - d) Define the start time of range 2 as (duration of pulse 1 + duration of interval)
  - e) Define the stop time of range 2 as (start time of range 2 + duration of pulse 2)
  - f) Activate range 2 by setting "Range 2 Use" to *On*.
  - g) Define the third range in the same way.
5. Start a sweep.

As soon as the defined number of samples have been measured, the statistical evaluation is displayed. Only the signal levels within the pulse periods are considered.

## 6.7.7 Examples

### 6.7.7.1 Configuration Example: Gated Statistics

A statistics evaluation has to be done over the useful part of the signal between  $t_3$  and  $t_4$ . The period of the GSM signal is 4.61536 ms.

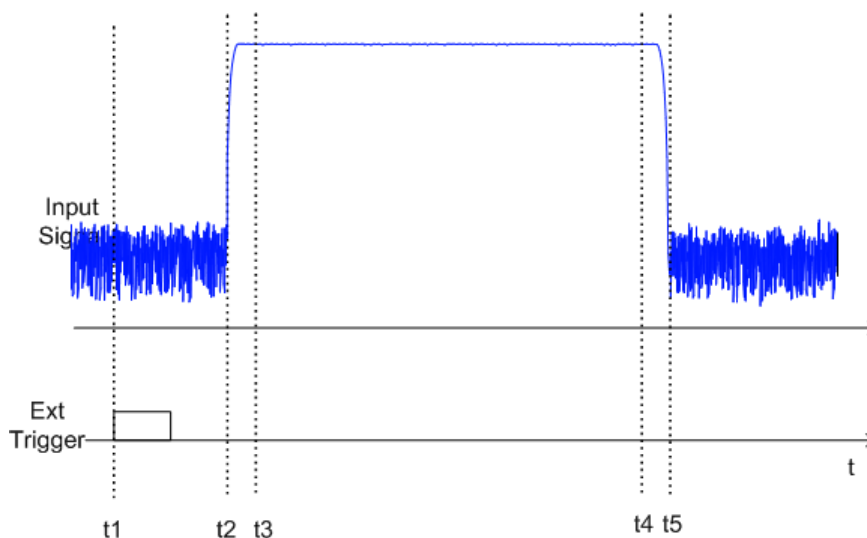

- $t_1$ : External positive trigger slope
- $t_2$ : Begin of burst (after 25  $\mu$ s)
- $t_3$ : Begin of useful part, to be used for statistics (after 40  $\mu$ s)
- $t_4$ : End of useful part, to be used for statistics (after 578  $\mu$ s)

t5: End of burst (after 602  $\mu$ s)

The instrument has to be configured as follows:

|                |                             |                                        |
|----------------|-----------------------------|----------------------------------------|
| Trigger Offset | $t2 - t1 = 25 \mu\text{s}$  | now the gate ranges are relative to t2 |
| Range1 Start   | $t3 - t2 = 15 \mu\text{s}$  | start of range 1 relative to t2        |
| Range1 End     | $t4 - t2 = 553 \mu\text{s}$ | end of range 1 relative to t2          |

### 6.7.7.2 Measurement Example – Measuring the APD and CCDF of White Noise Generated by the R&S FPS



#### Setting the RBW

When the amplitude distribution is measured, the analysis bandwidth must be set so that the complete spectrum of the signal to be measured falls within the bandwidth. This is the only way of ensuring that all the amplitudes will pass through the IF filter without being distorted. If the selected bandwidth is too small for a digitally modulated signal, the amplitude distribution at the output of the IF filter becomes a Gaussian distribution according to the central limit theorem and thus corresponds to a white noise signal. The true amplitude distribution of the signal therefore cannot be determined.



A programming example demonstrating a statistics measurement in a remote environment is provided in [Chapter 12.5.8.7, "Programming Example: Measuring Statistics"](#), on page 736.

1. Preset the R&S FPS.
2. Set the reference level to  $-60 \text{ dBm}$ .  
The R&S FPS's intrinsic noise is displayed at the top of the screen.
3. Select the "APD" measurement function from the "Select Measurement" dialog box.  
The R&S FPS sets the frequency span to 0 Hz and measures the amplitude probability distribution (APD). The number of uncorrelated level measurements used for the measurement is 100000. The mean power and the peak power are displayed in dBm. The crest factor (peak power – mean power) is output as well.

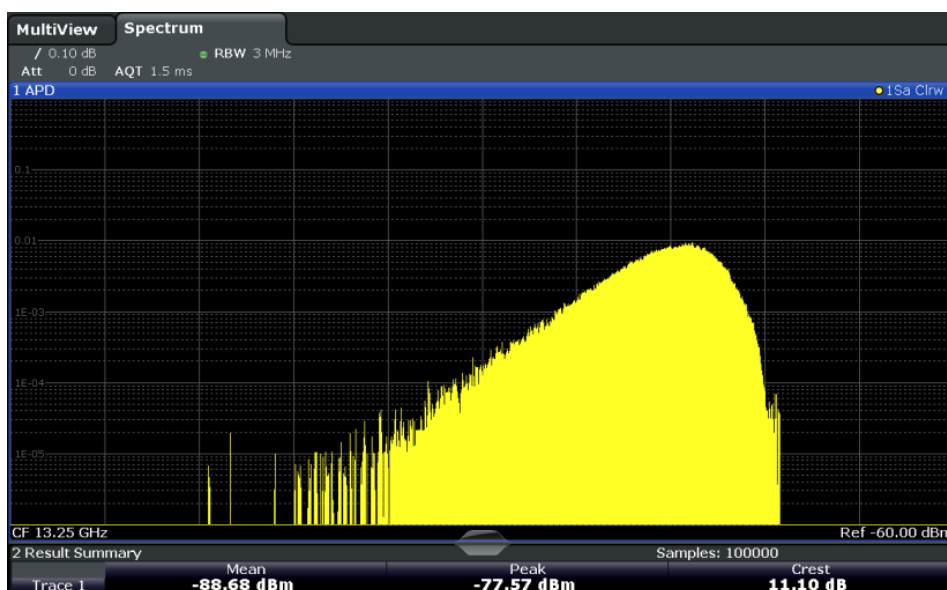

Figure 6-40: Amplitude probability distribution of white noise

- Now select the "CCDF" measurement function from the "Select Measurement" dialog box.

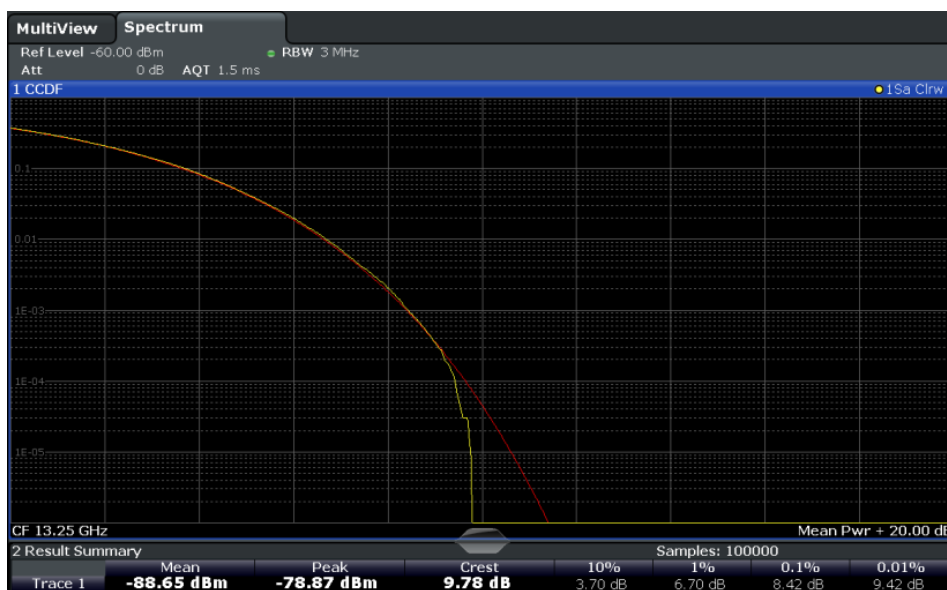

Figure 6-41: CCDF of white noise

The CCDF trace indicates the probability that a level will exceed the mean power. The level above the mean power is plotted along the x-axis of the graph. The origin of the axis corresponds to the mean power level. The probability that a level will be exceeded is plotted along the y-axis.

### 6.7.8 Optimizing and Troubleshooting the Measurement

If the results do not meet your expectations, try the following methods to optimize the measurement:

- Make sure the defined bandwidth is wide enough for the signal bandwidth of the device under test to be fully analyzed (see " [Analysis Bandwidth](#) " on page 267).
- If the complete signal is to be measured, increase the number of samples so that the resulting measurement time is longer than one period of a bursted signal.
- If only parts of the signal are to be examined, define a trigger source and a gate.

## 6.8 Time Domain Power Measurement

The Time Domain Power measurement determines the power of a signal in the time domain.

A time domain power measurement is only possible for zero span.

- [About the Measurement](#).....276
- [Time Domain Power Results](#).....276
- [Time Domain Power Basics - Range Definition Using Limit Lines](#).....277
- [Time Domain Power Configuration](#).....278
- [How to Measure Powers in the Time Domain](#).....279
- [Measurement Example](#).....279

### 6.8.1 About the Measurement

Using the Time Domain Power measurement function, the R&S FPS determines the power of the signal in zero span by summing up the power at the individual measurement points and dividing the result by the number of measurement points. Thus it is possible to measure the power of TDMA signals during transmission, for example, or during the muting phase. Both the mean power and the RMS power can be measured.

For this measurement, the sample detector is activated.

### 6.8.2 Time Domain Power Results

Several different power results can be determined simultaneously:

| Mode | Description                                                             |
|------|-------------------------------------------------------------------------|
| Peak | Peak value from the points of the displayed trace or a segment thereof. |
| RMS  | RMS value from the points of the displayed trace or a segment thereof.  |

| Mode    | Description                                                                                                                                                                                             |
|---------|---------------------------------------------------------------------------------------------------------------------------------------------------------------------------------------------------------|
| Mean    | Mean value from the points of the displayed trace or a segment thereof. The linear mean value of the equivalent voltages is calculated.<br><br>For example to measure the mean power during a GSM burst |
| Std Dev | The standard deviation of the measurement points from the mean value.                                                                                                                                   |

The result is displayed in the marker results, indicated by "Power" and the selected power mode, e.g. "RMS" . The measured values are updated after each sweep or averaged over a user-defined number of sweeps (trace averaging).

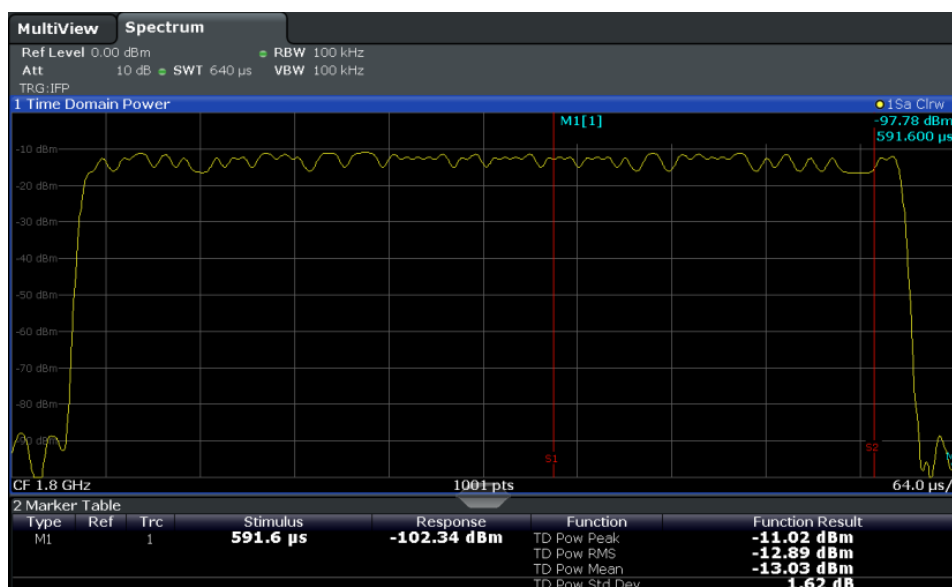

The results can also be queried using the remote commands described in [Chapter 12.5.9, "Measuring the Time Domain Power"](#), on page 738.

### 6.8.3 Time Domain Power Basics - Range Definition Using Limit Lines

The range of the measured signal to be evaluated for the power measurement can be restricted using limit lines. The left and right limit lines (S1, S2) define the evaluation range and are indicated by vertical red lines in the diagram. If activated, the power results are only calculated from the levels within the limit lines.

For example, if both the on and off phase of a burst signal are displayed, the measurement range can be limited to the transmission or to the muting phase. The ratio between signal and noise power of a TDMA signal for instance can be measured by using a measurement as a reference value and then varying the measurement range.



In order to get stable measurement results for a limited evaluation range, usually a trigger is required.

## 6.8.4 Time Domain Power Configuration

**Access:** "Overview" > "Select Measurement" > "Time Domain Power" > "Time Dom Power Config"

The remote commands required to perform these tasks are described in [Chapter 12.5.9, "Measuring the Time Domain Power"](#), on page 738.

|                                                |     |
|------------------------------------------------|-----|
| <a href="#">Results</a> .....                  | 278 |
| <a href="#">Limit State</a> .....              | 278 |
| <a href="#">Left Limit / Right Limit</a> ..... | 278 |

### Results

Activates the power results to be evaluated from the displayed trace or a limited area of the trace.

|           |                                                                                                                                                           |
|-----------|-----------------------------------------------------------------------------------------------------------------------------------------------------------|
| "Peak"    | Peak power over several measurements (uses trace averaging, Max Hold)                                                                                     |
| "RMS"     | RMS value from the points of the displayed trace or a segment thereof.                                                                                    |
| "Mean"    | Mean value from the points of the displayed trace or a segment thereof. The linear mean value of the equivalent voltages is calculated.                   |
| "Std Dev" | The standard deviation of the measurement points from the mean value.<br>The measurement of the mean power is automatically switched on at the same time. |

Remote command:

[CALCulate<n>:MARKer<m>:FUNCTION:SUMMARY:PPEak\[:STATe\]](#) on page 741  
[CALCulate<n>:MARKer<m>:FUNCTION:SUMMARY:PPEak:RESult?](#) on page 744  
[CALCulate<n>:MARKer<m>:FUNCTION:SUMMARY:RMS\[:STATe\]](#) on page 741  
[CALCulate<n>:MARKer<m>:FUNCTION:SUMMARY:RMS:RESult?](#) on page 745  
[CALCulate<n>:MARKer<m>:FUNCTION:SUMMARY:MEAN\[:STATe\]](#) on page 740  
[CALCulate<n>:MARKer<m>:FUNCTION:SUMMARY:MEAN:RESult?](#) on page 743

### Limit State

Switches the limitation of the evaluation range on or off. Default setting is off.

If deactivated, the entire sweep time is evaluated. If switched on, the evaluation range is defined by the left and right limit. If only one limit is set, it corresponds to the left limit and the right limit is defined by the stop frequency. If the second limit is also set, it defines the right limit.

Remote command:

[CALCulate<n>:MARKer<m>:X:SLIMits\[:STATe\]](#) on page 870

### Left Limit / Right Limit

Defines a power level limit for line S1 (left) or S2 (right).

Remote command:

[CALCulate<n>:MARKer<m>:X:SLIMits:LEFT](#) on page 871  
[CALCulate<n>:MARKer<m>:X:SLIMits:RIGHT](#) on page 871

### 6.8.5 How to Measure Powers in the Time Domain

The step-by-step procedure to measure powers in the time domain is described here in detail.



For remote operation, see [Chapter 12.5.9.4, "Programming Example: Time Domain Power"](#), on page 747.

#### To measure the power in the time domain

1. Select the "Time Domain Power" measurement function from the "Select Measurement" dialog box.
2. Select the type of power measurement results to be determined by selecting the corresponding softkeys.
3. To restrict the power evaluation range, define limits:
  - a) Select the "Time Dom Power Config" softkey to display the "Time Domain Power" configuration dialog box.
  - b) Switch on the limits by setting the "Limit State" to "On" .  
The limit lines S1 and S2 are displayed.
  - c) Define the left limit (limit line S1), the right limit (S2), or both.
4. Start a sweep.

The measured powers are displayed in the marker results.

### 6.8.6 Measurement Example

This measurement example demonstrates the time domain power calculation for a GSM burst.

#### Test setup:

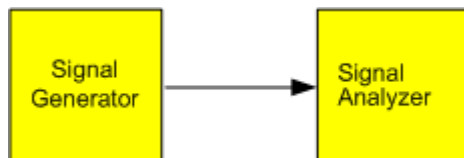

#### Signal generator settings (e.g. R&S FPS SMW):

|             |          |
|-------------|----------|
| Frequency:  | 1.8 GHz  |
| Level:      | -10 dBm  |
| Modulation: | GSM/EDGE |

#### Procedure:

1. Preset the R&S FPS.

2. Set the center frequency to *1.8 GHz*.
3. Set the RBW to *100 kHz*.
4. Set the sweep time to *640 μs*.
5. Set the trigger source to "IF Power" .
6. Define a trigger offset of *-50 μs*.
7. Select the "Time Domain Power" measurement function from the "Select Measurement" dialog box.
8. In the Time Domain Power configuration dialog box, set all four results to "On" .
9. Set the "Limit State" to "On" .
10. Define the left limit at *326 μs* and the right limit at *538 μs*.  
This range corresponds to the useful part of the GSM burst.

The mean power of the useful part of the GSM burst is calculated to be *-13 dBm*.

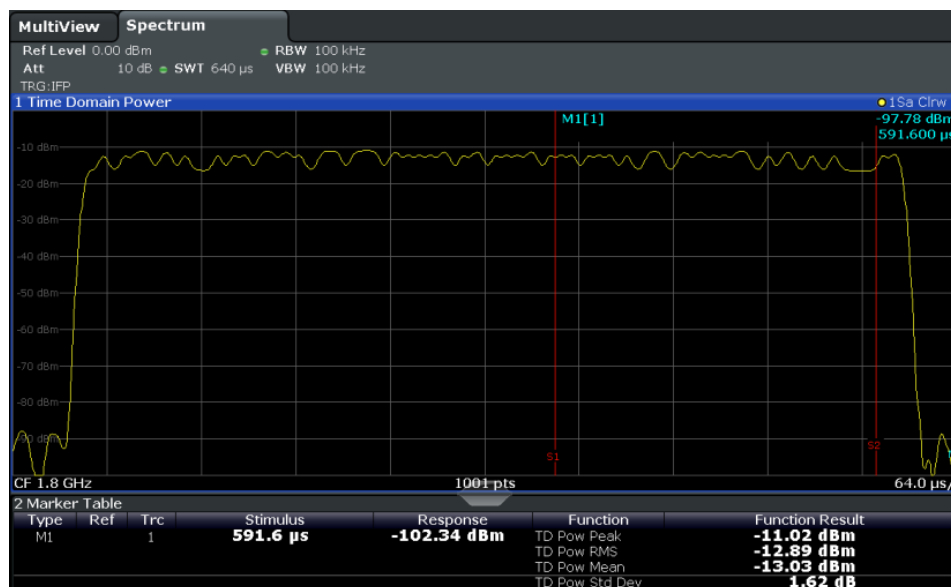

## 6.9 Harmonic Distortion Measurement

The "Harmonic Distortion" measurement measures harmonics and their distortion, including the total harmonic distortion.

- [About the Measurement](#).....281
- [Harmonic Distortion Basics](#).....281
- [Harmonic Distortion Results](#).....283
- [Harmonic Distortion Configuration](#).....284
- [How to Determine the Harmonic Distortion](#).....286



### 6.9.1 About the Measurement

With this measurement it is possible to measure the harmonics easily, for example from a VCO. In addition, the total harmonic distortion (THD) is calculated.

For measurements in the frequency domain, the Harmonic Distortion measurement starts with an automatic search for the first harmonic (= peak) within the set frequency range. The center frequency is set to this frequency and the reference level is adjusted accordingly.

For measurements in zero span, the center frequency remains unchanged.

The Harmonic Distortion measurement then performs zero span sweeps at the center frequency and at each harmonic, i.e. at frequencies that are a multiple of the center frequency.

As a result, the zero span sweeps on all harmonics are shown, as well as the RMS values and the total harmonic distortion (THD).



An application note discussing harmonics measurement is available from the Rohde & Schwarz website:

[1EF78: Measurement of Harmonics using Spectrum Analyzers](#)

---

### 6.9.2 Harmonic Distortion Basics

Measuring the harmonics of a signal is a frequent problem which can be solved best using a signal analyzer. In general, every signal contains harmonics. Harmonics are generated by nonlinear characteristics, which add frequencies to a pure sinewave. They can often be reduced by low pass filters. Since the signal analyzer itself has a nonlinear characteristic, for example in its first mixer, measures must be taken to ensure that harmonics produced in the signal analyzer do not cause spurious results. If necessary, the fundamental wave must be attenuated selectively with respect to the other harmonics with a high pass filter. Harmonics are particularly critical regarding high-power transmitters such as transceivers because large harmonics can interfere with other radio services.

Harmonic distortion can be determined as the level of the individual components, or as the root mean square of all components together, the total harmonic distortion (THD). The THD is set in relation to the power of the fundamental frequency (= center frequency).

#### Obtainable dynamic range

When harmonics are being measured, the obtainable dynamic range depends on the second harmonic intercept of the signal analyzer. The second harmonic intercept is the virtual input level at the RF input mixer at which the level of the 2nd harmonic becomes equal to the level of the fundamental wave. In practice, however, applying a level of this magnitude would damage the mixer. Nevertheless the available dynamic range for measuring the harmonic distance of a DUT can be calculated relatively easily using the second harmonic intercept.

As shown in Figure 6-42, the level of the 2<sup>nd</sup> harmonic drops by 20 dB if the level of the fundamental wave is reduced by 10 dB.

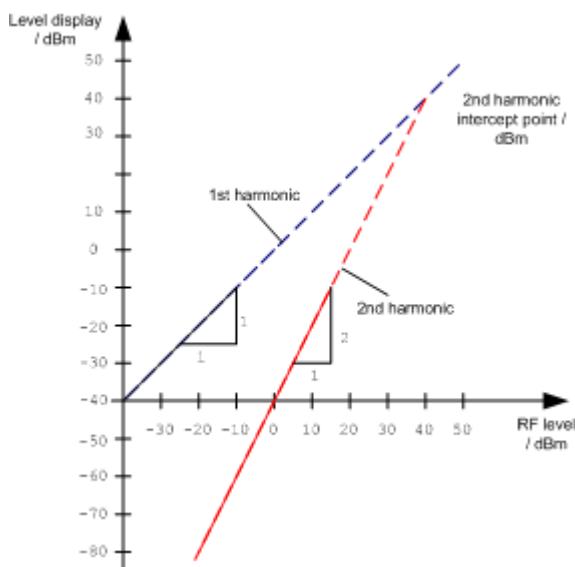

Figure 6-42: Extrapolation of the 1st and 2nd harmonics to the 2nd harmonic intercept at 40 dBm

The following formula for the obtainable harmonic distortion  $d_2$  in dB is derived from the straight-line equations and the given intercept point:

$$d_2 = \text{S.H.I} - P_1 \quad (1)$$

where:

|        |   |                           |
|--------|---|---------------------------|
| $d_2$  | = | harmonic distortion       |
| S.H.I. | = | second harmonic intercept |
| $P_1$  | = | mixer level/dBm           |



The mixer level is the RF level applied to the RF input minus the set RF attenuation.

The formula for the internally generated level  $P_1$  at the 2<sup>nd</sup> harmonic in dBm is:

$$P_1 = 2 * P_1 - \text{S.H.I.} \quad (2)$$

The lower measurement limit for the harmonic is the noise floor of the signal analyzer. The harmonic of the measured DUT should – if sufficiently averaged by means of a video filter – be at least 4 dB above the noise floor so that the measurement error due to the input noise is less than 1 dB.

**Rules for measuring high harmonic ratios**

The following rules for measuring high harmonic ratios can be derived:

- Select the smallest possible IF bandwidth for a minimal noise floor.

- Select an RF attenuation which is high enough to measure the harmonic ratio only.

The maximum harmonic distortion is obtained if the level of the harmonic equals the intrinsic noise level of the receiver. The level applied to the mixer, according to (2), is:

$$P_I = \frac{P_{noise} / dBm + IP2}{2}$$

At a resolution bandwidth of 10 Hz (noise level -143 dBm, S.H.I. = 40 dBm), the optimum mixer level is – 51.5 dBm. According to (1) a maximum measurable harmonic distortion of 91.5 dB minus a minimum S/N ratio of 4 dB is obtained.



### Detecting the origin of harmonics

If the harmonic emerges from noise sufficiently (approx. >15 dB), it is easy to check (by changing the RF attenuation) whether the harmonics originate from the DUT or are generated internally by the signal analyzer. If a harmonic originates from the DUT, its level remains constant if the RF attenuation is increased by 10 dB. Only the displayed noise is increased by 10 dB due to the additional attenuation. If the harmonic is exclusively generated by the signal analyzer, the level of the harmonic is reduced by 20 dB or is lost in noise. If both – the DUT and the signal analyzer – contribute to the harmonic, the reduction in the harmonic level is correspondingly smaller.

### High-sensitivity harmonics measurements

If harmonics have very small levels, the resolution bandwidth required to measure them must be reduced considerably. The sweep time is, therefore, also increased considerably. In this case, the measurement of individual harmonics is carried out with the R&S FPS set to a small span. Only the frequency range around the harmonics will then be measured with a small resolution bandwidth.

### Required measurement time

During the harmonics measurement, zero span sweeps are performed at the center frequency and at each harmonic. The duration of each sweep ( "Harmonic Sweep Time" , **SWT**) and the "Number of Harmonics" (n) are defined in the "Harmonic Distortion" configuration dialog box. Thus, the required measurement time for the harmonic distortion measurement (*Cumulated Measurement Time*, **CMT**) is:

$$CMT = n * SWT$$

The required measurement time is indicated as "CMT" in the channel bar.

## 6.9.3 Harmonic Distortion Results

As a result of the harmonics distortion measurement, the zero span sweeps of all detected harmonics are shown in the diagram, separated by red display lines. This provides a very good overview of the measurement.

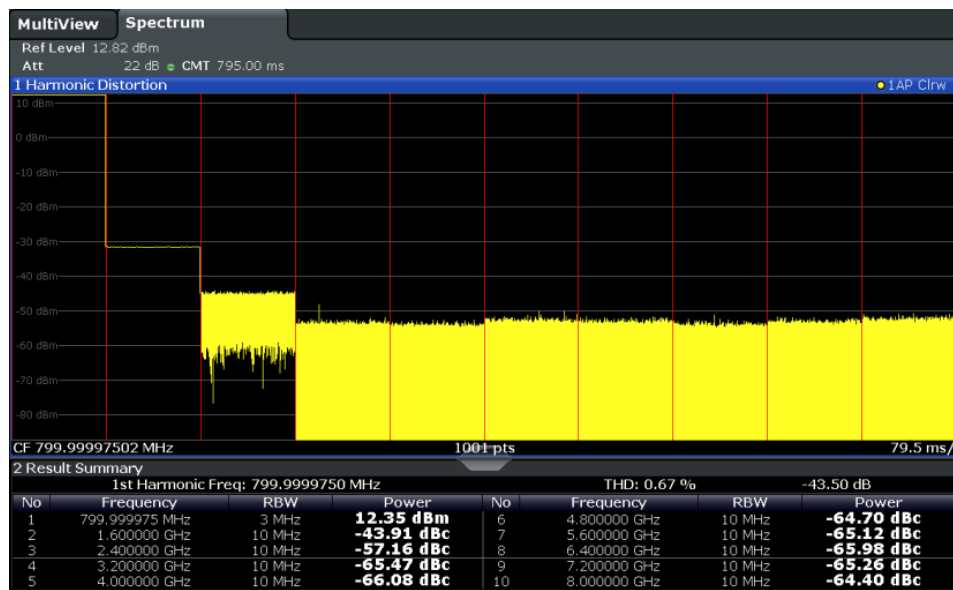

In addition, a result table is displayed providing the following information:

- First harmonic frequency
- THD (total harmonic distortion), relative and absolute values
- For each detected harmonic:
  - Frequency
  - RBW
  - Power

#### Remote commands

The results can also be queried using remote commands.

The first harmonic frequency can be read out via the general center frequency command `[SENSE:]FREQUENCY:CENTer` on page 777.

THD: `CALCulate<n>:MARKer<m>:FUNCTION:HARMonics:DISToRTion?`  
on page 750

List of harmonics: `CALCulate<n>:MARKer<m>:FUNCTION:HARMonics:LIST?`  
on page 750

### 6.9.4 Harmonic Distortion Configuration

**Access:** "Overview" > "Select Measurement" > "Harmonic Distortion" > "Harmonic Distortion Config"

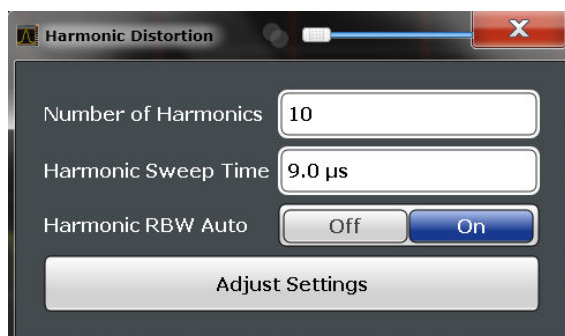

The remote commands required to perform these tasks are described in [Chapter 12.5.10, "Measuring the Harmonic Distortion"](#), on page 748.

|                                           |     |
|-------------------------------------------|-----|
| <a href="#">Number of Harmonics</a> ..... | 285 |
| <a href="#">Harmonic Sweep Time</a> ..... | 285 |
| <a href="#">Harmonic RBW Auto</a> .....   | 285 |
| <a href="#">Adjust Settings</a> .....     | 285 |

### Number of Harmonics

Defines the number of harmonics to be measured. The range is from 1 to 26. Default is 10.

Remote command:

`CALCulate<n>:MARKer<m>:FUNction:HARMonics:NHARmonics` on page 749

### Harmonic Sweep Time

Defines the sweep time for the zero span measurement on each harmonic frequency. This setting is identical to the normal sweep time for zero span, see also "[Sweep Time](#)" on page 368.

Remote command:

`[SENSe:]SWEep:TIME:AUTO` on page 790

### Harmonic RBW Auto

Enables/disables the automatic adjustment of the resolution bandwidth for Normal (3dB) (Gaussian) and 5-Pole filter types.

The automatic adjustment is carried out according to:

$$"RBW_n = RBW_1 * n"$$

If  $RBW_n$  is not available, the next higher value is used.

Remote command:

`CALCulate<n>:MARKer<m>:FUNction:HARMonics:BANDwidth:AUTO`  
on page 749

### Adjust Settings

If harmonic measurement was performed in the frequency domain, a new peak search is started in the frequency range that was set before starting the harmonic measurement. The center frequency is set to this frequency and the reference level is adjusted accordingly.

If harmonic measurement was performed in the time domain, this function adjusts the reference level only.

Remote command:

`CALCulate<n>:MARKer<m>:FUNction:HARMonics:PRESet` on page 749

### 6.9.5 How to Determine the Harmonic Distortion



In [Chapter 8.3.6, "Measurement Example: Measuring Harmonics Using Marker Functions"](#), on page 439, measuring harmonics was described using marker functions. This task can be performed much simpler using the Harmonic Distortion measurement, as described in the following procedure.

For remote operation, see [Chapter 12.5.10.5, "Example: Measuring the Harmonic Distortion"](#), on page 751.

1. Select the "Harmonic Distortion" measurement function from the "Select Measurement" dialog box.
2. Define the number of harmonics to be determined using the "Number of Harmonics" softkey.
3. Perform a sweep.

The trace for the determined harmonics are displayed in the diagram, separated by red display lines. The measured power for each harmonic in relation to the fundamental is indicated in the result table.

4. If the signal changes significantly during or after the harmonics measurement, use the "Adjust Settings" function to adjust the settings automatically and restart the measurement.

## 6.10 Third Order Intercept (TOI) Measurement

The third order intercept point of the R&S FPS can be determined if a two-tone signal with equal carrier levels is applied to the input.

`CALCulate<n>:MARKer<m>:FUNction:TOI:RESult?` on page 753

- [About the TOI Measurement](#).....287
- [TOI Basics](#).....287
- [TOI Results](#).....291
- [TOI Configuration](#).....292
- [How to Determine the Third Order Intercept](#).....293
- [Measurement Example – Measuring the R&S FPS's Intrinsic Intermodulation](#).... 293

### 6.10.1 About the TOI Measurement

If several signals are applied to a transmission two-port device with nonlinear characteristic, intermodulation products appear at its output at the sums and differences of the signals. The nonlinear characteristic produces harmonics of the useful signals which intermodulate at the characteristic. The intermodulation products of lower order have a special effect since their level is largest and they are near the useful signals. The intermodulation product of third order causes the highest interference. It is the intermodulation product generated from one of the useful signals and the 2nd harmonic of the second useful signal in case of two-tone modulation.

In order to measure the third order intercept point (TOI), a two-tone signal with equal carrier levels is expected at the R&S FPS input. Marker 1 and marker 2 (both normal markers) are set to the maximum of the two signals. Marker 3 and marker 4 are placed on the intermodulation products.

The R&S FPS calculates the third order intercept point from the level difference between the first 2 markers and the markers 3 and 4 and displays it in the marker table.

### 6.10.2 TOI Basics

If several signals are applied to a transmission two-port device with nonlinear characteristic, intermodulation products appear at its output at the sums and differences of the signals. The nonlinear characteristic produces harmonics of the useful signals which intermodulate at the characteristic.

The frequencies of the intermodulation products are above and below the useful signals. The [Figure 6-43](#) shows intermodulation products  $P_{S1}$  and  $P_{S2}$  generated by the two useful signals  $P_{U1}$  and  $P_{U2}$ .

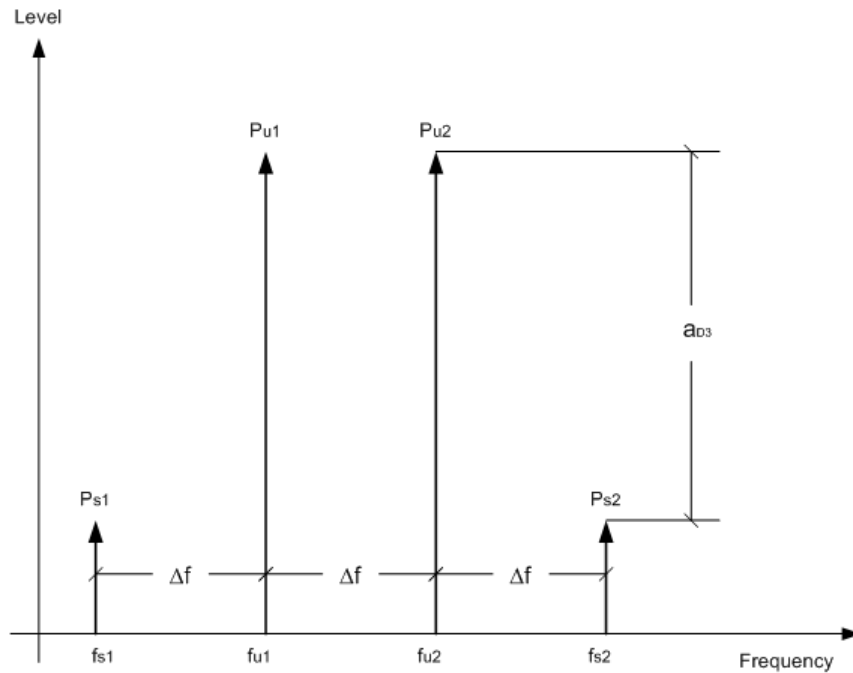

**Figure 6-43: Intermodulation products  $P_{s1}$  and  $P_{s2}$**

The intermodulation product at  $f_{i2}$  is generated by mixing the 2nd harmonic of useful signal  $P_{u2}$  and signal  $P_{u1}$ .

The intermodulation product at  $f_{i1}$  is generated by mixing the 2nd harmonic of useful signal  $P_{u1}$  and signal  $P_{u2}$ .

$$f_{i1} = 2 \times f_{u1} - f_{u2} \quad (1)$$

$$f_{i2} = 2 \times f_{u2} - f_{u1} \quad (2)$$

#### Dependency on level of useful signals

The level of the intermodulation products depends on the level of the useful signals. If the two useful signals are increased by 1 dB, the level of the intermodulation products increases by 3 dB, which means that the spacing  $a_{D3}$  between intermodulation signals and useful signals is reduced by 2 dB. This is illustrated in [Figure 6-44](#).



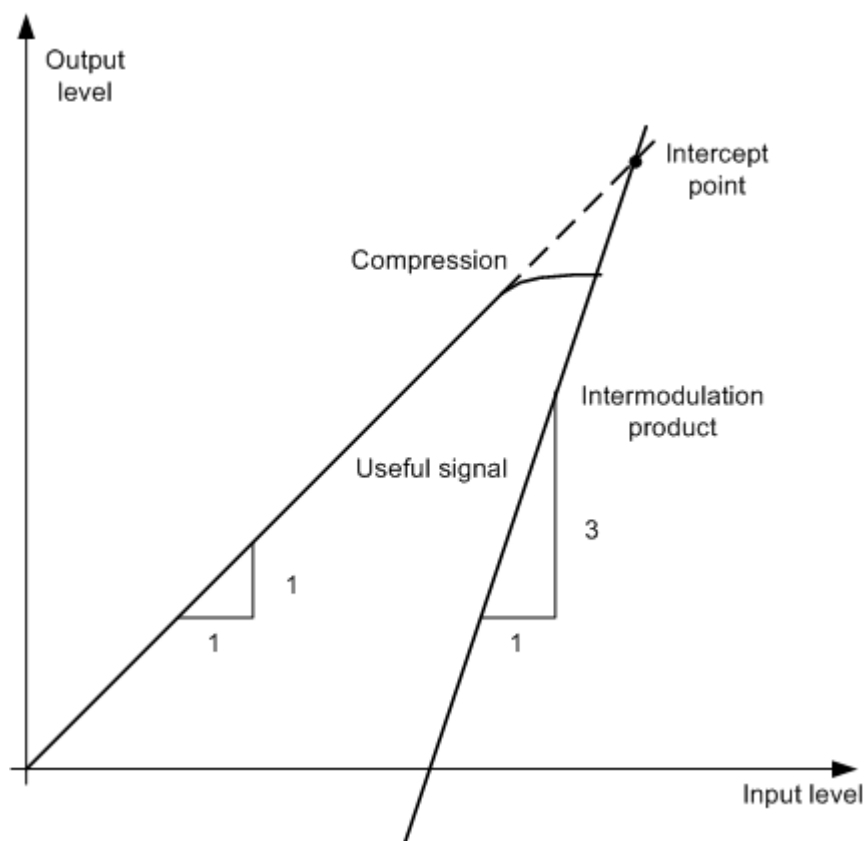

Figure 6-44: Dependency of intermodulation products on level of useful signals

The useful signals at the two-port output increase proportionally with the input level as long as the two-port is in the linear range. A level change of 1 dB at the input causes a level change of 1 dB at the output. Beyond a certain input level, the two-port goes into compression and the output level stops increasing. The intermodulation products of the third order increase three times as quickly as the useful signals. The intercept point is the fictitious level where the two lines intersect. It cannot be measured directly since the useful level is previously limited by the maximum two-port output power.

#### Calculation method

However, the intercept point can be calculated from the known line slopes and the measured spacing  $a_{D3}$  at a given level according to the following formula:

$$IP3 = \frac{a_{D3}}{2} + P_N$$

The third order intercept point (TOI), for example, is calculated for an intermodulation of 60 dB and an input level  $P_U$  of -20 dBm according to the following formula:

$$IP3 = \frac{60}{2} + (-20dBm) = 10dBm$$

### Intermodulation-free dynamic range

The "Intermodulation-free dynamic range", i.e. the level range in which no internal intermodulation products are generated if two-tone signals are measured, is determined by the third order intercept point, the phase noise and the thermal noise of the signal analyzer. At high signal levels, the range is determined by intermodulation products. At low signal levels, intermodulation products disappear below the noise floor, i.e. the noise floor and the phase noise of the signal analyzer determine the range. The noise floor and the phase noise depend on the resolution bandwidth that has been selected. At the smallest resolution bandwidth, the noise floor and phase noise are at a minimum and so the maximum range is obtained. However, a large increase in sweep time is required for small resolution bandwidths. It is therefore best to select the largest resolution bandwidth possible to obtain the range that is required. Since phase noise decreases as the carrier-offset increases, its influence decreases with increasing frequency offset from the useful signals.

The following diagrams illustrate the intermodulation-free dynamic range as a function of the selected bandwidth and of the level at the input mixer (= signal level – set RF attenuation) at different useful signal offsets.

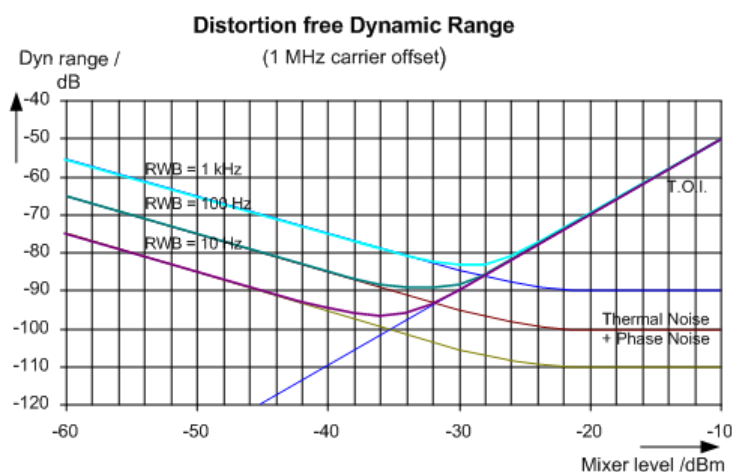

**Figure 6-45: Intermodulation-free range as a function of level at the input mixer and the set resolution bandwidth**

(Useful signal offset = 1 MHz, DANL = -145 dBm/Hz, TOI = 15 dBm; typical values at 2 GHz)

The optimum mixer level, i.e. the level at which the intermodulation distance is at its maximum, depends on the bandwidth. At a resolution bandwidth of 10 Hz, it is approx. -35 dBm and at 1 kHz increases to approx. -30 dBm.

Phase noise has a considerable influence on the intermodulation-free range at carrier offsets between 10 and 100 kHz ( see [Figure 6-46](#)). At greater bandwidths, the influence of the phase noise is greater than it would be with small bandwidths. The optimum mixer level at the bandwidths under consideration becomes almost independent of bandwidth and is approx. -40 dBm.

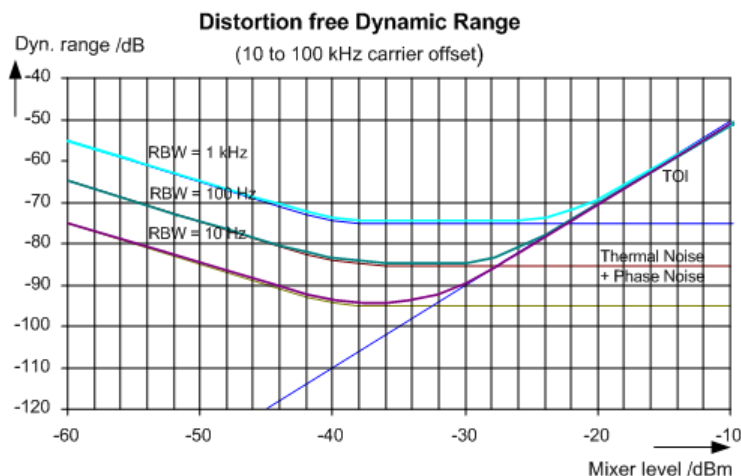

Figure 6-46: Intermodulation-free dynamic range as a function of level at the input mixer and of the selected resolution bandwidth

(Useful signal offset = 10 to 100 kHz, DANL = -145 dBm/Hz, TOI = 15 dBm; typical values at 2 GHz).



If the intermodulation products of a DUT with a very high dynamic range are to be measured and the resolution bandwidth to be used is therefore very small, it is best to measure the levels of the useful signals and those of the intermodulation products separately using a small span. The measurement time will be reduced, in particular if the offset of the useful signals is large. To find signals reliably when frequency span is small, it is best to synchronize the signal sources and the R&S FPS.

### 6.10.3 TOI Results

As a result of the TOI measurement, the following values are displayed in the marker area of the diagram:

| Label | Description                     |
|-------|---------------------------------|
| TOI   | Third-order intercept point     |
| M1    | Maximum of first useful signal  |
| M2    | Maximum of second useful signal |
| M3    | First intermodulation product   |
| M4    | Second intermodulation product  |

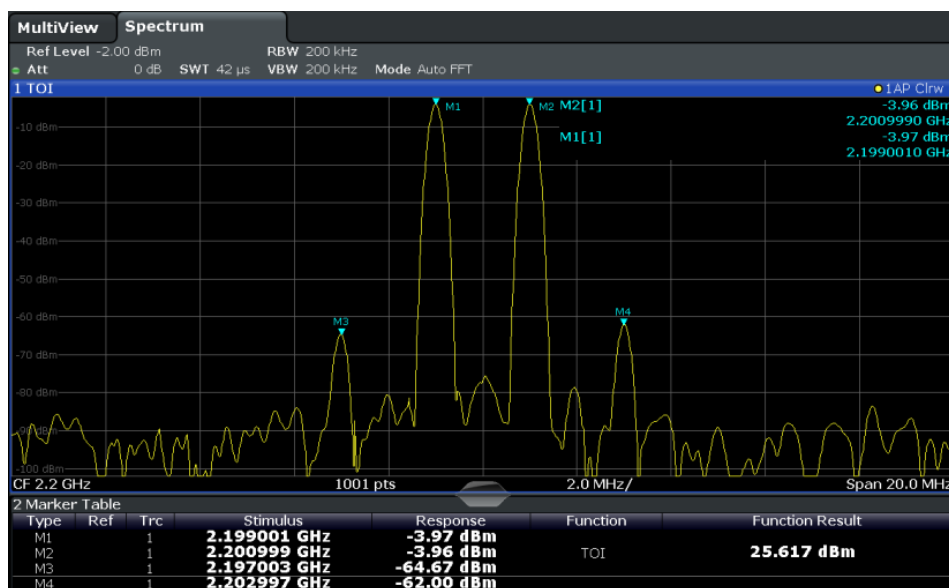

**Remote command**

The TOI can also be queried using the remote command `CALCulate<n>:MARKer<m>:FUNction:TOI:RESult?` on page 753.

**6.10.4 TOI Configuration**

**Access:** "Overview" > "Select Measurement" > "Third Order Intercept" > "TOI Config"

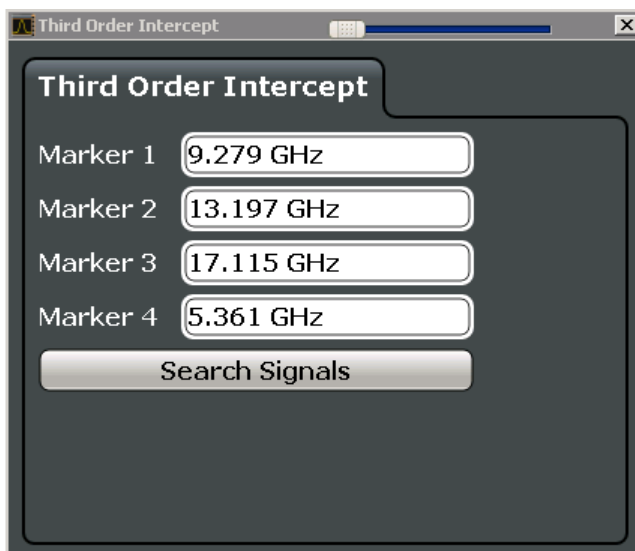

The remote commands required to perform these tasks are described in [Chapter 12.5.11, "Measuring the Third Order Intercept Point"](#), on page 752.

[Marker 1 / Marker 2 / Marker 3 / Marker 4](#) ..... 293

[Search Signals](#) ..... 293

**Marker 1 / Marker 2 / Marker 3 / Marker 4**

Indicates the detected characteristic values as determined by the TOI measurement (see [Chapter 6.10.3, "TOI Results"](#), on page 291).

The marker positions can be edited; the TOI is then recalculated according to the new marker values.

To reset all marker positions automatically, use the [Search Signals](#) function.

Remote command:

[CALCulate<n>:MARKer<m>:X](#) on page 867

[CALCulate<n>:DELTAmarker<m>:X](#) on page 865

[CALCulate<n>:DELTAmarker<m>:X:RELative?](#) on page 880

**Search Signals**

Performs a new search on the input signals and recalculates the TOI according to the measured values.

Remote command:

[CALCulate<n>:MARKer<m>:FUNCTION:TOI:SEARChsignal ONCE](#) on page 753

**6.10.5 How to Determine the Third Order Intercept**

The precise TOI for the R&S FPS in relation to the input signals is provided in the data sheet.

For remote operation, see [Chapter 12.5.11.2, "Programming Example: Measuring the TOI"](#), on page 753.

1. Apply a two-tone signal with equal carrier levels to the R&S FPS input.
2. On the R&S FPS, press the MEAS key.
3. Select the "Third Order Intercept" measurement function from the "Select Measurement" dialog box.

The calculated TOI is indicated in the marker information. The markers required for calculation are displayed in the marker table.

4. If the signal changes significantly during or after the TOI measurement, use the "Search Signals" function to start a new signal search automatically and restart the calculation of the TOI.

**6.10.6 Measurement Example – Measuring the R&S FPS's Intrinsic Intermodulation**

A programming example demonstrating a TOI measurement in a remote environment is provided in [Chapter 12.5.11.2, "Programming Example: Measuring the TOI"](#), on page 753.

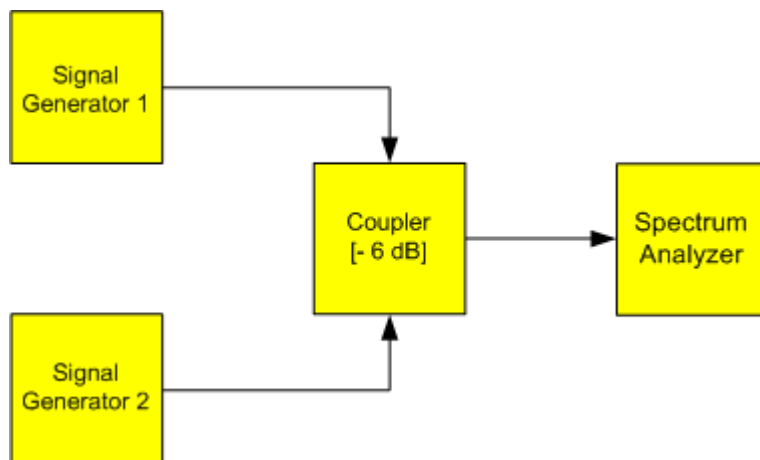
**Test setup:****Signal generator settings (e.g. R&S FPS SMW):**

| Device             | Level  | Frequency |
|--------------------|--------|-----------|
| Signal generator 1 | -4 dBm | 799.6 MHz |
| Signal generator 2 | -4 dBm | 800.4 MHz |

**Setting up the measurement**

1. Preset the R&S FPS.
2. Set the center frequency to *800 MHz* and the frequency span to *3 MHz*.
3. Set the reference level to *-10 dBm* and RF attenuation to *0 dB*.
4. Set the resolution bandwidth to *10 kHz*.  
The noise is reduced, the trace is smoothed further and the intermodulation products can be seen clearly.
5. Set the VBW to *1 kHz*.

**Measuring intermodulation using the Third Order Intercept (TOI) measurement function**

1. Press the MEAS key and select the "Third Order Intercept" measurement function from the "Select Measurement" dialog box.

The R&S FPS activates four markers to measure the intermodulation distance. Two markers are positioned on the useful signals and two on the intermodulation products. The TOI is calculated from the level difference between the useful signals and the intermodulation products. It is then displayed on the screen:

Third Order Intercept (TOI) Measurement

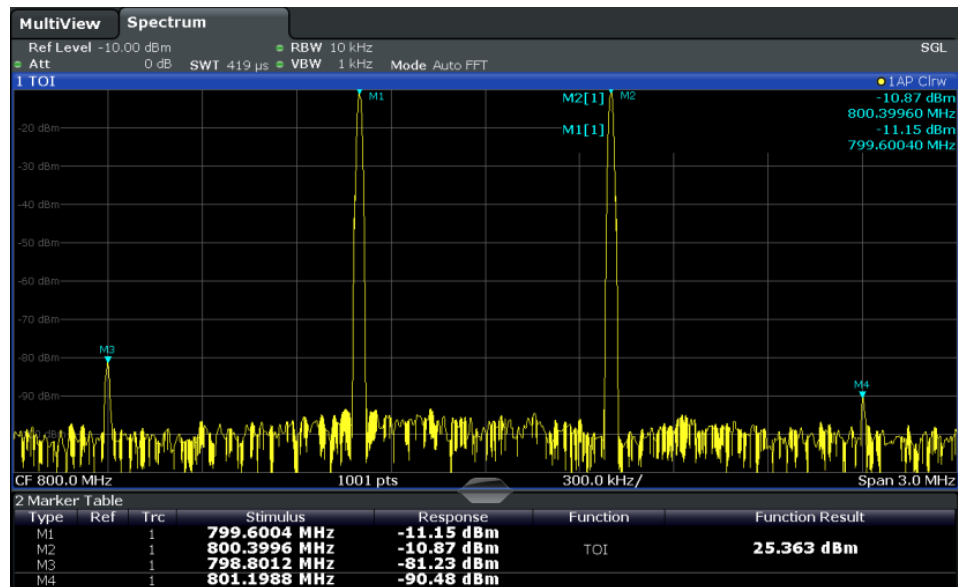

The third order intercept (TOI) is displayed in the marker information.

- The level of a signal analyzer's intrinsic intermodulation products depends on the RF level of the useful signals at the input mixer. When the RF attenuation is added, the mixer level is reduced and the intermodulation distance is increased. With an additional RF attenuation of 10 dB, the levels of the intermodulation products are reduced by 20 dB. The noise level is, however, increased by 10 dB. Increase the RF attenuation to 20 dB to reduce intermodulation products.

The R&S FPS's intrinsic intermodulation products disappear below the noise floor.

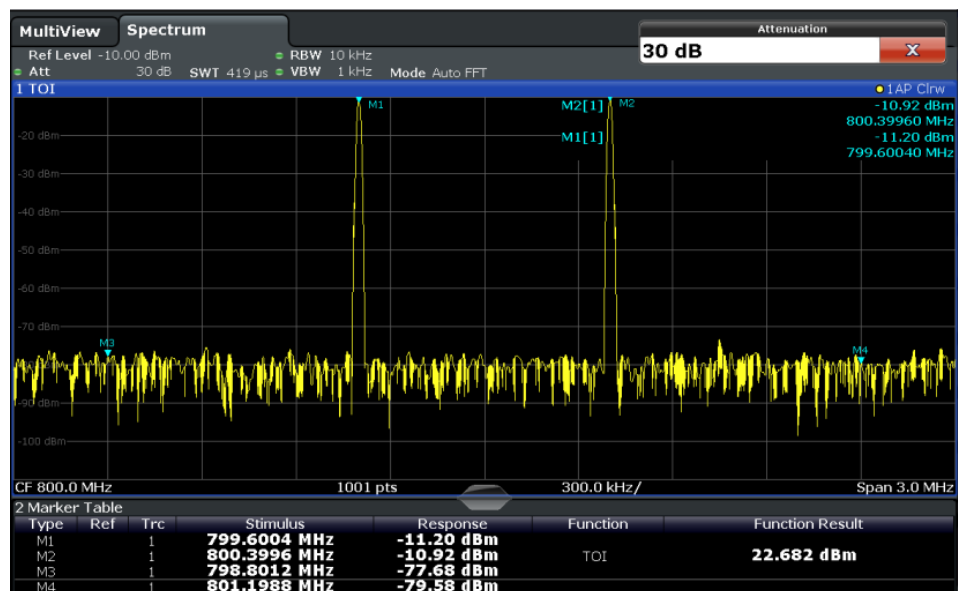

## 6.11 AM Modulation Depth Measurement

This measurement determines the AM modulation depth of an AM-modulated carrier.

- [About the Measurement](#).....296
- [AM Modulation Depth Results](#).....296
- [AM Modulation Depth Configuration](#).....297
- [Optimizing and Troubleshooting the Measurement](#).....298
- [How to Determine the AM Modulation Depth](#).....299

### 6.11.1 About the Measurement

The AM modulation depth, also known as a modulation index, indicates how much the modulated signal varies around the carrier amplitude. It is defined as:

$$M_{\text{Depth}} = \text{peak signal amplitude} / \text{unmodulated carrier amplitude}$$

So for  $M_{\text{Depth}} = 0.5$ , for example, the carrier amplitude varies by 50% above and below its unmodulated level, and for  $M_{\text{Depth}} = 1.0$  it varies by 100%.

When this measurement is activated, marker 1 is set to the peak level, which is considered to be the carrier level. Delta markers 2 and 3 are automatically set symmetrically to the carrier on the adjacent peak values of the trace. The markers can be adjusted manually, if necessary.

The R&S FPS calculates the power at the marker positions from the measured levels. The AM modulation depth is calculated as the ratio between the power values at the reference marker and at the delta markers. If the powers of the two AM side bands are unequal, the mean value of the two power values is used for AM modulation depth calculation.

### 6.11.2 AM Modulation Depth Results

As a result of the AM Modulation Depth measurement, the following values are displayed in the marker area of the diagram:

| Label  | Description                                        |
|--------|----------------------------------------------------|
| MDepth | AM modulation depth in percent                     |
| M1     | Maximum of the signal (= carrier level)            |
| D2     | Offset of next peak to the right of the carrier    |
| D3     | Offset of the next peak to the left of the carrier |



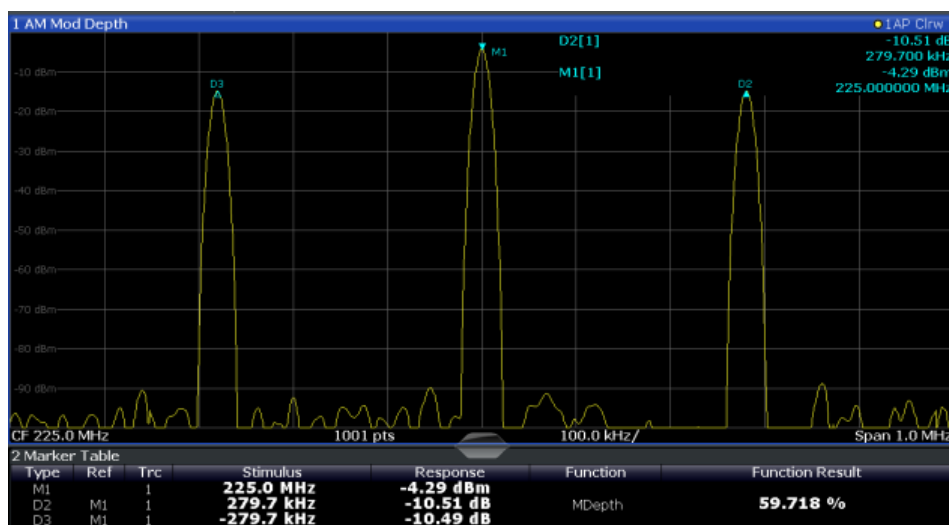

**Remote command:**

The AM modulation depth can also be queried using the remote command `CALCulate<n>:MARKer<m>:FUNCTION:MDEPth:RESult?` on page 755.

**6.11.3 AM Modulation Depth Configuration**

**Access:** "Overview" > "Select Measurement" > "AM Modulation Depth" > "AM Mod Depth Config"

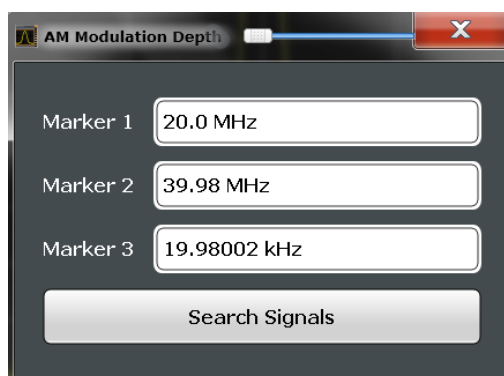

The remote commands required to perform these tasks are described in [Chapter 12.5.12, "Measuring the AM Modulation Depth"](#), on page 754.

[Marker 1 / Marker 2 / Marker 3](#) .....297  
[Search Signals](#) .....298

**Marker 1 / Marker 2 / Marker 3**

Indicates the detected characteristic values as determined by the AM Modulation Depth measurement:

| Marker | Description                                        |
|--------|----------------------------------------------------|
| M1     | Maximum of the signal (= carrier level)            |
| D2     | Offset of next peak to the right of the carrier    |
| D3     | Offset of the next peak to the left of the carrier |

The marker positions can be edited; the modulation depth is then recalculated according to the new marker values.

To reset all marker positions automatically, use the [Search Signals](#) function.

**Note:** Moving the marker positions manually. When the position of delta marker 2 is changed, delta marker 3 is moved symmetrically with respect to the reference marker 1.

Delta marker 3, on the other hand, can be moved for fine adjustment independently of marker 2.

Marker 1 can also be moved manually for re-adjustment without affecting the position of the delta markers.

Remote command:

[CALCulate<n>:MARKer<m>:X](#) on page 867

[CALCulate<n>:DELTAmarker<m>:X](#) on page 865

[CALCulate<n>:DELTAmarker<m>:X:RELative?](#) on page 880

#### Search Signals

Performs a new search on the input signal and recalculates the AM Modulation Depth according to the measured values.

Remote command:

[CALCulate<n>:MARKer<m>:FUNCTION:MDEPTH:SEARCHsignal ONCE](#)

on page 755

### 6.11.4 Optimizing and Troubleshooting the Measurement

If the results do not meet your expectations, try the following methods to optimize the measurement:

- Set the center frequency to the frequency of the device under test.
- Adjust the span so the peaks to the left and right of the carrier, produced by the AM modulated signal, are clearly visible.  
If the span is too wide, these signals may fall together with the carrier and the measurement can not be performed.  
If the span is too narrow, these signals are outside of the measured span and the delta markers can not find these peaks.  
The rule of thumb is to set the span to three times the value of the AM modulation frequency.

### 6.11.5 How to Determine the AM Modulation Depth

The following step-by-step instructions demonstrate how to determine the AM modulation depth.



For remote operation, see [Chapter 12.5.12.2, "Example: Measuring the AM Modulation Depth"](#), on page 755.

---

1. Apply a modulated carrier signal to the R&S FPS input.
2. On the R&S FPS, press the MEAS key.
3. Select the "AM Modulation Depth" measurement function from the "Select Measurement" dialog box.  
The calculated AM Modulation Depth is indicated in the marker information. The markers required for calculation are displayed in the marker table.
4. If the signal changes significantly during or after the AM Modulation Depth measurement, use the "Search Signals" function to start a new peak search automatically and restart the calculation of the AM Modulation Depth.

## 7 Common Measurement Settings

Basic measurement settings that are common to many measurement tasks, regardless of the application or operating mode, are described here. If you are performing a specific measurement task, using an operating mode other than Signal and Spectrum Analyzer mode, or an application other than the Spectrum application, be sure to check the specific application or mode description for settings that may deviate from these common settings.

- [Configuration Overview](#).....300
- [Data Input and Output](#).....302
- [Frequency and Span Configuration](#).....343
- [Amplitude and Vertical Axis Configuration](#).....351
- [Bandwidth, Filter and Sweep Configuration](#).....360
- [Trigger and Gate Configuration](#).....375
- [Adjusting Settings Automatically](#).....389

### 7.1 Configuration Overview



**Access:** all menus

Each channel provides an overview of the most important currently defined settings and access to the most important configuration dialog boxes for the particular measurement. This overview is available via the "Overview" icon, which is displayed in all menus.

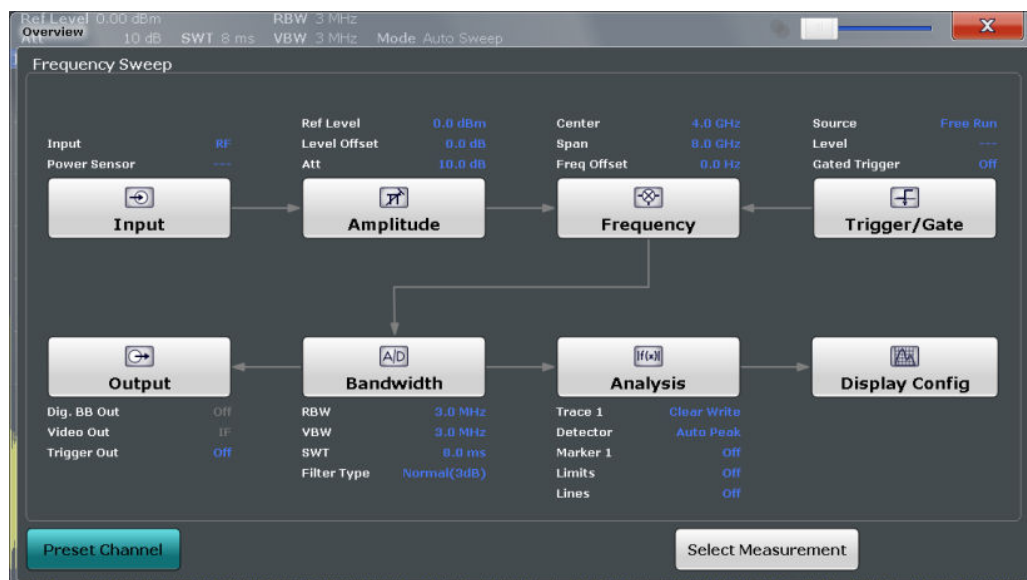

Using this overview, you can easily configure an entire channel from input over processing to output and analysis by stepping through the dialog boxes as indicated.

In particular, the "Overview" provides quick access to the following configuration dialog boxes (listed in the recommended order of processing):

1. "Select Measurement"  
See [Chapter 6, "Measurements and Results"](#), on page 123
2. Input  
See [Chapter 7.2.2, "Input Source Settings"](#), on page 303
3. Amplitude  
See [Chapter 7.4, "Amplitude and Vertical Axis Configuration"](#), on page 351
4. Frequency  
See [Chapter 7.3, "Frequency and Span Configuration"](#), on page 343
5. (Optionally:) Trigger/Gate  
See [Chapter 7.6, "Trigger and Gate Configuration"](#), on page 375
6. Bandwidth  
See [Chapter 7.5.2, "Bandwidth, Filter and Sweep Settings"](#), on page 366  
(For SEM measurements: SEM Setup, see [Chapter 6.5.5, "SEM Configuration"](#), on page 219)  
(For Spurious measurements: Spurious Setup, see [Chapter 6.6.4, "Spurious Emissions Measurement Configuration"](#), on page 252)
7. (Optionally:) Outputs  
See [Chapter 7.2.5, "Output Settings"](#), on page 338
8. Analysis  
See [Chapter 8, "Common Analysis and Display Functions"](#), on page 393
9. Display  
See [Chapter 8.1, "Result Display Configuration"](#), on page 393

#### To configure settings

- ▶ Select any button to open the corresponding dialog box.  
Select a setting in the channel bar (at the top of the channel tab) to change a specific setting.

#### Preset Channel

Select the "Preset Channel" button in the lower left-hand corner of the "Overview" to restore all measurement settings **in the current channel** to their default values.

Do not confuse the "Preset Channel" button with the PRESET key, which restores the entire instrument to its default values and thus closes **all channels** on the R&S FPS (except for the default channel)!

Remote command:

`SYSTem:PRESet:CHANnel[:EXEC]` on page 951

## 7.2 Data Input and Output

The R&S FPS can analyze signals from different input sources and provide various types of output (such as video or trigger signals).

- [Receiving Data Input and Providing Data Output](#)..... 302
- [Input Source Settings](#).....303
- [Power Sensors](#).....305
- [External Generator Control](#)..... 314
- [Output Settings](#)..... 338
- [Trigger Input/Output Settings](#)..... 340
- [How to Output a Trigger Signal](#)..... 342

### 7.2.1 Receiving Data Input and Providing Data Output

The R&S FPS can analyze signals from different input sources and provide various types of output (such as noise or trigger signals).

#### 7.2.1.1 Receiving and Providing Trigger Signals

Using one of the TRG IN / AUX connectors of the R&S FPS, the R&S FPS can use a signal from an external device as a trigger to capture data. Alternatively, the internal trigger signal used by the R&S FPS can be output for use by other connected devices. Using the same trigger on several devices is useful to synchronize the transmitted and received signals within a measurement.

For details on the connectors see the R&S FPS "Getting Started" manual.

#### External trigger as input

If the trigger signal for the R&S FPS is provided by an external device, the trigger signal source must be connected to the R&S FPS and the trigger source must be defined as "External" in the R&S FPS.

#### Trigger output

The R&S FPS can provide output to another device either to pass on the internal trigger signal, or to indicate that the R&S FPS itself is ready to trigger.

The trigger signal can be output by the R&S FPS automatically, or manually by the user. If it is provided automatically, a high signal is output when the R&S FPS has triggered due to a sweep start ( "Device Triggered" ), or when the R&S FPS is ready to receive a trigger signal after a sweep start ( "Trigger Armed" ).

#### Manual triggering

If the trigger output signal is initiated manually, the length and level (high/low) of the trigger pulse is also user-definable. Note, however, that the trigger pulse level is always opposite to the constant signal level defined by the output "Level" setting, e.g.

for "Level" = "High", a constant high signal is output to the connector until the "Send Trigger" button is selected. Then, a low pulse is provided.

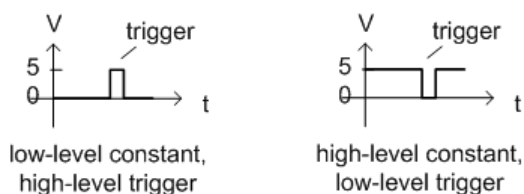

### 7.2.1.2 IF and Video Signal Output

The measured IF signal or displayed video signal (i.e. the filtered and detected IF signal) can be provided at the IF/VIDEO output connector of the R&S FPS.

The **video output** is a signal of 1 V. It can be used, for example, to control demodulated audio frequencies.

The **IF output** is a signal of the measured level at a specified frequency.

#### Restrictions

Note the following restrictions for data output:

- IF and video output is only available in the time domain (zero span).

If the hardware option R&S FPS-B160 for **bandwidth extension** is installed and activated (i.e. for bandwidths > 40 MHz), the IF output is not available at the IF/VIDEO output connector.

## 7.2.2 Input Source Settings

**Access:** "Overview" > "Input" > "Input Source"

The input source determines which data the R&S FPS will analyze.

The default input source for the R&S FPS is "Radio Frequency", i.e. the signal at the RF INPUT connector of the R&S FPS. If no additional options are installed, this is the only available input source.

- [Radio Frequency Input](#).....303

### 7.2.2.1 Radio Frequency Input

**Access:** "Overview" > "Input/Frontend" > "Input Source" > "Radio Frequency"

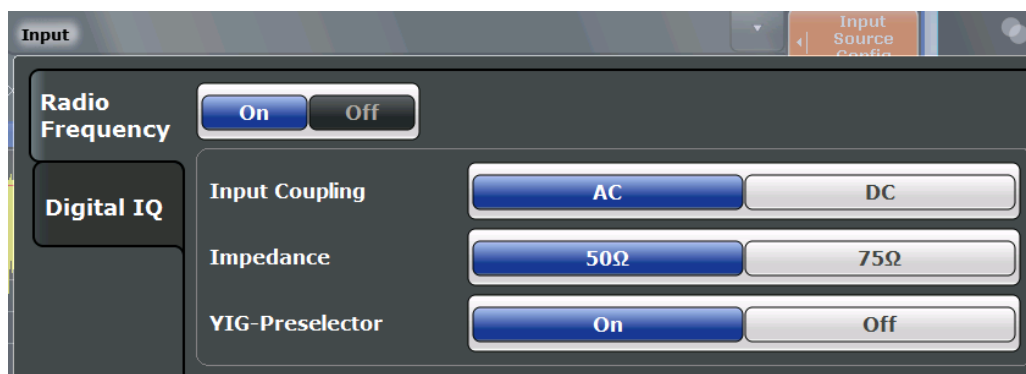

Radio Frequency State ..... 304  
 Input Coupling ..... 304  
 Impedance ..... 304  
 YIG-Preselector .....305

**Radio Frequency State**

Activates input from the RF INPUT connector.

Remote command:

[INPut:SElect](#) on page 814

**Input Coupling**

The RF input of the R&S FPS can be coupled by alternating current (AC) or direct current (DC).

AC coupling blocks any DC voltage from the input signal. This is the default setting to prevent damage to the instrument. Very low frequencies in the input signal may be distorted.

However, some specifications require DC coupling. In this case, you must protect the instrument from damaging DC input voltages manually. For details, refer to the data sheet.

Remote command:

[INPut:COUPling](#) on page 812

**Impedance**

The R&S FPS has an internal impedance of 50 Ω. However, some applications use other impedance values. In order to match the impedance of an external application to the impedance of the R&S FPS, an *impedance matching pad* can be inserted at the input. If the type and impedance value of the used matching pad is known to the R&S FPS, it can convert the measured units accordingly so that the results are calculated correctly.

(See " [Reference Level](#) " on page 355).

This function is not available for input from the optional Digital Baseband Interface. Not all settings are supported by all R&S FPS applications.

The impedance conversion does not affect the level of the output signals (such as IF, video, demod, digital I/Q output)

"50Ω" (Default:) no conversion takes place



|        |                                                                                                                                                                  |
|--------|------------------------------------------------------------------------------------------------------------------------------------------------------------------|
| "75Ω"  | The 50 Ω input impedance is transformed to a higher impedance using a 75 Ω adapter of the selected "Pad Type": "Series-R" (default) or "MLP" (Minimum Loss Pad)  |
| "User" | The 50 Ω input impedance is transformed to a user-defined impedance value according to the selected "Pad Type": "Series-R" (default) or "MLP" (Minimum Loss Pad) |

Remote command:

[INPut:IMPedance](#) on page 813

[INPut:IMPedance:PTYPe](#) on page 813

### YIG-Preselector

Activates or deactivates the YIG-preselector, if available on the R&S FPS.

An internal YIG-preselector at the input of the R&S FPS ensures that image frequencies are rejected. However, this is only possible for a restricted bandwidth. To use the maximum bandwidth for signal analysis you can deactivate the YIG-preselector at the input of the R&S FPS, which can lead to image-frequency display.

Note that the YIG-preselector is active only on frequencies greater than 8 GHz. Therefore, switching the YIG-preselector on or off has no effect if the frequency is below that value.

#### Note:

For the following measurements, the YIG-Preselector is off by default (if available).

- I/Q Analyzer (and thus in all slave applications in MSRA operating mode)
- GSM
- VSA

Remote command:

[INPut:FILTer:YIG\[:STATe\]](#) on page 813

## 7.2.3 Power Sensors

The R&S FPS can also analyze data from a connected power sensor.

- [Basics on Power Sensors](#)..... 305
- [Power Sensor Settings](#).....307
- [How to Work With a Power Sensor](#).....312
- [How to Configure a Power Sensor as an External Trigger](#)..... 314

### 7.2.3.1 Basics on Power Sensors

For precise power measurement, up to 4 power sensors can be connected to the instrument via the USB interfaces. Both manual operation and remote control are supported.



For a detailed list of supported sensors, see the data sheet.

As the R&S FPS does not provide an explicit POWER SENSOR connector, an R&S®NRP-Z3/-Z4/ or -Z5 adaptor is required to connect the power sensor to one of the USB connectors on the R&S FPS.

Power sensors can also be used to trigger a measurement at a specified power level, e.g. from a signal generator (see "Using a Power Sensor as an External Power Trigger" on page 306).



Figure 7-1: Power sensor support – standard test setup



### Using the power sensor with several applications

The power sensor cannot be used from the R&S FPS firmware and the R&S Power Viewer Plus (virtual power meter for displaying results of the R&S NRP power sensors) simultaneously.

### Result display

The results of the power sensor measurements are displayed in the marker table. For each power sensor, a row is inserted. The sensor index is indicated in the "Type" column.

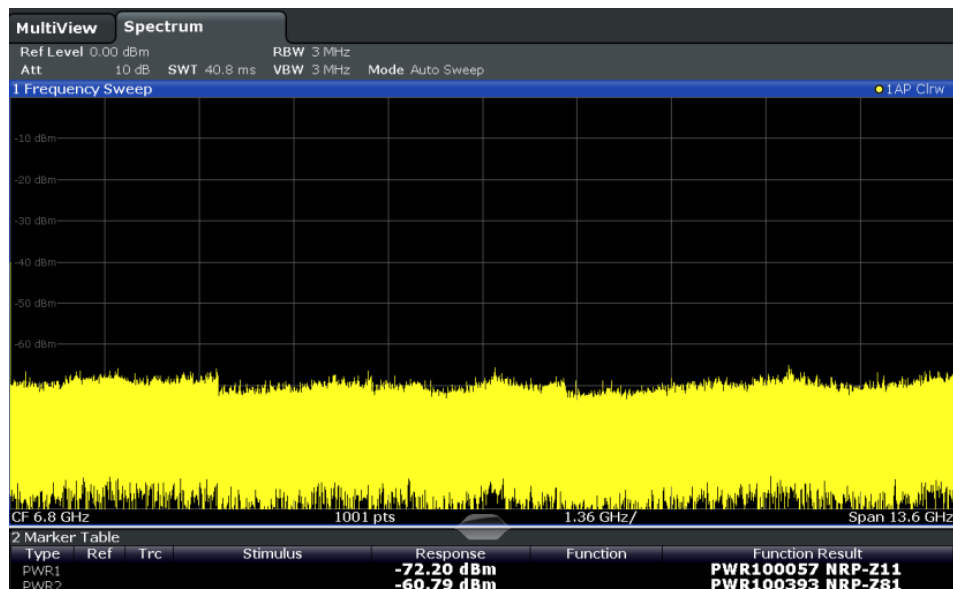

### Using a Power Sensor as an External Power Trigger

Power sensors can be used to trigger a measurement at a specified power level, e.g. from a signal generator. For a list of supported power sensors see the data sheet.

With the R&S FPS, the power sensor requires a special USB adaptor which must be connected to the instrument. In addition, the power sensor must be connected to the R&S FPS's external trigger port.

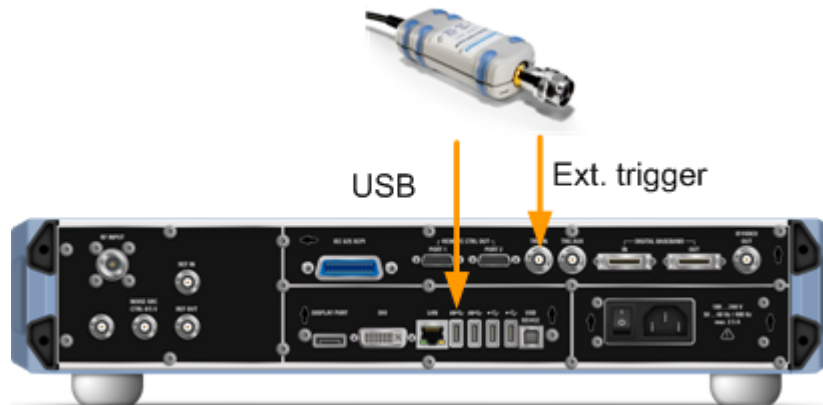

*Figure 7-2: Connecting a power sensor for use as an external trigger*

The R&S FPS receives an external trigger signal when the defined trigger level is measured by the power sensor. Power measurement results are provided as usual.



The "Gate Mode" *Level* is not supported for R&S power sensors. The signal sent by these sensors merely reflects the instant the level is first exceeded, rather than a time period. However, only time periods can be used for gating in level mode. Thus, the trigger impulse from the sensors is not long enough for a fully gated measurement; the measurement cannot be completed. For details on gating see [Chapter 7.6.2.1, "Gated Measurements"](#), on page 385.

For details see [Chapter 7.2.3.4, "How to Configure a Power Sensor as an External Trigger"](#), on page 314.

### 7.2.3.2 Power Sensor Settings

**Access:** "Overview" > "Input" > "Power Sensor" tab

Each sensor is configured on a separate tab.

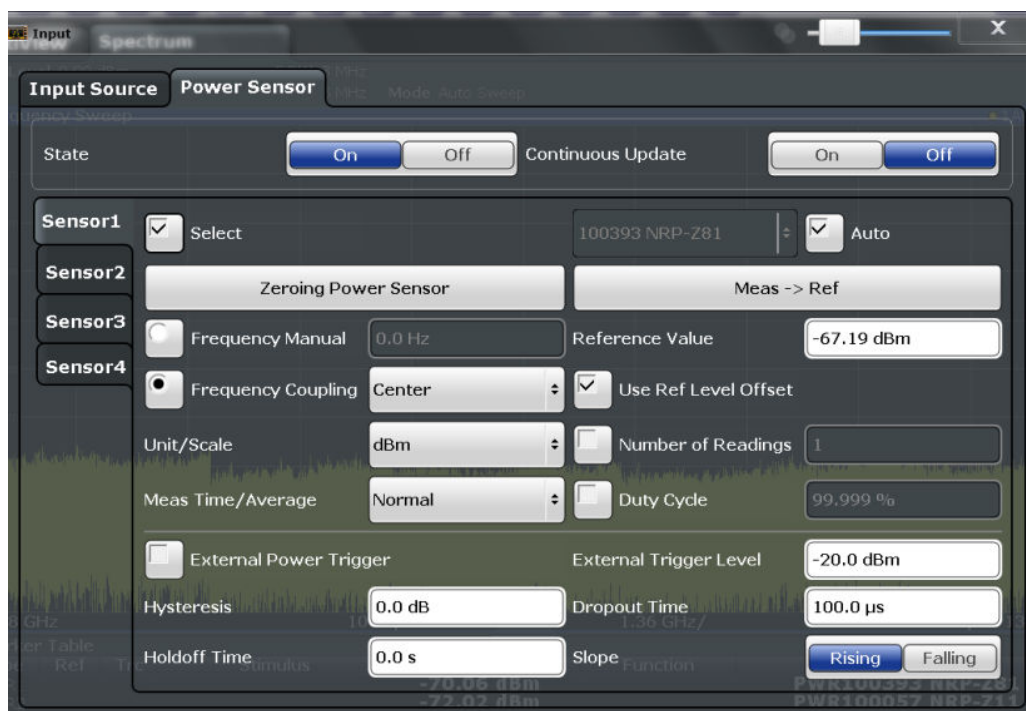

State ..... 308

Continuous Value Update ..... 309

Select ..... 309

Zeroing Power Sensor ..... 309

Frequency Manual ..... 309

Frequency Coupling ..... 309

Unit/Scale ..... 310

Meas Time/Average ..... 310

Setting the Reference Level from the Measurement Meas -> Ref ..... 310

Reference Value ..... 310

Use Ref Level Offset ..... 310

Average Count ( Number of Readings ) ..... 311

Duty Cycle ..... 311

Using the power sensor as an external trigger ..... 311

- L External Trigger Level ..... 311
- L Hysteresis ..... 311
- L Trigger Holdoff ..... 312
- L Drop-Out Time ..... 312
- L Slope ..... 312

**State**

Switches the power measurement for all power sensors on or off. Note that in addition to this general setting, each power sensor can be activated or deactivated individually by the [Select](#) setting on each tab. However, the general setting overrides the individual settings.

Remote command:

[SENSe:] PMETer<p> [:STATe] on page 830

### Continuous Value Update

If activated, the power sensor data is updated continuously during a sweep with a long sweep time, and even after a single sweep has completed.

This function cannot be activated for individual sensors.

If the power sensor is being used as a trigger (see " [Using the power sensor as an external trigger](#) " on page 311), continuous update is not possible; this setting is ignored.

Remote command:

[\[SENSe:\] PMETer<p>:UPDate \[:STATe\]](#) on page 831

### Select

Selects the individual power sensor for usage if power measurement is generally activated ( [State](#) function).

The detected **serial numbers** of the power sensors connected to the instrument are provided in a selection list. For each of the four available power sensor indexes ( "Power Sensor 1" ... "Power Sensor 4" ), which correspond to the tabs in the configuration dialog, one of the detected serial numbers can be assigned. The physical sensor is thus assigned to the configuration setting for the selected power sensor index.

By default, serial numbers not yet assigned are automatically assigned to the next free power sensor index for which "Auto Assignment" is selected.

Alternatively, you can assign the sensors manually by deactivating the "Auto" option and selecting a serial number from the list.

Remote command:

[\[SENSe:\] PMETer<p>\[:STATe\]](#) on page 830

[SYSTem:COMMUnicate:RDEvice:PMETer<p>:DEFine](#) on page 824

[SYSTem:COMMUnicate:RDEvice:PMETer<p>:CONFigure:AUTO\[:STATe\]](#)  
on page 824

[SYSTem:COMMUnicate:RDEvice:PMETer:COUNT?](#) on page 824

### Zeroing Power Sensor

Starts zeroing of the power sensor.

For details on the zeroing process refer to "[How to Zero the Power Sensor](#)" on page 313.

Remote command:

[CALibration:PMETer<p>:ZERO:AUTO ONCE](#) on page 825

### Frequency Manual

Defines the frequency of the signal to be measured. The power sensor has a memory with frequency-dependent correction factors. This allows extreme accuracy for signals of a known frequency.

Remote command:

[\[SENSe:\] PMETer<p>:FREQuency](#) on page 828

### Frequency Coupling

Selects the coupling option. The frequency can be coupled automatically to the center frequency of the instrument or to the frequency of marker 1.

Remote command:

[SENSe:] PMETer<p>:FREQuency:LINK on page 828

### Unit/Scale

Selects the unit with which the measured power is to be displayed. Available units are dBm, dB, W and %.

If dB or % is selected, the display is relative to the reference value that is defined with either the "Meas -> Ref" setting or the "Reference Value" setting.

Remote command:

UNIT<n>:PMETer<p>:POWer on page 831

UNIT<n>:PMETer<p>:POWer:RATio on page 831

### Meas Time/Average

Selects the measurement time or switches to manual averaging mode. In general, results are more precise with longer measurement times. The following settings are recommended for different signal types to obtain stable and precise results:

|          |                                                                                                                                                                     |
|----------|---------------------------------------------------------------------------------------------------------------------------------------------------------------------|
| "Short"  | Stationary signals with high power (> -40dBm), because they require only a short measurement time and short measurement time provides the highest repetition rates. |
| "Normal" | Signals with lower power or modulated signals                                                                                                                       |
| "Long"   | Signals at the lower end of the measurement range (<-50 dBm) or Signals with lower power to minimize the influence of noise                                         |
| "Manual" | Manual averaging mode. The average count is set with the <a href="#">Average Count ( Number of Readings )</a> setting.                                              |

Remote command:

[SENSe:] PMETer<p>:MTIME on page 829

[SENSe:] PMETer<p>:MTIME:AVERage[:STATe] on page 829

### Setting the Reference Level from the Measurement Meas -> Ref

Sets the currently measured power as a reference value for the relative display. The reference value can also be set manually via the [Reference Value](#) setting.

Remote command:

CALCulate<n>:PMETer<p>:RELative[:MAGNitude]:AUTO ONCE on page 826

### Reference Value

Defines the reference value for relative measurements in the unit dBm.

Remote command:

CALCulate<n>:PMETer<p>:RELative[:MAGNitude] on page 826

### Use Ref Level Offset

If activated, takes the reference level offset defined for the analyzer into account for the measured power (see "[Shifting the Display \( Offset \)](#)" on page 355).

If deactivated, takes no offset into account.

Remote command:

[SENSe:] PMETer<p>:ROFFset[:STATe] on page 830

**Average Count ( Number of Readings )**

Defines the number of readings (averages) to be performed after a single sweep has been started. This setting is only available if manual averaging is selected ( [Meas Time/Average](#) setting).

The values for the average count range from 0 to 256 in binary steps (1, 2, 4, 8, ...). For average count = 0 or 1, one reading is performed. The general averaging and sweep count for the trace are independent from this setting.

Results become more stable with extended average, particularly if signals with low power are measured. This setting can be used to minimize the influence of noise in the power sensor measurement.

Remote command:

[\[SENSe:\] PMETer<p>:MTIME:AVERage:COUNT](#) on page 829

**Duty Cycle**

Sets the duty cycle to a percent value for the correction of pulse-modulated signals and activates the duty cycle correction. With the correction activated, the sensor calculates the signal pulse power from this value and the mean power.

Remote command:

[\[SENSe:\] PMETer<p>:DCYCLE\[:STATe\]](#) on page 827

[\[SENSe:\] PMETer<p>:DCYCLE:VALue](#) on page 827

**Using the power sensor as an external trigger**

If activated, the power sensor creates a trigger signal when a power higher than the defined "External Trigger Level" is measured. This trigger signal can be used as an external power trigger by the R&S FPS.

This setting is only available in conjunction with a compatible power sensor.

For details on using a power sensor as an external trigger, see ["Using a Power Sensor as an External Power Trigger"](#) on page 306.

Remote command:

[\[SENSe:\] PMETer<p>:TRIGger\[:STATe\]](#) on page 834

TRIG:SOUR EXT, see [TRIGger\[:SEQUence\]:SOURce](#) on page 803

**External Trigger Level ← Using the power sensor as an external trigger**

Defines the trigger level for the power sensor trigger.

For details on supported trigger levels, see the data sheet.

Remote command:

[\[SENSe:\] PMETer<p>:TRIGger:LEVel](#) on page 833

**Hysteresis ← Using the power sensor as an external trigger**

Defines the distance in dB to the trigger level that the trigger source must exceed before a trigger event occurs. Setting a hysteresis avoids unwanted trigger events caused by noise oscillation around the trigger level.

Remote command:

[\[SENSe:\] PMETer<p>:TRIGger:HYSTeresis](#) on page 832

**Trigger Holdoff ← Using the power sensor as an external trigger**

Defines the minimum time (in seconds) that must pass between two trigger events. Trigger events that occur during the holdoff time are ignored.

Remote command:

[SENSe:] PMETer<p>:TRIGger:HOLDoff on page 832

**Drop-Out Time ← Using the power sensor as an external trigger**

Defines the time the input signal must stay below the trigger level before triggering again.

**Slope ← Using the power sensor as an external trigger**

Defines whether triggering occurs when the signal rises to the trigger level or falls down to it.

Remote command:

[SENSe:] PMETer<p>:TRIGger:SLOPe on page 833

**7.2.3.3 How to Work With a Power Sensor**

The following step-by-step instructions demonstrate how to set up a power sensor. For details on individual functions and settings see [Chapter 7.2.3.2, "Power Sensor Settings"](#), on page 307.

The remote commands required to perform these tasks are described in [Chapter 12.7.6.3, "Working with Power Sensors"](#), on page 823.



Power sensors can also be used to trigger a measurement at a specified power level, e.g. from a signal generator.

This is described in [Chapter 7.2.3.4, "How to Configure a Power Sensor as an External Trigger"](#), on page 314.

**How to Set Up a Power Sensor**

Up to 4 external power sensors can be configured separately and used for precise power measurement. All power sensors can be activated and deactivated individually.

The following procedure describes in detail how to configure and activate power sensors.

1. To display the "Power Sensor" tab of the "Input" dialog box, do one of the following:
  - Select "Input" from the "Overview" .
  - Select the INPUT/OUTPUT key and then the "Power Sensor Config" softkey.
2. Select the tab for the power sensor index you want to configure, e.g. "Power Sensor 1" .
3. Press "Select" to analyze the power sensor data according to the current configuration when power measurement is activated.
4. From the selection list with serial numbers of connected power sensors, select the sensor you want to configure.



- To have newly connected power sensors assigned to a tab automatically (default), select "Auto" .
5. Define the frequency of the signal whose power you want to measure.
    - a) To define the frequency manually, select "Frequency Manual" and enter a frequency.
    - b) To determine the frequency automatically, select "Frequency Coupling" and then either "Center" , to use the center frequency, or "Marker" , to use the frequency defined by marker 1.
  6. Select the unit for the power result display.
  7. Select the measurement time for which the average is calculated, or define the number of readings to average. To define the number of readings to be taken into account manually, select "Manual" and enter the number in the "Number of Readings" field.
  8. To activate the duty cycle correction, select "DutyCycle" and enter a percentage as the correction value.
  9. If you selected "dB" or "%" as units (relative display), define a reference value:
    - a) To set the currently measured power as a reference value, press the "Meas -> Ref" button.
    - b) Alternatively, enter a value manually in the "Reference Value" field.
    - c) Optionally, select the "Use Ref Level Offset" option to take the reference level offset set for the analyzer into account for the measured power.
  10. If necessary, repeat steps 3-10 for another power sensor.
  11. Set the "Power Sensor State" at the top of the "Power Sensor" tab to "On" to activate power measurement for the selected power sensors.

The results of the power measurement are displayed in the marker table (Function: "Sensor <1...4>" ).

### How to Zero the Power Sensor

1. To display the "Power Sensor" tab of the "Input" dialog box, do one of the following:
  - Select "Input" from the "Overview" .
  - Select the INPUT/OUTPUT key and then the "Power Sensor Config" softkey.
2. Select the tab that is assigned to the power sensor you want to zero.
3. Press the "Zeroing Power Sensor" button.

A dialog box is displayed that prompts you to disconnect all signals from the input of the power sensor.
4. Disconnect all signals sending input to the power sensor and press ENTER to continue.
5. Wait until zeroing is complete.

A corresponding message is displayed.

#### 7.2.3.4 How to Configure a Power Sensor as an External Trigger

The following step-by-step instructions demonstrate how to configure a power sensor to be used as an external power sensor trigger.

##### To configure a power sensor as an external trigger

1. Connect a compatible power sensor to one of the USB interfaces on the rear panel of the R&S FPS. (For details on supported sensors see ["Using a Power Sensor as an External Power Trigger"](#) on page 306).
2. Set up the power sensor as described in ["How to Set Up a Power Sensor"](#) on page 312.
3. In the "Power Sensor" tab of the "Input" dialog box, select the "External Power Trigger" option.
4. Enter the power level at which a trigger signal is to be generated ( "External Trigger Level" ) and the other trigger settings for the power sensor trigger.
5. Press the TRIG key and then select "Trigger/ Gate Config" .
6. In the "Trigger And Gate" dialog box, select "Signal Source" = External Trigger 1/2.

The R&S FPS is configured to trigger when the defined conditions for the power sensor occur.

### 7.2.4 External Generator Control

You can operate various commercially available generators as an external generator with the R&S FPS. Thus, scalar network analysis with the R&S FPS is possible.

- [About External Generator Control](#).....314
- [Basics on External Generator Control](#).....315
- [External Generator Control Settings](#)..... 323
- [How to Work With External Generator Control](#)..... 330
- [Measurement Example: Calibration with an External Generator](#)..... 333

#### 7.2.4.1 About External Generator Control

A common measurement setup includes a signal generator, a device under test (DUT), and a signal and spectrum analyzer, for example the R&S FPS. In this setup, the signal analyzer can control which signal the generator is to send, which is in turn measured by the analyzer. This process is referred to as *external generator control*. The generator in this setup is referred to as a *tracking generator*.

A measurement with a tracking generator is useful to measure any effects on the power level caused by the cables and connectors from the signal generator and the

signal analyzer in advance. The known effects can then be removed from the measurement results in order to obtain accurate information on the DUT.

#### 7.2.4.2 Basics on External Generator Control

Some background knowledge on basic terms and principles used for external generator control is provided here for a better understanding of the required configuration settings.



External generator control is only available in the following applications.

- Spectrum Analyzer
- I/Q Analyzer
- Analog Demodulation
- Noise Figure Measurements

|                                                                             |     |
|-----------------------------------------------------------------------------|-----|
| • <a href="#">External Generator Connections</a> .....                      | 315 |
| • <a href="#">Overview of Supported Generators</a> .....                    | 316 |
| • <a href="#">Generator Setup Files</a> .....                               | 317 |
| • <a href="#">Calibration Mechanism</a> .....                               | 317 |
| • <a href="#">Normalization</a> .....                                       | 318 |
| • <a href="#">Reference Trace, Reference Line and Reference Level</a> ..... | 319 |
| • <a href="#">Coupling the Frequencies</a> .....                            | 320 |
| • <a href="#">Displayed Information and Errors</a> .....                    | 322 |

#### External Generator Connections

The external generator is controlled via a LAN connection.

For more information on configuring interfaces see [Chapter 4.4.1, "Remote Control Interfaces and Protocols"](#), on page 51.

#### Transmission Measurement

This measurement yields the transmission characteristics of a two-port network. The external generator is used as a signal source. It is connected to the input connector of the DUT. The input of the R&S FPS is fed from the output of the DUT. A calibration can be carried out to compensate for the effects of the test setup (e.g. frequency response of connecting cables).

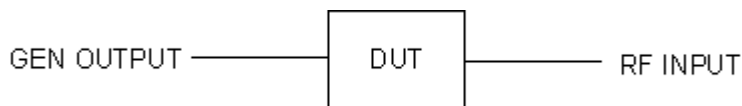

*Figure 7-3: Test setup for transmission measurement*

#### Reflection Measurement

Scalar reflection measurements can be carried out using a reflection-coefficient measurement bridge.

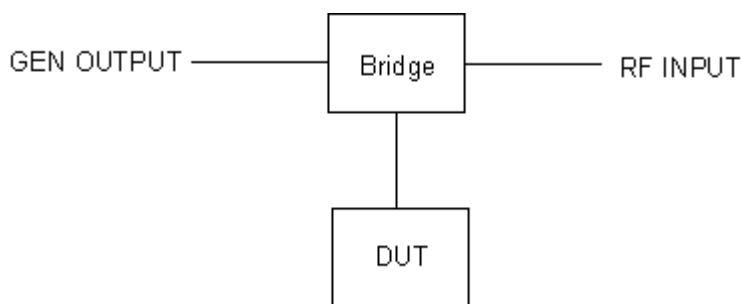

Figure 7-4: Test setup for reflection measurement

### Generated signal input

In order to use the functions of the external generator, an appropriate generator must be connected and configured correctly. In particular, the generator output must be connected to the RF input of the R&S FPS.

### External reference frequency

In order to enhance measurement accuracy, a common reference frequency should be used for both the R&S FPS and the generator. If no independent 10 MHz reference frequency is available, it is recommended that you connect the reference output of the generator with the reference input of the R&S FPS and that you enable usage of the external reference on the R&S FPS via "SETUP" > "Reference" > "External Reference".

For more information on external references see [Chapter 10.4, "Reference Frequency Settings"](#), on page 558.

### Connection errors

If no external generator is connected, if the connection address is not correct, or the generator is not ready for operation, an error message is displayed (e.g. "Ext. Generator TCP/IP Handshake Error!", see ["Displayed Information and Errors"](#) on page 322).

### Overview of Supported Generators

| Generator type                                                                                                                                                                                  | Generator type |
|-------------------------------------------------------------------------------------------------------------------------------------------------------------------------------------------------|----------------|
| SGS100A12                                                                                                                                                                                       | SMF100A        |
| SGS100A6                                                                                                                                                                                        | SMF22          |
| SGT100A3 <sup>3)</sup>                                                                                                                                                                          | SMF22B2        |
| SGT100A6 <sup>3)</sup>                                                                                                                                                                          | SMF43          |
| SMA01A <sup>1)</sup>                                                                                                                                                                            | SMF43B2        |
| SMA100A3 <sup>1)</sup>                                                                                                                                                                          | SMJ03          |
| 1) Requires firmware version V2.10.x or higher on the signal generator<br>2) Requires firmware version V1.10.x or higher on the signal generator<br>3) only for R&S FPS version 1.21 and higher |                |

| Generator type                                                                                                                                                                                  | Generator type         |
|-------------------------------------------------------------------------------------------------------------------------------------------------------------------------------------------------|------------------------|
| SMA100A6 <sup>1)</sup>                                                                                                                                                                          | SMJ06                  |
| SMB100A1                                                                                                                                                                                        | SMU02 <sup>2)</sup>    |
| SMB100A12                                                                                                                                                                                       | SMU02B31 <sup>2)</sup> |
| SMB100A2                                                                                                                                                                                        | SMU03 <sup>2)</sup>    |
| SMB100A20                                                                                                                                                                                       | SMU03B31 <sup>2)</sup> |
| SMB100A3                                                                                                                                                                                        | SMU04 <sup>2)</sup>    |
| SMB100A40                                                                                                                                                                                       | SMU04B31 <sup>2)</sup> |
| SMB100A6                                                                                                                                                                                        | SMU06 <sup>2)</sup>    |
| SMBV100A3                                                                                                                                                                                       | SMU06B31 <sup>2)</sup> |
| SMBV100A6                                                                                                                                                                                       | SMW03                  |
| SMC100A1                                                                                                                                                                                        | SMW06                  |
| SMC100A3                                                                                                                                                                                        |                        |
| 1) Requires firmware version V2.10.x or higher on the signal generator<br>2) Requires firmware version V1.10.x or higher on the signal generator<br>3) only for R&S FPS version 1.21 and higher |                        |

### Generator Setup Files

For each signal generator type to be controlled by the R&S FPS a generator setup file must be configured and stored on the R&S FPS. The setup file defines the frequency and power ranges supported by the generator, as well as information required for communication. For the signal generators listed in ["Overview of Supported Generators"](#) on page 316, default setup files are provided. If necessary, these files can be edited or duplicated for varying measurement setups or other instruments.

The existing setup files can be displayed in an editor in read-only mode directly from the "External Generator" configuration dialog box. From there, they can be edited and stored under a different name, and are then available on the R&S FPS.

(For details see ["To define a new generator setup file"](#) on page 332).

### Calibration Mechanism

A common measurement setup includes a signal generator, a device under test (DUT), and a signal and spectrum analyzer. Therefore, it is useful to measure the attenuation or gain caused by the cables and connectors from the signal generator and the signal analyzer in advance. The known level offsets can then be removed from the measurement results in order to obtain accurate information on the DUT.

Calculating the difference between the currently measured power and a reference trace is referred to as *calibration*. Thus, the measurement results from the controlled external generator - including the inherent distortions - can be used as a reference trace to calibrate the measurement setup.

The inherent frequency and power level distortions can be determined by connecting the R&S FPS to the signal generator. The R&S FPS sends a predefined list of frequencies to the signal generator (see also "Coupling the Frequencies" on page 320). The signal generator then sends a signal with the specified level at each frequency in the predefined list. The R&S FPS measures the signal and determines the level offsets to the expected values.

### Saving calibration results

A reference dataset for the calibration results is stored internally as a table of value pairs (frequency/level), one for each sweep point. The measured offsets can then be used as calibration factors for subsequent measurement results.

The calibration can be performed using either transmission or reflection measurements. The selected type of measurement used to determine the reference trace is included in the reference dataset.

### Normalization

Once the measurement setup has been calibrated and the reference trace is available, subsequent measurement results can be corrected according to the calibration factors, if necessary. This is done by subtracting the reference trace from the measurement results. This process is referred to as *normalization* and can be activated or deactivated as required. If normalization is activated, "NOR" is displayed in the channel bar, next to the indication that an external generator is being used ("Ext.Gen"). The normalized trace from the calibration sweep is a constant 0 dB line, as  $\text{<calibration trace> - <reference trace> = 0}$ .

*As long as the same settings are used for measurement as for calibration*, the normalized measurement results should not contain any inherent frequency or power distortions. Thus, the measured DUT values are very accurate.

### Approximate normalization

As soon as any of the calibration measurement settings are changed, the stored reference trace will no longer be identical to the new measurement results. However, if the measurement settings do not deviate too much, the measurement results can still be normalized *approximately* using the stored reference trace. This is indicated by the "APX" label in the channel bar (instead of "NOR").

This is the case if one or more of the following values deviate from the calibration settings:

- Coupling (RBW, VBW, SWT)
- Reference level, RF attenuation
- Start or stop frequency
- Output level of external generator
- Detector (max. peak, min. peak, sample, etc.)
- Frequency deviation at a maximum of 1001 points within the set sweep limits (corresponds to a doubling of the span)

Differences in level settings between the reference trace and the current instrument settings are taken into account automatically. If the span is reduced, a linear interpola-

tion of the intermediate values is applied. If the span increases, the values at the left or right border of the reference dataset are extrapolated to the current start or stop frequency, i.e. the reference dataset is extended by constant values.

Thus, the instrument settings can be changed in a wide area without giving up normalization. This reduces the necessity to carry out a new normalization to a minimum.

If approximation becomes too poor, however, normalization is aborted and an error message is displayed (see ["Displayed Information and Errors"](#) on page 322).

### The normalized trace in the display

The normalized reference trace is also displayed in the spectrum diagram, by default at the top of the diagram (= 100% of the window height). It is indicated by a red line labeled "NOR", followed by the current reference value. However, it can be shifted vertically to reflect an attenuation or gain caused by the measured DUT (see also ["Shifting the reference line \(and normalized trace\)"](#) on page 320).

### Restoring the calibration settings

If the measurement settings no longer match the instrument settings with which the calibration was performed (indicated by the "APX" or no label next to "Ext.TG" in the channel bar), you can restore the calibration settings, which are stored with the reference dataset on the R&S FPS.

### Storing the normalized reference trace as a transducer factor

The (inverse) normalized reference trace can also be stored as a *transducer factor* for use in other R&S FPS applications that do not support external generator control. The normalized trace data is converted to a transducer with unit dB and stored in a file with the specified name and the suffix `.trd` under `c:\r_s\instr\trd`. The frequency points are allocated in equidistant steps between the start and stop frequency.

This is useful, for example, to determine the effects of a particular device component and then remove these effects from a subsequent measurement which includes this component.

For an example see ["How to Remove the Effects of a Particular Component from Measurement Results Using Calibration"](#) on page 332.



Note that the *normalized* measurement data is stored, not the original *reference* trace! Thus, if you store the normalized trace directly after calibration, without changing any settings, the transducer factor will be 0 dB for the entire span (by definition of the normalized trace).

---

## Reference Trace, Reference Line and Reference Level

### Reference trace

The calibration results are stored internally on the R&S FPS as a *reference trace*. For each measured sweep point the offset to the expected values is determined. If normali-

zation is activated, the offsets in the reference trace are removed from the current measurement results to compensate for the inherent distortions.

### Reference line

The reference line is defined by the [Reference Value](#) and [Reference Position](#) in the "External Generator" > "Source Calibration" settings. It is similar to the [Reference Level](#) defined in the "Amplitude" settings. However, as opposed to the reference *level*, this reference *line* only affects the y-axis scaling in the diagram, it has no effect on the expected input power level or the hardware settings.

The reference line determines the range and the scaling of the y-axis, just as the reference level does.

The normalized reference trace (0 dB directly after calibration) is displayed on this reference line, indicated by a red line in the diagram. By default, the reference line is displayed at the top of the diagram. If you shift the reference line, the normalized trace is shifted, as well.

### Shifting the reference line (and normalized trace)

You can shift the reference line - and thus the normalized trace - in the result display by changing the [Reference Position](#) or the [Reference Value](#) .

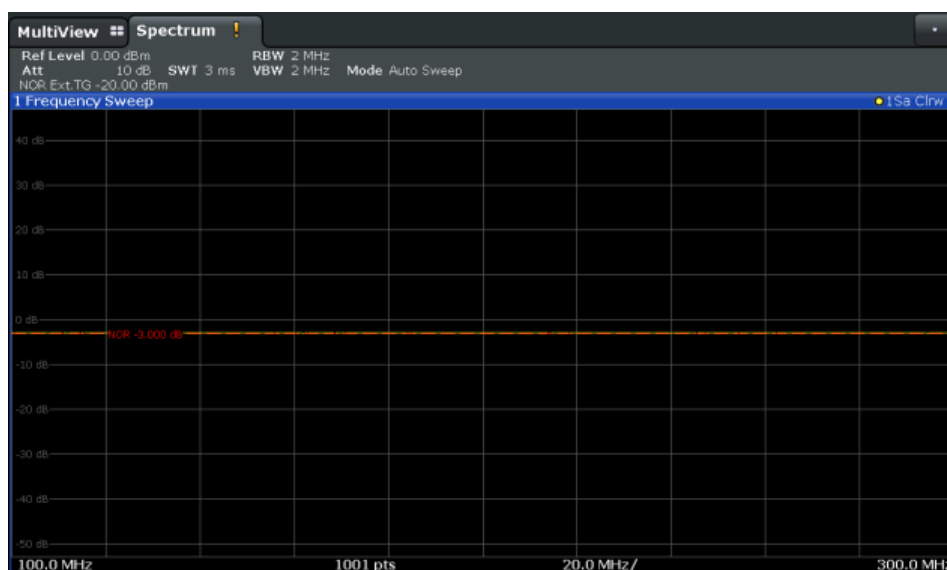

Figure 7-5: Shifted reference line

If the DUT inserts a gain or an attenuation in the measurement, this effect can be reflected in the result display on the R&S FPS. To reflect a power offset in the measurement trace, change the [Reference Value](#) .

For a detailed example see [Chapter 7.2.4.5, "Measurement Example: Calibration with an External Generator"](#), on page 333.

### Coupling the Frequencies

As described in ["Normalization"](#) on page 318, normalized measurement results are very accurate *as long as the same settings are used as for calibration*. Although



approximate normalization is possible, it is important to consider the required frequencies for calibration in advance. The frequencies and levels supported by the connected signal generator are provided for reference with the interface configuration.

Two different methods are available to define the frequencies for calibration, that is to couple the frequencies of the R&S FPS with those of the signal generator:

- **Manual coupling:** a single frequency is defined
- **Automatic coupling:** a series of frequencies is defined (one for each sweep point), based on the current frequency at the RF input of the R&S FPS; the RF frequency range covers the currently defined span of the R&S FPS (unless limited by the range of the signal generator)

### Automatic coupling

If automatic coupling is used, the output frequency of the generator (source frequency) is calculated as follows:

$$F_{Generator} = \left| F_{Analyzer} * \frac{Numerator}{Denominator} + F_{Offset} \right|$$

*Equation 7-1: Output frequency of the generator*

Where:

$F_{Generator}$  = output frequency of the generator

$F_{Analyzer}$  = current frequency at the RF input of the R&S FPS

Numerator = multiplication factor for  $F_{Analyzer}$

Denominator = division factor for  $F_{Analyzer}$

$F_{Offset}$  = frequency offset for  $F_{Analyzer}$ , for example for frequency-converting measurements or harmonics measurements

The value range for the offset depends on the selected generator. The default setting is 0 Hz. Offsets other than 0 Hz are indicated by the "FRQ" label in the channel bar (see also "[Displayed Information and Errors](#)" on page 322).

### Swept frequency range

The  $F_{Analyzer}$  values for the calibration sweep start with the start frequency and end with the stop frequency defined in the "Frequency" settings of the R&S FPS. The resulting output frequencies ( [Result Frequency Start](#) and [Result Frequency Stop](#) ) are displayed in "External Generator" > "Measurement Configuration" for reference.

If the resulting frequency range exceeds the allowed ranges of the signal generator, an error message is displayed (see "[Displayed Information and Errors](#)" on page 322) and the [Result Frequency Start](#) and [Result Frequency Stop](#) values are corrected to comply with the range limits.



The calibration sweep nevertheless covers the entire span defined by the R&S FPS; however, no input is received from the generator outside the generator's defined limits.

### Reverse sweep

The frequency offset for automatic coupling can be used to sweep in the reverse direction. To do so, define a negative offset in the external generator measurement configuration. (Note that the frequency is defined as the unsigned value of the equation, thus a negative frequency is not possible.)

#### Example: Example for reverse sweep

$$F_{\text{AnalyzerStart}} = 100 \text{ MHz}$$

$$F_{\text{AnalyzerStop}} = 200 \text{ MHz}$$

$$F_{\text{Offset}} = -300 \text{ MHz}$$

$$\text{Numerator} = \text{Denominator} = 1$$

$$\rightarrow F_{\text{GeneratorStart}} = 200 \text{ MHz}$$

$$\rightarrow F_{\text{GeneratorStop}} = 100 \text{ MHz}$$

If the offset is adjusted so that the sweep of the generator crosses the minimum generator frequency, a message is displayed in the status bar ("Reverse Sweep via min. Ext. Generator Frequency!").

#### Example: Example for reverse sweep via minimum frequency

$$F_{\text{AnalyzerStart}} = 100 \text{ MHz}$$

$$F_{\text{AnalyzerStop}} = 200 \text{ MHz}$$

$$F_{\text{Offset}} = -150 \text{ MHz}$$

$$F_{\text{min}} = 20 \text{ MHz}$$

$$\text{Numerator} = \text{Denominator} = 1$$

$$\rightarrow F_{\text{GeneratorStart}} = 50 \text{ MHz}$$

$$\rightarrow F_{\text{GeneratorStop}} = 50 \text{ MHz via } F_{\text{min}}$$

### Displayed Information and Errors

#### Channel bar

If external generator control is active, some additional information is displayed in the channel bar.

| Label                  | Description                                                                                                        |
|------------------------|--------------------------------------------------------------------------------------------------------------------|
| EXT TG: <source power> | External generator active; signal sent with <source power> level                                                   |
| LVL                    | Power Offset (see " <a href="#">Source Offset</a> " on page 326)                                                   |
| FRQ                    | Frequency Offset (see " <a href="#">(Automatic) Source Frequency (Numerator/Denominator/Offset)</a> " on page 327) |
| NOR                    | Normalization on;<br>No difference between reference setting and measurement                                       |

| Label               | Description                                                      |
|---------------------|------------------------------------------------------------------|
| APX (approximation) | Normalization on;<br>Deviation from the reference setting occurs |
| -                   | Aborted normalization or no calibration performed yet            |

### Error and status messages

The following status and error messages may occur during external generator control.

| Message                                            | Description                                                                                                                                         |
|----------------------------------------------------|-----------------------------------------------------------------------------------------------------------------------------------------------------|
| "Ext. Generator TCPIP Handshake Error!" /          | Connection to the generator is not possible, e.g. due to a cable damage or loose connection or wrong address.                                       |
| "Ext. Generator Limits Exceeded!"                  | The allowed frequency or power ranges for the generator were exceeded.                                                                              |
| "Reverse Sweep via min. Ext. Generator Frequency!" | Reverse sweep is performed; frequencies are reduced to the minimum frequency, then increased again; see <a href="#">"Reverse sweep"</a> on page 322 |
| "Ext. Generator File Syntax Error!"                | Syntax error in the generator setup file (see <a href="#">"Generator Setup Files"</a> on page 317)                                                  |
| "Ext. Generator Command Error!"                    | Missing or wrong command in the generator setup file (see <a href="#">"Generator Setup Files"</a> on page 317)                                      |
| "Ext. Generator Visa Error!"                       | Error with Visa driver provided with installation (very unlikely)                                                                                   |

## NOTICE

### Overloading

At a reference level of -10 dBm and at an external generator output level of the same value, the R&S FPS operates without overrange reserve. That means the R&S FPS is in danger of being overloaded if a signal is applied whose amplitude is higher than the reference line. In this case, either the message "RF OVLD" for overload or "IF OVLD" for exceeded display range (clipping of the trace at the upper diagram border = overrange) is displayed in the status line.

Overloading can be avoided as follows:

- Reducing the output level of the external generator ([" Source Power "](#) on page 326 in "External Generator > Measurement Configuration")
- Increasing the reference level ([Reference Level](#) in the "Amplitude" menu)

#### 7.2.4.3 External Generator Control Settings

**Access:** INPUT/OUTPUT > "External Generator Config"

The "External Generator" settings are available if the R&S FPS External Generator Control option is installed. For each measurement channel, you can configure one

external generator. To switch between different configurations, define multiple measurement channels.

For more information on external generator control, see [Chapter 7.2.4.2, "Basics on External Generator Control"](#), on page 315.

- [Interface Configuration Settings](#).....324
- [Measurement Settings](#).....325
- [Source Calibration Functions](#).....328

**Interface Configuration Settings**

**Access:** INPUT/OUPUT > "External Generator Config" > "Interface Configuration" tab

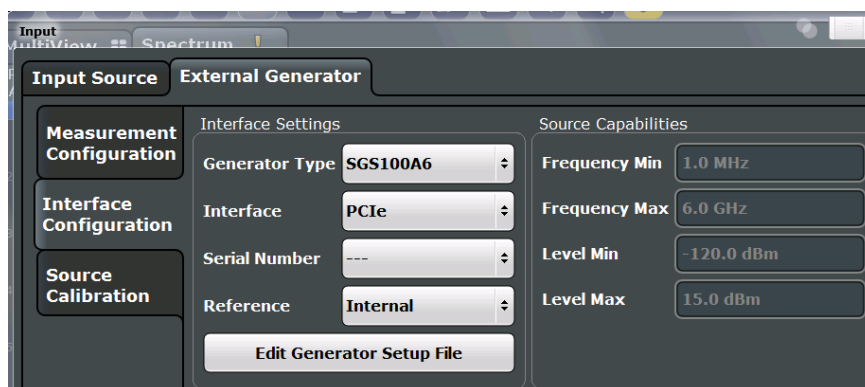

For more information on configuring interfaces, see [Chapter 4.4.1, "Remote Control Interfaces and Protocols"](#), on page 51.

- [Generator Type](#) ..... 324
- [Interface](#) ..... 324
- [TCPIP Address / Computer Name](#) ..... 325
- [Reference](#) ..... 325
- [Edit Generator Setup File](#) ..... 325
- [Frequency Min / Frequency Max](#) ..... 325
- [Level Min / Level Max](#) ..... 325

**Generator Type**

Selects the generator type and thus defines the generator setup file to use.

For an overview of supported generators, see ["Overview of Supported Generators"](#) on page 316. For information on generator setup files, see ["Generator Setup Files"](#) on page 317.

Remote command:

`SYSTem:COMMunicate:RDEvice:GENerator:TYPE` on page 818

**Interface**

Type of interface connection used. The following interfaces are currently supported:

- TCP/IP (not by all generators)

For details on which signal generators support which interfaces, see the documentation of the corresponding signal generator.

Remote command:

[SYSTem:COMMunicate:RDEvice:GENerator:INTerface](#) on page 818

#### **TCPIP Address / Computer Name**

For LAN connections only: TCP/IP address of the signal generator

Remote command:

[SYSTem:COMMunicate:TCPIP:RDEvice:GENerator:ADDRes](#) on page 818

#### **Reference**

Selects the internal R&S FPS or an external frequency reference to synchronize the R&S FPS with the generator (default: internal).

Remote command:

[SOURce:EXTernal:ROSCillator\[:SOURce\]](#) on page 817

#### **Edit Generator Setup File**

Displays the setup file for the currently selected [Generator Type](#) in read-only mode in an editor.

Although the existing setup files are displayed in read-only mode in the editor, they can be saved under a different name (using "File > SaveAs").

Be careful, however, to adhere to the required syntax and commands. Errors are only detected and displayed when you try to use the new generator (see also "[Displayed Information and Errors](#)" on page 322).

For details, see "[Generator Setup Files](#)" on page 317.

#### **Frequency Min / Frequency Max**

For reference only: Lower and upper frequency limit for the generator.

#### **Level Min / Level Max**

For reference only: Lower and upper power limit for the generator.

#### **Measurement Settings**

**Access:** INPUT/OUTPUT > "External Generator Config" > "Measurement Configuration" tab

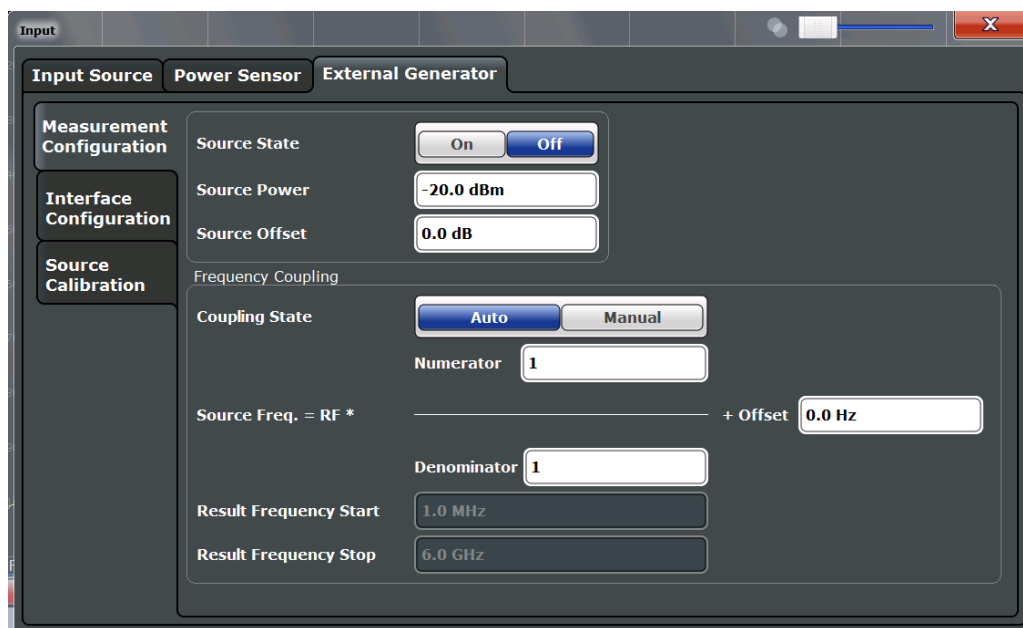

|                                                                  |     |
|------------------------------------------------------------------|-----|
| Source State .....                                               | 326 |
| Source Power .....                                               | 326 |
| Source Offset .....                                              | 326 |
| Source Frequency Coupling.....                                   | 327 |
| (Manual) Source Frequency.....                                   | 327 |
| (Automatic) Source Frequency (Numerator/Denominator/Offset)..... | 327 |
| Result Frequency Start .....                                     | 328 |
| Result Frequency Stop .....                                      | 328 |

**Source State**

Activates or deactivates control of an external generator.

Remote command:

[SOURce:EXTernal\[:STATe\]](#) on page 817

**Source Power**

The output power of the external generator. The default output power is -20 dBm. The range is specified in the data sheet.

Remote command:

[SOURce:EXTernal:POWer\[:LEVel\]](#) on page 816

**Source Offset**

Constant level offset for the external generator. Values from -200 dB to +200 dB in 1 dB steps are allowed. The default setting is 0 dB. Offsets are indicated by the "LVL" label in the channel bar (see also "Displayed Information and Errors" on page 322).

Using this offset, attenuators or amplifiers at the output connector of the external generator can be taken into account. This is useful, for example, for the displayed output power values on screen or during data entry. Positive offsets apply to an amplifier, while negative offsets apply to an attenuator after the external generator.

Remote command:

`SOURce:POWer[:LEVel][:IMMediate]:OFFSet` on page 817

### Source Frequency Coupling

Defines the frequency coupling mode between the R&S FPS and the generator.

For more information on coupling frequencies, see "[Coupling the Frequencies](#)" on page 320.

- |          |                                                                                                                                                                                                                                                                                                                                                                                 |
|----------|---------------------------------------------------------------------------------------------------------------------------------------------------------------------------------------------------------------------------------------------------------------------------------------------------------------------------------------------------------------------------------|
| "Auto"   | Default setting: a series of frequencies is defined (one for each sweep point), based on the current frequency at the RF input of the R&S FPS (see " <a href="#">(Automatic) Source Frequency (Numerator/Denominator/Offset)</a> " on page 327). The RF frequency range covers the currently defined span of the R&S FPS (unless limited by the range of the signal generator). |
| "Manual" | The generator uses a single fixed frequency, defined by <a href="#">(Manual) Source Frequency</a> which is displayed when you select "Manual" coupling.                                                                                                                                                                                                                         |

Remote command:

`SOURce:EXTeRnal:FREQuency:COUPling[:STATe]` on page 815

### (Manual) Source Frequency

Defines the fixed frequency to be used by the generator.

Remote command:

`SOURce:EXTeRnal:FREQuency` on page 814

### (Automatic) Source Frequency (Numerator/Denominator/Offset)

With automatic frequency coupling, a series of frequencies is defined (one for each sweep point), based on the current frequency at the RF input of the R&S FPS.

However, the frequency used by the generator may differ from the input from the R&S FPS. The RF frequency can be multiplied by a specified factor, or a frequency offset can be added, or both.

**Note:** The input for the generator frequency is not validated, i.e. you can enter any values. However, if the allowed frequency ranges of the generator are exceeded, an error message is displayed on the R&S FPS. The values for [Result Frequency Start](#) and [Result Frequency Stop](#) are corrected to comply with the range limits.

The value range for the offset depends on the selected generator. The default setting is 0 Hz. Offsets  $\neq$  0 Hz are indicated by the "FRQ" label in the channel bar. Negative offsets can be used to define reverse sweeps.

For more information on coupling frequencies and reverse sweeps, see "[Coupling the Frequencies](#)" on page 320. For more information on error messages and the channel bar, see "[Displayed Information and Errors](#)" on page 322.

Remote command:

`SOURce:EXTeRnal:FREQuency[:FACTor]:DENominator` on page 815

`SOURce:EXTeRnal:FREQuency[:FACTor]:NUMerator` on page 816

`SOURce:EXTeRnal:FREQuency:OFFSet` on page 816

**Result Frequency Start**

For reference only: The start frequency for the generator, calculated from the configured generator frequency and the start value defined for the R&S FPS.

**Result Frequency Stop**

For reference only: The stop frequency for the generator, calculated from the configured generator frequency and the stop value defined for the R&S FPS.

**Source Calibration Functions**

**Access:** INPUT/OUPUT > "External Generator Config" > "Source Calibration" tab

The calibration functions of the external generator are available *only if external generator control is active* (see " [Source State](#) " on page 326).

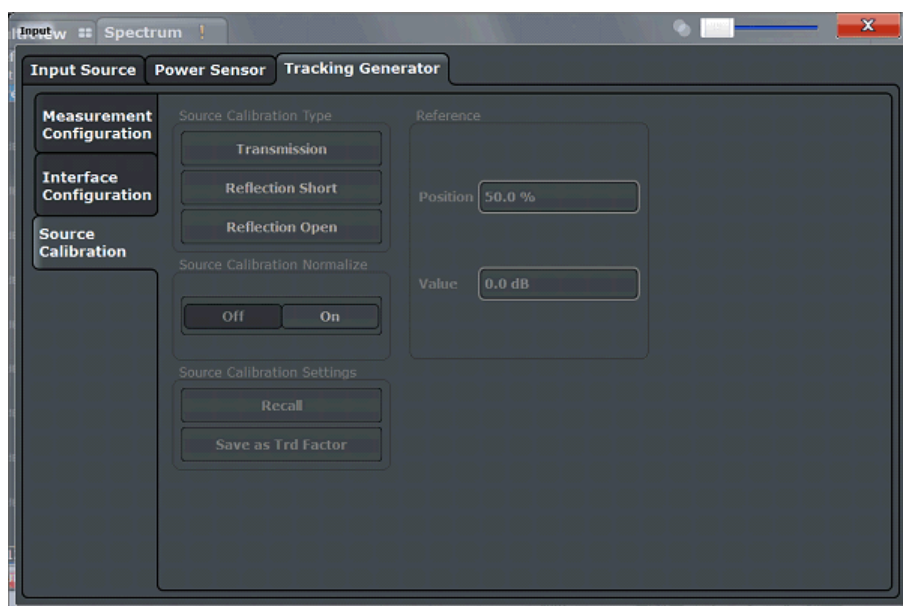

|                                                    |     |
|----------------------------------------------------|-----|
| <a href="#">Calibrate Transmission</a> .....       | 328 |
| <a href="#">Calibrate Reflection Short</a> .....   | 329 |
| <a href="#">Calibrate Reflection Open</a> .....    | 329 |
| <a href="#">Source Calibration Normalize</a> ..... | 329 |
| <a href="#">Recall</a> .....                       | 329 |
| <a href="#">Save as Trd Factor</a> .....           | 329 |
| <a href="#">Reference Position</a> .....           | 330 |
| <a href="#">Reference Value</a> .....              | 330 |

**Calibrate Transmission**

Starts a transmission type measurement to determine a reference trace. This trace is used to calculate the difference for the normalized values.

For details, see "[Calibration Mechanism](#)" on page 317.

Remote command:

[SENSe:]CORRection:METhod on page 820



**Calibrate Reflection Short**

Starts a short-circuit reflection type measurement to determine a reference trace for calibration.

If both calibrations (open circuit, short circuit) are carried out, the calibration trace is calculated by averaging the two measurements. The order of the two calibration measurements is irrelevant.

Remote command:

[\[SENSe:\]CORRection:MEtHod](#) on page 820

Selects the reflection method.

[\[SENSe:\]CORRection:COLLect\[:ACQuire\]](#) on page 819

Starts the sweep for short-circuit calibration.

**Calibrate Reflection Open**

Starts an open-circuit reflection type measurement to determine a reference trace for calibration.

If both reflection-type calibrations (open circuit, short circuit) are carried out, the reference trace is calculated by averaging the two measurements. The order of the two calibration measurements is irrelevant.

Remote command:

[\[SENSe:\]CORRection:MEtHod](#) on page 820

Selects the reflection method.

[\[SENSe:\]CORRection:COLLect\[:ACQuire\]](#) on page 819

Starts the sweep for open-circuit calibration.

**Source Calibration Normalize**

Switches the normalization of measurement results on or off. This function is only available if the memory contains a reference trace, that is, after a calibration has been performed.

For details on normalization, see "[Normalization](#)" on page 318.

Remote command:

[\[SENSe:\]CORRection\[:STATe\]](#) on page 821

**Recall**

Restores the settings that were used during source calibration. This can be useful if instrument settings were changed after calibration (e.g. center frequency, frequency deviation, reference level, etc.).

Remote command:

[\[SENSe:\]CORRection:RECall](#) on page 821

**Save as Trd Factor**

Uses the normalized measurement data to generate a transducer factor. The trace data is converted to a transducer with unit dB and stored in a file with the specified name and the suffix `.trd` under `"C:\R_S\INSTR\trd"`. The frequency points are allocated in equidistant steps between start and stop frequency. The generated transducer factor can be further adapted using the "Transducer" softkey in the SETUP menu.

For more information on transducers, see [Chapter 10.3.1, "Basics on Transducer Factors"](#), on page 546.

This function is only available if [Source Calibration Normalize](#) is switched on.

**Note:** Note that the *normalized* measurement data is used, not the *reference* trace! Thus, if you store the normalized trace directly after calibration, without changing any settings, the transducer factor will be 0 dB for the entire span (by definition of the normalized trace).

Remote command:

`[SENSe:]CORRection:TRANsducer:GENerate` on page 821

#### Reference Position

Defines the position of the [Result Frequency Stop](#) in percent of the total y-axis range. The top of the diagram is 100%, the bottom is 0%. By default, the 0 dB line is displayed at the top of the diagram (100%).

This setting is only available if normalization is on (see "[Source Calibration Normalize](#)" on page 329).

The reference line defined by the reference value and reference position is similar to the [Reference Level](#) defined in the "Amplitude" settings. However, this reference line only affects the y-axis scaling in the diagram, it has no effect on the expected input power level or the hardware settings.

The normalized trace (0 dB directly after calibration) is displayed on this reference line, indicated by a red line in the diagram. If you shift the reference line, the normalized trace is shifted, as well.

Remote command:

`DISPlay[:WINDow<n>]:TRACe<t>:Y[:SCALE]:RPOSITION` on page 798

#### Reference Value

Defines the reference value to be displayed at the specified [Result Frequency Start](#).

This setting can be used to shift the reference line and thus the normalized trace, similar to the [Shifting the Display \( Offset \)](#) defined in the "Amplitude" settings shifts the reference level *in the display*.

Shifting the normalized trace is useful, for example, to reflect an attenuation or gain caused by the measured DUT. If you then zoom into the diagram around the normalized trace, the measured trace still remains fully visible.

Remote command:

`DISPlay[:WINDow<n>]:TRACe<t>:Y[:SCALE]:RVALUE` on page 819

### 7.2.4.4 How to Work With External Generator Control

The following step-by-step instructions demonstrate how to work with the optional External Generator Control.



For remote operation, see "[Programming Example for External Generator Control](#)" on page 822.

---

- [How to Calibrate a Measurement Setup using an External Generator](#)..... 331
- [How to Remove the Effects of a Particular Component from Measurement Results Using Calibration](#).....332
- [How to Compensate for Additional Gain or Attenuation after Calibration](#)..... 333

### How to Calibrate a Measurement Setup using an External Generator

1. Connect the signal generator's LAN interface connector to the LAN connector on the rear panel of the R&S FPS.
2. Connect the signal generator output to the RF INPUT connector of the R&S FPS.
3. If the measurement setup does not require the full span of the R&S FPS, change the "Frequency Start" and "Frequency Stop" values (FREQ key > "Frequency Config" softkey).
4. Press the INPUT/OUTPUT key and select "External Generator Config".
5. In the "Interface Configuration" subtab, select the "Generator Type" connected to the R&S FPS.  
If the required generator type is not available, define a new setup file as described in ["To define a new generator setup file"](#) on page 332.
6. Select the type of interface and the address used to connect the generator to the R&S FPS.
7. Select "Reference: External" to synchronize the analyzer with the generator.
8. Switch to the "Measurement Configuration" subtab.
9. Set the "Source State" to "On".
10. Define the generator output level as the "Source Power".
11. Optionally, to define a constant level offset for the external generator, define a "Source Offset".
12. The default frequency list for the calibration sweep contains 1001 values, divided in equi-distant frequencies between the R&S FPS's start and stop frequency. For most cases, this automatic coupling should be correct. Check the "Result Frequency Start" and "Result Frequency Stop" values to make sure the required measurement span is covered. If necessary, change the frequency settings on the R&S FPS (FREQ key > "Frequency Config" softkey), or use a different generator type.
13. Switch to the "Source Calibration" subtab.
14. Select the "Source Calibration Type": "Transmission" to perform a calibration sweep and store a reference trace for the measurement setup.
15. Select "Source Calibration Normalize": "On".

16. Optionally, shift the reference line further down in the result display by decreasing the "Reference": "Position".

The measurement setup is now calibrated. Subsequent measurement results are normalized, so that any unwanted effects from the cables and connectors are removed.

#### To define a new generator setup file

1. Press the INPUT/OUTPUT key and select "External Generator Config".
2. In the "Interface Configuration" subtab, select a generator type that has similar characteristics (frequency and power ranges).
3. Select "Edit Generator Setup File".  
The configuration file for the selected generator type is displayed (read-only) in an editor.
4. Edit the configuration values according to your generator. Be sure not to change the syntax of the file - only change the *values* of the parameters.  
Errors will only be detected and displayed when you try to use the new generator (see also "[Displayed Information and Errors](#)" on page 322).
5. Save the file under a different name with the extension `.gen`:
  - a) In the editor, select "File > SaveAs".
  - b) Select "Save as type: All Files (\*.\*)".
  - c) Specify a name with the extension `.gen`.
6. In the R&S FPS firmware, close the "External Generator Config" dialog and re-open it.

Now you can select the new generator type from the selection list on the "Interface Configuration" tab.

#### How to Remove the Effects of a Particular Component from Measurement Results Using Calibration

1. Set up the measurement, including the component, and perform a calibration as described in "[How to Calibrate a Measurement Setup using an External Generator](#)" on page 331.
2. After setting "Source Calibration Normalize": "On", select "Save as Trd Factor" to store the normalized reference trace as a transducer factor.
3. If necessary, switch to another measurement channel for a different R&S FPS application.
4. Press the SETUP key, then select the "Transducer" softkey.
5. Select the stored transducer in the list of available transducers and select the "Active" setting for it.

6. Perform any measurement with the setup that contains the calibrated component.  
The measurement results do not include the effects from the component.

#### How to Compensate for Additional Gain or Attenuation after Calibration

If a gain or an attenuation is inserted in the measurement after calibration, this effect can be reflected in the display of the normalized trace on the R&S FPS. Thus, the measured trace and the normalized trace are not so far apart in the display, so that you can zoom into the normalized trace without cropping the measurement trace.

Prerequisite: a calibration has been performed for the original measurement setup, except for the component causing an additional gain or attenuation (as described in ["How to Calibrate a Measurement Setup using an External Generator"](#) on page 331)

1. Insert the additional component in the calibrated measurement setup and perform a new measurement.
2. Press the INPUT/OUTPUT key and select "External Generator Config".
3. Switch to the "Source Calibration" subtab.
4. With active normalization, set the "Reference": "Value" to the same value as the gain or attenuation the inserted component causes.
5. Optionally, shift the reference line further down in the result display by decreasing the "Reference": "Position".  
The normalized reference trace moves to the position of the measured trace.
6. Optionally, zoom into the measured trace by changing the y-axis scaling (or the range: "AMPT > Scale Config > Range").

The measured trace is still fully visible, and the absolute values are still valid.

#### 7.2.4.5 Measurement Example: Calibration with an External Generator

The following measurement example demonstrates the most common functions using an external generator. This example requires the External Generator Control option.

The example assumes an SMW100A generator is connected to the R&S FPS via TCP/IP. A band elimination filter is the device under test. After calibration, an additional attenuator is inserted between the DUT and the R&S FPS.

The following procedures are described:

- ["Calibrating the measurement setup"](#) on page 333
- ["Measuring the effects of the DUT"](#) on page 335
- ["Compensating the effects of additional attenuation after calibration"](#) on page 337

#### Calibrating the measurement setup

1. Connect the signal generator to the R&S FPS using a LAN cable.
2. Connect the signal generator output to the RF INPUT connector of the R&S FPS.

3. Adapt the measurement range of the R&S FPS to the filter to be tested. In this measurement, define the following settings:
  - a) Press the **FREQ** key, select "Frequency Config" and enter "Frequency Start": *100 MHz*.
  - b) Enter "Frequency Stop": *300 MHz*
4. Press the **INPUT/OUTPUT** key and select "External Generator Config".
5. In the "Interface Configuration" sub-tab, select "Generator Type": "SMW06".
6. Enter the TCP/IP address of the signal generator: *130.094.122.195*
7. Select "Reference: External" to synchronize the analyzer with the generator.
8. Switch to the "Measurement Configuration" sub-tab.
9. Set the "Source State" to "On".
10. Define the generator output level as the "Source Power": *-20 dBm*.
11. Set the "Coupling State" to "Auto".
 

The "Result Frequency Start" value for the generator is indicated as *100.0 MHz*.  
The "Result Frequency Stop" value is indicated as *300.0 MHz*.
12. Switch to the "Source Calibration" sub-tab.
13. Select the "Source Calibration Type": "Transmission" to perform a calibration sweep and store a reference trace for the measurement setup.



**Figure 7-6: Measurement results from generator, analyzer and connecting cables**

14. Select "Source Calibration Normalize": "On" to set the measurement results for the current setup to 0, thus eliminating all effects from the generator, the analyzer and

the connecting cables from subsequent measurements with the band elimination filter.

The reference line is displayed at 0 dB at the top of the diagram (100%).



*Figure 7-7: Normalized measurement results after calibration*

### Measuring the effects of the DUT

After calibration we can insert the band elimination filter (our DUT) in the measurement setup.

1. Connect the signal generator output to the band elimination filter.
2. Connect the band elimination filter output to the RF INPUT connector of the R&S FPS.

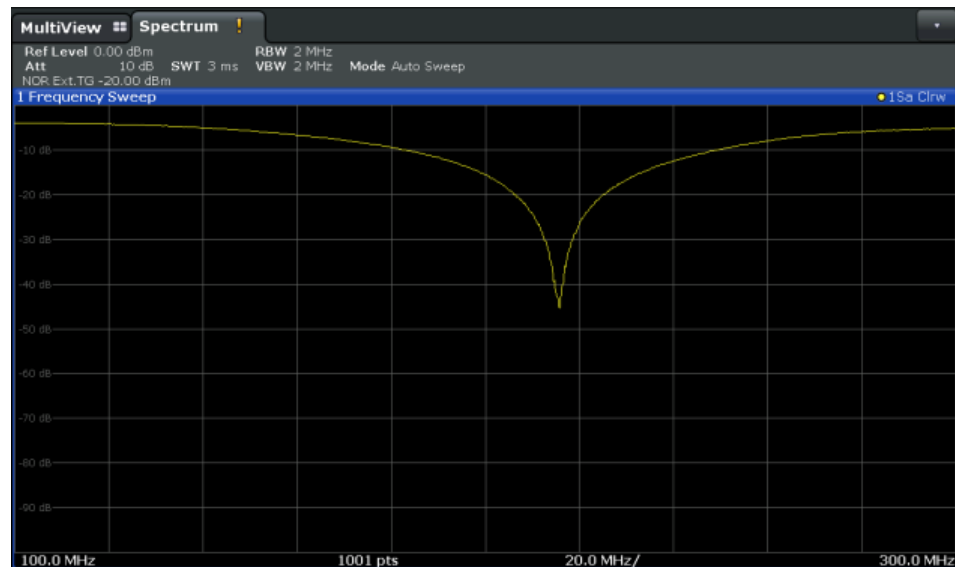

Figure 7-8: Band elimination filter results

- Shift the reference line from the top of the diagram to the middle of the diagram by changing the position of the reference point  $0.0\text{ dB}$  to  $50\%$ .  
In the "Source Calibration" tab, enter "Position":  $50\%$ .

At the same time, the range of the displayed y-axis moves from  $[-100.0\text{ dB to }0\text{ dB}]$  to  $[-50\text{ dB to }+50\text{ dB}]$ .

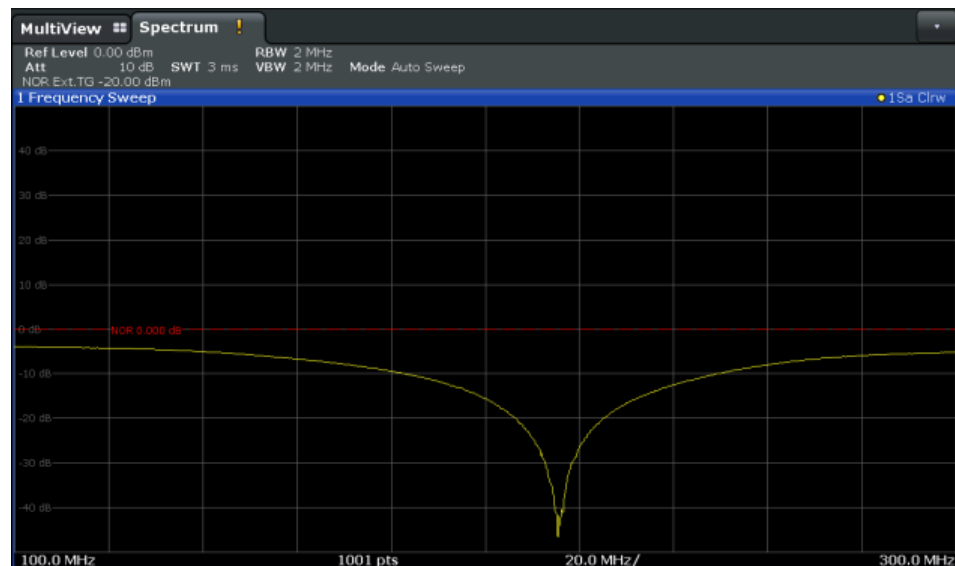

Figure 7-9: Reference line shifted to middle of diagram (50%)



### Compensating the effects of additional attenuation after calibration

After calibration, an additional attenuator is inserted between the DUT and the R&S FPS. This may be necessary, for example, to protect the analyzer's input connector. Nevertheless, we are only interested in the effects of the DUT, not those of the additional protective attenuator. Thus, we will compensate these effects in the result display on the R&S FPS by moving the reference line.

1. Connect a 3 dB attenuator between the band elimination filter output and the RF INPUT connector on the R&S FPS.

The measurement results are now 3 dB lower.

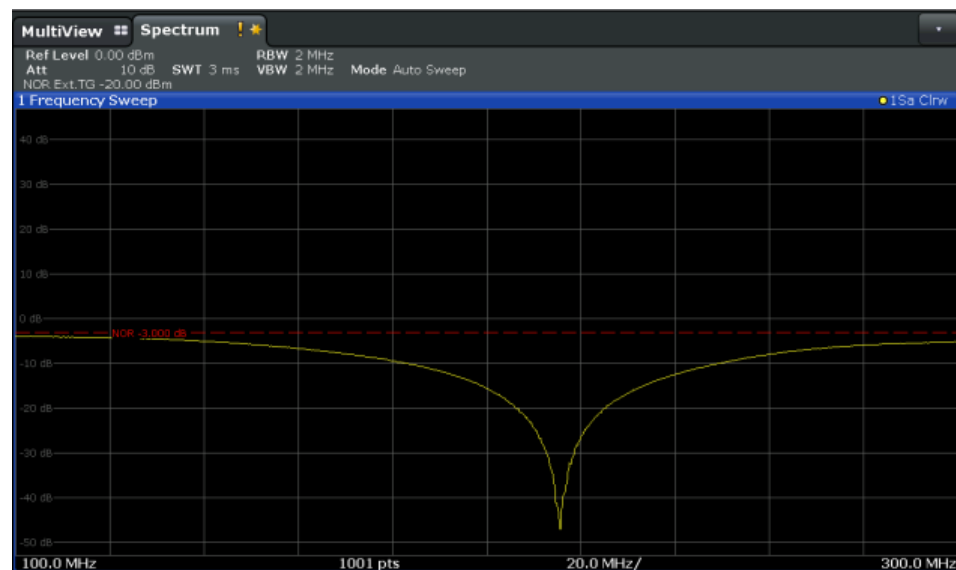

Figure 7-10: Measurement results with additional attenuator

2. In the "Source Calibration" tab, enter "Reference Value": -3 dB.

The reference line is shifted down by 3 dB so that the measurement trace is displayed on the reference line again.

At the same time, the scaling of the y-axis is changed: -3 dB are now shown at 50% of the diagram; the range is [-53 dB to +47 dB].

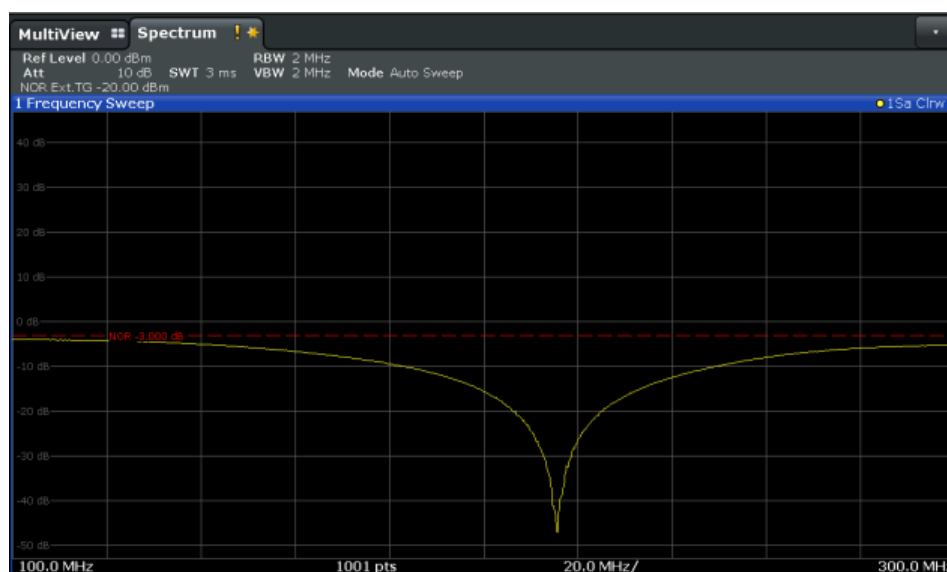

Figure 7-11: Reference line with an offset of -3 dB and shifted to middle of diagram (50%)

3. After the reference trace has been shifted, you can zoom into the measured trace to determine the offsets to the reference line, which represent the effects of the band elimination filter in the measurement setup. Change the y-axis scaling to 1 dB/div (or the range to 10 dB).
  - a) Press the AMPT key, then select "Scale Config" > "Range".
  - b) Enter 10 dB.

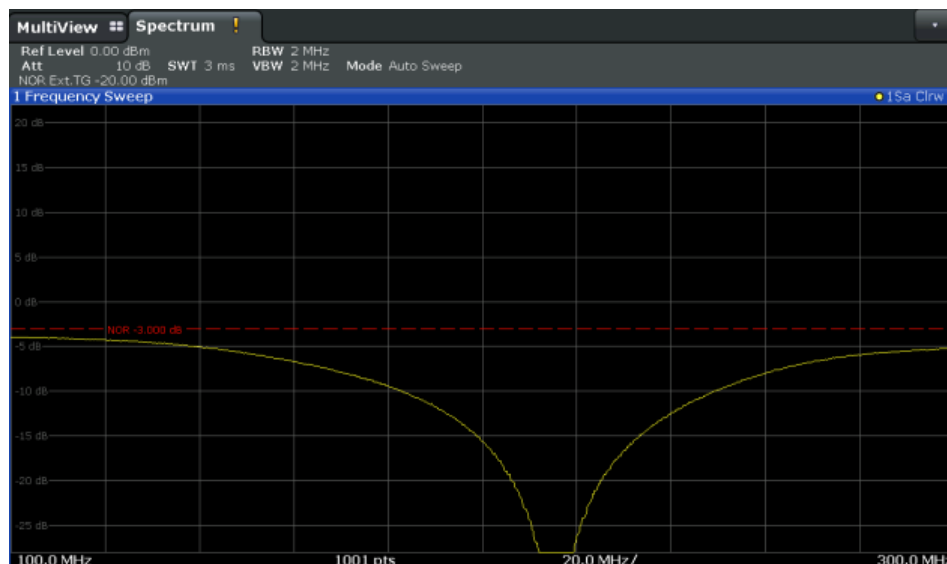

Figure 7-12: Reference line with measurement results using larger scale

## 7.2.5 Output Settings

Access: INPUT/OUTPUT > "Output"

The R&S FPS can provide output to special connectors for other devices.

For details on connectors, refer to the R&S FPS Getting Started manual, "Front / Rear Panel View" chapters.



Providing trigger signals as output is described in [Chapter 7.2.7, "How to Output a Trigger Signal"](#), on page 342.

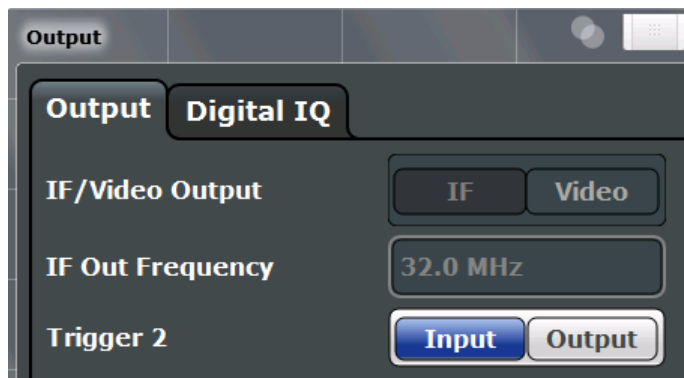

[IF/Video Output](#) ..... 339  
[IF Out Frequency](#) ..... 339  
[Noise Source Control](#)..... 340

**IF/Video Output**

Defines the type of signal available at the IF/VIDEO output on the rear panel of the R&S FPS.

For restrictions and additional information, see [Chapter 7.2.1.2, "IF and Video Signal Output"](#), on page 303.

For restrictions and additional information, see the R&S FPS I/Q Analyzer and I/Q Input User Manual.

"IF" The measured IF value is available at the IF/VIDEO output connector.

"Video" The displayed video signal (i.e. the filtered and detected IF signal) is available at the IF/VIDEO output connector.  
 This setting is required to provide demodulated audio frequencies at the output.

Remote command:  
[OUTPut:IF\[:SOURce\]](#) on page 835

**IF Out Frequency**

Defines or indicates the frequency at which the IF signal level is provided at the IF/VIDEO connector if [IF/Video Output](#) is set to "IF" .

For more information, see [Chapter 7.2.1.2, "IF and Video Signal Output"](#), on page 303.

### Noise Source Control

The R&S FPS provides a connector (NOISE SOURCE CONTROL) with a 28 V voltage supply for an external noise source. By switching the supply voltage for an external noise source on or off in the firmware, you can activate or deactivate the device as required.

External noise sources are useful when you are measuring power levels that fall below the noise floor of the R&S FPS itself, for example when measuring the noise level of an amplifier.

In this case, you can first connect an external noise source (whose noise power level is known in advance) to the R&S FPS and measure the total noise power. From this value you can determine the noise power of the R&S FPS. Then when you measure the power level of the actual DUT, you can deduct the known noise level from the total power to obtain the power level of the DUT.

Remote command:

`DIAGnostic:SERvice:NSource` on page 834

## 7.2.6 Trigger Input/Output Settings

**Access:** "Overview" > "Trigger" > "Trigger In/Out"

**Or:** TRIG > "Trigger Config" > "Trigger In/Out"

The R&S FPS can use a signal from an external device as a trigger to capture data. Alternatively, the internal trigger signal used by the R&S FPS can be output for use by other connected devices.



Providing trigger signals as output is described in detail in [Chapter 7.2.1.1, "Receiving and Providing Trigger Signals"](#), on page 302 and [Chapter 7.2.7, "How to Output a Trigger Signal"](#), on page 342.

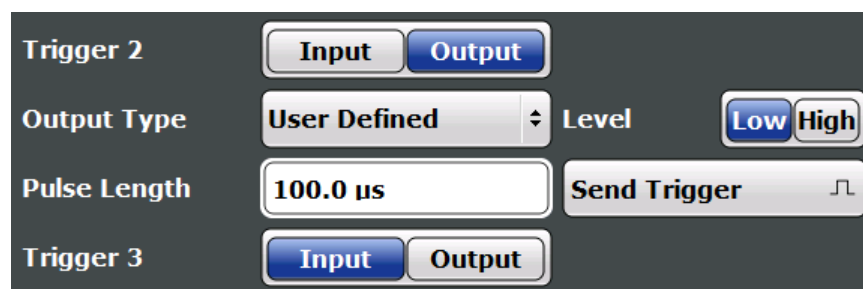

## Trigger 2

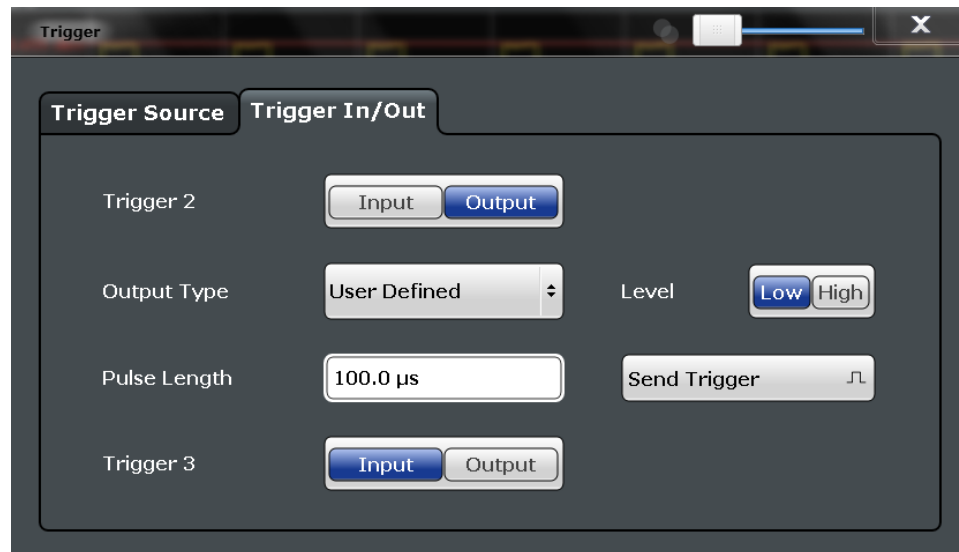

Defines the usage of the variable TRIGGER AUX connector on the rear panel.

(Trigger 1 is INPUT only.)

"Input" The signal at the connector is used as an external trigger source by the R&S FPS. Trigger input parameters are available in the "Trigger" dialog box.

"Output" The R&S FPS sends a trigger signal to the output connector to be used by connected devices. Further trigger parameters are available for the connector.

Remote command:

[OUTPut:TRIGger<port>:DIRection](#) on page 807

### Output Type ← Trigger 2

Type of signal to be sent to the output

"Device Triggered" (Default) Sends a trigger when the R&S FPS triggers.

"Trigger Armed" Sends a (high level) trigger when the R&S FPS is in "Ready for trigger" state. This state is indicated by a status bit in the `STATUS:OPERation` register (bit 5). For details, see "[STATUS:OPERation Register](#)" on page 592 and the R&S FPS Getting Started manual.

"User Defined" Sends a trigger when you select the "Send Trigger" button. In this case, further parameters are available for the output signal.

Remote command:

[OUTPut:TRIGger<port>:OTYPe](#) on page 808

### Level ← Output Type ← Trigger 2

Defines whether a high (1) or low (0) constant signal is sent to the trigger output connector.

The trigger pulse level is always opposite to the constant signal level defined here. For example, for "Level = High", a constant high signal is output to the connector until you select the [Send Trigger](#) function. Then, a low pulse is provided.

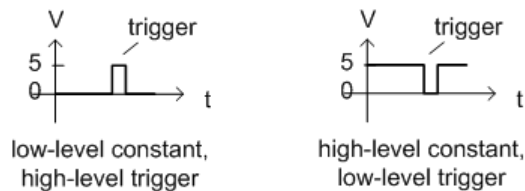

Remote command:

[OUTPut:TRIGger<port>:LEVel](#) on page 807

### **Pulse Length ← Output Type ← Trigger 2**

Defines the duration of the pulse (pulse width) sent as a trigger to the output connector.

Remote command:

[OUTPut:TRIGger<port>:PULSe:LENGth](#) on page 808

### **Send Trigger ← Output Type ← Trigger 2**

Sends a user-defined trigger to the output connector immediately.

Note that the trigger pulse level is always opposite to the constant signal level defined by the output [Level](#) setting. For example, for "Level" = "High", a constant high signal is output to the connector until you select the "Send Trigger" function. Then, a low pulse is sent.

Which pulse level will be sent is indicated by a graphic on the button.

Remote command:

[OUTPut:TRIGger<port>:PULSe:IMMediate](#) on page 808

## **7.2.7 How to Output a Trigger Signal**

Using the variable TRG AUX connector of the R&S FPS, the internal trigger signal can be output for use by other connected devices. For details on the connectors see the R&S FPS "Getting Started" manual.

### **To output a trigger to a connected device**

1. Select TRIGGER > "Trigger Config".
2. Switch to the "Trigger In/Out" tab of the "Trigger and Gate".
3. Set the trigger to be used to "Output".
4. Define whether the trigger signal is to be output automatically ("Output Type" = "Device triggered" or "Trigger Armed") or whether you want to start output manually ("Output Type" = "User-defined").

5. For manual output: Specify the constant signal level and the length of the trigger pulse to be output. Note that the level of the trigger pulse is opposite to the constant output "Level" setting (compare the graphic on the "Send Trigger" button).
6. Connect a device that will receive the trigger signal to the configured TRG AUX connector.
7. Start a measurement and wait for an internal trigger, or select the "Send Trigger" button.

The configured trigger is output to the connector.

## 7.3 Frequency and Span Configuration

The frequency and span settings define the scope of the signal and spectrum to be analyzed with the R&S FPS.

- [Impact of the Frequency and Span Settings](#)..... 343
- [Frequency and Span Settings](#)..... 345
- [Keeping the Center Frequency Stable - Signal Tracking](#)..... 349
- [How To Define the Frequency Range](#)..... 350
- [How to Move the Center Frequency through the Frequency Range](#)..... 351

### 7.3.1 Impact of the Frequency and Span Settings

Some background knowledge on the impact of the described settings is provided here for a better understanding of the required configuration.

- [Defining the Scope of the Measurement - Frequency Range](#)..... 343
- [Stepping Through the Frequency Range - Center Frequency Stepsize](#)..... 344
- [Coping with Large Frequency Ranges - Logarithmic Scaling](#)..... 344

#### 7.3.1.1 Defining the Scope of the Measurement - Frequency Range

The frequency range defines the scope of the signal and spectrum to be analyzed. It can either be defined as a span around a center frequency, or as a range from a start to a stop frequency. Furthermore, the full span comprising the entire possible frequency range can be selected, or a zero span. The full span option allows you to perform an overview measurement over the entire span. Using the "Last Span" function you can easily switch back to the detailed measurement of a specific frequency range.

For sinusoidal signals, the center frequency can be defined automatically by the R&S FPS as the highest frequency level in the frequency span (see "[Adjusting the Center Frequency Automatically \( Auto Frequency \)](#)" on page 390).

### 7.3.1.2 Stepping Through the Frequency Range - Center Frequency Stepsize

Using the arrow keys you can move the center frequency in discrete steps through the available frequency range. The step size by which the center frequency is increased or decreased is defined by the "Center Frequency Stepsize" .



The "Center Frequency Stepsize" also defines the step size by which the value is increased or decreased when you use the rotary knob to change the center frequency; however, the **rotary knob** moves in steps of only **1/10 of the "Center Frequency Stepsize"** to allow for a more precise setting.

By default, the step size is set in relation to the selected span or resolution bandwidth (for zero span measurements). In some cases, however, it may be useful to set the step size to other values.



For example, to analyze signal harmonics, you can define the step size to be equal to the center frequency. In this case, each stroke of the arrow key selects the center frequency of another harmonic. Similarly, you can define the step size to be equal to the current marker frequency.

### 7.3.1.3 Coping with Large Frequency Ranges - Logarithmic Scaling

In a linear display, the frequencies are distributed linearly across the x-axis. That means the entire frequency range is divided by the number of sweep points, and the distance between sweep points is equal. Linear scaling is useful to determine precise frequencies within a small range.



*Figure 7-13: Linear x-axis scaling: the distance between the sweep points is equal, e.g. 200 kHz*

However, if high and low frequencies appear in the same display, it is difficult to determine individual frequencies precisely or to distinguish frequencies that are close together.

In a logarithmic display, lower frequencies are distributed among a much larger area of the display, while high frequencies are condensed to a smaller area. Now it is much easier to distinguish several lower frequencies, as they are spread over a wider area. Logarithmic scaling is useful for overview measurements when a large frequency range must be displayed in one diagram.

However, with logarithmic scaling, the frequency resolution between two sweep points deteriorates with higher frequencies.

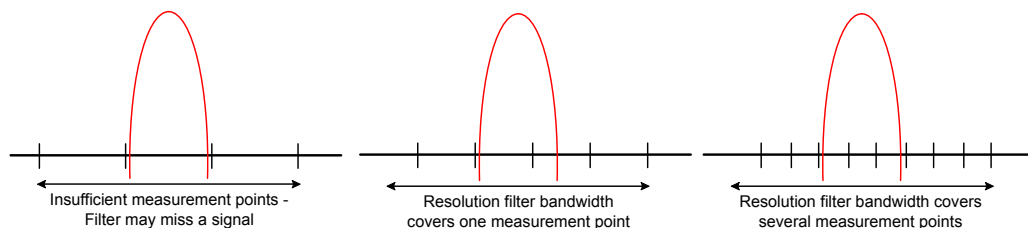



Figure 7-14: Logarithmic x-axis scaling: the distance between sweep points is variable

In the spectrum from 10 Hz to 100 Hz, the distance is a few Hz. Between 100 MHz and 1 GHz, the distance is several MHz.

Thus, for logarithmic x-axis scaling, the number of sweep points must be sufficiently high in order to distinguish high frequencies precisely. The resolution bandwidth should cover at least one sweep point (that means: the distance between two sweep points should not exceed the RBW). If this condition is not met, signals or interferers could be missed, especially narrowband interferers.



### 7.3.2 Frequency and Span Settings

Access: "Overview" > "Frequency"

For more information see [Chapter 7.3.4, "How To Define the Frequency Range"](#), on page 350.

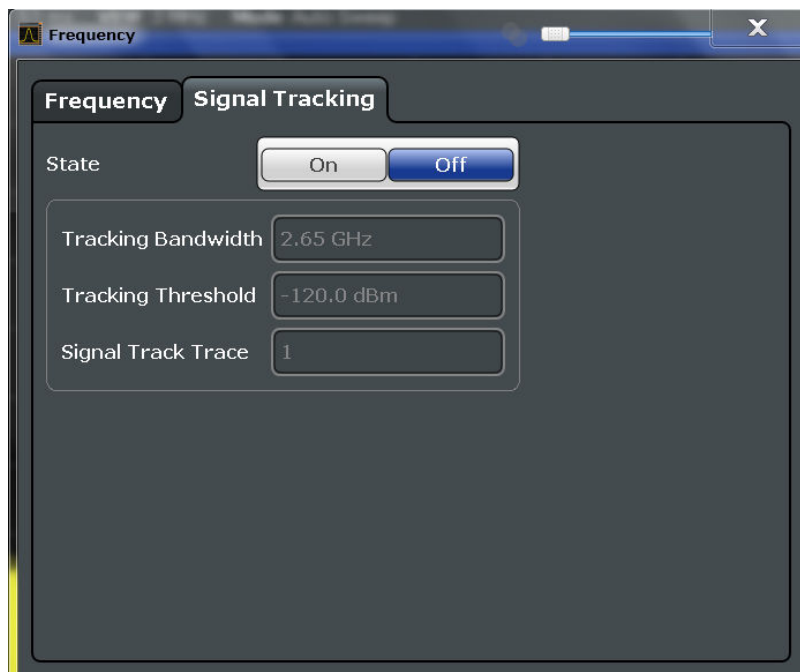
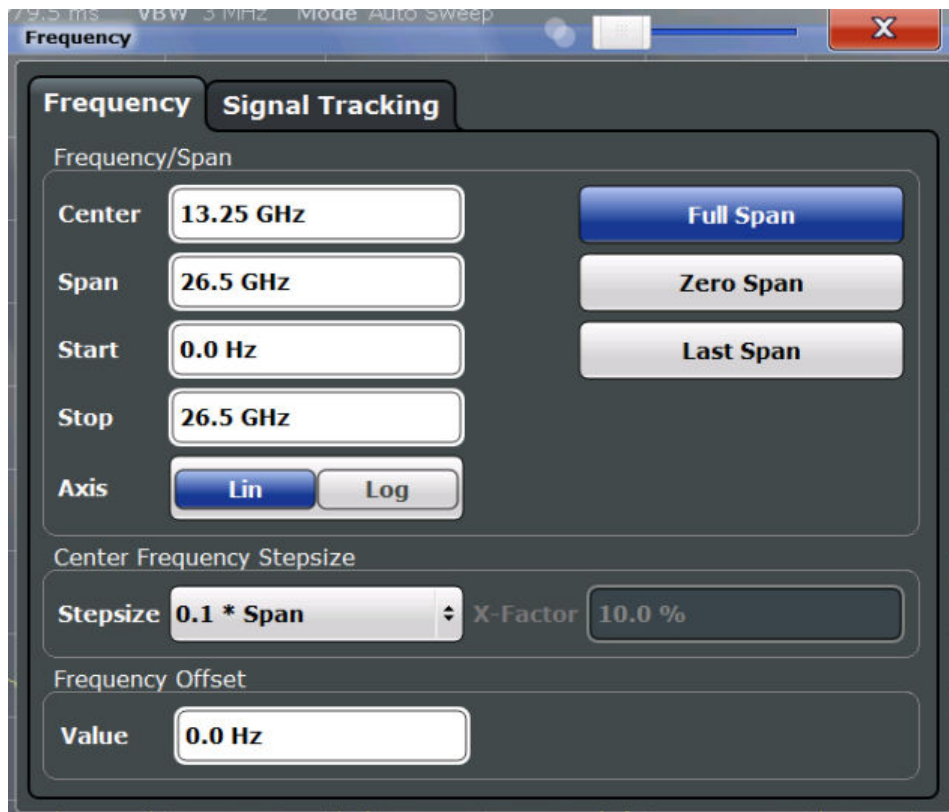

|                              |     |
|------------------------------|-----|
| Center Frequency .....       | 347 |
| Span .....                   | 347 |
| Start / Stop .....           | 347 |
| Frequency Axis Scaling ..... | 347 |
| Full Span .....              | 348 |

|                                 |     |
|---------------------------------|-----|
| Zero Span .....                 | 348 |
| Last Span .....                 | 348 |
| Center Frequency Stepsize ..... | 348 |
| Frequency Offset .....          | 349 |

### Center Frequency

Defines the center frequency of the signal in Hertz.

The allowed range of values for the center frequency depends on the frequency span.

$$\text{span} > 0: \text{span}_{\min}/2 \leq f_{\text{center}} \leq f_{\max} - \text{span}_{\min}/2$$

$$\text{zero span: } 0 \text{ Hz} \leq f_{\text{center}} \leq f_{\max}$$

$f_{\max}$  and  $\text{span}_{\min}$  depend on the instrument and are specified in the data sheet.

Remote command:

[SENSe:] FREQuency: CENTer on page 777

### Span

Defines the frequency span. The center frequency is kept constant. The following range is allowed:

$$\text{span} = 0: 0 \text{ Hz}$$

span >0:

$$\text{span}_{\min} \leq f_{\text{span}} \leq f_{\max}$$

$f_{\max}$  and  $\text{span}_{\min}$  are specified in the data sheet.

For more information see [Chapter 7.3.1.1, "Defining the Scope of the Measurement - Frequency Range"](#), on page 343.

Remote command:

[SENSe:] FREQuency: SPAN on page 779

### Start / Stop

Defines the start and stop frequencies.

The following range of values is allowed:

$$f_{\min} \leq f_{\text{start}} \leq f_{\max} - \text{span}_{\min}$$

$$f_{\min} + \text{span}_{\min} \leq f_{\text{stop}} \leq f_{\max}$$

$f_{\min}$ ,  $f_{\max}$  and  $\text{span}_{\min}$  are specified in the data sheet.

Remote command:

[SENSe:] FREQuency: START on page 780

[SENSe:] FREQuency: STOP on page 780

### Frequency Axis Scaling

Switches between linear and logarithmic scaling for the frequency axis.

By default, the frequency axis has linear scaling. Logarithmic scaling of the frequency axis, however, is common for measurements over large frequency ranges as it enhances the resolution of the lower frequencies. On the other hand, high frequencies get more crowded and become harder to distinguish.

For more information see [Chapter 7.3.1.3, "Coping with Large Frequency Ranges - Logarithmic Scaling"](#), on page 344.

Remote command:

`DISPlay[:WINDow<n>]:TRACe:X:SPACing` on page 777

### Full Span

Sets the span to the full frequency range of the R&S FPS specified in the data sheet. This setting is useful for overview measurements.

Remote command:

`[SENSe:]FREQuency:SPAN:FULL` on page 780

### Zero Span

Sets the span to 0 Hz (zero span). The x-axis becomes the time axis with the grid lines corresponding to 1/10 of the current sweep time ("SWT").

For details see [Chapter 6.1, "Basic Measurements"](#), on page 124.

Remote command:

`FREQ:SPAN 0Hz`, see `[SENSe:]FREQuency:SPAN` on page 779

### Last Span

Sets the span to the previous value. With this function you can switch between an overview measurement and a detailed measurement quickly.

Remote command:

`[SENSe:]FREQuency:SPAN` on page 779

### Center Frequency Stepsize

Defines the step size by which the center frequency is increased or decreased when the arrow keys are pressed. When you use the rotary knob the center frequency changes in steps of only 1/10 of the span.

The step size can be coupled to the span (span > 0) or the resolution bandwidth (span = 0), or it can be manually set to a fixed value.

For more details see [Chapter 7.3.1.2, "Stepping Through the Frequency Range - Center Frequency Stepsize"](#), on page 344.

"0.1 \* Span" / Sets the step size for the center frequency to 10 % of the span /  
"0.1 \* RBW" RBW.  
This is the default setting.

"0.5 \* Span" / Sets the step size for the center frequency to 50 % of the span /  
"0.5 \* RBW" RBW.

"x \* Span" / Sets the step size for the center frequency to a manually defined fac-  
"x \* RBW" tor of the span / RBW. The "X-Factor" defines the percentage of the  
span / RBW.  
Values between 1 and 100 % in steps of 1 % are allowed. The default  
setting is 10 %.

"= Center" Sets the step size to the value of the center frequency and removes  
the coupling of the step size to span or resolution bandwidth. The  
used value is indicated in the "Value" field.

- "= Marker" This setting is only available if a marker is active. Sets the step size to the value of the current marker and removes the coupling of the step size to span or resolution bandwidth. The used value is indicated in the "Value" field.
- "Manual" Defines a fixed step size for the center frequency. Enter the step size in the "Value" field.

Remote command:

[\[SENSe:\] FREQuency:CENTer:STEP:LINK](#) on page 778

[\[SENSe:\] FREQuency:CENTer:STEP:LINK:FACTor](#) on page 779

[\[SENSe:\] FREQuency:CENTer:STEP](#) on page 777

### Frequency Offset

Shifts the displayed frequency range along the x-axis by the defined offset.

This parameter has no effect on the instrument's hardware, or on the captured data or on data processing. It is simply a manipulation of the final results in which absolute frequency values are displayed. Thus, the x-axis of a spectrum display is shifted by a constant offset if it shows absolute frequencies, but not if it shows frequencies relative to the signal's center frequency.

A frequency offset can be used to correct the display of a signal that is slightly distorted by the measurement setup, for example.

The allowed values range from -100 GHz to 100 GHz. The default setting is 0 Hz.

Remote command:

[\[SENSe:\] FREQuency:OFFSet](#) on page 779

### 7.3.3 Keeping the Center Frequency Stable - Signal Tracking

If the signal drifts on the display but you want to keep the center frequency on the signal peak, the center frequency can be adjusted automatically using **signal tracking**. In this case, the signal trace is surveyed in a specified bandwidth around the expected center frequency. After each sweep, the center frequency is set to the maximum signal found within the searched bandwidth. If no maximum signal above a defined threshold value is found in the searched bandwidth, the center frequency remains unchanged. The search bandwidth and the threshold value are shown in the diagram by red lines which are labeled as "TRK" .

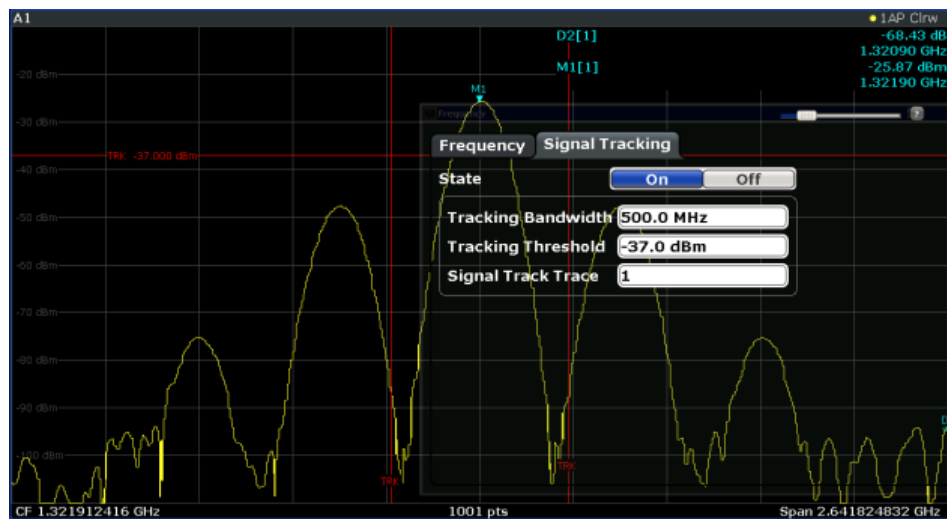

### Signal Tracking

**Access:** "Overview" > "Frequency" > "Signal Tracking" tab

Defines the settings for signal tracking. These settings are only available for spans > 0.

For more details see [Chapter 7.3.3, "Keeping the Center Frequency Stable - Signal Tracking"](#), on page 349.

If activated, after each sweep, the center frequency is set to the maximum level of the specified "Signal Track Trace" found within the searched "Tracking Bandwidth".

If the signal level does not pass the "Tracking Threshold", the center frequency is not changed.

Remote command:

[CALCulate<n>:MARKer<m>:FUNCTION:STRack\[:STATE\]](#) on page 784

[CALCulate<n>:MARKer<m>:FUNCTION:STRack:BANDwidth](#) on page 784

[CALCulate<n>:MARKer<m>:FUNCTION:STRack:THReshold](#) on page 784

[CALCulate<n>:MARKer<m>:FUNCTION:STRack:TRACe](#) on page 785

## 7.3.4 How To Define the Frequency Range

The following step-by-step instructions demonstrate how to configure the frequency and span settings. For details on individual functions and settings see [Chapter 7.3.2, "Frequency and Span Settings"](#), on page 345.

The remote commands required to perform these tasks are described in [Chapter 12.7.1, "Defining the Frequency and Span"](#), on page 776.

### To configure the frequency and span

Frequency and span settings can be configured via the "Frequency" dialog box. Signal tracking is configured in the "Signal Tracking" tab of this dialog box.

- To display the "Frequency" dialog box, do one of the following:
  - Select "Frequency" from the "Overview".
  - Select the FREQ key and then the "Frequency Config" softkey.

- Select the SPAN key and then the "Frequency Config" softkey.
2. Define the frequency range using one of the following methods:
    - Define the "Center Frequency" and "Span" .
    - Define the "Start Frequency" and "Stop Frequency" .
    - To perform a measurement in the time domain, define the "Center Frequency" and select the "Zero Span" button.
    - To perform a measurement over the entire available frequency range, select the "Full Span" button.
    - To return to the previously set frequency range, select the "Last Span" button.

### 7.3.5 How to Move the Center Frequency through the Frequency Range

In some cases it may be useful to move the center frequency through a larger frequency range, for example from one harmonic to another.

1. In the "Frequency" dialog box, define the "Center Frequency Stepsize" . This is the size by which the center frequency is to be increased or decreased in each step. Enter a manual or relative value, or set the step size to the current center frequency or marker value. To move from one harmonic to the next, use the center frequency or marker value.
2. Select the "Center Frequency" dialog field.
3. Use the arrow keys to move the center frequency in discrete steps through the available frequency range.

## 7.4 Amplitude and Vertical Axis Configuration

In the Spectrum application, measurement results usually consist of the measured signal levels (amplitudes) displayed on the vertical (y-)axis for the determined frequency spectrum or for the measurement time (horizontal, x-axis). The settings for the vertical axis, regarding amplitude and scaling, are described here.

- [Impact of the Vertical Axis Settings](#).....351
- [Amplitude Settings](#)..... 354
- [Scaling the Y-Axis](#)..... 358
- [How to Optimize the Amplitude Display](#)..... 359

### 7.4.1 Impact of the Vertical Axis Settings

Some background knowledge on the impact of the described settings is provided here for a better understanding of the required configuration.

- [Reference Level](#)..... 352
- [RF Attenuation](#)..... 353
- [Scaling](#)..... 354

### 7.4.1.1 Reference Level

The reference level value is the maximum value the AD converter can handle without distortion of the measured value. Signal levels above this value will not be measured correctly, which is indicated by the "IF Overload" status display.

Internally, the reference level is also used to determine the optimum hardware settings for the R&S FPS. The defined reference level should correspond with the maximum expected RF input level.



When determining the expected input level, consider that the power from *all* input signals contribute to the total power. The reference level must be higher than the total power from all signals.

The optimum reference level for the current measurement settings can be set automatically by the R&S FPS (see "Reference Level" on page 355).

The reference level determines the amplitude represented by the topmost grid line in the display. When you change the reference level, the measurement is not restarted; the results are merely shifted in the display. Only if the reference level changes due to a coupled RF attenuation (see "Attenuation Mode / Value" on page 356), the measurement is restarted.

In general, the R&S FPS measures the signal voltage at the RF input. The level display is calibrated in RMS values of an unmodulated sine wave signal. In the default state, the level is displayed at a power of 1 mW (= dBm). Via the known input impedance, conversion to other units is possible.

See "Impedance" on page 304.

#### Reference level offset

If the signal is attenuated or amplified before it is fed into the R&S FPS, you can define an (arithmetic) offset to the reference level so the application shows correct power results. All displayed power level results are shifted by this value, and the scaling of the y-axis is changed accordingly.

To determine the required offset, consider the external attenuation or gain applied to the input signal. For attenuation, define a positive offset so the R&S FPS increases the displayed power values.

If an external gain is applied, define a negative offset so the R&S FPS decreases the displayed power values.

Note, however, that the *internal* reference level (used to adjust the hardware settings to the expected signal optimally) ignores any "Reference Level Offset". Thus, it is important to keep in mind the actual power level the R&S FPS must handle, and not to rely on the displayed reference level.

internal reference level = displayed reference level - offset

#### Example

1. The initial reference level is 2 dBm with no offset.



Both the displayed reference level and the internal reference level are 2 dBm.

2. An offset of 3 dB is defined.

The displayed reference level is adjusted to 5 dBm.

The internal reference level remains at 2 dBm.

$(5 \text{ dBm (displayed ref level)} - 3 \text{ dB (offset)}) = 2 \text{ dBm}$

3. Now the user decreases the reference level to 1 dBm.

The displayed reference level is adjusted to 1 dBm.

The internal reference level is adjusted to:

$1 \text{ dBm (displayed ref level)} - 3 \text{ dB (offset)} = -2 \text{ dBm}$ .

#### 7.4.1.2 RF Attenuation

The attenuation is meant to protect the input mixer from high RF input levels. The level at the input mixer is determined by the set RF attenuation according to the formula:

" $\text{level}_{\text{mixer}} = \text{level}_{\text{input}} - \text{RF attenuation}$ "

The maximum mixer level allowed is 0 dBm.

Mixer levels above this value may lead to incorrect measurement results, which is indicated by the "RF Overload" status display. Furthermore, higher input levels may damage the instrument. Therefore, the required RF attenuation is determined automatically according to the reference level by default.

High attenuation levels also avoid intermodulation. On the other hand, attenuation must be compensated for by re-amplifying the signal levels after the mixer. Thus, high attenuation values cause the inherent noise (i.e. the noise floor) to rise and the sensitivity of the analyzer decreases.

The sensitivity of a signal analyzer is directly influenced by the selected RF attenuation. The highest sensitivity is obtained at an RF attenuation of 0 dB. Each additional 10 dB step reduces the sensitivity by 10 dB, i.e. the displayed noise is increased by 10 dB. To measure a signal with an improved signal-to-noise ratio, decrease the RF attenuation.



For ideal sinusoidal signals, the displayed signal level is independent of the RF attenuation.

Depending on the type of measurement you must find a compromise between a low noise floor and high intermodulation levels, and protecting the instrument from high input levels. You achieve this best by letting the R&S FPS determine the optimum level automatically (see "[Attenuation Mode / Value](#)" on page 356).



### Electronic attenuation

If the optional electronic attenuation hardware is installed on the R&S FPS, you can also activate an electronic attenuator. For details, see "[Using Electronic Attenuation](#)" on page 356.

#### 7.4.1.3 Scaling

In a linear display, the measurement values are distributed linearly throughout the grid. That means the entire range of measured values is divided by the number of rows in the grid (10) and each row corresponds to 1/10 of the total range. Linear scaling is useful to determine precise levels for a small range of values. However, if large and small values appear in the same display, it is difficult to determine individual values precisely or to distinguish values that are close together.

In a logarithmic display, smaller values are distributed among a much larger area of the display, while large values are condensed to a smaller area. Now it is much easier to distinguish several lower values, as they are spread over a wider area. Logarithmic scaling is useful when large ranges of values must be combined in one display. Logarithmic scaling is best applied to measurement values in logarithmic units (dB, dBm etc.).

In addition to linear or logarithmic scaling, the vertical axis can be set to display either absolute or relative values. Absolute values show the measured levels, while relative values show the difference between the measured level and the defined reference level. Relative values are indicated in percent for linear scaling, and in dB for logarithmic scaling.

## 7.4.2 Amplitude Settings

**Access:** "Overview" > "Amplitude"

Amplitude settings determine how the R&S FPS must process or display the expected input power levels.

The remote commands required to define these settings are described in [Chapter 12.7.3.1, "Amplitude Settings"](#), on page 792.

|                                                                  |     |
|------------------------------------------------------------------|-----|
| Reference Level .....                                            | 355 |
| ↳ Shifting the Display ( Offset ) .....                          | 355 |
| ↳ Unit .....                                                     | 355 |
| ↳ Setting the Reference Level Automatically ( Auto Level ) ..... | 356 |
| RF Attenuation .....                                             | 356 |
| ↳ Attenuation Mode / Value .....                                 | 356 |
| Using Electronic Attenuation .....                               | 356 |
| Input Settings .....                                             | 357 |
| ↳ Preamplifier (option B22/B24) .....                            | 357 |
| Noise Cancellation .....                                         | 357 |

**Reference Level**

Defines the expected maximum reference level. Signal levels above this value may not be measured correctly. This is indicated by an "IF Overload" status display.

The reference level can also be used to scale power diagrams; the reference level is then used as the maximum on the y-axis.

Since the hardware of the R&S FPS is adapted according to this value, it is recommended that you set the reference level close above the expected maximum signal level. Thus you ensure an optimum measurement (no compression, good signal-to-noise ratio).

For details, see [Chapter 7.4.1.1, "Reference Level"](#), on page 352.

Remote command:

`DISPlay[:WINDow<n>]:TRACe<t>:Y[:SCALe]:RLEVel` on page 793

**Shifting the Display ( Offset ) ← Reference Level**

Defines an arithmetic level offset. This offset is added to the measured level. In some result displays, the scaling of the y-axis is changed accordingly.

Define an offset if the signal is attenuated or amplified before it is fed into the R&S FPS so the application shows correct power results. All displayed power level results are shifted by this value.

The setting range is  $\pm 200$  dB in 0.01 dB steps.

Note, however, that the *internal* reference level (used to adjust the hardware settings to the expected signal) ignores any "Reference Level Offset". Thus, it is important to keep in mind the actual power level the R&S FPS must handle. Do not rely on the displayed reference level (internal reference level = displayed reference level - offset).

For details, see ["Reference level offset"](#) on page 352.

Remote command:

`DISPlay[:WINDow<n>]:TRACe<t>:Y[:SCALe]:RLEVel:OFFSet` on page 793

**Unit ← Reference Level**

The R&S FPS measures the signal voltage at the RF input.

In the default state, the level is displayed at a power level of 1 mW (= dBm). Via the known input impedance (50  $\Omega$  or 75  $\Omega$ , see [" Impedance "](#) on page 304), conversion to other units is possible.

The following units are available and directly convertible:

- dBm
- dBmV
- dB $\mu$ V
- dB $\mu$ A
- dBpW
- Volt
- Ampere
- Watt

Remote command:

`INPut:IMPedance` on page 813

`CALCulate<n>:UNIT:POWer` on page 793

**Setting the Reference Level Automatically ( Auto Level ) ← Reference Level**

Automatically determines a reference level which ensures that no overload occurs at the R&S FPS for the current input data. At the same time, the internal attenuators are adjusted so the signal-to-noise ratio is optimized, while signal compression and clipping are minimized.

To determine the required reference level, a level measurement is performed on the R&S FPS.

If necessary, you can optimize the reference level further. Decrease the attenuation level manually to the lowest possible value before an overload occurs, then decrease the reference level in the same way.

You can change the measurement time for the level measurement if necessary (see "[Changing the Automatic Measurement Time \( MeasTime Manual \)](#)" on page 391).

Remote command:

[\[SENSe:\]ADJust:LEVel](#) on page 783

**RF Attenuation**

Defines the attenuation applied to the RF input of the R&S FPS.

**Attenuation Mode / Value ← RF Attenuation**

The RF attenuation can be set automatically as a function of the selected reference level (Auto mode). This ensures that no overload occurs at the RF INPUT connector for the current reference level. It is the default setting.

By default and when no (optional) [electronic attenuation](#) is available, mechanical attenuation is applied.

In "Manual" mode, you can set the RF attenuation in 1 dB steps (down to 0 dB). Other entries are rounded to the next integer value. The range is specified in the data sheet. If the defined reference level cannot be set for the defined RF attenuation, the reference level is adjusted accordingly and the warning "limit reached" is displayed.

**NOTICE!** Risk of hardware damage due to high power levels. When decreasing the attenuation manually, ensure that the power level does not exceed the maximum level allowed at the RF input, as an overload may lead to hardware damage.

For details, see [Chapter 7.4.1.2, "RF Attenuation"](#), on page 353.

Remote command:

[INPut:ATTenuation](#) on page 794

[INPut:ATTenuation:AUTO](#) on page 795

**Using Electronic Attenuation**

If the (optional) Electronic Attenuation hardware is installed on the R&S FPS, you can also activate an electronic attenuator.

In "Auto" mode, the settings are defined automatically; in "Manual" mode, you can define the mechanical and electronic attenuation separately.

**Note:** Electronic attenuation is not available for stop frequencies (or center frequencies in zero span) above 7 GHz.

In "Auto" mode, RF attenuation is provided by the electronic attenuator as much as possible to reduce the amount of mechanical switching required. Mechanical attenuation may provide a better signal-to-noise ratio, however.

When you switch off electronic attenuation, the RF attenuation is automatically set to the same mode (auto/manual) as the electronic attenuation was set to. Thus, the RF attenuation can be set to automatic mode, and the full attenuation is provided by the mechanical attenuator, if possible.

The electronic attenuation can be varied in 1 dB steps. If the electronic attenuation is on, the mechanical attenuation can be varied in 5 dB steps. Other entries are rounded to the next lower integer value.

If the defined reference level cannot be set for the given attenuation, the reference level is adjusted accordingly and the warning "limit reached" is displayed in the status bar.

Remote command:

`INPut:EATT:STATe` on page 796

`INPut:EATT:AUTO` on page 796

`INPut:EATT` on page 795

### Input Settings

Some input settings affect the measured amplitude of the signal, as well.

The parameters "Input Coupling" and "Impedance" are identical to those in the "Input" settings.

See [Chapter 7.2.2, "Input Source Settings"](#), on page 303.

### Preamplifier (option B22/B24) ← Input Settings

Switches the preamplifier on and off. If activated, the input signal is amplified by 20 dB.

If option R&S FPS-B22 is installed, the preamplifier is only active below 7 GHz.

If option R&S FPS-B24 is installed, the preamplifier is active for all frequencies.

When measuring Spurious Emissions, using this softkey automatically opens the "Sweep List" dialog, see [Chapter 6.6.4.1, "Sweep List"](#), on page 252.

Remote command:

`INPut:GAIN:STATe` on page 796

### Noise Cancellation

The R&S FPS can correct the results by removing the inherent noise of the analyzer, which increases the dynamic range.

In this case, a reference measurement of the inherent noise of the analyzer is carried out. The measured noise power is then subtracted from the power in the channel that is being analyzed (first active trace only).

The inherent noise of the instrument depends on the selected center frequency, resolution bandwidth and level setting. Therefore, the correction function is disabled whenever one of these parameters is changed. A disable message is displayed on the screen. To enable the correction function after changing one of these settings, activate it again. A new reference measurement is carried out.

Noise cancellation is also available in zero span.

Currently, noise cancellation is only available for the following trace detectors (see "[Detector](#)" on page 467):

- RMS

- Average
- Sample
- Positive peak

Remote command:

[SENSe:]POWER:NCORrection on page 794

### 7.4.3 Scaling the Y-Axis

The individual scaling settings that affect the vertical axis are described here.

**Access:** "Overview" > "Amplitude" > "Scale" tab

**Or:** AMPT > "Scale Config"

The remote commands required to define these settings are described in [Chapter 12.7.3, "Configuring the Vertical Axis \(Amplitude, Scaling\)"](#), on page 792.

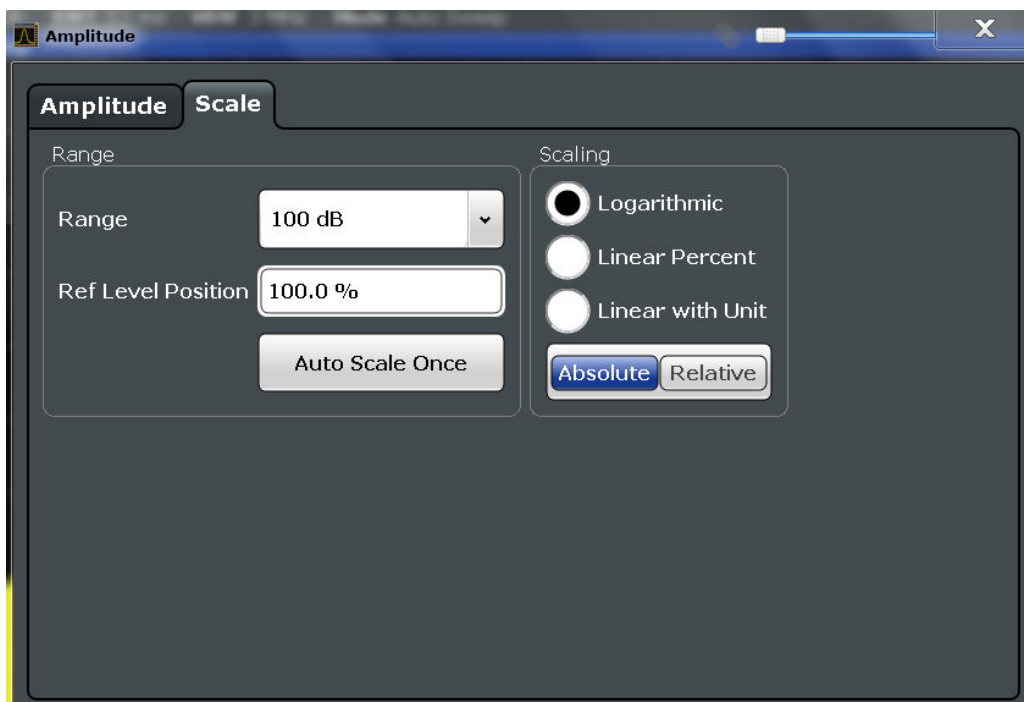

|                          |     |
|--------------------------|-----|
| Range .....              | 358 |
| Ref Level Position ..... | 359 |
| Auto Scale Once .....    | 359 |
| Scaling .....            | 359 |

#### Range

Defines the displayed y-axis range in dB.

The default value is 100 dB.

Remote command:

DISPlay[:WINDow<n>]:TRACe<t>:Y[:SCALE] on page 797

**Ref Level Position**

Defines the reference level position, i.e. the position of the maximum AD converter value on the level axis in %, where 0 % corresponds to the lower and 100 % to the upper limit of the diagram.

For spectrograms, this value defines the position of the reference level value within the span covered by the color map. In this case, the value is given in %, where 0 % corresponds to the maximum (right end) and 100 % to the minimum (left end) of the color map.

Remote command:

`DISPlay[:WINDow<n>]:TRACe<t>:Y[:SCALe]:RPOSition` on page 798

**Auto Scale Once**

Automatically determines the optimal range and reference level position to be displayed for the current measurement settings.

The display is only set once; it is not adapted further if the measurement settings are changed again.

Remote command:

`DISPlay[:WINDow<n>]:TRACe<t>:Y[:SCALe]:AUTO ONCE` on page 797

**Scaling**

Defines the scaling method for the y-axis.

For more information see [Chapter 7.4.1.3, "Scaling"](#), on page 354.

|                    |                                                                                                                                                                       |
|--------------------|-----------------------------------------------------------------------------------------------------------------------------------------------------------------------|
| "Logarithmic"      | Logarithmic scaling (only available for logarithmic units - dB..., and A, V, Watt)                                                                                    |
| "Linear with Unit" | Linear scaling in the unit of the measured signal                                                                                                                     |
| "Linear Percent"   | Linear scaling in percentages from 0 to 100                                                                                                                           |
| "Absolute"         | The labeling of the level lines refers to the absolute value of the reference level (not available for "Linear Percent" )                                             |
| "Relative"         | The scaling is in dB, relative to the reference level (only available for logarithmic units - dB...). The upper line of the grid (reference level) is always at 0 dB. |

Remote command:

`DISPlay[:WINDow<n>]:TRACe<t>:Y:SPACing` on page 799

`DISPlay[:WINDow<n>]:TRACe<t>:Y[:SCALe]:MODE` on page 798

**7.4.4 How to Optimize the Amplitude Display**

This section gives you some advice on how to optimize the display of the measured signal amplitudes depending on the required evaluation.

1. Perform a measurement with the default settings to get an impression of the values to be expected.

2. Use the "Auto Level" function (AUTO menu) to optimize the reference level.
3. Use the "AF Auto Scale" function (AUTO menu) to optimize the scaling.
4. **To determine a precise level at a specific point in the signal:**
  - Reduce the "Range" of the y-axis to a small area around the required level. If necessary, change the "Ref Level Position" so the required range remains visible.
  - Select "Linear with Unit" scaling.

Now you can set a marker at the point in question and read the result.

5. **To detect a spurious signal close to the noise floor:**
  - Set the "RF Attenuation" to "Manual" mode and reduce the "Value" to lower the noise floor.
  - Select "Relative" - "Logarithmic" scaling.

Now you can determine if any spurious levels of a certain size are visible.

## 7.5 Bandwidth, Filter and Sweep Configuration

The basic bandwidth, filter and sweep settings that apply to most measurements are described here. These parameters define how the data is measured: how much data is collected internally and which filters are used.

- [Impact of the Bandwidth, Filter and Sweep Settings](#).....360
- [Bandwidth, Filter and Sweep Settings](#)..... 366
- [Reference: List of Available RRC and Channel Filters](#)..... 373

### 7.5.1 Impact of the Bandwidth, Filter and Sweep Settings

The bandwidth, filter and sweep settings are closely related and interdependent. The values available for resolution bandwidth and video bandwidth depend on the selected filter type. In addition, these settings have an impact on other measurement parameters. The following equation shows the interdependency of these settings:

$$T_{\text{MIN}} = K \cdot \text{Span} / \text{RBW}^2$$

where K = Filter constant

By default, a Gaussian filter is used. The resolution bandwidth, the video bandwidth and the "Sweep Time" are set automatically according to the set span, and default coupling is used. Thus, the following settings are applied:

$$\text{RBW} = 100 \cdot \text{Span}$$

$$\text{VBW} = \text{RBW} = 100 \cdot \text{Span}$$

$$\text{"Sweep Time"} = T_{\text{min}} \text{ for set Span, RBW, VBW}$$



When defining the bandwidth and filter settings, consider the impact of the individual settings on the other settings and the measurement result, as described in more detail in the following sections.

- [Separating Signals by Selecting an Appropriate Resolution Bandwidth](#)..... 361
- [Smoothing the Trace Using the Video Bandwidth](#)..... 362
- [Coupling VBW and RBW](#)..... 362
- [Coupling Span and RBW](#)..... 363
- [How Data is Measured: the Sweep Type](#).....363
- [Which Data May Pass: Filter Types](#)..... 364
- [How Long the Data is Measured: Sweep Time](#) .....365
- [How Much Data is Measured: Sweep Points and Sweep Count](#)..... 365
- [How Often Data is Measured: Sweep Mode](#).....366

### 7.5.1.1 Separating Signals by Selecting an Appropriate Resolution Bandwidth

The resolution bandwidth defines the 3 dB bandwidth of the resolution filter to be used. An RF sinusoidal signal is displayed according to the passband characteristic of the resolution filter (RBW), i.e. the signal display reflects the shape of the filter.

A basic feature of a signal analyzer is being able to separate the spectral components of a mixture of signals. The resolution at which the individual components can be separated is determined by the resolution bandwidth. Selecting a resolution bandwidth that is too large may make it impossible to distinguish between spectral components, i.e. they are displayed as a single component. Smaller resolution bandwidths, however, increase the required "Sweep Time" .

Two signals with the same amplitude can be resolved if the resolution bandwidth is smaller than or equal to the frequency spacing of the signal. If the resolution bandwidth is equal to the frequency spacing, the spectrum display screen shows a level drop of 3 dB precisely in the center of the two signals. Decreasing the resolution bandwidth makes the level drop larger, which thus makes the individual signals clearer.

The highest sensitivity is obtained at the smallest bandwidth (1 Hz). If the bandwidth is increased, the reduction in sensitivity is proportional to the change in bandwidth. Increasing the bandwidth by a factor of 3 increases the displayed noise by approx. 5 dB (4.77 dB precisely). If the bandwidth is increased by a factor of 10, the displayed noise increases by a factor of 10, i.e. 10 dB.

If there are large level differences between signals, the resolution is determined by selectivity as well as by the resolution bandwidth that has been selected. The measure of selectivity used for signal analyzers is the ratio of the 60 dB bandwidth to the 3 dB bandwidth (= shape factor).

For the R&S FPS, the shape factor for bandwidths is < 5, i.e. the 60 dB bandwidth of the 30 kHz filter is <150 kHz.

The higher spectral resolution with smaller bandwidths is won by longer "Sweep Time" s for the same span. The "Sweep Time" has to allow the resolution filters to settle during a sweep at all signal levels and frequencies to be displayed.

If the RBW is too large, signal parts that are very far away (e.g. from a different signal) are considered in the measurement and distort the results. The noise increases.

If the RBW is too small, parts of the signal are lost. As the displayed signal always reflects the shape of the filter, select a bandwidth large enough so the displayed signal reflects the entire shape of the filter.

### 7.5.1.2 Smoothing the Trace Using the Video Bandwidth

The video filters are responsible for smoothing the displayed trace. Using video bandwidths that are small compared to the resolution bandwidth, only the signal average is displayed and noise peaks and pulsed signals are repressed. If pulsed signals are to be measured, it is advisable to use a video bandwidth that is large compared to the resolution bandwidth ( $VBW = 10 \times RBW$ ) for the amplitudes of pulses to be measured correctly.

The level of a sine wave signal is not influenced by the video bandwidth. A sine wave signal can therefore be freed from noise by using a video bandwidth that is small compared with the resolution bandwidth, and thus be measured more accurately.



#### RMS/Average detector and VBW

If an RMS or average detector is used, the video bandwidth in the hardware is bypassed. Thus, duplicate trace averaging with small VBWs and RMS or average detector no longer occurs. However, the VBW is still considered when calculating the "Sweep Time". This leads to a longer "Sweep Time" for small VBW values. Thus, you can reduce the VBW value to achieve more stable trace curves even when using an RMS or average detector. Normally, if the RMS or average detector is used the "Sweep Time" should be increased to get more stable traces.

### 7.5.1.3 Coupling VBW and RBW

The video bandwidth can be coupled to the resolution bandwidth automatically. In this case, if the resolution bandwidth is changed, the video bandwidth is automatically adjusted.

Coupling is recommended if a minimum "Sweep Time" is required for a selected resolution bandwidth. Narrow video bandwidths require longer "Sweep Time" s due to the longer settling time. Wide bandwidths reduce the signal/noise ratio.

**Table 7-1: Overview of RBW/VBW ratios and recommendations for use**

| Ratio RBW/VBW                | Recommendation for use                                                                                                                                                                                   |
|------------------------------|----------------------------------------------------------------------------------------------------------------------------------------------------------------------------------------------------------|
| 1/1                          | Recommended for sinusoidal signals<br>This is the default setting for automatic coupling.                                                                                                                |
| 0.1                          | Recommended when the amplitudes of pulsed signals are to be measured correctly. The IF filter is exclusively responsible for the pulse shape. No additional evaluation is performed by the video filter. |
| 10                           | Recommended to suppress noise and pulsed signals in the video domain.                                                                                                                                    |
| Manually set (0.001 to 1000) | Recommended for other measurement requirements                                                                                                                                                           |

#### 7.5.1.4 Coupling Span and RBW

The resolution bandwidth can be coupled to the span setting, either by a manually defined factor or automatically. If the span is changed, the resolution bandwidth is automatically adjusted. The automatic coupling adapts the resolution bandwidth to the currently set frequency span/100.

With a span/RBW ratio of 100 and a screen resolution of 1000 pixels, each frequency in the spectrum is displayed by 10 pixels. A span/RBW ratio of 1000 provides the highest resolution.

A higher span/RBW ratio (i.e. low RBW values and large frequency spans), however, results in large amounts of data.

#### 7.5.1.5 How Data is Measured: the Sweep Type

In a standard analog **frequency sweep**, the local oscillator of the analyzer sweeps the applied signal quasi analog from the start to the stop frequency to determine the frequency spectrum.

Alternatively, the analyzer can sample signal levels over time at a defined frequency and transform the data to a spectrum by Fast Fourier Transformation (**FFT**). Although this measurement method requires additional calculations, it can provide results much faster than the frequency sweep, in particular for small RBWs.

Which sweep mode is appropriate for the current measurement depends on the span, RBW, VBW and "Sweep Time" settings. By default ("Auto" sweep type), the R&S FPS automatically uses the sweep type with the highest sweep rate depending on these measurement settings.



#### Restrictions for FFT mode

FFT mode is not available when using 5-Pole filters, Channel filters or RRC filters. In this case, sweep mode is used.

The same applies when an external generator is active (with the optional External Generator Control).

---

#### Optimization

In FFT mode, FFT analysis is performed to determine a spectrum of frequencies. Several analysis steps are required to cover the entire span. The partial span which is covered by one FFT analysis depends on the RBW. The partial span cannot be defined directly, but it can be optimized according to measurement requirements.

Narrow partial spans provide a higher dynamic range, and also allow you to perform measurements near a carrier with a reduced reference level. With a wide partial span, the carrier and the useful signal are likely to be measured at the same time, in which case the powers of both signals are summarized, so the reference level must be high enough to consider this factor. With a narrow partial span, this is less likely to happen, so the reference level can be reduced.

For an optimal dynamic range, the narrowest possible partial span (depending on the RBW) is used.

On the other hand, the narrower the partial span, the more steps are required to cover the entire span, thus increasing analysis and calculation time. To **optimize the sweep rate**, the widest possible partial span (depending on the RBW) is used.



For an optimal sweep rate, it is recommended that you set the "Sweep Time" to "Auto" , as well.

For general purpose measurements, an "Auto" mode is available, which provides a **compromise between a large dynamic range and a fast sweep**. In this case, a medium-sized partial span is used.

#### Optimization for zero span sweeps

For normal sweeps in the time domain (zero span), the optimization mode determines the selection of the A/D converter prefilter, which depends on the RBW.

In "**Dynamic**" mode, the narrowest possible prefilter is used.

In "**Speed**" mode, the widest possible prefilter is used.

In "**Auto**" mode, a medium-sized prefilter is used.

#### 7.5.1.6 Which Data May Pass: Filter Types

While the filter is irrelevant when measuring individual narrowband signals (as long as the signal remains within the RBW), the measurement result for broadband signals is very dependant on the selected filter type and its shape. If the filter is too narrow, the signal is distorted by the filter. If the filter is too wide, multiple signals can no longer be distinguished. Generally, the smaller the filter width and the steeper its edges, the longer the settling time and thus the longer the "Sweep Time" must be.

All resolution bandwidths are realized with digital filters. Normal (3dB) Gaussian filters are set by default. Some communication standards require different filters.

For a list of available filter types, see [Chapter 7.5.3, "Reference: List of Available RRC and Channel Filters"](#), on page 373.

#### Normal (3 dB) Gaussian filters

Gaussian filters provide a good compromise between steep edges and a short settling time. This filter is suitable for most measurement tasks and is used by default.

The available Gaussian (3 dB) filters are listed in the R&S FPS data sheet.

#### Channel filters

Channel filters are fairly steep but require a long settling time; they are useful for pulse measurements in the time domain.

### RRC filters

Root raised cosine filters are similar in shape to channel filters and are required by some measurement standards.

### 5-Pole filters

5-Pole filters are very broad and allow for a large bandwidth to pass.

#### 7.5.1.7 How Long the Data is Measured: Sweep Time

Each filter has a settling time that must be awaited in order to obtain correct results. Since the resolution bandwidth and video bandwidth define the filter, the smaller of the two determines the minimum "Sweep Time" required for the measurement. Allowed values depend on the ratio of span to RBW and RBW to VBW.

If the selected "Sweep Time" is too short for the selected bandwidth and span, level measurement errors will occur. In this case, the R&S FPS displays the error message "Sweep time too low" and marks the indicated "Sweep Time" with a red bullet. Furthermore, a status bit indicates an error.

(For more information see "[STATus:QUESTIONable:TIME Register](#)" on page 599.)

The "Sweep Time" can be coupled to the span (not zero span), video bandwidth (VBW) and resolution bandwidth (RBW) automatically. If the span, resolution bandwidth or video bandwidth is changed, the "Sweep Time" is automatically adjusted.

#### 7.5.1.8 How Much Data is Measured: Sweep Points and Sweep Count

By default, 1001 data points are determined in a single sweep. During the next sweep, 1001 new data points are collected, and so on. The number of **sweep points** defines how much of the entire span is covered by a single data point. By increasing the number of sweep points you can increase the reliability of the individual data points and thus the accuracy of the analyzed results. However, these data points are all stored on the instrument, occupying a large amount of memory, and each sweep point increases the overall measurement time.

The number of sweeps to be performed in single sweep mode is defined by the "Sweep Count". Values from 0 to 200000 are allowed. If the values 0 or 1 are set, one sweep is performed. The sweep count is applied to all the traces in a diagram.

If the trace configurations "Average" , "Max Hold" or "Min Hold" are set, the "Sweep/Average Count" also determines the number of averaging or maximum search procedures (see "[Analyzing Several Traces - Trace Mode](#)" on page 462).

For details on how the number of sweep points and the sweep count affect the trace results on the screen, see "[Mapping Samples to sweep Points with the Trace Detector](#)" on page 459.

### 7.5.1.9 How Often Data is Measured: Sweep Mode

How often the spectrum is swept depends on the sweep mode. Either a certain number of sweeps can be defined ("Sweep Count") which are performed in "Single Sweep" mode, or the sweep is repeated continuously ("Continuous Sweep" mode).

By default, the data is collected for the specified number of sweeps and the corresponding trace is displayed. When the next sweep is started, the previous trace is deleted.

However, the data from a single sweep run can also be retained and displayed together with the new data ("Continue Single Sweep" mode). This is particularly of interest when using the trace configurations "Average" or "Max Hold" to take previously recorded measurements into account for averaging/maximum search (see ["Analyzing Several Traces - Trace Mode"](#) on page 462).

## 7.5.2 Bandwidth, Filter and Sweep Settings

**Access:** "Overview" > "Bandwidth"

The remote commands required to define these settings are described in [Chapter 12.7.2, "Configuring Bandwidth and Sweep Settings"](#), on page 785.

How to perform a basic sweep measurement is described in [Chapter 6.1.2, "How to Perform a Basic Sweep Measurement"](#), on page 125.



Figure 7-15: Bandwidth dialog box for RF measurements

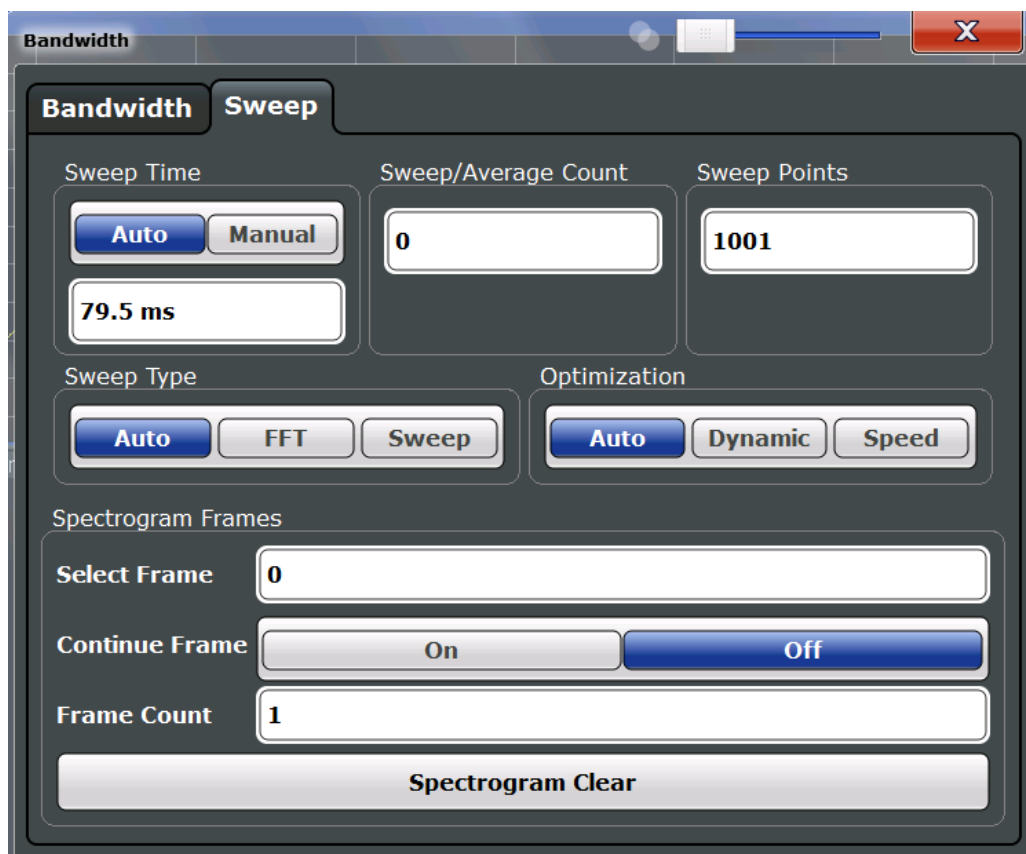

Figure 7-16: Sweep dialog box for spectrogram display

|                                   |     |
|-----------------------------------|-----|
| RBW .....                         | 368 |
| VBW .....                         | 368 |
| Sweep Time .....                  | 368 |
| Span/RBW .....                    | 369 |
| RBW/VBW .....                     | 369 |
| Filter Type .....                 | 369 |
| Default Coupling .....            | 370 |
| Sweep/Average Count .....         | 370 |
| Sweep Points.....                 | 370 |
| Optimization .....                | 370 |
| Sweep Type .....                  | 371 |
| Single Sweep / Run Single .....   | 371 |
| Continuous Sweep / Run Cont ..... | 371 |
| Continue Single Sweep .....       | 372 |
| Spectrogram Frames .....          | 372 |
| L Select Frame.....               | 372 |
| L Continue Frame .....            | 372 |
| L Frame Count .....               | 373 |
| L Clear Spectrogram .....         | 373 |

**RBW**

Defines the resolution bandwidth. The available resolution bandwidths are specified in the data sheet. Numeric input is always rounded to the nearest possible bandwidth.

If "Auto" is selected, the resolution bandwidth is coupled to the selected span (for span > 0). If the span is changed, the resolution bandwidth is automatically adjusted.

If the resolution bandwidth is defined manually, a green bullet is displayed next to the "RBW" display in the channel bar.

For more information see [Chapter 7.5.1.1, "Separating Signals by Selecting an Appropriate Resolution Bandwidth"](#), on page 361.

For measurements on I/Q data in the frequency domain, the maximum RBW is 1 MHz.

Remote command:

[\[SENSe:\]BANDwidth\[:RESolution\]](#) on page 785

[\[SENSe:\]BANDwidth\[:RESolution\]:AUTO](#) on page 786

**VBW**

Defines the video bandwidth automatically or manually.

For more information see [Chapter 7.5.1.2, "Smoothing the Trace Using the Video Bandwidth"](#), on page 362.

"Auto"                    The video bandwidth is coupled to the resolution bandwidth. If the resolution bandwidth is changed, the video bandwidth is automatically adjusted.

"Manual"                For manual mode, define the bandwidth value. The available video bandwidths are specified in the data sheet. Numeric input is always rounded to the nearest possible bandwidth.  
If the video bandwidth is defined manually, a green bullet is displayed next to the "VBW" display in the channel bar.

Remote command:

[\[SENSe:\]BANDwidth:VIDeo:AUTO](#) on page 787

[\[SENSe:\]BANDwidth:VIDeo](#) on page 787

**Sweep Time**

Defines the duration of a single sweep, during which the defined number of sweep points are measured. The "Sweep Time" can be defined automatically or manually.

The allowed "Sweep Time" s depend on the device model; refer to the data sheet.

For more information see [Chapter 7.5.1.7, "How Long the Data is Measured: Sweep Time"](#), on page 365.

**Note:** The "Sweep Time" only indicates how long data is captured; the time required to process the captured data may be considerably longer, in particular for FFT mode. For FFT mode, an estimated duration is indicated behind the "Sweep Time" in the channel bar (for RF measurements only).

"Auto"                    The "Sweep Time" is coupled to the span (not zero span), video bandwidth (VBW) and resolution bandwidth (RBW). If the span, resolution bandwidth or video bandwidth is changed, the "Sweep Time" is automatically adjusted.



"Manual" For manual mode, define the "Sweep Time" . Allowed values depend on the ratio of span to RBW and RBW to VBW. For details refer to the data sheet. Numeric input is always rounded to the nearest possible "Sweep Time" .

Remote command:

[SENSe:] SWEep:TIME:AUTO on page 790

[SENSe:] SWEep:TIME on page 790

### Span/RBW

Sets the coupling ratio if **RBW** is set to auto mode.

For more information see [Chapter 7.5.1.4, "Coupling Span and RBW"](#), on page 363.

"Auto[100]" "Resolution Bandwidth" = "Span/100"  
This coupling ratio is the default setting of the R&S FPS.

"Manual" The coupling ratio is defined manually.  
The span/resolution bandwidth ratio can be set in the range from 1 to 10000.

Remote command:

[SENSe:] BANDwidth[:RESolution]:RATio on page 786

### RBW/VBW

Sets the coupling ratio between the resolution bandwidth and the video bandwidth.

This setting is only effective if **VBW** is set to auto mode.

For more information see [Chapter 7.5.1.3, "Coupling VBW and RBW"](#), on page 362.

"Sine[1/1]" "Video Bandwidth" = "Resolution Bandwidth"  
This is the default setting for the coupling ratio RBW/VBW and is recommended if sinusoidal signals are to be measured.

"Pulse[0.1]" "Video Bandwidth" = 10 x "Resolution Bandwidth"  
or  
"Video Bandwidth" = "10 MHz" (= max. VBW)  
Recommended for pulse signals

"Noise[10]" "Video Bandwidth" = "Resolution Bandwidth/10"  
Recommended for noise measurements

"Manual" The coupling ratio is defined manually.  
The RBW/VBW ratio can be set in the range of 0.001 to 1000.

Remote command:

[SENSe:] BANDwidth:VIDeo:AUTO on page 787

[SENSe:] BANDwidth:VIDeo:RATio on page 787

### Filter Type

Defines the filter type.

The following filter types are available:

- Normal (3dB)
- Channel
- RRC
- 5-Pole (not available for sweep type "FFT" )

For more information see [Chapter 7.5.1.6, "Which Data May Pass: Filter Types"](#), on page 364.

Remote command:

`[SENSe:]BANDwidth[:RESolution]:TYPE` on page 786

### Default Coupling

Sets all coupled functions to the default state ( "Auto" ). In addition, the ratio "RBW/VBW" is set to "Sine[1/1]" and the ratio "Span/RBW" to 100.

For more information see [Chapter 7.5.1.3, "Coupling VBW and RBW"](#), on page 362.

Remote command:

`[SENSe:]BANDwidth[:RESolution]:AUTO` on page 786

`[SENSe:]BANDwidth:VIDeo:AUTO` on page 787

`[SENSe:]SWEep:TIME:AUTO` on page 790

### Sweep/Average Count

Defines the number of sweep s to be performed in the single sweep mode. Values from 0 to 200000 are allowed. If the values 0 or 1 are set, one sweep is performed.

The sweep count is applied to all the traces in all diagrams.

If the trace modes "Average" , "Max Hold" or "Min Hold" are set, this value also determines the number of averaging or maximum search procedures.

In continuous sweep mode, if "Sweep Count" = 0 (default), averaging is performed over 10 sweep s. For "Sweep Count" =1, no averaging, maxhold or minhold operations are performed.

For more information, see [Chapter 7.5.1.8, "How Much Data is Measured: Sweep Points and Sweep Count"](#), on page 365.

For spectrogram displays, the sweep count determines how many sweep s are combined in one frame in the spectrogram; that is: how many sweep s the R&S FPS performs to plot one trace in the spectrogram result display. For more details, see ["Time Frames"](#) on page 472.

Remote command:

`[SENSe:]SWEep:COUNT` on page 789

`[SENSe:]AVERAge<n>:COUNT` on page 841

### Sweep Points

Defines the number of measured values to be collected during one sweep.

For details see [Chapter 7.5.1.8, "How Much Data is Measured: Sweep Points and Sweep Count"](#), on page 365.

All values from 101 to 32001 can be set. The default value is 1001 sweep points.

Remote command:

`[SENSe:]SWEep:POINTs` on page 790

### Optimization

In FFT mode, several FFT analysis steps are required to cover the entire measurement span. The span which is covered by one FFT analysis step is called *partial span*. The partial span cannot be defined directly, but it can be optimized according to measurement requirements.

Table 7-2: Optimization parameters in FFT mode

| Optimization mode | Description                                                                                                                                                                                       |
|-------------------|---------------------------------------------------------------------------------------------------------------------------------------------------------------------------------------------------|
| Dynamic           | Optimizes the dynamic range by using the narrowest possible partial span (depending on the RBW).                                                                                                  |
| Speed             | Optimizes the sweep rate by using the widest possible partial span (depending on the RBW).<br>It is recommended that you set the <a href="#">Sweep Time</a> to "Auto" to optimize the sweep rate. |
| Auto              | Uses a medium-sized partial span to obtain a compromise between a large dynamic range and a fast sweep rate.                                                                                      |

Remote command:

[\[SENSe:\]SWEep:OPTimize](#) on page 789

### Sweep Type

Defines the sweep type.

|         |                                                                                                                                                                                                                                                                                                                                                                                                                                    |
|---------|------------------------------------------------------------------------------------------------------------------------------------------------------------------------------------------------------------------------------------------------------------------------------------------------------------------------------------------------------------------------------------------------------------------------------------|
| "Sweep" | In the standard sweep mode, the local oscillator is set to provide the spectrum quasi analog from the start to the stop frequency.                                                                                                                                                                                                                                                                                                 |
| "Auto"  | Automatically sets the fastest available sweep type for the current measurement (Frequency or FFT). Auto mode is set by default.                                                                                                                                                                                                                                                                                                   |
| "FFT"   | The FFT sweep samples on a defined frequency value and transforms it to the spectrum by fast Fourier transformation (FFT) (see also <a href="#">Chapter 7.5.1.5, "How Data is Measured: the Sweep Type"</a> , on page 363).<br>FFT is not available in the following cases: <ul style="list-style-type: none"> <li>• when using 5-Pole filters, Channel filters or RRC filters</li> </ul> In these cases, frequency sweep is used. |

Remote command:

[\[SENSe:\]SWEep:TYPE](#) on page 791

### Single Sweep / Run Single

After triggering, starts the number of sweeps set in "Sweep Count". The measurement stops after the defined number of sweeps has been performed.

While the measurement is running, the "Single Sweep" softkey and the RUN SINGLE key are highlighted. The running measurement can be aborted by selecting the highlighted softkey or key again.

Remote command:

[INITiate<n>\[:IMMEDIATE\]](#) on page 636

[CALCulate<n>:SPECTrogram:CONTinuous](#) on page 845

### Continuous Sweep / Run Cont

After triggering, starts the measurement and repeats it continuously until stopped.

While the measurement is running, the "Continuous Sweep" softkey and the RUN CONT key are highlighted. The running measurement can be aborted by selecting the highlighted softkey or key again. The results are not deleted until a new measurement is started.

**Note:** Sequencer. If the Sequencer is active, the "Continuous Sweep" softkey only controls the sweep mode for the currently selected channel. However, the sweep mode only takes effect the next time the Sequencer activates that channel, and only for a channel-defined sequence. In this case, a channel in continuous sweep mode is swept repeatedly.

Furthermore, the RUN CONT key controls the Sequencer, not individual sweeps. RUN CONT starts the Sequencer in continuous mode.

For details on the Sequencer, see [Chapter 5.4.1, "The Sequencer Concept"](#), on page 119.

Remote command:

`INITiate<n>:CONTInuous` on page 635

### Continue Single Sweep

After triggering, repeats the number of sweeps set in "Sweep Count", without deleting the trace of the last measurement.

While the measurement is running, the "Continue Single Sweep" softkey and the RUN SINGLE key are highlighted. The running measurement can be aborted by selecting the highlighted softkey or key again.

Remote command:

`INITiate<n>:CONMeas` on page 634

### Spectrogram Frames

These settings are only available if spectrogram display is active.

For more information see [Chapter 8.5.2.3, "How to Display and Configure a Spectrogram"](#), on page 482.

### Select Frame ← Spectrogram Frames

Selects a specific frame, loads the corresponding trace from the memory, and displays it in the Spectrum window.

Note that activating a marker or changing the position of the active marker automatically selects the frame that belongs to that marker.

This function is only available in single sweep mode or if the sweep is stopped, and only if a spectrogram is selected.

The most recent frame is number 0, all previous frames have a negative number.

For more details see ["Time Frames"](#) on page 472.

Remote command:

`CALCulate<n>:SPECTrogram:FRAMe:SElect` on page 846

### Continue Frame ← Spectrogram Frames

Determines whether the results of the previous sweeps are included in the analysis of the next sweeps for trace modes "Max Hold", "Min Hold", and "Average".

This function is available in single sweep mode only.

- **On**

When the average or peak values are determined for the new sweep, the results of the previous sweeps in the spectrogram are also taken into account.

- **Off**

The average or peak values are determined from the results of the newly swept frames only.

Remote command:

`CALCulate<n>:SPECTrogram:CONTinuous` on page 845

#### Frame Count ← Spectrogram Frames

Determines how many frames are plotted during a single sweep (as opposed to a continuous sweep). The maximum number of possible frames depends on the history depth (see "History Depth" on page 479).

For more details see "Time Frames" on page 472.

Remote command:

`CALCulate<n>:SPECTrogram:FRAMe:COUNT` on page 845

#### Clear Spectrogram ← Spectrogram Frames

Resets the spectrogram result display and clears the history buffer.

This function is only available if a spectrogram is selected.

Remote command:

`CALCulate<n>:SPECTrogram:CLEAr[:IMMediate]` on page 844

### 7.5.3 Reference: List of Available RRC and Channel Filters

For power measurement a number of especially steep-edged channel filters are available (see the following table). The indicated filter bandwidth is the 3 dB bandwidth.

For RRC filters, the fixed roll-off factor ( $\alpha$ ) is also indicated.



The available Gaussian 3 dB sweep filters are listed in the R&S FPS data sheet.

**Table 7-3: Filter types**

| Filter Bandwidth | Filter Type | Application |
|------------------|-------------|-------------|
| 100 Hz           | CFILter     |             |
| 200 Hz           | CFILter     |             |
| 300 Hz           | CFILter     |             |
| 500 Hz           | CFILter     |             |
|                  |             |             |
| 1 kHz            | CFILter     |             |
| 1.5 kHz          | CFILter     |             |
| 2 kHz            | CFILter     |             |
| 2.4 kHz          | CFILter     | SSB         |
| 2.7 kHz          | CFILter     |             |

| Filter Bandwidth | Filter Type | Application                        |
|------------------|-------------|------------------------------------|
| 3 kHz            | CFILter     |                                    |
| 3.4 kHz          | CFILter     |                                    |
| 4 kHz            | CFILter     | DAB, Satellite                     |
| 4.5 kHz          | CFILter     |                                    |
| 5 kHz            | CFILter     |                                    |
| 6 kHz            | CFILter     |                                    |
| 6 kHz, a=0.2     | RRC         | APCO                               |
| 8.5 kHz          | CFILter     | ETS300 113 (12.5 kHz channels)     |
| 9 kHz            | CFILter     | AM Radio                           |
|                  |             |                                    |
| 10 kHz           | CFILter     |                                    |
| 12.5 kHz         | CFILter     | CDMAone                            |
| 14 kHz           | CFILter     | ETS300 113 (20 kHz channels)       |
| 15 kHz           | CFILter     |                                    |
| 16 kHz           | CFILter     | ETS300 113 (25 kHz channels)       |
| 18 kHz, a=0.35   | RRC         | TETRA                              |
| 20 kHz           | CFILter     |                                    |
| 21 kHz           | CFILter     | PDC                                |
| 24.3 kHz, a=0.35 | RRC         | IS 136                             |
| 25 kHz           | CFILter     | APCO 25-P2                         |
| 30 kHz           | CFILter     | CDPD, CDMAone                      |
| 50 kHz           | CFILter     |                                    |
|                  |             |                                    |
| 100 kHz          | CFILter     |                                    |
| 150 kHz          | CFILter     | FM Radio                           |
| 192 kHz          | CFILter     | PHS                                |
| 200 kHz          | CFILter     | GSM                                |
| 300 kHz          | CFILter     |                                    |
| 500 kHz          | CFILter     | J.83 (8-VSB DVB, USA); RF ID 14333 |
|                  |             |                                    |
| 1 MHz            | CFILter     | CDMAone                            |
| 1.228 MHz        | CFILter     | CDMAone                            |
| 1.28 MHz, a=0.22 | RRC         | TD-SCDMA                           |

| Filter Bandwidth                                                              | Filter Type | Application       |
|-------------------------------------------------------------------------------|-------------|-------------------|
| 1.5 MHz                                                                       | CFILter     | DAB               |
| 2 MHz                                                                         | CFILter     |                   |
| 3 MHz                                                                         | CFILter     |                   |
| 3.75 MHz                                                                      | CFILter     |                   |
| 3.84 MHz, a=0.22                                                              | RRC         | W-CDMA 3GPP       |
| 4.096 MHz, a=0.22                                                             | RRC         | W-CDMA NTT DOCoMo |
| 5 MHz                                                                         | CFILter     |                   |
| 20 MHz *)                                                                     | CFILter     |                   |
| 28 MHz *)                                                                     | CFILter     |                   |
| 40 MHz *)                                                                     | CFILter     |                   |
| Filters larger than 28 MHz require an appropriate bandwidth extension option. |             |                   |

## 7.6 Trigger and Gate Configuration

Triggering means to capture the interesting part of the signal. Choosing the right trigger type and configuring all trigger settings correctly allows you to detect various incidents in your signals.

Gating allows you to restrict measurement analysis to the important part or parts of the signal, for example bursts.

- [Triggering](#).....375
- [Gating](#).....385

### 7.6.1 Triggering

#### 7.6.1.1 Triggered Measurements

In a basic measurement with default settings, the sweep is started immediately. However, sometimes you want the measurement to start only when a specific condition is fulfilled, for example a signal level is exceeded, or in certain time intervals. For these cases you can define a trigger for the measurement. In FFT sweep mode, the trigger defines when the data acquisition starts for the FFT conversion.

An "Offset" can be defined to delay the measurement after the trigger event, or to include data before the actual trigger event in time domain measurements (pre-trigger offset).

For complex tasks, advanced trigger settings are available:

- Hysteresis to avoid unwanted trigger events caused by noise

- Holdoff to define exactly which trigger event will cause the trigger in a jittering signal
- [Trigger Source](#)..... 376
- [Trigger Offset](#)..... 376
- [Trigger Hysteresis](#)..... 376
- [Trigger Drop-Out Time](#)..... 377
- [Trigger Holdoff](#)..... 378

### Trigger Source

The trigger source defines which source must fulfill the condition that triggers the measurement. Basically, this can be:

- Power: an input signal is checked for a defined power level  
The trigger signal can be any of the following:
  - The input signal at one of various stages in the signal analysis process - before or after the input mixer, after the video filter etc.
  - A signal from an external device via one of the TRG IN / AUX connectors on the instrument

For details on the available trigger sources see "[Trigger Source](#)" on page 381.

### Trigger Offset

An offset can be defined to delay the measurement after the trigger event, or to include data before the actual trigger event in time domain measurements (pre-trigger offset). Pre-trigger offsets are possible because the R&S FPS captures data continuously in the time domain, even before the trigger occurs.

See "[Trigger Offset](#)" on page 383.

### Trigger Hysteresis

Setting a hysteresis for the trigger helps avoid unwanted trigger events caused by noise, for example. The hysteresis is a threshold to the trigger level that the signal must fall below on a rising slope or rise above on a falling slope before another trigger event occurs.



**Example:**

In the following example, the second possible trigger event is ignored as the signal does not exceed the hysteresis (threshold) before it reaches the trigger level again on the rising edge. On the falling edge, however, two trigger events occur as the signal exceeds the hysteresis before it falls to the trigger level the second time.

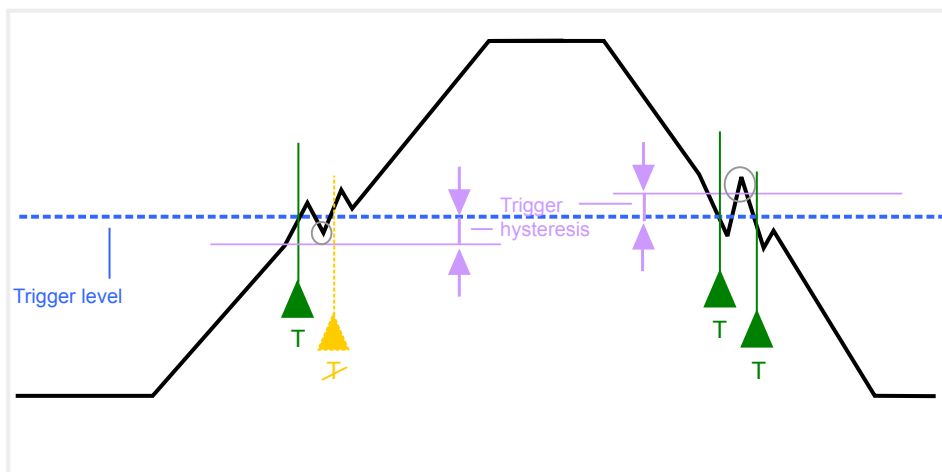
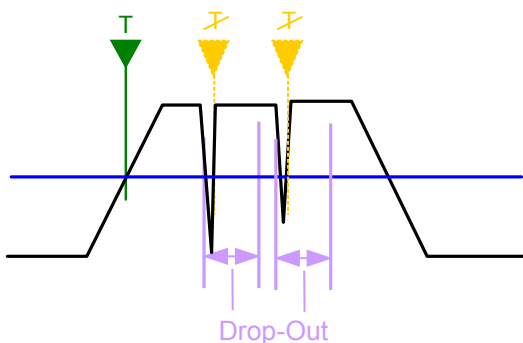

**Figure 7-17: Effects of the trigger hysteresis**

See " [Hysteresis](#) " on page 383

**Trigger Drop-Out Time**

If a modulated signal is instable and produces occasional "drop-outs" during a burst, you can define a minimum duration that the input signal must stay below the trigger level before triggering again. This is called the "drop-out" time. Defining a dropout time helps you stabilize triggering when the analyzer is triggering on undesired events.



**Figure 7-18: Effect of the trigger drop-out time**

See " [Drop-Out Time](#) " on page 383.



### Drop-out times for falling edge triggers

If a trigger is set to a falling edge ( "Slope" = "Falling" , see " [Slope](#) " on page 384) the measurement is to start when the power level falls below a certain level. This is useful, for example, to trigger at the end of a burst, similar to triggering on the rising edge for the beginning of a burst.

If a drop-out time is defined, the power level must remain below the trigger level at least for the duration of the drop-out time (as defined above). However, if a drop-out time is defined that is longer than the pulse width, this condition cannot be met before the final pulse, so a trigger event will not occur until the pulsed signal is over!

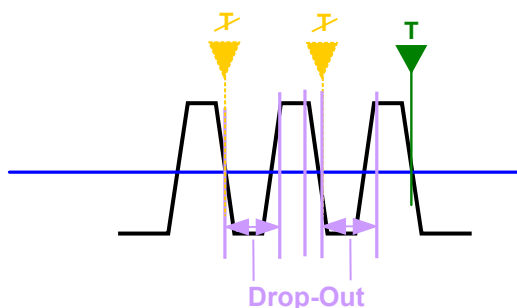

Figure 7-19: Trigger drop-out time for falling edge trigger

For gated measurements, a combination of a falling edge trigger and a drop-out time is generally not allowed.

### Trigger Holdoff

The trigger holdoff defines a waiting period before the next trigger after the current one will be recognized.

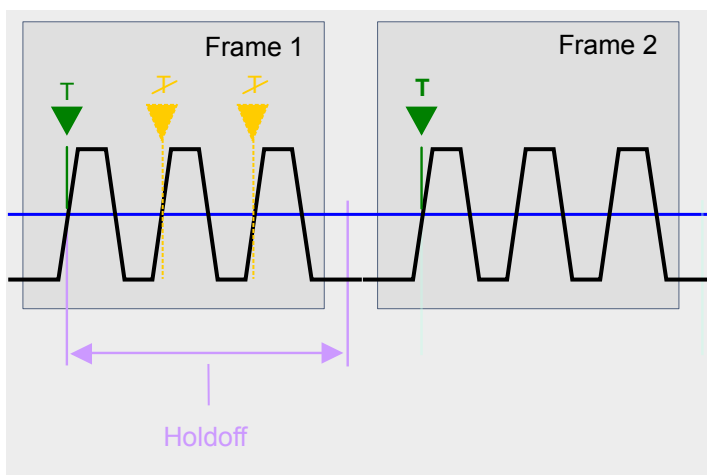
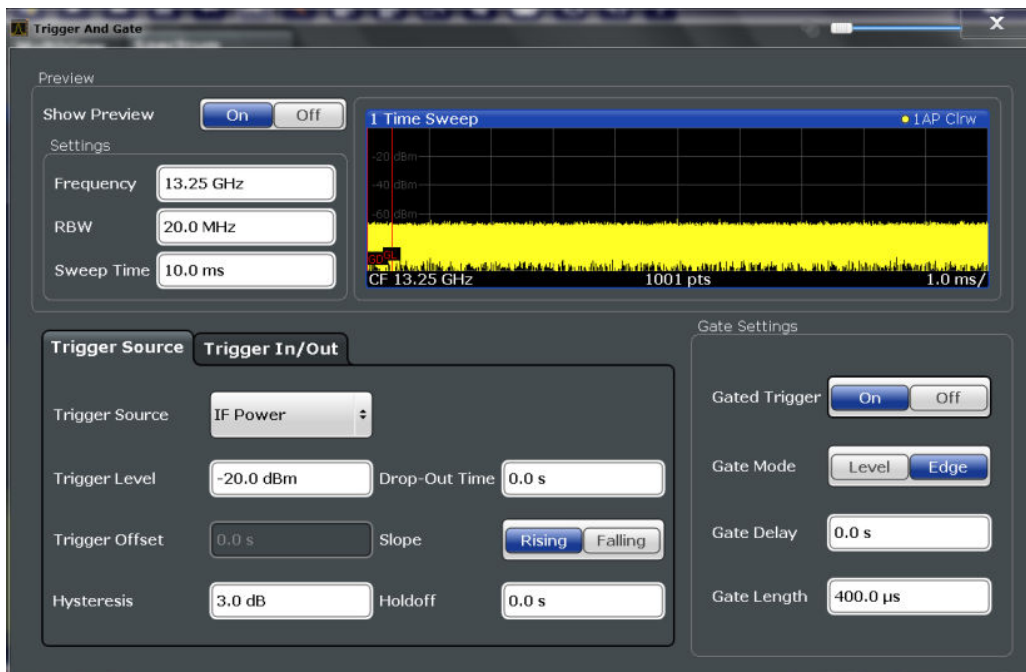

Figure 7-20: Effect of the trigger holdoff

See " [Trigger Holdoff](#) " on page 383.

7.6.1.2 Trigger Settings

Access: "Overview" > "Trigger/Gate"



External triggers from one of the TRG IN / AUX connectors on the R&S FPS are configured in a separate tab of the dialog box.

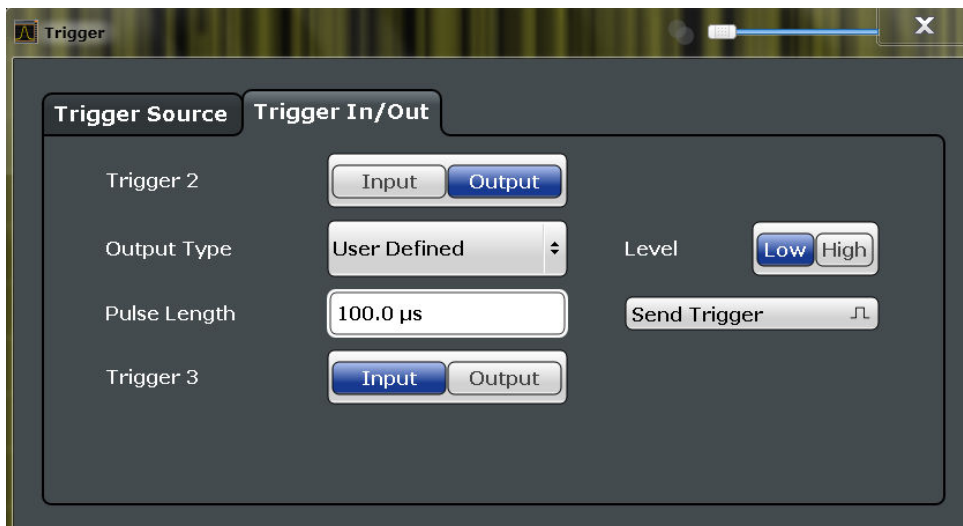

For step-by-step instructions on configuring triggered measurements, see [Chapter 7.6.1.4, "How to Configure a Triggered Measurement"](#), on page 384.

|                      |     |
|----------------------|-----|
| Preview .....        | 380 |
| L Frequency .....    | 380 |
| L RBW .....          | 380 |
| L Sweep Time .....   | 380 |
| Trigger Source ..... | 381 |

|                             |     |
|-----------------------------|-----|
| L Free Run .....            | 381 |
| L External Trigger 1/2..... | 381 |
| L Video .....               | 381 |
| L IF Power .....            | 382 |
| L RF Power .....            | 382 |
| Trigger Level .....         | 382 |
| Drop-Out Time .....         | 383 |
| Trigger Offset .....        | 383 |
| Hysteresis .....            | 383 |
| Trigger Holdoff .....       | 383 |
| Slope .....                 | 384 |

### Preview

The preview mode allows you to try out trigger and gate settings before actually applying them to the current measurement.

The preview diagram displays a zero span measurement at the center frequency with the defined RBW and sweep time. This is useful to analyze bursts, for example, to determine the required gate settings.

The trigger and gate settings are applied to the measurement when the dialog box is closed.

**Note:** The zero span settings refer only to the preview diagram. The main diagram remains unchanged.

If preview mode is switched off, any changes to the settings in this dialog box are applied to the measurement diagram directly. In this case, the zero span settings for the preview diagram are not displayed.

For information on the zero span settings see:

- " [Center Frequency](#) " on page 347
- " [RBW](#) " on page 368
- " [Sweep Time](#) " on page 368

### Frequency ← Preview

Defines the center frequency.

Remote command:

`[SENSe:]FREQuency:CENTer` on page 777

### RBW ← Preview

Defines the bandwidth value. The available resolution bandwidths are specified in the data sheet. Numeric input is always rounded to the nearest possible bandwidth.

Remote command:

`[SENSe:]BANDwidth[:RESolution]` on page 785

### Sweep Time ← Preview

Defines the sweep time. Allowed values depend on the ratio of span to RBW and RBW to VBW. For details refer to the data sheet. Numeric input is always rounded to the nearest possible sweep time.

Remote command:

`[SENSe:]SWEep:TIME` on page 790

**Trigger Source**

Selects the trigger source. If a trigger source other than "Free Run" is set, "TRG" is displayed in the channel bar and the trigger source is indicated.

For gated measurements, this setting also selects the gating source.

For more information see "[Trigger Source](#)" on page 376.

Remote command:

[TRIGger \[ :SEQuence \] :SOURce](#) on page 803

[\[SENSe: \]SWEep:EGATe:SOURce](#) on page 806

**Free Run ← Trigger Source**

No trigger source is considered. Data acquisition is started manually or automatically and continues until stopped explicitly.

In the Spectrum application, this is the default setting.

Remote command:

`TRIG:SOUR IMM`, see [TRIGger \[ :SEQuence \] :SOURce](#) on page 803

**External Trigger 1/2 ← Trigger Source**

Data acquisition starts when the TTL signal fed into the specified input connector meets or exceeds the specified trigger level.

(See "[Trigger Level](#)" on page 382).

**Note:** The "External Trigger 1" softkey automatically selects the trigger signal from the TRG IN connector.

For details, see the "Instrument Tour" chapter in the R&S FPS Getting Started manual.

"External Trigger 1"

Trigger signal from the TRG IN connector.

"External Trigger 2"

Trigger signal from the TRG AUX connector.

Note: Connector must be configured for "Input" in the "Output" configuration

Remote command:

`TRIG:SOUR EXT, TRIG:SOUR EXT2`

See [TRIGger \[ :SEQuence \] :SOURce](#) on page 803

`SWE:EGAT:SOUR EXT` for gated triggering, see [\[SENSe: \]SWEep:EGATe:SOURce](#) on page 806

**Video ← Trigger Source**

Defines triggering by the video signal, i.e. the filtered and detected version of the input signal (the envelope of the IF signal), as displayed on the screen.

Define a trigger level from 0 % to 100 % of the diagram height. The absolute trigger level is indicated by a horizontal trigger line in the diagram, which you can also move graphically to change the trigger level.

Video mode is only available in the time domain, and not for I/Q-based data.

Remote command:

TRIG:SOUR VID, see TRIGger[:SEQuence]:SOURce on page 803

SWE:EGAT:SOUR VID for gated triggering, see [SENSe:]SWEep:EGATe:SOURce on page 806

### IF Power ← Trigger Source

The R&S FPS starts capturing data as soon as the trigger level is exceeded around the third intermediate frequency.

For frequency sweeps, the third IF represents the start frequency. The trigger bandwidth at the third IF depends on the RBW and sweep type.

For measurements on a fixed frequency (e.g. zero span or I/Q measurements), the third IF represents the center frequency.

This trigger source is only available for RF input.

The available trigger levels depend on the RF attenuation and preamplification. A reference level offset, if defined, is also considered.

For details on available trigger levels and trigger bandwidths, see the data sheet.

**Note:** Be aware that in auto sweep type mode, due to a possible change in sweep types, the trigger bandwidth can vary considerably for the same RBW setting.

Remote command:

TRIG:SOUR IFP, see TRIGger[:SEQuence]:SOURce on page 803

SWE:EGAT:SOUR IFP for gated triggering, see [SENSe:]SWEep:EGATe:SOURce on page 806

### RF Power ← Trigger Source

Defines triggering of the measurement via signals which are outside the displayed measurement range.

For this purpose, the instrument uses a level detector at the first intermediate frequency.

The input signal must be in the frequency range between 500 MHz and 7 GHz.

The resulting trigger level at the RF input depends on the RF attenuation and preamplification. For details on available trigger levels, see the instrument's data sheet.

**Note:** If the input signal contains frequencies outside of this range (e.g. for fullspan measurements), the sweep may be aborted. A message indicating the allowed input frequencies is displayed in the status bar.

A "Trigger Offset", "Trigger Polarity" and "Trigger Holdoff" (to improve the trigger stability) can be defined for the RF trigger, but no "Hysteresis".

Remote command:

TRIG:SOUR RFP, see TRIGger[:SEQuence]:SOURce on page 803

SWE:EGAT:SOUR RFP for gated triggering, see [SENSe:]SWEep:EGATe:SOURce on page 806

### Trigger Level

Defines the trigger level for the specified trigger source.

For gated measurements, this setting also defines the gate level.

For details on supported trigger levels, see the data sheet.

Remote command:

[TRIGger\[:SEquence\]:LEVel:IFPower](#) on page 802

[TRIGger\[:SEquence\]:LEVel:IQPower](#) on page 802

[TRIGger\[:SEquence\]:LEVel\[:EXternal<port>\]](#) on page 801

[TRIGger\[:SEquence\]:LEVel:VIDeo](#) on page 803

[TRIGger\[:SEquence\]:LEVel:RFPower](#) on page 802

### Drop-Out Time

Defines the time the input signal must stay below the trigger level before triggering again.

For more information on the drop-out time, see "[Trigger Drop-Out Time](#)" on page 377.

Remote command:

[TRIGger\[:SEquence\]:DTIME](#) on page 800

### Trigger Offset

Defines the time offset between the trigger event and the start of the sweep .

For more information, see "[Trigger Offset](#)" on page 376.

|             |                                                                                                                                                                                                                                                          |
|-------------|----------------------------------------------------------------------------------------------------------------------------------------------------------------------------------------------------------------------------------------------------------|
| Offset > 0: | Start of the sweep is delayed                                                                                                                                                                                                                            |
| Offset < 0: | Sweep starts earlier (pretrigger)<br>Only possible for zero span (e.g. I/Q Analyzer application) and gated trigger switched off<br>Maximum allowed range limited by the sweep time:<br>$\text{Pretrigger}_{\text{max}} = \text{sweep time}_{\text{max}}$ |

Remote command:

[TRIGger\[:SEquence\]:HOLDoff\[:TIME\]](#) on page 800

### Hysteresis

Defines the distance in dB to the trigger level that the trigger source must exceed before a trigger event occurs. Setting a hysteresis avoids unwanted trigger events caused by noise oscillation around the trigger level.

This setting is only available for "IF Power" trigger sources. The range of the value is between 3 dB and 50 dB with a step width of 1 dB.

For more information, see "[Trigger Hysteresis](#)" on page 376.

Remote command:

[TRIGger\[:SEquence\]:IFPower:HYSteresis](#) on page 801

### Trigger Holdoff

Defines the minimum time (in seconds) that must pass between two trigger events. Trigger events that occur during the holdoff time are ignored.

For more information, see "[Trigger Holdoff](#)" on page 378.

Remote command:

[TRIGger\[:SEquence\]:IFPower:HOLDoff](#) on page 801

**Slope**

For all trigger sources except time, you can define whether triggering occurs when the signal rises to the trigger level or falls down to it.

For gated measurements in "Edge" mode, the slope also defines whether the gate starts on a falling or rising edge.

Remote command:

`TRIGger [:SEquence] :SLOPe` on page 803

`[SENSe:]SWEep:EGATE:POLarity` on page 805

**7.6.1.3 How to Determine the Required Trigger/Gate Parameters**

1. In the "Trigger And Gate" dialog box, switch on "Show Preview" .  
A zero span measurement for the currently defined center frequency is displayed.
2. Set the "Frequency" , "RBW" and "Sweep Time" such that the relevant part of the signal is displayed, for example a complete burst.
3. Determine the parameters you want to use to define the trigger and gate conditions from the preview diagram, for example:
  - the length of a burst or slot
  - the upper or lower power level of a pulse
  - the maximum noise level
  - the power level or time at which a certain incident occurs
4. Try out different trigger and gate settings as described in [How to Configure a Triggered Measurement](#) and [How to Configure a Gated Measurement](#), then select "Update Main Diagram" to see the effect of the current settings on the main measurement in the background.
5. If the results are as expected, close the dialog box to keep the changes permanently. Otherwise, correct the settings as necessary.

**7.6.1.4 How to Configure a Triggered Measurement****To define an external trigger:**

1. Connect an external device that will provide the trigger signal to one of the TRG IN / AUX connectors on the R&S FPS (for details see the R&S FPS "Getting Started" manual).
2. In the "Trigger And Gate" dialog box, define the "Trigger Source" = "External" .
3. If you are using the variable TRG AUX connector, you must define its use as an input connector. In the "Trigger In/Out" tab of the "Trigger And Gate" dialog box, set the corresponding trigger to "Input" .
4. Configure the external trigger as described for the other power triggers.



**To define a power trigger:**

1. In the "Trigger And Gate" dialog box, define the "Trigger Source" = "IF Power" . Alternatively, define "Trigger Source" = "Video" . The video signal corresponds to the envelope of the IF signal: it has been processed by the resolution and video filters and the selected detector.
2. Define the "Trigger Level" : the power level at which the measurement will start. For a "Video" trigger source you can move the level line graphically to define the level. If you define the value numerically, you must enter a percentage of the full diagram height as the level.
3. Define whether the signal must cross the trigger level on a falling or on a rising edge ( "Slope" ) to trigger the measurement.
4. To start the measurement with a time delay, define a "Trigger Offset" .
5. To reject triggers due to noise or jittering in the signal, define a "Hysteresis" that is larger than the expected noise or jittering. After the previous trigger, the signal must exceed this threshold before the next level crossing triggers a new measurement.
6. To skip multiple triggers in a burst, define a "Holdoff" time that must pass between two triggers. The holdoff time should be slightly larger than the burst.

**7.6.2 Gating**

- [Gated Measurements](#).....385
- [Gate Settings](#)..... 388
- [How to Configure a Gated Measurement](#).....389

**7.6.2.1 Gated Measurements**

Like a gate provides an opening in a fence, a gated measurement lets data from the input signal pass in defined areas only. The *gate* controls exactly when data is included in the measurement results and when not. The gate is opened by the trigger source, which is also the gate source. Gates can be used in two different modes:

- **Level:** The gate opens and the measurement starts when a defined level in the gate source is exceeded and stops when the gate source drops below the "Gate Level" .  
Using a pulsed gate signal in level mode, the following behavior can be achieved: When the gate source signal is active, the input signal data is collected; when the gate signal is inactive, the input signal is ignored.
- **Edge:** The gate opens and the measurement starts when a defined level in the gate source is exceeded and stops when the defined "Gate Length" is reached.

Additionally, a delay time can be defined so that the first few measurement points after the gate opening are ignored.

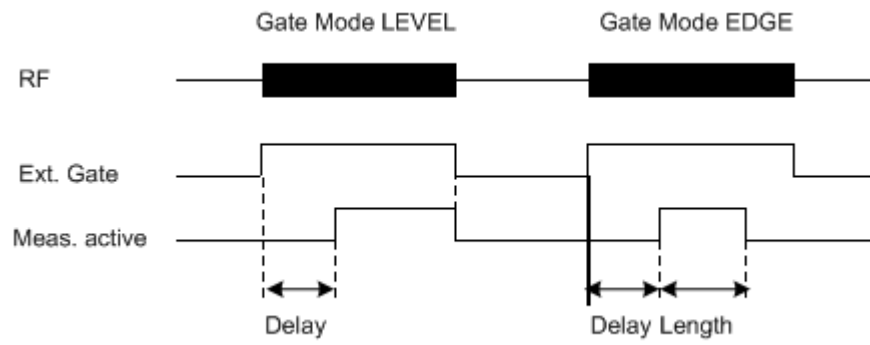

Figure 7-21: Effects of Gate mode, Gate delay and Gate length

**Example:**

By using a gate in sweep mode and stopping the measurement while the gate signal is inactive, the spectrum for pulsed RF carriers can be displayed without the superposition of frequency components generated during switching. Similarly, the spectrum can also be analyzed for an inactive carrier. The sweep can be controlled by an external gate or by the internal power trigger.

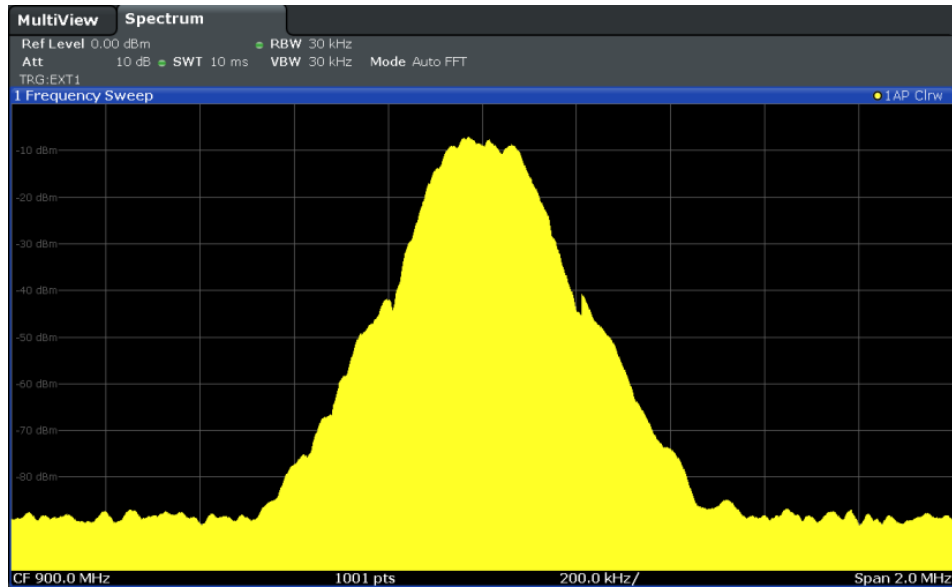

Figure 7-22: GSM signal with GATE OFF

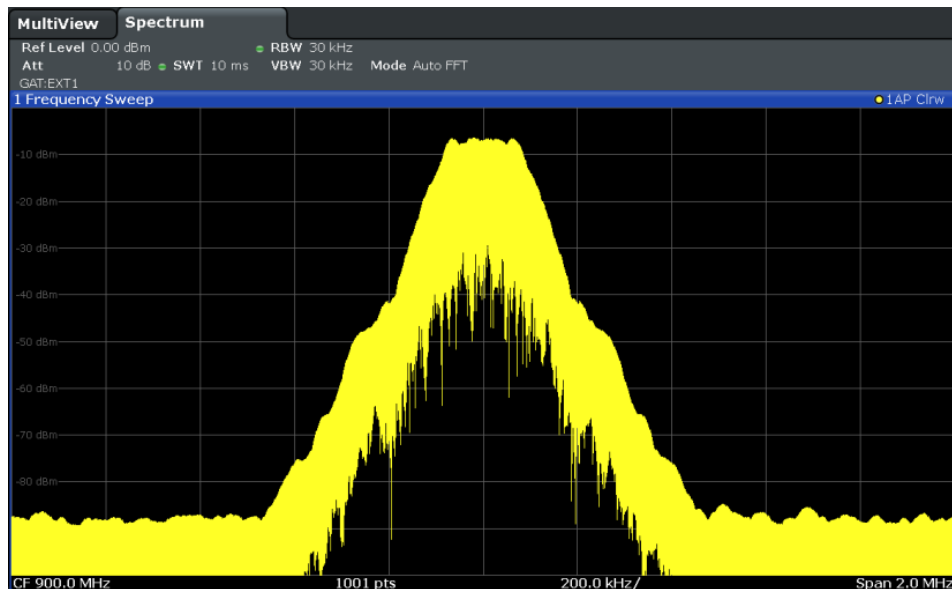

Figure 7-23: GSM signal with GATE ON

Gated sweep operation is also possible for zero span measurements. This allows you to display level variations of individual slots, for instance in burst signals, versus time.

To indicate that a gate is used for the sweep, "GAT" and the gate source is displayed in the channel bar.

### 7.6.2.2 Gate Settings

Gate settings define one or more extracts of the signal to be measured.



Gating is not available for measurements on I/Q-based data.

|                     |     |
|---------------------|-----|
| Gated Trigger ..... | 388 |
| Gate Mode .....     | 388 |
| Gate Delay .....    | 388 |
| Gate Length .....   | 389 |

#### Gated Trigger

Switches gated triggering on or off.

If the gate is switched on, a gate signal applied to one of the TRIGGER INPUT connectors or the internal IF power detector controls the sweep .

#### Gate Mode

Sets the gate mode.

For more information see [Chapter 7.6.2.1, "Gated Measurements"](#), on page 385

"Edge"            The trigger event for the gate to open is the detection of the signal edge.  
After the gate signal has been detected, the gate remains open until the gate length is over.

"Level"           The trigger event for the gate to open is a particular power level.  
After the gate signal has been detected, the gate remains open until the signal disappears.

**Note:** If you perform gated measurements in combination with the IF Power trigger, the R&S FPS ignores the holding time for frequency sweep, FFT sweep, zero span and I/Q mode measurements.

Remote command:

[SENSe:] SWEep:EGATe:TYPE on page 806

#### Gate Delay

Defines the delay time between the gate signal and the continuation of the measurement.

The delay position on the time axis in relation to the sweep is indicated by a line labeled "GD" .

For more information see [Chapter 7.6.2.1, "Gated Measurements"](#), on page 385

Remote command:

[SENSe:] SWEep:EGATe:HOLDoff on page 805

### Gate Length

Defines how long the gate is open when it is triggered. The gate length can only be set in the edge-triggered gate mode. In the level-triggered mode the gate length depends on the level of the gate signal.

The gate length in relation to the sweep is indicated by a line labeled "GL" .

For more information see [Chapter 7.6.2.1, "Gated Measurements"](#), on page 385

Remote command:

`[SENSe:] SWEep:EGATe:LENGth` on page 805

### 7.6.2.3 How to Configure a Gated Measurement

A gated measurement records data only while the gate conditions are fulfilled. These step-by-step instructions demonstrate how to configure a gated measurement manually.

#### To configure a common gated measurement

1. Determine the required parameters as described in [Chapter 7.6.1.3, "How to Determine the Required Trigger/Gate Parameters"](#), on page 384.
2. The gate is opened by a trigger event, which must be based on a power source. Define the trigger as described in [Chapter 7.6.1.4, "How to Configure a Triggered Measurement"](#), on page 384. As the "Trigger Source" , use "IF Power" , "Video" or "External" .
3. Define how long the gate is to remain open:  
To measure the signal as long as the trigger level is exceeded, for example for one or more pulses, define "Gate Mode" = "Level" .  
To measure the signal for a certain time after a level is exceeded, for example during a burst:
  - a) Define "Gate Mode" = "Edge" .
  - b) Define the time to measure for each gate: "Gate Length" .
4. To open the gate with a time delay, for example to ignore an overshoot, define a "Gate Delay" .
5. Select "Gated Trigger" = "On" .

## 7.7 Adjusting Settings Automatically

**Access:** AUTO SET

Some settings can be adjusted by the R&S FPS automatically according to the current measurement settings. In order to do so, a measurement is performed. The duration of this measurement can be defined automatically or manually.

**MSRA operating mode**

In MSRA operating mode, settings related to data acquisition can only be adjusted automatically for the MSRA Master, not the applications.

**Adjusting settings automatically during triggered measurements**

When you select an auto adjust function a measurement is performed to determine the optimal settings. If you select an auto adjust function for a triggered measurement, you are asked how the R&S FPS should behave:

- (default:) The measurement for adjustment waits for the next trigger
- The measurement for adjustment is performed without waiting for a trigger. The trigger source is temporarily set to "Free Run" . After the measurement is completed, the original trigger source is restored. The trigger level is adjusted as follows:
  - For IF Power and RF Power triggers:  
Trigger Level = Reference Level - 15 dB
  - For Video trigger:  
Trigger Level = 85 %

**Remote command:**

[\[SENSe:\]ADJust:CONFigure:TRIGger](#) on page 783

|                                                                                       |     |
|---------------------------------------------------------------------------------------|-----|
| <a href="#">Adjusting all Determinable Settings Automatically ( Auto All )</a> .....  | 390 |
| <a href="#">Adjusting the Center Frequency Automatically ( Auto Frequency )</a> ..... | 390 |
| <a href="#">Setting the Reference Level Automatically ( Auto Level )</a> .....        | 391 |
| <a href="#">Resetting the Automatic Measurement Time ( Meastime Auto )</a> .....      | 391 |
| <a href="#">Changing the Automatic Measurement Time ( Meastime Manual )</a> .....     | 391 |
| <a href="#">Upper Level Hysteresis</a> .....                                          | 391 |
| <a href="#">Lower Level Hysteresis</a> .....                                          | 392 |

**Adjusting all Determinable Settings Automatically ( Auto All )**

Activates all automatic adjustment functions for the current measurement settings.

This includes:

- [Auto Frequency](#)
- [Auto Level](#)

**Note:** MSRA operating modes. In MSRA operating mode, this function is only available for the MSRA Master, not the applications.

Remote command:

[\[SENSe:\]ADJust:ALL](#) on page 781

**Adjusting the Center Frequency Automatically ( Auto Frequency )**

The R&S FPS adjusts the center frequency automatically.

The optimum center frequency is the frequency with the highest S/N ratio in the frequency span. As this function uses the signal counter, it is intended for use with sinusoidal signals.

At the same time, the optimal reference level is also set (see "[Setting the Reference Level Automatically \( Auto Level \)](#)" on page 356).

Remote command:

`[SENSe:]ADJust:FREQuency` on page 783

#### **Setting the Reference Level Automatically ( Auto Level )**

Automatically determines a reference level which ensures that no overload occurs at the R&S FPS for the current input data. At the same time, the internal attenuators are adjusted so the signal-to-noise ratio is optimized, while signal compression and clipping are minimized.

To determine the required reference level, a level measurement is performed on the R&S FPS.

If necessary, you can optimize the reference level further. Decrease the attenuation level manually to the lowest possible value before an overload occurs, then decrease the reference level in the same way.

You can change the measurement time for the level measurement if necessary (see "[Changing the Automatic Measurement Time \( Meastime Manual \)](#)" on page 391).

Remote command:

`[SENSe:]ADJust:LEVel` on page 783

#### **Resetting the Automatic Measurement Time ( Meastime Auto )**

Resets the measurement duration for automatic settings to the default value.

(Spectrum application: 1 ms)

Remote command:

`[SENSe:]ADJust:CONFigure[:LEVel]:DURation:MODE` on page 781

#### **Changing the Automatic Measurement Time ( Meastime Manual )**

This function allows you to change the measurement duration for automatic setting adjustments. Enter the value in seconds.

Remote command:

`[SENSe:]ADJust:CONFigure[:LEVel]:DURation:MODE` on page 781

`[SENSe:]ADJust:CONFigure[:LEVel]:DURation` on page 781

#### **Upper Level Hysteresis**

When the reference level is adjusted automatically using the [Auto Level](#) function, the internal attenuators and the preamplifier are also adjusted. To avoid frequent adaptation due to small changes in the input signal, you can define a hysteresis. This setting defines an upper threshold the signal must exceed (compared to the last measurement) before the reference level is adapted automatically.

Remote command:

`[SENSe:]ADJust:CONFigure:HYSTeresis:UPPer` on page 782

**Lower Level Hysteresis**

When the reference level is adjusted automatically using the [Auto Level](#) function, the internal attenuators and the preamplifier are also adjusted. To avoid frequent adaptation due to small changes in the input signal, you can define a hysteresis. This setting defines a lower threshold the signal must fall below (compared to the last measurement) before the reference level is adapted automatically.

Remote command:

`[SENSe:]ADJust:CONFigure:HYSTeresis:LOWer` on page 782



## 8 Common Analysis and Display Functions

**Access:** "Overview" > "Analysis"

General methods and basic settings to display and analyze measurements, regardless of the operating mode, are described here. If you are performing a specific measurement task, using an operating mode other than Signal and Spectrum Analyzer mode, or an application other than the Spectrum application, be sure to check the specific application or mode description for settings and functions that may deviate from these common settings.

- [Result Display Configuration](#).....393
- [Zoomed Displays](#).....400
- [Marker Usage](#).....404
- [Display and Limit Lines](#).....441
- [Trace Configuration](#).....459
- [Importing and Exporting Measurement Results for Evaluation](#).....488

### 8.1 Result Display Configuration

Measurement results can be evaluated in many different ways, for example graphically, as summary tables, statistical evaluations etc. Thus, the result display is highly configurable to suit your specific requirements and optimize analysis. Here you can find out how to optimize the display for your measurement results.

Basic operations concerning the R&S FPS display, for example how to use the SmartGrid, are described in the R&S FPS Getting Started manual.

General display settings that are usually configured during initial instrument setup, independently of the current measurement, e.g. which items or colors are displayed on the screen, are described in [Chapter 10.2, "Display Settings"](#), on page 535.

- [Basic Evaluation Methods](#).....393
- [Laying out the Result Display with the SmartGrid](#).....395

#### 8.1.1 Basic Evaluation Methods

Measurement results can be displayed and evaluated using various different methods, also at the same time. Depending on the currently selected measurement, in particular when using optional firmware applications, not all evaluation methods are available.

The evaluation methods described here are available for most measurements in the Spectrum application.

- [Diagram](#) .....394
- [Marker Table](#) .....394
- [Marker Peak List](#) .....394
- [Result Summary](#) .....395
- [Spectrogram](#) .....395

### Diagram

Displays a basic level vs. frequency or level vs. time diagram of the measured data to evaluate the results graphically. This is the default evaluation method. Which data is displayed in the diagram depends on the "Trace" settings. Scaling for the y-axis can be configured.

See [Chapter 8.5, "Trace Configuration"](#), on page 459 and [Chapter 7.4.3, "Scaling the Y-Axis"](#), on page 358.

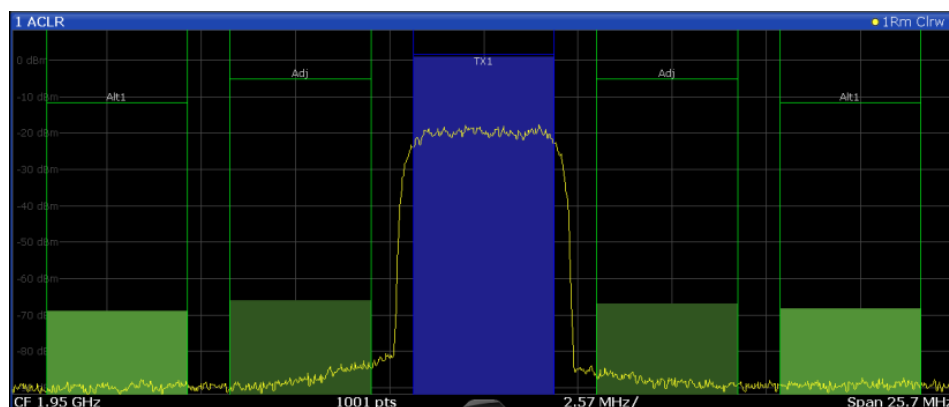

Remote command:

LAY:ADD? '1',RIGH, DIAG, see [LAYout:ADD\[:WINDow\]?](#) on page 767

Results:

[TRACe<n>\[:DATA\]](#) on page 854

### Marker Table

Displays a table with the current marker values for the active markers.

This table is displayed automatically if configured accordingly (see "[Marker Table Display](#)" on page 412).

| 2 Marker |     |     |            |            |          |                 |  |
|----------|-----|-----|------------|------------|----------|-----------------|--|
| Type     | Ref | Trc | Stimulus   | Response   | Function | Function Result |  |
| N1       |     | 1   | 13.197 GHz | -25.87 dBm | Count    | 13.197057       |  |
| D1       | N1  | 1   | -7.942 GHz | -49.41 dB  |          |                 |  |
| D2       | N1  | 2   | -3.918 GHz | -21.90 dB  |          |                 |  |
| D3       | N1  | 3   | 4.024 GHz  | -21.99 dB  |          |                 |  |

Remote command:

LAY:ADD? '1',RIGH, MTAB, see [LAYout:ADD\[:WINDow\]?](#) on page 767

Results:

[CALCulate<n>:MARKer<m>:X](#) on page 867

[CALCulate<n>:MARKer<m>:Y?](#) on page 881

### Marker Peak List

The marker peak list determines the frequencies and levels of peaks in the spectrum or time domain. How many peaks are displayed can be defined, as well as the sort order. In addition, the detected peaks can be indicated in the diagram. The peak list can also be exported to a file for analysis in an external application.

You can define search and sort criteria to influence the results of the analysis.

(See [Chapter 8.3.3.1, "Marker Search Settings"](#), on page 413).

| 2 Marker Peak List |                |             |
|--------------------|----------------|-------------|
| No                 | Stimulus       | Response    |
| 1                  | 64.400000 MHz  | -30.352 dBm |
| 2                  | 128.400000 MHz | -51.896 dBm |
| 3                  | 192.300000 MHz | -40.227 dBm |
| 4                  | 257.200000 MHz | -60.699 dBm |
| 5                  | 320.200000 MHz | -44.273 dBm |
| 6                  | 384.100000 MHz | -53.494 dBm |
| 7                  | 448.100000 MHz | -47.460 dBm |
| 8                  | 513.000000 MHz | -55.603 dBm |

Remote command:

LAY:ADD? '1',RIGH, PEAK, see [LAYout:ADD\[:WINDow\]?](#) on page 767

Results:

[CALCulate<n>:MARKer<m>:X](#) on page 867

[CALCulate<n>:MARKer<m>:Y?](#) on page 881

### Result Summary

Result summaries provide the results of specific measurement functions in a table for numerical evaluation. The contents of the result summary vary depending on the selected measurement function. See the description of the individual measurement functions for details.

| 2 Result Summary |            |             |                  |                  |
|------------------|------------|-------------|------------------|------------------|
| Channel          | Bandwidth  | Offset      | Power            |                  |
| TX1 (Ref)        | 1.229 MHz  |             | <b>-0.86 dBm</b> |                  |
| Tx Total         |            |             | <b>-0.86 dBm</b> |                  |
| Channel          | Bandwidth  | Offset      | Lower            | Upper            |
| Adj              | 30.000 kHz | 750.000 kHz | <b>-79.59 dB</b> | <b>-80.34 dB</b> |
| Alt1             | 30.000 kHz | 1.980 MHz   | <b>-85.04 dB</b> | <b>-83.85 dB</b> |

Remote command:

LAY:ADD? '1',RIGH, RSUM, see [LAYout:ADD\[:WINDow\]?](#) on page 767

### Spectrogram

A spectrogram shows how the spectral density of a signal varies over time. The x-axis shows the frequency or sweep time, the y-axis shows the measurement time. A third dimension, the power level, is indicated by different colors. Thus you can see how the strength of the signal varies over time for different frequencies.

The spectrogram display consists of two diagrams: the standard spectrum result display (upper diagram) and the spectrogram result display (lower diagram).

For details see [Chapter 8.5.2.1, "Working with Spectrograms"](#), on page 471.

Remote command:

LAY:ADD? '1',RIGH, SGR, see [LAYout:ADD\[:WINDow\]?](#) on page 767

## 8.1.2 Laying out the Result Display with the SmartGrid

Measurement results can be evaluated in many different ways, for example graphically, as summary tables, statistical evaluations etc. Each type of evaluation is displayed in a separate window in the channel tab. Up to 16 individual windows can be displayed per channel (i.e. per tab). To arrange the diagrams and tables on the screen, the Rohde & Schwarz SmartGrid function helps you find the target position simply and quickly.

Principally, the layout of the windows on the screen is based on an underlying grid, the SmartGrid. However, the SmartGrid is dynamic and flexible, allowing for many different layout possibilities. The SmartGrid functionality provides the following basic features:

- Windows can be arranged in columns or in rows, or in a combination of both.
  - Windows can be arranged in up to four rows and four columns.
  - Windows are moved simply by dragging them to a new position on the screen, possibly changing the layout of the other windows, as well.
  - All evaluation methods available for the currently selected measurement are displayed as icons in the evaluation bar. If the evaluation bar contains more icons than can be displayed at once on the screen, it can be scrolled vertically. The same evaluation method can be displayed in multiple windows simultaneously.
  - New windows are added by dragging an evaluation icon from the evaluation bar to the screen. The position of each new window depends on where you drop the evaluation icon in relation to the existing windows.
  - All display configuration actions are only possible in SmartGrid mode. When SmartGrid mode is activated, the evaluation bar replaces the current softkey menu display. When the SmartGrid mode is deactivated again, the previous softkey menu display is restored.
- [Background Information: The SmartGrid Principle](#).....396
  - [How to Activate SmartGrid Mode](#).....398
  - [How to Add a New Result Window](#)..... 398
  - [How to Close a Result Window](#).....399
  - [How to Arrange the Result Windows](#)..... 399

### 8.1.2.1 Background Information: The SmartGrid Principle

#### SmartGrid display

During any positioning action, the underlying SmartGrid is displayed. Different colors and frames indicate the possible new positions. The position in the SmartGrid where you drop the window determines its position on the screen.

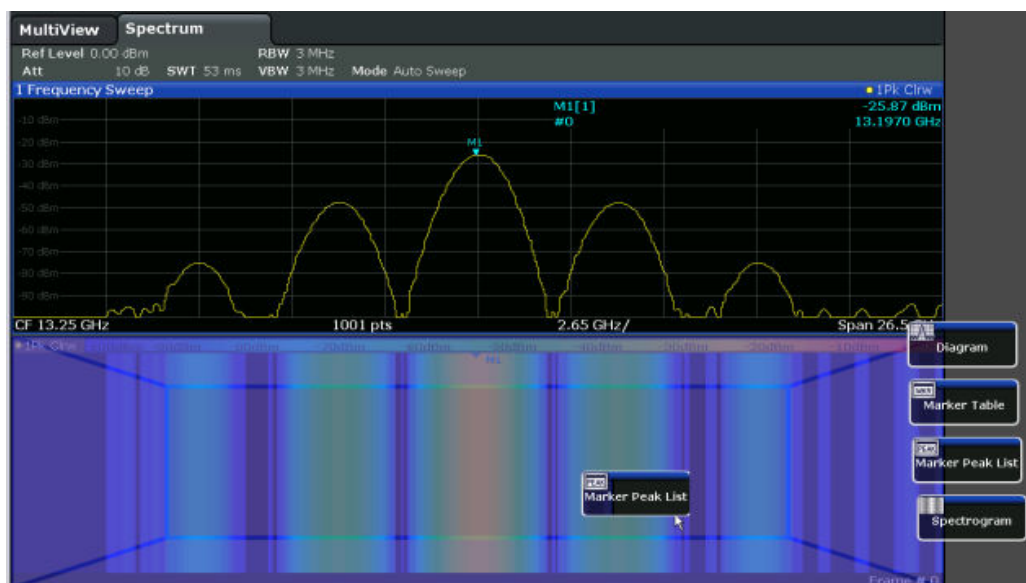

Figure 8-1: Moving a window in SmartGrid mode

The brown area indicates the possible "drop area" for the window, i.e. the area in which the window can be placed. A blue area indicates the (approximate) layout of the window as it would be if the icon were dropped at the current position. The frames indicate the possible destinations of the new window with respect to the existing windows: above/below, right/left or replacement (as illustrated in Figure 4-8). If an existing window would be replaced, the drop area is highlighted in a darker color shade.

**Positioning the window**

The screen can be divided into up to four rows. Each row can be split into up to four columns, where each row can have a different number of columns. However, rows always span the entire width of the screen and may not be interrupted by a column. A single row is available as the drop area for the window in the SmartGrid. The row can be split into columns, or a new row can be inserted above or below the existing row (if the maximum of 4 has not yet been reached).

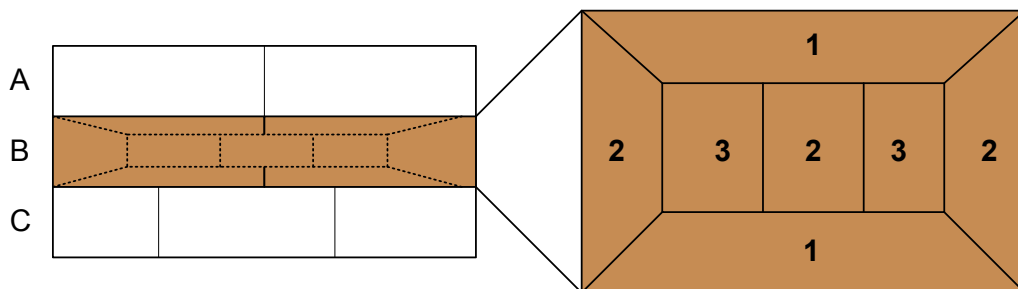

Figure 8-2: SmartGrid window positions

- 1 = Insert row above or below the existing row
- 2 = Create a new column in the existing row
- 3 = Replace a window in the existing row

### SmartGrid functions

Once the evaluation icon has been dropped, icons in each window provide delete and move functions.



The "Move" icon allows you to move the position of the window, possibly changing the size and position of the other displayed windows.



The "Delete" icon allows you to close the window, enlarging the display of the remaining windows.

#### 8.1.2.2 How to Activate SmartGrid Mode

All display configuration actions are only possible in SmartGrid mode. In SmartGrid mode the evaluation bar replaces the current softkey menu display. When the SmartGrid mode is deactivated again, the previous softkey menu display is restored.

► To activate SmartGrid mode, do one of the following:



Select the "SmartGrid" icon from the toolbar.

- Select the "Display Config" button in the configuration "Overview" .
- Select the "Display Config" softkey from the MEAS CONFIG menu.

The SmartGrid functions and the evaluation bar are displayed.



To close the SmartGrid mode and restore the previous softkey menu select the "Close" icon in the right-hand corner of the toolbar, or press any key.

#### 8.1.2.3 How to Add a New Result Window

Each type of evaluation is displayed in a separate window. Up to 16 individual windows can be displayed per channel (i.e. per tab).

1. Activate SmartGrid mode.

All evaluation methods available for the currently selected measurement are displayed as icons in the evaluation bar.

2. Select the icon for the required evaluation method from the evaluation bar.

If the evaluation bar contains more icons than can be displayed at once on the screen, it can be scrolled vertically. Set the mouse pointer in the evaluation bar between the icons and move it up or down until the required icon appears.

3. Drag the required icon from the evaluation bar to the SmartGrid, which is displayed in the diagram area, and drop it at the required position. (See ["How to Arrange the Result Windows"](#) on page 105 for more information on positioning the window).

**Remote command:**

[LAYout:ADD\[:WINDow\]? on page 767](#) / [LAYout:WINDow<n>:ADD? on page 771](#)

**8.1.2.4 How to Close a Result Window**

- ▶ To close a window, activate SmartGrid mode and select the "Delete" icon for the window.

**Remote command:**

[LAYout:REMove\[:WINDow\] on page 769](#) / [LAYout:WINDow<n>:REMove on page 772](#)

**8.1.2.5 How to Arrange the Result Windows**

1. Select an icon from the evaluation bar or the "Move" icon for an existing evaluation window.



2. Drag the evaluation over the SmartGrid.  
A blue area shows where the window will be placed.
3. Move the window until a suitable area is indicated in blue.
4. Drop the window in the target area.  
The windows are rearranged to the selected layout, and "Delete" and "Move" icons are displayed in each window.
5. To close a window, select the corresponding "Delete" icon.

**Remote command:**

[LAYout:REPLace\[:WINDow\] on page 769](#) / [LAYout:WINDow<n>:REPLace on page 772](#)

## 8.2 Zoomed Displays

You can zoom into the diagram to visualize the measurement results in greater detail. Using a mouse pointer you can easily define the area to be enlarged.



### Zoom and the number of sweep points

Note that zooming is merely a visual tool, it does not change any measurement settings, such as the number of sweep points!

You should increase the number of sweep points before zooming, as otherwise the function has no real effect (see [Chapter 7.5.1.8, "How Much Data is Measured: Sweep Points and Sweep Count"](#), on page 365).

- [Single Zoom Versus Multiple Zoom](#)..... 400
- [Zoom Functions](#)..... 401
- [How to Zoom Into a Diagram](#)..... 402

### 8.2.1 Single Zoom Versus Multiple Zoom

Two different (graphical) zoom modes are available: single zoom and multiple zoom. A single zoom replaces the current diagram by a new diagram which displays an enlarged extract of the trace. This function can be used repetitively until the required details are visible. In multiple zoom mode, you can enlarge up to four different areas of the trace simultaneously. An overview window indicates the zoom areas in the original trace, while the zoomed trace areas are displayed in individual windows. The zoom areas can be moved and resized any time. The zoom area that corresponds to the individual zoom display is indicated in the lower right corner, between the scrollbars.

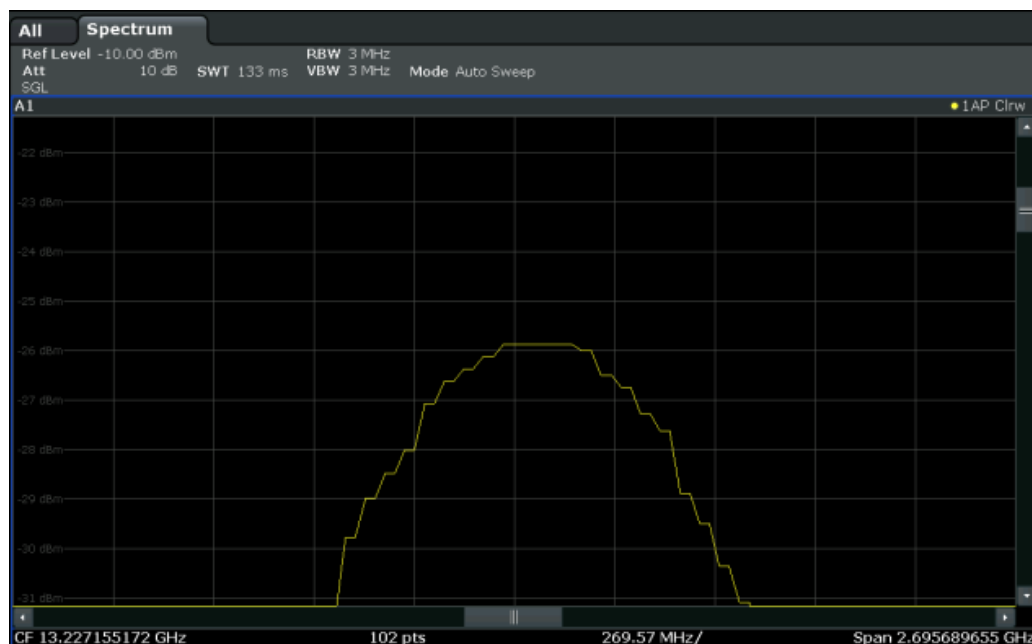

Figure 8-3: Single zoom



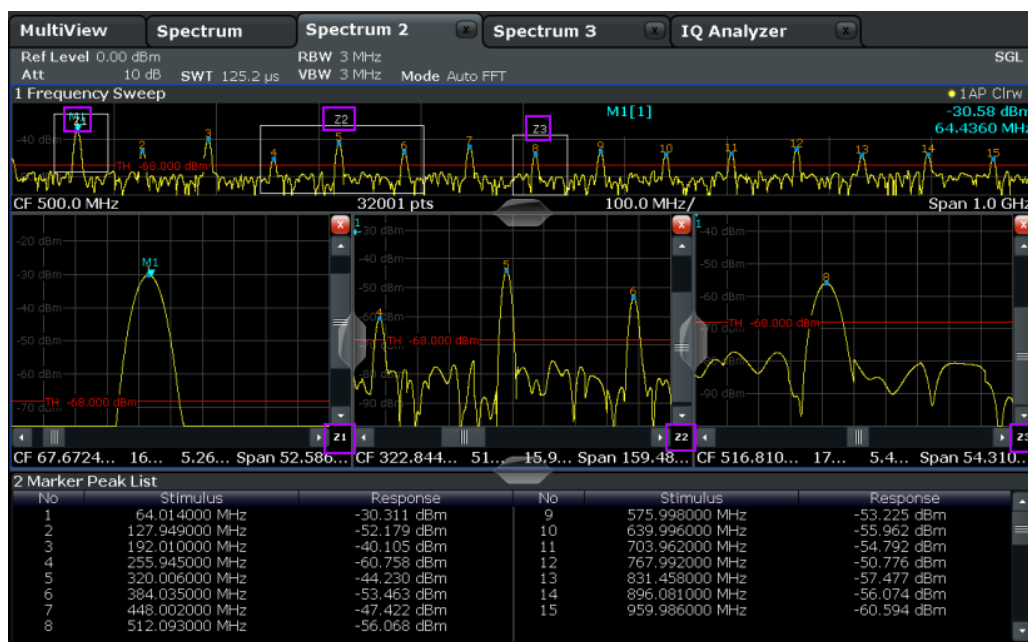

Figure 8-4: Multiple zoom



**Using the zoom area to restrict a peak search**

The selected zoom area can be used to restrict the search range for a peak search, but only in single zoom mode (see "Use Zoom Limits" on page 415).

**8.2.2 Zoom Functions**

**Access:** "Zoom" icons in toolbar

Single Zoom ..... 401

Multi-Zoom ..... 402

Restore Original Display ..... 402

Deactivating Zoom (Selection Mode) ..... 402

**Single Zoom**



A single zoom replaces the current diagram by a new diagram which displays an enlarged extract of the trace. This function can be used repetitively until the required details are visible.

Remote command:

- DISPlay[:WINDow<n>]:ZOOM[:STATe] on page 836
- DISPlay[:WINDow<n>]:ZOOM:AREA on page 835

### Multi-Zoom



In multiple zoom mode, you can enlarge several different areas of the trace simultaneously. An overview window indicates the zoom areas in the original trace, while the zoomed trace areas are displayed in individual windows. The zoom area that corresponds to the individual zoom display is indicated in the lower right corner, between the scrollbars.

Remote command:

`DISPlay[:WINDow<n>]:ZOOM:MULTiple<zoom>[:STATe]` on page 837

`DISPlay[:WINDow<n>]:ZOOM:MULTiple<zoom>:AREA` on page 836

### Restore Original Display



Restores the original display, that is, the originally calculated displays for the entire capture buffer, and closes all zoom windows.

Remote command:

Single zoom:

`DISPlay[:WINDow<n>]:ZOOM[:STATe]` on page 836

Multiple zoom:

`DISPlay[:WINDow<n>]:ZOOM:MULTiple<zoom>[:STATe]` on page 837 (for each multiple zoom window)

### Deactivating Zoom (Selection Mode)

Deactivates any zoom mode.

Selecting a point in the display no longer invokes a zoom, but selects an object.

Remote command:

Single zoom:

`DISPlay[:WINDow<n>]:ZOOM[:STATe]` on page 836

Multiple zoom:

`DISPlay[:WINDow<n>]:ZOOM:MULTiple<zoom>[:STATe]` on page 837 (for each multiple zoom window)

## 8.2.3 How to Zoom Into a Diagram

The remote commands required to zoom into a display are described in [Chapter 12.8.1, "Zooming into the Display"](#), on page 835.

The following tasks are described here:

- ["To zoom into the diagram at one position"](#) on page 403
- ["To return to selection mode in the diagram"](#) on page 403
- ["To return to original display"](#) on page 403
- ["To zoom into multiple positions in the diagram"](#) on page 404

### To zoom into the diagram at one position

1. 

Click on the "Single Zoom" icon in the toolbar.

Zoom mode is activated.

2. Select the area in the diagram to be enlarged using the mouse pointer. The selected area is indicated by a dotted rectangle.

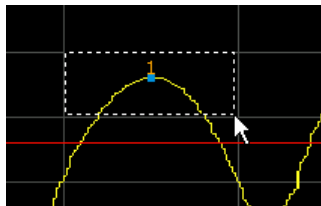

When you drop the mouse pointer, the diagram is replaced by the zoomed trace area.

3. Repeat these steps, if necessary, to enlarge the diagram further.



### Scrolling in the zoomed display

You can scroll the diagram area to display the entire diagram using the scrollbars at the right and at the bottom of the diagram.

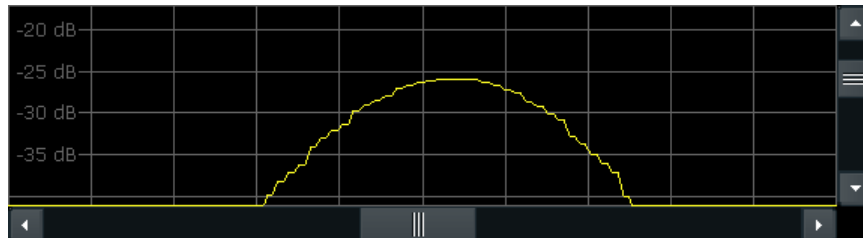

### To return to selection mode in the diagram

While you are in zoom mode, selecting points in the display changes the zoom area. In order to select or move a trace or marker, you must switch back to selection mode:



Select the "Selection Mode" icon in the toolbar.

### To return to original display



Click on the "Zoom Off" icon in the toolbar.

The original trace display is restored. Zoom mode remains active, however.

To switch off zoom mode and return to selection mode, select the "Selection Mode" icon in the toolbar.

### To zoom into multiple positions in the diagram

1. 

Click on the "Multi-Zoom" icon in the toolbar.

Multiple zoom mode is activated.

2. Select the first area in the diagram to be enlarged as described in ["To zoom into the diagram at one position"](#) on page 403. The selected area is indicated by a dotted rectangle.

When you have completed your selection, the original trace is shown in an overview diagram with the selected area indicated by a dotted rectangle. The zoomed trace area is displayed in a separate window (see [Figure 8-4](#)).

3. In the overview diagram, select the next area to be enlarged.  
The second zoom area is indicated in the overview diagram, and a second zoom window is displayed.
4. Repeat these steps, if necessary, to zoom into further trace areas (up to four).

### To move or change zoom areas

In multiple zoom mode, you can change the size or position of the individual zoom areas easily at any time.

1. If necessary, switch off zoom mode and return to selection mode by selecting the "Selection Mode" icon in the toolbar.
2. To resize a zoom area, set the mouse pointer directly **on** the corresponding frame in the overview window and drag the line to change the size of the frame.  
To move a zoom area, set the mouse pointer **inside** the corresponding frame in the overview window and drag the frame to the new position.  
The contents of the zoom windows are adapted accordingly.

## 8.3 Marker Usage

Markers help you analyze your measurement results by determining particular values in the diagram. Thus you can extract numeric values from a graphical display both in the time and frequency domain. In addition to basic markers, sophisticated marker functions are provided for special results such as noise or demodulation.



### Markers in Spectrogram Displays

In the spectrogram result display, you can activate up to 16 markers or delta markers at the same time. Each marker can be assigned to a different frame. Therefore, in addition to the frequency you also define the frame number when activating a new marker. If no frame number is specified, the marker is positioned on the currently selected frame. All markers are visible that are positioned on a visible frame.

- [Basics on Markers](#).....405
- [Marker Settings](#).....408
- [Marker Search Settings and Positioning Functions](#)..... 413
- [Marker \(Measurement\) Functions](#).....420
- [How to Work With Markers](#).....438
- [Measurement Example: Measuring Harmonics Using Marker Functions](#)..... 439

### 8.3.1 Basics on Markers

Some background knowledge on marker settings and functions is provided here for a better understanding of the required configuration settings.

Markers are used to mark points on traces, to read out measurement results and to select a display section quickly. R&S FPS provides 16 markers per display window. In the Spectrum application, the same markers are displayed in all windows.

- The easiest way to work with markers is using a mouse. Simply drag the marker and drop it at the required position. When a marker label is selected, a vertical line is displayed which indicates the marker's current x-value.

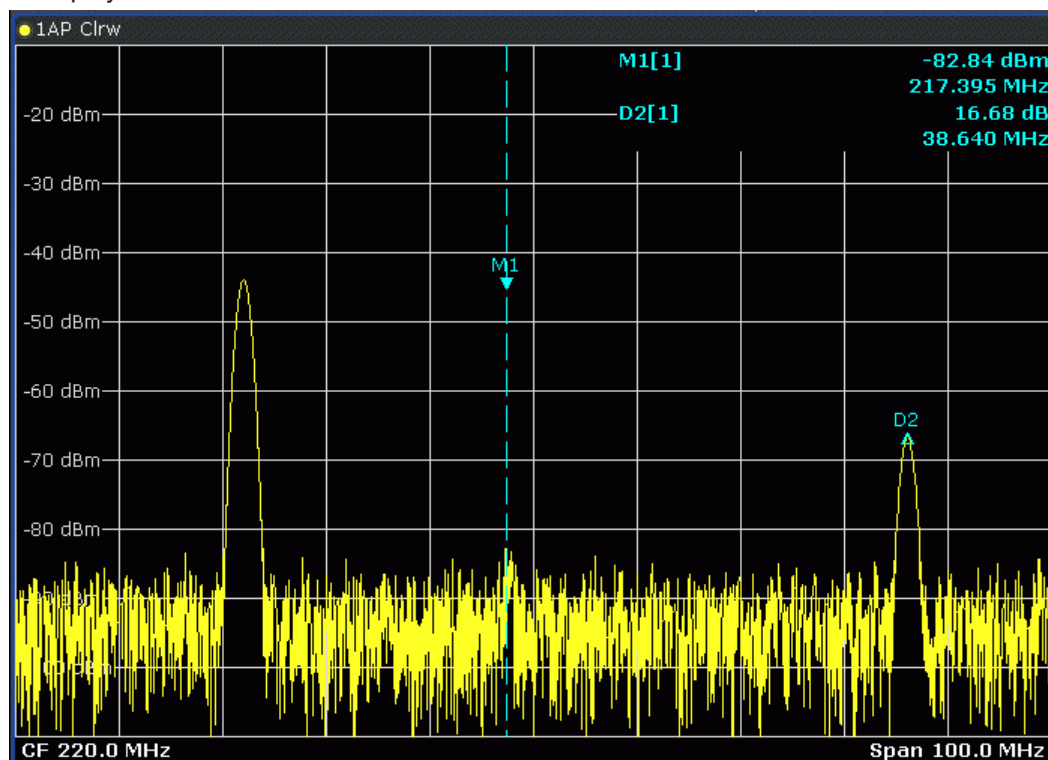

- You can also set an active marker to a new position by defining its x-position numerically. When you select the softkey for a marker, an edit dialog box is displayed.
- The most commonly required marker settings and functions are also available as softkeys.  
Softkeys for active markers (displayed on the screen) are highlighted blue. The softkey for the currently selected marker (for which functions are performed) is highlighted orange.
- To set individual markers very quickly, use the softkeys in the "Marker" menu.
- To set up several markers at once, use the "Marker" dialog box.
- To position the selected marker to a special value, use the softkeys in the "Marker To" menu.
- To determine more sophisticated marker results, use the special functions in the "Marker Function" dialog box.

In addition to basic markers, sophisticated marker functions are provided for special results such as noise or demodulation.

- [Marker Types](#)..... 406
- [Activating Markers](#).....406
- [Marker Results](#).....407

### 8.3.1.1 Marker Types

All markers can be used either as normal markers or delta markers. A normal marker indicates the absolute signal value at the defined position in the diagram. A delta marker indicates the value of the marker relative to the specified reference marker (by default marker 1).

In addition, special functions can be assigned to the individual markers. The availability of special marker functions depends on whether the measurement is performed in the frequency or time domain, and on the type of measurement.

Temporary markers are used in addition to the markers and delta markers to analyze the measurement results for special marker functions. They disappear when the associated function is deactivated.

### 8.3.1.2 Activating Markers

Only active markers are displayed in the diagram and in the marker table.

Active markers are indicated by a highlighted softkey.

By default, marker 1 is active and positioned on the maximum value (peak) of trace 1 as a normal marker. If several traces are displayed, the marker is set to the maximum value of the trace which has the lowest number and is not frozen (View mode). The next marker to be activated is set to the frequency of the next lower level (next peak) as a delta marker; its value is indicated as an offset to marker 1.

A marker can only be activated when at least one trace in the corresponding window is visible. If a trace is switched off, the corresponding markers and marker functions are

also deactivated. If the trace is switched on again, the markers along with coupled functions are restored to their original positions, provided the markers have not been used on another trace.

### 8.3.1.3 Marker Results

Normal markers point to a sweep point on the time or frequency axis and display the associated numeric value for that sweep point. Delta markers indicate an offset between the level at the delta marker position and the level at the position of the assigned reference marker, in dB.

Signal count markers determine the frequency of a signal at the marker position very accurately.

The results can be displayed directly within the diagram area or in a separate table. By default, the first two active markers are displayed in the diagram area. If more markers are activated, the results are displayed in a marker table.

#### Marker information in diagram area

By default, the results of the last two markers or delta markers that were activated are displayed in the diagram area.

|       |             |
|-------|-------------|
| D2[1] | -21.90 dB   |
|       | -3.9180 GHz |
| M1[1] | -25.87 dBm  |
|       | 13.1970 GHz |

The following information is displayed there:

- The marker type (M for normal, D for delta, or special function name)
- The marker number (1 to 16)
- The assigned trace number in square brackets [ ]
- The marker value on the y-axis, or the result of the marker function
- The marker position on the x-axis

For n dB down markers, additional information is displayed, see [Table 8-1](#).

#### Marker information in marker table

In addition to the marker information displayed within the diagram area, a separate marker table may be displayed beneath the diagram. This table provides the following information for all active markers:

|                |                                                                                                  |
|----------------|--------------------------------------------------------------------------------------------------|
| <b>Type</b>    | Marker type: N (normal), D (delta), T (temporary, internal) and number                           |
| <b>Ref</b>     | Reference marker for delta markers                                                               |
| <b>Trc</b>     | Trace to which the marker is assigned                                                            |
| <b>Frame</b>   | Spectrogram frame the marker is positioned in. Displayed only when the Spectrogram is displayed. |
| <b>X-value</b> | X-value of the marker                                                                            |

|                 |                                                     |
|-----------------|-----------------------------------------------------|
| Y-value         | Y-value of the marker                               |
| Function        | Activated marker or measurement function            |
| Function Result | Result of the active marker or measurement function |

### 8.3.2 Marker Settings

Or: MKR > "Marker Config"

The remote commands required to define these settings are described in [Chapter 12.8.3.1, "Setting Up Individual Markers"](#), on page 862.

- [Individual Marker Setup](#)..... 408
- [General Marker Settings](#)..... 411

#### 8.3.2.1 Individual Marker Setup

Up to 17 markers or delta markers can be activated for each window simultaneously. Initial marker setup is performed using the "Marker" dialog box.

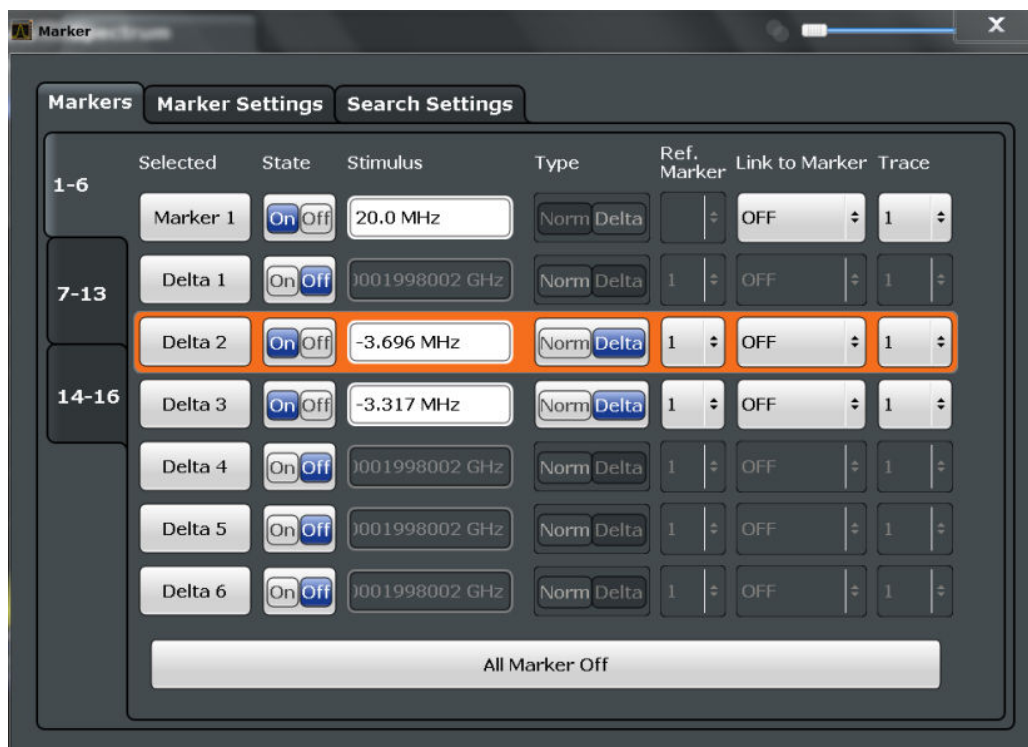

The markers are distributed among 3 tabs for a better overview. By default, the first marker is defined as a normal marker, whereas all others are defined as delta markers with reference to the first marker. All markers are assigned to trace 1, but only the first marker is active.



|                                       |     |
|---------------------------------------|-----|
| Selected Marker .....                 | 409 |
| Marker State .....                    | 409 |
| Marker Position X-value .....         | 409 |
| Frame (Spectrogram only).....         | 409 |
| Marker Type .....                     | 409 |
| Reference Marker .....                | 410 |
| Linking to Another Marker .....       | 410 |
| Assigning the Marker to a Trace ..... | 410 |
| Select Marker .....                   | 410 |
| All Marker Off .....                  | 411 |

### Selected Marker

Marker name. The marker which is currently selected for editing is highlighted orange.

Remote command:

Marker selected via suffix <m> in remote commands.

### Marker State

Activates or deactivates the marker in the diagram.

Remote command:

`CALCulate<n>:MARKer<m>[:STATe]` on page 867

`CALCulate<n>:DELTamarker<m>[:STATe]` on page 865

### Marker Position X-value

Defines the position (x-value) of the marker in the diagram. For normal markers, the absolute position is indicated. For delta markers, the position relative to the reference marker is provided.

Remote command:

`CALCulate<n>:MARKer<m>:X` on page 867

`CALCulate<n>:DELTamarker<m>:X` on page 865

### Frame (Spectrogram only)

Spectrogram frame the marker is assigned to.

Remote command:

`CALCulate<n>:MARKer<m>:SPECTrogram:FRAMe` on page 883

`CALCulate<n>:DELTamarker<m>:SPECTrogram:FRAMe` on page 888

### Marker Type

Toggles the marker type.

The type for marker 1 is always "Normal" , the type for delta marker 1 is always "Delta" . These types cannot be changed.

**Note:** If normal marker 1 is the active marker, switching the "Mkr Type" activates an additional delta marker 1. For any other marker, switching the marker type does not activate an additional marker, it only switches the type of the selected marker.

"Normal"            A normal marker indicates the absolute value at the defined position in the diagram.

"Delta"             A delta marker defines the value of the marker relative to the specified reference marker (marker 1 by default).

Remote command:

`CALCulate<n>:MARKer<m>[:STATe]` on page 867

`CALCulate<n>:DELTamarker<m>[:STATe]` on page 865

### Reference Marker

Defines a marker as the reference marker which is used to determine relative analysis results (delta marker values).

If the reference marker is deactivated, the delta marker referring to it is also deactivated.

If a fixed reference point is configured (see "Defining a Fixed Reference" on page 412), the reference point ( "FXD" ) can also be selected instead of another marker.

Remote command:

`CALCulate<n>:DELTamarker<m>:MREF` on page 864

### Linking to Another Marker

Links the current marker to the marker selected from the list of active markers. If the x-axis value of the initial marker is changed, the linked marker follows to the same position on the x-axis. Linking is off by default.

Using this function you can set two markers on different traces to measure the difference (e.g. between a max hold trace and a min hold trace or between a measurement and a reference trace).

Remote command:

`CALCulate<n>:MARKer<m>:LINK:TO:MARKer<m>` on page 866

`CALCulate<n>:DELTamarker<m>:LINK:TO:MARKer<m>` on page 863

`CALCulate<n>:DELTamarker<m>:LINK` on page 863

### Assigning the Marker to a Trace

The "Trace" setting assigns the selected marker to an active trace. The trace determines which value the marker shows at the marker position. If the marker was previously assigned to a different trace, the marker remains on the previous frequency or time, but indicates the value of the new trace.

If a trace is turned off, the assigned markers and marker functions are also deactivated.

Remote command:

`CALCulate<n>:MARKer<m>:TRACe` on page 867

### Select Marker

The "Select Marker" function opens a dialog box to select and activate or deactivate one or more markers quickly.



Remote command:

[CALCulate<n>:MARKer<m>\[:STATe\]](#) on page 867

[CALCulate<n>:DELTAmarker<m>\[:STATe\]](#) on page 865

**All Marker Off**

Deactivates all markers in one step.

Remote command:

[CALCulate<n>:MARKer<m>:AOFF](#) on page 866

**8.3.2.2 General Marker Settings**

Some general marker settings allow you to influence the marker behavior for all markers.

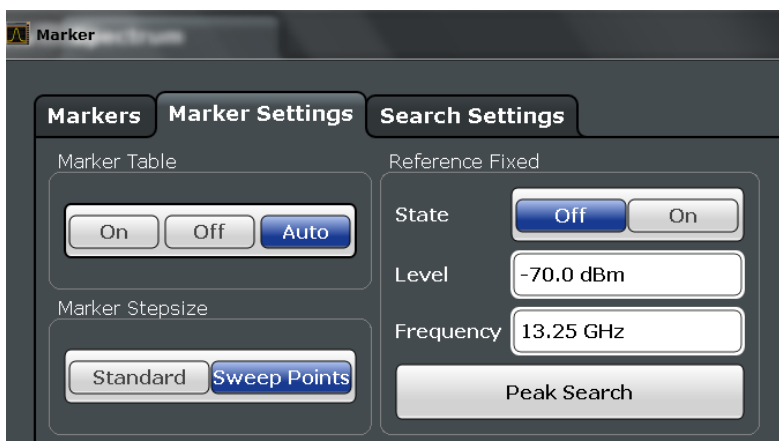

|                                 |     |
|---------------------------------|-----|
| Marker Table Display .....      | 412 |
| Marker Info .....               | 412 |
| Marker Stepsize .....           | 412 |
| Defining a Fixed Reference..... | 412 |

### Marker Table Display

Defines how the marker information is displayed.

|        |                                                                                                                                                                                                                         |
|--------|-------------------------------------------------------------------------------------------------------------------------------------------------------------------------------------------------------------------------|
| "On"   | Displays the marker information in a table in a separate area beneath the diagram.                                                                                                                                      |
| "Off"  | No separate marker table is displayed.<br>If <a href="#">Marker Info</a> is active, the marker information is displayed within the diagram area.                                                                        |
| "Auto" | (Default) If more than two markers are active, the marker table is displayed automatically.<br>If <a href="#">Marker Info</a> is active, the marker information for up to two markers is displayed in the diagram area. |

Remote command:

`DISPlay[:WINDow<n>]:MTABLE` on page 868

### Marker Info

Turns the marker information displayed in the diagram on and off.

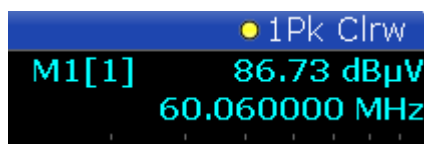

Remote command:

`DISPlay:MINFo[:STATe]` on page 868

### Marker Stepsize

Defines the size of the steps that the marker position is moved using the rotary knob.

|                |                                                                                                                                                                                                                                                  |
|----------------|--------------------------------------------------------------------------------------------------------------------------------------------------------------------------------------------------------------------------------------------------|
| "Standard"     | The marker position is moved in steps of (Span/1000), which corresponds approximately to the number of pixels for the default display of 1001 sweep points. This setting is most suitable to move the marker over a larger distance.             |
| "Sweep Points" | The marker position is moved from one sweep point to the next. This setting is required for a very precise positioning if more sweep points are collected than the number of pixels that can be displayed on the screen. It is the default mode. |

Remote command:

`CALCulate<n>:MARKer<m>:X:SSIZE` on page 869

### Defining a Fixed Reference

Instead of using a reference marker that may vary its position depending on the measurement results, a fixed reference marker can be defined for trace analysis.

Note that this function may not be available in all result displays.

For "State" = "On" , a vertical and a horizontal red display line are displayed, marked as "FXD" . The normal marker 1 is activated and set to the peak value of the trace assigned to marker 1, and a delta marker to the next peak. The fixed reference marker is set to the position of marker 1 at the peak value. The delta marker refers to the fixed reference marker.

The "Level" and "Frequency" or "Time" settings define the position and value of the reference marker. To move the fixed reference, move the red display lines marked "FXD" in the diagram, or change the position settings in the "Marker Settings" tab of the "Marker" dialog box.

**Peak Search** sets the fixed reference marker to the current maximum value of the trace assigned to marker 1.

If activated, the fixed reference marker ( "FXD" ) can also be selected as a [Reference Marker](#) instead of another marker.

Remote command:

`CALCulate<n>:DELTAmarker<m>:FUNCTION:FIXed[:STATe]` on page 893

`CALCulate<n>:DELTAmarker<m>:FUNCTION:FIXed:RPOint:Y` on page 893

`CALCulate<n>:DELTAmarker<m>:FUNCTION:FIXed:RPOint:X` on page 892

`CALCulate<n>:DELTAmarker<m>:FUNCTION:FIXed:RPOint:MAXimum[:PEAK]` on page 892

### 8.3.3 Marker Search Settings and Positioning Functions

**Access:** "Overview" > "Analysis" > "Marker" > "Search"

or: MKR TO

Several functions are available to set the marker to a specific position very quickly and easily, or to use the current marker position to define another characteristic value. In order to determine the required marker position, searches may be performed. The search results can be influenced by special settings.

For more information on searching for signal peaks see [Chapter 8.3.4.7, "Marker Peak List"](#), on page 434.

The remote commands required to define these settings are described in [Chapter 12.8.3.4, "Positioning the Marker"](#), on page 873.

- [Marker Search Settings](#).....413
- [Marker Search Settings for Spectrograms](#).....416
- [Positioning Functions](#).....419

#### 8.3.3.1 Marker Search Settings

**Access:** MKR TO > "Search Config"

Markers are commonly used to determine peak values, i.e. maximum or minimum values, in the measured signal. Configuration settings allow you to influence the peak search results.



For Spectrograms, special marker settings are available, see [Chapter 8.3.3.2, "Marker Search Settings for Spectrograms"](#), on page 416.

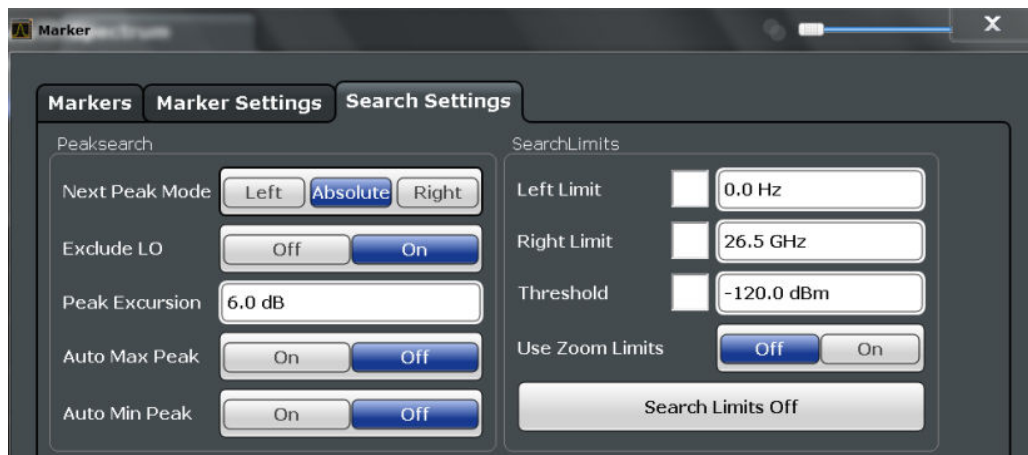

[Search Mode for Next Peak](#) ..... 414

[Exclude LO](#) ..... 414

[Peak Excursion](#) ..... 415

[Auto Max Peak Search / Auto Min Peak Search](#) ..... 415

[Search Limits](#) ..... 415

    L [Search Limits \( Left / Right \)](#) ..... 415

    L [Search Threshold](#) ..... 415

    L [Use Zoom Limits](#) ..... 415

    L [Deactivating All Search Limits](#) ..... 416

**Search Mode for Next Peak**

Selects the search mode for the next peak search.

- "Left"                 Determines the next maximum/minimum to the left of the current peak.
- "Absolute"            Determines the next maximum/minimum to either side of the current peak.
- "Right"                Determines the next maximum/minimum to the right of the current peak.

Remote command:

[Chapter 12.8.3.4, "Positioning the Marker"](#), on page 873

**Exclude LO**

If activated, restricts the frequency range for the marker search functions.

- "On"                    The minimum frequency included in the peak search range is  $\geq 5 \times$  resolution bandwidth (RBW).  
Due to the interference by the first local oscillator to the first intermediate frequency at the input mixer, the LO is represented as a signal at 0 Hz. To avoid the peak marker jumping to the LO signal at 0 Hz, this frequency is excluded from the peak search.

"Off" No restriction to the search range. The frequency 0 Hz is included in the marker search functions.

Remote command:

[CALCulate<n>:MARKer<m>:LOEXclude](#) on page 870

### Peak Excursion

Defines the minimum level value by which a signal must rise or fall so that it is identified as a maximum or a minimum by the search functions.

Entries from 0 dB to 80 dB are allowed; the resolution is 0.1 dB. The default setting for the peak excursion is 6 dB.

For more information see [Chapter 8.3.4.7, "Marker Peak List"](#), on page 434.

Remote command:

[CALCulate<n>:MARKer<m>:PEXCursion](#) on page 870

### Auto Max Peak Search / Auto Min Peak Search

If activated, a maximum or minimum peak search is performed automatically for marker 1 after each sweep .

For spectrogram displays, define which frame the peak is to be searched in.

Remote command:

[CALCulate<n>:MARKer<m>:MAXimum:AUTO](#) on page 873

[CALCulate<n>:MARKer<m>:MINimum:AUTO](#) on page 875

### Search Limits

The search results can be restricted by limiting the search area or adding search conditions.

#### Search Limits ( Left / Right ) ← Search Limits

If activated, limit lines are defined and displayed for the search. Only results within the limited search range are considered.

For details on limit lines for searches, see ["Peak search limits"](#) on page 434.

Remote command:

[CALCulate<n>:MARKer<m>:X:SLIMits\[:STATe\]](#) on page 870

[CALCulate<n>:MARKer<m>:X:SLIMits:LEFT](#) on page 871

[CALCulate<n>:MARKer<m>:X:SLIMits:RIGHT](#) on page 871

#### Search Threshold ← Search Limits

Defines an absolute threshold as an additional condition for the peak search. Only peaks that exceed the threshold are detected.

Remote command:

[CALCulate<n>:THReshold](#) on page 872

#### Use Zoom Limits ← Search Limits

If activated, the peak search is restricted to the active zoom area defined for a single zoom.

Remote command:

[CALCulate<n>:MARKer<m>:X:SLIMits:ZOOM\[:STATe\]](#) on page 872

**Deactivating All Search Limits ← Search Limits**

Deactivates the search range limits.

Remote command:

CALCulate<n>:MARKer<m>:X:SLIMits[:STATe] on page 870

CALCulate<n>:THReshold:STATe on page 873

**8.3.3.2 Marker Search Settings for Spectrograms**

**Access:** "Overview" > "Analysis" > "Markers" > "Search"

**or:** MKR TO > "Search Config"

Spectrograms show not only the current sweep results, but also the sweep history. Thus, when searching for peaks, you must define the search settings within a single time frame (x-direction) and within several time frames (y-direction).

These settings are only available for spectrogram displays.

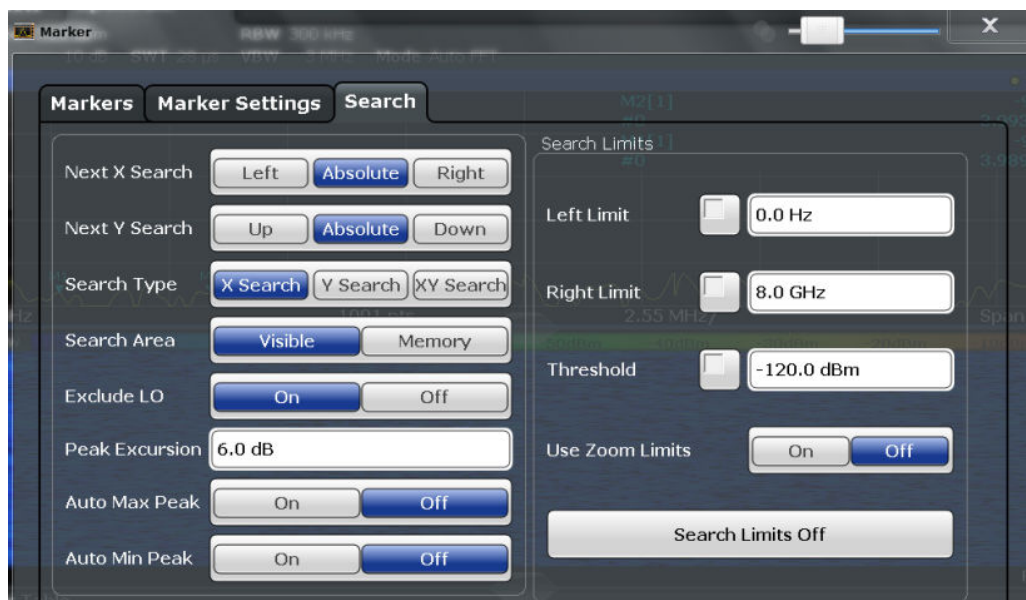

Search Mode for Next Peak in X-Direction ..... 416

Search Mode for Next Peak in Y-Direction ..... 417

Marker Search Type ..... 417

Marker Search Area ..... 418

Exclude LO ..... 418

Peak Excursion ..... 418

Auto Max Peak Search / Auto Min Peak Search ..... 418

Search Limits ..... 418

    L Search Limits ( Left / Right ) ..... 418

    L Search Threshold ..... 419

    L Use Zoom Limits ..... 419

    L Deactivating All Search Limits ..... 419

**Search Mode for Next Peak in X-Direction**

Selects the search mode for the next peak search within the currently selected frame.



|            |                                                                         |
|------------|-------------------------------------------------------------------------|
| "Left"     | Determines the next maximum/minimum to the left of the current peak.    |
| "Absolute" | Determines the next maximum/minimum to either side of the current peak. |
| "Right"    | Determines the next maximum/minimum to the right of the current peak.   |

Remote command:

[Chapter 12.8.3.4, "Positioning the Marker"](#), on page 873

### Search Mode for Next Peak in Y-Direction

Selects the search mode for the next peak search within all frames at the current marker position.

|            |                                                                                      |
|------------|--------------------------------------------------------------------------------------|
| "Up"       | Determines the next maximum/minimum above the current peak (in more recent frames).  |
| "Absolute" | Determines the next maximum/minimum above or below the current peak (in all frames). |
| "Down"     | Determines the next maximum/minimum below the current peak (in older frames).        |

Remote command:

[CALCulate<n>:MARKer<m>:SPECTrogram:Y:MAXimum:ABOVE](#) on page 884

[CALCulate<n>:DELTaMarker<m>:SPECTrogram:Y:MAXimum:ABOVE](#)  
on page 889

[CALCulate<n>:MARKer<m>:SPECTrogram:Y:MAXimum:BELOW](#) on page 885

[CALCulate<n>:DELTaMarker<m>:SPECTrogram:Y:MAXimum:BELOW](#)  
on page 890

[CALCulate<n>:MARKer<m>:SPECTrogram:Y:MAXimum:NEXT](#) on page 885

[CALCulate<n>:DELTaMarker<m>:SPECTrogram:Y:MAXimum:NEXT](#) on page 890

[CALCulate<n>:MARKer<m>:SPECTrogram:Y:MINimum:ABOVE](#) on page 886

[CALCulate<n>:DELTaMarker<m>:SPECTrogram:Y:MINimum:ABOVE](#)  
on page 891

[CALCulate<n>:MARKer<m>:SPECTrogram:Y:MINimum:BELOW](#) on page 886

[CALCulate<n>:DELTaMarker<m>:SPECTrogram:Y:MINimum:BELOW](#)  
on page 891

[CALCulate<n>:MARKer<m>:SPECTrogram:Y:MINimum:NEXT](#) on page 886

[CALCulate<n>:DELTaMarker<m>:SPECTrogram:Y:MINimum:NEXT](#) on page 891

### Marker Search Type

Defines the type of search to be performed in the spectrogram.

|             |                                                                        |
|-------------|------------------------------------------------------------------------|
| "X-Search"  | Searches only within the currently selected frame.                     |
| "Y-Search"  | Searches within all frames but only at the current frequency position. |
| "XY-Search" | Searches in all frames at all positions.                               |

Remote command:

Defined by the search function, see [Chapter 12.8.3.6, "Marker Search \(Spectrograms\)"](#), on page 882

**Marker Search Area**

Defines which frames the search is performed in.

"Visible" Only the visible frames are searched.

"Memory" All frames stored in the memory are searched.

Remote command:

[CALCulate<n>:MARKer<m>:SPECTrogram:SARea](#) on page 883

[CALCulate<n>:DELTaMarker<m>:SPECTrogram:SARea](#) on page 888

**Exclude LO**

If activated, restricts the frequency range for the marker search functions.

"On" The minimum frequency included in the peak search range is  $\geq 5 \times$  resolution bandwidth (RBW).  
Due to the interference by the first local oscillator to the first intermediate frequency at the input mixer, the LO is represented as a signal at 0 Hz. To avoid the peak marker jumping to the LO signal at 0 Hz, this frequency is excluded from the peak search.

"Off" No restriction to the search range. The frequency 0 Hz is included in the marker search functions.

Remote command:

[CALCulate<n>:MARKer<m>:LOEXclude](#) on page 870

**Peak Excursion**

Defines the minimum level value by which a signal must rise or fall so that it is identified as a maximum or a minimum by the search functions.

Entries from 0 dB to 80 dB are allowed; the resolution is 0.1 dB. The default setting for the peak excursion is 6 dB.

For more information see [Chapter 8.3.4.7, "Marker Peak List"](#), on page 434.

Remote command:

[CALCulate<n>:MARKer<m>:PEXCursion](#) on page 870

**Auto Max Peak Search / Auto Min Peak Search**

If activated, a maximum or minimum peak search is performed automatically for marker 1 after each sweep .

For spectrogram displays, define which frame the peak is to be searched in.

Remote command:

[CALCulate<n>:MARKer<m>:MAXimum:AUTO](#) on page 873

[CALCulate<n>:MARKer<m>:MINimum:AUTO](#) on page 875

**Search Limits**

The search results can be restricted by limiting the search area or adding search conditions.

**Search Limits ( Left / Right ) ← Search Limits**

If activated, limit lines are defined and displayed for the search. Only results within the limited search range are considered.

For details on limit lines for searches, see ["Peak search limits"](#) on page 434.

Remote command:

`CALCulate<n>:MARKer<m>:X:SLIMits[:STATe]` on page 870

`CALCulate<n>:MARKer<m>:X:SLIMits:LEFT` on page 871

`CALCulate<n>:MARKer<m>:X:SLIMits:RIGHT` on page 871

#### Search Threshold ← Search Limits

Defines an absolute threshold as an additional condition for the peak search. Only peaks that exceed the threshold are detected.

Remote command:

`CALCulate<n>:THReshold` on page 872

#### Use Zoom Limits ← Search Limits

If activated, the peak search is restricted to the active zoom area defined for a single zoom.

Remote command:

`CALCulate<n>:MARKer<m>:X:SLIMits:ZOOM[:STATe]` on page 872

#### Deactivating All Search Limits ← Search Limits

Deactivates the search range limits.

Remote command:

`CALCulate<n>:MARKer<m>:X:SLIMits[:STATe]` on page 870

`CALCulate<n>:THReshold:STATe` on page 873

### 8.3.3.3 Positioning Functions

**Access:** MKR ->

The following functions set the currently selected marker to the result of a peak search or set other characteristic values to the current marker value.

|                                           |     |
|-------------------------------------------|-----|
| Peak Search .....                         | 419 |
| Search Next Peak .....                    | 419 |
| Search Minimum .....                      | 420 |
| Search Next Minimum .....                 | 420 |
| Center Frequency = Marker Frequency ..... | 420 |
| Reference Level = Marker Level .....      | 420 |

#### Peak Search

Sets the selected marker/delta marker to the maximum of the trace. If no marker is active, marker 1 is activated.

For spectrogram displays, define which frame the peak is to be searched in.

Remote command:

`CALCulate<n>:MARKer<m>:MAXimum[:PEAK]` on page 874

`CALCulate<n>:DELTAmarker<m>:MAXimum[:PEAK]` on page 877

#### Search Next Peak

Sets the selected marker/delta marker to the next (lower) maximum of the assigned trace. If no marker is active, marker 1 is activated.

For spectrogram displays, define which frame the next peak is to be searched in.

Remote command:

[CALCulate<n>:MARKer<m>:MAXimum:NEXT](#) on page 874  
[CALCulate<n>:MARKer<m>:MAXimum:RIGHT](#) on page 875  
[CALCulate<n>:MARKer<m>:MAXimum:LEFT](#) on page 874  
[CALCulate<n>:DELTamarker<m>:MAXimum:NEXT](#) on page 877  
[CALCulate<n>:DELTamarker<m>:MAXimum:RIGHT](#) on page 878  
[CALCulate<n>:DELTamarker<m>:MAXimum:LEFT](#) on page 877

### Search Minimum

Sets the selected marker/delta marker to the minimum of the trace. If no marker is active, marker 1 is activated.

For spectrogram displays, define which frame the minimum is to be searched in.

Remote command:

[CALCulate<n>:MARKer<m>:MINimum\[:PEAK\]](#) on page 876  
[CALCulate<n>:DELTamarker<m>:MINimum\[:PEAK\]](#) on page 879

### Search Next Minimum

Sets the selected marker/delta marker to the next (higher) minimum of the selected trace. If no marker is active, marker 1 is activated.

For spectrogram displays, define which frame the next minimum is to be searched in.

Remote command:

[CALCulate<n>:MARKer<m>:MINimum:NEXT](#) on page 876  
[CALCulate<n>:MARKer<m>:MINimum:LEFT](#) on page 875  
[CALCulate<n>:MARKer<m>:MINimum:RIGHT](#) on page 876  
[CALCulate<n>:DELTamarker<m>:MINimum:NEXT](#) on page 878  
[CALCulate<n>:DELTamarker<m>:MINimum:LEFT](#) on page 878  
[CALCulate<n>:DELTamarker<m>:MINimum:RIGHT](#) on page 879

### Center Frequency = Marker Frequency

Sets the center frequency to the selected marker or delta marker frequency. A peak can thus be set as center frequency, for example to analyze it in detail with a smaller span.

This function is not available for zero span measurements.

Remote command:

[CALCulate<n>:MARKer<m>:FUNCTION:CENTer](#) on page 776

### Reference Level = Marker Level

Sets the reference level to the selected marker level.

Remote command:

[CALCulate<n>:MARKer<m>:FUNCTION:REFerence](#) on page 792

## 8.3.4 Marker (Measurement) Functions

**Access:** "Overview" > "Analysis" > "Marker Functions"



The remote commands required to define these settings are described in [Chapter 12.8.3, "Working with Markers"](#), on page 862.

- [Precise Frequency \(Signal Count\) Marker](#).....421
- [Measuring Noise Density \(Noise Meas Marker\)](#).....422
- [Phase Noise Measurement Marker](#).....425
- [Measuring Characteristic Bandwidths \(n dB Down Marker\)](#).....428
- [Fixed Reference Marker](#).....430
- [Measuring the Power in a Channel \(Band Power Marker\)](#).....431
- [Marker Peak List](#).....434
- [Deactivating All Marker Functions](#).....437

#### 8.3.4.1 Precise Frequency (Signal Count) Marker

**Access:** "Overview" > "Analysis" > "Marker Functions" > "Select Marker Function" > "Signal Count" > "Signal Count Config"

**Or:** MKR FUNC > "Select Marker Function" > "Signal Count" > "Signal Count Config"

A normal marker determines the position of the point on the trace and indicates the signal frequency at this position. The trace, however, contains only a limited number of points. Depending on the selected span, each trace point can contain many measurement values. Thus, the frequency resolution of each trace point is limited.

(See also [Chapter 7.5.1.8, "How Much Data is Measured: Sweep Points and Sweep Count"](#), on page 365).

Frequency resolution is further restricted by the RBW and sweep time settings.

To determine the frequency of a signal point accurately without changing the sweep settings, the R&S FPS is equipped with a signal counter. The signal counter sets the RF to the current marker position, then counts the zero crossings of the IF (thus the term signal *counter*) and derives the precise frequency value.

Signal counting can be performed explicitly at the current marker position ( "Signal Count" marker function), or implicitly by the R&S FPS for certain functions.

Signal counting is only possible while the instrument is not sweeping. Thus, to perform a signal count for a marker, the sweep is stopped at the marker position. The frequency is determined with the desired resolution and then the sweep is allowed to continue.

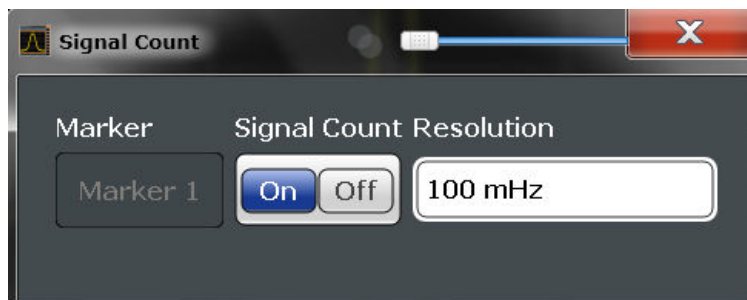

A measurement example is described in [Chapter 6.1.3.2, "Measuring the Signal Frequency Using the Signal Counter"](#), on page 128.



Signal counters are not available for measurements on I/Q-based data.

#### Remote commands:

[CALCulate<n>:MARKer<m>:COUNT](#) on page 908

[CALCulate<n>:MARKer<m>:COUNT:RESolution](#) on page 909

[Signal Count Marker State](#) ..... 422  
[Resolution](#) ..... 422

#### Signal Count Marker State

Activates or deactivates the special signal count marker function.

When activated, the sweep stops at the reference marker until the signal counter has delivered a result.

Remote command:

[CALCulate<n>:MARKer<m>:COUNT](#) on page 908

[CALCulate<n>:MARKer<m>:COUNT:FREquency?](#) on page 909

#### Resolution

Defines the resolution with which the signal is analyzed around the reference marker 1.

Remote command:

[CALCulate<n>:MARKer<m>:COUNT:RESolution](#) on page 909

#### 8.3.4.2 Measuring Noise Density (Noise Meas Marker)

**Access:** "Overview" > "Analysis" > "Marker Functions" > "Select Marker Function" > "Noise Measurement" > "Noise Meas Config"

**Or:** MKR FUNC > "Select Marker Function" > "Noise Measurement" > "Noise Meas Config"

Using the noise measurement marker function, the noise power density is measured at the position of the marker. In the time domain mode, all points of the trace are used to determine the noise power density. When measurements are performed in the frequency domain, eight points to the right and left of the marker (if available) are used for the measurement to obtain a stable result.

### Result display

Noise density is the noise referred to a bandwidth of 1 Hz. With logarithmic amplitude units (dBm, dBmV, dBm $\mu$ V, dB $\mu$ A), the noise power density is output in dBm/Hz, i.e. as the level in 1 Hz bandwidth with reference to 1 mW. With linear amplitude units (V, A, W), the noise voltage density is analyzed in  $\mu$ V/ $\sqrt$ Hz; the noise current density in  $\mu$ A/ $\sqrt$ Hz; the noise power density in  $\mu$ W/ $\sqrt$ Hz.

The result is indicated as the **function result in the Marker Table**.

### Prerequisite settings

The following settings are required to obtain correct values:

- Detector: Sample or RMS
- Video bandwidth:
  - ≤ 0.1 resolution bandwidth with sample detector
  - ≥ 3 x resolution bandwidth with RMS detector
- Trace averaging:

In the default setting, the R&S FPS uses the sample detector for the noise function. With the sample detector, you can set the trace to "Average" mode to stabilize the measured values. When the RMS detector is used, trace averaging produces noise levels that are too low and cannot be corrected. Instead, increase the sweep time to obtain stable measurement results.

### Correction factors

The R&S FPS uses the following correction factors to analyze the noise density from the marker level:

- Since the noise power is indicated with reference to 1 Hz bandwidth, the bandwidth correction value is deducted from the marker level. It is  $10 \times \lg(1 \text{ Hz}/\text{BWNoise})$ , where BWNoise is the noise or power bandwidth of the set resolution filter (RBW).
- RMS detector: With the exception of bandwidth correction, no further corrections are required since this detector already indicates the power for each point of the trace.
- Sample detector: As a result of video filter averaging and trace averaging, 1.05 dB is added to the marker level. This is the difference between the average value and the RMS value of white noise. With a logarithmic level axis, 1.45 dB is added additionally. Logarithmic averaging is thus fully taken into account, which yields a value that is 1.45 dB lower than that of linear averaging.
- To allow for a more stable noise display, eight trace points on each side of the measurement frequency are averaged.

- For span > 0, the measured values are averaged versus time (after a sweep).



The R&S FPS noise figure can be calculated from the measured power density level. It is calculated by deducting the set RF attenuation (RF Att) from the displayed noise level and adding 174 to the result.

The individual marker settings correspond to those defined in the "Marker" dialog box (see [Chapter 8.3.2.1, "Individual Marker Setup"](#), on page 408). Any settings to the marker state or type changed in the "Marker Function" dialog box are also changed in the "Marker" dialog box and vice versa.



**Remote commands:**

[CALCulate<n>:MARKer<m>:FUNCTION:NOISE\[:STATe\]](#) on page 898

[CALCulate<n>:MARKer<m>:FUNCTION:NOISE:RESult?](#) on page 897

|                                                           |     |
|-----------------------------------------------------------|-----|
| <a href="#">Marker State</a> .....                        | 424 |
| <a href="#">Marker Type</a> .....                         | 425 |
| <a href="#">Noise Measurement State</a> .....             | 425 |
| <a href="#">Switching All Noise Measurement Off</a> ..... | 425 |

**Marker State**

Activates or deactivates the marker in the diagram.

Remote command:

[CALCulate<n>:MARKer<m>\[:STATe\]](#) on page 867

[CALCulate<n>:DELTAmarker<m>\[:STATe\]](#) on page 865



**Marker Type**

Toggles the marker type.

The type for marker 1 is always "Normal" , the type for delta marker 1 is always "Delta" . These types cannot be changed.

**Note:** If normal marker 1 is the active marker, switching the "Mkr Type" activates an additional delta marker 1. For any other marker, switching the marker type does not activate an additional marker, it only switches the type of the selected marker.

"Normal"            A normal marker indicates the absolute value at the defined position in the diagram.

"Delta"            A delta marker defines the value of the marker relative to the specified reference marker (marker 1 by default).

Remote command:

[CALCulate<n>:MARKer<m>\[:STATe\]](#) on page 867

[CALCulate<n>:DELTAmarker<m>\[:STATe\]](#) on page 865

**Noise Measurement State**

Activates or deactivates noise measurement for the marker in the diagram.

This function is only available for normal markers.

If activated, the marker displays the noise power density measured at the position of the marker.

For details see [Chapter 8.3.4.2, "Measuring Noise Density \(Noise Meas Marker\)"](#), on page 422.

Remote command:

[CALCulate<n>:MARKer<m>:FUNCTION:NOISe\[:STATe\]](#) on page 898

[CALCulate<n>:MARKer<m>:FUNCTION:NOISe:RESult?](#) on page 897

**Switching All Noise Measurement Off**

Deactivates noise measurement for all markers.

Remote command:

[CALCulate<n>:MARKer<m>:FUNCTION:NOISe\[:STATe\]](#) on page 898

**8.3.4.3 Phase Noise Measurement Marker**

**Access:** "Overview" > "Analysis" > "Marker Functions" > "Phase Noise" > "Phase Noise Config"

**Or:** MKR FUNC > "Select Marker Function" > "Phase Noise" > "Phase Noise Config"

For each of the 16 markers phase noise measurement can be activated.

Phase noise is unintentional modulation of a carrier; it creates frequencies next to the carrier frequency. A phase noise measurement consists of noise density measurements at defined offsets from the carrier; the results are given in relation to the carrier level (dBc). The phase noise marker function measures the noise power at the delta markers referred to 1 Hz bandwidth. Marker 1 is used as the reference for the phase noise measurement. By default, the current frequency and level of marker 1 are used

as the fixed reference marker. However, a peak search can be started to use the current signal peak as the reference point, or a reference point can be defined manually.

Since the reference point is fixed, the reference level or the center frequency can be set so that the carrier is outside the displayed frequency range after phase noise measurement is started. Or a notch filter can be switched on to suppress the carrier.

Alternatively, the reference point can be determined automatically by a peak search after each sweep. This function can be used to track a drifting source during a phase noise measurement. The delta marker 2, which shows the phase noise measurement result, keeps the delta frequency value. Therefore the phase noise measurement leads to reliable results in a certain offset although the source is drifting. Only if the marker 2 reaches the border of the span, the delta marker value is adjusted to be within the span. In these cases, select a larger span.

The result of the phase noise measurement is the difference in level between the reference point and the noise power density. It is indicated as the function result of the phase noise marker in the marker table.

The sample detector is automatically used and the video bandwidth set to 0.1 times the resolution bandwidth (RBW). The two settings are taken into account in the correction values used for the noise power measurement. To obtain stable results, two pixels on the right and the left of the delta marker position are taken for the measurement.

The procedure for determining the noise power is identical to the method used for the noise power measurement (see [Chapter 8.3.4.2, "Measuring Noise Density \(Noise Meas Marker\)"](#), on page 422).

The individual marker settings correspond to those defined in the "Marker" dialog box. Any settings to the marker state or type changed in the "Marker Function" dialog box are also changed in the "Marker" dialog box and vice versa.



**Remote commands:**

[CALCulate<n>:MARKer<m>:FUNCTION:PNOise\[:STATE\]](#) on page 901

[CALCulate<n>:MARKer<m>:FUNCTION:PNOise:RESult?](#) on page 900

[Phase Noise Measurement State](#) ..... 427

[Defining Reference Point](#) ..... 427

[Switching All Phase Noise Measurements Off](#) ..... 428

**Phase Noise Measurement State**

Activates or deactivates phase noise measurement for the reference point in the diagram.

This function is only available for delta markers.

If activated, the delta markers display the phase noise measured at defined offsets from the reference position.

Remote command:

[CALCulate<n>:DELTamarker<m>:FUNCTION:PNOise\[:STATE\]](#) on page 900

[CALCulate<n>:DELTamarker<m>:FUNCTION:PNOise:RESult?](#) on page 899

**Defining Reference Point**

Instead of using marker 1 as the reference marker, a fixed reference marker can be defined for phase noise measurement.

The "Level" and "Frequency" or "Time" settings define the position and value of the reference point.

Alternatively, a **Peak Search** can be performed to set the maximum value of the selected trace as the reference point.

If "Automatic Peak Search" is activated, a peak search is started automatically after each sweep and the result is used as the reference point.

Remote command:

`CALCulate<n>:DELTAmarker<m>:FUNCTION:FIXed:RPOINT:Y` on page 893

`CALCulate<n>:DELTAmarker<m>:FUNCTION:FIXed:RPOINT:X` on page 892

`CALCulate<n>:DELTAmarker<m>:FUNCTION:FIXed:RPOINT:MAXimum[:PEAK]`  
on page 892

`CALCulate<n>:DELTAmarker<m>:FUNCTION:PNOise:AUTO` on page 899

#### Switching All Phase Noise Measurements Off

Deactivates phase noise measurement for all markers.

Remote command:

`CALCulate<n>:DELTAmarker<m>:FUNCTION:PNOise[:STATE]` on page 900

#### 8.3.4.4 Measuring Characteristic Bandwidths (n dB Down Marker)

**Access:** "Overview" > "Analysis" > "Marker Functions" > "n dB down" > "n dB Down Config"

**Or:** MKR FUNC > "Select Marker Function" > "n dB down" > "n dB Down Config"

When characterizing the shape of a signal, the bandwidth at a specified offset from its peak level is often of interest. The offset is specified as a relative decrease in amplitude of n dB. To measure this bandwidth, you could use several markers and delta markers and determine the bandwidth manually. However, using the n dB down marker function makes the task very simple and quick.

The n dB down marker function uses the current value of marker 1 as the reference point. It activates two temporary markers T1 and T2 located on the signal, whose level is n dB below the level of the reference point. Marker T1 is placed to the left and marker T2 to the right of the reference marker. The default setting for n is 3 dB, but it can be changed.

If a positive offset is entered, the markers T1 and T2 are placed below the active reference point. If a negative value is entered (for example for notch filter measurements), the markers T1 and T2 are placed above the active reference point.

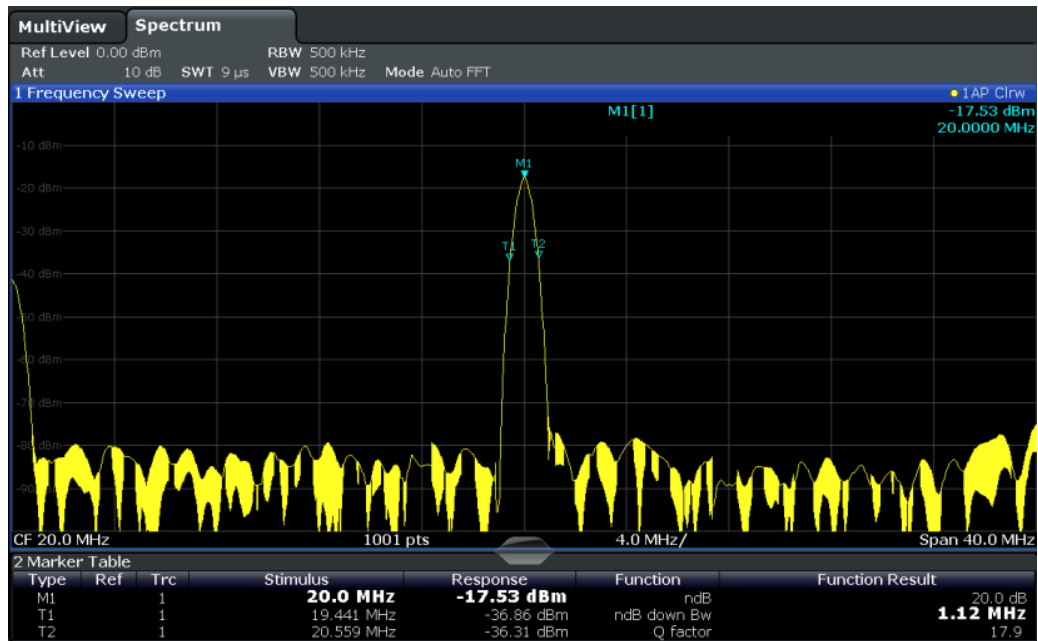

Figure 8-5: n dB down marker function

The following marker function results are displayed:

Table 8-1: n dB down marker function results

| Label              | Description                                                                         |
|--------------------|-------------------------------------------------------------------------------------|
| M1                 | Current position and level of marker 1                                              |
| ndB                | Offset value (n dB down)                                                            |
| ndB down Bw / PWid | Determined bandwidth or pulse width (zero span) at the offset                       |
| Q-factor           | Quality factor of the determined bandwidth (characteristic of damping or resonance) |
| T1, T2             | Current position and level of the temporary markers                                 |

If the required position for the temporary markers cannot be determined uniquely, for example due to noise, dashes are displayed as a result.



**Remote commands:**

CALCulate<n>:MARKer<m>:FUNCTION:NDBDown:STATE on page 907

CALCulate<n>:MARKer<m>:FUNction:NDBDown:RESult? on page 906

n dB down Marker State .....430  
 n dB down Delta Value .....430

**n dB down Marker State**

Activates or deactivates the special n dB down marker function.

Remote command:

CALCulate<n>:MARKer<m>:FUNction:NDBDown:STATe on page 907

CALCulate<n>:MARKer<m>:FUNction:NDBDown:RESult? on page 906

**n dB down Delta Value**

Defines the delta level from the reference marker 1 used to determine the bandwidth or time span.

Remote command:

CALCulate<n>:MARKer<m>:FUNction:NDBDown:FREQuency? on page 905

CALCulate<n>:MARKer<m>:FUNction:NDBDown:TIME? on page 907

**8.3.4.5 Fixed Reference Marker**

**Access:** "Overview" > "Analysis" > "Marker Functions" > "Reference Fixed"

**Or:** MKR FUNC > "Select Marker Function" > "Reference Fixed"

Instead of using a reference marker that may vary its position depending on the measurement results, a fixed reference marker can be defined for trace analysis. Once positioned, the reference marker does not move during subsequent sweeps unless you explicitly move it manually.

When you select this marker function, a vertical and a horizontal red display line are displayed, marked as "FXD". A normal marker is activated and set to the peak value and a delta marker to the next peak. The fixed reference marker is set to the position of the normal marker at the peak value. The delta marker refers to the fixed reference marker.

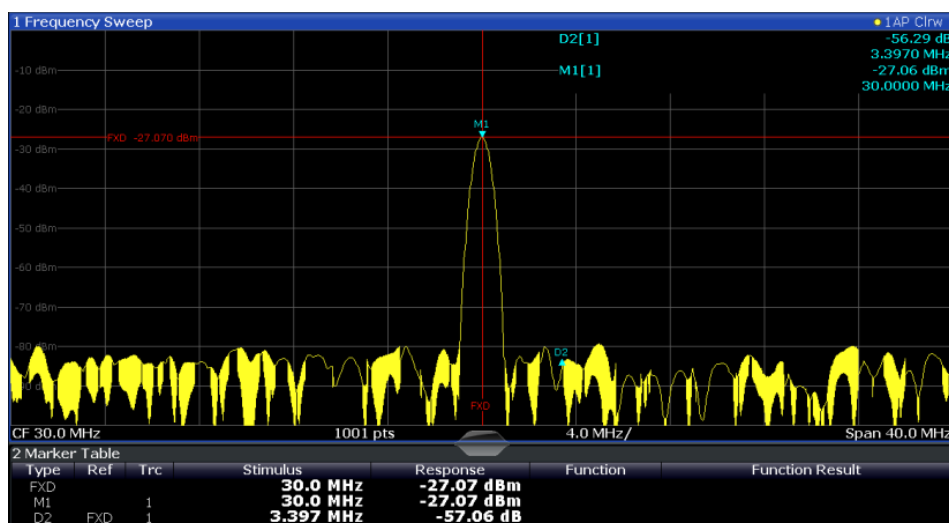

You can move the position of the fixed reference marker graphically by dragging the display lines, or numerically by entering values for the marker position and level.

**Remote commands:**

`CALCulate<n>:DELTAmarker<m>:FUNCTION:FIXed[:STATe]` on page 893

`CALCulate<n>:DELTAmarker<m>:FUNCTION:FIXed:RPOint:X` on page 892

`CALCulate<n>:DELTAmarker<m>:FUNCTION:FIXed:RPOint:Y` on page 893

### 8.3.4.6 Measuring the Power in a Channel (Band Power Marker)

**Access:** "Overview" > "Analysis" > "Marker Functions" > "Band Power" > "Band Power Config"

**or:** MKR FUNC > "Select Marker Function" > "Band Power"

To determine the noise power in a transmission channel, you could use a noise marker and multiply the result with the channel bandwidth. However, the results would only be accurate for flat noise.

Band power markers allow you to measure the integrated power for a defined span (band) around a marker (similar to ACP measurements). By default, 5 % of the current span is used. The span is indicated by limit lines in the diagram. The results can be displayed either as a power (dBm) or density (dBm/Hz) value and are indicated in the marker table for each band power marker.



#### Relative band power markers

The results for band power markers which are defined as *delta* markers and thus have a reference value can also be calculated as reference power values (in dB).

In this case, the result of the band power deltamarker is the difference between the absolute power in the band around the delta marker and the absolute power for the reference marker. The powers are subtracted logarithmically, so the result is a dB value.

*[Relative band power (Delta2) in dB] = [absolute band power (Delta2) in dBm] - [absolute (band) power of reference marker in dBm]*

The measured power for the reference marker may be an absolute power at a single point (if the reference marker is not a band power marker), or the power in a band (if the reference marker is a band power marker itself).

If the reference marker for the band power marker is also a delta marker, the absolute power level for the reference marker is used for calculation.



Band power markers are only available for standard frequency measurements (not zero span) in the Spectrum application.

For the I/Q Analyzer application, band power markers are only available for Spectrum displays.

The entire band must lie within the display. If it is moved out of the display, the result cannot be calculated (indicated by "- -" as the "Function Result" ). However, the width of the band is maintained so that the band power can be calculated again when it returns to the display.

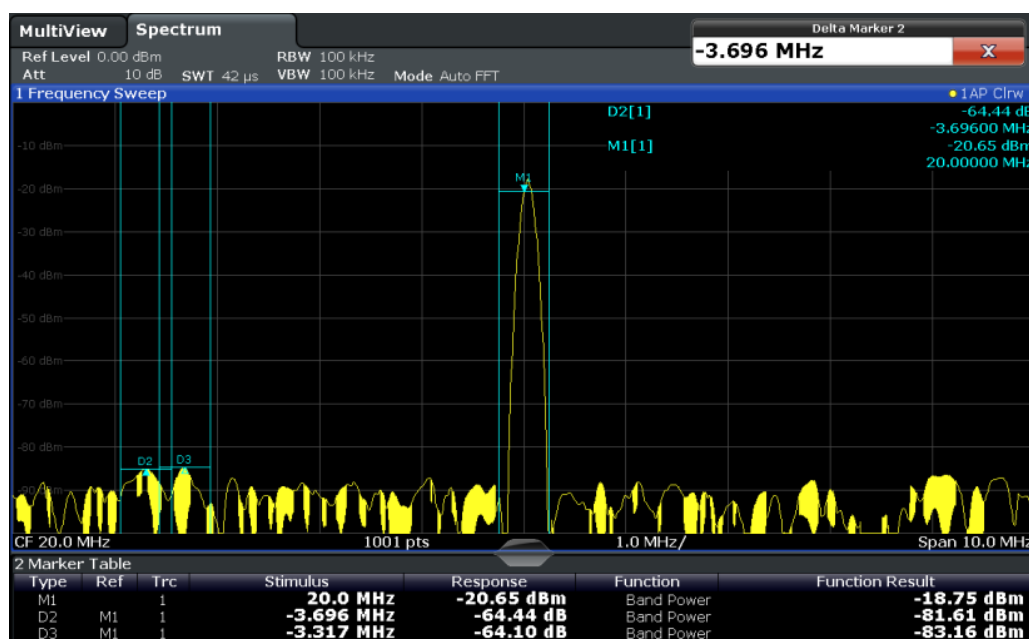

All markers can be defined as band power markers, each with a different span. When a band power marker is activated, if no marker is active yet, marker 1 is activated. Otherwise, the currently active marker is used as a band power marker (all other marker functions for this marker are deactivated).

If the detector mode for the marker trace is set to "Auto" , the RMS detector is used.

The individual marker settings correspond to those defined in the "Marker" dialog box (see [Chapter 8.3.2.1, "Individual Marker Setup"](#), on page 408). Any settings to the marker state or type changed in the "Marker Function" dialog box are also changed in the "Marker" dialog box and vice versa.





**Remote commands:**

[CALCulate<n>:MARKer<m>:FUNCTION:BPOwer\[:STATE\]](#) on page 902

[CALCulate<n>:MARKer<m>:FUNCTION:BPOwer:RESult?](#) on page 902

[Band Power Measurement State](#) ..... 433

[Span](#) ..... 433

[Power Mode](#) ..... 433

[Switching All Band Power Measurements Off](#) ..... 434

**Band Power Measurement State**

Activates or deactivates band power measurement for the marker in the diagram. Band power markers are only available for standard frequency measurements (not zero span) in the Spectrum application. If activated, the markers display the power or density measured in the band around the current marker position.

For details see [Chapter 8.3.4.6, "Measuring the Power in a Channel \(Band Power Marker\)"](#), on page 431.

Remote command:

[CALCulate<n>:MARKer<m>:FUNCTION:BPOwer\[:STATE\]](#) on page 902

[CALCulate<n>:DELTamarker<m>:FUNCTION:BPOwer\[:STATE\]](#) on page 904

**Span**

Defines the span (band) around the marker for which the power is measured. The span is indicated by lines in the diagram.

Remote command:

[CALCulate<n>:MARKer<m>:FUNCTION:BPOwer:SPAN](#) on page 902

[CALCulate<n>:DELTamarker<m>:FUNCTION:BPOwer:SPAN](#) on page 904

**Power Mode**

Defines the mode of the power measurement result.

|                  |                                                                                                                                                                                                                                                                                                                                                                                                                                                                                                                                                                         |
|------------------|-------------------------------------------------------------------------------------------------------------------------------------------------------------------------------------------------------------------------------------------------------------------------------------------------------------------------------------------------------------------------------------------------------------------------------------------------------------------------------------------------------------------------------------------------------------------------|
| "Power"          | The result is an absolute power level.<br>The power unit depends on the <a href="#">Unit</a> setting.                                                                                                                                                                                                                                                                                                                                                                                                                                                                   |
| "Relative Power" | This setting is only available for a delta band power marker.<br>The result is the difference between the absolute power in the band around the delta marker and the absolute power for the reference marker (see " <a href="#">Reference Marker</a> " on page 410). The powers are subtracted logarithmically, so the result is a dB value.<br><i>[Relative band power (Delta2) in dB] = [absolute band power (Delta2) in dBm] - [absolute (band) power of reference marker in dBm]</i><br>For details see " <a href="#">Relative band power markers</a> " on page 431 |
| "Density"        | The result is a power level in relation to the bandwidth, displayed in dBm/Hz.                                                                                                                                                                                                                                                                                                                                                                                                                                                                                          |

Remote command:

`CALCulate<n>:MARKer<m>:FUNCTION:BPOWER:MODE` on page 901

`CALCulate<n>:DELTAmarker<m>:FUNCTION:BPOWER:MODE` on page 903

#### Switching All Band Power Measurements Off

Deactivates band power measurement for all markers.

Remote command:

`CALCulate<n>:MARKer<m>:FUNCTION:BPOWER[:STATe]` on page 902

`CALCulate<n>:DELTAmarker<m>:FUNCTION:BPOWER[:STATe]` on page 904

#### 8.3.4.7 Marker Peak List

**Access:** "Overview" > "Analysis" > "Marker Functions" > "Marker Peak List"

**Or:** MKR FUNC > "Marker Peak List"

A common measurement task is to determine peak values, i.e. maximum or minimum signal levels. The R&S FPS provides various peak search functions and applications:

- Setting a marker to a peak value once (Peak Search)
- Searching for a peak value within a restricted search area (Search Limits)
- Creating a marker table with all or a defined number of peak values for one sweep (Marker Peak List)
- Updating the marker position to the current peak value automatically after each sweep (Auto Peak Search)
- Creating a fixed reference marker at the current peak value of a trace (Fixed Reference)

#### Peak search limits

The peak search can be restricted to a search area. The search area is defined by limit lines which are also indicated in the diagram. In addition, a minimum value (threshold) can be defined as a further search condition.

**When is a peak a peak? - Peak excursion**

During a peak search, for example when a marker peak table is displayed, noise values may be detected as a peak if the signal is very flat or does not contain many peaks. Therefore, you can define a relative threshold ( "Peak Excursion" ). The signal level must increase by the threshold value before falling again before a peak is detected. To avoid identifying noise peaks as maxima or minima, enter a peak excursion value that is higher than the difference between the highest and the lowest value measured for the displayed inherent noise.

**Effect of peak excursion settings (example)**

The following figure shows a trace to be analyzed.

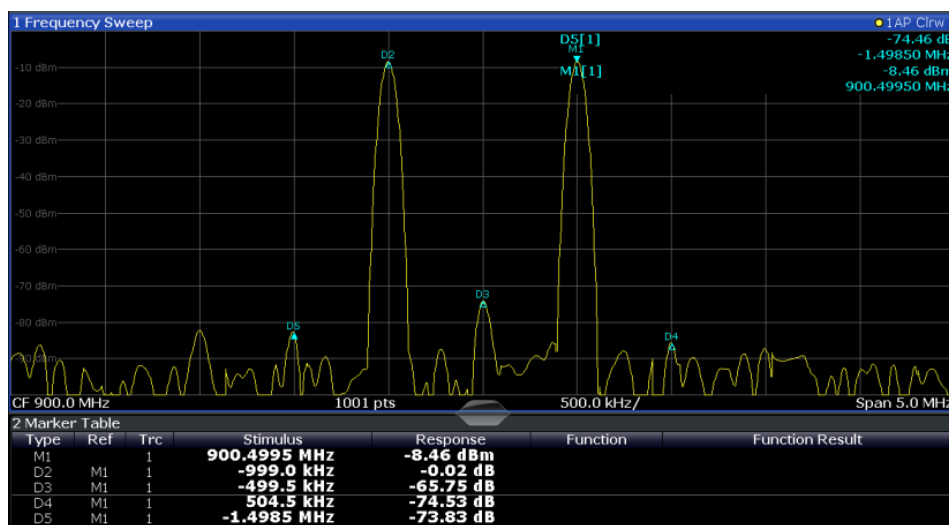

Figure 8-6: Trace example

The following table lists the peaks as indicated by the marker numbers in the diagram above, as well as the minimum decrease in amplitude to either side of the peak:

| Marker # | Min. amplitude decrease to either side of the signal |
|----------|------------------------------------------------------|
| 1        | 30 dB                                                |
| 2        | 29.85 dB                                             |
| 3        | 20 dB                                                |
| 4        | 10 dB                                                |
| 5        | 18 dB                                                |

In order to eliminate the smaller peaks M3,M4 and M5 in the example above, a peak excursion of at least 20 dB is required. In this case, the amplitude must rise at least 20 dB before falling again before a peak is detected.

**Marker peak list**

The marker peak list determines the frequencies and levels of peaks in the spectrum. It is updated automatically after each sweep . How many peaks are displayed can be defined, as well as the sort order. In addition, the detected peaks can be indicated in the diagram. The peak list can also be exported to a file for analysis in an external application.

**Automatic peak search**

A peak search can be repeated automatically after each sweep in order to keep the maximum value as the reference point for a phase noise measurement. This is useful to track a drifting source. The delta marker 2, which shows the phase noise measurement result, keeps the delta frequency value. Therefore the phase noise measurement leads to reliable results in a certain offset although the source is drifting.

**Using a peak as a fixed reference marker**

Some results are analyzed in relation to a peak value, for example a carrier frequency level. In this case, the maximum level can be determined by an initial peak search and then be used as a reference point for further measurement results.



**Remote commands:**

CALCulate<n>:MARKer<m>:FUNCTION:FPEaks:STATE on page 896

TRAC? LIST, see TRACe<n>[:DATA] on page 854

Peak List State ..... 437

Sort Mode ..... 437

Maximum Number of Peaks ..... 437

Peak Excursion ..... 437

Display Marker Numbers ..... 437

Export Peak List ..... 437

**Peak List State**

Activates/deactivates the marker peak list. If activated, the peak list is displayed and the peaks are indicated in the trace display.

For each listed peak the frequency/time ( "X-value" ) and level ( "Y-Value" ) values are given.

Remote command:

`CALCulate<n>:MARKer<m>:FUNCTION:FPEaks:STATE` on page 896

**Sort Mode**

Defines whether the peak list is sorted according to the x-values or y-values. In either case the values are sorted in ascending order.

Remote command:

`CALCulate<n>:MARKer<m>:FUNCTION:FPEaks:SORT` on page 896

**Maximum Number of Peaks**

Defines the maximum number of peaks to be determined and displayed.

Remote command:

`CALCulate<n>:MARKer<m>:FUNCTION:FPEaks:LIST:SIZE` on page 896

**Peak Excursion**

Defines the minimum level value by which a signal must rise or fall so that it is identified as a maximum or a minimum by the search functions.

Entries from 0 dB to 80 dB are allowed; the resolution is 0.1 dB. The default setting for the peak excursion is 6 dB.

For more information see [Chapter 8.3.4.7, "Marker Peak List"](#), on page 434.

Remote command:

`CALCulate<n>:MARKer<m>:PEXCursion` on page 870

**Display Marker Numbers**

By default, the marker numbers are indicated in the diagram so you can find the peaks from the list. However, for large numbers of peaks the marker numbers may decrease readability; in this case, deactivate the marker number display.

Remote command:

`CALCulate<n>:MARKer<m>:FUNCTION:FPEaks:ANnotation:LABEL[:STATE]`  
on page 894

**Export Peak List**

The peak list can be exported to an ASCII file ( .DAT ) for analysis in an external application.

Remote command:

`MMEMory:STORe<n>:PEAK` on page 964

`FORMat:DEXPort:DSEParator` on page 937

**8.3.4.8 Deactivating All Marker Functions**

**Access:** "Overview" > "Analysis" > "Marker Functions" > "All Functions Off"

Or: MKR FUNC > "All Functions Off"

All special marker functions can be deactivated in one step.

### 8.3.5 How to Work With Markers

The following step-by-step instructions demonstrate in detail how to work with markers.

- [How to Analyze a Signal Point in Detail](#).....438
- [How to Use a Fixed Reference Marker](#).....438

#### 8.3.5.1 How to Analyze a Signal Point in Detail



Step-by-step instructions on working with markers are provided here. For details on individual functions and settings see [Chapter 8.3.2, "Marker Settings"](#), on page 408.

The remote commands required to perform these tasks are described in [Chapter 12.8.3, "Working with Markers"](#), on page 862.

When you need to analyze a characteristic point in the signal in more detail, the following procedure can be helpful:

1. Perform a peak search to determine the characteristic point roughly by pressing the PEAK SEARCH key.
2. If the required signal point is not the maximum, continue the peak search to one of the subsequent maxima or minima:
  - a) Press the MKR -> key.
  - b) Select the "Next Peak" or "Next Min" key.
  - c) If necessary, change the search settings by selecting the "Search Config" softkey.
3. Center the display around the determined signal point by setting the marker value to the center frequency. Select the "Center = Mkr Freq" softkey.
4. Determine the precise frequency of the signal point:
  - a) Select the "Select Marker Function" softkey.
  - b) Select the "Signal Count" button.
  - c) Select the "Signal Count Resolution" softkey.
  - d) Select the resolution depending on how precise the result needs to be.

#### 8.3.5.2 How to Use a Fixed Reference Marker

By default, delta markers refer to marker 1. However, they can also refer to a fixed reference marker.

### How to Define and Move a Fixed Reference Marker

- To display a fixed reference marker, do one of the following:
  - Press the MKR FUNC key, then select the "Reference Fixed" marker function.
  - In the "Marker" dialog box, in the "Reference Fixed" area of the "Marker Config" tab, set the "State" to "On" .

A vertical and a horizontal red display line are displayed, marked as "FXD" . The normal marker 1 is activated and set to the peak value of the trace assigned to marker 1, and a delta marker to the next peak. The fixed reference marker is set to the position of marker 1 at the peak value.

- To move the fixed reference marker, do one of the following:
  - Change the "Level" and "Frequency" of the reference point in the "Marker Config" tab of the "Marker" dialog box, . By default, the current peak value of trace 1 is set.
  - Set the fixed reference marker to the current peak value by selecting the "Peak Search" button in the "Marker Config" tab of the "Marker" dialog box.
  - Move the "FXD" display lines that define the position of the fixed reference marker by dragging them on the screen.

### How to Assign a Fixed Reference Marker to Delta Markers

- In the "Marker" dialog box, select the horizontal "Markers" tab.
- For the active delta marker that is to refer to the fixed reference marker, select "FXD" from the "Reference Marker" list.

The delta marker indicates the offset of the current trace value at the marker position from the fixed reference value.

## 8.3.6 Measurement Example: Measuring Harmonics Using Marker Functions

This measurement example describes how to measure harmonics using the provided marker functions. Note that this task can be performed much simpler using the Harmonic Distortion measurement (see [Chapter 6.9, "Harmonic Distortion Measurement"](#), on page 280).

### Signal generator settings (e.g. R&S FPS SMW):

|            |          |
|------------|----------|
| Frequency: | 128 MHz  |
| Level:     | - 25 dBm |

### Procedure:

- Preset the R&S FPS.
- Set the center frequency to *128 MHz*.

3. Set the span to 100 kHz.

The R&S FPS displays the reference signal with a span of 100 kHz and resolution bandwidth of 1 kHz.

4. Switch on the marker by pressing the MKR key.  
The marker is positioned on the trace maximum.
5. Set the measured signal frequency and the measured level as reference values:
  - a) Press the MKR FUNC key
  - b) Press the "Reference Fixed" softkey.

The position of the marker becomes the reference point. The reference point level is indicated by a horizontal line, the reference point frequency with a vertical line. At the same time, the delta marker 2 is switched on.

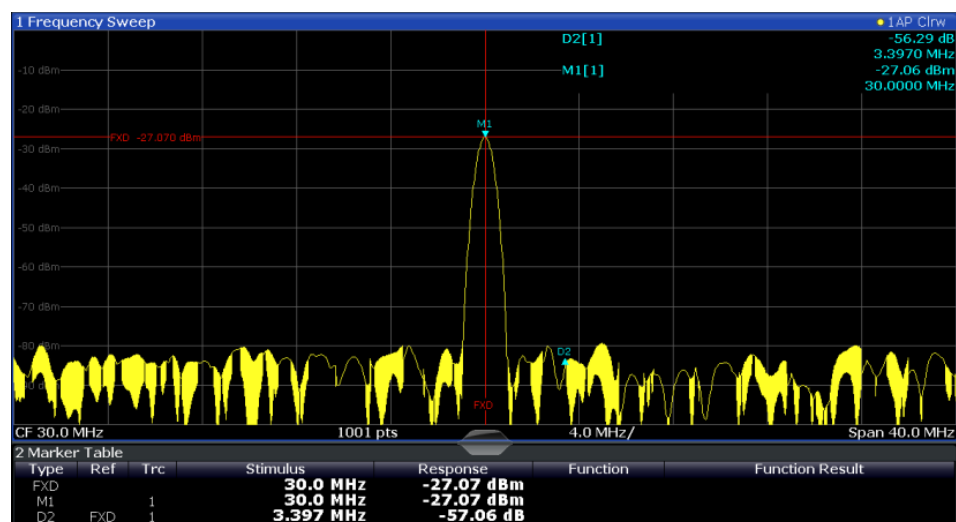

Figure 8-7: Fundamental wave and the frequency and level reference point

6. Make the step size for the center frequency correspond to the signal frequency: in the "Frequency" configuration dialog box, select "Center Frequency Stepsize" = "Marker" .  
The step size for the center frequency is now equal to the marker frequency.
7. Move the center frequency to the 2<sup>nd</sup> harmonic of the signal by pressing the UP (↑) key.  
The center frequency is set to the 2<sup>nd</sup> harmonic.
8. Place the delta marker on the 2<sup>nd</sup> harmonic: in the "Marker To" menu, select the "Peak" softkey.

The delta marker moves to the maximum of the 2<sup>nd</sup> harmonic. The displayed level result is relative to the reference point level (= fundamental wave level).



The other harmonics are measured by repeating steps [step 7](#) and [step 8](#), with the center frequency being incremented or decremented in steps of 128 MHz using the UP or DOWN keys.

## 8.4 Display and Limit Lines

Display and limit lines help you analyze a measurement trace.

**Access:** "Overview" > "Analysis" > "Lines"

For remote operation, see [Chapter 12.8.4, "Configuring Display and Limit Lines"](#), on page 917.

- [Display Lines](#).....441
- [Limit Lines](#).....443

### 8.4.1 Display Lines

#### 8.4.1.1 Basics on Display Lines

Display lines help you analyze a trace – as do markers. The function of a display line is comparable to that of a ruler that can be shifted on the trace in order to mark absolute values. They are used exclusively to visually mark relevant frequencies or points in time (zero span), as well as constant level values. It is not possible to check automatically whether the points are below or above the marked level values - use limit lines for that task (see [Chapter 8.4.2.1, "Basics on Limit Lines"](#), on page 443).

Two different types of display lines are provided:

- Two horizontal lines: "Horizontal Line 1" and "Horizontal Line 2".  
These lines are continuous horizontal lines across the entire width of a diagram and can be shifted up and down.
- Two vertical lines: "Vertical Line 1" and "Vertical Line 2".  
These lines are continuous vertical lines across the entire height of the diagram and can be shifted left and right.

#### Labels

Each line is identified by one of the following abbreviations in the diagrams:

- H1: "Horizontal Line 1"
- H2: "Horizontal Line 2"
- V1: "Vertical Line 1"
- V2: "Vertical Line 2"

#### 8.4.1.2 Display Line Settings

**Access:** "Overview" > "Analysis" > "Lines" > "Display Lines"

Two vertical and two horizontal lines can be defined in the display.

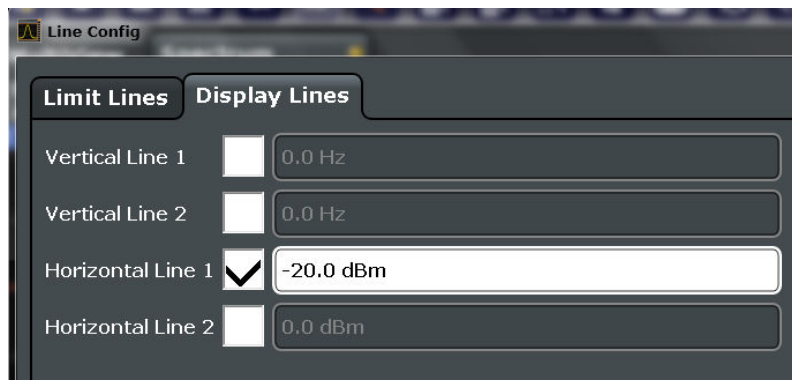

|                                             |     |
|---------------------------------------------|-----|
| Vertical Line 1 / Vertical Line 2 .....     | 442 |
| Horizontal Line 1 / Horizontal Line 2 ..... | 442 |

#### Vertical Line 1 / Vertical Line 2

Activates a vertical display line (V1 or V2) in the diagram at the specified point of the x-axis, depending on the scale of the axis.

Remote command:

[CALCulate<n>:FLINE<k>](#) on page 918

[CALCulate<n>:FLINE<k>](#) on page 918

[CALCulate<n>:TLINE<k>](#) on page 919

[CALCulate<n>:TLINE<k>](#) on page 919

#### Horizontal Line 1 / Horizontal Line 2

Activates a horizontal display line (H1 or H2) in the diagram at the specified point of the y-axis

Remote command:

[CALCulate<n>:DLINE<k>](#) on page 917

[CALCulate<n>:DLINE<k>](#) on page 917

### 8.4.1.3 Defining Display Lines

1. Display lines are configured in the "Lines Config" dialog box. To display this dialog box, press the LINES key and then "Lines Config" .
2. Select the "Display Lines" tab.
3. To define a vertical line, select "Vertical Line 1" or 2 and enter the x-value at which the line is to be displayed.  
To define a horizontal line, select "Horizontal Line 1" or 2 and enter the y-value at which the line is to be displayed.

## 8.4.2 Limit Lines

Limit lines allow you to check automatically whether the measured points are below or above specified values.

- [Basics on Limit Lines](#)..... 443
- [Limit Line Settings and Functions](#)..... 447
- [How to Define Limit Lines](#)..... 454
- [Reference: Limit Line File Format](#)..... 458

### 8.4.2.1 Basics on Limit Lines

Limit lines are used to define amplitude curves or spectral distribution boundaries in the result diagram which are not to be exceeded. They indicate, for example, the upper limits for interference radiation or spurious waves which are allowed from a device under test (DUT). When transmitting information in TDMA systems (e.g. GSM), the amplitude of the bursts in a time slot must adhere to a curve that falls within a specified tolerance band. The lower and upper limits may each be specified by a limit line. Then, the amplitude curve can be controlled either visually or automatically for any violations of the upper or lower limits (GO/NOGO test).

The R&S FPS supports limit lines with a maximum of 200 data points. Eight of the limit lines stored in the instrument can be activated simultaneously. The number of limit lines stored in the instrument is only limited by the capacity of the storage device used.

Limit line data can also be exported to a file in ASCII (CSV) format for further evaluation in other applications. Limit lines stored in the specified ASCII (CSV) format can also be imported to the R&S FPS for other measurements.

#### Compatibility

Limit lines are compatible with the current measurement settings, if the following applies:

- The x unit of the limit line has to be identical to the current setting.
- The y unit of the limit line has to be identical to the current setting with the exception of dB based units; all dB based units are compatible with each other.

#### Validity

Only limit lines that fulfill the following conditions can be activated:

- Each limit line must consist of a minimum of 2 and a maximum of 200 data points.
- The frequencies/times for each data point must be defined in ascending order; however, for any single frequency or time, two data points may be entered (to define a vertical segment of a limit line).
- Gaps in frequency or time are not allowed. If gaps are desired, two separate limit lines must be defined and then both enabled.
- The entered frequencies or times need not necessarily be selectable in R&S FPS. A limit line may also exceed the specified frequency or time range. The minimum frequency for a data point is -200 GHz, the maximum frequency is 200 GHz. For

the time range representation, negative times may also be entered. The allowed range is -1000 s to +1000 s.

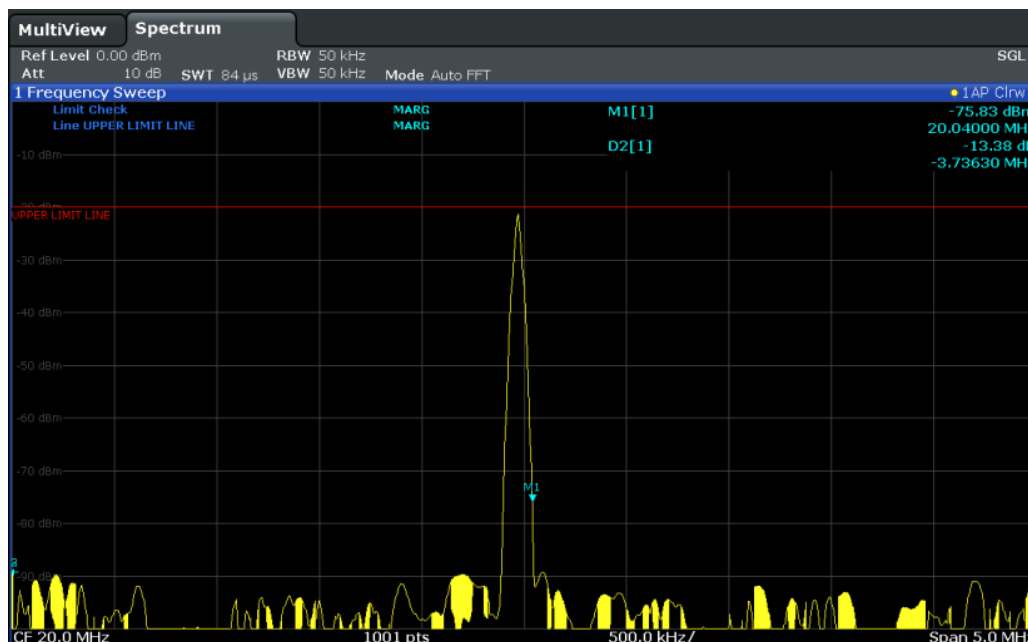

Figure 8-8: Example for an upper limit line

### Limits and Margins

Limit lines define strict values that must not be exceeded by the measured signal. A **margin** is similar to a limit, but less strict and it still belongs to the valid data range. It can be used as a warning that the limit is almost reached. The margin is not indicated by a separate line in the display, but if it is violated, a warning is displayed. Margins are defined as lines with a fixed distance to the limit line.

To check the signal for maximum levels you must define an **upper limit**, whereas to check the signal for minimum levels you must define a **lower limit**.

Limits can be defined relative to the reference level, the beginning of the time scale, or the center frequency, or as absolute values.

Relative scaling is suitable, for example, if masks for bursts are to be defined in zero span, or if masks for modulated signals are required in the frequency domain.

### Thresholds

If the y-axis for the limit line data points uses relative scaling, an additional absolute **threshold** can be defined for the limit check. In this case, both the threshold value and the relative limit line must be exceeded before a violation occurs.

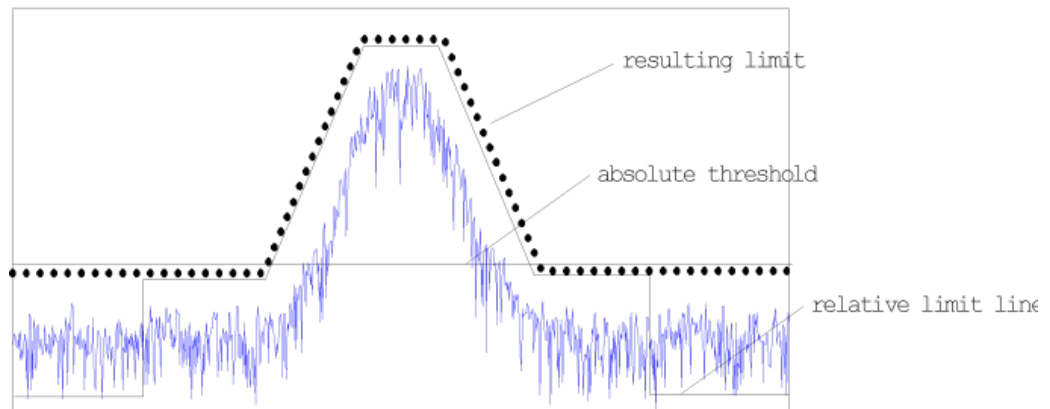

### Offsets and Shifting

A configured limit line can easily be moved vertically or horizontally. Two different methods to do so are available:

- An **offset** moves the entire line in the diagram without editing the configured values or positions of the individual data points. This option is only available if relative scaling is used.  
Thus, a new limit line can be easily generated based upon an existing limit line which has been shifted horizontally or vertically.
- Defining a **shift** width for the values or position of the individual data points changes the line configuration, thus changing the position of the line in the diagram.

### Limit Check Results

A limit check is automatically performed as soon as any of the limit lines is activated ("Visibility" setting). Only the specified "Traces to be Checked" are compared with the active limit lines. The status of the limit check for each limit line is indicated in the diagram. If a violation occurs, the limit check status is set to "MARG" for a margin violation, or to "Fail" for a limit violation.

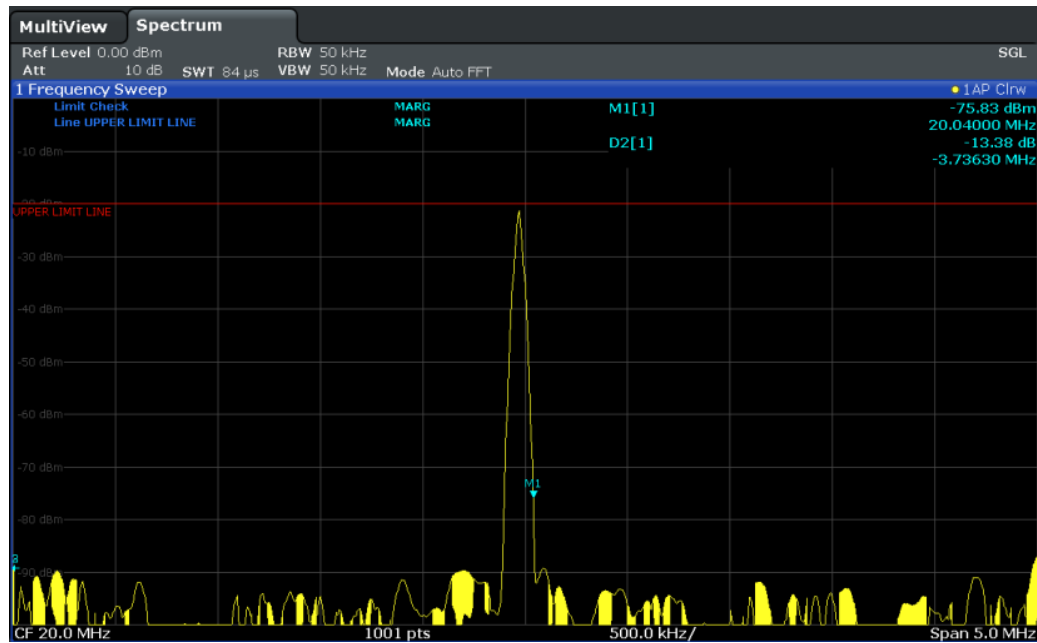

Figure 8-9: Margin violation for limit check

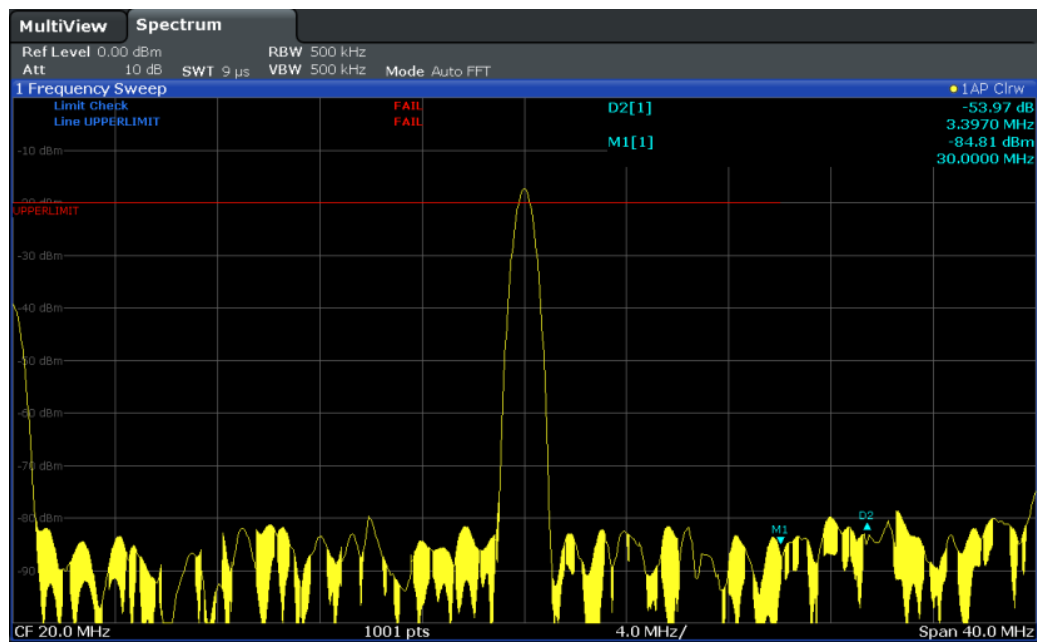

Figure 8-10: Limit violation for limit check



### Storing and Recalling Limit Lines

Limit lines can be stored with the configuration settings so they can be recalled for other measurements at a later time (see [Chapter 9.3, "Storing and Recalling Instrument Settings and Measurement Data"](#), on page 502). Note, however, that any changes made to the limit lines *after* storing the configuration file cannot be restored and will be overwritten by the stored values when the configuration file is recalled. Always remember to store the settings again after changing the limit line values.

After recalling measurement settings, the limit line values applied to the measurement may be different to those displayed in the "Limit Lines" dialog box; see ["Saving and recalling transducer and limit line settings"](#) on page 503.

#### 8.4.2.2 Limit Line Settings and Functions

**Access:** "Overview" > "Analysis" > "Lines"

or: LINES > "Line Config"

Up to 8 limit lines can be displayed simultaneously in the R&S FPS. Many more can be stored on the instrument.



### Stored limit line settings

When storing and recalling limit line settings, consider the information provided in ["Saving and recalling transducer and limit line settings"](#) on page 503.

- [Limit Line Management](#).....447
- [Limit Line Details](#).....450

### Limit Line Management

**Access:** "Overview" > "Analysis" > "Lines" > "Limit Lines"

or: LINES > "Line Config" > "Limit Lines"



For the limit line overview, the R&S FPS searches for all stored limit lines with the file extension `.LIN` in the `limits` subfolder of the main installation folder. The overview allows you to determine which limit lines are available and can be used for the current measurement.

For details on settings for individual lines see ["Limit Line Details"](#) on page 450.

For more basic information on limit lines see [Chapter 8.4.2.1, "Basics on Limit Lines"](#), on page 443.

|                                                  |     |
|--------------------------------------------------|-----|
| Name .....                                       | 448 |
| Unit .....                                       | 448 |
| Compatibility .....                              | 449 |
| Visibility .....                                 | 449 |
| Traces to be Checked .....                       | 449 |
| Comment .....                                    | 449 |
| Included Lines in Overview ( View Filter ) ..... | 449 |
| └ Show Lines for all Modes .....                 | 449 |
| X-Offset .....                                   | 449 |
| Y-Offset .....                                   | 450 |
| Create New Line .....                            | 450 |
| Edit Line .....                                  | 450 |
| Copy Line .....                                  | 450 |
| Delete Line .....                                | 450 |
| Disable All Lines .....                          | 450 |

**Name**

The name of the stored limit line.

**Unit**

The unit in which the y-values of the data points of the limit line are defined.



**Compatibility**

Indicates whether the limit line definition is compatible with the current measurement settings.

For more information on which conditions a limit line must fulfill to be compatible, see "Compatibility" on page 443.

**Visibility**

Displays or hides the limit line in the diagram. Up to 8 limit lines can be visible at the same time. Inactive limit lines can also be displayed in the diagram.

Remote command:

[CALCulate<n>:LIMit<k>:LOWer:STATe](#) on page 925

[CALCulate<n>:LIMit<k>:UPPer:STATe](#) on page 928

[CALCulate<n>:LIMit<k>:ACTive?](#) on page 929

**Traces to be Checked**

Defines which traces are automatically checked for conformance with the limit lines. As soon as a trace to be checked is defined, the assigned limit line is active. One limit line can be activated for several traces simultaneously. If any of the "Traces to be Checked" violate any of the active limit lines, a message is indicated in the diagram.

Remote command:

[CALCulate<n>:LIMit<k>:TRACe<t>:CHECK](#) on page 931

**Comment**

An optional description of the limit line.

**Included Lines in Overview ( View Filter )**

Defines which of the stored lines are included in the overview.

|                   |                                                                                                                                                                                                  |
|-------------------|--------------------------------------------------------------------------------------------------------------------------------------------------------------------------------------------------|
| "Show Compatible" | Only compatible lines<br>Whether a line is compatible or not is indicated in the <a href="#">Compatibility</a> setting.                                                                          |
| "Show All"        | All stored limit lines with the file extension <code>.LIN</code> in the <code>limits</code> subfolder of the main installation folder (if not restricted by "Show Lines for all Modes" setting). |

**Show Lines for all Modes ← Included Lines in Overview ( View Filter )**

If activated (default), limit lines from all applications are displayed. Otherwise, only lines that were created in the Spectrum application are displayed.

Note that limit lines from some applications may include additional properties that are lost when the limit lines are edited in the Spectrum application. In this case a warning is displayed when you try to store the limit line.

**X-Offset**

Shifts a limit line that has been specified for relative frequencies or times (x-axis) horizontally.

This setting does not have any effect on limit lines that are defined by absolute values for the x-axis.

Remote command:

[CALCulate<n>:LIMit<k>:CONTRol:OFFSet](#) on page 922

### Y-Offset

Shifts a limit line that has relative values for the y-axis (levels or linear units such as volt) vertically.

This setting does not have any effect on limit lines that are defined by absolute values for the y-axis.

Remote command:

[CALCulate<n>:LIMit<k>:LOWer:OFFSet](#) on page 924

[CALCulate<n>:LIMit<k>:UPPer:OFFSet](#) on page 927

### Create New Line

Creates a new limit line.

### Edit Line

Edit an existing limit line configuration.

### Copy Line

Copy the selected limit line configuration to create a new line.

Remote command:

[CALCulate<n>:LIMit<k>:COPY](#) on page 930

### Delete Line

Delete the selected limit line configuration.

Remote command:

[CALCulate<n>:LIMit<k>:DELete](#) on page 930

### Disable All Lines

Disable all limit lines in one step.

Remote command:

[CALCulate<n>:LIMit<k>:STATe](#) on page 930

### Limit Line Details

**Access:** "Overview" > "Analysis" > "Lines" > "Limit Lines" > "New" / "Edit" / "Copy To"

**or:** LINES > "Line Config" > "Limit Lines" > "New" / "Edit" / "Copy To"

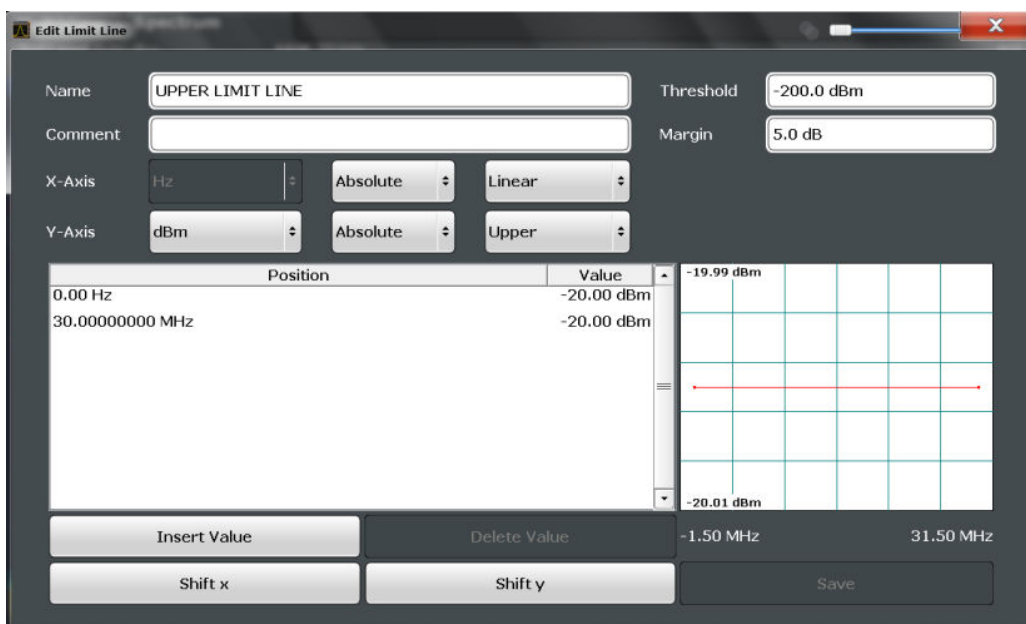

Name .....451

Comment .....451

Threshold .....451

Margin .....452

X-Axis .....452

Y-Axis .....452

Data Points .....452

Insert Value .....453

Delete Value .....453

Shift x .....453

Shift y .....453

Save .....453

Import .....453

Export .....453

**Name**

Defines the limit line name. All names must be compatible with Windows conventions for file names. The limit line data is stored under this name (with a .LIN extension).

Remote command:

CALCulate<n>:LIMit<k>:NAME on page 925

**Comment**

Defines an optional comment for the limit line.

Remote command:

CALCulate<n>:LIMit<k>:COMMeNt on page 920

**Threshold**

Defines an absolute threshold value (only for relative scaling of the y-axis).

For details on thresholds see "Thresholds" on page 444.

Remote command:

`CALCulate<n>:LIMit<k>:LOWer:THReshold` on page 925

`CALCulate<n>:LIMit<k>:UPPer:THReshold` on page 929

### Margin

Defines a margin for the limit line. The default setting is 0 dB (i.e. no margin).

For details on margins see "[Limits and Margins](#)" on page 444.

Remote command:

`CALCulate<n>:LIMit<k>:LOWer:MARGin` on page 923

`CALCulate<n>:LIMit<k>:UPPer:MARGin` on page 927

### X-Axis

Describes the horizontal axis on which the data points of the limit line are defined.

Includes the following settings:

- Unit:
  - "Hz" : for frequency domain
  - "s" : for time domain
- Scaling mode: absolute or relative values  
For relative values, the frequencies are referred to the currently set center frequency. In the time domain, the left boundary of the diagram is used as the reference.
- Scaling: linear or logarithmic

Remote command:

`CALCulate<n>:LIMit<k>:LOWer:MODE` on page 923

`CALCulate<n>:LIMit<k>:UPPer:MODE` on page 927

`CALCulate<n>:LIMit<k>:CONTrol:DOMain` on page 921

`CALCulate<n>:LIMit<k>:CONTrol:SPACing` on page 922

### Y-Axis

Describes the vertical axis on which the data points of the limit line are defined.

Includes the following settings:

- Level unit
- Scaling mode: absolute or relative (dB/%) values  
Relative limit values refer to the reference level.
- Limit type: upper or lower limit; values must stay above the lower limit and below the upper limit to pass the limit check

Remote command:

`CALCulate<n>:LIMit<k>:UNIT` on page 926

`CALCulate<n>:LIMit<k>:LOWer:SPACing` on page 924

`CALCulate<n>:LIMit<k>:UPPer:SPACing` on page 928

### Data Points

Each limit line is defined by a minimum of 2 and a maximum of 200 data points. Each data point is defined by its position (x-axis) and value (y-value). Data points must be defined in ascending order. The same position can have two different values.

Remote command:

`CALCulate<n>:LIMit<k>:CONTRol[:DATA]` on page 920

`CALCulate<n>:LIMit<k>:LOWer[:DATA]` on page 923

`CALCulate<n>:LIMit<k>:UPPer[:DATA]` on page 926

### Insert Value

Inserts a data point in the limit line above the selected one in the "Edit Limit Line" dialog box.

### Delete Value

Deletes the selected data point in the "Edit Limit Line" dialog box.

### Shift x

Shifts the x-value of each data point horizontally by the defined shift width (as opposed to an additive offset defined for the entire limit line, see "X-Offset" on page 449).

Remote command:

`CALCulate<n>:LIMit<k>:CONTRol:SHIFt` on page 922

### Shift y

Shifts the y-value of each data point vertically by the defined shift width (as opposed to an additive offset defined for the entire limit line, see "Y-Offset" on page 450).

Remote command:

`CALCulate<n>:LIMit<k>:LOWer:SHIFt` on page 924

`CALCulate<n>:LIMit<k>:UPPer:SHIFt` on page 928

### Save

Saves the currently edited limit line under the name defined in the "Name" field.

### Import

Opens a file selection dialog box and loads the limit line from the selected file in .CSV format.

Note that a valid import file must contain a minimum of required information for the R&S FPS.

For details on the file format see [Chapter 8.4.2.4, "Reference: Limit Line File Format"](#), on page 458.

Remote command:

`MMEMorY:LOAD<n>:LIMit` on page 931

### Export

Opens a file selection dialog box and stores the currently displayed limit line to the defined file in .CSV format.

For details on the file format see [Chapter 8.4.2.4, "Reference: Limit Line File Format"](#), on page 458.

The limit line can be imported again later by the R&S FPS for use in other measurements.

Remote command:

`MMEMorY:STORE<n>:LIMit` on page 931

### 8.4.2.3 How to Define Limit Lines

**Access:** "Overview" > "Analysis" > "Lines" > "Limit Lines"

**or:** LINES > "Line Config" > "Limit Lines"



#### Limit lines for spurious and SEM measurements

Note that for spurious and SEM measurements, special limit lines can be defined for each frequency range, see [Chapter 6.5.4.2, "Limit Lines in SEM Measurements"](#), on page 211 and [Chapter 6.6.3.2, "Limit Lines in Spurious Measurements"](#), on page 251. It is strongly recommended that you define limits only via the "Sweep List" dialog for these measurements, not using the LINES key.

Any changes to the special limit lines are automatically overwritten when the sweep list settings are changed.

The following tasks are described here:

- ["How to find compatible limit lines"](#) on page 454
- ["How to activate and deactivate a limit check"](#) on page 454
- ["How to edit existing limit lines"](#) on page 455
- ["How to copy an existing limit line"](#) on page 455
- ["How to delete an existing limit line"](#) on page 455
- ["How to configure a new limit line"](#) on page 455
- ["How to move the limit line vertically or horizontally"](#) on page 456

#### How to find compatible limit lines

- ▶ In the "Line Config" dialog box, select the "View Filter" option: "Show Compatible". All stored limit lines with the file extension `.LIN` in the `limits` subfolder of the main installation folder of the instrument that are compatible to the current measurement settings are displayed in the overview.

#### How to activate and deactivate a limit check

A limit check is automatically performed as soon as any of the limit lines is activated.

1. To activate a limit check:  
Select the "Check Traces" setting for a limit line in the overview and select the trace numbers to be included in the limit check. One limit line can be assigned to several traces.  
  
The specified traces to be checked are compared with the active limit lines. The status of the limit check is indicated in the diagram.
2. To deactivate a limit line, deactivate all "Traces to be Checked" for it.  
To deactivate all limit lines at once, select the "Disable All Lines" button.  
  
The limit checks for the deactivated limit lines are stopped and the results are removed from the display.

### How to edit existing limit lines

Existing limit line configurations can be edited.

1. In the "Line Config" dialog box, select the limit line.
2. Select the "Edit" button.
3. Edit the line configuration as described in ["How to configure a new limit line"](#) on page 455.
4. Save the new configuration by selecting the "Save" button.

If the limit line is active, the edited limit line is displayed in the diagram.

### How to copy an existing limit line

1. In the dialog box, select the limit line.
2. Select the "Line Config" "Copy To" button.
3. Define a new name to create a new limit with the same configuration as the source line.
4. Edit the line configuration as described in ["How to configure a new limit line"](#) on page 455.
5. Save the new configuration by selecting the "Save" button.

The new limit line is displayed in the overview and can be activated.

### How to delete an existing limit line

1. In the "Line Config" dialog box, select the limit line.
2. Select the "Delete" button.
3. Confirm the message.

The limit line and the results of the limit check are deleted.

### How to configure a new limit line

1. In the "Line Config" dialog box, select the "New" button.  
The "Edit Limit Line" dialog box is displayed. The current line configuration is displayed in the preview area of the dialog box. The preview is updated after each change to the configuration.
2. Define a "Name" and, optionally, a "Comment" for the new limit line.
3. Define the x-axis configuration:
  - Time domain or frequency domain
  - Absolute or relative limits
  - Linear or logarithmic scaling
4. Define the y-axis configuration:
  - Level unit

- Absolute or relative limits
  - Upper or lower limit line
5. Define the data points: minimum 2, maximum 200:
    - a) Select "Insert Value" .
    - b) Define the x-value ( "Position" ) and y-value ( "Value" ) of the first data point.
    - c) Select "Insert Value" again and define the second data point.
    - d) Repeat this to insert all other data points.
      - To insert a data point before an existing one, select the data point and then "Insert Value" .
      - To insert a new data point at the end of the list, move the focus to the line after the last entry and then select "Insert Value" .
      - To delete a data point, select the entry and then "Delete Value" .
  6. Check the current line configuration in the preview area of the dialog box. If necessary, correct individual data points or add or delete some.  
If necessary, shift the entire line vertically or horizontally by selecting the "Shift x" or "Shift y" button and defining the shift width.
  7. Optionally, define a "Margin" at a fixed distance to the limit line.  
The margin must be within the valid value range and is not displayed in the diagram or preview area.
  8. Optionally, if the y-axis uses relative scaling, define an absolute "Threshold" as an additional criteria for a violation.
  9. Save the new configuration by selecting the "Save" button.  
The new limit line is displayed in the overview and can be activated.

#### **How to move the limit line vertically or horizontally**

A configured limit line can easily be moved vertically or horizontally. Thus, a new limit line can be easily generated based upon an existing limit line which has been shifted horizontally.

1. In the "Line Config" dialog box, select the limit line.
2. To shift the complete limit line parallel in the horizontal direction, select the "X-Offset" button and enter an offset value.  
To shift the complete limit line parallel in the vertical direction, select the "Y-Offset" button and enter an offset value.
3. To shift the individual data points of a limit line by a fixed value (all at once):
  - a) Select the "Edit" button.
  - b) In the "Edit Limit Line" dialog box, select the "Shift x" or "Shift y" button and define the shift width.
  - c) Save the shifted data points by selecting the "Save" button.

If activated, the limit line is shifted in the diagram.



### How to export a limit line

Limit line configurations can be stored to an ASCII file for evaluation in other programs or to be imported later for other measurements.

1. In the "Line Config" dialog box, select the limit line.
2. Select the "New" or "Edit" button.
3. Define the limit line as described in ["How to configure a new limit line"](#) on page 455.
4. Select "Export" to save the configuration to a file.

You are asked whether you would like to save the configuration internally on the R&S FPS first.

5. Select a file name and location for the limit line.
6. Select the decimal separator to be used in the file.
7. Select "Save" .

The limit line is stored to a file with the specified name and the extension `.CSV`. For details on the file format see [Chapter 8.4.2.4, "Reference: Limit Line File Format"](#), on page 458.

### How to import a limit line

Limit line configurations that are stored in an ASCII file and contain a minimum of required data can be imported to the R&S FPS.

For details on the required file format see [Chapter 8.4.2.4, "Reference: Limit Line File Format"](#), on page 458.

1. In the "Line Config" dialog box, select the limit line.
2. Select the "New" or "Edit" button.
3. Select "Import" to load a limit line from a file.

You are asked whether you would like to save the current configuration on the R&S FPS first.

4. Select the file name of the limit line.
5. Select the decimal separator that was used in the file.
6. Select "Select" .

The limit line is loaded from the specified file and displayed in the "Edit Limit Line" dialog box.

7. Activate the limit line as described in ["How to activate and deactivate a limit check"](#) on page 454.

#### 8.4.2.4 Reference: Limit Line File Format

Limit line data can be exported to a file in ASCII (CSV) format for further evaluation in other applications. Limit lines stored in the specified ASCII (CSV) format can also be imported to the R&S FPS for other measurements (see "[How to import a limit line](#)" on page 457). This reference describes in detail the format of the export/import files for limit lines. Note that the **bold** data is **mandatory**, all other data is optional.

Different language versions of evaluation programs may require a different handling of the decimal point. Thus, you can define the decimal separator to be used (see "[Decimal Separator](#)" on page 493).

**Table 8-2: ASCII file format for limit line files**

| File contents                                  | Description                                                                |
|------------------------------------------------|----------------------------------------------------------------------------|
| <b>Header data</b>                             |                                                                            |
| <b>sep=;</b>                                   | Separator for individual values (required by Microsoft Excel, for example) |
| <b>Type</b> ;RS_LimitLineDefinition;           | Type of data                                                               |
| <b>FileFormatVersion</b> ;1.00;                | File format version                                                        |
| Date;01.Oct 2006;                              | Date of data set storage                                                   |
| OptionID;SpectrumAnalyzer                      | Application the limit line was created for                                 |
| <b>Name</b> ;RELFREQ1                          | Limit line name                                                            |
| Comment;Defines the upper limit line           | Description of limit line                                                  |
| XAxisScaling;LINEAR                            | Scaling of x-axis linear (LIN) or logarithmic (LOG)                        |
| XAxisUnit;FREQ_HZ                              | Unit of x values                                                           |
| XAxisScaleMode;ABSOLUTE                        | Scaling of x-axis (absolute or relative)                                   |
| YAxisUnit;LEVEL_DB                             | Unit of y values                                                           |
| YAxisScaleMode;ABSOLUTE                        | Scaling of y-axis (absolute or relative)                                   |
| Mode;UPPER                                     | Type of limit line (upper, lower)                                          |
| ThresholdUnit;LEVEL_DBM                        | Unit of threshold value                                                    |
| ThresholdValue;-200                            | Threshold value                                                            |
| MarginValue;0                                  | Margin value                                                               |
| <b>NoOfPoints</b> ;5                           | Number of points the line is defined by                                    |
| <b>Data section for individual data points</b> |                                                                            |
| -4500000000;-50                                | <b>x- and y-values of each data point defining the line</b>                |
| -2000000000;-30                                |                                                                            |
| -1000000000;0                                  |                                                                            |
| 0;-30                                          |                                                                            |
| 2500000000;-50                                 |                                                                            |

## 8.5 Trace Configuration

A trace is a collection of measured data points. The trace settings determine how the measured data is analyzed and displayed on the screen.

- [Standard Traces](#).....459
- [Spectrograms](#).....471
- [Trace Math](#).....486

### 8.5.1 Standard Traces

#### 8.5.1.1 Basics on Setting up Traces

Some background knowledge on traces is provided here for a better understanding of the required configuration settings.

- [Mapping Samples to sweep Points with the Trace Detector](#).....459
- [Analyzing Several Traces - Trace Mode](#).....462
- [How Many Traces are Averaged - Sweep Count + Sweep Mode](#).....463
- [How Trace Data is Averaged - the Averaging Mode](#).....464
- [Trace Smoothing](#).....464

#### Mapping Samples to sweep Points with the Trace Detector

A trace displays the values measured at the sweep points. The number of samples taken during a sweep can be much larger than the number of sweep points that are displayed in the measurement trace.

#### Example:

Assume the following measurement parameters:

- Sample rate: 32 MSamples / s
- sweep points: 1000
- sweep time: 100 ms
- Span: 5 GHz

During a single sweep ,  $3.2 * 10^6$  samples are collected and distributed to 1000 sweep points, i.e. 3200 samples are collected per sweep point. For each sweep point, the measured data for a frequency span of 5 MHz ( $\text{span}/\langle \text{sweep points} \rangle$ ) is analyzed.

Note that if you increase the number of sweep points, the frequency span analyzed for each point in the trace decreases, making the result more stable.

See also [Chapter 7.5.1.8, "How Much Data is Measured: Sweep Points and Sweep Count"](#), on page 365.

Obviously, a data reduction must be performed to determine which of the samples are displayed for each sweep point. This is the trace detector's task.

The trace detector can analyze the measured data using various methods:



The detector activated for the specific trace is indicated in the corresponding trace information by an abbreviation.

**Table 8-3: Detector types**

| Detector      | Abbrev. | Description                                                                                                                                                                                                                                                                                                                                                                                                                                                                                                                                                                                                                                                                                                                                                                                        |
|---------------|---------|----------------------------------------------------------------------------------------------------------------------------------------------------------------------------------------------------------------------------------------------------------------------------------------------------------------------------------------------------------------------------------------------------------------------------------------------------------------------------------------------------------------------------------------------------------------------------------------------------------------------------------------------------------------------------------------------------------------------------------------------------------------------------------------------------|
| Positive Peak | Pk      | Determines the largest of all positive peak values of the levels measured at the individual frequencies which are displayed in one sample point                                                                                                                                                                                                                                                                                                                                                                                                                                                                                                                                                                                                                                                    |
| Negative Peak | Mi      | Determines the smallest of all negative peak values of the levels measured at the individual frequencies which are displayed in one sample point                                                                                                                                                                                                                                                                                                                                                                                                                                                                                                                                                                                                                                                   |
| Auto Peak     | Ap      | Combines the peak detectors; determines the maximum and the minimum value of the levels measured at the individual frequencies which are displayed in one sample point<br>(not available for SEM)                                                                                                                                                                                                                                                                                                                                                                                                                                                                                                                                                                                                  |
| RMS           | Rm      | Calculates the root mean square of all samples contained in a sweep point.<br>To this effect, R&S FPS uses the linear voltage after envelope detection. The sampled linear values are squared, summed and the sum is divided by the number of samples (= root mean square). For logarithmic display, the logarithm is formed from the square sum. For linear display, the root mean square value is displayed. Each sweep point thus corresponds to the power of the measured values summed up in the sweep point.<br><br>The RMS detector supplies the power of the signal irrespective of the waveform (CW carrier, modulated carrier, white noise or impulsive signal). Correction factors as needed for other detectors to measure the power of the different signal classes are not required. |
| Average       | Av      | Calculates the linear average of all samples contained in a sweep point.<br>To this effect, R&S FPS uses the linear voltage after envelope detection. The sampled linear values are summed up and the sum is divided by the number of samples (= linear average value). For logarithmic display, the logarithm is formed from the average value. For linear display, the average value is displayed. Each sweep point thus corresponds to the average of the measured values summed up in the sweep point.<br><br>The average detector supplies the average value of the signal irrespective of the waveform (CW carrier, modulated carrier, white noise or impulsive signal).                                                                                                                     |
| Sample        | Sa      | Selects the last measured value of the levels measured at the individual frequencies which are displayed in one sample point; all other measured values for the frequency range are ignored                                                                                                                                                                                                                                                                                                                                                                                                                                                                                                                                                                                                        |

The result obtained from the selected detector for a sweep point is displayed as the value at this frequency point in the trace.

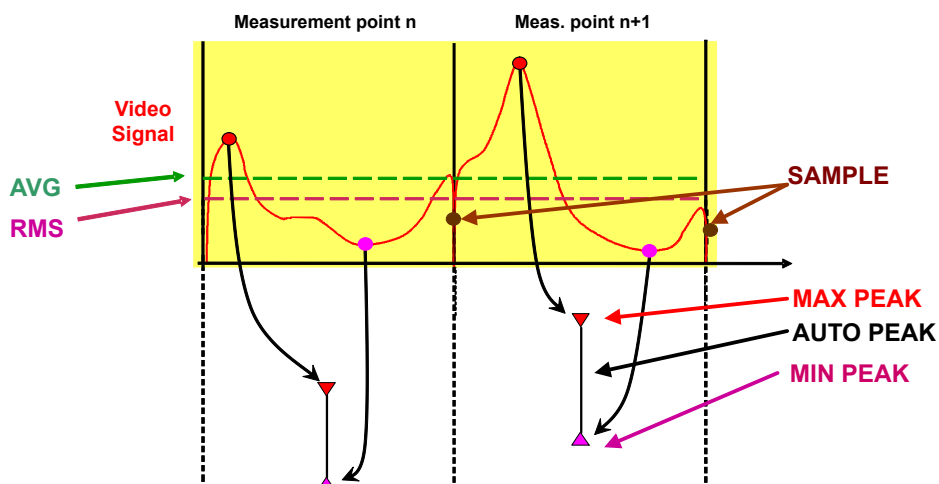

You can define the trace detector to be used for the individual traces manually, or the R&S FPS can select the appropriate detector automatically.

The detectors of the R&S FPS are implemented as pure digital devices. All detectors work in parallel in the background, which means that the measurement speed is independent of the detector combination used for different traces.



**RMS detector and VBW**

If the RMS detector is selected, the video bandwidth in the hardware is bypassed. Thus, duplicate trace averaging with small VBWs and RMS detector no longer occurs. However, the VBW is still considered when calculating the sweep time. This leads to a longer sweep time for small VBW values. Thus, you can reduce the VBW value to achieve more stable trace curves even when using an RMS detector. Normally, if the RMS detector is used, the sweep time should be increased to get more stable traces.

**Auto detector**

If the R&S FPS is set to define the appropriate detector automatically, the detector is set depending on the selected trace mode:

| Trace mode  | Detector      |
|-------------|---------------|
| Clear Write | Auto Peak     |
| Max Hold    | Positive Peak |
| Min Hold    | Negative Peak |
| Average     | Sample Peak   |
| View        | –             |
| Blank       | –             |

### Analyzing Several Traces - Trace Mode

If several sweep are performed one after the other, or continuous sweep are performed, the trace mode determines how the data for subsequent traces is processed. After each sweep , the trace mode determines whether:

- The data is frozen (View)
- The data is hidden (Blank)
- The data is replaced by new values (Clear Write)
- The data is replaced selectively (Max Hold, Min Hold, Average)



Each time the trace mode is changed, the selected trace memory is cleared.

The trace mode also determines the detector type if the detector is set automatically, see "[Mapping Samples to sweep Points with the Trace Detector](#)" on page 459.

The R&S FPS supports the following trace modes:

**Table 8-4: Overview of available trace modes**

| Trace Mode  | Description                                                                                                                                                                                                                                                                                                                                                                                                                                                                            |
|-------------|----------------------------------------------------------------------------------------------------------------------------------------------------------------------------------------------------------------------------------------------------------------------------------------------------------------------------------------------------------------------------------------------------------------------------------------------------------------------------------------|
| Blank       | Hides the selected trace.                                                                                                                                                                                                                                                                                                                                                                                                                                                              |
| Clear Write | Overwrite mode: the trace is overwritten by each sweep . This is the default setting. All available detectors can be selected.                                                                                                                                                                                                                                                                                                                                                         |
| Max Hold    | The maximum value is determined over several measurements and displayed. The R&S FPS saves the sweep result in the trace memory only if the new value is greater than the previous one.<br><br>This mode is especially useful with modulated or pulsed signals. The signal spectrum is filled up upon each sweep until all signal components are detected in a kind of envelope.<br><br>This mode is not available for statistics measurements.                                        |
| Min Hold    | The minimum value is determined from several measurements and displayed. The R&S FPS saves the sweep result in the trace memory only if the new value is lower than the previous one.<br><br>This mode is useful for example for making an unmodulated carrier in a composite signal visible. Noise, interference signals or modulated signals are suppressed, whereas a CW signal is recognized by its constant level.<br><br>This mode is not available for statistics measurements. |
| Average     | The average is formed over several measurements and displayed.<br><br>The <a href="#">Sweep/Average Count</a> determines the number of averaging procedures.<br><br>This mode is not available for statistics measurements.                                                                                                                                                                                                                                                            |
| View        | The current contents of the trace memory are frozen and displayed.                                                                                                                                                                                                                                                                                                                                                                                                                     |



If a trace is frozen ( "View" mode), the measurement settings, apart from scaling settings, can be changed without impact on the displayed trace. The fact that the displayed trace no longer matches the current measurement settings is indicated by a yellow asterisk \* on the tab label.

If you change any parameters that affect the scaling of the diagram axes, the R&S FPS automatically adapts the trace data to the changed display range. This allows you to zoom into the diagram after the measurement to show details of the trace.

### How Many Traces are Averaged - Sweep Count + Sweep Mode

In "Average" trace mode, the sweep count and sweep mode determine how many traces are averaged. The more traces are averaged, the smoother the trace is likely to become.

The algorithm for averaging traces depends on the sweep mode and sweep count.

- **sweep count = 0** (default)
  - In "**Continuous**" sweep mode, a continuous average is calculated for 10 sweep s, according to the following formula:

$$Trace = \frac{9 * Trace_{old} + MeasValue}{10}$$

Figure 8-11: Equation 1

Due to the weighting between the current trace and the average trace, past values have practically no influence on the displayed trace after about ten sweep s. With this setting, signal noise is effectively reduced without need for restarting the averaging process after a change of the signal.

- In "**Single**" sweep mode, the current trace is averaged with the previously stored averaged trace. No averaging is carried out for the first sweep but the measured value is stored in the trace memory. The next time a sweep is performed, the trace average is calculated according to the following formula:

$$Trace = \frac{Trace_{old} + MeasValue}{2}$$

The averaged trace is then stored in the trace memory.

- **sweep count = 1**  
The currently measured trace is displayed and stored in the trace memory. No averaging is performed.
- **sweep count > 1**  
For both "**Single**" sweep mode and "**Continuous**" sweep mode, averaging takes place over the selected number of sweep s. In this case the displayed trace is determined during averaging according to the following formula:

$$Trace_n = \frac{1}{n} \cdot \left[ \sum_{i=1}^{n-1} (T_i) + MeasValue_n \right]$$

Figure 8-12: Equation 2

Where n is the number of the current sweep (n = 2 ... Sweep Count).

No averaging is carried out for the first sweep but the measured value is stored in the trace memory. With increasing n, the displayed trace is increasingly smoothed since there are more individual sweep s for averaging.

After the selected number of sweep  $s$ , the average trace is saved in the trace memory. Until this number of sweep  $s$  is reached, a preliminary average is displayed. When the averaging length defined by the "Sweep Count" is attained, averaging is continued in continuous sweep mode or for "Continue Single Sweep" according to the following formula:

$$Trace = \frac{(N - 1) * Trace_{old} + MeasValue}{N}$$

Where  $N$  is the sweep count

### How Trace Data is Averaged - the Averaging Mode

When the trace is averaged over several sweeps (Trace mode: "Average" ), different methods are available to determine the trace average.

With logarithmic averaging, the dB values of the display voltage are averaged or subtracted from each other with trace mathematical functions.

With linear averaging, the level values in dB are converted into linear voltages or powers before averaging. Voltage or power values are averaged or offset against each other and reconverted into level values.

For stationary signals, the two methods yield the same result.

Logarithmic averaging is recommended if sinewave signals are to be clearly visible against noise since with this type of averaging noise suppression is improved while the sinewave signals remain unchanged.

For noise or pseudo-noise signals, the positive peak amplitudes are decreased in logarithmic averaging due to the characteristic involved. The negative peak values are increased relative to the average value. If the distorted amplitude distribution is averaged, a value is obtained that is smaller than the actual average value. The difference is -2.5 dB.

This low average value is usually corrected in noise power measurements by a 2.5 dB factor. Therefore the R&S FPS offers the selection of linear averaging. The trace data is linearized before averaging, then averaged and logarithmized again for display on the screen. The average value is always displayed correctly irrespective of the signal characteristic.

### Trace Smoothing

(Software-based) **smoothing** is a way to visually remove anomalies in the trace that may distort the results. The smoothing process is based on a moving average over the complete measurement range. The number of samples included in the averaging process (the *aperture* size) is variable and is a percentage of all samples that the trace consists of.



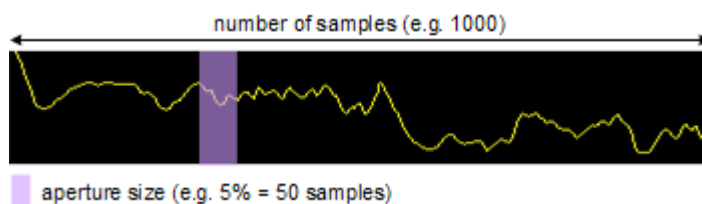

Figure 8-13: Sample size included in trace smoothing



### Effects of smoothing on post-processing functions

Note that in Spectrum mode, all functions performed after the sweep, such as limit checks, markers, or channel power measurements, are based on the smoothed trace data. Thus, the results differ from results based on the original trace.

You can turn trace smoothing on and off for all traces individually and compare, for example, the raw and the smooth trace.

Linear smoothing is based on the following algorithm:

$$y'(s) = \frac{1}{n} \left( \sum_{x=s-\frac{n-1}{2}}^{x=s+\frac{n-1}{2}} y(x) \right)$$

Equation 8-1: Linear trace smoothing

With:

s = sample number

x = sample offset from s

n = aperture size

#### 8.5.1.2 Trace Settings

**Access:** "Overview" > "Analysis" > "Traces"

Or: TRACE > "Trace Config"

You can configure the settings for up to 6 individual traces.

For settings on spectrograms, see [Chapter 8.5.2.2, "Spectrogram Settings"](#), on page 478.



Trace data can also be exported to an ASCII file for further analysis. For details see [Chapter 8.6.2, "Trace/Data Ex/Import"](#), on page 490.

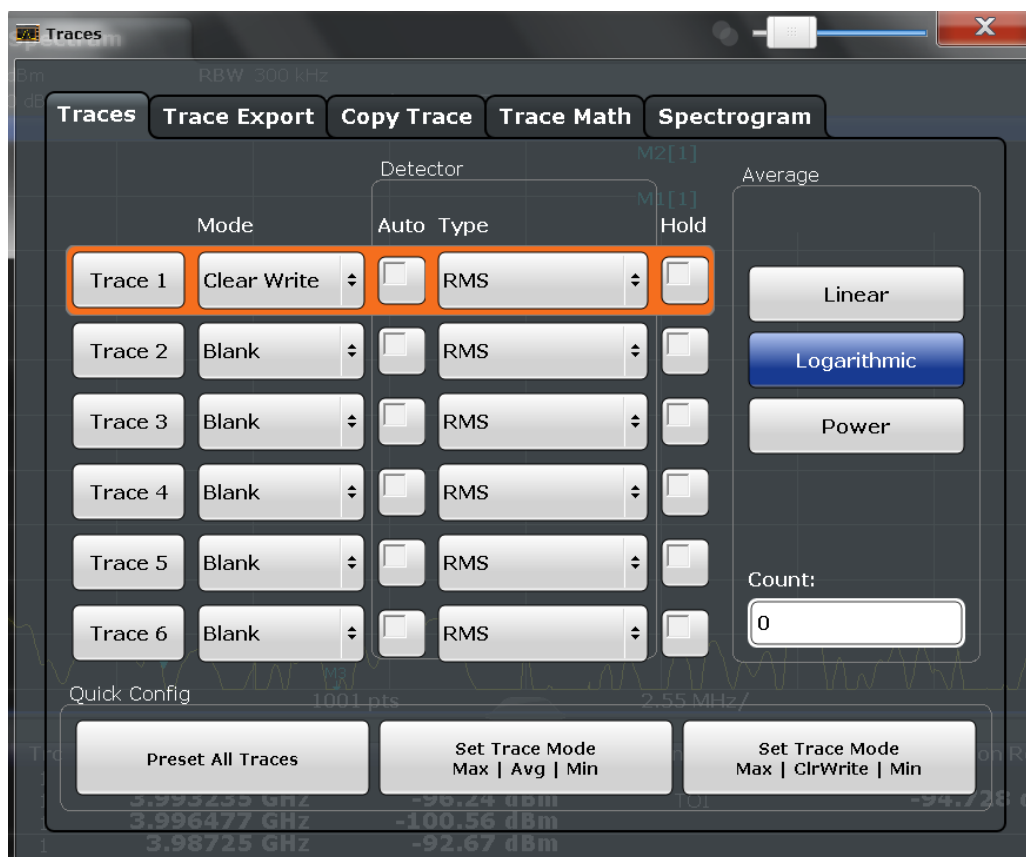

Trace 1 / Trace 2 / Trace 3 / Trace 4 / Trace 5 / Trace 6 ..... 466

Trace Mode ..... 466

Detector ..... 467

Hold ..... 467

Smoothing ..... 468

Average Mode ..... 468

Average Count ..... 468

Predefined Trace Settings - Quick Config ..... 469

Trace 1 / Trace 2 / Trace 3 / Trace 4 (Softkeys)..... 469

Copy Trace ..... 469

**Trace 1 / Trace 2 / Trace 3 / Trace 4 / Trace 5 / Trace 6**

Selects the corresponding trace for configuration. The currently selected trace is highlighted.

For details see [Chapter 8.5.1.3, "How to Configure a Standard Trace"](#), on page 470.

Remote command:

Selected via numeric suffix of:TRACe<1 . . . 6> commands

[DISPlay\[:WINDow<n>\]:TRACe<t>\[:STATe\]](#) on page 840

**Trace Mode**

Defines the update mode for subsequent traces.

For details, see ["Analyzing Several Traces - Trace Mode"](#) on page 462.

|                |                                                                                                                                                                                                                                                                                                              |
|----------------|--------------------------------------------------------------------------------------------------------------------------------------------------------------------------------------------------------------------------------------------------------------------------------------------------------------|
| "Clear/ Write" | Overwrite mode (default): the trace is overwritten by each sweep .<br>The "Detector" is automatically set to "Auto Peak" .                                                                                                                                                                                   |
| "Max Hold"     | The maximum value is determined over several sweep s and displayed. The R&S FPS saves each trace point in the trace memory only if the new value is greater than the previous one.<br>The "Detector" is automatically set to "PositivePeak" .<br>This mode is not available for statistics measurements.     |
| "Min Hold"     | The minimum value is determined from several measurements and displayed. The R&S FPS saves each trace point in the trace memory only if the new value is lower than the previous one.<br>The "Detector" is automatically set to "Negative Peak" .<br>This mode is not available for statistics measurements. |
| "Average"      | The average is formed over several sweep s.<br>The <a href="#">Sweep/Average Count</a> determines the number of averaging procedures.<br>The "Detector" is automatically set to "Sample" .<br>This mode is not available for statistics measurements.                                                        |
| "View"         | The current contents of the trace memory are frozen and displayed.                                                                                                                                                                                                                                           |
| "Blank"        | Removes the selected trace from the display.                                                                                                                                                                                                                                                                 |

Remote command:

[DISPlay\[:WINDow<n>\]:TRACe<t>:MODE](#) on page 838

### Detector

Defines the trace detector to be used for trace analysis.

For details see ["Mapping Samples to sweep Points with the Trace Detector"](#) on page 459.

"Auto" Selects the optimum detector for the selected trace and filter mode.  
This is the default setting.

"Type" Defines the selected detector type.

Remote command:

[\[SENSe:\] \[WINDow<n>:\] DETector<t>\[:FUNction\]](#) on page 842

[\[SENSe:\] \[WINDow<n>:\] DETector<t>\[:FUNction\]:AUTO](#) on page 843

### Hold

If activated, traces in "Min Hold" , "Max Hold" and "Average" mode are not reset after specific parameter changes have been made.

Normally, the measurement is started again after parameter changes, before the measurement results are analyzed (e.g. using a marker). In all cases that require a new measurement after parameter changes, the trace is reset automatically to avoid false results (e.g. with span changes). For applications that require no reset after parameter changes, the automatic reset can be switched off.

The default setting is off.

Remote command:

[DISPlay\[:WINDow<n>\]:TRACe<t>:MODE:HCONTinuous](#) on page 839

### Smoothing

If enabled, the trace is smoothed by the specified value (between 1 % and 50 %). The smoothing value is defined as a percentage of the display width. The larger the smoothing value, the greater the smoothing effect.

**Note:** Effects of smoothing on post-processing functions. Note that in Spectrum mode, all functions performed after the sweep, such as limit checks, markers, or channel power measurements, are based on the smoothed trace data. Thus, the results will differ from results based on the original trace.

For more information see ["Trace Smoothing"](#) on page 464.

Remote command:

`DISPlay[:WINDow<n>]:TRACe<t>:SMOothing[:STATe]` on page 841

`DISPlay[:WINDow<n>]:TRACe<t>:SMOothing:APERTure` on page 840

### Average Mode

Defines the mode with which the trace is averaged over several sweep s.

This setting is generally applicable if trace mode "Average" is selected. For FFT sweeps, the setting also affects the VBW (regardless of whether or not the trace is averaged).

(See also ["Video Bandwidth \(VBW\)"](#) on page 154).

How many sweep s are averaged is defined by the [" Sweep/Average Count "](#) on page 370.

For details see ["How Trace Data is Averaged - the Averaging Mode"](#) on page 464.

|               |                                                                                                                                                                                                                                                                                                                                                                                                        |
|---------------|--------------------------------------------------------------------------------------------------------------------------------------------------------------------------------------------------------------------------------------------------------------------------------------------------------------------------------------------------------------------------------------------------------|
| "Linear"      | The power level values are converted into linear units prior to averaging. After the averaging, the data is converted back into its original unit.                                                                                                                                                                                                                                                     |
| "Logarithmic" | For logarithmic scaling, the values are averaged in dBm. For linear scaling, the behavior is the same as with linear averaging.                                                                                                                                                                                                                                                                        |
| "Power"       | Activates linear power averaging.<br>The power level values are converted into unit Watt prior to averaging. After the averaging, the data is converted back into its original unit.<br>Use this mode to average power values in Volts or Amperes correctly.<br>In particular, for small VBW values (smaller than the RBW), use power averaging mode for correct power measurements in FFT sweep mode. |

Remote command:

`[SENSe:]AVERAge<n>:TYPE` on page 842

### Average Count

Determines the number of averaging or maximum search procedures If the trace modes "Average" , "Max Hold" or "Min Hold" are set.

In continuous sweep mode, if sweep count = 0 (default), averaging is performed over 10 sweep s. For sweep count =1, no averaging, Max Hold or Min Hold operations are performed.

This value is identical to the [Sweep/Average Count](#) setting in the "Sweep" settings.

Remote command:

[SENSe:] AVERage<n>:COUNT on page 841

### Predefined Trace Settings - Quick Config

Commonly required trace settings have been predefined and can be applied very quickly by selecting the appropriate button.

| Function                               | Trace Settings |                                           |
|----------------------------------------|----------------|-------------------------------------------|
| Preset All Traces                      | Trace 1:       | Clear Write<br>Auto Detector (Auto Peak)  |
|                                        | Traces 2-6:    | Blank<br>Auto Detector                    |
| Set Trace Mode<br>Max   Avg   Min      | Trace 1:       | Max Hold<br>Auto Detector (Positive Peak) |
|                                        | Trace 2:       | Average<br>Auto Detector (Sample)         |
|                                        | Trace 3:       | Min Hold<br>Auto Detector (Negative Peak) |
|                                        | Traces 4-6:    | Blank<br>Auto Detector                    |
| Set Trace Mode<br>Max   ClrWrite   Min | Trace 1:       | Max Hold<br>Auto Detector (Positive Peak) |
|                                        | Trace 2:       | Clear Write<br>Auto Detector (Auto Peak)  |
|                                        | Trace 3:       | Min Hold<br>Auto Detector (Negative Peak) |
|                                        | Traces 4-6:    | Blank<br>Auto Detector                    |

### Trace 1 / Trace 2 / Trace 3 / Trace 4 (Softkeys)

Displays the "Traces" settings and focuses the "Mode" list for the selected trace.

For details see [Chapter 8.5.1.3, "How to Configure a Standard Trace"](#), on page 470.

Remote command:

DISPlay[:WINDow<n>]:TRACe<t>[:STATe] on page 840

### Copy Trace

**Access:** "Overview" > "Analysis" > "Traces" > "Copy Trace"

Or: TRACE > "Copy Trace"

Copies trace data to another trace.

The first group of buttons (labeled "Trace 1" to "Trace 6") selects the source trace. The second group of buttons (labeled "Copy to Trace 1" to "Copy to Trace 6") selects the destination.

Remote command:

TRACe<n>:COPY on page 843

### 8.5.1.3 How to Configure a Standard Trace

Step-by-step instructions on configuring the trace settings are provided here.

For details on individual functions and settings see [Chapter 8.5.1.2, "Trace Settings"](#), on page 465.

Trace settings are configured in the "Traces" dialog box.

To display the "Traces" dialog box, do one of the following:

- Press the TRACE key and then select the "Trace Config" softkey.
  - Select "Analysis" from the "Overview" , then select the "Traces" tab.
1. For each trace, select the "Trace Mode" and "Trace Detector" . Traces with the trace mode "Blank" are not displayed.
  2. To configure several traces to predefined display modes in one step, press the button for the required function:
    - "Preset All Traces"
    - "Set Trace Mode Max | Avg | Min"
    - "Set Trace Mode Max | ClrWrite | Min"

For details see [Chapter 8.5.1.2, "Trace Settings"](#), on page 465.

3. For "Average" trace mode, define the number of sweep s to be averaged in the "Count:" field.
4. If linear scaling is used, select the "Average Mode" : "Linear" .
5. To improve the trace stability, increase the number of "Sweep Points" or the "Sweep Time" (in the "Sweep" settings).

All configured traces (not set to "Blank" ) are displayed after the next sweep .

#### How to Copy Traces

1. A trace copy function is provided in a separate tab of the "Traces" dialog box. To display this tab do one of the following:
  - Select the TRACE key and then the "Trace Copy" softkey.
  - Select "Analysis" from the "Overview" , then select the "Trace Copy" tab.
2. Select the "Source" trace to be copied.
3. Select the "Copy to Trace" button for the trace to which the settings are to be applied.

The settings from the source trace are applied to the destination trace. The newly configured trace (if not set to "Blank" ) is displayed after the next sweep .

### 8.5.1.4 How to Copy Traces

You can copy the trace settings from one trace to another in the "Copy Trace" tab of the "Traces" dialog box.

- ▶ Select the "Source" trace and then the button for the "Copy To" trace.

**Remote command:**

TRACe<n>:COPY on page 843

## 8.5.2 Spectrograms

### 8.5.2.1 Working with Spectrograms

In addition to the standard "level versus frequency" or "level versus time" traces, the R&S FPS also provides a spectrogram display of the measured data.

A spectrogram shows how the spectral density of a signal varies over time. The x-axis shows the frequency, the y-axis shows the time. A third dimension, the power level, is indicated by different colors. Thus you can see how the strength of the signal varies over time for different frequencies.

**Example:**

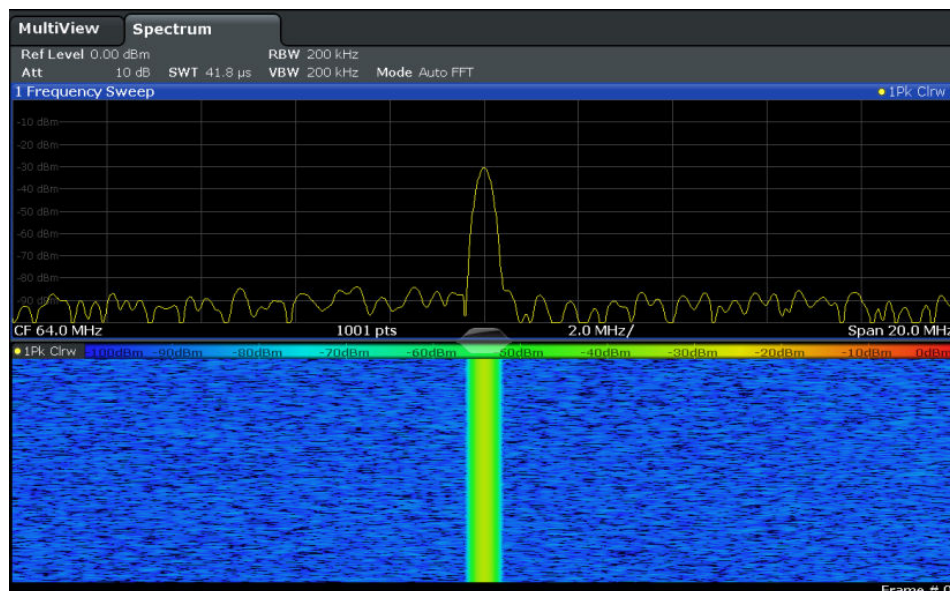

In this example, you see the spectrogram for the calibration signal of the R&S FPS, compared to the standard spectrum display. Since the signal does not change over time, the color of the frequency levels does not change over time, i.e. vertically. The legend above the spectrogram display describes the power levels the colors represent.

**Result display**

The spectrogram result can consist of the following elements:

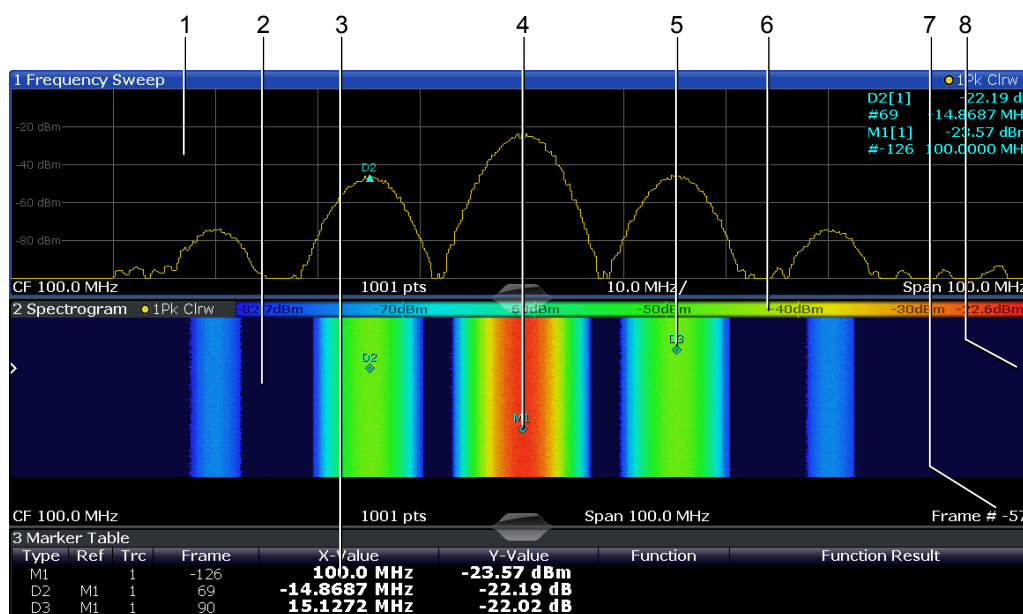

**Figure 8-14: Screen layout of the spectrogram result display**

- 1 = Spectrum result display
- 2 = Spectrogram result display
- 3 = Marker list
- 4 = Marker
- 5 = Delta marker
- 6 = Color map
- 7 = Timestamp / frame number
- 8 = Current frame indicator

For more information about spectrogram configuration, see [Chapter 8.5.2.2, "Spectrogram Settings"](#), on page 478.

**Remote commands:**

Activating and configuring spectrograms:

[Chapter 12.8.2.2, "Configuring Spectrograms"](#), on page 844

Storing results:

`MMEMoRY:STORe<n>:SPECTrogram` on page 965

- [Time Frames](#).....472
- [Color Maps](#).....474
- [Markers in the Spectrogram](#).....477

**Time Frames**

The time information in the spectrogram is displayed vertically, along the y-axis. Each line (or trace) of the y-axis represents one or more captured sweep and is called a



**time frame** or simply "frame". As with standard spectrum traces, several measured values are combined in one sweep point using the selected detector.

(See "[Mapping Samples to sweep Points with the Trace Detector](#)" on page 459).

Frames are sorted in chronological order, beginning with the most recently recorded frame at the top of the diagram (frame number 0). With the next sweep, the previous frame is moved further down in the diagram, until the maximum number of captured frames is reached. The display is updated continuously during the measurement, and the measured trace data is stored. Spectrogram displays are continued even after single measurements unless they are cleared manually.

The maximum number of frames that you can capture is summarized in [Table 8-5](#).

**Table 8-5: Correlation between number of sweep points and number of frames stored in the history buffer**

| Sweep Points | Max. History Depth |
|--------------|--------------------|
| ≤1250        | 20000              |
| 2001         | 12488              |
| 4001         | 6247               |
| 8.001        | 3124               |
| 16.001       | 1562               |
| 32.001       | 781                |



The scaling of the time axis (y-axis) is not configurable. However, you can enlarge the spectrogram display by maximizing the window using the "Split/Maximize" key.



### Frame analysis - Frame count vs. sweep count

As described for standard spectrum sweeps, the sweep count defines how many sweeps are analyzed to create a single trace. Thus, for a trace in "Average" mode, for example, a sweep count of 10 means that 10 sweeps are averaged to create a single trace, or frame.

The frame count, on the other hand, determines how many frames are plotted during a single sweep measurement (as opposed to a continuous sweep). For a frame count of 2, for example, 2 frames will be plotted during each single sweep. For continuous sweep mode, the frame count is irrelevant; one frame is plotted per sweep until the measurement is stopped.

If you combine the two settings, 20 sweeps will be performed for each single sweep measurement. The first 10 will be averaged to create the first frame, the next 10 will be averaged to create the second frame.

As you can see, increasing the sweep count increases the accuracy of the individual traces, while increasing the frame count increases the number of traces in the diagram.

Especially for "Average" or "Min Hold" and "Max Hold" trace modes, the number of sweeps that are analyzed to create a single trace has an effect on the accuracy of the results. Thus, you can also define whether the results from frames in previous traces are considered in the analysis for each new trace ("Continue Frame").

### Tracking absolute time - timestamps

Alternatively to the frame count, the absolute time (that is: a *timestamp*) at which a frame was captured can be displayed. While the measurement is running, the timestamp shows the system time. In single sweep mode or if the sweep is stopped, the timestamp shows the time and date at the end of the sweep. Thus, the individual frames can be identified by their timestamp or their frame count.

When active, the timestamp replaces the display of the frame number in the diagram footer (see [Figure 8-14](#)).

### Displaying individual frames

The spectrogram diagram contains all stored frames since it was last cleared. Arrows on the left and right border of the spectrogram indicate the currently selected frame. The spectrum diagram always displays the spectrum for the currently selected frame.

The current frame number is indicated in the diagram footer, or alternatively a timestamp, if activated. The current frame, displayed at the top of the diagram, is frame number 0. Older frames further down in the diagram are indicated by a negative index, e.g. "-10". You can display the spectrum diagram of a previous frame by changing the current frame number.

### Color Maps

Spectrograms assign power levels to different colors to visualize them. The legend above the spectrogram display describes the power levels the colors represent.

The color display is highly configurable to adapt the spectrograms to your needs. You can define:

- Which colors to use (Color scheme)
- Which value range to apply the color scheme to
- How the colors are distributed within the value range, i.e. where the focus of the visualization lies (shape of the color curve)

The individual colors are assigned to the power levels automatically by the R&S FPS.

### The Color Scheme

- **Hot**



Uses a color range from blue to red. Blue colors indicate low levels, red colors indicate high ones.

- **Cold**



Uses a color range from red to blue. Red colors indicate low levels, blue colors indicate high ones.

The "Cold" color scheme is the inverse "Hot" color scheme.

- **Radar**



Uses a color range from black over green to light turquoise with shades of green in between. Dark colors indicate low levels, light colors indicate high ones.

- **Grayscale**



Shows the results in shades of gray. Dark gray indicates low levels, light gray indicates high ones.

### The Value Range of the Color Map

If the measured values only cover a small area in the spectrogram, you can optimize the displayed value range so it becomes easier to distinguish between values that are close together. Display only parts of interest.

### The Shape and Focus of the Color Curve

The color mapping function assigns a specified color to a specified power level in the spectrogram display. By default, colors on the color map are distributed evenly. However, to visualize a certain area of the value range in greater detail than the rest, you can set the focus of the color mapping to that area. Changing the focus is performed by changing the shape of the color curve.

The color curve is a tool to shift the focus of the color distribution on the color map. By default, the color curve is linear. If you shift the curve to the left or right, the distribution becomes non-linear. The slope of the color curve increases or decreases. One end of the color palette then covers a large range of results, while the other end distributes several colors over a relatively small result range.

You can use this feature to put the focus on a particular region in the diagram and to be able to detect small variations of the signal.

**Example:**

In the color map based on the linear color curve, the range from -100 dBm to -60 dBm is covered by blue and a few shades of green only. The range from -60 dBm to -20 dBm is covered by red, yellow and a few shades of green.

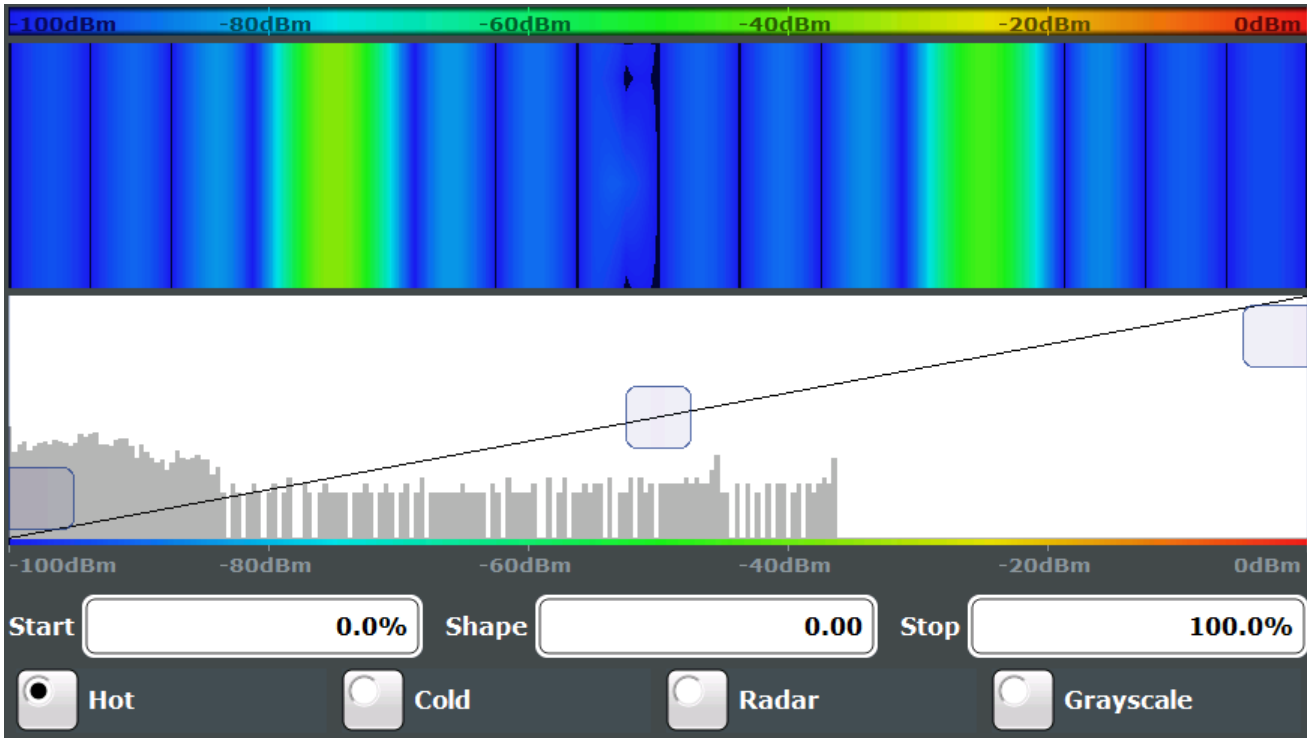

*Figure 8-15: Spectrogram with (default) linear color curve shape = 0*

The sample spectrogram is dominated by blue and green colors. After shifting the color curve to the left (negative value), more colors cover the range from -100 dBm to -60 dBm (blue, green and yellow). This range occurs more often in the example. The range from -60 dBm to -20 dBm, on the other hand, is dominated by various shades of red only.

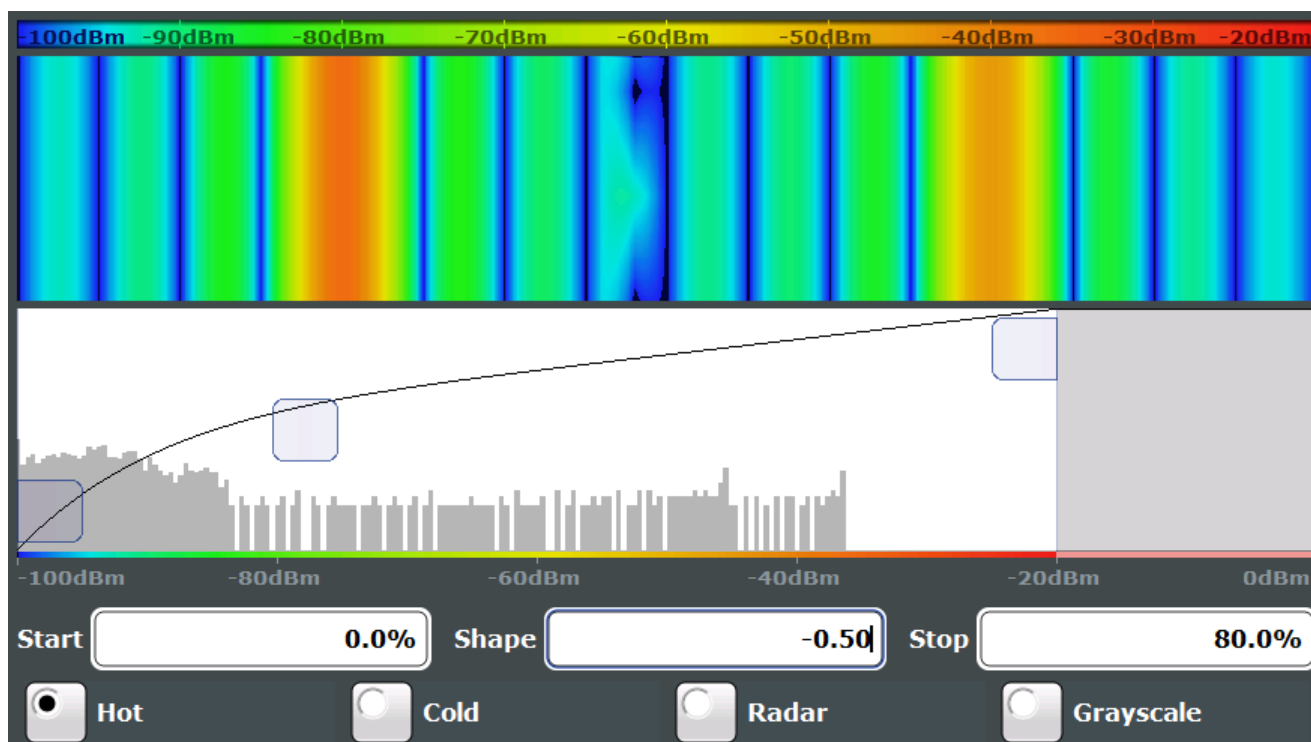
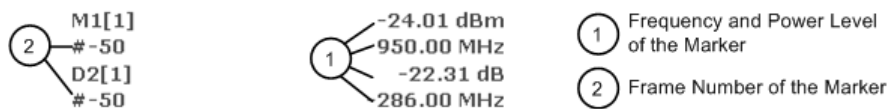

Figure 8-16: Spectrogram with non-linear color curve (shape = -0.5)

### Markers in the Spectrogram

Markers and delta markers are shaped like diamonds in the spectrogram. They are only displayed in the spectrogram if the marker position is inside the visible area of the spectrogram. If more than two markers are active, the marker values are displayed in a separate marker table.

In the spectrum result display, the markers and their frequency and level values (1) are displayed as usual. Additionally, the frame number is displayed to indicate the position of the marker in time (2).



In the spectrogram result display, you can activate up to 16 markers or delta markers at the same time. Each marker can be assigned to a different frame. Therefore, in addition to the frequency you also define the frame number when activating a new marker. If no frame number is specified, the marker is positioned on the currently selected frame. All markers are visible that are positioned on a visible frame. Special search functions are provided for spectrogram markers.

In the spectrum result display, only the markers positioned on the currently selected frame are visible. In "Continuous Sweep" mode, this means that only markers positioned on frame 0 are visible. To view markers that are positioned on a frame other than frame 0 in the spectrum result display, you must stop the measurement and select the corresponding frame.

### 8.5.2.2 Spectrogram Settings

**Access:** TRACE > "Spectrogram Config"

The individual settings available for spectrogram display are described here. For settings on color mapping, see "Color Map Settings" on page 480.

Settings concerning the frames and how they are handled during a sweep are provided as additional sweep settings for spectrogram display.

See Chapter 7.5, "Bandwidth, Filter and Sweep Configuration", on page 360.

Search functions for spectrogram markers are described in Chapter 8.3.3.2, "Marker Search Settings for Spectrograms", on page 416.

- [General Spectrogram Settings](#).....478
- [Color Map Settings](#).....480

#### General Spectrogram Settings

**Access:** TRACE > "Spectrogram Config"

This section describes general settings for spectrogram display.

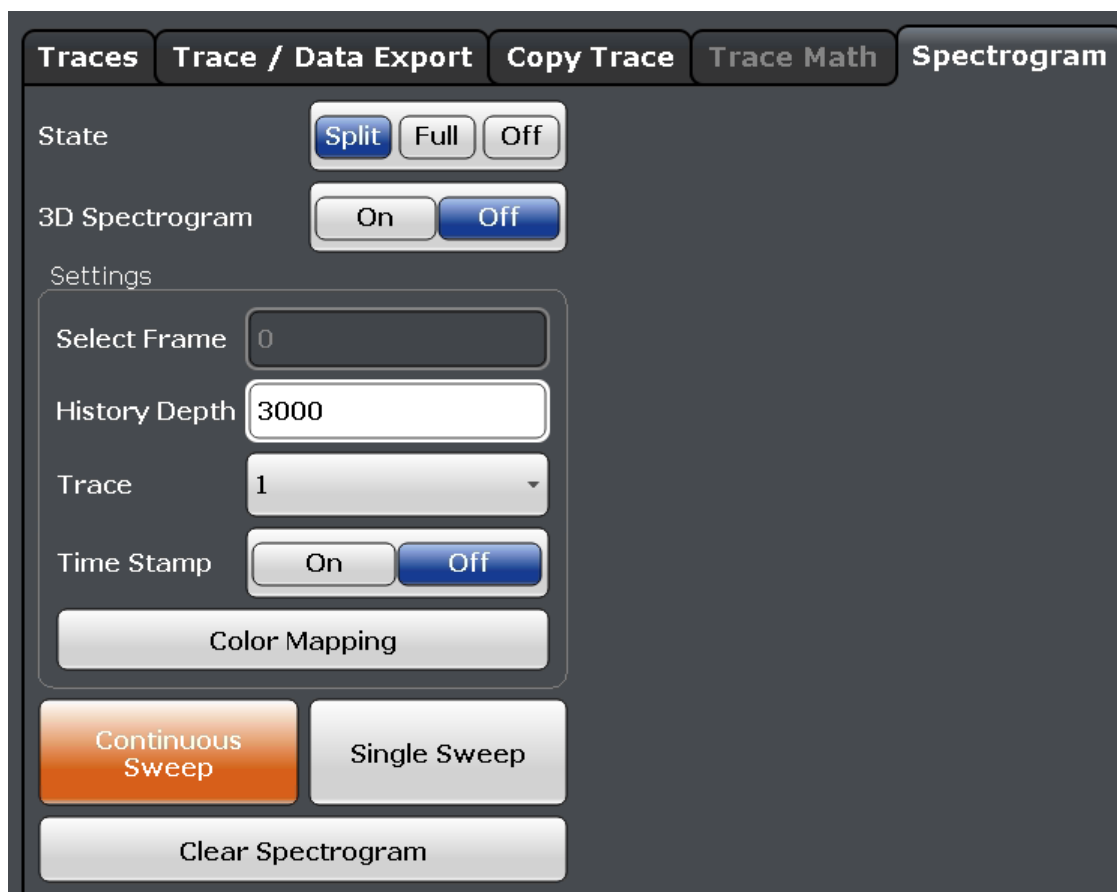

|                                     |     |
|-------------------------------------|-----|
| <a href="#">State</a> .....         | 479 |
| <a href="#">Select Frame</a> .....  | 479 |
| <a href="#">History Depth</a> ..... | 479 |

|                                   |     |
|-----------------------------------|-----|
| Time Stamp .....                  | 479 |
| Color Mapping .....               | 480 |
| Continuous Sweep / Run Cont ..... | 480 |
| Single Sweep / Run Single .....   | 480 |
| Clear Spectrogram .....           | 480 |

### State

Activates and deactivates a Spectrogram subwindow.

|         |                                                                                          |
|---------|------------------------------------------------------------------------------------------|
| "Split" | Displays the Spectrogram as a subwindow in the original result display.                  |
| "Full"  | Displays the Spectrogram in a subwindow in the full size of the original result display. |
| "Off"   | Closes the Spectrogram subwindow.                                                        |

Remote command:

`CALCulate<n>:SPECTrogram:LAYout` on page 847

### Select Frame

Selects a specific frame, loads the corresponding trace from the memory, and displays it in the Spectrum window.

Note that activating a marker or changing the position of the active marker automatically selects the frame that belongs to that marker.

This function is only available in single sweep mode or if the sweep is stopped, and only if a spectrogram is selected.

The most recent frame is number 0, all previous frames have a negative number.

For more details see "Time Frames" on page 472.

Remote command:

`CALCulate<n>:SPECTrogram:FRAMe:SElect` on page 846

### History Depth

Sets the number of frames that the R&S FPS stores in its memory.

The maximum number of frames depends on the [Sweep Points](#).

If the memory is full, the R&S FPS deletes the oldest frames stored in the memory and replaces them with the new data.

Remote command:

`CALCulate<n>:SPECTrogram:HDEPth` on page 846

### Time Stamp

Activates and deactivates the timestamp. The timestamp shows the system time while the measurement is running. In single sweep mode or if the sweep is stopped, the timestamp shows the time and date of the end of the sweep .

When active, the timestamp replaces the display of the frame number.

Remote command:

`CALCulate<n>:SPECTrogram:TSTamp[:STATe]` on page 848

`CALCulate<n>:SPECTrogram:TSTamp:DATA?` on page 847

### Color Mapping

Opens the "Color Mapping" dialog.

For details see ["Color Maps"](#) on page 474.

### Continuous Sweep / Run Cont

After triggering, starts the measurement and repeats it continuously until stopped.

While the measurement is running, the "Continuous Sweep" softkey and the RUN CONT key are highlighted. The running measurement can be aborted by selecting the highlighted softkey or key again. The results are not deleted until a new measurement is started.

**Note:** Sequencer. If the Sequencer is active, the "Continuous Sweep" softkey only controls the sweep mode for the currently selected channel. However, the sweep mode only takes effect the next time the Sequencer activates that channel, and only for a channel-defined sequence. In this case, a channel in continuous sweep mode is swept repeatedly.

Furthermore, the RUN CONT key controls the Sequencer, not individual sweeps. RUN CONT starts the Sequencer in continuous mode.

For details on the Sequencer, see [Chapter 5.4.1, "The Sequencer Concept"](#), on page 119.

Remote command:

`INITiate<n>:CONTInuous` on page 635

### Single Sweep / Run Single

After triggering, starts the number of sweeps set in "Sweep Count". The measurement stops after the defined number of sweeps has been performed.

While the measurement is running, the "Single Sweep" softkey and the RUN SINGLE key are highlighted. The running measurement can be aborted by selecting the highlighted softkey or key again.

Remote command:

`INITiate<n>[:IMMediate]` on page 636

`CALCulate<n>:SPECTrogram:CONTInuous` on page 845

### Clear Spectrogram

Resets the spectrogram result display and clears the history buffer.

This function is only available if a spectrogram is selected.

Remote command:

`CALCulate<n>:SPECTrogram:CLEar[:IMMediate]` on page 844

### Color Map Settings

**Access:** "Overview" > "Analysis" > "Traces" > "Spectrogram" > "Color Mapping"

**or:** TRACE > "Spectrogram Config" > "Color Mapping"

For more information on color maps see ["Color Maps"](#) on page 474. For details on changing color mapping settings see ["How to Configure the Color Mapping"](#) on page 484.



In addition to the available color settings, the dialog box displays the current color map and provides a preview of the display with the current settings.

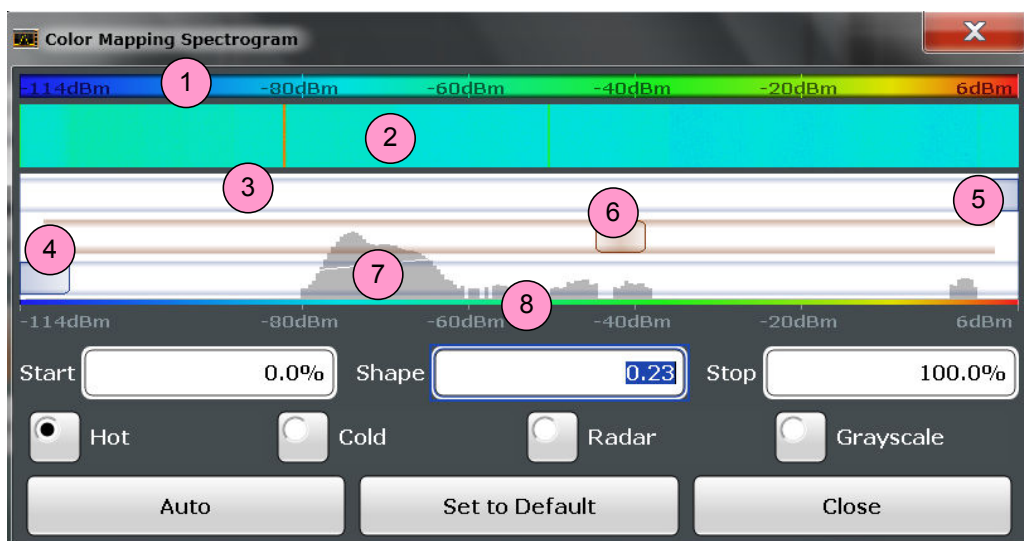

**Figure 8-17: Color Mapping dialog box**

- 1 = Color map: shows the current color distribution
- 2 = Preview pane: shows a preview of the spectrogram with any changes that you make to the color scheme
- 3 = Color curve pane: graphical representation of all settings available to customize the color scheme
- 4/5 = Color range start and stop sliders: define the range of the color map or amplitudes for the spectrogram
- 6 = Color curve slider: adjusts the focus of the color curve
- 7 = Histogram: shows the distribution of measured values
- 8 = Scale of the horizontal axis (value range)

### Start / Stop

Defines the lower and upper boundaries of the value range of the spectrogram.

Remote command:

[DISPlay\[:WINDow<n>\]:SPECTrogram:COLor:LOWer](#) on page 849

[DISPlay\[:WINDow<n>\]:SPECTrogram:COLor:UPPer](#) on page 850

### Shape

Defines the shape and focus of the color curve for the spectrogram result display.

"-1 to <0" More colors are distributed among the lower values

"0" Colors are distributed linearly among the values

">0 to 1" More colors are distributed among the higher values

Remote command:

[DISPlay\[:WINDow<n>\]:SPECTrogram:COLor:SHApe](#) on page 849

### Hot / Cold / Radar / Grayscale

Sets the color scheme for the spectrogram.

Remote command:

[DISPlay\[:WINDow<n>\]:SPECTrogram:COLor\[:STYLE\]](#) on page 850

**Auto**

Defines the color range automatically according to the existing measured values for optimized display.

**Set to Default**

Sets the color mapping to the default settings.

Remote command:

`DISPlay[:WINDow<n>]:SPECTrogram:COLor:DEFault` on page 849

**Close**

Saves the changes and closes the dialog box.

### 8.5.2.3 How to Display and Configure a Spectrogram

Step-by-step instructions on how to display and configure a spectrogram are provided here. For details on individual functions and settings see [Chapter 8.5.2.2, "Spectrogram Settings"](#), on page 478.

The remote commands required to perform these tasks are described in [Chapter 12.8.2.2, "Configuring Spectrograms"](#), on page 844.

The following tasks are described here:

- ["To display a spectrogram"](#) on page 482
- ["To remove the spectrogram display"](#) on page 483
- ["To set a marker in the spectrogram"](#) on page 483
- ["To configure a spectrogram"](#) on page 483
- ["To select a color scheme"](#) on page 484
- ["To set the value range graphically using the color range sliders"](#) on page 484
- ["To set the value range of the color map numerically"](#) on page 485
- ["To set the color curve shape graphically using the slider"](#) on page 486
- ["To set the color curve shape numerically"](#) on page 486

**To display a spectrogram**

1. In the "Overview", select "Display", then drag the evaluation type "Spectrogram" to the diagram area.  
Alternatively:
  - a) Select the TRACE key and then the "Spectrogram Config" softkey.
  - b) Toggle "Spectrogram" to "On" .
2. To clear an existing spectrogram display, select "Clear Spectrogram" .
3. Start a new measurement using RUN SINGLE or RUN CONT.  
The spectrogram is updated continuously with each new sweep.
4. To display the spectrum diagram for a specific time frame:
  - a) Stop the continuous measurement or wait until the single sweep is completed.
  - b) Select the frame number in the diagram footer.

- c) Enter the required frame number in the edit dialog box.  
Note that the most recent sweep is frame number 0, all previous frames have negative numbers.

#### To remove the spectrogram display

1. Select the TRACE key and then the "Spectrogram Config" softkey.
2. Toggle "Spectrogram" to "Off" .

The standard spectrum display is restored.

#### To set a marker in the spectrogram

1. While a spectrogram is displayed, select the MARKER key.
2. Select a "Marker" softkey.
3. Enter the frequency or time (x-value) of the marker or delta marker.
4. Enter the frame number for which the marker is to be set, for example 0 for the current frame, or -2 for the second to last frame. Note that the frame number is always 0 or a negative value!

The marker is only visible in the spectrum diagram if it is defined for the currently selected frame. In the spectrogram result display all markers are visible that are positioned on a visible frame.

#### To configure a spectrogram

1. Configure the spectrogram frames:
  - a) Select the SWEEP key.
  - b) Select the "Sweep Config" softkey.
  - c) In the "Sweep/Average Count" field, define how many sweeps are to be analyzed to create a single frame.
  - d) In the "Frame Count" field, define how many frames are to be plotted during a single sweep measurement.
  - e) To include frames from previous sweeps in the analysis of the new frame (for "Max Hold" , "Min Hold" and "Average" trace modes only), select "Continue Frame" = "On" .
2. Define how many frames are to be stored in total:
  - a) Select the TRACE key and then the "Spectrogram Config" softkey.
  - b) Select the "History Depth" softkey.
  - c) Enter the maximum number of frames to store.
3. Optionally, replace the frame number by a time stamp by toggling the "Time Stamp" softkey to "On" .
4. If necessary, adapt the color mapping for the spectrogram to a different value range or color scheme as described in ["How to Configure the Color Mapping"](#) on page 484.

### How to Configure the Color Mapping

The color display is highly configurable to adapt the spectrogram to your needs.

The settings for color mapping are defined in the "Color Mapping" dialog box. To display this dialog box, do one of the following:

- Select the color map in the window title bar of the Spectrogram result display.
- Select the "Color Mapping" softkey in the "Spectrogram" menu.

#### To select a color scheme

You can select which colors are assigned to the measured values.

- ▶ In the "Color Mapping" dialog box, select the option for the color scheme to be used.

#### Editing the value range of the color map

The distribution of the measured values is displayed as a histogram in the "Color Mapping" dialog box. To cover the entire measurement value range, make sure the first and last bar of the histogram are included.

To ignore noise in a spectrogram, for example, exclude the lower power levels from the histogram.



The value range of the color map must cover at least 10% of the value range on the horizontal axis of the diagram, that means, the difference between the start and stop values must be at least 10%.

The value range of the color map can be set numerically or graphically.

#### To set the value range graphically using the color range sliders

1. Select and drag the bottom color curve slider (indicated by a gray box at the left of the color curve pane) to the lowest value you want to include in the color mapping.
2. Select and drag the top color curve slider (indicated by a gray box at the right of the color curve pane) to the highest value you want to include in the color mapping.

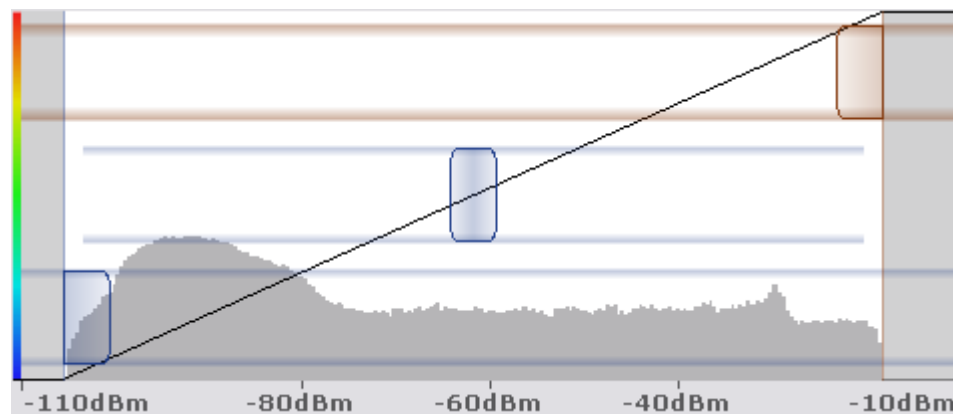

**To set the value range of the color map numerically**

1. In the "Start" field, enter the percentage from the left border of the histogram that marks the beginning of the value range.
2. In the "Stop" field, enter the percentage from the right border of the histogram that marks the end of the value range.

**Example:**

The color map starts at -110 dBm and ends at -10 dBm (that is: a range of 100 dB). In order to suppress the noise, you only want the color map to start at -90 dBm. Thus, you enter 10% in the "Start" field. The R&S FPS shifts the start point 10% to the right, to -90 dBm.

**Adjusting the reference level and level range**

Since the color map is configured using percentages of the total value range, changing the reference level and level range of the measurement (and thus the power value range) also affects the color mapping in the spectrogram.

---

**Editing the shape of the color curve**

The color curve is a tool to shift the focus of the color distribution on the color map. By default, the color curve is linear, i.e. the colors on the color map are distributed evenly. If you shift the curve to the left or right, the distribution becomes non-linear. The slope of the color curve increases or decreases. One end of the color palette then covers a large number of results, while the other end distributes several colors over a relatively small result range.

The color curve shape can be set numerically or graphically.

### To set the color curve shape graphically using the slider

- ▶ Select and drag the color curve shape slider (indicated by a gray box in the middle of the color curve) to the left or right. The area beneath the slider is focused, i.e. more colors are distributed there.

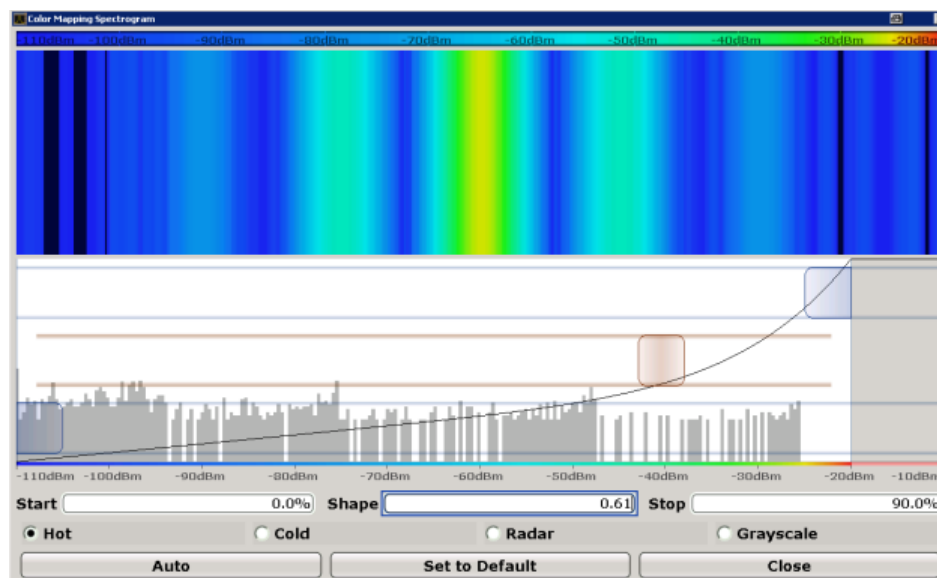

### To set the color curve shape numerically

- ▶ In the "Shape" field, enter a value to change the shape of the curve:
  - A negative value ( $-1$  to  $<0$ ) focuses the lower values
  - $0$  defines a linear distribution
  - A positive value ( $>0$  to  $1$ ) focuses the higher values

## 8.5.3 Trace Math

**Access:** TRACE > "Trace Math"

If you have several traces with different modes, for example an average trace and a maximum trace, it may be of interest to compare the results of both traces. In this example, you could analyze the maximum difference between the average and maximum values. To analyze the span of result values, you could subtract the minimum trace from the maximum trace. For such tasks, the results from several traces can be combined using mathematical functions.

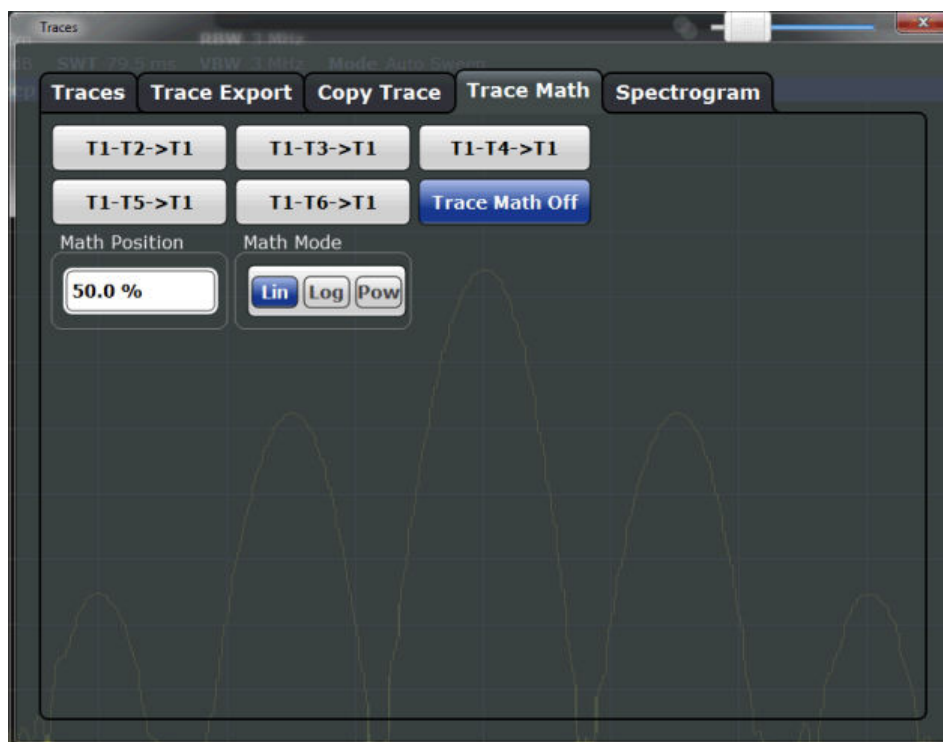

[Trace Math Function](#) ..... 487

[Trace Math Off](#) ..... 487

[Trace Math Position](#) ..... 488

[Trace Math Mode](#) ..... 488

**Trace Math Function**

Defines which trace is subtracted from trace 1. The result is displayed in trace 1 and refers to the zero point defined with the [Trace Math Position](#) setting. The following subtractions can be performed:

|             |                                 |
|-------------|---------------------------------|
| "T1-T2->T1" | Subtracts trace 2 from trace 1. |
| "T1-T3->T1" | Subtracts trace 3 from trace 1  |
| "T1-T4->T1" | Subtracts trace 4 from trace 1  |
| "T1-T5->T1" | Subtracts trace 5 from trace 1  |
| "T1-T6->T1" | Subtracts trace 6 from trace 1  |

To switch off the trace math, use the [Trace Math Off](#) button.

Remote command:

[CALCulate<n>:MATH\[:EXPRession\]\[:DEFine\]](#) on page 851

[CALCulate<n>:MATH:STATe](#) on page 852

**Trace Math Off**

Deactivates any previously selected trace math functions.

Remote command:

[CALC:MATH:STAT OFF](#), see [CALCulate<n>:MATH:STATe](#) on page 852

**Trace Math Position**

Defines the zero point on the y-axis of the resulting trace in % of the diagram height. The range of values extends from -100 % to +200 %.

Remote command:

`CALCulate<n>:MATH:POSition` on page 852

**Trace Math Mode**

Defines the mode for the trace math calculations.

|         |                                                                                                                                                                                                                                                                                                                                                                                                                                                                                                                                                                                                                                                                                        |
|---------|----------------------------------------------------------------------------------------------------------------------------------------------------------------------------------------------------------------------------------------------------------------------------------------------------------------------------------------------------------------------------------------------------------------------------------------------------------------------------------------------------------------------------------------------------------------------------------------------------------------------------------------------------------------------------------------|
| "Lin"   | <p>Activates linear subtraction, which means that the power level values are converted into linear units prior to subtraction. After the subtraction, the data is converted back into its original unit. This setting takes effect if the grid is set to a linear scale. In this case, subtraction is done in two ways (depending on the set unit):</p> <ul style="list-style-type: none"> <li>• The unit is set to either W or dBm: the data is converted into W prior to subtraction, i.e. averaging is done in W.</li> <li>• The unit is set to either V, A, dBmV, dBµV, dBµA or dBpW: the data is converted into V prior to subtraction, i.e. subtraction is done in V.</li> </ul> |
| "Log"   | <p>Activates logarithmic subtraction. This subtraction method only takes effect if the grid is set to a logarithmic scale, i.e. the unit of the data is dBm. In this case the values are subtracted in dBm. Otherwise (i.e. with linear scaling) the behavior is the same as with linear subtraction.</p>                                                                                                                                                                                                                                                                                                                                                                              |
| "Power" | <p>Activates linear power subtraction. The power level values are converted into unit Watt prior to subtraction. After the subtraction, the data is converted back into its original unit. Unlike the linear mode, the subtraction is always done in W.</p>                                                                                                                                                                                                                                                                                                                                                                                                                            |

Remote command:

`CALCulate<n>:MATH:MODE` on page 851

## 8.6 Importing and Exporting Measurement Results for Evaluation

The R&S FPS provides various evaluation methods for the results of the performed measurements. However, you may want to evaluate the data with further, external applications. In this case, you can export the measurement data to a standard format file (ASCII or XML). Some of the data stored in these formats can also be re-imported to the R&S FPS for further evaluation later, for example in other applications.

The following data types can be exported (depending on the application):

- Trace data
- Table results, such as result summaries, marker peak lists etc.
- I/Q data



The following data types can be imported (depending on the application):

- I/Q data



I/Q data can only be imported and exported in applications that process I/Q data, such as the I/Q Analyzer or optional applications.

See the corresponding user manuals for those applications for details.

- [Displaying a Reference Trace - Importing Trace Data](#).....489
- [Trace/Data Ex/Import](#).....490
- [How to Import Traces](#).....494
- [How to Export Trace Data and Numerical Results](#).....494
- [How to Export a Peak List](#).....495
- [Reference: ASCII File Export Format](#).....495

### 8.6.1 Displaying a Reference Trace - Importing Trace Data

Trace data that was stored during a previous measurement can be imported to the Spectrum application, for example as a reference trace.

The data in the import file must have a specified format (see [Chapter 8.6.6, "Reference: ASCII File Export Format"](#), on page 495), and can be stored in .CSV or .DAT format.

#### Trace Mode

The trace mode for the imported traces is set to "View" so that the data is not overwritten immediately during the next sweep. Other trace settings remain unchanged. Thus, **the displayed trace may not comply with the displayed trace settings in the channel bar.**

#### Detector type and number of sweep points

In particular, the detector type and the number of sweep points remain unchanged.

If the detector type of the active trace requires two points per x-value ( "Auto Peak" ), but the file contains only one, each point is duplicated. If the detector type requires only one point per x-value, but the file contains two, each second point is ignored.

If the file contains more sweep points than the active trace requires, the superfluous points are ignored. If the file does not contain enough sweep points, the missing points are inserted as -200 dBm.

#### Units

If the unit of the y-axis values in the file does not correspond to the active result display, the imported values are converted. If no unit is defined in the file, it is assumed to be dBm.

### Importing multiple traces in one file

If the import file contains more than one trace, you can import several traces at once, overwriting the existing trace data for any active trace in the result display with the same trace number. Data from the import file for currently not active traces is not imported.

Alternatively, you can import a single trace only, which is displayed for the trace number specified in "Import to Trace" . This list contains all currently active traces in the result display. If a trace with the specified number exists in the import file, that trace is imported. Otherwise, the first trace in the file is imported (indicated by a message in the status bar).

#### Example:

The import file contains trace 1, trace 2, and trace 4. The current result display has 4 active traces.

"Import to Trace" = 2: trace 2 of the import file is displayed as trace 2 in the result display.

"Import to Trace" = 3: trace 3 is not available in the import file, thus trace 1 is imported and displayed as trace 3 in the result display

"Import to Trace" is enabled: Trace 1 is imported from the file and replaces trace 1 in the result display.

Trace 2 is imported from the file and replaces trace 2 in the result display.

Trace 4 is imported from the file and replaces trace 4 in the result display.

Trace 3 in the result display remains unchanged.

### Importing spectrogram traces

Trace data can also be imported to an active Spectrogram result display.

Note the following differences that apply in this case:

- The measurement must be stopped before import.
- Only trace 1 is imported to the spectrogram. Any other traces may be imported to a Spectrum display, if available. However, they do not change the spectrogram display, which always refers to trace 1.
- A single spectrum is inserted as a new frame number 0.
- The trace mode is *not* changed to "View" as for Spectrum trace imports.

## 8.6.2 Trace/Data Ex/Import

**Access:** TRACE > "Trace Config" > "Trace / Data Export"

The R&S FPS provides various evaluation methods for the results of the performed measurements. However, you may want to evaluate the data with other, external applications. In this case, you can export the measurement data to a standard ASCII format file (DAT or CSV). You can also import existing trace data from a file, for example as a reference trace (Spectrum application only).



The standard data management functions (e.g. saving or loading instrument settings) that are available for all R&S FPS applications are not described here.

See [Chapter 9.3, "Storing and Recalling Instrument Settings and Measurement Data"](#), on page 502 for a description of the standard functions.

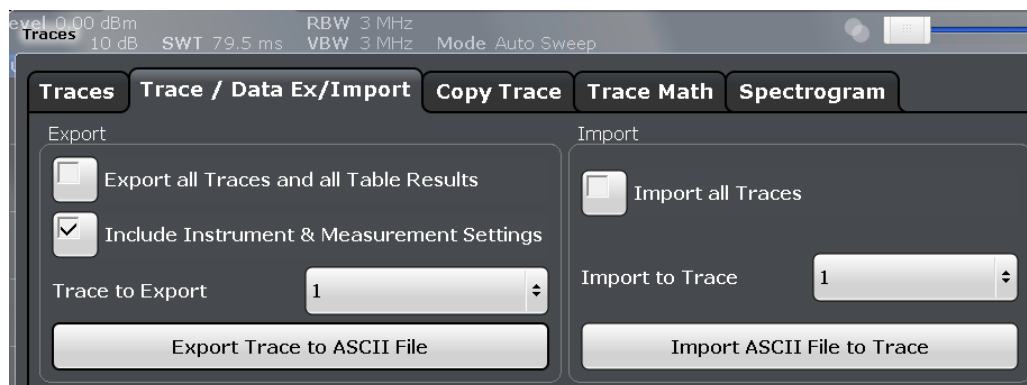

For step-by-step instructions on how to export a trace, see [Chapter 8.6.4, "How to Export Trace Data and Numerical Results"](#), on page 494.

|                                                                     |     |
|---------------------------------------------------------------------|-----|
| <a href="#">Export all Traces and all Table Results</a> .....       | 491 |
| <a href="#">Include Instrument &amp; Measurement Settings</a> ..... | 491 |
| <a href="#">Trace to Export</a> .....                               | 491 |
| <a href="#">Export Trace to ASCII File</a> .....                    | 492 |
| L <a href="#">File Type</a> .....                                   | 493 |
| L <a href="#">Decimal Separator</a> .....                           | 493 |
| <a href="#">Importing Traces</a> .....                              | 493 |
| L <a href="#">Import All Traces / Import to Trace</a> .....         | 493 |
| L <a href="#">Import ASCII File to Trace</a> .....                  | 493 |

**Export all Traces and all Table Results**

Selects all displayed traces and result tables (e.g. Result Summary, marker table etc.) in the current application for export to an ASCII file.

Alternatively, you can select one specific trace only for export (see [Trace to Export](#) ).

The results are output in the same order as they are displayed on the screen: window by window, trace by trace, and table row by table row.

Remote command:

[FORMat:DEXPort:TRACes](#) on page 858

**Include Instrument & Measurement Settings**

Includes additional instrument and measurement settings in the header of the export file for result data.

See [Chapter 8.6.6, "Reference: ASCII File Export Format"](#), on page 495 for details.

Remote command:

[FORMat:DEXPort:HEADer](#) on page 963

**Trace to Export**

Defines an individual trace that will be exported to a file.

This setting is not available if [Export all Traces and all Table Results](#) is selected.

### Export Trace to ASCII File

Saves the selected trace or all traces in the currently active result display to the specified file and directory in the selected ASCII format.

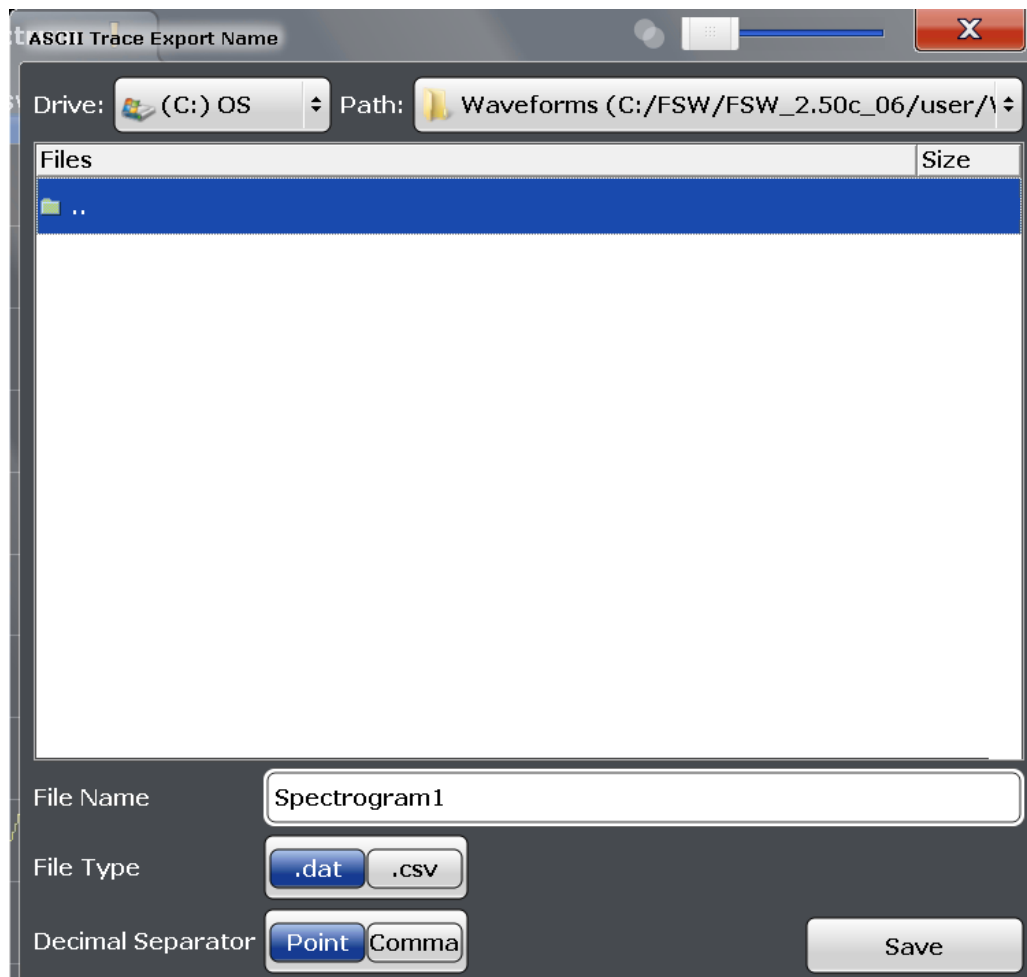

If the spectrogram display is selected when you perform this function, the entire histogram buffer with all frames is exported to a file. The data for a particular frame begins with information about the frame number and the time that frame was recorded. For large history buffers the export operation may take some time.

For details on the file format in the Spectrum application, see [Chapter 8.6.6, "Reference: ASCII File Export Format"](#), on page 495.

**Note:** Secure user mode.

In secure user mode, settings that are stored on the instrument are stored to volatile memory, which is restricted to 256 MB. Thus, a "memory limit reached" error can occur although the hard disk indicates that storage space is still available.

To store data permanently, select an external storage location such as a USB memory device.

For details, see [Chapter 4.1.6, "Protecting Data Using the Secure User Mode"](#), on page 33.

Remote command:

`MMEMory:STORe<n>:TRACe` on page 859

`MMEMory:STORe<n>:SPECTrogram` on page 965

#### **File Type ← Export Trace to ASCII File**

Determines the format of the ASCII file to be imported or exported.

Depending on the external program in which the data file was created or will be evaluated, a comma-separated list (CSV) or a plain data format (DAT) file may be required.

Remote command:

`FORMat:DEXPort:FORMat` on page 857

#### **Decimal Separator ← Export Trace to ASCII File**

Defines the decimal separator for floating-point numerals for the data export/import files. Evaluation programs require different separators in different languages.

Remote command:

`FORMat:DEXPort:DSEParator` on page 937

### **Importing Traces**

Trace data that was stored during a previous measurement can be imported to the Spectrum application, for example as a reference trace.

#### **Import All Traces / Import to Trace ← Importing Traces**

If the import file contains more than one trace, you can import several traces at once, overwriting the existing trace data for any active trace in the result display with the same trace number. Data from the import file for currently not active traces is not imported.

Alternatively, you can import a single trace only, which is displayed for the trace number specified in "Import to Trace". This list contains all currently active traces in the result display. If a trace with the specified number exists in the import file, that trace is imported. Otherwise, the first trace in the file is imported (indicated by a message in the status bar).

Remote command:

`FORMat:DIMPort:TRACes` on page 858

#### **Import ASCII File to Trace ← Importing Traces**

Loads one trace or all traces from the selected file in the selected ASCII format (.DAT or .CSV) to the currently active result display.

This function is only available for the Spectrum application. Spectrograms can also be imported.

For details see [Chapter 8.6.1, "Displaying a Reference Trace - Importing Trace Data"](#), on page 489.

Remote command:

`MMEMory:LOAD<n>:TRACe` on page 858

### 8.6.3 How to Import Traces

Trace data that was stored during a previous measurement can be imported to the Spectrum application, for example as a reference trace.

#### To import trace data

1. Press the TRACE key.
2. Select "Trace Config" > "Trace / Data Export" / "Import" .
3. Select "Import All Traces" to import traces for all the currently active traces, or select a specific trace to be imported in "Import to Trace" .
4. Select "Import ASCII File to Trace" .
5. Select the file format in which the data is stored.
6. Select the file that contains the trace data.
7. Select "Select" to close the dialog box and start the import.

### 8.6.4 How to Export Trace Data and Numerical Results

The measured trace data and numerical measurement results in tables can be exported to an ASCII file. For each sweep point the measured trace position and value are output.

The file is stored with a .DAT extension. For details on the storage format see [Chapter 8.6.6, "Reference: ASCII File Export Format"](#), on page 495.



For the results of a Spectrum Emission Mask (SEM) or Spurious Emissions measurement, special file export functions are available, see [Chapter 6.5.6.2, "How to Save SEM Result Files"](#), on page 239(SEM) and [" Save Evaluation List "](#) on page 258 (Spurious).

---

#### To export trace data and table results

1. Select TRACE > "Trace Config" > "Trace / Data Export" tab.
2. Select "Export all Traces and all Table Results" to export all available measurement result data for the current application, or select a specific "Trace to Export" .
3. Optionally, select the "Include Instrument & Measurement Settings" option to insert additional information in the export file header.
4. If necessary, change the decimal separator to be used for the ASCII export file.
5. Select the "Export Trace to ASCII File" button.
6. In the file selection dialog box, select the storage location and file name for the export file.

7. Select "Save" to close the dialog box and export the data to the file.

### 8.6.5 How to Export a Peak List

You can save the results of a marker peak list to an ASCII file.

1. Press the MKR FUNCT key.
2. Select the "Marker Peak List" softkey.
3. Configure the peak search and list settings as described in [Chapter 8.3.4.7, "Marker Peak List"](#), on page 434.
4. Set the marker peak list "State" to "On" .
5. Press the RUN SINGLE key to perform a single sweep measurement and create a marker peak list.
6. Select the "Marker Peak List" softkey to display the "Marker Peak List" dialog box again.
7. If necessary, change the decimal separator to be used for the ASCII export file.
8. Select the "Export Peak List" button.
9. In the file selection dialog box, select the storage location and file name for the export file.
10. Select "Save" to close the dialog box and export the peak list data to the file.

### 8.6.6 Reference: ASCII File Export Format

Trace data can be exported to a file in ASCII format for further evaluation in other applications. This reference describes in detail the format of the export files for result data.

(For details see [Chapter 8.6.4, "How to Export Trace Data and Numerical Results"](#), on page 494).

The file consists of the header containing important scaling parameters and a data section containing the trace data. Optionally, the header can be excluded from the file (see [" Include Instrument & Measurement Settings "](#) on page 491).

The data of the file header consist of three columns, each separated by a semicolon: parameter name; numeric value; basic unit. The data section starts with the keyword "Trace <n>" (<n> = number of stored trace), followed by the measured data in one or several columns (depending on the measurement) which are also separated by a semicolon.

The results are output in the same order as they are displayed on the screen: window by window, trace by trace, and table row by table row.

Generally, the format of this ASCII file can be processed by spreadsheet calculation programs, e.g. MS-Excel. Different language versions of evaluation programs may

require a different handling of the decimal point. Thus you can define the decimal separator to be used (decimal point or comma, see " [Decimal Separator](#) " on page 493).

If the spectrogram display is selected when you select the "ASCII Trace Export" soft-key, the entire histogram buffer with all frames is exported to a file. The data corresponding to a particular frame begins with information about the frame number and the time that frame was recorded.

**Table 8-6: ASCII file format for trace export in the Spectrum application**

| File contents                    | Description                                                                                                   |
|----------------------------------|---------------------------------------------------------------------------------------------------------------|
| <b>Header data</b>               |                                                                                                               |
| Type;R&S FPS;                    | Instrument model                                                                                              |
| Version;1.00;                    | Firmware version                                                                                              |
| Date;01.Oct 2006;                | Date of data set storage                                                                                      |
| Mode;ANALYZER;                   | Operating mode                                                                                                |
| Preamplifier;OFF                 | Preamplifier status                                                                                           |
| Transducer; OFF                  | Transducer status                                                                                             |
| Center Freq;55000;Hz             | Center frequency                                                                                              |
| Freq Offset;0;Hz                 | Frequency offset                                                                                              |
| Start;10000;Hz<br>Stop;100000;Hz | Start/stop of the display range.<br>Unit: Hz for span > 0, s for span = 0, dBm/dB for statistics measurements |
| Span;90000;Hz                    | Frequency range (0 Hz in zero span and statistics measurements)                                               |
| Ref Level;-30;dBm                | Reference level                                                                                               |
| Level Offset;0;dB                | Level offset                                                                                                  |
| Rf Att;20;dB                     | Input attenuation                                                                                             |
| EI Att;2.0;dB                    | Electrical attenuation                                                                                        |
| RBW;100000;Hz                    | Resolution bandwidth                                                                                          |
| VBW;30000;Hz                     | Video bandwidth                                                                                               |
| SWT;0.005;s                      | Sweep time                                                                                                    |
| Sweep Count;20;                  | Number of sweeps set                                                                                          |
| Ref Position;75;%                | Position of reference level referred to diagram limits (0 % = lower edge)                                     |
| Level Range;100;dB               | Display range in y direction. Unit: dB with x-axis LOG, % with x-axis LIN                                     |
| x-Axis;LIN;                      | Scaling of x-axis linear (LIN) or logarithmic (LOG)                                                           |
| y-Axis;LOG;                      | Scaling of y-axis linear (LIN) or logarithmic (LOG)                                                           |
| x-Unit;Hz;                       | Unit of x values: Hz with span > 0; s with span = 0; dBm/dB with statistics measurements                      |



| File contents                                                           | Description                                                                                                                                                                           |
|-------------------------------------------------------------------------|---------------------------------------------------------------------------------------------------------------------------------------------------------------------------------------|
| y-Unit;dBm;                                                             | Unit of y values: dB*/V/A/W depending on the selected unit with y-axis LOG or % with y-axis LIN                                                                                       |
| <b>Data section for individual window</b>                               |                                                                                                                                                                                       |
| Window;1;Frequency Sweep                                                | Window number and name                                                                                                                                                                |
| Trace 1;;                                                               | Selected trace                                                                                                                                                                        |
| Trace Mode;AVERAGE;                                                     | Display mode of trace: CLR/WRITE,AVERAGE,MAXHOLD,MINHOLD                                                                                                                              |
| Detector;AUTOPEAK;                                                      | Selected detector                                                                                                                                                                     |
| Values; 1001;                                                           | Number of measurement points                                                                                                                                                          |
| 10000;-10.3;-15.7<br>10130;-11.5;-16.9<br>10360;-12.0;-17.4<br>...;...; | Measured values: <x value>, <y1>, <y2>; <y2> being available only with detector AUTOPEAK and containing in this case the smallest of the two measured values for a measurement point. |
| <b>Data section for individual trace</b>                                |                                                                                                                                                                                       |
| Trace 2;;                                                               | Next trace in same window                                                                                                                                                             |
| ...                                                                     |                                                                                                                                                                                       |
| <b>Data section for individual window</b>                               |                                                                                                                                                                                       |
| Window;2 ..;                                                            | Name of next window                                                                                                                                                                   |
| <b>Data section for individual trace</b>                                |                                                                                                                                                                                       |
| Trace 1;;                                                               | First trace                                                                                                                                                                           |
| ...                                                                     |                                                                                                                                                                                       |

Table 8-7: ASCII file format for spectrogram trace export

| File contents                     | Description                                                                                                   |
|-----------------------------------|---------------------------------------------------------------------------------------------------------------|
| <b>Header</b>                     |                                                                                                               |
| Type;R&S FPS;                     | Instrument model                                                                                              |
| Version;5.00;                     | Firmware version                                                                                              |
| Date;01.Oct 2006;                 | Date of data set storage                                                                                      |
| Mode;ANALYZER; <b>SPECTROGRAM</b> | Operating mode                                                                                                |
| Center Freq;55000;Hz              | Center frequency                                                                                              |
| Freq Offset;0;Hz                  | Frequency offset                                                                                              |
| Span;90000;Hz                     | Frequency range (0 Hz in zero span and statistics measurements)                                               |
| x-Axis;LIN;                       | Scaling of x-axis linear (LIN) or logarithmic (LOG)                                                           |
| Start;10000;Hz<br>Stop;100000;Hz  | Start/stop of the display range.<br>Unit: Hz for span > 0, s for span = 0, dBm/dB for statistics measurements |

## Importing and Exporting Measurement Results for Evaluation

| File contents                                                           | Description                                                                                                                                                                                                          |
|-------------------------------------------------------------------------|----------------------------------------------------------------------------------------------------------------------------------------------------------------------------------------------------------------------|
| Ref Level;-30;dBm                                                       | Reference level                                                                                                                                                                                                      |
| Level Offset;0;dB                                                       | Level offset                                                                                                                                                                                                         |
| Ref Position;75; %                                                      | Position of reference level referred to diagram limits (0 % = lower edge)                                                                                                                                            |
| y-Axis;LOG;                                                             | Scaling of y-axis linear (LIN) or logarithmic (LOG)                                                                                                                                                                  |
| Level Range;100;dB                                                      | Display range in y direction. Unit: dB with x-axis LOG, % with x-axis LIN                                                                                                                                            |
| Rf Att;20;dB                                                            | Input attenuation                                                                                                                                                                                                    |
| RBW;100000;Hz                                                           | Resolution bandwidth                                                                                                                                                                                                 |
| VBW;30000;Hz                                                            | Video bandwidth                                                                                                                                                                                                      |
| SWT;0.005;s                                                             | Sweep time                                                                                                                                                                                                           |
| Trace Mode;AVERAGE;                                                     | Display mode of trace: CLR/WRITE,AVERAGE,MAXHOLD,MINHOLD                                                                                                                                                             |
| Detector;AUTOPEAK;                                                      | Selected detector                                                                                                                                                                                                    |
| Sweep Count;20;                                                         | Number of sweeps set                                                                                                                                                                                                 |
| <b>Data section</b>                                                     |                                                                                                                                                                                                                      |
| Trace 1;;                                                               | Selected trace                                                                                                                                                                                                       |
| x-Unit;Hz;                                                              | Unit of x values: Hz with span > 0; s with span = 0; dBm/dB with statistics measurements                                                                                                                             |
| y-Unit;dBm;                                                             | Unit of y values: dB*V/A/W depending on the selected unit with y-axis LOG or % with y-axis LIN                                                                                                                       |
| Values; 1001;                                                           | Number of measurement points                                                                                                                                                                                         |
| <b>Frames;2;</b>                                                        | <b>Number of exported frames</b>                                                                                                                                                                                     |
| <b>Frame;0;</b>                                                         | <b>Most recent frame number</b>                                                                                                                                                                                      |
| Timestamp;17.Mar 11;11:27:05.990                                        | <b>Timestamp of this frame</b>                                                                                                                                                                                       |
| 10000;-10.3;-15.7<br>10130;-11.5;-16.9<br>10360;-12.0;-17.4<br>...;...; | Measured values, identical to spectrum data:<br><x value>, <y1>, <y2>; <y2> being available only with detector AUTOPEAK and containing in this case the smallest of the two measured values for a measurement point. |
| <b>Frame;-1;</b>                                                        | <b>Next frame</b>                                                                                                                                                                                                    |
| <b>Timestamp;17.Mar 11;11:27:05.342</b>                                 | <b>Timestamp of this frame</b>                                                                                                                                                                                       |
| ...                                                                     |                                                                                                                                                                                                                      |

## 9 Data Management

The R&S FPS allows you to store and load instrument settings, as well as import and export measurement data for analysis later. Finally, you can store or print the measurement results displayed on the screen.

General storage and import/export functions are available via the toolbar. Some special storage functions are (also) available via softkeys or dialog boxes in the corresponding menus, for example trace data export.

See [Chapter 8.6, "Importing and Exporting Measurement Results for Evaluation"](#), on page 488 for RF measurements in the Spectrum mode, or the description of the specific applications.

- [Restoring the Default Instrument Configuration \(Preset\)](#)..... 499
- [Protecting Data Using the Secure User Mode](#)..... 500
- [Storing and Recalling Instrument Settings and Measurement Data](#)..... 502
- [Import/Export Functions](#)..... 513
- [Creating Screenshots of Current Measurement Results and Settings](#)..... 515

### 9.1 Restoring the Default Instrument Configuration (Preset)

When delivered, the R&S FPS has a default configuration. You can restore this defined initial state at any time as a known starting point for measurements. This is often recommendable as a first step in troubleshooting when unusual measurement results arise.



#### Factory default configuration

The factory default configuration is selected such that the RF input is always protected against overload, provided that the applied signal levels are in the allowed range for the instrument.

Alternatively to the factory default settings, you can define user-specific recall settings to be restored after a preset or reboot, see ["To recall settings automatically after preset or reboot"](#) on page 513.

#### To restore the default instrument configuration for all channels at once

- ▶ Press the PRESET key.



After you use the PRESET function, the history of previous actions is deleted, i.e. any actions performed previously cannot be undone or redone using the UNDO/REDO keys.

#### Remote command:

\*RST or SYSTem:PRESet

### To restore the default configuration for a single channel

The default measurement settings can also be reset for an individual channel only, rather than resetting the entire instrument.

- ▶ In the "Overview" , select the "Preset Channel" button.

The factory default settings are restored to the current channel. Note that a user-defined recall settings file is **NOT** restored.

#### Remote command:

`SYSTem:PRESet:CHANnel [:EXEC]` on page 951

## 9.2 Protecting Data Using the Secure User Mode

During normal operation, the R&S FPS uses a solid-state drive to store its operating system, instrument firmware, instrument self-alignment data, and any user data created during operation. If necessary, the solid-state drive can be removed from the R&S FPS and locked in a secure place to protect any classified data it may contain.

### Redirecting storage to volatile memory

Alternatively, to avoid storing any sensitive data on the R&S FPS permanently, the *secure user mode* was introduced (option R&S FPS-K33). In secure user mode the instrument's solid-state drive is write-protected so that no information can be written to memory permanently. Data that the R&S FPS normally stores on the solid-state drive is redirected to volatile memory instead, which remains available only until the instrument is switched off. This data includes:

- Windows 7 operating system files
- Firmware shutdown files containing information on last instrument state
- Self-alignment data
- General instrument settings such as the IP address
- Measurement settings
- User data created during operation (see also [Table 9-1](#))
- Any data created by other applications installed on the R&S FPS, for example text editors (Notepad), the Clipboard, drawing tools, etc.

Users can access data that is stored in volatile memory just as in normal operation. However, when the instrument's power is switched off, all data in this memory is cleared. Thus, in secure user mode, the instrument always starts in a defined, fixed state when switched on.

To store data such as measurement results permanently, it must be stored to an external storage device, such as a memory stick.



### Limited storage space

The volatile memory used to store data in secure user mode is restricted to 256 MB. Thus, a "Memory full" error can occur although the hard disk indicates that storage space is still available.

### Storing required data permanently

Any data that is to be available for subsequent sessions with the R&S FPS must be stored on the instrument permanently, *before activating the secure user mode*. This includes predefined instrument settings, transducer factors and self-alignment data.



### Self-alignment data

Note that self-alignment data becomes invalid with time and due to temperature changes. Therefore, to achieve optimal accuracy, it may be preferable to perform a new self-alignment at the start of each new session on the R&S FPS.

### Restricted operation

Since permanent storage is not possible, the following functions are not available in secure user mode:

- Firmware update
- Activating a new option key

Furthermore, since the "SecureUser" used in secure user mode does not have administrator rights, **administrative tasks** such as LAN configuration and some general instrument settings are not available. Refer to the description of the basic instrument setup (SETUP menu) to find out which functions are affected.



### Remote Desktop restricted for "SecureUser" by default

For security reasons, the "SecureUser" is not allowed Remote Desktop access to the R&S FPS by default. You must explicitly add the "SecureUser" to the Remote Desktop group (see [Chapter 4.4.6.5, "How to Add or Remove Users to the Remote Desktop Users Group"](#), on page 75). If you do not allow this user Remote Desktop access, the "SecureUser" can only operate the R&S FPS using remote commands or via the miniature display.

### Activating and deactivating secure user mode

Only a user with administrator rights can activate (and deactivate) the secure user mode. Once activated, a restart is required. The special user "SecureUser" is then logged on to the R&S FPS automatically (using the automatic login function, see ["Automatic Login Function"](#) on page 27). While the secure user mode is active, a message is displayed in the status bar at the bottom of the screen, and in the miniature display "SecUsr" is displayed.

To deactivate the secure user mode, the "SecureUser" must log off and the "Instrument" user (administrator) must log on.



### Switching users when using the automatic login function

In the "Start" menu, select the arrow next to the "Shut down" button and then "Log off". The "Login" dialog box is displayed, in which you can enter the different user account name and password.

The secure user mode setting and automatic login is automatically deactivated when the "Instrument" user logs on. The "SecureUser" is no longer available.

For administrators ("Instrument" user), the secure user mode setting is available in the general system configuration settings (see "[SecureUser Mode](#)" on page 565).

Alternatively, you can activate or deactivate the secure user function via the miniature display (see "[Enable SecureUser/Disable SecureUser](#)" on page 45. In this case, enter the administrator ("Instrument" user) password.

### Remote control

Initially after installation of the R&S FPS-K33 option, secure user mode must be enabled manually once before remote control is possible.

(See `SYSTEM:SECURITY[:STATE]`.)

## 9.3 Storing and Recalling Instrument Settings and Measurement Data



**Access:** "Save" / "Open" icon in the toolbar



Possibly you would like to restore or repeat a measurement you performed under specific conditions on the instrument. Or you want to evaluate imported data in another application on the R&S FPS and would like to restore the measurement settings applied during measurement. In these cases, you can store and recall instrument and measurement settings, and possibly other related measurement data.

Two different methods are available for managing instrument settings:

- Quick Save/Quick Recall - a defined set of instrument settings or channels are stored or recalled quickly in just one step
- Configurable Save/Recall - a user-defined set of instrument settings or channels are stored to a definable storage location



### Restrictions when recalling measurement settings

When recalling a saved configuration file, the following restrictions apply:

- The R&S FPS must support the frequency range defined in the configuration file.
- Configuration files created on a R&S FPS with certain options in use do not work on an R&S FPS without these options.
- Files created with newer firmware versions may not work with a previous version.
- Files created on an instrument other than the R&S FPS do not work on the R&S FPS.



### Saving instrument settings in secure user mode

Be sure to store instrument settings that you require beyond the current session before **SecureUser Mode** is enabled; see [Chapter 4.1.6, "Protecting Data Using the Secure User Mode"](#), on page 33.

Settings that are saved via QuickSave in secure user mode are only available during the current session. As soon as the power is switched off on the R&S FPS, the data is cleared.



### Saving and recalling transducer and limit line settings

If a transducer file was in use when the save set was stored (with the save item "Current Settings" only) the R&S FPS assumes that these transducer values should remain valid after every recall of that save set. Thus, even if the transducer file is changed and the original save set file is recalled later, the *originally stored* transducer values are recalled and applied to the measurement. In the "Edit" transducer dialog box, however, the *changed* transducer file values are displayed, as no updated transducer file was loaded.

The same applies to limit line settings.

The same applies to integrated measurements' weighting filter.

If you want to apply the changed transducer values after recalling the save set, you must force the application to reload the transducer file. To do so, simply open the "Edit Transducer" dialog box (see [Chapter 10.3.2, "Transducer Settings"](#), on page 548) and toggle the "X-Axis" option from "Lin" to "log" and back. Due to that change, the transducer file is automatically reloaded, and the changed transducer values are applied to the current measurement. Now you can create a new save set with the updated transducer values.

Similarly, if you want to apply the changed limit values after recalling the save set, you must force the application to reload the limit file. To do so, simply open the "Edit Limit Line" dialog box (see [Chapter 8.4.2.2, "Limit Line Settings and Functions"](#), on page 447) and toggle the "Y-Axis" unit. Due to that change, the limit line file is automatically reloaded, and the changed limit values are applied to the current measurement. Now a new save set with the updated limit values can be created.

- [Quick Save/Quick Recall](#).....504
- [Configurable Storage and Recall](#)..... 506
- [How to Save and Load Instrument Settings](#).....511

### 9.3.1 Quick Save/Quick Recall

The Quick Save and Quick Recall functions allow you to store instrument settings or channels very easily and quickly in one step. Up to ten different sets of settings can be stored to or recalled from "save sets". Each save set is identified by its storage date and type (instrument or specific "Channel" ) in the display. The save sets are stored in the C:\R\_S\INSTR\USER\QuickSave directory, in files named QuickSave1.dfl to QuickSave10.dfl. The storage filenames and locations cannot be changed. Only the current measurement settings are stored, not any additional data such as traces, limit line or transducer files (see [Chapter 9.3.2.1, "Stored Data Types"](#), on page 506).

During recall, save sets of type "Instrument" replace the settings of the entire instrument. All other save sets start a new channel with the stored settings.



If a channel with the same name as the "Channel" to be restored is already active, the name for the new channel is extended by a consecutive number:



#### 9.3.1.1 Quick Save / Quick Recall Settings



**Access:** "Save" / "Open" icon in the toolbar > "Quick Save" / "Quick Recall"



Both dialog boxes are very similar and closely related.



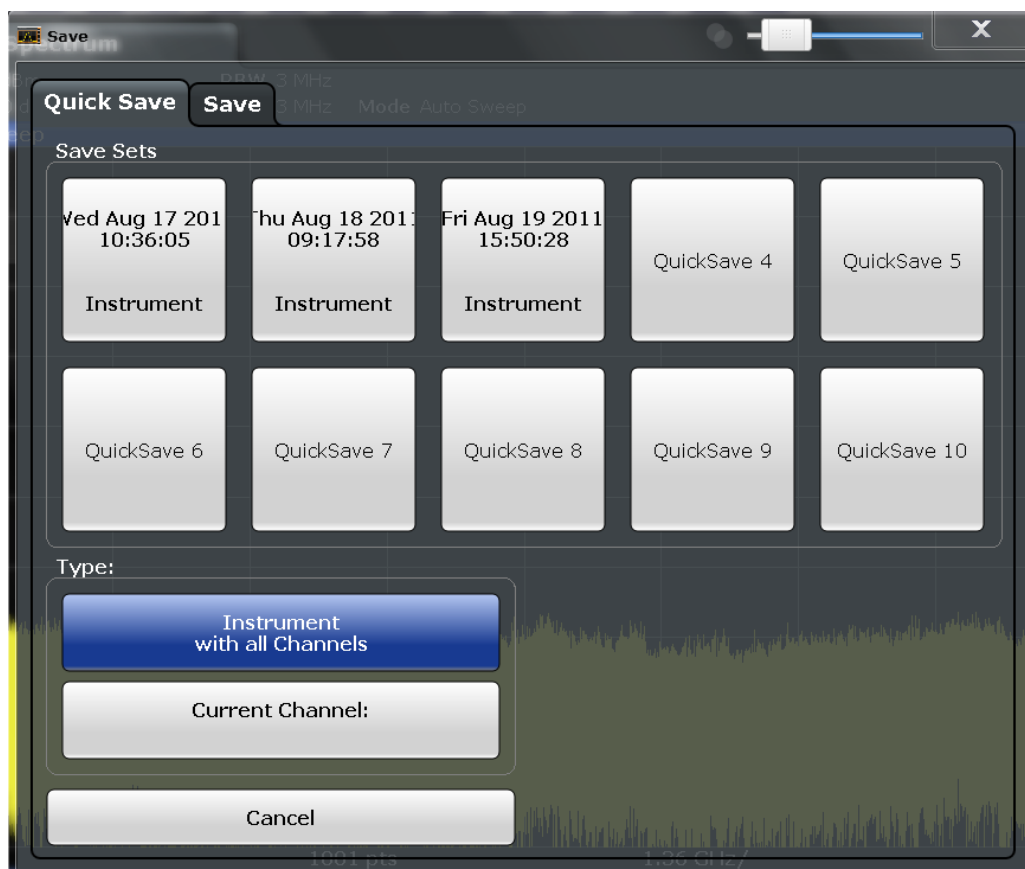

QuickSave 1 / ... / QuickSave 10 ..... 505  
 Storage Type (Save only) ..... 505  
 Recall ..... 506

**QuickSave 1 / ... / QuickSave 10**

Selects one of the save sets to store the current settings in or to be recalled. At the time of storage, the "QuickSave 1 / ... / QuickSave 10" placeholder is replaced by a label indicating the storage date and time and the storage type.

During recall, save sets of type "Instrument" replace the settings of the entire instrument. All other save sets start a new channel with the stored settings.

**Storage Type (Save only)**

Defines which type of settings are stored in the save set.

"Instrument with all Channels" The instrument settings for all currently active "Channel" s are stored.

"Current Channel" Only the instrument settings for the currently selected measurement "Channel" s are stored.

**Recall**

Restores the instrument settings as saved in the selected settings file. If the settings file contains settings for a specific "Channel" only, a new channel with the stored settings is activated, otherwise all "Channel" s and instrument settings are overwritten with the stored settings.

**Note:** After you use the "Recall" function, the history of previous actions is deleted, i.e. any actions performed previously cannot be undone or redone using the UNDO/REDO keys.

**Note:** If a channel with the same name as the "Channel" to be restored (in a new "Channel" ) is already active, the name for the new channel is extended by a consecutive number:



In remote commands, you must append this number to the channel name, as well.

Remote command:

`MMEMory:LOAD:STATe` on page 947

### 9.3.2 Configurable Storage and Recall

The more sophisticated storage and recall functions allow you to define which settings are stored, and where the settings file is stored to. Any settings file can be selected for recall.

- [Stored Data Types](#)..... 506
- [Storage Location and Filename](#)..... 507
- [Save and Recall Dialog Boxes](#).....507
- [Startup Recall Settings](#).....510

#### 9.3.2.1 Stored Data Types

The following types of data can be stored to and loaded from files via the "Save" dialog box on the R&S FPS:

**Table 9-1: Items that can be stored to files**

| Item             | Description                                                                                                                                                                                                                                                                               |
|------------------|-------------------------------------------------------------------------------------------------------------------------------------------------------------------------------------------------------------------------------------------------------------------------------------------|
| Current Settings | Current instrument and measurement settings.                                                                                                                                                                                                                                              |
| All Transducers  | All transducer factor <i>files</i> .<br>(Note: Restoring a saveset overwrites transducer factor files on the hard disk that have the same name as those in the saveset. For more information, see <a href="#">"Saving and recalling transducer and limit line settings"</a> on page 503.) |
| All Traces       | All active traces.                                                                                                                                                                                                                                                                        |
| All Limit Lines  | All limit line <i>files</i> .                                                                                                                                                                                                                                                             |
| Spectrograms     | Spectrogram trace data (only available if spectrogram display is currently active).                                                                                                                                                                                                       |

### 9.3.2.2 Storage Location and Filename

The data is stored on the internal flash disk or, if selected, on a memory stick or network drive. The operating system, firmware and stored instrument settings are located on drive C.



#### Saving instrument settings in secure user mode

In secure user mode all data is stored to the SDRAM, and is only available during the current session. As soon as the power is switched off on the R&S FPS, the data is cleared (see [Chapter 4.1.6, "Protecting Data Using the Secure User Mode"](#), on page 33).

Other storage locations cannot be selected in this mode.

---

The storage location and filename are selected in a file selection dialog box which is displayed when you perform a storage function.

By default, the name of a settings file consists of a base name followed by an underscore and three numbers, e.g. `limit_lines_005`. In the example, the base name is `limit_lines`. The base name can contain characters, numbers and underscores. The file extension `df1` is added automatically. The default folder for settings files is `C:\R_S\INSTR\USER`.

### 9.3.2.3 Save and Recall Dialog Boxes



**Access:** "Save" / "Open" icon in the toolbar > "Save" / "Recall"



Both dialog boxes are very similar and closely related.

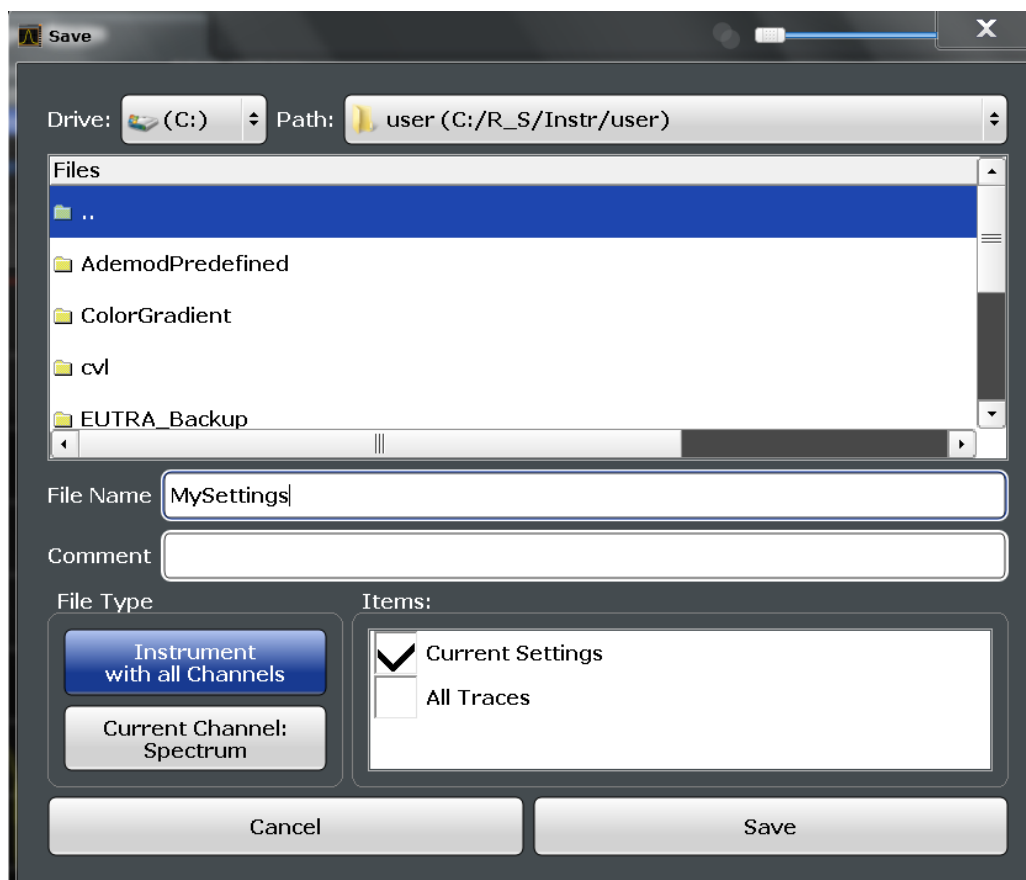

Selecting Storage Location - Drive/ Path/ Files.....508

File Name .....509

Comment .....509

File Type .....509

Items: .....509

Save File .....509

Recall in New Channel / Recall in Current Channel .....510

**Selecting Storage Location - Drive/ Path/ Files**

Select the storage location of the file on the instrument or an external drive.

The default storage location for the SEM settings files is: C:\R\_S\INSTR\sem\_std.

**Note:** Saving instrument settings in secure user mode.

In secure user mode, settings that are stored on the instrument are stored to volatile memory, which is restricted to 256 MB. Thus, a "memory limit reached" error can occur although the hard disk indicates that storage space is still available.

To store data permanently, select an external storage location such as a USB memory device.

For details, see [Chapter 4.1.6, "Protecting Data Using the Secure User Mode"](#), on page 33.

Remote command:

[MMEMoRY:CATalog?](#) on page 937

**File Name**

Contains the name of the data file without the path or extension.

By default, the name of a user file consists of a base name followed by an underscore. Multiple files with the same base name are extended by three numbers, e.g.

limit\_lines\_005.

For details on the filename and location, see [Chapter 9.3.2.2, "Storage Location and Filename"](#), on page 507.

**Comment**

An optional description for the data file. A maximum of 60 characters can be displayed.

Remote command:

[MMEMory:COMMeNt](#) on page 938

**File Type**

Determines whether the global instrument settings with all "Channel" s are stored or recalled, or the current "Channel" settings only.

**Items:**

Defines which data and settings are stored or are recalled. Depending on the "File Type" , either channels only, or global settings are available. Which items are available also depends on the installed options (see also [Chapter 9.3.2.1, "Stored Data Types"](#), on page 506).

Remote command:

[MMEMory:SELEct\[:ITEM\]:ALL](#) on page 943

[MMEMory:SELEct\[:ITEM\]:DEFault](#) on page 943

[MMEMory:SELEct\[:ITEM\]:NONE](#) on page 944

[MMEMory:SELEct\[:ITEM\]:HWSettings](#) on page 944

[MMEMory:SELEct\[:ITEM\]:LINES:ALL](#) on page 944

[MMEMory:SELEct\[:ITEM\]:SGRam](#) on page 945

[MMEMory:SELEct\[:ITEM\]:TRACe\[:ACTive\]](#) on page 945

[MMEMory:SELEct\[:ITEM\]:TRANsducer:ALL](#) on page 945

**Save File**

Saves the settings file with the defined filename.

**Note:** Secure user mode. In secure user mode, settings that are stored on the instrument are stored to volatile memory, which is restricted to 256 MB. Thus, a "memory limit reached" error can occur although the hard disk indicates that storage space is still available.

For details, see [Chapter 4.1.6, "Protecting Data Using the Secure User Mode"](#), on page 33.

Remote command:

[MMEMory:STORe<n>:STATe](#) on page 949

[MMEMory:STORe<n>:STATe:NEXT](#) on page 949

### Recall in New Channel / Recall in Current Channel

Restores the instrument settings as saved in the selected settings file. If the settings file contains settings for a specific "Channel" only, select "Recall in New Channel" to activate a new channel with the stored settings. Select "Recall in Current Channel" to replace the current "Channel" settings.

**Note:** After you use the "Recall" function, the history of previous actions is deleted, i.e. any actions performed previously cannot be undone or redone using the UNDO/REDO keys.

**Note:** If a channel with the same name as the "Channel" to be restored (in a new "Channel" ) is already active, the name for the new channel is extended by a consecutive number:



In remote commands, you must append this number to the channel name, as well.

Remote command:

`MMEMory:LOAD:STATe` on page 947

#### 9.3.2.4 Startup Recall Settings



**Access:** "Open" icon in the toolbar > "Startup Recall"

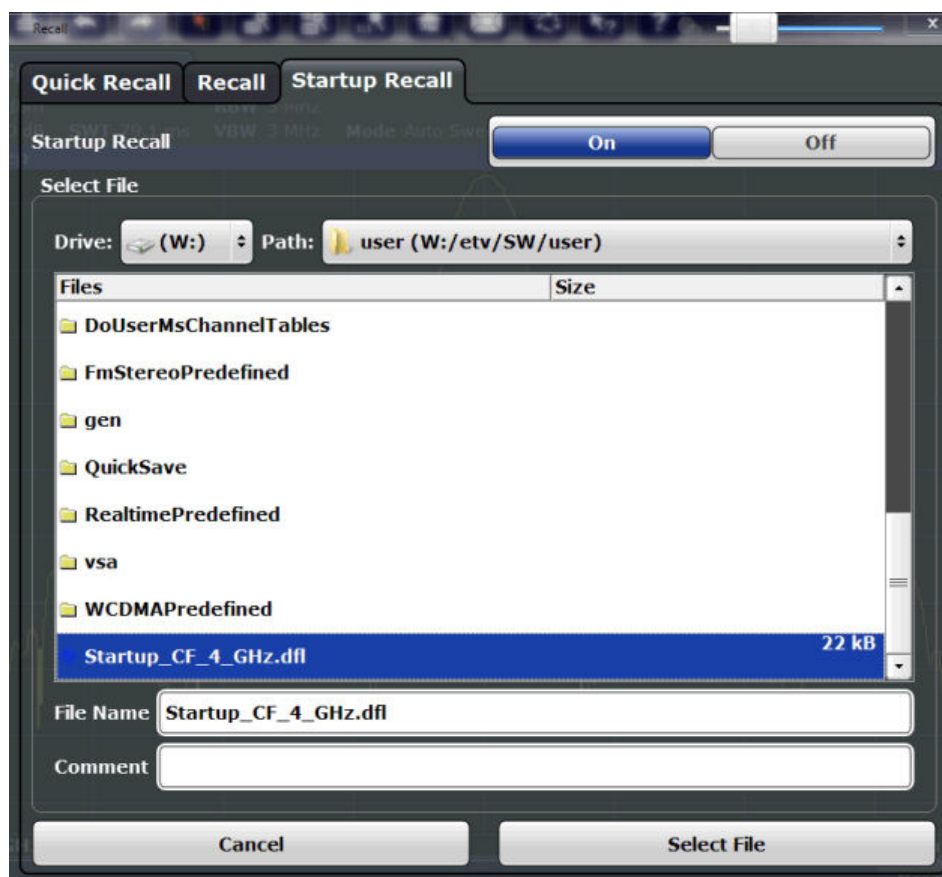

|                                                      |     |
|------------------------------------------------------|-----|
| Startup Recall .....                                 | 511 |
| Selecting Storage Location - Drive/ Path/ Files..... | 511 |
| File Name .....                                      | 511 |
| Comment .....                                        | 511 |

### Startup Recall

Activates or deactivates the startup recall function. If activated, the settings stored in the selected file are loaded each time the instrument is started or preset. If deactivated, the default settings are loaded.

Note that only *instrument* settings files can be selected for the startup recall function, not "Channel" files.

Remote command:

`MMEMoRY:LOAD:AUTO` on page 946

### Selecting Storage Location - Drive/ Path/ Files

Select the storage location of the file on the instrument or an external drive.

The default storage location for the SEM settings files is: `C:\R_S\INSTR\sem_std`.

**Note:** Saving instrument settings in secure user mode.

In secure user mode, settings that are stored on the instrument are stored to volatile memory, which is restricted to 256 MB. Thus, a "memory limit reached" error can occur although the hard disk indicates that storage space is still available.

To store data permanently, select an external storage location such as a USB memory device.

For details, see [Chapter 4.1.6, "Protecting Data Using the Secure User Mode"](#), on page 33.

Remote command:

`MMEMoRY:CATalog?` on page 937

### File Name

Contains the name of the data file without the path or extension.

By default, the name of a user file consists of a base name followed by an underscore. Multiple files with the same base name are extended by three numbers, e.g. `limit_lines_005`.

For details on the filename and location, see [Chapter 9.3.2.2, "Storage Location and Filename"](#), on page 507.

### Comment

An optional description for the data file. A maximum of 60 characters can be displayed.

Remote command:

`MMEMoRY:COMMeNt` on page 938

## 9.3.3 How to Save and Load Instrument Settings

Instrument settings can be saved to a file and loaded again later, so that you can repeat the measurement with the same settings. Optionally, user-defined measure-

ment settings can automatically be restored each time you start or preset the instrument.

#### To save and recall instrument settings using the Quick Save function

1. Select the  "Save" icon from the toolbar.
2. Select whether the instrument settings for **all** "Channel" s are stored, or only those for the **current** "Channel" .
3. Select one of the save sets in which the settings are stored ( "QuickSaveX" ).

The selected settings are stored to the file

`C:\R_S\INSTR\USERQuickSave\QuickSaveX.dfl.`

**Note:** If you make any changes to the settings *after* storing the configuration file, remember to save the settings again. Otherwise those settings cannot be restored and will be overwritten by the stored values when the configuration file is recalled.

4. To restore the settings, select the  "Open" icon from the toolbar.
5. Select the save set in which the settings were stored ( "QuickSaveX" ).  
The selected settings are restored to the instrument or channel.

#### To save configurable instrument settings

1. Select the  "Save" icon from the toolbar.
2. In the "Save" dialog box, switch to the "Save" tab.
3. In the file selection dialog box, select a filename and storage location for the settings file.
4. Optionally, define a comment to describe the stored settings.
5. Select whether the instrument settings for **all** "Channel" s are stored, or only those for the **current** "Channel" .
6. Select the items to be saved with the settings. Either the settings for the currently selected "Channel" only, or the settings for all "Channel" s can be stored. Various other items, such as lines or traces etc., can be stored as well (see [Chapter 9.3.2.1, "Stored Data Types"](#), on page 506).
7. Select "Save" .

A file with the defined name and path and the extension `.dfl` is created.



If you make any changes to the settings *after* storing the configuration file, remember to save the settings again. Otherwise those settings cannot be restored and will be overwritten by the stored values when the configuration file is recalled.

#### To recall configurable instrument settings

1. Select the  "Open" icon from the toolbar.
2. In the "Recall" dialog box, switch to the "Recall" tab.



- In the file selection dialog box, select the filename and storage location of the settings file.

**Note:** The "File Type" indicates whether the file contains instrument settings for **all** "Channel" s, or only those for the current "Channel" .

- If several items were saved, select which items are restored.
- If a "Channel" was saved, select whether the settings will replace the settings in the current "Channel" , or whether a new channel with the saved settings will be opened.
- Select "Recall" .

The settings and selected items from the saved measurement are restored and you can repeat the measurement with the same settings.

Note that any changes made to the settings *after* storing the configuration file will be overwritten by the stored values when the configuration file is recalled.

#### To recall settings automatically after preset or reboot

You can define the settings that are restored when you preset or reboot the instrument.

- Configure the settings as required and save them as described in ["To save configurable instrument settings"](#) on page 512.
- In the "Save/Recall" menu, select "Startup Recall" .
- From the file selection dialog box, select the recall settings to restore.
- Select "Select File" .
- Set "Startup Recall" to "On" .

Now when you press the PRESET key or reboot the instrument, the defined settings will be restored.

- To restore the factory preset settings, set "Startup Recall" to "Off" .

## 9.4 Import/Export Functions



**Access:** "Save" / "Open" icon in the toolbar > "Import" / "Export"



The R&S FPS provides various evaluation methods for the results of the performed measurements. However, you may want to evaluate the data with further, external applications. In this case, you can export the measurement data to a standard format file (ASCII or XML). Some of the data stored in these formats can also be re-imported to the R&S FPS for further evaluation later, for example in other applications.

The following data types can be exported (depending on the application):

- Trace data
- Table results, such as result summaries, marker peak lists etc.
- I/Q data

The following data types can be imported (depending on the application):

- I/Q data



I/Q data can only be imported and exported in applications that process I/Q data, such as the I/Q Analyzer or optional applications.

See the corresponding user manuals for those applications for details.



These functions are only available if no measurement is running.

In particular, if [Continuous Sweep / Run Cont](#) is active, the import/export functions are not available.

|                                    |     |
|------------------------------------|-----|
| Import .....                       | 514 |
| Export .....                       | 514 |
| L Export Trace to ASCII File ..... | 514 |
| L Trace Export Configuration ..... | 515 |
| L I/Q Export .....                 | 515 |



### Import

**Access:** "Save/Recall" > Import



Provides functions to import data.

Importing I/Q data is not possible in MSRA operating mode.

See the R&S FPS I/Q Analyzer User Manual for more information.



### Export

**Access:** "Save/Recall" > Export



Opens a submenu to configure data export.

#### Export Trace to ASCII File ← Export

Opens a file selection dialog box and saves the selected trace in ASCII format (.dat) to the specified file and directory.

The results are output in the same order as they are displayed on the screen: window by window, trace by trace, and table row by table row.

If the spectrogram display is selected when you perform this function, the entire histogram buffer with all frames is exported to a file. The data for a particular frame begins with information about the frame number and the time that frame was recorded. For large history buffers the export operation may take some time.

For details on the file format in the Spectrum application, see [Chapter 8.6.6, "Reference: ASCII File Export Format"](#), on page 495.

**Note:** Secure user mode.

In secure user mode, settings that are stored on the instrument are stored to volatile memory, which is restricted to 256 MB. Thus, a "memory limit reached" error can occur although the hard disk indicates that storage space is still available.

To store data permanently, select an external storage location such as a USB memory device.

For details, see [Chapter 4.1.6, "Protecting Data Using the Secure User Mode"](#), on page 33.

Remote command:

[MMEMemory:STORe<n>:TRACe](#) on page 859

[MMEMemory:STORe<n>:SPECTrogram](#) on page 965

#### **Trace Export Configuration ← Export**

Opens the "Traces" dialog box to configure the trace and data export settings.

#### **I/Q Export ← Export**

Opens a file selection dialog box to define an export file name to which the I/Q data is stored. This function is only available in single sweep mode.

It is not available in the Spectrum application, only in applications that process I/Q data, such as the I/Q Analyzer or optional applications.

For details, see the description in the R&S FPS I/Q Analyzer User Manual ("Importing and Exporting I/Q Data").

**Note:** MSRA operating mode. Importing I/Q data is not possible in MSRA operating mode.

**Note:** Storing large amounts of I/Q data (several Gigabytes) can exceed the available (internal) storage space on the R&S FPS. In this case, it can be necessary to use an external storage medium.

**Note:** Secure user mode.

In secure user mode, settings that are stored on the instrument are stored to volatile memory, which is restricted to 256 MB. Thus, a "memory limit reached" error can occur although the hard disk indicates that storage space is still available.

To store data permanently, select an external storage location such as a USB memory device.

For details, see [Chapter 4.1.6, "Protecting Data Using the Secure User Mode"](#), on page 33.

## **9.5 Creating Screenshots of Current Measurement Results and Settings**

To document the graphical results and the most important settings for the currently performed measurement, you can create a screenshot of the current display. Screenshots can either be printed or stored to a file.

- [Print and Screenshot Settings](#).....515
- [How to Store or Print Screenshots of the Display](#)..... 526
- [Example for Storing Multiple Measurement Results to a PDF File](#)..... 529

### **9.5.1 Print and Screenshot Settings**



**Access:** "Print" icon in the toolbar

For step-by-step instructions, see [Chapter 9.5.2, "How to Store or Print Screenshots of the Display"](#), on page 526.

Remote commands for these settings are described in [Chapter 12.9.4, "Storing or Printing Screenshots"](#), on page 951.



To print a screenshot of the current display with the current settings immediately, without switching to the "Print" menu, use the "Print immediately" icon in the toolbar.

- [Print Content Settings](#)..... 516
- [Print Preview Functions](#)..... 519
- [Printer Settings](#).....521
- [Page Setup](#)..... 524
- [Print Color Settings](#)..... 525

### 9.5.1.1 Print Content Settings



**Access:** "Print" > "Print Config" > "Content" tab

The content settings determine which data is included in the printout.

Note that some content settings are independent of the selected printing device, others are printing device-specific.

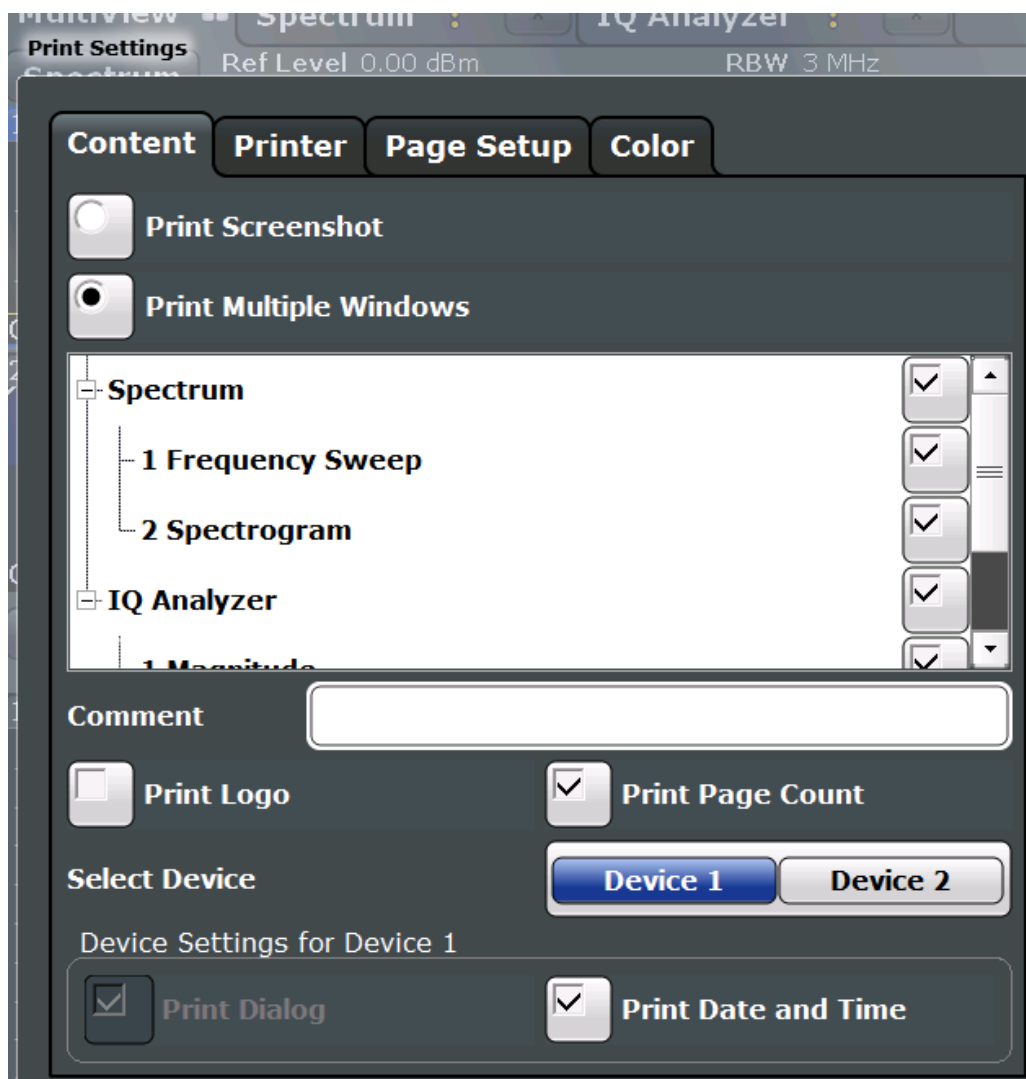

|                              |     |
|------------------------------|-----|
| Print Screenshot .....       | 517 |
| Print Multiple Windows ..... | 518 |
| Comment .....                | 518 |
| Print Logo .....             | 518 |
| Print Page Count .....       | 518 |
| Select Device 1/2 .....      | 518 |
| Print Dialog .....           | 519 |
| Print Date and Time .....    | 519 |

**Print Screenshot**

Selects all measurement results displayed on the screen for the current channel (or "MultiView" ): diagrams, traces, markers, marker lists, limit lines, etc., including the channel bar and status bar, for printout on a single page. Displayed items belonging to the software user interface (e.g. softkeys) are not included. The position and size of the elements in the printout is identical to the display.

This setting is independent of the printing device.

Remote command:

`HCOP:CONT HCOP`

### Print Multiple Windows

Includes only the selected windows in the printout. All currently active windows for the current channel (or "MultiView" ) are available for selection. How many windows are printed on a single page of the printout is user-definable (see " [Windows Per Page](#) " on page 525).

This option is only available when printing on a printer or to a PDF file (see " [Destination](#) " on page 523). If the [Destination](#) is currently set to an image file or the clipboard for the selected printing device, it is automatically changed to be a PDF file.

Remote command:

`HCOP:CONT WIND`

`HCOPY:PAGE:WINDow<device>:STATe` on page 960

`HCOPY:PAGE:WINDow<device>:CHANnel:STATe` on page 959

### Comment

Defines an optional comment to be included in the printout of the display. Maximum 120 characters are allowed. Up to 60 characters fit in one line. In the first line, a manual line-feed can be forced at any point by entering "@".

The comment is printed in the top left corner of each printout page. If a comment should not be printed, it must be deleted.

This setting is independent of the printing device.

**Tip:** The current date and time can be inserted automatically, see " [Print Date and Time](#) " on page 519.

Remote command:

`HCOPY:ITEM:WINDow:TEXT` on page 956

### Print Logo

Activates/deactivates the printout of the Rohde & Schwarz company logo in the upper right corner.

This setting is independent of the printing device.

Remote command:

`DISPlay:LOGO` on page 952

### Print Page Count

Includes the page number for printouts consisting of multiple windows (" [Print Multiple Windows](#) " on page 518).

This setting is independent of the printing device.

Remote command:

`HCOPY:PAGE:COUNt:STATe` on page 957

### Select Device 1/2

Selects the printing device to be configured.

Two different printout devices can be configured, for example one for printing and one for storage to a file. When you execute the "Print immediately" function, the selected printing device and its settings determine the behavior of the R&S FPS.

**Print Dialog**

Includes any currently displayed dialog in the screenshot printout.

This setting is (printing) device-specific and only available if [Print Screenshot](#) is selected.

**Print Date and Time**

Includes or removes the current date and time at the bottom of the printout.

This setting is (printing) device-specific.

Remote command:

`HCOPY:TDSTamp:STATe<device>` on page 961

### 9.5.1.2 Print Preview Functions



**Access:** "Print"

The "Print Preview" of the printout according to the current configuration is available in all "Print Settings" dialog tabs.

The preview display (not the functions) is device-specific (see "[Select Device 1/2](#)" on page 518).

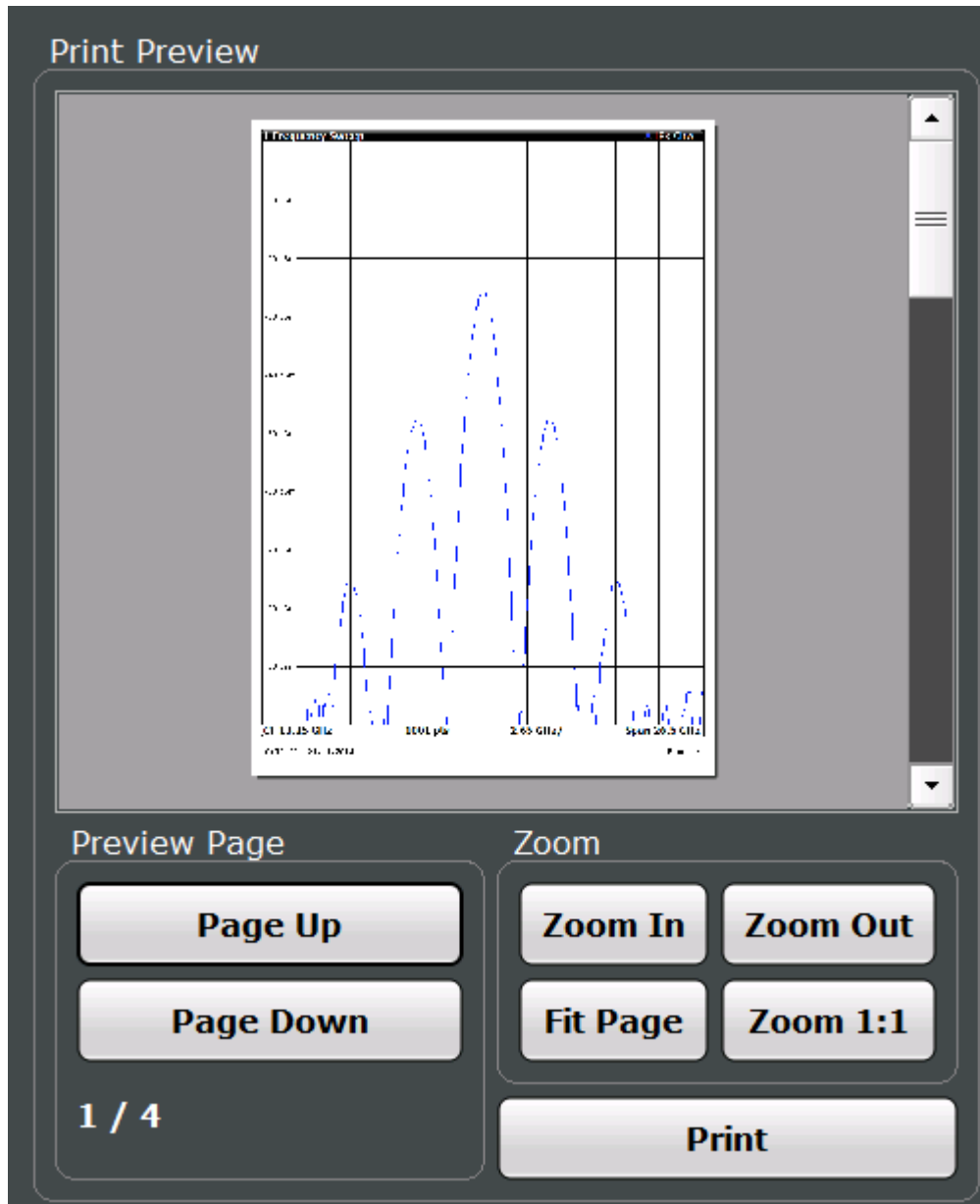

|                           |     |
|---------------------------|-----|
| Zoom In / Zoom Out .....  | 520 |
| Fit Page .....            | 521 |
| Zoom 1:1 .....            | 521 |
| Page Up / Page Down ..... | 521 |
| Print .....               | 521 |

**Zoom In / Zoom Out**

Zooms into (enlarges) or zooms out of (decreases) the preview display. Note that the zoom functions affect only the preview, not the printout itself.



**Fit Page**

Adapts the preview display zoom factor so that one complete page is visible as large as possible in the available display space. Note that the zoom functions affect only the preview, not the printout itself.

**Zoom 1:1**

Displays the printout in its original size, as it will be printed.

**Page Up / Page Down**

Depending on the selected contents (see [Chapter 9.5.1.1, "Print Content Settings"](#), on page 516), the printout can consist of multiple pages. Use these functions to scroll within the preview to see the individual pages.

**Print**

Starts to print or store the selected screen contents to a file (see [Chapter 9.5.1.1, "Print Content Settings"](#), on page 516).

Whether the output is sent to the printer or stored in a file or the clipboard depends on the selected printing device and the printing device settings (see [Chapter 9.5.1.3, "Printer Settings"](#), on page 521).

If the output is stored to a file, a file selection dialog box is opened to select the file-name and location. The default path is C:\R\_S\INSTR\USER.

Remote command:

`HCOPY[:IMMEDIATE<device>]` on page 956

`HCOPY[:IMMEDIATE<device>]:NEXT` on page 956

### 9.5.1.3 Printer Settings



**Access:** "Print" > "Print Config" > "Printer" tab

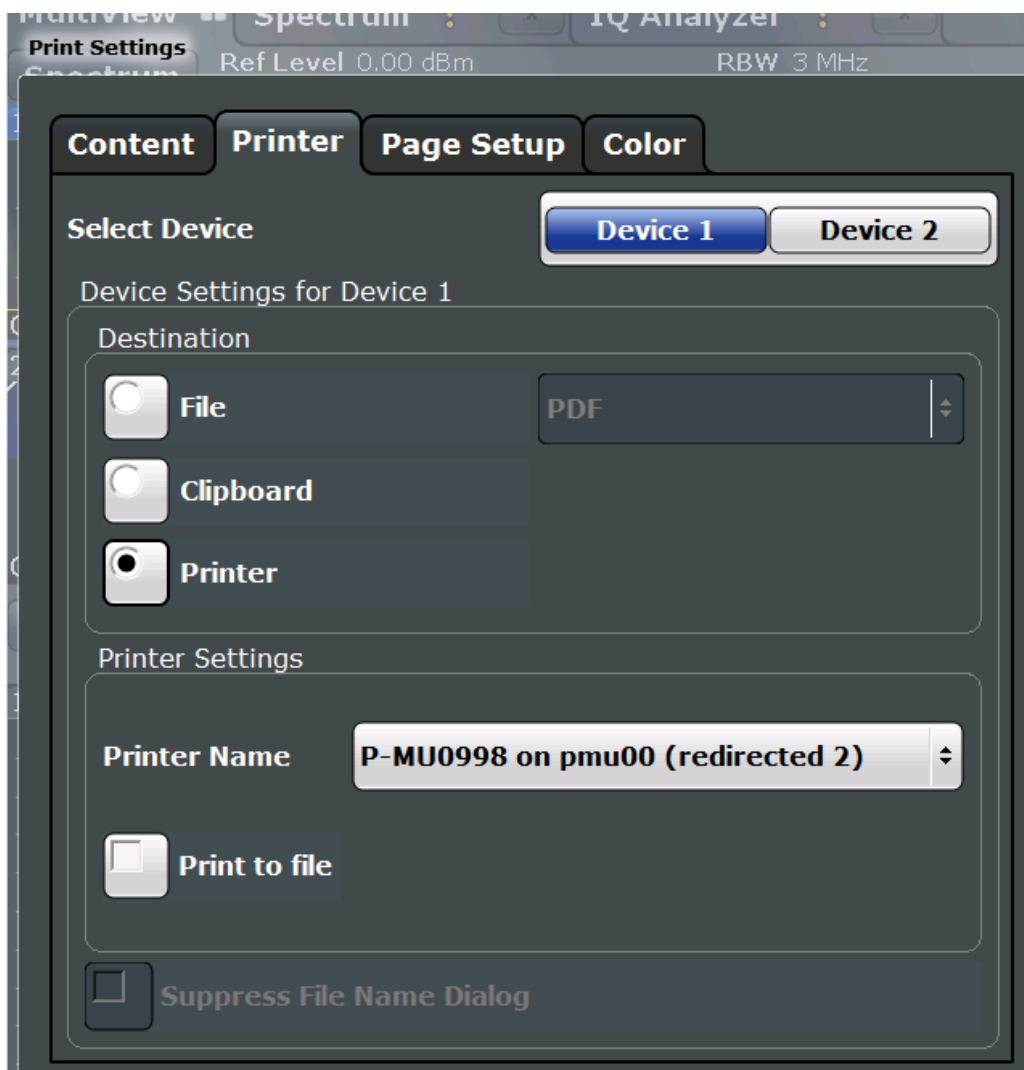

Printer settings are (printing) device-specific. That means you can configure two different printing devices (for example, a printer and a file) and switch between configurations easily simply by selecting the appropriate device before printing.

|                                 |     |
|---------------------------------|-----|
| Select Device 1/2 .....         | 522 |
| Destination .....               | 523 |
| Suppress File Name Dialog ..... | 523 |
| Printer Name .....              | 523 |
| Print to file .....             | 523 |
| Install Printer .....           | 523 |

**Select Device 1/2**

Selects the printing device to be configured.

Two different printout devices can be configured, for example one for printing and one for storage to a file. When you execute the "Print immediately" function, the selected printing device and its settings determine the behavior of the R&S FPS.

**Destination**

Defines the medium to which the printout is output.

- "File" Stores the printout to a file in the selected format. The filename is queried at the time of storage, or a default name is used (see [Suppress File Name Dialog](#) ).  
Multiple windows can only be printed to a file in PDF format. If you select an image file format, the content setting is automatically set to [Print Screenshot](#) . Page settings are not available for image files; however, you can configure the colors used for the screenshot (see [Chapter 9.5.1.5, "Print Color Settings"](#), on page 525).
- "Clipboard" Copies the printout to the clipboard. Since only single pages can be copied, only screenshots can be copied to this destination, not multiple windows (see [Chapter 9.5.1.1, "Print Content Settings"](#), on page 516). Page settings are not available; however, you can configure the colors used for the screenshot (see [Chapter 9.5.1.5, "Print Color Settings"](#), on page 525).  
If you select the clipboard as the printing destination, the content setting is automatically set to [Print Screenshot](#) .
- "Printer" Sends the printout to the printer selected from the [Printer Name](#) list.

Remote command:

[HCOPY:DESTination<device>](#) on page 955

[HCOPY:DEVIce:LANGUage<device>](#) on page 955

**Suppress File Name Dialog**

If the [Destination](#) is a file, the file selection dialog box is not displayed. Instead, the default storage location and filename are used.

**Printer Name**

Defines the printer to print to if a printer is selected as the [Destination](#) .

Any printers detected in the network are listed for selection.

**Tip:** the printout can also be stored in a print file using the selected printer driver, see "[Print to file](#)" on page 523.

Remote command:

[SYSTEM:COMMUnicate:PRINter:ENUMerate\[:NEXT\]?](#) on page 962

[SYSTEM:COMMUnicate:PRINter:ENUMerate:FIRSt?](#) on page 961

[SYSTEM:COMMUnicate:PRINter:SElect<device>](#) on page 962

**Print to file**

If a printer is selected as the [Destination](#) , use this option to store the data in a `.prn` file using the selected printer driver.

**Install Printer**

This softkey opens the standard Windows dialog box to install a new printer. All printers that are already installed are displayed.

Only user accounts with administrator rights can install a printer.

For further information, refer to the Microsoft Windows documentation.

9.5.1.4 Page Setup



Access: "Print" > "Print Config" > "Page Setup" tab

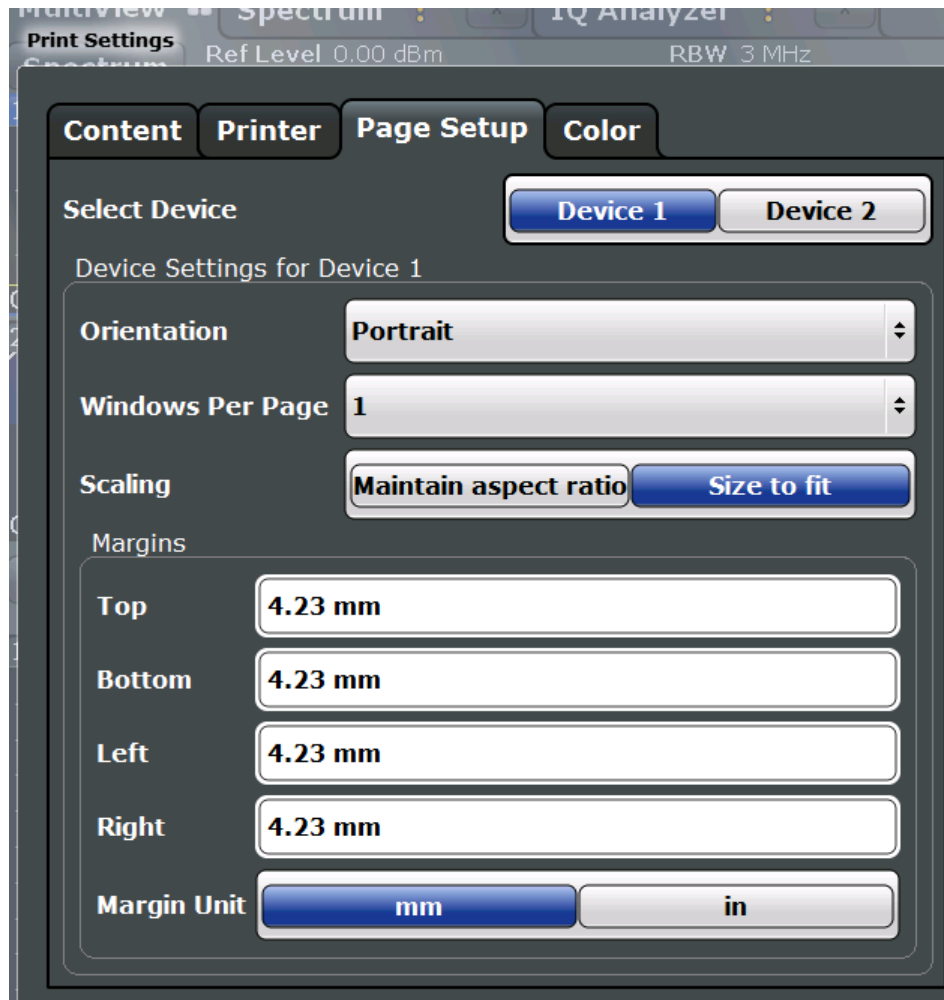

Page settings are (printing) device-specific. That means you can configure two different printing devices (for example, a printer and a file) and switch between configurations easily simply by selecting the appropriate device before printing.

Page settings are only available when printing on a printer or to a PDF file (see " Destination " on page 523).

|                         |     |
|-------------------------|-----|
| Select Device 1/2 ..... | 524 |
| Orientation .....       | 525 |
| Windows Per Page .....  | 525 |
| Scaling .....           | 525 |
| Margins .....           | 525 |

**Select Device 1/2**

Selects the printing device to be configured.

Two different printout devices can be configured, for example one for printing and one for storage to a file. When you execute the "Print immediately" function, the selected printing device and its settings determine the behavior of the R&S FPS.

### Orientation

Selects the page orientation of the printout: portrait or landscape.

Remote command:

`HCOPY:PAGE:ORIENTATION<device>` on page 959

### Windows Per Page

Defines how many windows are displayed on a single page of the printout. This setting is only available if [Print Multiple Windows](#) is active (see [Chapter 9.5.1.1, "Print Content Settings"](#), on page 516).

If more than one window is printed on one page, each window is printed in equal size.

Remote command:

`HCOPY:PAGE:WINDOW<device>:COUNT` on page 960

### Scaling

Determines the scaling of the windows in the printout if [Print Multiple Windows](#) is active (see [Chapter 9.5.1.1, "Print Content Settings"](#), on page 516).

If more than one window is printed on one page (see [Windows Per Page](#)), each window is printed in equal size.

"Maintain aspect ratio" Each window is printed as large as possible while maintaining the aspect ratio of the original display.

"Size to fit" Each window is scaled to fit the page size optimally, not regarding the aspect ratio of the original display.

Remote command:

`HCOPY:PAGE:WINDOW<device>:SCALE` on page 960

### Margins

Defines margins for the printout page on which no elements are printed. The margins are defined according to the selected unit.

Remote command:

`HCOPY:PAGE:MARGIN<device>:BOTTOM` on page 957

`HCOPY:PAGE:MARGIN<device>:LEFT` on page 957

`HCOPY:PAGE:MARGIN<device>:RIGHT` on page 958

`HCOPY:PAGE:MARGIN<device>:TOP` on page 958

`HCOPY:PAGE:MARGIN<device>:UNIT` on page 958

#### 9.5.1.5 Print Color Settings



**Access:** "Print" > "Print Config" > "Color" tab

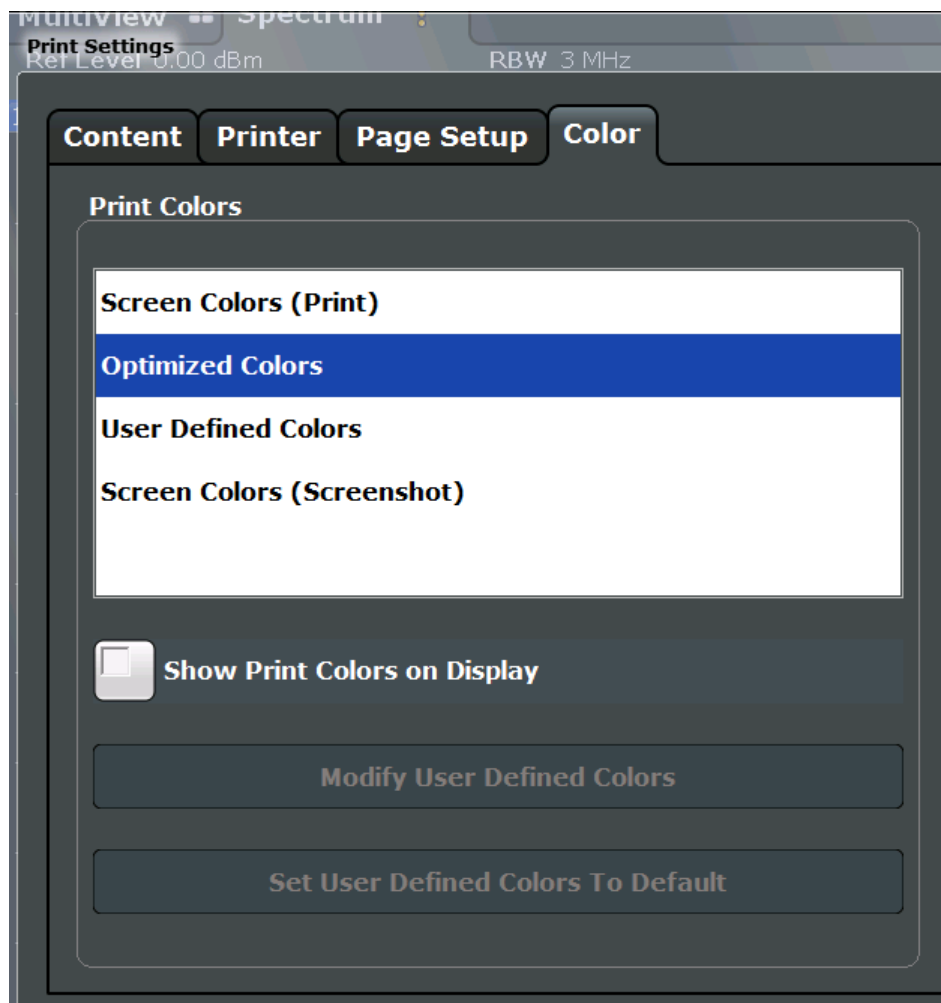

The settings provided here are identical to those in the "Print Colors" section of the "Display" > "Theme + Color" dialog box.

See "[Print Colors](#)" on page 542.

### 9.5.2 How to Store or Print Screenshots of the Display

The measurement results displayed on the screen can be printed or stored to a file very easily.

Two different scenarios can be configured in parallel, assigned to different printing devices. You can then perform one or the other simply by selecting the corresponding printing device and the "Print" function.



#### To start printing or storing results to a file

- ▶ If the R&S FPS has already been set up according to your current requirements, simply press the "Print immediate" icon (🖨️) at the far right end of the toolbar.

The current measurement display is printed or stored to a file, as configured.

### To print a screenshot

This configuration assumes a printer has already been installed. To install a new printer, use the [Install Printer](#) function (common Microsoft Windows procedure).

1. Select the  "Printer" tool in the toolbar.  
The "Print Settings" dialog box is displayed.
2. Select "Device 1" or "Device 2" to define which printing device you want to configure.  
(Note: Some settings are independent of the printing-device.)
3. In the "Content" tab, define the elements of the screen and additional information to be included in the printout.
  - a) Select "Print Screenshot" to include all elements displayed on the screen in a single-page printout.
  - b) Optionally, add a comment to be printed at the top of the printout.
  - c) Optionally, activate the date and time or the logo so they are added to the printout.
  - d) Optionally, activate "Print Dialog" to include any dialog boxes currently displayed on the screen in the printout. This is useful, for example, to document the used settings for a particular result.
  - e) Check the "Print Preview" to make sure all relevant elements of the display are visible.
4. In the "Printer" tab, select "Printer" as the "Destination" .
5. Select the "Printer Name" to print to from the list of installed printers.
6. In the "Page Setup" tab, configure the layout of the printout page.
  - a) Select the page orientation.
  - b) Define the page margins.
  - c) Check the "Print Preview" to make sure all relevant elements of the display are visible.
7. In the "Color" tab, define the colors to be used for the printout.
  - a) By default, "Optimized Colors" are used to improve the visibility of the colors. The background is always printed in white and the grid in black. For a printout that reflects exactly what you see on the screen, select "Screen Colors (Screenshot)" .
  - b) Check the "Print Preview" to find out if the setting is appropriate.
8. Select "Print" to execute the print function.  
The screenshot is printed on the printer as configured.
9. To print another screenshot using the same configuration any other time, simply press the "Print immediate" icon () at the far right end of the toolbar.  
If you use different printing scenarios alternately, perform the following steps to print another screenshot:
  - a) Select the  "Printer" tool in the toolbar.

- b) Select "Device 1" or "Device 2" to select the configured printing device.
- c) Select "Print" to execute the print function.

### To store a printout containing multiple windows

1. Select the  "Printer" tool in the toolbar.  
The "Print Settings" dialog box is displayed.
2. Select "Device 1" or "Device 2" to define which printing device you want to configure.
3. In the "Content" tab, define the elements of the screen and additional information to be included in the printout.
  - a) Select "Print Selected Windows" to include the selected windows in the printout, possibly on multiple pages.
  - b) Select the result displays in the currently selected channel to be included in the printout.  
**Tip:** Select the "MultiView" before configuring the printout to include result displays from any active channel.
  - c) Optionally, add a comment to be printed at the top of each page of the printout.
  - d) Optionally, activate the date and time or the logo so they are added to the printout pages.
4. Check the "Print Preview" to make sure all required result displays are included.
  - a) Scroll through the individual pages of the printout using "Page Up" and "Page Down" .
  - b) Use the zoom functions to make sure all relevant parts of the result display are visible.
5. In the "Printer" tab, select "File" as the "Destination" .
6. Select the file format from the selection list.
7. By default, you define the filename individually for each print operation. To avoid having the "File Selection" dialog box being displayed for each print operation, select "Suppress File Name Dialog" . In this case, the previously used or default storage location and filename are used.
8. In the "Page Setup" tab, configure the layout of the printout page.
  - a) Select the page orientation.
  - b) Define the page margins.
  - c) Check the "Print Preview" to make sure all relevant elements of the display are visible.
9. In the "Color" tab, define the colors to be used for the printout.
  - a) By default, "Optimized Colors" are used to improve the visibility of the colors. The background is always printed in white and the grid in black. For a printout that reflects the colors you see on the screen, but with a white background, select "Screen Colors (Print)" .
  - b) Check the "Print Preview" to find out if the setting is appropriate.



10. Select "Print" to execute the print function.
11. If you did not select the option to suppress the dialog, enter a filename in the file selection dialog box.

The selected data elements are stored to the file as configured.

12. To store another file using the same configuration any other time, simply press the "Print immediate" icon (🖨️) at the far right end of the toolbar.

If you use different printing scenarios alternately, perform the following steps to store another file:

- a) Select the 🖨️ "Printer" tool in the toolbar.
- b) Select "Device 1" or "Device 2" to select the configured printing device.
- c) Select "Print" to execute the print function.

### 9.5.3 Example for Storing Multiple Measurement Results to a PDF File

The following example describes the procedure to store results from measurements in the Spectrum application and the I/Q Analyzer to a single PDF file.

1. Configure and perform the measurements in the Spectrum application and I/Q Analyzer as required. Configure at least the following result displays:
  - Frequency Sweep, Spectrogram (Spectrum)
  - Magnitude, Spectrum (I/Q Analyzer)
2. Switch to the "MultiView" tab to display an overview of the result displays in all active channels.

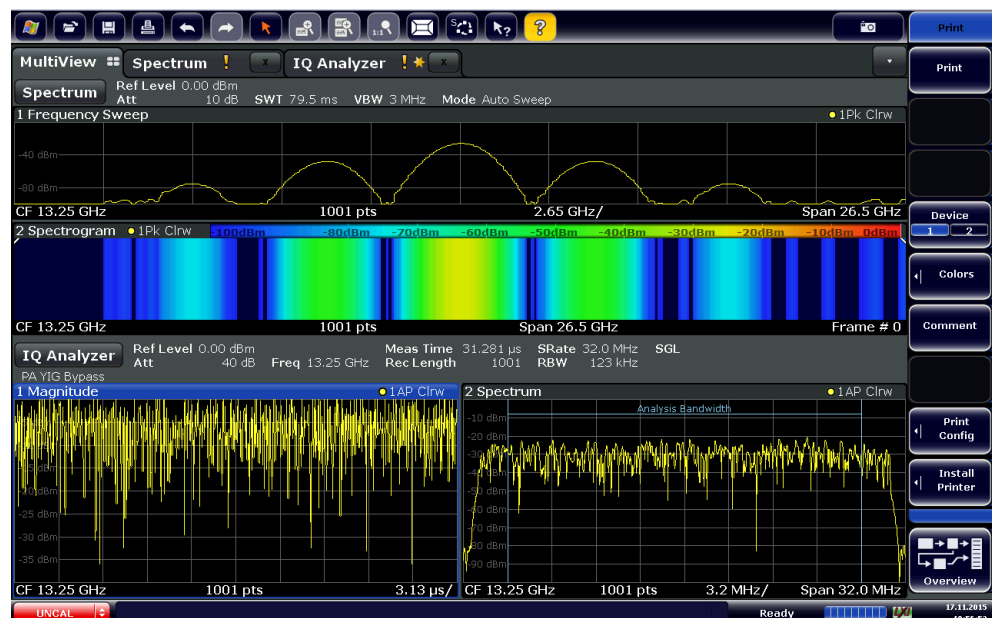

3. Select the 🖨️ "Printer" tool in the toolbar.  
The "Print Settings" dialog box is displayed.

4. Select "Device 1" to configure the settings for this printing device.
5. In the "Content" tab, select "Print Selected Windows" .
6. Select the result displays listed in [step 1](#).
7. Enter the comment *Measurement Test Report* to be inserted at the top of each page.
8. Select "Print Page Count" and "Print Date and Time" .
9. In the "Content" tab, select "Print Selected Windows" .
10. In the "Printer" tab, select "File" as the "Destination" .
11. Select "PDF" from the file format selection list.
12. Select "Suppress File Name Dialog" .
13. In the "Page Setup" tab, select "Landscape" as the "Orientation" .
14. Select "Windows Per Page" : 1 to print a single result display on each page.
15. Select the "Scaling" option "Size to fit" to maximize the result display on each page.
16. In the "Color" tab, select "Screen Colors (Print)" for a printout that reflects the colors you see on the screen, but with a white background.
17. Check the "Print Preview" to make sure all required result displays are included and all relevant data elements are visible.
  - a) Scroll through the individual pages of the printout using "Page Up" and "Page Down" .
  - b) Use the zoom functions to make sure all relevant parts of the result display are visible.
18. Select "Print" to execute the print function.

The selected data elements are stored to the file as configured.

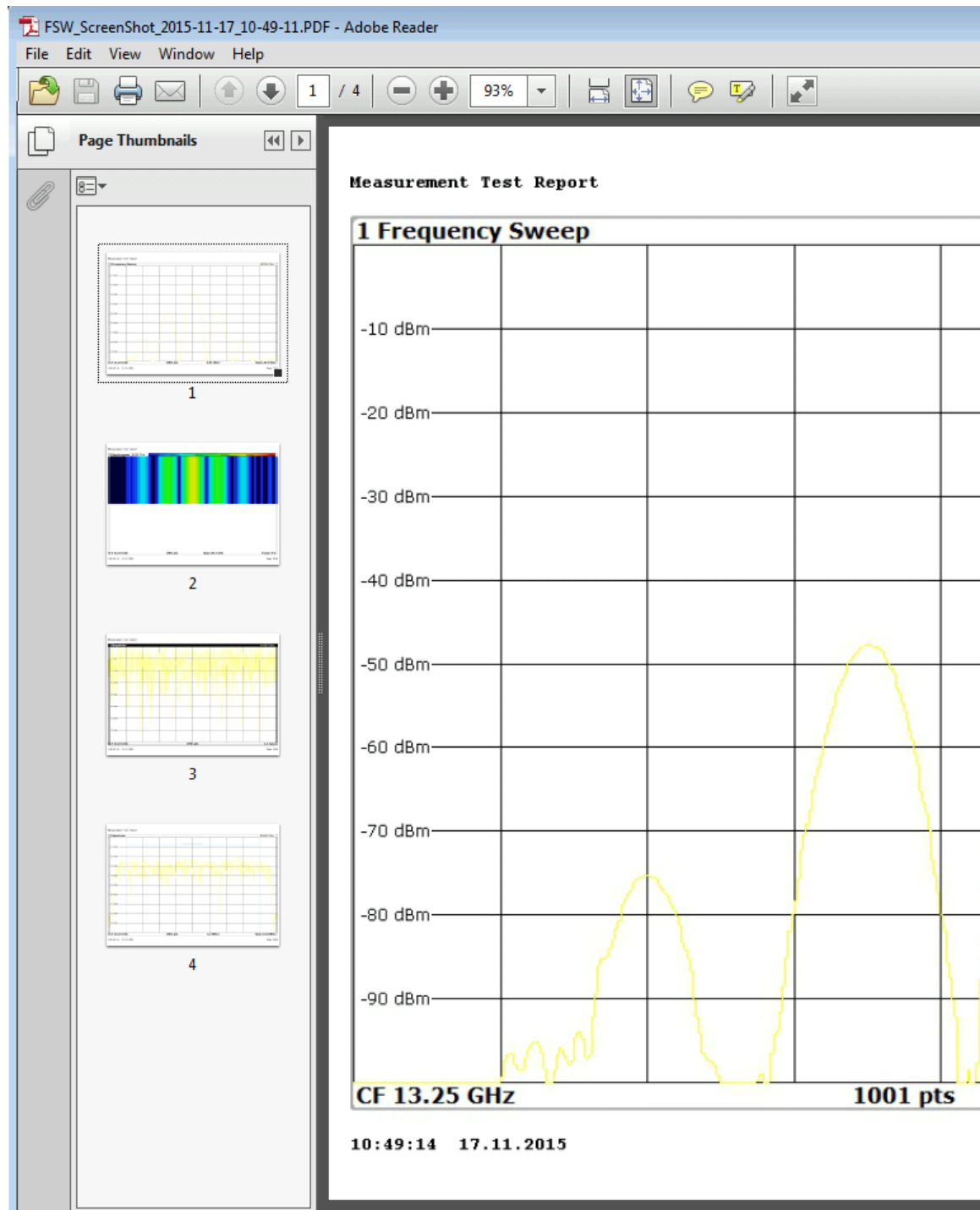

# 10 General Instrument Setup

**Access:** SETUP

Some basic instrument settings can be configured independently of the selected operating mode or application. Usually, you will configure most of these settings initially when you set up the instrument according to your personal preferences or requirements and then only adapt individual settings to special circumstances when necessary. Some special functions are provided for service and basic system configuration.



## Network and Remote Settings, Display Settings

Settings for network and remote operation are described in [Chapter 11, "Network and Remote Operation"](#), on page 574.

Display settings are described in [Chapter 10.2.1, "Display Settings"](#), on page 535.



Some of the following settings and functions are also available directly on the R&S FPS, via the miniature display. See [Chapter 4.3, "Miniature Display"](#), on page 41.

- [Alignment](#)..... 532
- [Display Settings](#)..... 535
- [Transducers](#)..... 546
- [Reference Frequency Settings](#)..... 558
- [System Configuration Settings](#)..... 559
- [Service Functions](#)..... 566

## 10.1 Alignment

### 10.1.1 Basics on Alignment

When you put the instrument into operation for the first time, align the data to a reference source.

The correction data and characteristics required for the alignment are determined by the firmware. It compares the results at different settings with the known characteristics of the high-precision calibration signal source at 64 MHz.



During instrument start, the firmware checks whether the installed hardware is supported. If not, an error message is displayed ( "Wrong Firmware Version" ) and you are asked to update the firmware. Until the firmware version is updated, self-alignment fails.



If you start a self-alignment remotely and then select the "Local" softkey while the alignment is still running, the instrument only returns to the manual operation state after the alignment is completed.

### Alignment results

The alignment results are displayed and contain the following information:

- Date and time of last correction data record
- Overall results of correction data record
- List of found correction values according to function/module

The results are classified as follows:

|               |                                                                                                                    |
|---------------|--------------------------------------------------------------------------------------------------------------------|
| <b>PASSED</b> | Calibration successful without any restrictions                                                                    |
| <b>CHECK</b>  | Deviation of correction value larger than expected, correction could however be performed                          |
| <b>FAILED</b> | Deviations of correction value too large, no correction was possible. The found correction data is not applicable. |

The results are available until the next self-alignment process is started or the instrument is switched off.

## 10.1.2 Alignment Settings

**Access:** SETUP > "Alignment"

The instrument can be aligned when necessary (see [Chapter 10.1.1, "Basics on Alignment"](#), on page 532).

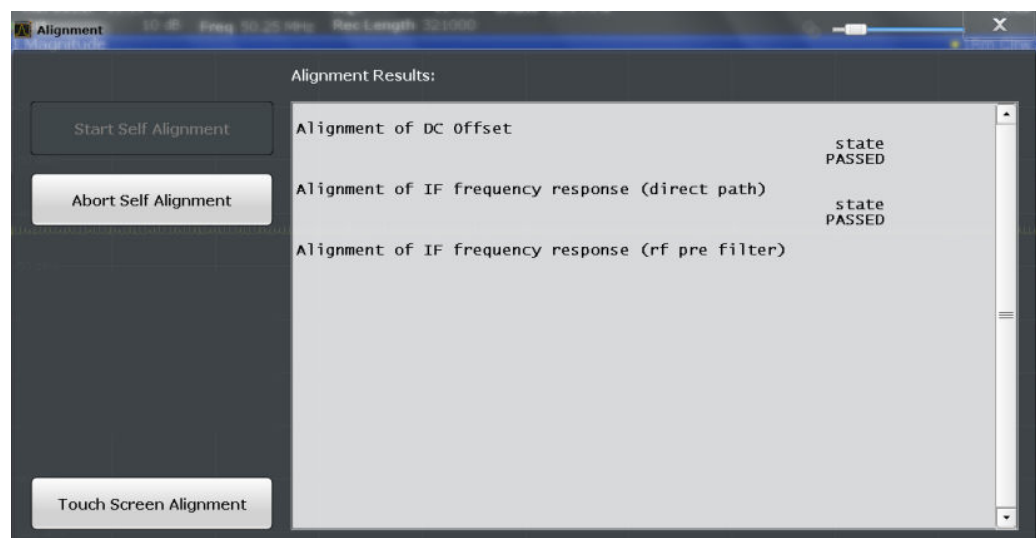



### Self-alignment results in secure user mode

Be sure to store self-alignment results before [SecureUser Mode](#) is enabled; see [Chapter 4.1.6, "Protecting Data Using the Secure User Mode"](#), on page 33.

In secure user mode, the results are not stored permanently. Thus, if the currently stored self-alignment results are not suitable, you must perform a self-alignment each time you switch on the R&S FPS.

|                                            |     |
|--------------------------------------------|-----|
| <a href="#">Start Self Alignment</a> ..... | 534 |
| <a href="#">Abort Self Alignment</a> ..... | 534 |
| <a href="#">Alignment Results:</a> .....   | 534 |

### Start Self Alignment

Starts recording correction data for the instrument. If the correction data acquisition fails or if the correction values are deactivated, a corresponding message is displayed in the status field.

For details, see [Chapter 10.1.1, "Basics on Alignment"](#), on page 532.

#### Note:

A running Sequencer operation is aborted when you start a self-alignment.

Remote command:

[\\*CAL?](#) on page 619, see also [CALibration\[:ALL\]?](#) on page 971

### Abort Self Alignment

As long as the self-alignment data is being collected, the procedure can be canceled using the "Abort Self Alignment" button.

**Note:** If you start a self-alignment remotely, then select the "Local" softkey while the alignment is still running, the instrument only returns to the manual operation state after the alignment is completed. In this case, you cannot abort a self-alignment manually.

### Alignment Results:

Information on whether the alignment was performed successfully and on the applied correction data is displayed. The results are available until the next self-alignment process is started or the instrument is switched off.

Remote command:

[CALibration:RESult?](#) on page 971

## 10.1.3 How to Perform a Self-Test

You do not have to repeat the self-test every time you switch on the instrument. It is only necessary when instrument malfunction is suspected.



### Operating temperature

Before performing this functional test, make sure that the instrument has reached its operating temperature (for details, refer to the data sheet).

1. Press the SETUP key.
2. Press the "Service" softkey.
3. Press the "Selftest" softkey.

Once the instrument modules have been checked successfully, a message is displayed.

### 10.1.4 How to Align the Instrument



#### Operating temperature

Before performing this functional test, make sure that the instrument has reached its operating temperature (for details, refer to the data sheet).

#### To perform a self-alignment

1. Press the SETUP key.
2. Select the "Alignment" softkey.
3. Select the "Start Self Alignment" button.
4. To abort the self-alignment process, select the "Abort Self Alignment" button.

Once the system correction values have been calculated successfully, a message is displayed.



#### To display the alignment results again later

- Press the SETUP key.
- Press the "Alignment" softkey.

## 10.2 Display Settings

### 10.2.1 Display Settings

**Access:** SETUP > "Display"

Some general display settings are available regardless of the current application or operating mode. For information on optimizing your display for measurement results, see [Chapter 8.1, "Result Display Configuration"](#), on page 393.

- [General Display Settings](#).....536
- [Displayed Items](#).....536
- [Display Theme and Colors](#).....540

### 10.2.1.1 General Display Settings

**Access:** SETUP > "Display" > "General"

This section includes general screen display behavior and date and time display.

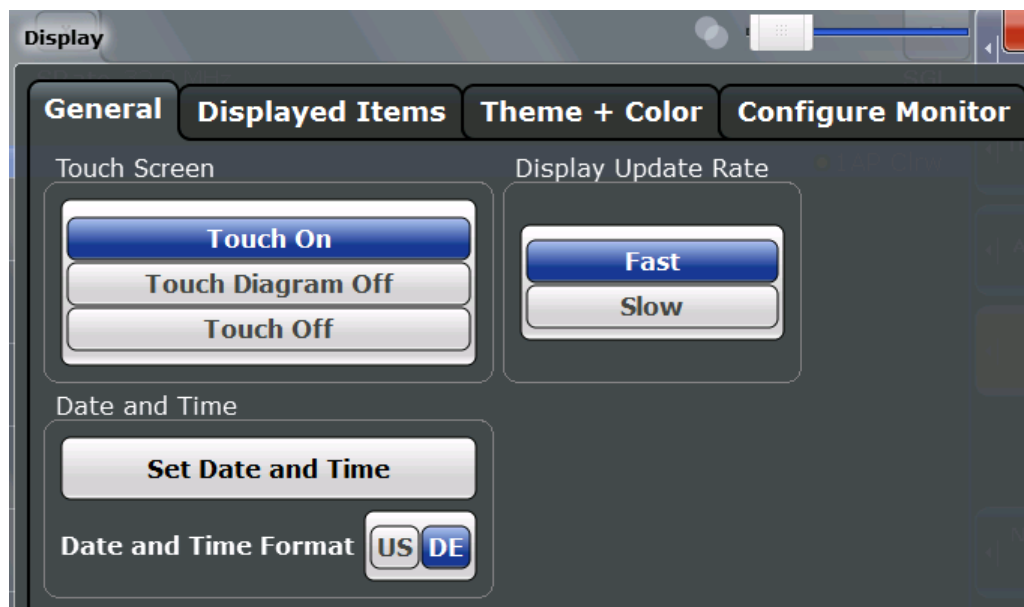

|                            |     |
|----------------------------|-----|
| Display Update Rate .....  | 536 |
| Set Date and Time .....    | 536 |
| Date and Time Format ..... | 536 |

#### Display Update Rate

By default, a fast update rate ensures the most recent measurement results on the display. However, when performance is poor due to slow data transfer (for example during remote control), it can be helpful to decrease the frequency with which the screen display is updated.

#### Set Date and Time

The current date and time on the instrument is set using the standard Windows "Date and Time Properties" dialog box. Select the "Set Date and Time" button in the "Display" dialog box, or select the date and time display in the status bar to open the Windows dialog box.

#### Date and Time Format

Switches the time and date display on the screen between US and German (DE) format.

Remote command:

`DISPlay[:WINDow]:TIME:FORMat` on page 980

### 10.2.1.2 Displayed Items

**Access:** SETUP > "Display" > "Displayed Items"



Several elements on the screen display can be hidden or shown as required, for example to enlarge the display area for the measurement results.



|                                   |     |
|-----------------------------------|-----|
| Toolbar .....                     | 537 |
| Status Bar .....                  | 537 |
| Softkey Bar .....                 | 538 |
| Channel Bar .....                 | 538 |
| Diagram Footer (Annotation) ..... | 538 |
| Date and Time .....               | 538 |
| Front Panel .....                 | 538 |
| Mini Front Panel .....            | 539 |

**Toolbar**

The toolbar provides access to frequently used functions via icons at the top of the screen. Some functions, such as zooming, finding help, printing screenshots or storing and loading files are not accessible at all without the toolbar.

Remote command:

[DISPlay:TBAR\[:STATe\]](#) on page 980

**Status Bar**

The status bar beneath the diagram indicates the global instrument settings, the instrument status and any irregularities during measurement or display.

Some of the information displayed in the status bar can be queried from the status registry via remote commands, see [Chapter 12.11, "Using the Status Register"](#), on page 996.

Remote command:

`DISPlay:SBAR[:STATe]` on page 979

### Softkey Bar

Softkeys are virtual keys provided by the software. Thus, more functions can be provided than can be accessed directly via the function keys on the device.

The functions provided by the softkeys are often also available via dialog boxes. However, some functions are not accessible at all without the softkey bar.

The softkey bar can be hidden temporarily to provide more space for the result displays on the screen. If you switch off the "Softkey Bar" display, it is only displayed for a few seconds when you select a key. Thus, you can access the functionality. Then the bar is hidden again until the next time you select a key or switch the "Softkey Bar" display back on.

**Note:** The softkey bar is hidden while the SmartGrid is displayed and restored automatically when the SmartGrid is closed.

Remote command:

`DISPlay:SKEYs[:STATe]` on page 980

### Channel Bar

The channel bar provides information on firmware and measurement settings for a specific channel.

Remote command:

`DISPlay:ANNotation:CBAR` on page 979

### Diagram Footer (Annotation)

The diagram footer beneath the diagram contains information on the x-axis of the diagram display, such as:

- The current center frequency and span settings
- The displayed span per division
- The number of sweep points

Remote command:

`DISPlay:ANNotation:FREQuency` on page 979

### Date and Time

The date and time display can be switched off independently of the status bar.

You can set the current date and time and configure the display format in the "General" tab of the "Display" dialog box.

Remote command:

`DISPlay[:WINDow]:TIME` on page 980

### Front Panel

The "Front Panel" display simulates the entire front panel of the device (except for the external connectors) on the screen. Thus, you can interact with the R&S FPS without the keypad and keys on the front panel of the device. That is useful, for example, when working with an external monitor or operating via remote control from a computer.

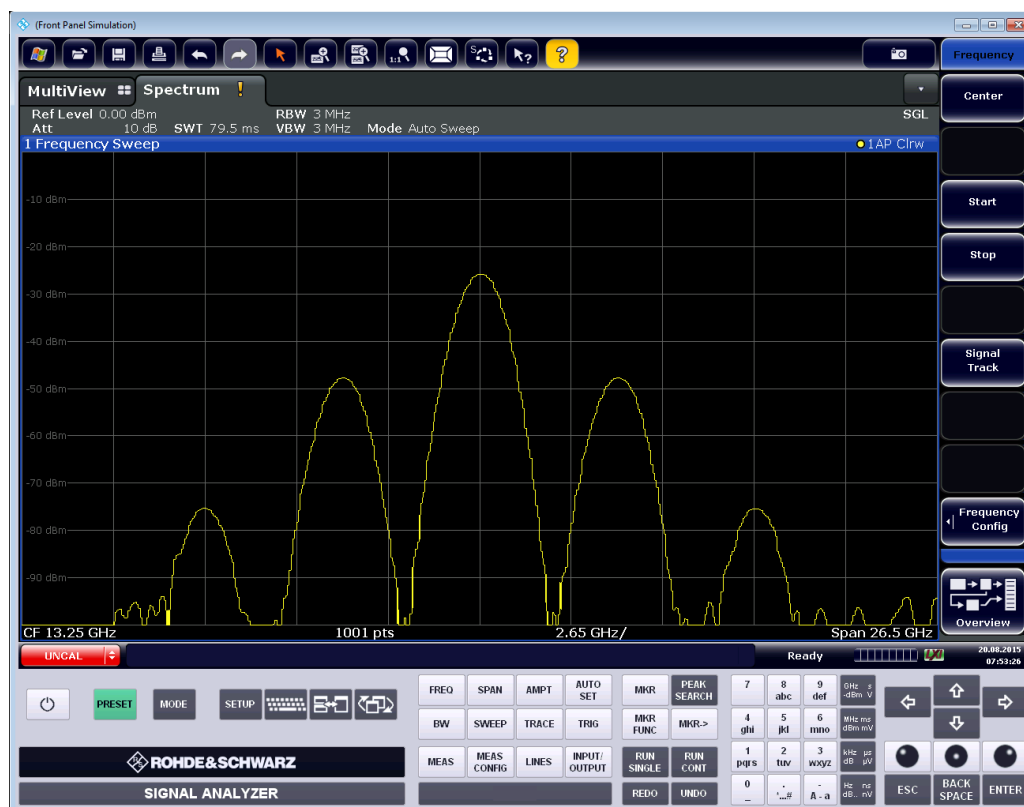

To activate or deactivate the front panel temporarily, press the F6 key on the external keyboard (if available) or the remote computer.

For more information, see [Chapter 4.5.1.3, "Front Panels"](#), on page 83.

Remote command:

`SYSTEM:DISPLAY:FPANEL[:STATE]` on page 981

### Mini Front Panel

If you require a front panel display but do not want to lose too much space for results in the display area, a mini front panel is available. The mini version displays only the main function keys in a separate window in the display area.

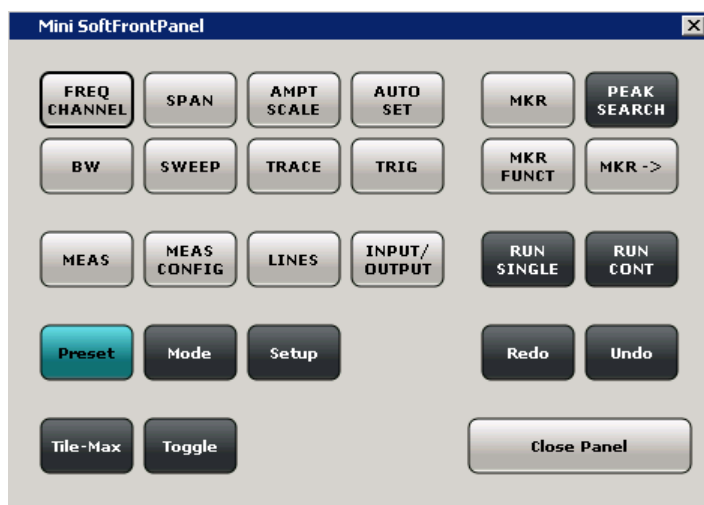

For more information, see [Chapter 4.5.1.3, "Front Panels"](#), on page 83.

**Note:**

You can also activate the mini front panel using the key combination ALT + M (be aware of the keyboard language defined in the operating system!). That is useful when you are working from a remote PC and the front panel function is not active.

Remote command:

`SYSTEM:DISPlay:FPANel[:STATe]` on page 981

### 10.2.1.3 Display Theme and Colors

**Access:** SETUP > "Display" > "Theme + Color"

You can configure the used colors and styles of display elements on the screen.

For step-by-step instructions see [Chapter 10.2.3, "How to Configure the Colors for Display and Printing"](#), on page 545.

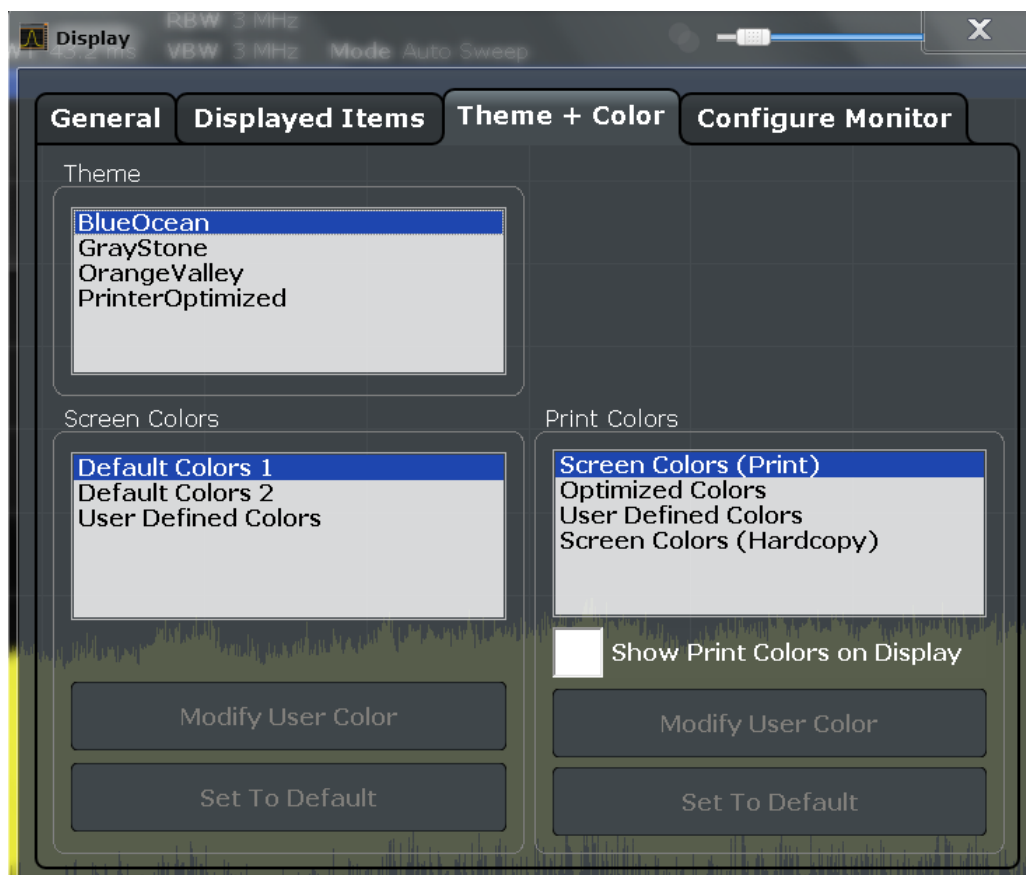

Theme ..... 541

Screen Colors ..... 541

Print Colors ..... 542

Showing Print Colors on Display..... 542

Modifying User-Defined Color Assignments..... 542

    L Selecting the Object..... 543

    L Predefined Colors ..... 543

    L Preview ..... 543

Defining User-specific Colors..... 543

Restoring the User Settings to Default Colors..... 544

**Theme**

The theme defines the colors and style used to display softkeys and other screen objects.

The default theme is "BlueOcean" .

Remote command:

`DISPlay:THEMe:SElect` on page 983

**Screen Colors**

Two different color sets are provided by the instrument, a third user-defined set can be configured.

The default color schemes provide optimum visibility of all screen objects when regarding the screen from above or below. Default setting is "Default Colors 1" .

If "User Defined Colors" is selected, a user-defined color set can be defined (see ["Defining User-specific Colors"](#) on page 543).

Remote command:

`DISPlay:CMAP<item>:DEFault<color>` on page 981

### Print Colors

Defines the color settings used for printout.

If "Show Print Colors on Display" is activated, the currently selected print colors are displayed as a preview for your selection.

|                            |                                                                                                                                                                                                                                                               |
|----------------------------|---------------------------------------------------------------------------------------------------------------------------------------------------------------------------------------------------------------------------------------------------------------|
| Optimized Colors           | Selects an optimized color setting for the printout to improve the visibility of the colors (default setting). Trace 1 is blue, trace 2 black, trace 3 green, and the markers are turquoise. The background is always printed in white and the grid in black. |
| Screen Colors (Print)      | Selects the current screen colors for the printout. The background is always printed in white and the grid in black.                                                                                                                                          |
| Screen Colors (Screenshot) | Selects the current screen colors without any changes for a screenshot.                                                                                                                                                                                       |
| User Defined Colors        | Selects the user-defined color setting.                                                                                                                                                                                                                       |

Remote command:

`HCOPY:CMAP<item>:DEFault<color>` on page 953

### Showing Print Colors on Display

Temporarily shows the currently selected print colors on the screen display. This function can be used as a preview for printing.

### Modifying User-Defined Color Assignments

You can configure the colors used to display and print individual screen objects according to your specific requirements.

The colors are configured in the (identical) "Screen Color Setup" / "Printer Color Setup" dialog boxes.



#### Selecting the Object ← Modifying User-Defined Color Assignments

Selects the object for which the color is to be defined. Colors can be defined for the following objects:

- Background
- Grid
- Individual traces
- Display lines
- Limit lines and check results
- Markers and marker information

Remote command:

Each object is assigned to a specific suffix of the CMAP commands, see [Chapter 12.10.4.3, "CMAP Suffix Assignment"](#), on page 983.

#### Predefined Colors ← Modifying User-Defined Color Assignments

Displays the available colors from the predefined color set that can be used for the selected object.

Remote command:

[HCOPY:CMAP<item>:PDEFined](#) on page 954

#### Preview ← Modifying User-Defined Color Assignments

Indicates the currently selected color that will be used for the selected object.

#### Defining User-specific Colors

In addition to the colors in the predefined color set you can configure a user-specific color to be used for the selected object.

When you select "Userdefined Colors..." , the set of predefined colors is replaced by a color palette and color configuration settings.

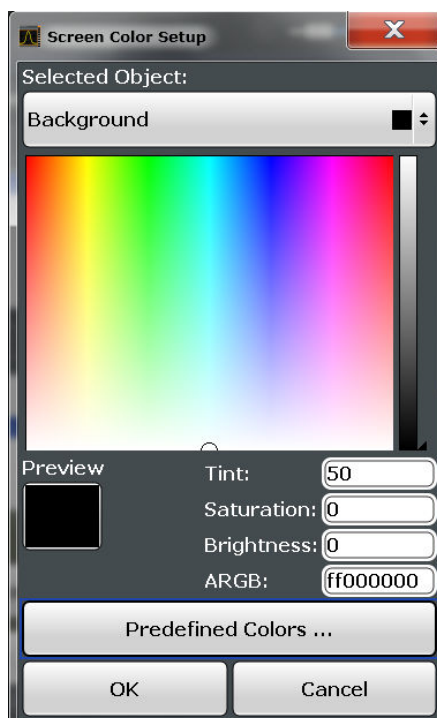

The color palette allows you to select the color directly. The color settings allow you to define values for tint, saturation and brightness.

Remote command:

[HCOpy:CMAP<item>:HSL](#) on page 954

### Restoring the User Settings to Default Colors

In addition to the predefined color settings, a user-defined setting can be configured. By default, the same settings as defined in "Default Colors 1" are used. They can then be modified according to user-specific requirements (see "[Modifying User-Defined Color Assignments](#)" on page 542).

The "Set to Default" function restores the original default settings for the user-defined color set. You can select which of the three default settings are restored.

Remote command:

[DISPlay:CMAP<item>:PDEFined](#) on page 982

## 10.2.2 External Monitor Settings

**Access:** SETUP > "Display" > "Configure Monitor"

You can connect an external monitor (or projector) to the DVI or DISPLAY PORT connector on the instrument's rear panel (see the R&S FPS getting started manual).



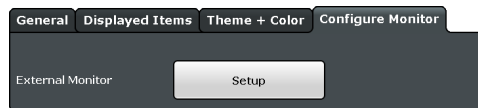

|                                            |     |
|--------------------------------------------|-----|
| Setup .....                                | 545 |
| Screen Resolution: Restore to Default..... | 545 |

### Setup

Opens the standard Windows configuration dialog box to configure the used display devices.

### Screen Resolution: Restore to Default

The default screen resolution (1280 x 800) is restored in the Windows configuration settings. This is useful, for instance, if the instrument was connected to a display device and was adapted to different requirements.

## 10.2.3 How to Configure the Colors for Display and Printing

You can configure the style and colors with which various screen objects are displayed or printed.

### To select a color set

1. Press the SETUP key and select the "Display" softkey.
2. Select the "Theme + Color" tab.
3. In the "Screen Colors" area, do one of the following:
  - Select a predefined set of colors for screen display.
  - Select "User Defined Colors" to configure the color set yourself.
4. In the "Print Colors" area, do one of the following:
  - Select a predefined set of colors for printing screenshots.
  - Select "User Defined Colors" to configure the color set yourself.
5. Activate the "Show Print Colors on Display" option to see a preview of the print colors.

### To configure a user-defined color set

1. In the "Theme + Color" tab of the "Display" dialog box, select "User Defined Colors" either for the screen or the print colors.
2. Select "Modify User Defined Colors" .  
The "Screen Color Setup" dialog box is opened.
3. From the "Selected Object:" list, select the object to which you want to assign a color.
4. Do one of the following:
  - Select a color from the "Predefined Colors" .

- Select the "Userdefined Colors ..." button to define a different color.  
The "Preview" area indicates the currently selected color.
5. To assign a user-specific color to the selected object, do one of the following:
    - Select the color from the palette.
    - Enter values for the "Tint:" , "Saturation:" , and "Brightness:" .  
**Note:** In the continuous color spectrum ( "Tint:" ), 0 % represents red and 100 % represents blue.
    - Enter an "ARGB:" value in hexadecimal format.
  6. Select the next object to which you want to assign a color from the "Selected Object:" list.
  7. Repeat these steps until you have assigned a color to all objects you want to configure.
  8. Select "OK" to close the dialog box.  
The colors are applied to the assigned objects.

## 10.3 Transducers

### 10.3.1 Basics on Transducer Factors

The transducer allows you to manipulate the trace at discrete trace points to correct the signal coming from an input device. Transducers are often used to correct the frequency response for antennas, for example. The transducer is configured by defining transducer factors for specific trace points. A set of transducer factors defines an interpolated transducer line and can be stored on the instrument.

In the Spectrum application, the correction factor from all active transducers is calculated for each displayed trace point once in advance and is added to the result of the level measurement during the sweep. If the sweep range changes, the correction values are calculated again. If several measured values are combined in one point, only one value is taken into consideration. If the active transducer line is not defined for the entire sweep range, the missing values are replaced by zeroes.

When a transducer is used, the trace is shifted by a calculated factor. However, an upward shift reduces the dynamic range for the displayed values. Thus, the reference level can be adapted automatically to restore the original dynamic range. The reference level is shifted by the maximum transducer factor. By default, if transducers are active the reference level function is adapted automatically to obtain the best dynamic performance.

If a transducer factor is active, "TDF" is displayed in the channel bar.

### Y-Axis Unit

The individual transducer factors can be defined as absolute values or relative (dB) values. However, all factors for one transducer line use the same unit. As soon as a transducer is activated, the unit of the transducer is automatically used for all the level settings and outputs. The unit cannot be changed in the amplitude settings since the R&S FPS and the active transducer are regarded as one measuring instrument. Only for relative transducer factors (unit dB), the unit originally set on the instrument is maintained and can be changed.

When all transducers have been switched off, the R&S FPS returns to the unit that was used before a transducer was activated.

### Configuration

The R&S FPS supports transducer lines with a maximum of 1001 data points. Eight of the transducer lines stored in the instrument can be activated simultaneously. The number of transducer lines stored in the instrument is only limited by the capacity of the storage device used.

A transducer line consists of the following data:

- A maximum of 1001 data points with a position and value
- A unit for the values
- A name to distinguish the transducer lines

### Validity

The transducer factors must comply with the following rules to ensure correct operation:

- The frequencies for the data points must always be defined in ascending order. Otherwise the entry will not be accepted and an error message is displayed.
- The frequencies of the data points may exceed the valid frequency range of the R&S FPS since only the set frequency range is taken into account for measurements. The minimum frequency of a data point is 0 Hz, the maximum frequency 200 GHz.
- The value range for the transducer factor is  $\pm 200$  dB.
- Gain has to be entered as a negative value, and attenuation as a positive value.

### Storing transducer factors

Transducer factors can also be stored with the configuration settings so they can be recalled for other measurements at a later time. Note, however, that any changes made to the transducer factors *after* storing the configuration file cannot be restored and will be overwritten by the stored values when the configuration file is recalled. Always remember to store the settings again after changing the transducer factors.

(See [Chapter 9.3, "Storing and Recalling Instrument Settings and Measurement Data"](#), on page 502).

**Transducer settings in secure user mode**

Be sure to store transducer files before [SecureUser Mode](#) is enabled; see [Chapter 4.1.6, "Protecting Data Using the Secure User Mode"](#), on page 33.

**Recalling transducer factors stored with measurement settings**

After recalling measurement settings, the transducer factors applied to the measurement may be different to those displayed in the "Transducer" dialog box; see ["Saving and recalling transducer and limit line settings"](#) on page 503.

## 10.3.2 Transducer Settings

**Access:** SETUP > "Transducer"

Up to 8 transducer lines can be activated simultaneously in the R&S FPS. Many more can be stored on the instrument.

**Transducer settings in secure user mode**

Be sure to store transducer files before [SecureUser Mode](#) is enabled; see [Chapter 4.1.6, "Protecting Data Using the Secure User Mode"](#), on page 33.

**Stored transducer settings**

When storing and recalling transducer settings, consider the information provided in ["Saving and recalling transducer and limit line settings"](#) on page 503.

- [Transducer Management](#)..... 548
- [Transducer Factors](#)..... 551

### 10.3.2.1 Transducer Management

**Access:** SETUP > "Transducer"

The settings required to manage all transducer lines on the instrument are described here.

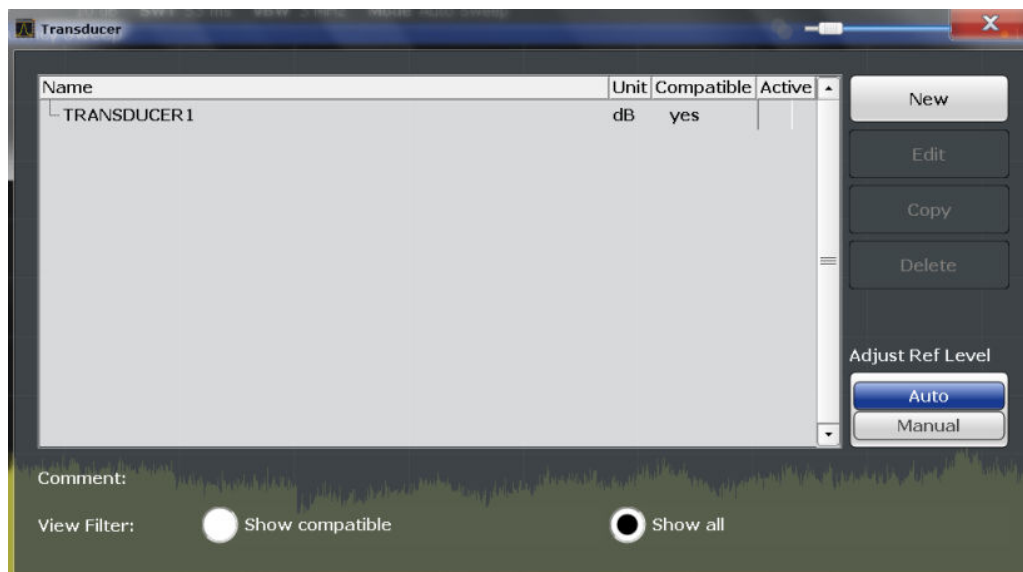

For the transducer line overview, the R&S FPS searches for all stored transducer lines with the file extension .TDF in the C:\R\_S\INSTR\trd directory. The overview allows you to determine which transducer lines are available and can be used for the current measurement.

For details on settings for individual lines see [Chapter 10.3.2.2, "Transducer Factors"](#), on page 551.

For instructions on configuring and working with transducers see [Chapter 10.3.4, "How to Configure the Transducer"](#), on page 554.

|                                                           |     |
|-----------------------------------------------------------|-----|
| Name .....                                                | 549 |
| Unit .....                                                | 549 |
| Compatibility .....                                       | 550 |
| Activating / Deactivating .....                           | 550 |
| Comment .....                                             | 550 |
| Included Transducer Lines in Overview (View Filter) ..... | 550 |
| Adjust Ref Level .....                                    | 550 |
| Create New Line .....                                     | 550 |
| Edit Line .....                                           | 550 |
| Copy Line .....                                           | 550 |
| Delete Line .....                                         | 551 |

**Name**

The name of the stored transducer line.

**Unit**

The unit in which the y-values of the data points of the transducer line are defined.

The following units are available:

- dB
- dBm
- dBmV
- dBµV

- dB $\mu$ V/m
- dB $\mu$ A
- dB $\mu$ A/m
- dBpW
- dBpT

**Compatibility**

Indicates whether the transducer factors are compatible with the current measurement settings.

For more information on which conditions a transducer line must fulfill to be compatible, see [Chapter 10.3.1, "Basics on Transducer Factors"](#), on page 546.

**Activating / Deactivating**

Activates/deactivates the transducer line. Up to 8 transducer lines can be active at the same time.

Remote command:

[\[SENSe:\]CORRection:TRANsdUcer:SELEct](#) on page 977

[\[SENSe:\]CORRection:TRANsdUcer\[:STATe\]](#) on page 977

**Comment**

An optional description of the transducer line.

**Included Transducer Lines in Overview (View Filter)**

Defines which of the stored transducer lines are included in the overview. The view can be restricted to compatible transducer lines only or include all transducer lines found. Whether a line is compatible or not is indicated in the [Compatibility](#) setting.

**Adjust Ref Level**

Activates or deactivates the automatic adjustment of the reference level to the selected transducer factor.

- |          |                                                                                                                                              |
|----------|----------------------------------------------------------------------------------------------------------------------------------------------|
| "Auto"   | Activates the automatic adjustment. The original dynamic range is restored by shifting the reference level by the maximum transducer factor. |
| "Manual" | Deactivates the automatic adjustment. Adjust the reference level via the "Amplitude" menu.                                                   |

Remote command:

[\[SENSe:\]CORRection:TRANsdUcer:ADJust:RLEVel\[:STATe\]](#) on page 974

**Create New Line**

Create a new transducer line.

Remote command:

[\[SENSe:\]CORRection:TRANsdUcer:SELEct](#) on page 977

**Edit Line**

Edit an existing transducer line configuration.

**Copy Line**

Copy the selected transducer line configuration to create a new line.

**Delete Line**

Delete the selected transducer line.

Remote command:

[SENSe:]CORRection:TRANsducer:DELeTe on page 976

**10.3.2.2 Transducer Factors**

**Access:** SETUP > "Transducer" > "Edit Line" / "Copy Line" / "New Line"

The settings and functions available for individual transducer lines are described here.

For instructions on creating and editing transducer lines see [Chapter 10.3.4, "How to Configure the Transducer"](#), on page 554.

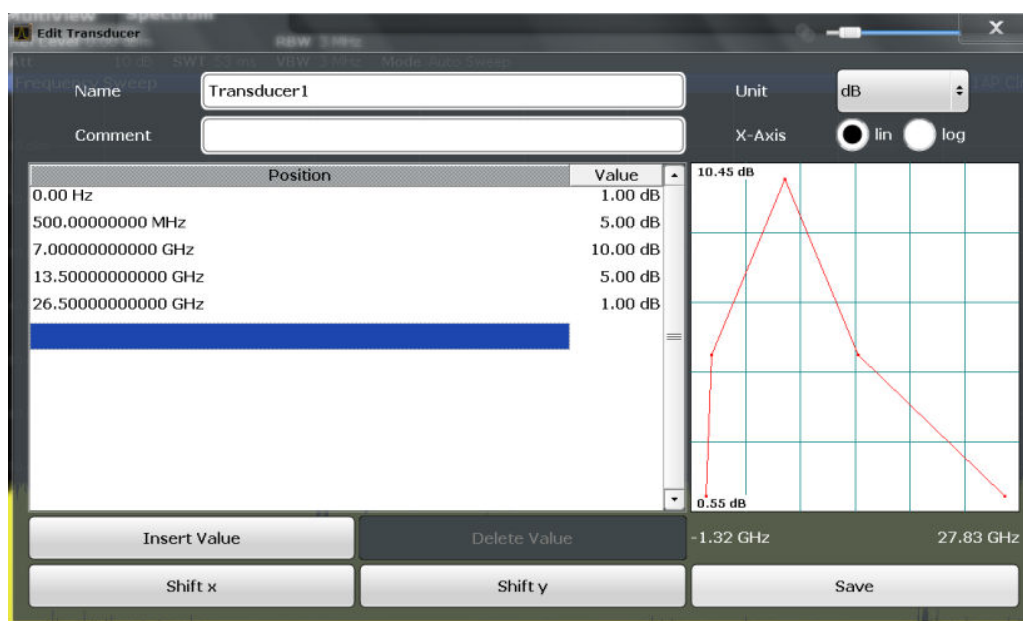

Name .....551

Comment .....552

Unit .....552

X-Axis Scaling .....552

Data Points .....552

Insert Value .....552

Delete Value .....552

Shift x .....552

Shift y .....553

Save .....553

Import .....553

Export .....553

**Name**

Defines the transducer line name. All names must be compatible with the Windows 7 conventions for file names. The transducer data is stored under this name (with a .TDF extension) in the C:\R\_S\INSTR\trd directory.

Remote command:

[\[SENSe:\]CORRection:TRANsdUCer:SELeCt](#) on page 977

### Comment

Defines an optional comment for the transducer line. The text may contain up to 40 characters.

Remote command:

[\[SENSe:\]CORRection:TRANsdUCer:COMMeNt](#) on page 975

### Unit

The unit in which the y-values of the data points of the transducer line are defined.

As soon as a transducer is activated, the unit of the transducer is automatically used for all the level settings and outputs. The unit cannot be changed in the amplitude settings unless dB is used.

Remote command:

[\[SENSe:\]CORRection:TRANsdUCer:UNIt](#) on page 977

### X-Axis Scaling

Describes the scaling of the horizontal axis on which the data points of the transducer line are defined. Scaling can be linear or logarithmic.

Remote command:

[\[SENSe:\]CORRection:TRANsdUCer:SCALIng](#) on page 976

### Data Points

Each transducer line is defined by a minimum of 2 and a maximum of 50 data points. Each data point is defined by its position (x-axis) and value (y-value).

The data points must comply with the following rules to ensure correct operation:

- The frequencies for the data points must always be defined in ascending order. Otherwise the entry will not be accepted and an error message is displayed.
- The frequencies of the data points may exceed the valid frequency range of the R&S FPS since only the set frequency range is taken into account for measurements. The minimum frequency of a data point is 0 Hz, the maximum frequency 200 GHz.
- The value range for the transducer factor is  $\pm 200$  dB.
- Gain has to be entered as a negative value, and attenuation as a positive value.

Remote command:

[\[SENSe:\]CORRection:TRANsdUCer:DATA](#) on page 976

### Insert Value

Inserts a data point in the transducer line above the selected one in the "Edit Transducer" dialog box.

### Delete Value

Deletes the selected data point in the "Edit Transducer" dialog box.

### Shift x

Shifts the x-value of each data point horizontally by the defined shift width.



**Shift y**

Shifts the y-value of each data point vertically by the defined shift width.

**Save**

Saves the currently edited transducer line under the name defined in the "Name" field.

Remote command:

`MMEMemory:SElect[:ITEM]:TRANsducer:ALL` on page 945

`MMEMemory:STORe<n>:STATe` on page 949

**Import**

Opens a file selection dialog box and loads the transducer factor from the selected file in .CSV format.

Note that a valid import file must contain a minimum of required information for the R&S FPS. For details on the file format see [Chapter 10.3.3, "Reference: Transducer Factor File Format"](#), on page 553.

Remote command:

`MMEMemory:LOAD<n>:TFACTOR` on page 978

**Export**

Opens a file selection dialog box and stores the currently displayed transducer factor to the defined file in .CSV format.

For details on the file format see [Chapter 10.3.3, "Reference: Transducer Factor File Format"](#), on page 553.

The transducer factor can be imported again later by the R&S FPS for use in other measurements.

Remote command:

`MMEMemory:STORe<n>:TFACTOR` on page 978

**10.3.3 Reference: Transducer Factor File Format**

Transducer factor data can be exported to a file in ASCII (CSV) format for further evaluation in other applications. Transducer factors stored in the specified ASCII (CSV) format can also be imported to the R&S FPS for other measurements (see ["Import"](#) on page 553). This reference describes in detail the format of the export/import files for transducer factors. Note that the **bold** data is **mandatory**, all other data is optional.

Different language versions of evaluation programs may require a different handling of the decimal point. Thus, you can define the decimal separator to be used (see ["Decimal Separator"](#) on page 493).

*Table 10-1: ASCII file format for transducer factor files*

| File contents                    | Description                                                                |
|----------------------------------|----------------------------------------------------------------------------|
| <b>Header data</b>               |                                                                            |
| <b>sep=;</b>                     | Separator for individual values (required by Microsoft Excel, for example) |
| <b>Type;RS_TransducerFactor;</b> | Type of data                                                               |

| File contents                                  | Description                                                 |
|------------------------------------------------|-------------------------------------------------------------|
| FileFormatVersion;1.00;                        | File format version                                         |
| Date;01.Oct 2006;                              | Date of data set storage                                    |
| OptionID;SpectrumAnalyzer                      | Application the transducer factor was created for           |
| Name;TestTDF1                                  | Transducer factor name                                      |
| Comment;Transducer for device A                | Description of transducer factor                            |
| XAxisScaling;LINEAR                            | Scaling of x-axis linear (LIN) or logarithmic (LOG)         |
| YAxisUnit;LEVEL_DB                             | Unit of y values                                            |
| YAxisScaleMode;ABSOLUTE                        | Scaling of y-axis (absolute or relative)                    |
| NoOfPoints;5                                   | Number of points the line is defined by                     |
| <b>Data section for individual data points</b> |                                                             |
| 1000000000;-50.000000                          | <b>x- and y-values of each data point defining the line</b> |
| 5000000000;-30.000000                          |                                                             |
| 10000000000;0.000000                           |                                                             |
| 15000000000;-30.000000                         |                                                             |
| 25000000000;-50.000000                         |                                                             |

### 10.3.4 How to Configure the Transducer

Configuring the transducer is very similar to configuring transducer factors.

The transducer settings are defined in the "Transducer" dialog box which is displayed when you press the SETUP key and then select "Transducer" .



#### Stored transducer settings

When storing and recalling transducer settings, consider the information provided in ["Saving and recalling transducer and limit line settings"](#) on page 503.

The following tasks are described:

- ["How to find compatible transducer lines"](#) on page 554
- ["How to activate and deactivate a transducer"](#) on page 555
- ["How to edit existing transducer lines"](#) on page 555
- ["How to copy an existing transducer line"](#) on page 555
- ["How to delete an existing transducer line"](#) on page 556
- ["How to configure a new transducer line"](#) on page 556
- ["How to move the transducer line vertically or horizontally"](#) on page 556

#### How to find compatible transducer lines

- ▶ In the "Transducer" dialog box, select the "View Filter" option: "Show Compatible" .

All transducer lines stored on the instrument that are compatible to the current measurement settings are displayed in the overview.

### How to activate and deactivate a transducer

1. To activate a transducer select a transducer line in the overview and select the "Active" setting for it.

The trace is automatically recalculated for the next sweep after a transducer line is activated.

2. To deactivate a transducer line, deactivate the "Active" setting for it.

After the next sweep, the originally measured values are displayed.

### How to edit existing transducer lines

Existing transducer line configurations can be edited.

1. In the "Transducer" dialog box, select the transducer line.
2. Select the "Edit" button.
3. Edit the line configuration as described in ["How to configure a new transducer line"](#) on page 556.
4. Save the new configuration by selecting the "Save" button.

The trace is automatically recalculated for the next sweep if the transducer line is active.



In order to store the changes to the transducer lines in a settings file, select the  "Save" icon in the toolbar.

(See [Chapter 9.3, "Storing and Recalling Instrument Settings and Measurement Data"](#), on page 502).

---

### How to copy an existing transducer line

1. In the "Transducer" dialog box, select the transducer line.
2. Select the "Copy" button.

The "Edit Transducer" dialog box is opened with the configuration of the selected transducer.

3. Define a new name to create a new transducer with the same configuration as the source line.
4. Edit the line configuration as described in ["How to configure a new transducer line"](#) on page 556.
5. Save the new configuration by selecting the "Save" button.

The new transducer line is displayed in the overview and can be activated.

### How to delete an existing transducer line

1. In the "Transducer" dialog box, select the transducer line.
2. Select the "Delete" button.
3. Confirm the message.

The transducer line is deleted. After the next sweep, the originally measured values are displayed.

### How to configure a new transducer line

1. In the "Transducer" dialog box, select the "New" button.  
The "Edit Transducer" dialog box is displayed. The current line configuration is displayed in the preview area of the dialog box. The preview is updated after each change to the configuration.
2. Define a "Name" and, optionally, a "Comment" for the new transducer line.
3. Define the scaling for the x-axis.
4. Define the data points: minimum 2, maximum 1000:
  - a) Select "Insert Value" .
  - b) Define the x-value ( "Position" ) and y-value ( "Value" ) of the first data point.
  - c) Select "Insert Value" again and define the second data point.
  - d) Repeat this to insert all other data points.  
To insert a data point before an existing one, select the data point and then "Insert Value" .  
To insert a new data point at the end of the list, move the focus to the line after the last entry and then select "Insert Value" .  
To delete a data point, select the entry and then "Delete Value" .
5. Check the current line configuration in the preview area of the dialog box. If necessary, correct individual data points or add or delete some.  
If necessary, shift the entire line vertically or horizontally by selecting the "Shift x" or "Shift y" button and defining the shift width.
6. Save the new configuration by selecting the "Save" button.  
The new transducer line is displayed in the overview and can be activated.

### How to move the transducer line vertically or horizontally

A configured transducer line can easily be moved vertically or horizontally. Thus, a new transducer line can be easily generated based upon an existing transducer line which has been shifted.

1. In the "Line Config" dialog box, select the transducer line.
2. Select the "Edit" button.
3. In the "Edit Transducer Line" dialog box, select the "Shift x" or "Shift y" button and define the shift width.

4. Save the shifted data points by selecting the "Save" button.  
If activated, the trace is recalculated after the next sweep.

#### How to export a transducer factor

Transducer factor configurations can be stored to an ASCII file for evaluation in other programs or to be imported later for other measurements.

1. In the "Edit Transducer" dialog box, select the transducer factor.
2. Select the "New" or "Edit" button.
3. Define the transducer factor as described in ["How to configure a new transducer line"](#) on page 556.
4. Select "Export" to save the configuration to a file.  
You are asked whether you would like to save the configuration internally on the R&S FPS first.
5. Select a file name and location for the transducer factor.
6. Select the decimal separator to be used in the file.
7. Select "Save" .

The transducer factor is stored to a file with the specified name and the extension .CSV.

For details on the file format see [Chapter 10.3.3, "Reference: Transducer Factor File Format"](#), on page 553.

#### How to import a transducer factor

Transducer factor configurations that are stored in an ASCII file and contain a minimum of required data can be imported to the R&S FPS.

For details on the required file format see [Chapter 10.3.3, "Reference: Transducer Factor File Format"](#), on page 553.

1. In the "Edit Transducer" dialog box, select the transducer factor.
2. Select the "New" or "Edit" button.
3. Select "Import" to load a transducer factor from a file.  
You are asked whether you would like to save the current configuration on the R&S FPS first.
4. Select the file name of the transducer factor.
5. Select the decimal separator that was used in the file.
6. Select "Select" .

The transducer factor is loaded from the specified file and displayed in the "Edit Transducer" dialog box.

7. Activate the transducer factor as described in "How to activate and deactivate a transducer" on page 555.

## 10.4 Reference Frequency Settings

**Access:** SETUP > "Reference"

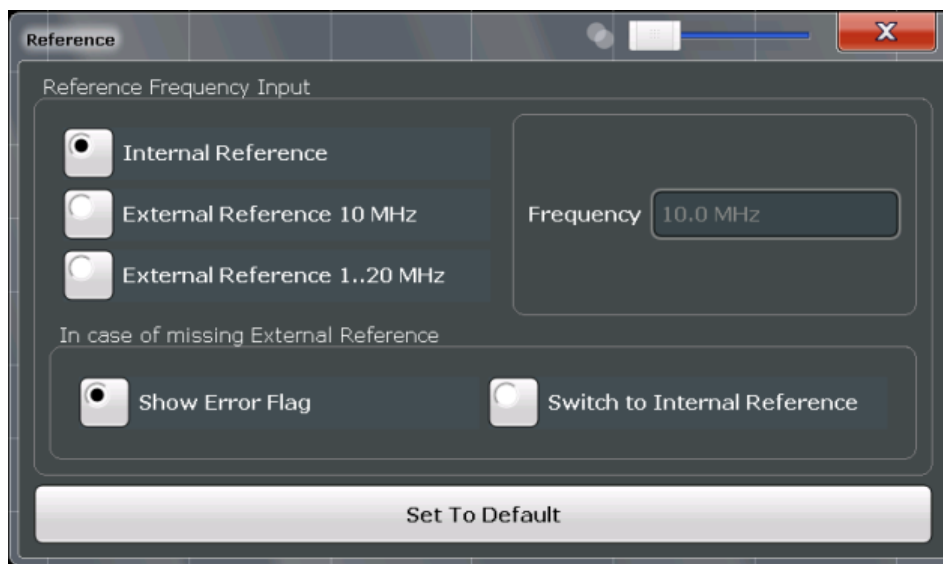

|                                                       |     |
|-------------------------------------------------------|-----|
| Reference Frequency Input.....                        | 558 |
| L Behavior in case of missing external reference..... | 559 |
| L Frequency.....                                      | 559 |
| Resetting the Default Values.....                     | 559 |

### Reference Frequency Input

The R&S FPS can use the internal reference source or an external reference source as the frequency standard for all internal oscillators. A 10 MHz crystal oscillator is used as the internal reference source. In the external reference setting, all internal oscillators of the R&S FPS are synchronized to the external reference frequency.

External references are connected to the REF INPUT connector on the rear panel. For details see the "Getting Started" manual.

**Note:** The optional, and more precise OCXO signal can replace the internal reference source.

The default setting is the internal reference. When an external reference is used, "EXT REF" is displayed in the status bar.

**Note:** The REF OUTPUT connector can be used to provide an external reference signal (or the OCXO reference signal) from the R&S FPS to other devices that are connected to this instrument. Reference output is always enabled.

| Connector  | Reference signal         | Usage                                                                                                                                                      |
|------------|--------------------------|------------------------------------------------------------------------------------------------------------------------------------------------------------|
| REF INPUT  | 1...20 MHz<br>0...10 dBm | To provide an external reference signal on the R&S FPS.                                                                                                    |
| REF OUTPUT | 10 MHz<br>10 dBm         | To provide the internal reference signal from the R&S FPS to another device continuously.<br>Also used to provide OCXO reference signal to another device. |

Remote command:

[\[SENSe:\]ROSCillator:SOURce](#) on page 970

[SOURce:EXTeRnal:ROSCillator:EXTeRnal:FREQuency](#) on page 969

#### Behavior in case of missing external reference ← Reference Frequency Input

If an external reference is selected but none is available, there are different ways the instrument can react.

"Show Error Flag"      The error message "External reference missing" is displayed if no valid external reference signal is available. Additionally, the flag "NO REF" is displayed to indicate that no synchronization was performed *for the last measurement*.

"Switch to internal reference"      The instrument automatically switches back to the internal reference if no external reference is available. Note that you must re-activate the external reference if it becomes available again at a later time.

Remote command:

[\[SENSe:\]ROSCillator:SOURce](#) on page 970

[\[SENSe:\]ROSCillator:SOURce:EAUTO?](#) on page 970

#### Frequency ← Reference Frequency Input

Defines the external reference frequency to be used (for variable connectors only).

#### Resetting the Default Values

The frequency value for the different types of external reference are stored.

When you switch the input source, the previously defined settings are restored. You can restore the default values for all input sources using the "Preset Channel" function.

## 10.5 System Configuration Settings

Access: SETUP > "System Configuration"

- [Hardware Information](#).....560
- [Information on Versions and Options](#).....560
- [System Messages](#).....562
- [Firmware Updates](#).....563
- [General Configuration Settings](#).....564

### 10.5.1 Hardware Information

**Access:** SETUP > "System Configuration" > "Hardware Info"

An overview of the installed hardware in your R&S FPS is provided.

Every listed component is described by its serial number, order number, model information, hardware code, and hardware revision.

This information can be useful when problems occur with the instrument and you require support from Rohde & Schwarz.

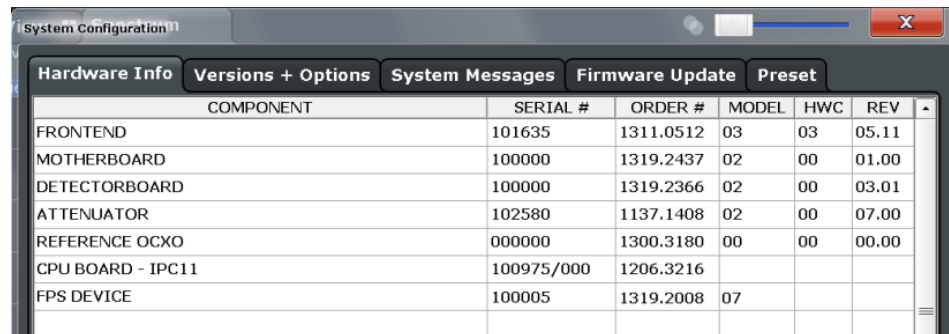

| COMPONENT         | SERIAL #   | ORDER #   | MODEL | HWC | REV   |
|-------------------|------------|-----------|-------|-----|-------|
| FRONTEND          | 101635     | 1311.0512 | 03    | 03  | 05.11 |
| MOTHERBOARD       | 100000     | 1319.2437 | 02    | 00  | 01.00 |
| DETECTORBOARD     | 100000     | 1319.2366 | 02    | 00  | 03.01 |
| ATTENUATOR        | 102580     | 1137.1408 | 02    | 00  | 07.00 |
| REFERENCE OCXO    | 000000     | 1300.3180 | 00    | 00  | 00.00 |
| CPU BOARD - IPC11 | 100975/000 | 1206.3216 |       |     |       |
| FPS DEVICE        | 100005     | 1319.2008 | 07    |     |       |



You can obtain basic information on the instrument's hardware directly via the R&S FPS's mini display: navigate to "Info" and select the required information.

**Remote command:**

`DIAGnostic:SERVICE:HWInfo?` on page 990

### 10.5.2 Information on Versions and Options

**Access:** SETUP > "System Configuration" > "Versions + Options"

Information on the firmware version and options installed on your instrument is provided. The unique Rohde & Schwarz device ID is also indicated here, as it is required for license and option administration.

You can also install new firmware options in this dialog box.

The table also contains:

- The open source acknowledgements (PDF file) for the firmware and other software packages used by the R&S FPS



#### Installing options in secure user mode

Be sure to install any new options before [SecureUser Mode](#) is enabled; see [Chapter 4.1.6, "Protecting Data Using the Secure User Mode"](#), on page 33.

For restricted users in secure user mode, this function is not available!





### Expired option licenses

If an option is about to expire, a message box is displayed to inform you. You can then use the "Install Option" function to enter a new license key.

If an option has already expired, a message box appears for you to confirm. In this case, all instrument functions are unavailable (including remote control) until the R&S FPS is rebooted. You must then use the "Install Option" function to enter the new license key.

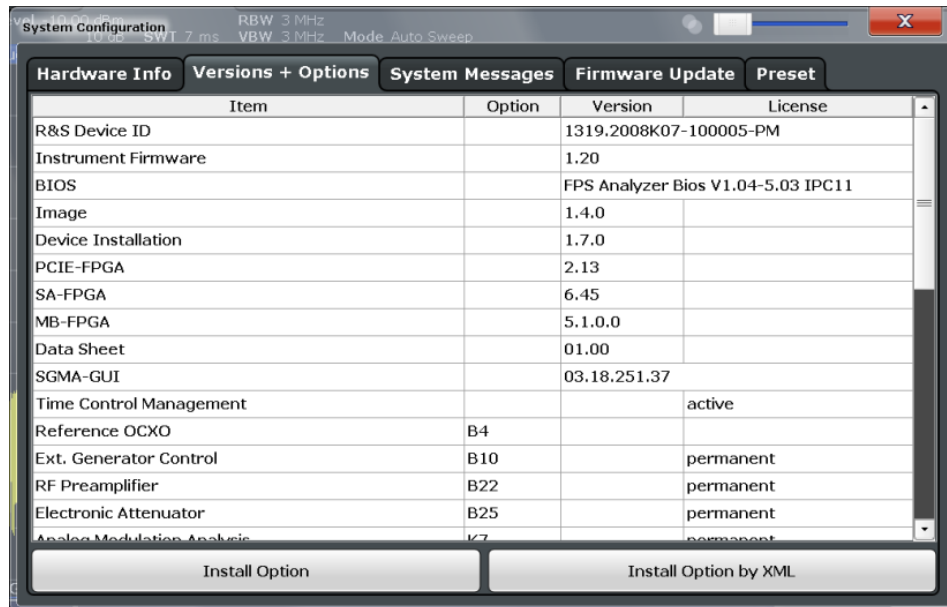

For details on options refer to the "Getting Started" manual, "Checking the Supplied Items".

#### Remote commands:

`SYSTEM:FORMat:IDENT` on page 993

`DIAGnostic:SERvice:BIOSinfo?` on page 990

`DIAGnostic:SERvice:VERSinfo?` on page 990

#### Open Source Acknowledgment: Open

Displays a PDF file containing information on open source code used by the R&S FPS firmware.

#### Install Option

Opens an edit dialog box to enter the license key for the option that you want to install. Only user accounts with administrator rights are able to install options.

#### Install Option by XML

Opens a file selection dialog box to install an additional option to the R&S FPS using an XML file. Enter or browse for the name of an XML file that contains the option key and select "Select".

Only user accounts with administrator rights are able to install options.

### 10.5.3 System Messages

**Access:** SETUP > "System Configuration" > "System Messages"

The system messages generated by the R&S FPS are displayed.

The messages are displayed in the order of their occurrence; the most recent messages are placed at the top of the list. Messages that have occurred since you last visited the system messages tab are marked with an asterisk '\*'.  
 \*

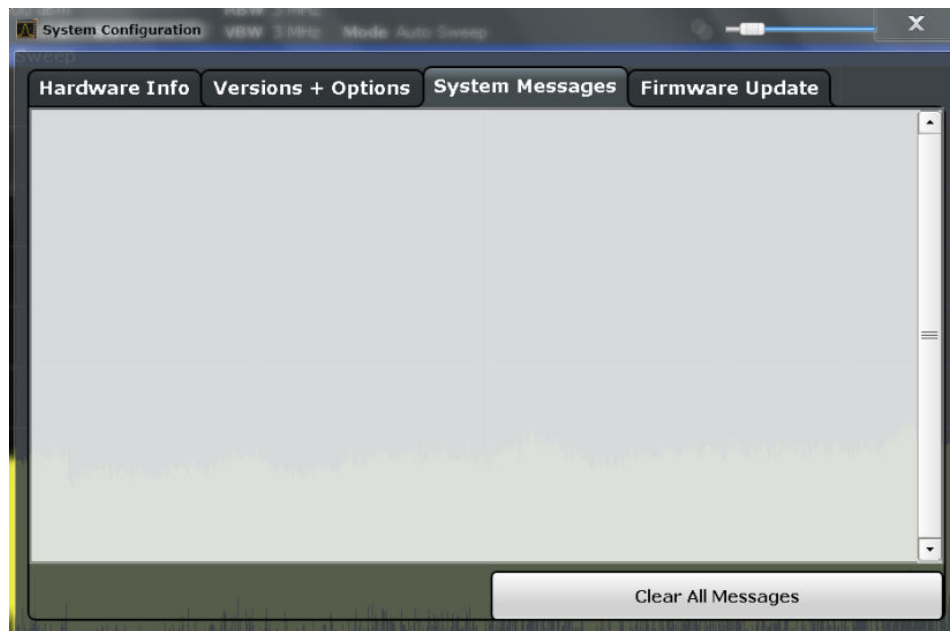

You can view the system messages directly via the R&S FPS's mini display: navigate to "System Messages" .

To clear the messages, navigate to "System commands" > "Clear messages" .

If the number of error messages exceeds the capacity of the error buffer, "Message Buffer Overflow" is displayed. To clear the message buffer use the "Clear All Messages" button.

The following information is available:

|           |                                                  |
|-----------|--------------------------------------------------|
| No        | device-specific error code                       |
| Message   | brief description of the message                 |
| Component | hardware messages: name of the affected module   |
|           | software messages: name of the affected software |
| Date/Time | date and time of the occurrence of the message   |

**Remote command:**

`SYSTem:ERRor:LIST?` on page 992

**10.5.4 Firmware Updates**

**Access:** SETUP > "System Configuration" > "Firmware Update"

During instrument start, the installed hardware is checked against the current firmware version to ensure the hardware is supported. If not, an error message is displayed ( "Wrong Firmware Version" ) and you are asked to update the firmware. Until the firmware version is updated, self-alignment fails. To see which components are not supported, see the [System Messages](#).

The firmware on your R&S FPS may also need to be updated in order to enable additional new features or if reasons for improvement come up. Ask your sales representative or check the Rohde&Schwarz website for availability of firmware updates. A firmware update package includes at least a setup file and release notes.



Before updating the firmware on your instrument, read the release notes delivered with the firmware version.

**Installing options in secure user mode**

Be sure to perform any firmware updates before [SecureUser Mode](#) is enabled; see [Chapter 4.1.6, "Protecting Data Using the Secure User Mode"](#), on page 33.

For restricted users in secure user mode, this function is not available!

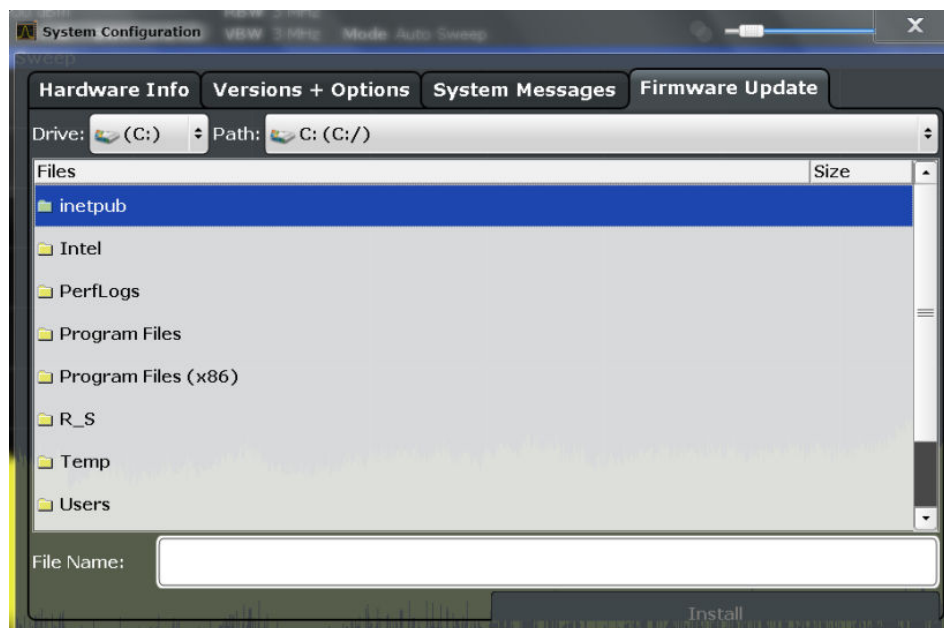

Enter the name or browse for the firmware installation file and press the "Install" button.

**Remote command:**

[SYSTem:FIRMware:UPDate](#) on page 993

**How to Update the Instrument Firmware**

1. Download the update package from the Rohde&Schwarz website and store it on a memory stick, on the instrument, or on a server network drive that can be accessed by the instrument.
2. **NOTICE!** Stop measurement. The firmware update must not be performed during a running measurement.  
If a measurement is running, stop it by pressing the highlighted RUN CONT or RUN SINGLE key.
3. Select the SETUP key.
4. Select the "System Config" softkey.
5. Select the "Firmware Update" tab.
6. In the file selection dialog box select the `FPSSetup*.exe` file.
7. Select "Install" to start the update.
8. After the firmware update, the R&S FPS reboots automatically.
9. Depending on the previous firmware version, a reconfiguration of the hardware might be required during the first startup of the firmware. The reconfiguration starts automatically, and a message box informs you about the process. When the reconfiguration has finished, the instrument again reboots automatically.

**Note:** Do not switch off the instrument during the reconfiguration process!

Now the firmware update is complete.

It is recommended that you perform a self-alignment after the update (see [Chapter 10.1.4, "How to Align the Instrument"](#), on page 535).

### 10.5.5 General Configuration Settings

**Access:** SETUP > "System Configuration" > "Config"

General system settings, for example concerning the initial behaviour of the R&S FPS after booting, can also be configured.

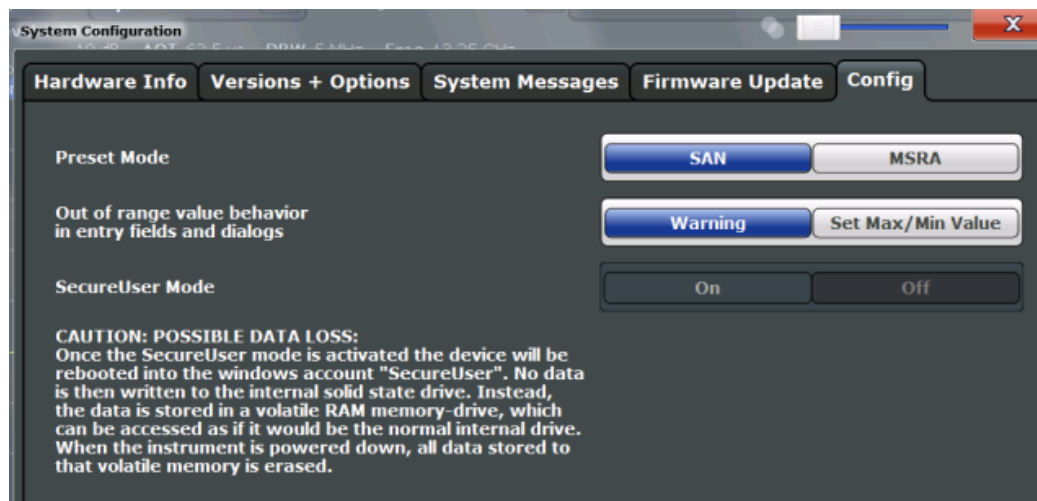

Preset Mode ..... 565  
 Out-of-range value behavior ..... 565  
 SecureUser Mode ..... 565  
     └ Changing the password..... 566

**Preset Mode**

The default operating mode is Signal and Spectrum Analyzer mode, however, the pre-setting can be changed. The defined operating mode is activated when you switch on the R&S FPS or press the PRESET key.

The presettings can be defined in the "Config" tab of the "System Configuration" dialog box.

For details on operating modes see [Chapter 5, "Applications, Measurement Channels, and Operating Modes"](#), on page 110.

- "SAN"           Signal and Spectrum Analyzer mode
- "MSRA"         Multi-Standard Radio Analysis mode

Remote command:

[SYSTEM:PRESet:COMPAtible](#) on page 993

**Out-of-range value behavior**

By default, if you enter a value that is outside the valid range in an input field for a setting, a warning is displayed and the value is not accepted. Alternatively, entries below the minimum value can automatically be set to the minimum possible entry, and entries above the maximum value set to the maximum possible entry. This behavior avoids errors and facilitates setting correct values.

**SecureUser Mode**

If activated, the R&S FPS requires a reboot and then automatically logs in using the "SecureUser" account.

Data that the R&S FPS normally stores on the solid-state drive is redirected to volatile memory instead. Data that is stored in volatile memory can be accessed by the user during the current instrument session; however, when the instrument's power is removed, all data in volatile memory is erased.

The Secure User Mode can only be activated or deactivated by a user with administrator rights.

**Note:** Storing instrument settings permanently. Before you activate secure user mode, store any instrument settings that are required beyond the current session, such as predefined instrument settings, transducer files, or self-alignment data.

For details on the secure user mode see [Chapter 4.1.6, "Protecting Data Using the Secure User Mode"](#), on page 33.

Remote command:

`SYSTEM:SECURITY[:STATE]` on page 994

**Note:** Initially after installation of the R&S FPS-K33 option, secure user mode must be enabled manually once before remote control is possible.

### Changing the password ← SecureUser Mode

When the secure user mode is activated the first time after installation, you are prompted to change the passwords for all user accounts in order to improve system security.



To save the new password, select "Save". The password dialog for the next user is displayed, until you have been prompted to change the password all user accounts.

If you cancel the dialog without changing the password, the password dialog for the next user is displayed, until you have been prompted to change the password all user accounts. Although it is possible to continue in secure user mode without changing the passwords (and you will not be prompted to do so again), it is strongly recommended that you do define a more secure password for all users.

By default, the password characters are not displayed to ensure confidentiality during input. To display the characters, select "Show password".

To display the onscreen keyboard, select "Keyboard".

## 10.6 Service Functions

**Access:** SETUP > "Service"

When unexpected problems arise with the R&S FPS some service functions may help you solve them.

- [R&S Support Information](#)..... 567
- [Self-test Settings and Results](#)..... 568
- [Calibration Signal Display](#)..... 569
- [Service Functions](#)..... 570
- [Hardware Diagnostics](#)..... 572

### 10.6.1 R&S Support Information

**Access:** SETUP > "Service" > "R&S Support"

In case of errors you can store useful information for troubleshooting and send it to your Rohde & Schwarz support center.

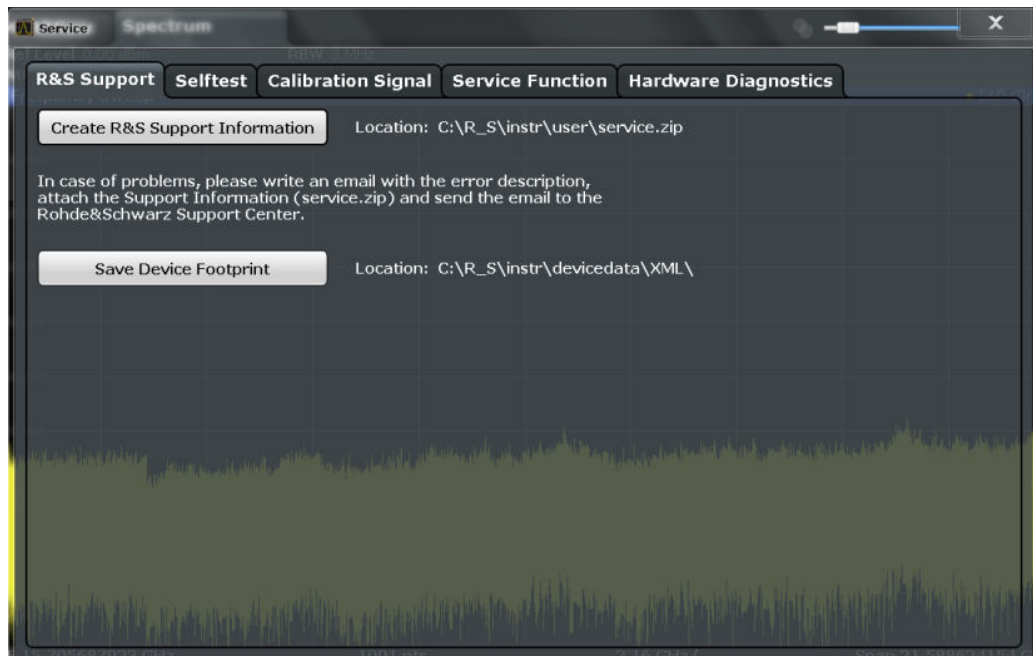

- [Create R&S Support Information](#) ..... 567
- [Save Device Footprint](#) ..... 568

#### Create R&S Support Information

Creates a \*.zip file with important support information. The \*.zip file contains the system configuration information ( "Device Footprint" ), the current eeprom data and a screenshot of the screen display.

This data is stored to the C:\R\_S\INSTR\USER directory on the instrument.

The file name consists of the unique device ID and the current date and time of the file creation.

If you contact the Rohde&Schwarz support to get help for a certain problem, send these files to the support in order to identify and solve the problem faster.

Remote command:

[DIAGnostic:SERvice:SINFo?](#) on page 995

### Save Device Footprint

Creates an \*.xml file with information on installed hardware, software, image and FPGA versions. The \*.xml file is stored under C:\R\_S\INSTR\devicedata\xml\ on the instrument. It is also included in the service.zip file.

## 10.6.2 Self-test Settings and Results

**Access:** SETUP > "Service" > "Selftest"

Or directly via the R&S FPS's mini display: "System commands" > "Selftest" .

If the R&S FPS fails you can perform a self-test of the instrument to identify any defective modules.

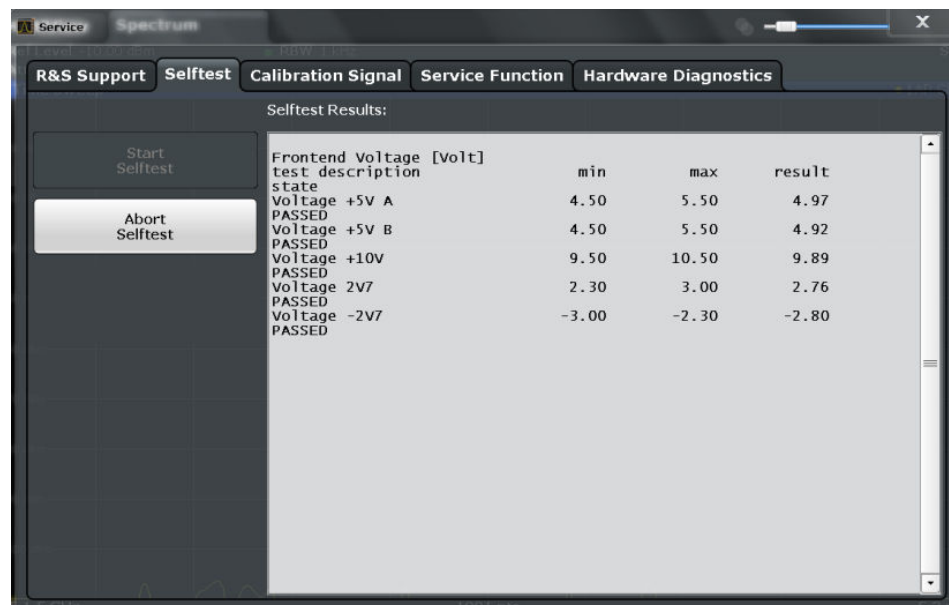

Once the self-test is started, all modules are checked consecutively and the test result is displayed. You can abort a running test.

In case of failure a short description of the failed test, the defective module, the associated value range and the corresponding test results are indicated.



A running Sequencer process is aborted when you start a self-test.

If you start a self-test remotely, then select the "Local" softkey while the test is still running, the instrument only returns to the manual operation state after the test is completed. In this case, the self-test cannot be aborted.

**Remote command:**

[\\*TST?](#) on page 622



[DIAGnostic:SERVICE:STEST:RESult?](#) on page 974

### 10.6.3 Calibration Signal Display

**Access:** SETUP > "Service" > "Calibration Signal"

Alternatively to the RF input signal from the front panel connector you can use the instrument's calibration signal as the input signal, for example to perform service functions on.

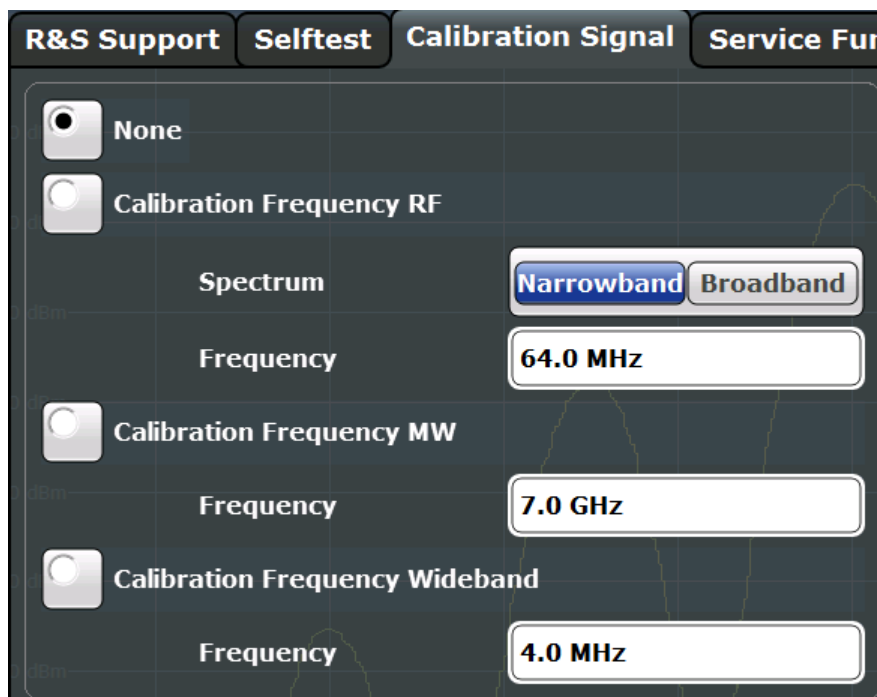

|                                      |     |
|--------------------------------------|-----|
| NONE .....                           | 569 |
| Calibration Frequency RF .....       | 569 |
| L Spectrum .....                     | 570 |
| L Frequency .....                    | 570 |
| Calibration Frequency MW .....       | 570 |
| Calibration Frequency Wideband ..... | 570 |

**NONE**

Uses the current RF signal at the input, i.e. no calibration signal (default).

Remote command:

[DIAGnostic:SERVICE:INPut\[:SElect\]](#) on page 973

**Calibration Frequency RF**

Uses the internal calibration signal as the RF input signal.

Remote command:

[DIAGnostic:SERVICE:INPut\[:SElect\]](#) on page 973

[DIAGnostic:SERVICE:INPut:PULSed:CFrequency](#) on page 972

**Spectrum ← Calibration Frequency RF**

Defines whether a broadband or narrowband calibration signal is sent to the RF input.

"Narrowband" Used to calibrate the absolute level of the frontend at 64 MHz.

"Broadband" Used to calibrate the IF filter.

Remote command:

[DIAGnostic:SERVice:INPut:RF\[:SPECTrum\]](#) on page 973

**Frequency ← Calibration Frequency RF**

Defines the frequency of the internal broadband calibration signal to be used for IF filter calibration (max. 64 MHz).

For narrowband signals, 64 MHz is sent.

**Calibration Frequency MW**

Uses the microwave calibration signal as the RF input (for frequencies greater than 7 GHz; for R&S FPS13/30/40 only). The microwave calibration signal is pulsed. This function is used to calibrate the YIG-filter on the microwave converter.

Remote command:

[DIAGnostic:SERVice:INPut\[:SElect\]](#) on page 973

[DIAGnostic:SERVice:INPut:PULSed:MCFrequency](#) on page 972

**Calibration Frequency Wideband**

Defines the frequency of the internal broadband calibration signal to be used for IF filter calibration.

If you define a frequency that is not available, the R&S FPS uses the next available frequency.

**Tip:** Use the arrow keys to step through the available frequencies.

This function is only available if the bandwidth extension option R&S FPS-B160 is installed and no other restrictions for its use apply.

See the R&S FPS I/Q Analyzer and I/Q Input User Manual

Remote command:

[DIAGnostic:SERVice:INPut\[:SElect\]](#) on page 973

[DIAGnostic:SERVice:INPut:PULSed:WBFrequency](#) on page 972

## 10.6.4 Service Functions

**Access:** SETUP > "Service" > "Service Function"

**NOTICE**

**Using service functions**

The service functions are not necessary for normal measurement operation. Incorrect use can affect correct operation and/or data integrity of the R&S FPS.

Therefore, only user accounts with administrator rights can use service functions and many of the functions can only be used after entering a password. These functions are described in the instrument service manual.

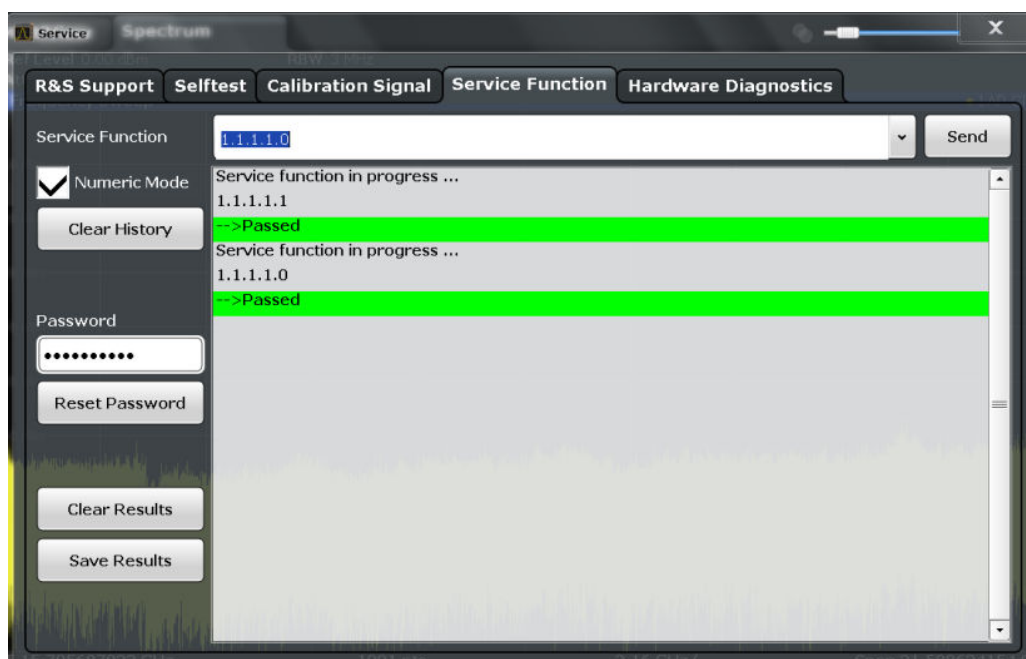

|                        |     |
|------------------------|-----|
| Service Function ..... | 571 |
| Numeric Mode .....     | 571 |
| Send .....             | 572 |
| Clear History .....    | 572 |
| Password .....         | 572 |
| Clear Results .....    | 572 |
| Save Results .....     | 572 |
| Result List .....      | 572 |

**Service Function**

Selects the service function by its numeric code or textual name.

The selection list includes all functions previously selected (since the last "Clear History" action).

Remote command:

`DIAGnostic:SERVice:SFUNction` on page 995

**Numeric Mode**

If activated, the service function is selected by its numeric code. Otherwise, the function is selected by its textual name.

**Send**

Starts the selected service function.

Remote command:

[DIAGnostic:SERvice:SFUNction](#) on page 995

**Clear History**

Deletes the list of previously selected service functions.

**Password**

Most service functions require a special password as they may disrupt normal operation of the R&S FPS. There are different levels of service functions, depending on how restrictive their use is handled. Each service level has a different password.

"Reset Password" clears any previously entered password and returns to the most restrictive service level.

**Clear Results**

Clears the result display for all previously performed service functions.

Remote command:

[DIAGnostic:SERvice:SFUNction:RESults:DELete](#) on page 995

**Save Results**

Opens a file selection dialog box to save the results of all previously performed service functions to a file.

Remote command:

[DIAGnostic:SERvice:SFUNction:RESults:SAVE](#) on page 995

**Result List**

The Results List indicates the status and results of the executed service functions.

**10.6.5 Hardware Diagnostics**

In case problems occur with the instrument hardware, some diagnostic tools provide information that may support troubleshooting.

The hardware diagnostics tools are available in the "Hardware Diagnostics" tab of the "Service" dialog box.

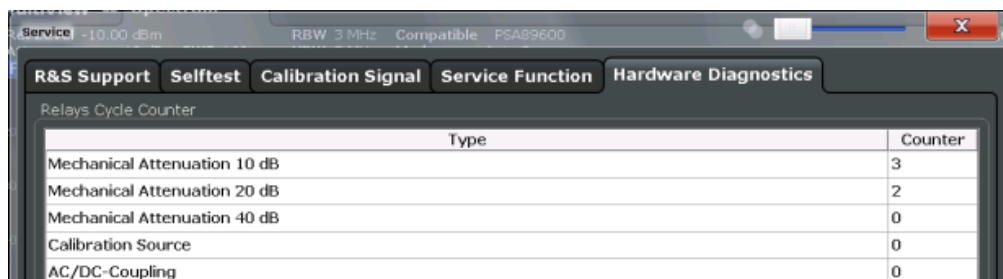

[Relays Cycle Counter](#) ..... 573

**Relays Cycle Counter**

The hardware relays built into the R&S FPS may fail after a large number of switching cycles (see data sheet). The counter indicates how many switching cycles the individual relays have performed since they were installed.

Remote command:

[DIAGnostic:INFO:CCOut?](#) on page 989

# 11 Network and Remote Operation

In addition to working with the R&S FPS interactively, located directly at the instrument, it is also possible to operate and control it from a remote PC. Various methods for remote control are supported:

- Connecting the instrument to a (LAN) network
- Using the LXI browser interface in a LAN network
- Using the Windows Remote Desktop application in a LAN network
- Connecting a PC via the GPIB interface

How to configure the remote control interfaces is described in [Chapter 4.4, "Controlling the R&S FPS Remotely"](#), on page 50.

- [Remote Control Basics](#)..... 574
- [GPIB Languages](#).....603
- [Network and Remote Control Settings](#).....605

## 11.1 Remote Control Basics

Basic information on operating an instrument via remote control is provided here. This information applies to all applications and operating modes on the R&S FPS.

See also [Chapter 4.4.1, "Remote Control Interfaces and Protocols"](#), on page 51.



For additional information on remote control of spectrum analyzers see the following application notes available from the Rohde & Schwarz website:

[1EF62: Hints and Tricks for Remote Control of Spectrum and Network Analyzers](#)

[1MA171: How to use Rohde & Schwarz Instruments in MATLAB](#)

[1MA208: Fast Remote Instrument Control with HiSLIP](#)

- [SCPI \(Standard Commands for Programmable Instruments\)](#).....574
- [Messages](#).....575
- [SCPI Command Structure](#).....576
- [Command Sequence and Synchronization](#).....584
- [Status Reporting System](#)..... 586
- [General Programming Recommendations](#).....602

### 11.1.1 SCPI (Standard Commands for Programmable Instruments)

SCPI commands - messages - are used for remote control. Commands that are not taken from the SCPI standard follow the SCPI syntax rules. The R&S FPS supports the SCPI version 1999. The SCPI standard is based on standard IEEE 488.2 and aims at the standardization of device-specific commands, error handling and the status registers. The tutorial "Automatic Measurement Control - A tutorial on SCPI and IEEE

488.2" from John M. Pieper (R&S order number 0002.3536.00) offers detailed information on concepts and definitions of SCPI.

Tables provide a fast overview of the bit assignment in the status registers. The tables are supplemented by a comprehensive description of the status registers.

## 11.1.2 Messages

The messages transferred on the data lines are divided into the following categories:

- **Interface messages**  
Interface messages are transmitted to the instrument on the data lines, with the attention line being active (LOW). They are used to communicate between the controller and the instrument. Interface messages can only be sent by instruments that have GPIB bus functionality. For details see the sections for the required interface.
- **Instrument messages**  
Instrument messages are employed in the same way for all interfaces, if not indicated otherwise in the description. Structure and syntax of the instrument messages are described in [Chapter 11.1.3, "SCPI Command Structure"](#), on page 576. A detailed description of all messages available for the instrument is provided in the chapter "Remote Control Commands".  
There are different types of instrument messages, depending on the direction they are sent:
  - Commands
  - Instrument responses

### Commands

Commands (program messages) are messages the controller sends to the instrument. They operate the instrument functions and request information. The commands are subdivided according to two criteria:

- According to the effect they have on the instrument:
  - **Setting commands** cause instrument settings such as a reset of the instrument or setting the frequency.
  - **Queries** cause data to be provided for remote control, e.g. for identification of the instrument or polling a parameter value. Queries are formed by directly appending a question mark to the command header.
- According to their definition in standards:
  - **Common commands**: their function and syntax are precisely defined in standard IEEE 488.2. They are employed identically on all instruments (if implemented). They refer to functions such as management of the standardized status registers, reset and self-test.
  - **Instrument control commands** refer to functions depending on the features of the instrument such as frequency settings. Many of these commands have also been standardized by the SCPI committee. These commands are marked as "SCPI confirmed" in the command reference chapters. Commands without this SCPI label are device-specific; however, their syntax follows SCPI rules as permitted by the standard.

### Instrument responses

Instrument responses (response messages and service requests) are messages the instrument sends to the controller after a query. They can contain measurement results, instrument settings and information on the instrument status.

## 11.1.3 SCPI Command Structure

SCPI commands consist of a header and, in most cases, one or more parameters. The header and the parameters are separated by a "white space" (ASCII code 0 to 9, 11 to 32 decimal, e.g. blank). The headers may consist of several mnemonics (keywords). Queries are formed by appending a question mark directly to the header.

The commands can be either device-specific or device-independent (common commands). Common and device-specific commands differ in their syntax.

### 11.1.3.1 Syntax for Common Commands

Common (= device-independent) commands consist of a header preceded by an asterisk (\*), and possibly one or more parameters.

*Table 11-1: Examples of common commands*

|       |                      |                                                     |
|-------|----------------------|-----------------------------------------------------|
| *RST  | RESET                | Resets the instrument.                              |
| *ESE  | EVENT STATUS ENABLE  | Sets the bits of the event status enable registers. |
| *ESR? | EVENT STATUS QUERY   | Queries the contents of the event status register.  |
| *IDN? | IDENTIFICATION QUERY | Queries the instrument identification string.       |



### 11.1.3.2 Syntax for Device-Specific Commands



Not all commands used in the following examples are necessarily implemented in the instrument. For demonstration purposes only, assume the existence of the following commands for this section:

- DISPLAY[:WINDow<1...4>]:MAXimize <Boolean>
- FORMat:READings:DATA <type>[,<length>]
- HCOpy:DEvIce:COLor <Boolean>
- HCOpy:DEvIce:CMAP:COLor:RGB <red>,<green>,<blue>
- HCOpy[:IMMediate]
- HCOpy:ITEM:ALL
- HCOpy:ITEM:LABel <string>
- HCOpy:PAGE:DIMensions:QUADrant [<N>]
- HCOpy:PAGE:ORientation LANDscape | PORTrait
- HCOpy:PAGE:SCALE <numeric value>
- MMEMoRY:COpy <file\_source>,<file\_destination>
- SENSE:BANDwidth|BWIDth[:RESolution] <numeric\_value>
- SENSE:FREQuency:STOP <numeric value>
- SENSE:LIST:FREQuency <numeric\_value>{,<numeric\_value>}

|                                             |     |
|---------------------------------------------|-----|
| • <a href="#">Long and short form</a> ..... | 577 |
| • <a href="#">Numeric Suffixes</a> .....    | 577 |
| • <a href="#">Optional Mnemonics</a> .....  | 578 |

#### Long and short form

The mnemonics feature a long form and a short form. The short form is marked by upper case letters, the long form corresponds to the complete word. Either the short form or the long form can be entered; other abbreviations are not permitted.

#### Example:

HCOpy:DEvIce:COLor ON is equivalent to HCOP:DEV:COL ON.



#### Case-insensitivity

Upper case and lower case notation only serves to distinguish the two forms in the manual, the instrument itself is case-insensitive.

#### Numeric Suffixes

If a command can be applied to multiple instances of an object, e.g. specific channels or sources, the required instances can be specified by a suffix added to the command. Numeric suffixes are indicated by angular brackets (<1...4>, <n>, <i>) and are replaced by a single value in the command. Entries without a suffix are interpreted as having the suffix 1.

**Example:**

Definition: `HCOPY:PAGE:DIMensions:QUADrant [<N>]`

Command: `HCOP:PAGE:DIM:QUAD2`

This command refers to the quadrant 2.

**Different numbering in remote control**

For remote control, the suffix may differ from the number of the corresponding selection used in manual operation. SCPI prescribes that suffix counting starts with 1. Suffix 1 is the default state and used when no specific suffix is specified.

Some standards define a fixed numbering, starting with 0. If the numbering differs in manual operation and remote control, it is indicated for the corresponding command.

**Optional Mnemonics**

Some command systems permit certain mnemonics to be inserted into the header or omitted. These mnemonics are marked by square brackets in the description. The instrument must recognize the long command to comply with the SCPI standard. Some commands are considerably shortened by these optional mnemonics.

**Example:**

Definition: `HCOPY[:IMMEDIATE]`

Command: `HCOP:IMM` is equivalent to `HCOP`

**Optional mnemonics with numeric suffixes**

Do not omit an optional mnemonic if it includes a numeric suffix that is relevant for the effect of the command.

**Example:**

Definition: `DISPlay[:WINDow<1...4>]:MAXimize <Boolean>`

Command: `DISP:MAX ON` refers to window 1.

In order to refer to a window other than 1, you must include the optional `WINDow` parameter with the suffix for the required window.

`DISP:WIND2:MAX ON` refers to window 2.

**11.1.3.3 SCPI Parameters**

Many commands are supplemented by a parameter or a list of parameters. The parameters must be separated from the header by a "white space" (ASCII code 0 to 9, 11 to 32 decimal, e.g. blank).

The parameters required for each command and the allowed range of values are specified in the command description.

Allowed parameters are:

|                                                |     |
|------------------------------------------------|-----|
| • <a href="#">Numeric Values</a> .....         | 579 |
| • <a href="#">Special Numeric Values</a> ..... | 579 |
| • <a href="#">Boolean Parameters</a> .....     | 580 |
| • <a href="#">Text Parameters</a> .....        | 580 |
| • <a href="#">Character Strings</a> .....      | 580 |
| • <a href="#">Block Data</a> .....             | 581 |

### Numeric Values

Numeric values can be entered in any form, i.e. with sign, decimal point and exponent. Values exceeding the resolution of the instrument are rounded up or down. The mantissa may comprise up to 255 characters, the exponent must lie inside the value range -32000 to 32000. The exponent is introduced by an "E" or "e". Entry of the exponent alone is not allowed.

#### Example:

```
SENS:FREQ:STOP 1500000 = SENS:FREQ:STOP 1.5E6
```

### Units

For physical quantities, the unit can be entered. If the unit is missing, the basic unit is used. Allowed unit prefixes are:

- G (giga)
- MA (mega), MOHM, MHZ
- K (kilo)
- M (milli)
- U (micro)
- N (nano)

#### Example:

```
SENSe:FREQ:STOP 1.5GHz = SENSe:FREQ:STOP 1.5E9
```

Some settings allow relative values to be stated in percent. According to SCPI, this unit is represented by the `PCT` string.

#### Example:

```
HCOP:PAGE:SCAL 90PCT
```

### Special Numeric Values

The following mnemonics are special numeric values. In the response to a query, the numeric value is provided.

- **MIN and MAX:** denote the minimum and maximum value.
- **DEF:** denotes a preset value which has been stored in the EPROM. This value conforms to the default setting, as it is called by the `*RST` command.
- **UP and DOWN:** increases or reduces the numeric value by one step. The step width can be specified via an allocated step command for each parameter which can be set via `UP` and `DOWN`.

- **INF and NINF:** INFinity and negative INFinity (NINF) represent the numeric values 9.9E37 or -9.9E37, respectively. INF and NINF are only sent as instrument responses.
- **NAN:** Not A Number (NAN) represents the value 9.91E37. NAN is only sent as a instrument response. This value is not defined. Possible causes are the division of zero by zero, the subtraction of infinite from infinite and the representation of missing values.

**Example:**

Setting command: `SENSe:LIST:FREQ MAXimum`

Query: `SENS:LIST:FREQ?`

Response: `3.5E9`

**Queries for special numeric values**

The numeric values associated to `MAXimum`/`MINimum`/`DEFault` can be queried by adding the corresponding mnemonic after the quotation mark.

Example: `SENSe:LIST:FREQ? MAXimum`

Returns the maximum numeric value as a result.

**Boolean Parameters**

Boolean parameters represent two states. The "ON" state (logically true) is represented by "ON" or a numeric value 1. The "OFF" state (logically untrue) is represented by "OFF" or the numeric value 0. The numeric values are provided as the response for a query.

**Example:**

Setting command: `HCOPY:DEV:COL ON`

Query: `HCOPY:DEV:COL?`

Response: `1`

**Text Parameters**

Text parameters observe the syntactic rules for mnemonics, i.e. they can be entered using a short or long form. Like any parameter, they have to be separated from the header by a white space. In the response to a query, the short form of the text is provided.

**Example:**

Setting command: `HCOPY:PAGE:ORIENTATION LANDscape`

Query: `HCOP:PAGE:ORI?`

Response: `LAND`

**Character Strings**

Strings must always be entered in quotation marks (' or ").

**Example:**

```
HCOP:ITEM:LABel "Test1"
```

```
HCOP:ITEM:LABel 'Test1'
```

**Block Data**

Block data is a format which is suitable for the transmission of large amounts of data. For example, a command using a block data parameter has the following structure:

```
FORMat:READings:DATA #45168xxxxxxxx
```

The ASCII character # introduces the data block. The next number indicates how many of the following digits describe the length of the data block. In the example the 4 following digits indicate the length to be 5168 bytes. The data bytes follow. During the transmission of these data bytes all end or other control signs are ignored until all bytes are transmitted.

#0 specifies a data block of indefinite length. The use of the indefinite format requires a NL^END message to terminate the data block. This format is useful when the length of the transmission is not known or if speed or other considerations prevent segmentation of the data into blocks of definite length.

**11.1.3.4 Overview of Syntax Elements**

The following tables provide an overview of the syntax elements and special characters.

**Table 11-2: Syntax elements**

|     |                                                                                                                                                                                                                     |
|-----|---------------------------------------------------------------------------------------------------------------------------------------------------------------------------------------------------------------------|
| :   | The colon separates the mnemonics of a command.                                                                                                                                                                     |
| ;   | The semicolon separates two commands of a command line. It does not alter the path.                                                                                                                                 |
| ,   | The comma separates several parameters of a command.                                                                                                                                                                |
| ?   | The question mark forms a query.                                                                                                                                                                                    |
| *   | The asterisk marks a common command.                                                                                                                                                                                |
| ' ' | Quotation marks introduce a string and terminate it (both single and double quotation marks are possible).                                                                                                          |
| #   | The hash symbol introduces binary, octal, hexadecimal and block data. <ul style="list-style-type: none"> <li>• Binary: #B10110</li> <li>• Octal: #O7612</li> <li>• Hexa: #HF3A7</li> <li>• Block: #21312</li> </ul> |
|     | A "white space" (ASCII-Code 0 to 9, 11 to 32 decimal, e.g. blank) separates the header from the parameters.                                                                                                         |

**Table 11-3: Special characters**

|            |                                                                                                                                                                                                                                                                                                                                                                                                                                                                                                                                                                                                                                                                                                                                                                                                                                                                                                                                                                                                                    |
|------------|--------------------------------------------------------------------------------------------------------------------------------------------------------------------------------------------------------------------------------------------------------------------------------------------------------------------------------------------------------------------------------------------------------------------------------------------------------------------------------------------------------------------------------------------------------------------------------------------------------------------------------------------------------------------------------------------------------------------------------------------------------------------------------------------------------------------------------------------------------------------------------------------------------------------------------------------------------------------------------------------------------------------|
| <b> </b>   | <p><b>Parameters</b></p> <p>A vertical stroke in parameter definitions indicates alternative possibilities in the sense of "or". The effect of the command differs, depending on which parameter is used.</p> <p>Example:</p> <p>Definition:HCOPY:PAGE:ORIENTATION LANDscape   PORTRait</p> <p>Command HCOP:PAGE:ORI LAND specifies landscape orientation</p> <p>Command HCOP:PAGE:ORI PORT specifies portrait orientation</p> <p><b>Mnemonics</b></p> <p>A selection of mnemonics with an identical effect exists for several commands. These mnemonics are indicated in the same line; they are separated by a vertical stroke. Only one of these mnemonics needs to be included in the header of the command. The effect of the command is independent of which of the mnemonics is used.</p> <p>Example:</p> <p>DefinitionSENSE:BANDwidth BWIDTH[:RESolution] &lt;numeric_value&gt;</p> <p>The two following commands with identical meaning can be created:</p> <p>SENS:BAND:RES 1</p> <p>SENS:BWID:RES 1</p> |
| <b>[]</b>  | <p>Mnemonics in square brackets are optional and may be inserted into the header or omitted.</p> <p>Example: HCOpy[:IMMediate]</p> <p>HCOP: IMM is equivalent to HCOP</p>                                                                                                                                                                                                                                                                                                                                                                                                                                                                                                                                                                                                                                                                                                                                                                                                                                          |
| <b>{ }</b> | <p>Parameters in curly brackets are optional and can be inserted once or several times, or omitted.</p> <p>Example: SENSE:LIST:FREQuency &lt;numeric_value&gt;{,&lt;numeric_value&gt;}</p> <p>The following are valid commands:</p> <p>SENS:LIST:FREQ 10</p> <p>SENS:LIST:FREQ 10,20</p> <p>SENS:LIST:FREQ 10,20,30,40</p>                                                                                                                                                                                                                                                                                                                                                                                                                                                                                                                                                                                                                                                                                         |

### 11.1.3.5 Structure of a Command Line

A command line may consist of one or several commands. It is terminated by one of the following:

- <New Line>
- <New Line> with EOI
- EOI together with the last data byte

Several commands in a command line must be separated by a semicolon ";".

**Example:**

```
MMEM:COPY "Test1","MeasurementXY";:HCOP:ITEM ALL
```

This command line contains two commands. The first command belongs to the MMEM system, the second command belongs to the HCOP system. If the next command belongs to a different command system, the semicolon is followed by a colon.

**Example:**

```
HCOP:ITEM ALL;:HCOP:IMM
```

This command line contains two commands. Both commands are part of the HCOP command system, i.e. they have one level in common.

If the successive commands belong to the same system, having one or several levels in common, the command line can be abbreviated. When abbreviating the command line, the second command begins with the level below HCOP. The colon after the semicolon is omitted. The abbreviated form of the command line reads as follows:

```
HCOP:ITEM ALL;IMM
```

**Example:**

```
HCOP:ITEM ALL
```

```
HCOP:IMM
```

A new command line always begins with the complete path.

**11.1.3.6 Responses to Queries**

A query is defined for each setting command unless explicitly specified otherwise. It is formed by adding a question mark to the associated setting command. According to SCPI, the responses to queries are partly subject to stricter rules than in standard IEEE 488.2.

- The requested parameter is transmitted without a header.  
**Example:** HCOP:PAGE:ORI?, **Response:** LAND
- Maximum values, minimum values and all other quantities that are requested via a special text parameter are returned as numeric values.  
**Example:** SENSE:FREQUENCY:STOP? MAX, **Response:** 3.5E9
- Numeric values are output without a unit. Physical quantities are referred to the basic units or to the units set using the Unit command. The response 3.5E9 in the previous example stands for 3.5 GHz.
- Truth values (Boolean values) are returned as 0 (for OFF) and 1 (for ON).  
**Example:**  
Setting command: HCOPI:DEV:COL ON  
Query: HCOPI:DEV:COL?  
Response: 1
- Text (character data) is returned in a short form.  
**Example:**  
Setting command: HCOPI:PAGE:ORIENTATION LANDscape  
Query: HCOPI:PAGE:ORI?  
Response: LAND
- Invalid numerical results  
In some cases, particularly when a result consists of multiple numeric values, invalid values are returned as 9.91E37 (not a number).

### 11.1.4 Command Sequence and Synchronization

IEEE 488.2 defines a distinction between overlapped and sequential commands:

- A sequential command is one which finishes executing before the next command starts executing. Commands that are processed quickly are usually implemented as sequential commands.
- An overlapping command is one which does not automatically finish executing before the next command starts executing. Usually, overlapping commands take longer to process and allow the program to do other tasks while being executed. If overlapping commands do have to be executed in a defined order, e.g. in order to avoid wrong measurement results, they must be serviced sequentially. This is called synchronization between the controller and the instrument.

Setting commands within one command line, even though they may be implemented as sequential commands, are not necessarily serviced in the order in which they have been received. In order to make sure that commands are actually carried out in a certain order, each command must be sent in a separate command line.

#### Example: Commands and queries in one message

The response to a query combined in a program message with commands that affect the queried value is not predictable.

The following commands always return the specified result:

```
:FREQ:STAR 1GHZ;SPAN 100;:FREQ:STAR?
```

Result:

```
1000000000 (1 GHz)
```

Whereas the result for the following commands is not specified by SCPI:

```
:FREQ:STAR 1GHz;STAR?;SPAN 1000000
```

The result could be the value of `START` before the command was sent since the instrument might defer executing the individual commands until a program message terminator is received. The result could also be 1 GHz if the instrument executes commands as they are received.



As a general rule, send commands and queries in different program messages.

---



**Example: Overlapping command with \*OPC**

The instrument implements `INITiate[:IMMEDIATE]` as an overlapped command. Assuming that `INITiate[:IMMEDIATE]` takes longer to execute than `*OPC`, sending the following command sequence results in initiating a sweep and, after some time, setting the `OPC` bit in the `ESR`:

```
INIT; *OPC.
```

Sending the following commands still initiates a sweep:

```
INIT; *OPC; *CLS
```

However, since the operation is still pending when the instrument executes `*CLS`, forcing it into the "Operation Complete Command Idle" State (OCIS), `*OPC` is effectively skipped. The `OPC` bit is not set until the instrument executes another `*OPC` command.

**11.1.4.1 Preventing Overlapping Execution**

To prevent an overlapping execution of commands, one of the commands `*OPC`, `*OPC?` or `*WAI` can be used. All three commands cause a certain action only to be carried out after the hardware has been set. The controller can be forced to wait for the corresponding action to occur.

**Table 11-4: Synchronization using \*OPC, \*OPC? and \*WAI**

| Command | Action                                                                                               | Programming the controller                                                                                                                              |
|---------|------------------------------------------------------------------------------------------------------|---------------------------------------------------------------------------------------------------------------------------------------------------------|
| *OPC    | Sets the Operation Complete bit in the ESR after all previous commands have been executed.           | <ul style="list-style-type: none"> <li>Setting bit 0 in the ESE</li> <li>Setting bit 5 in the SRE</li> <li>Waiting for service request (SRQ)</li> </ul> |
| *OPC?   | Stops command processing until 1 is returned. This occurs when all pending operations are completed. | Send *OPC? directly after the command whose processing must be terminated before other commands can be executed.                                        |
| *WAI    | Stops further command processing until all commands sent before *WAI have been executed.             | Send *WAI directly after the command whose processing must be terminated before other commands are executed.                                            |

Command synchronization using `*WAI` or `*OPC?` is a good choice if the overlapped command takes only little time to process. The two synchronization commands simply block overlapped execution of the command. Append the synchronization command to the overlapping command, for example:

```
SINGLE; *OPC?
```

For time consuming overlapped commands, you can allow the controller or the instrument to do other useful work while waiting for command execution. Use one of the following methods:

**\*OPC with a service request**

1. Set the OPC mask bit (bit no. 0) in the ESE: `*ESE 1`
2. Set bit no. 5 in the SRE: `*SRE 32` to enable ESB service request.
3. Send the overlapped command with `*OPC` .

4. Wait for a service request.

The service request indicates that the overlapped command has finished.

#### **\*OPC? with a service request**

1. Set bit no. 4 in the SRE: \*SRE 16 to enable MAV service request.
2. Send the overlapped command with \*OPC?.
3. Wait for a service request.

The service request indicates that the overlapped command has finished.

#### **Event status register (ESE)**

1. Set the OPC mask bit (bit no. 0) in the ESE: \*ESE 1
2. Send the overlapped command without \*OPC, \*OPC? or \*WAI.
3. Poll the operation complete state periodically (with a timer) using the sequence:  
\*OPC; \*ESR?

A return value (LSB) of 1 indicates that the overlapped command has finished.

### **11.1.5 Status Reporting System**

The status reporting system stores all information on the current operating state of the instrument, and on errors which have occurred. This information is stored in the status registers and in the error queue. Both can be queried via GPIB bus or LAN interface (STATus... commands).

(See [Chapter 12.11, "Using the Status Register"](#), on page 996).

- [Hierarchy of Status Registers](#)..... 586
- [Structure of a SCPI Status Register](#).....588
- [Contents of the Status Registers](#)..... 589
- [Application of the Status Reporting System](#).....599
- [Reset Values of the Status Reporting System](#).....602

#### **11.1.5.1 Hierarchy of Status Registers**

As shown in the following figure, the status information is of hierarchical structure.

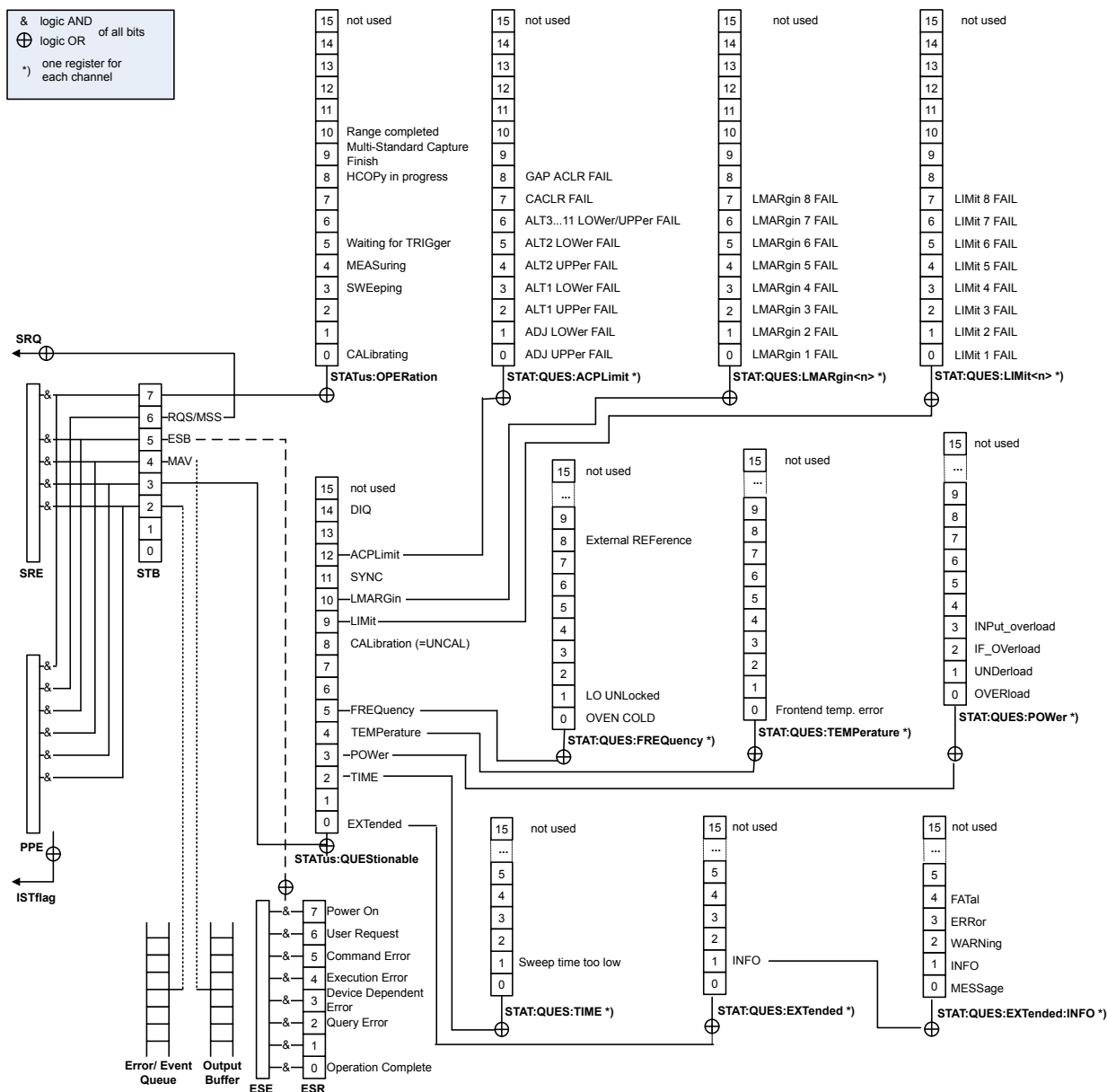

Figure 11-1: Graphical overview of the R&S FPS status registers hierarchy

- **STB, SRE**  
The STatus Byte (STB) register and its associated mask register Service Request Enable (SRE) form the highest level of the status reporting system. The STB provides a rough overview of the instrument status, collecting the information of the lower-level registers.
- **ESR, SCPI registers**  
The STB receives its information from the following registers:
  - The Event Status Register (ESR) with the associated mask register standard Event Status Enable (ESE).
  - The STATUS:OPERation and STATUS:QUESTIONable registers which are defined by SCPI and contain detailed information on the instrument.

- **IST, PPE**

The **IST** flag ("Individual Status"), like the **SRQ**, combines the entire instrument status in a single bit. The **PPE** fulfills the same function for the **IST** flag as the **SRE** for the service request.

- **Output buffer**

The output buffer contains the messages the instrument returns to the controller. It is not part of the status reporting system but determines the value of the **MAV** bit in the **STB** and thus is represented in the overview.

All status registers have the same internal structure.



### SRE, ESE

The service request enable register **SRE** can be used as **ENABLE** part of the **STB** if the **STB** is structured according to **SCPI**. By analogy, the **ESE** can be used as the **ENABLE** part of the **ESR**.

#### 11.1.5.2 Structure of a SCPI Status Register

Each standard **SCPI** register consists of 5 parts. Each part has a width of 16 bits and has different functions. The individual bits are independent of each other, i.e. each hardware status is assigned a bit number which is valid for all five parts. Bit 15 (the most significant bit) is set to zero for all parts. Thus the contents of the register parts can be processed by the controller as positive integers.

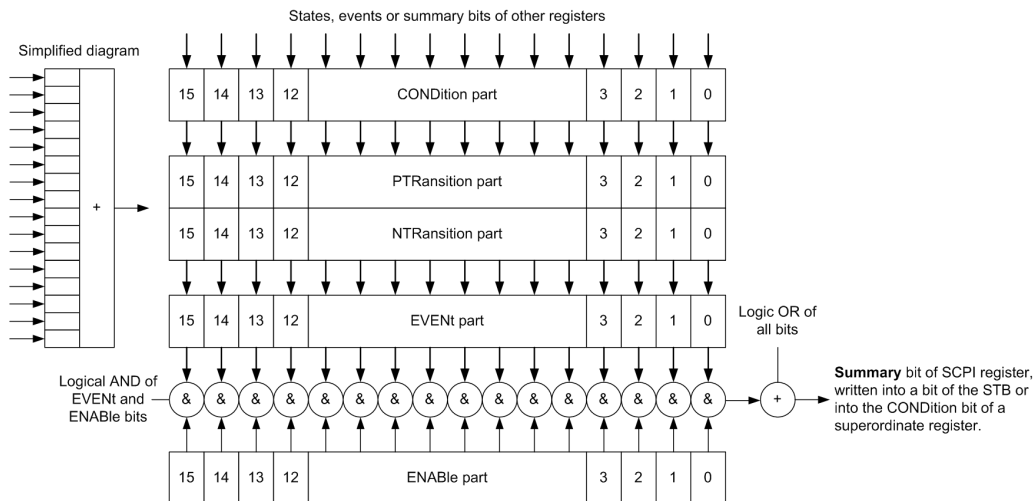

Figure 11-2: The status-register model

#### Description of the five status register parts

The five parts of a **SCPI** register have different properties and functions:

- **CONDition**

The **CONDition** part is written into directly by the hardware or the sum bit of the next lower register. Its contents reflect the current instrument status. This register

part can only be read, but not written into or cleared. Its contents are not affected by reading.

- **Ptransition / NTransition**

The two transition register parts define which state transition of the `CONDition` part (none, 0 to 1, 1 to 0 or both) is stored in the `EVENT` part.

The **Positive-TRansition** part acts as a transition filter. When a bit of the `CONDition` part is changed from 0 to 1, the associated `PTR` bit decides whether the `EVENT` bit is set to 1.

- `PTR` bit =1: the `EVENT` bit is set.
- `PTR` bit =0: the `EVENT` bit is not set.

This part can be written into and read as required. Its contents are not affected by reading.

The **Negative-TRansition** part also acts as a transition filter. When a bit of the `CONDition` part is changed from 1 to 0, the associated `NTR` bit decides whether the `EVENT` bit is set to 1.

- `NTR` bit =1: the `EVENT` bit is set.
- `NTR` bit =0: the `EVENT` bit is not set.

This part can be written into and read as required. Its contents are not affected by reading.

- **EVENT**

The `EVENT` part indicates whether an event has occurred since the last reading, it is the "memory" of the condition part. It only indicates events passed on by the transition filters. It is permanently updated by the instrument. This part can only be read by the user. Reading the register clears it. This part is often equated with the entire register.

- **ENABLE**

The `ENABLE` part determines whether the associated `EVENT` bit contributes to the sum bit (see below). Each bit of the `EVENT` part is "ANDed" with the associated `ENABLE` bit (symbol '&'). The results of all logical operations of this part are passed on to the sum bit via an "OR" function (symbol '+').

`ENABLE` bit = 0: the associated `EVENT` bit does not contribute to the sum bit

`ENABLE` bit = 1: if the associated `EVENT` bit is "1", the sum bit is set to "1" as well.

This part can be written into and read by the user as required. Its contents are not affected by reading.

### Sum bit

The sum bit is obtained from the `EVENT` and `ENABLE` part for each register. The result is then entered into a bit of the `CONDition` part of the higher-order register.

The instrument automatically generates the sum bit for each register. Thus an event can lead to a service request throughout all levels of the hierarchy.

#### 11.1.5.3 Contents of the Status Registers

In the following sections, the contents of the status registers are described in more detail.



### STATus:QUEStionable:SYNC register

The STATus:QUEStionable:SYNC register is used by the R&S FPS applications and is described in the individual sections (manuals) for each application.

- Status Byte (STB) and Service Request Enable Register (SRE).....590
- IST Flag and Parallel Poll Enable Register (PPE)..... 591
- Event Status Register (ESR) and Event Status Enable Register (ESE)..... 591
- STATus:OPERation Register.....592
- STATus:QUEStionable Register..... 593
- STATus:QUEStionable:ACPLimit Register..... 594
- STATus:QUEStionable:EXTended Register..... 595
- STATus:QUEStionable:EXTended:INFO Register..... 595
- STATus:QUEStionable:FREQuency Register..... 596
- STATus:QUEStionable:LIMit Register..... 597
- STATus:QUEStionable:LMARgin Register..... 597
- STATus:QUEStionable:POWer Register..... 598
- STATus:QUEStionable:TIMe Register.....599

#### Status Byte (STB) and Service Request Enable Register (SRE)

The STatus Byte (STB) is already defined in IEEE 488.2. It provides a rough overview of the instrument status by collecting the pieces of information of the lower registers. A special feature is that bit 6 acts as the sum bit of the remaining bits of the status byte.

The STB can thus be compared with the CONDition part of an SCPI register and assumes the highest level within the SCPI hierarchy.

The STB is read using the command \*STB? or a serial poll.

The STatus Byte (STB) is linked to the Service Request Enable (SRE) register. Each bit of the STB is assigned a bit in the SRE. Bit 6 of the SRE is ignored. If a bit is set in the SRE and the associated bit in the STB changes from 0 to 1, a service request (SRQ) is generated. The SRE can be set using the command \*SRE and read using the command \*SRE?.

**Table 11-5: Meaning of the bits used in the status byte**

| Bit No. | Meaning                                                                                                                                                                                                                                                                                                                                                                                                                                  |
|---------|------------------------------------------------------------------------------------------------------------------------------------------------------------------------------------------------------------------------------------------------------------------------------------------------------------------------------------------------------------------------------------------------------------------------------------------|
| 0...1   | Not used                                                                                                                                                                                                                                                                                                                                                                                                                                 |
| 2       | Error Queue not empty<br>The bit is set when an entry is made in the error queue. If this bit is enabled by the SRE, each entry of the error queue generates a service request. Thus an error can be recognized and specified in greater detail by polling the error queue. The poll provides an informative error message. This procedure is to be recommended since it considerably reduces the problems involved with remote control. |
| 3       | QUEStionable status register summary bit<br>The bit is set if an EVENT bit is set in the QUEStionable status register and the associated ENABLE bit is set to 1. A set bit indicates a questionable instrument status, which can be specified in greater detail by querying the STATus:QUEStionable status register.                                                                                                                     |

| Bit No. | Meaning                                                                                                                                                                                                                                                                                                                        |
|---------|--------------------------------------------------------------------------------------------------------------------------------------------------------------------------------------------------------------------------------------------------------------------------------------------------------------------------------|
| 4       | MAV bit (message available)<br>The bit is set if a message is available in the output queue which can be read. This bit can be used to enable data to be automatically read from the instrument to the controller.                                                                                                             |
| 5       | ESB bit<br>Sum bit of the event status register. It is set if one of the bits in the event status register is set and enabled in the event status enable register. Setting of this bit indicates a serious error which can be specified in greater detail by polling the event status register.                                |
| 6       | MSS bit (master status summary bit)<br>The bit is set if the instrument triggers a service request. This is the case if one of the other bits of this registers is set together with its mask bit in the service request enable register SRE.                                                                                  |
| 7       | STaTus:OPERation status register summary bit<br>The bit is set if an EVENt bit is set in the OPEratiOn status register and the associated ENABle bit is set to 1. A set bit indicates that the instrument is just performing an action. The type of action can be determined by querying the STaTus:OPERation status register. |

### IST Flag and Parallel Poll Enable Register (PPE)

As with the SRQ, the IST flag combines the entire status information in a single bit. It can be read by means of a parallel poll (see "Parallel Poll" on page 600) or using the command `*IST?`.

The parallel poll enable register (PPE) determines which bits of the STB contribute to the IST flag. The bits of the STB are "ANDed" with the corresponding bits of the PPE, with bit 6 being used as well in contrast to the SRE. The IST flag results from the "ORing" of all results. The PPE can be set using commands `*PRE` and read using command `*PRE?`.

### Event Status Register (ESR) and Event Status Enable Register (ESE)

The ESR is defined in IEEE 488.2. It can be compared with the EVENt part of a SCPI register. The event status register can be read out using command `*ESR?`.

The ESE corresponds to the ENABle part of a SCPI register. If a bit is set in the ESE and the associated bit in the ESR changes from 0 to 1, the ESB bit in the STB is set. The ESE register can be set using the command `*ESE` and read using the command `*ESE?`.

**Table 11-6: Meaning of the bits used in the event status register**

| Bit No. | Meaning                                                                                                                                                                                                                                                                                           |
|---------|---------------------------------------------------------------------------------------------------------------------------------------------------------------------------------------------------------------------------------------------------------------------------------------------------|
| 0       | Operation Complete<br>This bit is set on receipt of the command <code>*OPC</code> exactly when all previous commands have been executed.                                                                                                                                                          |
| 1       | Not used                                                                                                                                                                                                                                                                                          |
| 2       | Query Error<br>This bit is set if either the controller wants to read data from the instrument without having sent a query, or if it does not fetch requested data and sends new instructions to the instrument instead. The cause is often a query which is faulty and hence cannot be executed. |

| Bit No. | Meaning                                                                                                                                                                                                                                                        |
|---------|----------------------------------------------------------------------------------------------------------------------------------------------------------------------------------------------------------------------------------------------------------------|
| 3       | Device-dependent Error<br>This bit is set if a device-dependent error occurs. An error message with a number between -300 and -399 or a positive error number, which denotes the error in greater detail, is entered into the error queue.                     |
| 4       | Execution Error<br>This bit is set if a received command is syntactically correct but cannot be performed for other reasons. An error message with a number between -200 and -300, which denotes the error in greater detail, is entered into the error queue. |
| 5       | Command Error<br>This bit is set if a command is received, which is undefined or syntactically incorrect. An error message with a number between -100 and -200, which denotes the error in greater detail, is entered into the error queue.                    |
| 6       | User Request<br>This bit is set when the instrument is switched over to manual control.                                                                                                                                                                        |
| 7       | Power On (supply voltage on)<br>This bit is set on switching on the instrument.                                                                                                                                                                                |

### STATus:OPERation Register

The `STATus:OPERation` register contains information on current activities of the R&S FPS. It also contains information on activities that have been executed since the last read out.

You can read out the register with `STATus:OPERation:CONDition?` or `STATus:OPERation[:EVENT]?`.

**Table 11-7: Meaning of the bits used in the `STATus:OPERation` register**

| Bit No. | Meaning                                                                                                                                                               |
|---------|-----------------------------------------------------------------------------------------------------------------------------------------------------------------------|
| 0       | <code>CALibrating</code><br>This bit is set as long as the instrument is performing a calibration.                                                                    |
| 1-2     | Not used                                                                                                                                                              |
| 3       | <code>SWEeping</code><br>Sweep is being performed in base unit (applications are not considered); identical to bit 4<br>In applications, this bit is not used.        |
| 4       | <code>MEASuring</code><br>Measurement is being performed in base unit (applications are not considered); identical to bit 3<br>In applications, this bit is not used. |
| 5       | <code>Waiting for TRigger</code><br>Instrument is ready to trigger and waiting for trigger signal.                                                                    |
| 6-7     | Not used                                                                                                                                                              |
| 8       | <code>HardCOpy in progress</code><br>This bit is set while the instrument is printing a hardcopy.                                                                     |



| Bit No. | Meaning                                                                                                                                                                                                                                                                                           |
|---------|---------------------------------------------------------------------------------------------------------------------------------------------------------------------------------------------------------------------------------------------------------------------------------------------------|
| 9       | For data acquisition in MSRA mode only:<br>Multi-Standard capture finish<br>This bit is set if a data acquisition measurement was completed successfully in MSRA operating mode and data is available for evaluation.<br>For details on the MSRA operating mode see the R&S FPS MSRA User Manual. |
| 10      | Range completed<br>This bit is set when a range in the sweep list has been completed if "Stop after Range" has been activated.                                                                                                                                                                    |
| 11-14   | Not used                                                                                                                                                                                                                                                                                          |
| 15      | This bit is always 0.                                                                                                                                                                                                                                                                             |

### STATUS:QUESTIONABLE Register

The STATUS:QUESTIONABLE register contains information on instrument states that do not meet the specifications.



The `STAT:QUES:SYNC` register is used by the applications and is thus described in the individual applications' User Manuals.

You can read out the register with `STAT:QUES:COND` or `STAT:QUES:EVEN`.



The `STATUS:QUESTIONABLE` register "sums up" the information from all subregisters (e.g. bit 2 sums up the information for all `STATUS:QUESTIONABLE:TIME` registers). For some subregisters, there may be separate registers for each active channel. Thus, if a status bit in the `STATUS:QUESTIONABLE` register indicates an error, the error may have occurred in any of the channel-specific subregisters. In this case, you must check the subregister of each channel to determine which channel caused the error. By default, querying the status of a subregister always returns the result for the currently selected channel.

**Table 11-8: Meaning of the bits used in the STATUS:QUESTIONABLE register**

| Bit No. | Meaning                                                                                                                                                                                                      |
|---------|--------------------------------------------------------------------------------------------------------------------------------------------------------------------------------------------------------------|
| 0 - 1   | Unused                                                                                                                                                                                                       |
| 2       | "TIME"<br>This bit is set if a time error occurs in any of the active channels.<br>The <a href="#">STATUS:QUESTIONABLE:TIME Register</a> provides more information on the error type.                        |
| 3       | "POWER"<br>This bit is set if the measured power level in any of the active channels is questionable.<br>The <a href="#">STATUS:QUESTIONABLE:POWER Register</a> provides more information on the error type. |

| Bit No. | Meaning                                                                                                                                                                                                                                                                                                                                                                                                                                           |
|---------|---------------------------------------------------------------------------------------------------------------------------------------------------------------------------------------------------------------------------------------------------------------------------------------------------------------------------------------------------------------------------------------------------------------------------------------------------|
| 5       | "FREquency"<br>This bit is set if there is anything wrong with the frequency of the local oscillator or the reference frequency in any of the active channels.<br>The <a href="#">STATus:QUEStionable:FREquency Register</a> provides more information on the error type.                                                                                                                                                                         |
| 6 - 7   | Unused                                                                                                                                                                                                                                                                                                                                                                                                                                            |
| 8       | "CALibration"<br>This bit is set if the R&S FPS is unaligned ("UNCAL" display)                                                                                                                                                                                                                                                                                                                                                                    |
| 9       | "LIMit" (device-specific)<br>This bit is set if a limit value is violated in any of the active channels in any window.<br>The <a href="#">STATus:QUEStionable:LIMit Register</a> provides more information on the error type.                                                                                                                                                                                                                     |
| 10      | "LMARgin" (device-specific)<br>This bit is set if a margin is violated in any of the active channels in any window.<br>The <a href="#">STATus:QUEStionable:LMARgin Register</a> provides more information on the error type.                                                                                                                                                                                                                      |
| 11      | "SYNC" (device-specific)<br>This bit is set if the R&S FPS is not synchronized to the signal that is applied.<br>The R&S FPS is not synchronized if: <ul style="list-style-type: none"> <li>• it cannot synchronize to midamble during a measurement or premeasurement</li> <li>• it cannot find a burst during a measurement or premeasurement</li> <li>• the results deviate too much from the expected value during premeasurements</li> </ul> |
| 12      | "ACPLimit" (device-specific)<br>This bit is set if a limit during ACLR measurements is violated in any of the active channels.<br>The <a href="#">STATus:QUEStionable:ACPLimit Register</a> provides more information on the error type.                                                                                                                                                                                                          |
| 13-14   | Unused                                                                                                                                                                                                                                                                                                                                                                                                                                            |
| 15      | This bit is always 0.                                                                                                                                                                                                                                                                                                                                                                                                                             |

### STATus:QUEStionable:ACPLimit Register

The STATus:QUEStionable:ACPLimit register contains information about the results of a limit check during ACLR measurements. A separate ACPLimit register exists for each active channel.

You can read out the register with [STATus:QUEStionable:ACPLimit:CONDition?](#) or [STATus:QUEStionable:ACPLimit\[:EVENT\]?](#)

**Table 11-9: Meaning of the bits used in the STATus:QUEStionable:ACPLimit register**

| Bit No. | Meaning                                                                                                |
|---------|--------------------------------------------------------------------------------------------------------|
| 0       | ADJ UPPer FAIL<br>This bit is set if the limit is exceeded in the <b>upper adjacent</b> channel        |
| 1       | ADJ LOWer FAIL<br>This bit is set if the limit is exceeded in the <b>lower adjacent</b> channel.       |
| 2       | ALT1 UPPer FAIL<br>This bit is set if the limit is exceeded in the <b>upper 1st alternate</b> channel. |

| Bit No. | Meaning                                                                                                                            |
|---------|------------------------------------------------------------------------------------------------------------------------------------|
| 3       | ALT1 LOWEr FAIL<br>This bit is set if the limit is exceeded in the <b>lower 1st alternate</b> channel.                             |
| 4       | ALT2 UPPer FAIL<br>This bit is set if the limit is exceeded in the <b>upper 2nd alternate</b> channel.                             |
| 5       | ALT2 LOWEr FAIL<br>This bit is set if the limit is exceeded in the <b>lower 2nd alternate</b> channel.                             |
| 6       | ALT3 ... 11 LOWEr/UPPer FAIL<br>This bit is set if the limit is exceeded in one of the lower or upper alternate channels 3 ... 11. |
| 7       | CACLR FAIL<br>This bit is set if the CACLR limit is exceeded in one of the gap channels.                                           |
| 8       | GAP ACLR FAIL<br>This bit is set if the ACLR limit is exceeded in one of the gap channels.                                         |
| 9 to 14 | Unused                                                                                                                             |
| 15      | This bit is always 0.                                                                                                              |

### STATus:QUEStionable:EXTEnded Register

The `STATus:QUEStionable:EXTEnded` register contains further status information not covered by the other status registers of the R&S FPS. A separate `EXTEnded` register exists for each active channel.

You can read out the register with `STATus:QUEStionable:EXTEnded:CONDition?` or `STATus:QUEStionable:EXTEnded[:EVENT]?`

**Table 11-10: Meaning of the bits used in the `STATus:QUEStionable:EXTEnded` register**

| Bit No. | Meaning                                                                                                                                                                                       |
|---------|-----------------------------------------------------------------------------------------------------------------------------------------------------------------------------------------------|
| 0       | not used                                                                                                                                                                                      |
| 1       | INFO<br>This bit is set if a status message is available for the application.<br>Which type of message occurred is indicated in the <code>STATus:QUEStionable:EXTEnded:INFO Register</code> . |
| 2 to 14 | Unused                                                                                                                                                                                        |
| 15      | This bit is always 0.                                                                                                                                                                         |

### STATus:QUEStionable:EXTEnded:INFO Register

The `STATus:QUEStionable:EXTEnded:INFO` register contains information on the type of messages that occur during operation of the R&S FPS. A separate `INFO` register exists for each active channel.

You can read out the register with `STATus:QUEStionable:EXTEnded:INFO:CONDition?` or `STATus:QUEStionable:EXTEnded:INFO[:EVENT]?`. You can query all messages that occur for a specific channel using the command `SYSTEM:ERRor:EXTEnded?` on page 991.

**Table 11-11: Meaning of the bits used in the STATus:QUESTionable:EXTended:INFO register**

| Bit No. | Meaning                                                                                                                                                                                                       |
|---------|---------------------------------------------------------------------------------------------------------------------------------------------------------------------------------------------------------------|
| 0       | MESSage<br>This bit is set if event or state has occurred that may lead to an error during further operation.                                                                                                 |
| 1       | INFO<br>This bit is set if an informational status message is available for the application.                                                                                                                  |
| 2       | WARNIng<br>This bit is set if an irregular situation occurs during measurement, e.g. the settings no longer match the displayed results, or the connection to an external device was interrupted temporarily. |
| 3       | ERRor<br>This bit is set if an error occurs during a measurement, e.g. due to missing data or wrong settings, so that the measurement cannot be completed correctly.                                          |
| 4       | FATal<br>This bit is set if a serious error occurs in the application and regular operation is no longer possible.                                                                                            |
| 5 to 14 | Unused                                                                                                                                                                                                        |
| 15      | This bit is always 0.                                                                                                                                                                                         |

**STATus:QUESTionable:FREQuency Register**

The STATus:QUESTionable:FREQuency register contains information about the condition of the local oscillator and the reference frequency. A separate frequency register exists for each active channel.

You can read out the register with `STATus:QUESTionable:FREQuency:CONDition?` or `STATus:QUESTionable:FREQuency[:EVENT]?`.

**Table 11-12: Meaning of the bits used in the STATus:QUESTionable:FREQuency register**

| Bit No. | Meaning                                                                                                                                                                                                                                             |
|---------|-----------------------------------------------------------------------------------------------------------------------------------------------------------------------------------------------------------------------------------------------------|
| 0       | OVEN COLD<br>This bit is set if the reference oscillator has not yet attained its operating temperature. "OCXO" is displayed.                                                                                                                       |
| 1       | LO UNLocked<br>This bit is set if the local oscillator no longer locks. "LOUNL" is displayed.                                                                                                                                                       |
| 2 to 7  | Not used                                                                                                                                                                                                                                            |
| 8       | EXTernalREFerence<br>This bit is set if you have selected an external reference oscillator but did not connect a useable external reference source.<br>In that case the synthesizer can not lock. The frequency in all probability is not accurate. |
| 9 to 14 | Not used                                                                                                                                                                                                                                            |
| 15      | This bit is always 0.                                                                                                                                                                                                                               |

### STATus:QUEStionable:LIMit Register

The STATus:QUEStionable:LIMit register contains information about the results of a limit check when you are working with limit lines.

A separate LIMit register exists for each active channel and for each window.

You can read out the register with `STATus:QUEStionable:LIMit<n>:CONDition?` or `STATus:QUEStionable:LIMit<n>[:EVENT]?`.

**Table 11-13: Meaning of the bits used in the STATus:QUEStionable:LIMit register**

| Bit No. | Meaning                                                      |
|---------|--------------------------------------------------------------|
| 0       | LIMit 1 FAIL<br>This bit is set if limit line 1 is violated. |
| 1       | LIMit 2 FAIL<br>This bit is set if limit line 2 is violated. |
| 2       | LIMit 3 FAIL<br>This bit is set if limit line 3 is violated. |
| 3       | LIMit 4 FAIL<br>This bit is set if limit line 4 is violated. |
| 4       | LIMit 5 FAIL<br>This bit is set if limit line 5 is violated. |
| 5       | LIMit 6 FAIL<br>This bit is set if limit line 6 is violated. |
| 6       | LIMit 7 FAIL<br>This bit is set if limit line 7 is violated. |
| 7       | LIMit 8 FAIL<br>This bit is set if limit line 8 is violated. |
| 8 to 14 | Unused                                                       |
| 15      | This bit is always 0.                                        |

### STATus:QUEStionable:LMARgin Register

This register contains information about the observance of limit margins.

A separate LMARgin register exists for each active channel and for each window.

It can be read using the commands

`STATus:QUEStionable:LMARgin:CONDition?` and  
`STATus:QUEStionable:LMARgin[:EVENT]?`.

**Table 11-14: Meaning of the bits used in the `STATUS:QUESTIONable:LMARgin` register**

| Bit No. | Meaning                                                          |
|---------|------------------------------------------------------------------|
| 0       | LMARgin 1 FAIL<br>This bit is set if limit margin 1 is violated. |
| 1       | LMARgin 2 FAIL<br>This bit is set if limit margin 2 is violated. |
| 2       | LMARgin 3 FAIL<br>This bit is set if limit margin 3 is violated. |
| 3       | LMARgin 4 FAIL<br>This bit is set if limit margin 4 is violated. |
| 4       | LMARgin 5 FAIL<br>This bit is set if limit margin 5 is violated. |
| 5       | LMARgin 6 FAIL<br>This bit is set if limit margin 6 is violated. |
| 6       | LMARgin 7 FAIL<br>This bit is set if limit margin 7 is violated. |
| 7       | LMARgin 8 FAIL<br>This bit is set if limit margin 8 is violated. |
| 8 to 14 | Not used                                                         |
| 15      | This bit is always 0.                                            |

**STATUS:QUESTIONable:POWER Register**

The `STATUS:QUESTIONable:POWER` register contains information about possible overload situations that may occur during operation of the R&S FPS. A separate power register exists for each active channel.

You can read out the register with `STATUS:QUESTIONable:POWER:CONDition?` or `STATUS:QUESTIONable:POWER[:EVENT]?`

**Table 11-15: Meaning of the bits used in the `STATUS:QUESTIONable:POWER` register**

| Bit No. | Meaning                                                                                                                                                                               |
|---------|---------------------------------------------------------------------------------------------------------------------------------------------------------------------------------------|
| 0       | OVERload<br>This bit is set if an overload occurs at the RF input, causing signal distortion but not yet causing damage to the device.<br>The R&S FPS displays the keyword "RF OVLD". |
| 1       | UNDerload<br>This bit is set if an underload occurs at the RF input.<br>The R&S FPS displays the keyword "UNLD".                                                                      |
| 2       | IF_Overload<br>This bit is set if an overload occurs in the IF path.<br>The R&S FPS displays the keyword "IF OVLD".                                                                   |

| Bit No. | Meaning                                                                                                                                                                                                                                                                                                                                                                                  |
|---------|------------------------------------------------------------------------------------------------------------------------------------------------------------------------------------------------------------------------------------------------------------------------------------------------------------------------------------------------------------------------------------------|
| 3       | <p>Input Overload</p> <p>This bit is set if the signal level at the RF input connector exceeds the maximum.</p> <p>The RF input is disconnected from the input mixer to protect the device. In order to re-enable measurement, decrease the level at the RF input connector and reconnect the RF input to the mixer input.</p> <p>The R&amp;S FPS displays the keyword "INPUT OVLD".</p> |
| 4 to 14 | Unused                                                                                                                                                                                                                                                                                                                                                                                   |
| 15      | This bit is always 0.                                                                                                                                                                                                                                                                                                                                                                    |

### STATus:QUEStionable:TIME Register

The `STATus:QUEStionable:TIME` register contains information about possible time errors that may occur during operation of the R&S FPS. A separate time register exists for each active channel.

You can read out the register with `STATus:QUEStionable:TIME:CONDition?` or `STATus:QUEStionable:TIME[:EVENT]?`

**Table 11-16: Meaning of the bits used in the `STATus:QUEStionable:TIME` register**

| Bit No. | Meaning                                                                        |
|---------|--------------------------------------------------------------------------------|
| 0       | not used                                                                       |
| 1       | <p>Sweep time too low</p> <p>This bit is set if the sweep time is too low.</p> |
| 2 to 14 | Unused                                                                         |
| 15      | This bit is always 0.                                                          |

#### 11.1.5.4 Application of the Status Reporting System

The purpose of the status reporting system is to monitor the status of one or several devices in a measuring system. To do this and react appropriately, the controller must receive and evaluate the information of all devices. The following standard methods are used:

- **Service request** (SRQ) initiated by the instrument
- **Serial poll** of all devices in the bus system, initiated by the controller in order to find out who sent a SRQ and why
- **Parallel poll** of all devices
- Query of a **specific instrument status** by means of commands
- Query of the **error queue**

#### Service Request

Under certain circumstances, the instrument can send a service request (SRQ) to the controller. A service request is a request from an instrument for information, advice or treatment by the controller. Usually this service request initiates an interrupt at the controller, to which the control program can react appropriately. As evident from [Fig-](#)

Figure 11-1, an SRQ is always initiated if one or several of bits 2, 3, 4, 5 or 7 of the status byte are set and enabled in the SRE. Each of these bits combines the information of a further register, the error queue or the output buffer. The `ENABLE` parts of the status registers can be set such that arbitrary bits in an arbitrary status register initiate an SRQ. In order to make use of the possibilities of the service request effectively, all bits should be set to "1" in enable registers SRE and ESE.

The service request is the only possibility for the instrument to become active on its own. Each controller program should cause the instrument to initiate a service request if errors occur. The program should react appropriately to the service request.

#### Use of the command `*OPC` to generate an SRQ at the end of a sweep

1. `CALL InstrWrite(analyzer, "*ESE 1")` 'Set bit 0 in the ESE (Operation Complete)
2. `CALL InstrWrite(analyzer, "*SRE 32")` 'Set bit 5 in the SRE (ESB)
3. `CALL InstrWrite(analyzer, "*INIT;*OPC")` 'Generate an SRQ after operation complete

After its settings have been completed, the instrument generates an SRQ.

A detailed example for a service request routine is provided in [Chapter 12.15.2, "Service Request"](#), on page 1044.

#### Serial Poll

In a serial poll, just as with command `*STB`, the status byte of an instrument is queried. However, the query is realized via interface messages and is thus clearly faster.

The serial poll method is defined in IEEE 488.1 and used to be the only standard possibility for different instruments to poll the status byte. The method also works for instruments which do not adhere to SCPI or IEEE 488.2.

The serial poll is mainly used to obtain a fast overview of the state of several instruments connected to the controller.

#### Parallel Poll

In a parallel poll, up to eight instruments are simultaneously requested by the controller using a single command to transmit 1 bit of information each on the data lines, i.e., to set the data line allocated to each instrument to a logical "0" or "1".

In addition to the SRE register, which determines the conditions under which an SRQ is generated, there is a Parallel Poll Enable register (PPE) which is ANDed with the STB bit by bit, considering bit 6 as well. This register is ANDed with the STB bit by bit, considering bit 6 as well. The results are ORed, the result is possibly inverted and then sent as a response to the parallel poll of the controller. The result can also be queried without parallel poll using the command `*IST?`.

The instrument first has to be set for the parallel poll using the command `PPC`. This command allocates a data line to the instrument and determines whether the response is to be inverted. The parallel poll itself is executed using `PPE`.



The parallel poll method is mainly used to find out quickly which one of the instruments connected to the controller has sent a service request. To this effect, SRE and PPE must be set to the same value.

### Query of an instrument status

Each part of any status register can be read using queries. There are two types of commands:

- The common commands `*ESR?`, `*IDN?`, `*IST?`, `*STB?` query the higher-level registers.
- The commands of the `STATus` system query the SCPI registers (`STATus:QUEStionable...`)

The returned value is always a decimal number that represents the bit pattern of the queried register. This number is evaluated by the controller program.

Queries are usually used after an SRQ in order to obtain more detailed information on the cause of the SRQ.

### Decimal representation of a bit pattern

The STB and ESR registers contain 8 bits, the SCPI registers 16 bits. The contents of a status register are specified and transferred as a single decimal number. To make this possible, each bit is assigned a weighted value. The decimal number is calculated as the sum of the weighted values of all bits in the register that are set to 1.

|        |   |   |   |   |    |    |    |     |     |
|--------|---|---|---|---|----|----|----|-----|-----|
| Bits   | 0 | 1 | 2 | 3 | 4  | 5  | 6  | 7   | ... |
| Weight | 1 | 2 | 4 | 8 | 16 | 32 | 64 | 128 | ... |

### Example:

The decimal value  $40 = 32 + 8$  indicates that bits no. 3 and 5 in the status register (e.g. the `QUEStionable` status summary bit and the `ESB` bit in the `STatus Byte`) are set.

### Error Queue

Each error state in the instrument leads to an entry in the error queue. The entries of the error queue are detailed plain text error messages that can be looked up in the Error Log or queried via remote control using `SYSTem:ERRor[:NEXT]?`. Each call of `SYSTem:ERRor[:NEXT]?` provides one entry from the error queue. If no error messages are stored there any more, the instrument responds with 0, "No error".

The error queue should be queried after every SRQ in the controller program as the entries describe the cause of an error more precisely than the status registers. Especially in the test phase of a controller program the error queue should be queried regularly since faulty commands from the controller to the instrument are recorded there as well.

### 11.1.5.5 Reset Values of the Status Reporting System

The following table contains the different commands and events causing the status reporting system to be reset. None of the commands, except \*RST and SYSTem:PRESet, influence the functional instrument settings. In particular, DCL does not change the instrument settings.

**Table 11-17: Resetting the status reporting system**

| Event                                                                                                                 | Switching on supply voltage<br>Power-On-Status-Clear |     | DCL,<br>SDC<br>(Device<br>Clear,<br>Selected<br>Device<br>Clear) | *RST or<br>SYS-<br>Tem:PRE-<br>Set | STA-<br>Tus:PRE-<br>Set | *CLS |
|-----------------------------------------------------------------------------------------------------------------------|------------------------------------------------------|-----|------------------------------------------------------------------|------------------------------------|-------------------------|------|
|                                                                                                                       | 0                                                    | 1   |                                                                  |                                    |                         |      |
| Clear STB, ESR                                                                                                        | -                                                    | yes | -                                                                | -                                  | -                       | yes  |
| Clear SRE, ESE                                                                                                        | -                                                    | yes | -                                                                | -                                  | -                       | -    |
| Clear PPE                                                                                                             | -                                                    | yes | -                                                                | -                                  | -                       | -    |
| Clear EVENT parts of the registers                                                                                    | -                                                    | yes | -                                                                | -                                  | -                       | yes  |
| Clear ENABLE parts of all OPERation and QUEStionable registers;<br>Fill ENABLE parts of all other registers with "1". | -                                                    | yes | -                                                                | -                                  | yes                     | -    |
| Fill PTRansition parts with "1";<br>Clear NTRansition parts                                                           | -                                                    | yes | -                                                                | -                                  | yes                     | -    |
| Clear error queue                                                                                                     | yes                                                  | yes | -                                                                | -                                  | -                       | yes  |
| Clear output buffer                                                                                                   | yes                                                  | yes | yes                                                              | 1)                                 | 1)                      | 1)   |
| Clear command processing and input buffer                                                                             | yes                                                  | yes | yes                                                              | -                                  | -                       | -    |

1) The first command in a command line that immediately follows a <PROGRAM MESSAGE TERMINATOR> clears the output buffer.

### 11.1.6 General Programming Recommendations

#### Initial instrument status before changing settings

Manual operation is designed for maximum possible operating convenience. In contrast, the priority of remote control is the "predictability" of the instrument status. Thus, when a command attempts to define incompatible settings, the command is ignored and the instrument status remains unchanged, i.e. other settings are not automatically adapted. Therefore, control programs should always define an initial instrument status (e.g. using the \*RST command) and then implement the required settings.

**Command sequence**

As a general rule, send commands and queries in different program messages. Otherwise, the result of the query may vary depending on which operation is performed first (see also [Chapter 11.1.4.1, "Preventing Overlapping Execution"](#), on page 585).

**Reacting to malfunctions**

The service request is the only possibility for the instrument to become active on its own. Each controller program should instruct the instrument to initiate a service request in case of malfunction. The program should react appropriately to the service request.

**Error queues**

The error queue should be queried after every service request in the controller program as the entries describe the cause of an error more precisely than the status registers. Especially in the test phase of a controller program the error queue should be queried regularly since faulty commands from the controller to the instrument are recorded there as well.

## 11.2 GPIB Languages

The R&S FPS analyzer family supports a subset of the GPIB commands used by other devices. Thus it can emulate other devices in order to use existing remote control programs.

The device model to be emulated is selected manually using "SETUP > Network + Remote > GPIB tab > Language". Via the GPIB interface using the [SYSTem: LANGuage](#) on page 1002 command.

In order to emulate device models that are not part of the selection list of the GPIB "Language" setting, you can modify the identification string received in response to the ID command ("Identification String" setting). Thus, any device model whose command set is compatible with one of the supported device models can be emulated.

**Supported languages**

| Language | Comment               |
|----------|-----------------------|
| SCPI     |                       |
| 71100C   | Compatible to 8566A/B |
| 71200C   | Compatible to 8566A/B |
| 71209A   | Compatible to 8566A/B |
| 8560E    |                       |
| 8561E    |                       |
| 8562E    |                       |

| Language | Comment                                                                                                       |
|----------|---------------------------------------------------------------------------------------------------------------|
| 8563E    |                                                                                                               |
| 8564E    |                                                                                                               |
| 8565E    |                                                                                                               |
| 8566A    | Command sets A and B are available. Command sets A and B differ in the rules regarding the command structure. |
| 8566B    |                                                                                                               |
| 8568A    | Command sets A and B are available. Command sets A and B differ in the rules regarding the command structure. |
| 8568A_DC | Uses DC input coupling by default if supported by the instrument                                              |
| 8568B    | Command sets A and B are available. Command sets A and B differ in the rules regarding the command structure. |
| 8568B_DC | Uses DC input coupling by default if supported by the instrument                                              |
| 8591E    | Compatible to 8594E                                                                                           |
| 8594E    | Command sets A and B are available. Command sets A and B differ in the rules regarding the command structure. |
| PSA89600 |                                                                                                               |
| PSA      |                                                                                                               |

**Notes:**

- If you select a language other than "SCPI", the GPIB address is set to 18 if it was 20 before.
- The Start/stop frequency, reference level and number of sweep points are adapted to the selected instrument model.
- When you switch between remote control languages, the following settings or changes are made:  
**SCPI:**  
The instrument performs a PRESET.  
**8566A/B, 8568A/B, 8594E; FSEA, FSEB, FSEM; FSEK:**
  - The instrument performs a PRESET.
  - The following instrument settings are changed:

*Table 11-18: Instrument settings for emulation of 8566A/B, 8568A/B, 8594E; FSEA, FSEB, FSEM; FSEK instruments*

| Model   | # of Trace Points | Start Freq. | Stop Freq. | Ref Level | Input Coupling |
|---------|-------------------|-------------|------------|-----------|----------------|
| 8566A/B | 1001              | 2 GHz       | 22 GHz     | 0 dBm     | AC             |
| 8568A/B | 1001              | 0 Hz        | 1.5 GHz    | 0 dBm     | AC             |
| 8560E   | 601               | 0 Hz        | 2.9 GHz    | 0 dBm     | AC             |
| 8561E   | 601               | 0 Hz        | 6.5 GHz    | 0 dBm     | AC             |
| 8562E   | 601               | 0 Hz        | 13.2 GHz   | 0 dBm     | AC             |

| Model | # of Trace Points | Start Freq. | Stop Freq. | Ref Level | Input Coupling |
|-------|-------------------|-------------|------------|-----------|----------------|
| 8563E | 601               | 0 Hz        | 26.5 GHz   | 0 dBm     | AC             |
| 8564E | 601               | 0 Hz        | 40 GHz     | 0 dBm     | AC             |
| 8565E | 601               | 0 Hz        | 50 GHz     | 0 dBm     | AC             |
| 8594E | 401               | 0 Hz        | 3 GHz      | 0 dBm     | AC             |

**Note:** The stop frequency indicated in the table may be limited to the corresponding frequency of the R&S FPS, if required.

## 11.3 Network and Remote Control Settings

**Access:** SETUP > "Network + Remote"



Some of the following settings and functions are also available directly on the R&S FPS, via the miniature display. See [Chapter 4.3, "Miniature Display"](#), on page 41.



### Network settings in secure user mode

Be sure to store all network settings before [SecureUser Mode](#) is enabled; see [Chapter 4.1.6, "Protecting Data Using the Secure User Mode"](#), on page 33.

If the currently stored network settings are not suitable, you must correct them each time you switch on the R&S FPS in secure user mode, as the settings are not stored permanently in this case.

The remote commands required to define these settings are described in [Chapter 12.10.6, "Configuring the Network and Remote Control"](#), on page 985.

Step-by-step instructions are provided in [Chapter 4.4, "Controlling the R&S FPS Remotely"](#), on page 50.

- [General Network Settings](#)..... 605
- [GPIB Settings](#)..... 607
- [Compatibility Settings](#)..... 610
- [LXI Settings](#)..... 612
- [Remote Errors](#)..... 614
- [Returning to Manual Mode \("Local"\)](#)..... 616

### 11.3.1 General Network Settings

**Access:** SETUP > "Network + Remote" > "Network" tab

The R&S FPS can be operated in a local area network (LAN), for example to control the instrument from a remote PC or use a network printer.

**NOTICE**

**Risk of network problems**

All parameters can be edited here; however, beware that changing the computer name has major effects in a network.

For details, see [Chapter 4.4, "Controlling the R&S FPS Remotely"](#), on page 50.

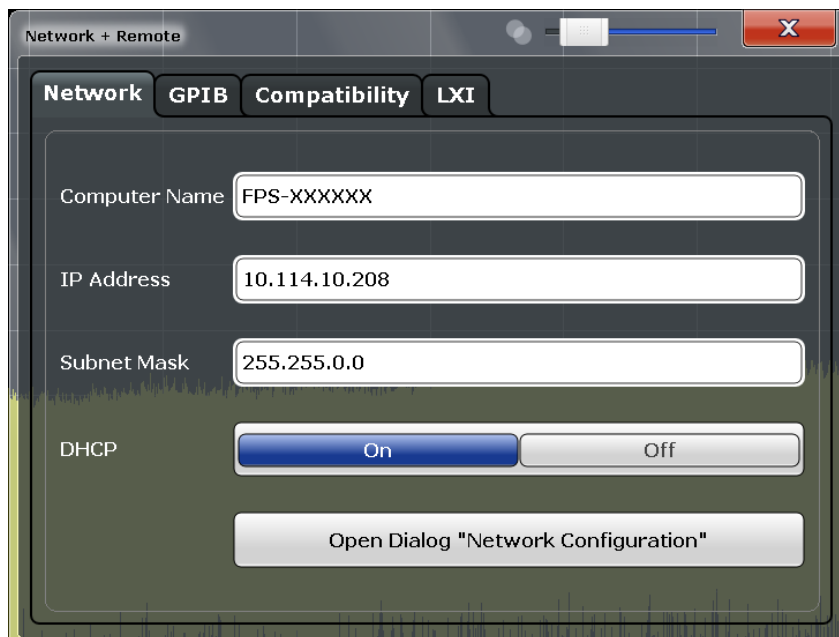

[Computer Name](#).....606

[IP Address](#).....607

[Subnet Mask](#).....607

[DHCP](#).....607

[Network Configuration](#).....607

**Computer Name**

Each instrument is delivered with an assigned computer name, but this name can be changed. The naming conventions of Windows apply. If too many characters and/or numbers are entered, an error message is displayed in the status line.

The default instrument name is a non-case-sensitive string with the following syntax:

<Type><variant>-<serial\_number>

For example FPS13-123456

The serial number can be found on the rear panel of the instrument. It is the third part of the device ID printed on the bar code sticker:



#### IP Address

Defines the IP address. The TCP/IP protocol is preinstalled with the IP address 10.0.0.10. If the DHCP server is available ("DHCP On"), the setting is read-only.

The IP address consists of four number blocks separated by dots. Each block contains 3 numbers in maximum (e.g. 100.100.100.100), but also one or two numbers are allowed in a block (as an example see the preinstalled address).

#### Subnet Mask

Defines the subnet mask. The TCP/IP protocol is preinstalled with the subnet mask 255.255.255.0. If the DHCP server is available ("DHCP On"), this setting is read-only.

The subnet mask consists of four number blocks separated by dots. Each block contains 3 numbers in maximum (e.g. 100.100.100.100), but also one or two numbers are allowed in a block (as an example see the preinstalled address).

#### DHCP

Switches between DHCP server available (On) or not available (Off). If a DHCP server is available in the network, the IP address and subnet mask of the instrument are obtained automatically from the DHCP server.

#### Network Configuration

Opens the standard Windows "Network Configuration" dialog box for further configuration.

### 11.3.2 GPIB Settings

**Access:** SETUP > "Network + Remote" > "GPIB" tab

Alternatively to connecting the R&S FPS to a LAN, the GPIB interface can be used to connect a remote PC. For details see [Chapter 4.4.1.2, "GPIB Interface \(IEC 625/IEEE 418 Bus Interface\)"](#), on page 56).

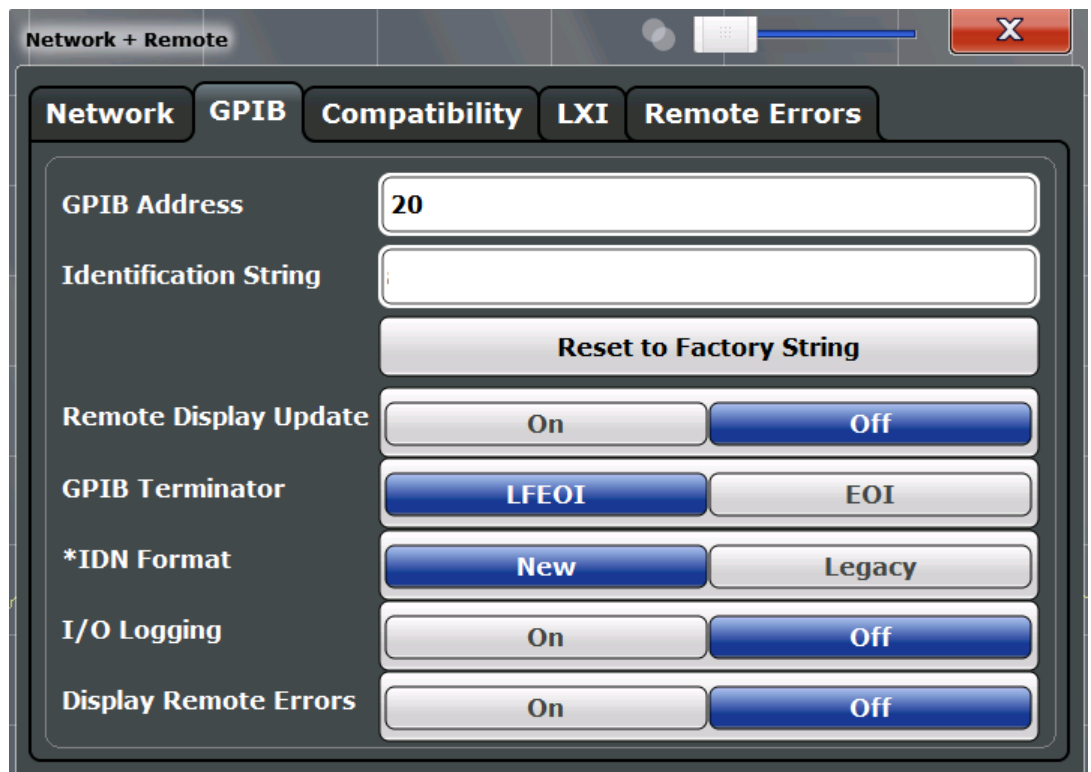

|                              |     |
|------------------------------|-----|
| GPIB Address.....            | 608 |
| Identification String.....   | 608 |
| Reset to Factory String..... | 608 |
| Remote Display Update.....   | 609 |
| GPIB Terminator.....         | 609 |
| *IDN Format.....             | 609 |
| I/O Logging.....             | 609 |
| Display Remote Errors.....   | 609 |

**GPIB Address**

Defines the GPIB address. Values from 0 to 30 are allowed. The default address is 20.

Remote command:

`SYSTem:COMMunicate:GPIB[:SELF]:ADDRes` on page 985

**Identification String**

Defines the identification string for the R&S FPS which is provided as a response to the \*IDN? query. Maximum 36 characters are allowed.

Remote command:

`SYSTem:IDENtify[:STRing]` on page 987

**Reset to Factory String**

Restores the default identification string. Each R&S FPS has a unique ID according to the following syntax:

Rohde&Schwarz,FPS,<Unique number>



Remote command:

[SYSTem:IDENTify:FACTory](#) on page 987

### Remote Display Update

Defines whether the display of the R&S FPS is updated when changing from manual operation to remote control.

Turning off the display update function improves performance during remote control.

Remote command:

[SYSTem:DISPlay:UPDate](#) on page 986

### GPIO Terminator

Changes the GPIB receive terminator.

"LFEOI" According to the standard, the terminator in ASCII is <LF> and/or <EOI>.

"EOI" For binary data transfers (e.g. trace data) from the control computer to the instrument, the binary code used for <LF> might be included in the binary data block, and therefore should not be interpreted as a terminator in this particular case. This can be avoided by using only the receive terminator `EOI`.

Remote command:

[SYSTem:COMMunicate:GPIO\[:SELF\]:RTERminator](#) on page 985

### \*IDN Format

Defines the response format to the remote command `*IDN?` (see [\\*IDN?](#) on page 620). This function is intended for re-use of existing control programs together with the R&S FPS.

"Leg" Legacy format, as in the R&S FSP/FSU/FSQ family.

"New" R&S FPS format.

Remote command:

[SYSTem:FORMat:IDENT](#) on page 993

### I/O Logging

Activates or deactivates the SCPI error log function. All remote control commands received by the R&S FPS are recorded in the following log file:

```
C:\R_S\INSTR\ScpiLogging\ScpiLog.txt
```

Logging the commands may be extremely useful for debug purposes, e.g. in order to find misspelled keywords in control programs.

Remote command:

[SYSTem:CLOGging](#) on page 1001

### Display Remote Errors

Activates and deactivates the display of errors that occur during remote operation of the R&S FPS. If activated, the R&S FPS displays a message box at the bottom of the screen that contains the type of error and the command that caused the error.



The error message remains in place when you switch to "Local" mode. To close the message box, select the  "Close" icon.

Only the most recent error is displayed in remote mode. However, in local mode, all errors that occurred during remote operation are listed in a separate tab of the "Network + Remote" dialog box (see [Chapter 11.3.5, "Remote Errors"](#), on page 614).

Remote command:

[SYSTem:ERRor:DISPlay](#) on page 986

[SYSTem:ERRor:CLEar:REMote](#) on page 991

### 11.3.3 Compatibility Settings

The R&S FPS can emulate the GPIB interface of other signal and spectrum analyzers, e.g. in order to use existing control applications.

The required settings are configured in the "Compatibility" tab of the "Network + Remote" dialog box.



|                                                      |     |
|------------------------------------------------------|-----|
| <a href="#">Language</a> .....                       | 610 |
| <a href="#">IF Gain</a> .....                        | 611 |
| <a href="#">Sweep Repeat</a> .....                   | 611 |
| <a href="#">Coupling</a> .....                       | 611 |
| <a href="#">Revision String</a> .....                | 611 |
| <a href="#">Resetting the Factory Revision</a> ..... | 612 |

#### Language

Defines the system language used to control the instrument.

For details on the available GPIB languages, see [Chapter 12.13.2, "Reference: GPIB Commands of Emulated HP Models"](#), on page 1004.

**Note:** For PSA89600 emulation, the option is indicated as "B7J" for the \*OPT? query ("B7J, 140").

Remote command:

[SYSTem:LANGuage](#) on page 1002

### IF Gain

Configures the internal IF gain settings in HP emulation mode due to the application needs. This setting is only taken into account for resolution bandwidth < 300 kHz.

|      |                                                                                 |
|------|---------------------------------------------------------------------------------|
| NORM | Optimized for high dynamic range, overload limit is close to reference level.   |
| PULS | Optimized for pulsed signals, overload limit up to 10 dB above reference level. |

This setting is only available if an HP language is selected (see ["Language"](#) on page 610).

Remote command:

[SYSTem:IFGain:MODE](#) on page 1002

### Sweep Repeat

Controls a repeated sweep of the E1 and MKPK HI HP model commands (for details on the commands refer to [Chapter 12.13.2, "Reference: GPIB Commands of Emulated HP Models"](#), on page 1004). If the repeated sweep is OFF, the marker is set without sweeping before.

**Note:** In single sweep mode, switch off this setting before you set the marker via the E1 and MKPK HI commands in order to avoid sweeping again.

This setting is only available if a HP language is selected (see ["Language"](#) on page 610).

Remote command:

[SYSTem:RSweep](#) on page 1004

### Coupling

Controls the default coupling ratios in the HP emulation mode for:

- span and resolution bandwidth (Span/RBW)
- resolution bandwidth and video bandwidth (RBW/VBW)

For FSx, the standard parameter coupling of the instrument is used. As a result, in most cases a shorter sweep time is used than in case of HP.

This setting is only available if a HP language is selected (see ["Language"](#) on page 610).

Remote command:

[SYSTem:HPCoupling](#) on page 1002

### Revision String

Defines the response to the REV? query for the revision number (HP emulation only, see ["GPIB Address"](#) on page 46). Max. 36 characters are allowed.

Remote command:

`SYSTem:REVision[:STRing]` on page 1003

#### Resetting the Factory Revision

Resets the response to the `REV?` query for the revision number to the factory default (HP emulation only, see "[Language](#)" on page 610).

Remote command:

`SYSTem:REVision:FACTory` on page 988

### 11.3.4 LXI Settings

**Access:** SETUP > "Network + Remote" > "LXI" tab

On the R&S FPS the LXI Class C functionality is already installed and enabled; thus, the instrument can be accessed via any web browser (e.g. the Microsoft Internet Explorer) to perform the following tasks:

- modifying network configurations
- modifying device configurations
- monitoring connections from the device to other devices

The "LXI" tab of the "Network + Remote" dialog box provides basic LXI functions and information for the R&S FPS.

Alternatively, you can change the LAN settings using the LXI Web browser interface.

For details see [Chapter 4.4.2.3, "How to Configure the LAN Using the LXI Web Browser Interface"](#), on page 63.

Only user accounts with administrator rights are able to use LXI functionality.

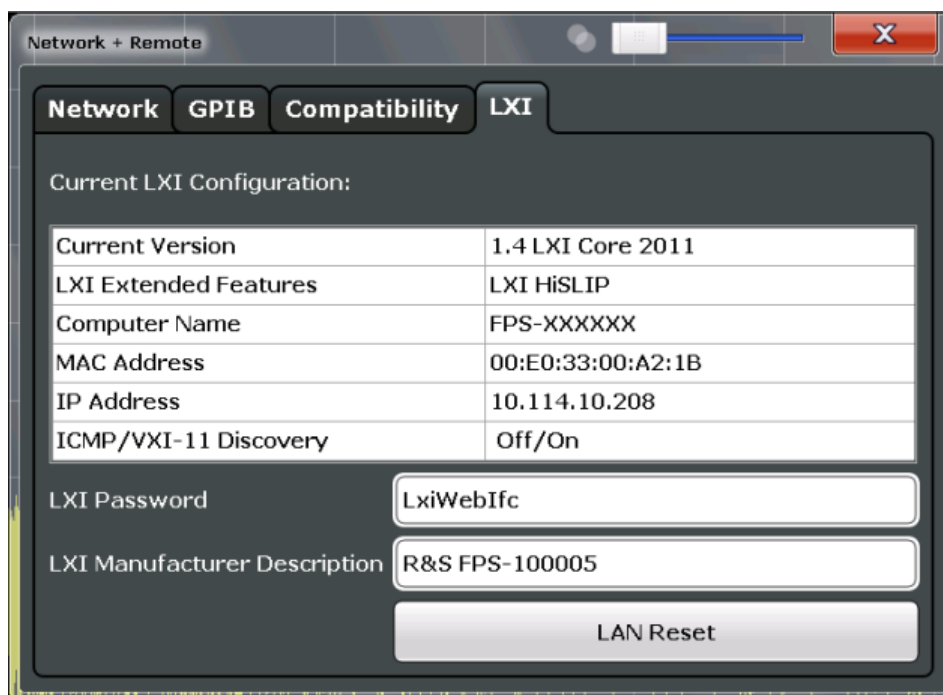

[Current LXI Configuration](#)..... 613

[LXI Password](#)..... 613

[LXI Manufacturer Description](#)..... 614

[LAN Reset](#)..... 614

**Current LXI Configuration**

Displays the current LXI information from the R&S FPS (read-only).

- "Current ver-  
sion"      Current LXI version
- "LXI Extended  
Features"      Detected LXI features, such as HiSlip (see "[HiSLIP Protocol](#)" on page 53)
- "Computer  
name"      Name of the R&S FPS as defined in the operating system (see also "[Computer Name](#)" on page 43)
- "MAC address"      Media Access Control address (MAC address), a unique identifier for the network card in the R&S FPS
- "IP address"      IP address of the R&S FPS as defined in the operating system (see also "[IP Address](#)" on page 43).
- "ICMP"      Indicates whether the ping responder is active or not
- "VXI-11 Dis-  
covery"      If enabled, connected devices are detected automatically using the VXI-11 protocol (see "[VXI-11 Protocol](#)" on page 53)

Remote command:  
[SYSTem: LXI : INFO?](#) on page 987

**LXI Password**

Password for LAN configuration. The default password is *LxiWebIfc*.

Remote command:

[SYSTem:LXI:PASSword](#) on page 988

#### LXI Manufacturer Description

Instrument description of the R&S FPS

Remote command:

[SYSTem:LXI:MDEScription](#) on page 988

#### LAN Reset

Resets the LAN configuration to its default settings (LCI function).

According to the LXI standard, an LCI must set the following parameters to a default state.

| Parameter                      | Value                  |
|--------------------------------|------------------------|
| TCP/IP Mode                    | DHCP + Auto IP Address |
| Dynamic DNS                    | Enabled                |
| ICMP Ping                      | Enabled                |
| Password for LAN configuration | LxiWebIfc              |

The LAN configuration can be reset to its default settings directly on the instrument via the R&S FPS's mini display ("System commands" > "LAN reset"), or in the "Network" tab of the "Network + Remote" dialog box or using the instrument's LXI Browser interface.

Remote command:

[SYSTem:LXI:LANReset](#) on page 988

### 11.3.5 Remote Errors

**Access:** SETUP > "Network + Remote" > "Remote Errors " tab

The error messages generated by the R&S FPS during remote operation are displayed here.

The messages are displayed in the order of their occurrence; the most recent messages are placed at the top of the list.

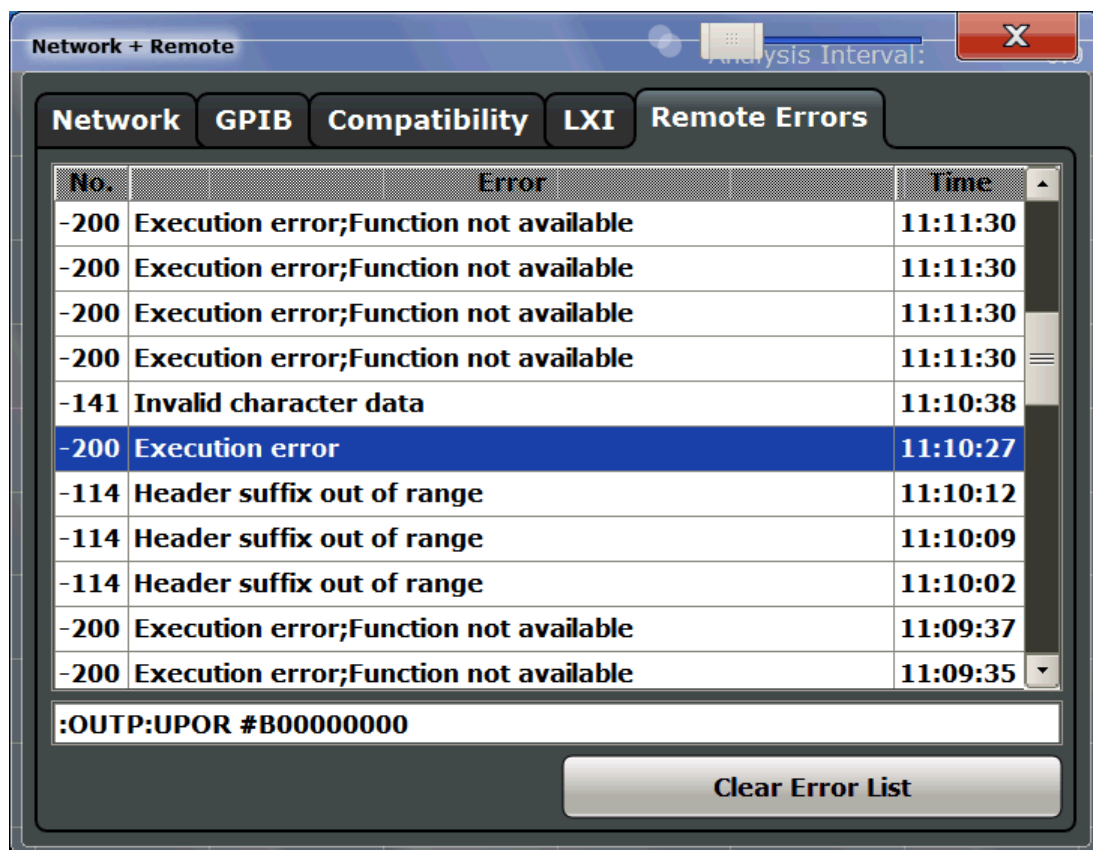

| No.  | Error                                  | Time     |
|------|----------------------------------------|----------|
| -200 | Execution error;Function not available | 11:11:30 |
| -200 | Execution error;Function not available | 11:11:30 |
| -200 | Execution error;Function not available | 11:11:30 |
| -200 | Execution error;Function not available | 11:11:30 |
| -141 | Invalid character data                 | 11:10:38 |
| -200 | Execution error                        | 11:10:27 |
| -114 | Header suffix out of range             | 11:10:12 |
| -114 | Header suffix out of range             | 11:10:09 |
| -114 | Header suffix out of range             | 11:10:02 |
| -200 | Execution error;Function not available | 11:09:37 |
| -200 | Execution error;Function not available | 11:09:35 |

:OUTP:UPOR #B00000000

Clear Error List



The most recent error message during remote operation can be displayed on the screen, see "[Display Remote Errors](#)" on page 609.

If the number of error messages exceeds the capacity of the error buffer, the oldest error message is removed before the newest one is inserted. To clear the message buffer use the "Clear Error List" button. It is automatically cleared when the R&S FPS is shut down.

The following information is available:

|           |                                |
|-----------|--------------------------------|
| No        | Device-specific error code     |
| Error     | Brief description of the error |
| Date/Time | Time the message occurred      |

#### Remote command:

`SYSTEM:ERRor:LIST?` on page 992

#### Clear Error List

Deletes the error message buffer for remote operation.

**Note:** The remote error list is automatically cleared when the R&S FPS is shut down.

Remote command:

[SYSTem:ERRor:CLEar:REMOte](#) on page 991

### 11.3.6 Returning to Manual Mode ("Local")

When switched on, the instrument is always in the manual measurement mode and can be operated via the front panel. As soon as the instrument receives a remote command, it is switched to the remote control mode.

In remote control mode, all keys of the instrument except the PRESET key are disabled. The "LOCAL" softkey and the [Remote Display Update](#) softkey are displayed.

#### Local

The instrument switches from remote to manual operation, but only if the local lockout function has not been activated in the remote control mode (see ["GPIB Interface Messages"](#) on page 57).

Furthermore, when you return to manual operation, the following happens:

- All front panel keys are enabled.
- The main softkey menu of the current mode is displayed.
- The measurement diagrams, traces and display fields are displayed again.
- If, at the time of pressing the "LOCAL" softkey, the synchronization mechanism via \*OPC, \*OPC? or \*WAI is active, the currently running measurement procedure is aborted and synchronization is achieved by setting the corresponding bits in the registers of the status reporting system.
- Bit 6 (User Request) of the Event Status Register is set.  
If the status reporting system is configured accordingly, this bit immediately causes the generation of a service request (SRQ) to inform the control software that the user wishes to return to front panel control. For example, this can be used to interrupt the control program and to correct instrument settings manually. This bit is set each time the "LOCAL" softkey is pressed.

**Note:** Before you switch back to manual operation, all remote command processing must be completed. Otherwise, the instrument will switch back to remote control immediately.

If you select the "Local" softkey while a self-alignment or a self-test is still running (which was started remotely), the instrument only returns to the manual operation state when the alignment or test is completed.

Remote command:

[SYSTem:KLOCK](#) on page 987



## 12 Remote Commands

The commands required to perform measurements in the Spectrum application in a remote environment are described here.

It is assumed that the R&S FPS has already been set up for remote operation in a network as described in [Chapter 4.4, "Controlling the R&S FPS Remotely"](#), on page 50.



### Compatibility with former R&S signal and spectrum analyzers

As a rule, the R&S FPS supports most commands from previous R&S signal and spectrum analyzers such as the FSQ, FSP, FSU, or FSV. However, the default values, in particular the number of sweep points or particular bandwidths, may vary. Therefore, the R&S FPS can emulate these other devices, including their default values, in order to repeat previous measurements or support existing control applications as in legacy systems.

|                                                                       |      |
|-----------------------------------------------------------------------|------|
| • <a href="#">Conventions Used in SCPI Command Descriptions</a> ..... | 617  |
| • <a href="#">Common Suffixes</a> .....                               | 618  |
| • <a href="#">Common Commands</a> .....                               | 618  |
| • <a href="#">Selecting the Operating Mode and Application</a> .....  | 623  |
| • <a href="#">Configuring and Performing Measurements</a> .....       | 633  |
| • <a href="#">Configuring the Result Display</a> .....                | 765  |
| • <a href="#">Setting Basic Measurement Parameters</a> .....          | 775  |
| • <a href="#">Analyzing Measurements (Basics)</a> .....               | 835  |
| • <a href="#">Managing Settings and Results</a> .....                 | 935  |
| • <a href="#">Configuring the R&amp;S FPS</a> .....                   | 969  |
| • <a href="#">Using the Status Register</a> .....                     | 996  |
| • <a href="#">Commands for Remote Instrument Operation</a> .....      | 1000 |
| • <a href="#">Emulating Other Instruments' Commands</a> .....         | 1001 |
| • <a href="#">Deprecated Commands</a> .....                           | 1039 |
| • <a href="#">Programming Examples</a> .....                          | 1041 |

### 12.1 Conventions Used in SCPI Command Descriptions

Note the following conventions used in the remote command descriptions:

- **Command usage**  
If not specified otherwise, commands can be used both for setting and for querying parameters.  
If a command can be used for setting or querying only, or if it initiates an event, the usage is stated explicitly.
- **Parameter usage**  
If not specified otherwise, a parameter can be used to set a value and it is the result of a query.  
Parameters required only for setting are indicated as **Setting parameters**.  
Parameters required only to refine a query are indicated as **Query parameters**.

Parameters that are only returned as the result of a query are indicated as **Return values**.

- **Conformity**  
Commands that are taken from the SCPI standard are indicated as **SCPI confirmed**. All commands used by the R&S FPS follow the SCPI syntax rules.
- **Asynchronous commands**  
A command which does not automatically finish executing before the next command starts executing (overlapping command) is indicated as an **Asynchronous command**.
- **Reset values (\*RST)**  
Default parameter values that are used directly after resetting the instrument (\*RST command) are indicated as \*RST values, if available.
- **Default unit**  
This is the unit used for numeric values if no other unit is provided with the parameter.
- **Manual operation**  
If the result of a remote command can also be achieved in manual operation, a link to the description is inserted.

## 12.2 Common Suffixes

In the Spectrum application, the following common suffixes are used in remote commands:

*Table 12-1: Common suffixes used in remote commands in the Spectrum application*

| Suffix | Value range | Description                                |
|--------|-------------|--------------------------------------------|
| <m>    | 1 to 16     | Marker                                     |
| <n>    | 1 to 16     | Window (in the currently selected channel) |
| <t>    | 1 to 6      | Trace                                      |

## 12.3 Common Commands

Common commands are described in the IEEE 488.2 (IEC 625-2) standard. These commands have the same effect and are employed in the same way on different devices. The headers of these commands consist of "\*" followed by three letters. Many common commands are related to the Status Reporting System.

Available common commands:

|       |     |
|-------|-----|
| *CAL? | 619 |
| *CLS  | 619 |
| *ESE  | 619 |
| *ESR? | 619 |
| *IDN? | 620 |

|       |     |
|-------|-----|
| *IST? | 620 |
| *OPC  | 620 |
| *OPT? | 620 |
| *PCB  | 621 |
| *PRE  | 621 |
| *PSC  | 621 |
| *RST  | 621 |
| *SRE  | 622 |
| *STB? | 622 |
| *TRG  | 622 |
| *TST? | 622 |
| *WAI  | 623 |

---

### \*CAL?

Calibration query

Initiates a calibration of the instrument and subsequently queries the calibration status. Responses > 0 indicate errors.

**Note:** If you start a self-alignment remotely, then select the "Local" softkey while the alignment is still running, the instrument only returns to the manual operation state after the alignment is completed.

**Usage:** Query only

**Manual operation:** See "Self align" on page 44  
See " Start Self Alignment " on page 534

---

### \*CLS

Clear status

Sets the status byte (STB), the standard event register (ESR) and the `EVENT` part of the `QUESTIONABLE` and the `OPERATION` registers to zero. The command does not alter the mask and transition parts of the registers. It clears the output buffer.

**Usage:** Setting only

---

### \*ESE <Value>

Event status enable

Sets the event status enable register to the specified value. The query returns the contents of the event status enable register in decimal form.

**Parameters:**

<Value>                      Range:      0 to 255

---

### \*ESR?

Event status read

Returns the contents of the event status register in decimal form and subsequently sets the register to zero.

**Return values:**

<Contents>                      Range:        0 to 255

**Usage:**                              Query only

**\*IDN?**

Identification

Returns the instrument identification.

**Return values:**

<ID>                                      "Rohde&Schwarz,<device type>,<part number>/<serial number>,<firmware version>"

**Example:**                              Rohde&Schwarz,FPS-7,1319.2008K07/100005,1.00

**Usage:**                                      Query only

**Manual operation:**    See ["\\*IDN Format"](#) on page 609

**\*IST?**

Individual status query

Returns the contents of the IST flag in decimal form. The IST flag is the status bit which is sent during a parallel poll.

**Return values:**

<ISTflag>                              0 | 1

**Usage:**                                      Query only

**\*OPC**

Operation complete

Sets bit 0 in the event status register when all preceding commands have been executed. This bit can be used to initiate a service request. The query form writes a "1" into the output buffer as soon as all preceding commands have been executed. This is used for command synchronization.

**\*OPT?**

Option identification query

Queries the options included in the instrument. For a list of all available options and their description refer to the data sheet.

**Return values:**

<Options> The query returns a list of all installed and activated options, separated by commas, where:  
 B<number> describes hardware options  
 K<number> describes software options  
 For PSA89600 emulation, the option is indicated as "B7J" for the \*OPT? query ("B7J, 140" if SYST:PSA:WID is activated).

**Usage:** Query only

**\*PCB <Address>**

Pass control back

Indicates the controller address to which remote control is returned after termination of the triggered action.

**Setting parameters:**

<Address> Range: 0 to 30

**Usage:** Setting only

**\*PRE <Value>**

Parallel poll register enable

Sets parallel poll enable register to the indicated value. The query returns the contents of the parallel poll enable register in decimal form.

**Parameters:**

<Value> Range: 0 to 255

**\*PSC <Action>**

Power on status clear

Determines whether the contents of the ENABLE registers are preserved or reset when the instrument is switched on. Thus a service request can be triggered when the instrument is switched on, if the status registers ESE and SRE are suitably configured. The query reads out the contents of the "power-on-status-clear" flag.

**Parameters:**

<Action> 0 | 1

**0**

The contents of the status registers are preserved.

**1**

Resets the status registers.

**\*RST**

Reset

Sets the instrument to a defined default status. The default settings are indicated in the description of commands.

The command is equivalent to `SYSTem:PRESet`.

**Usage:**                   Setting only

---

**\*SRE <Contents>**

Service request enable

Sets the service request enable register to the indicated value. This command determines under which conditions a service request is triggered.

**Parameters:**

<Contents>                   Contents of the service request enable register in decimal form.  
Bit 6 (MSS mask bit) is always 0.

Range:       0 to 255

---

**\*STB?**

Status byte query

Reads the contents of the status byte in decimal form.

**Usage:**                   Query only

---

**\*TRG**

Trigger

Triggers all actions waiting for a trigger event. In particular, \*TRG generates a manual trigger signal. This common command complements the commands of the `TRIGger` subsystem.

**Usage:**                   Event

---

**\*TST?**

Self-test query

Initiates self-tests of the instrument and returns an error code

**Note:** If you start a self-test remotely, then select the "Local" softkey while the test is still running, the instrument only returns to the manual operation state after the test is completed. In this case, the self-test cannot be aborted.

**Return values:**

<ErrorCode>            **integer > 0 (in decimal format)**  
 An error occurred.  
 (For details see the Service Manual supplied with the instrument).  
**0**  
 No errors occurred.

**Usage:**                    Query only

**Manual operation:**    See "Selftest" on page 44

**\*WAI**

Wait to continue

Prevents servicing of the subsequent commands until all preceding commands have been executed and all signals have settled (see also command synchronization and \*OPC).

**Usage:**                    Event

## 12.4 Selecting the Operating Mode and Application

The following commands are required to select the operating mode or the application and to configure a Sequencer in a remote environment.

- [Selecting the Mode and Applications](#)..... 623
- [Performing a Sequence of Measurements](#)..... 628
- [Programming Example: Performing a Sequence of Measurements](#)..... 631

### 12.4.1 Selecting the Mode and Applications

|                                                   |     |
|---------------------------------------------------|-----|
| <a href="#">DISPlay:ATAB</a> .....                | 623 |
| <a href="#">INSTrument:CREate:DUPLicate</a> ..... | 624 |
| <a href="#">INSTrument:CREate[NEW]</a> .....      | 624 |
| <a href="#">INSTrument:CREate:REPLace</a> .....   | 625 |
| <a href="#">INSTrument:DELeTe</a> .....           | 625 |
| <a href="#">INSTrument:LIST?</a> .....            | 625 |
| <a href="#">INSTrument:MODE</a> .....             | 626 |
| <a href="#">INSTrument:REName</a> .....           | 627 |
| <a href="#">INSTrument[SELect]</a> .....          | 627 |

**DISPlay:ATAB <State>**

This command switches between the MultiView tab and the most recently displayed channel. If only one channel is active, this command has no effect.

**Parameters:**

<State> ON | OFF | 1 | 0

**ON | 1**  
The MultiView tab is displayed.

**OFF | 0**  
The most recently displayed channel is displayed.

\*RST: 0

**INSTrument:CREate:DUPLicate**

This command duplicates the currently selected channel, i.e. creates a new channel of the same type and with the identical measurement settings. The name of the new channel is the same as the copied channel, extended by a consecutive number (e.g. "IQAnalyzer" -> "IQAnalyzer 2").

The channel to be duplicated must be selected first using the `INST:SEL` command.

This command is not available if the MSRA Master channel is selected.

**Example:**

```
INST:SEL 'IQAnalyzer'
```

```
INST:CRE:DUPL
```

Duplicates the channel named 'IQAnalyzer' and creates a new channel named 'IQAnalyzer2'.

**Usage:** Event

**Manual operation:** See "[Duplicate Current Channel](#)" on page 118

**INSTrument:CREate[:NEW] <ChannelType>, <ChannelName>**

This command adds an additional channel.

The number of channels you can configure at the same time depends on available memory.

See also

- [INSTrument\[:SElect\]](#) on page 627
- [INSTrument:CREate:DUPLicate](#) on page 624

**Parameters:**

<ChannelType> Channel type of the new channel.  
For a list of available channel types see [INSTrument:LIST?](#) on page 625.

<ChannelName> String containing the name of the channel. The channel name is displayed as the tab label for the channel.  
Note: If the specified name for a new channel already exists, the default name, extended by a sequential number, is used for the new channel (see [INSTrument:LIST?](#) on page 625).

**Example:**

```
INST:CRE IQ, 'IQAnalyzer2'
```

Adds an additional I/Q Analyzer channel named "IQAnalyzer2".



**Manual operation:** See ["New Channel"](#) on page 118

---

**INSTRument:CREate:REPLace** <ChannelName1>,<ChannelType>,<ChannelName2>

This command replaces a channel with another one.

**Setting parameters:**

<ChannelName1> String containing the name of the channel you want to replace.

<ChannelType> Channel type of the new channel.  
For a list of available channel types see [INSTRument:LIST?](#) on page 625.

<ChannelName2> String containing the name of the new channel.  
Note: If the specified name for a new channel already exists, the default name, extended by a sequential number, is used for the new channel (see [INSTRument:LIST?](#) on page 625).

**Example:** `INST:CRE:REPL 'IQAnalyzer2',IQ,'IQAnalyzer'`  
Replaces the channel named "IQAnalyzer2" by a new channel of type "IQ Analyzer" named "IQAnalyzer".

**Usage:** Setting only

**Manual operation:** See ["Replace Current Channel"](#) on page 118

---

**INSTRument:DELeTe** <ChannelName>

This command deletes a channel.

If you delete the last channel, the default "Spectrum" channel is activated.

**Parameters:**

<ChannelName> String containing the name of the channel you want to delete.  
A channel must exist in order to be able delete it.

**Example:** `INST:DEL 'IQAnalyzer4'`  
Deletes the channel with the name 'IQAnalyzer4'.

**Usage:** Event

**Manual operation:** See ["Closing an application"](#) on page 118

---

**INSTRument:LIST?**

This command queries all active channels. This is useful in order to obtain the names of the existing channels, which are required in order to replace or delete the channels.

**Return values:**

<ChannelType>,  
<ChannelName> For each channel, the command returns the channel type and channel name (see tables below).  
Tip: to change the channel name, use the [INSTRument:REName](#) command.

**Example:**                   INST:LIST?  
                                   Result for 3 channels:  
                                   'ADEM', 'Analog Demod', 'IQ', 'IQ  
                                   Analyzer', 'IQ', 'IQ Analyzer2'

**Usage:**                    Query only

**Table 12-2: Available channel types and default channel names in Signal and Spectrum Analyzer mode**

| Application                                                                                                                                                                                      | <ChannelType><br>Parameter | Default Channel Name*) |
|--------------------------------------------------------------------------------------------------------------------------------------------------------------------------------------------------|----------------------------|------------------------|
| Spectrum                                                                                                                                                                                         | SANALYZER                  | Spectrum               |
| 1xEV-DO BTS (R&S FPS-K84)                                                                                                                                                                        | BDO                        | 1xEV-DO BTS            |
| 1xEV-DO MS (R&S FPS-K85)                                                                                                                                                                         | MDO                        | 1xEV-DO MS             |
| 3GPP FDD BTS (R&S FPS-K72)                                                                                                                                                                       | BWCD                       | 3G FDD BTS             |
| 3GPP FDD UE (R&S FPS-K73)                                                                                                                                                                        | MWCD                       | 3G FDD UE              |
| Analog Demodulation (R&S FPS-K7)                                                                                                                                                                 | ADEM                       | Analog Demod           |
| cdma2000 BTS (R&S FPS-K82)                                                                                                                                                                       | BC2K                       | CDMA2000 BTS           |
| cdma2000 MS (R&S FPS-K83)                                                                                                                                                                        | MC2K                       | CDMA2000 MS            |
| GSM (R&S FPS-K10)                                                                                                                                                                                | GSM                        | GSM                    |
| I/Q Analyzer                                                                                                                                                                                     | IQ                         | IQ Analyzer            |
| LTE (R&S FPS-K10x)                                                                                                                                                                               | LTE                        | LTE                    |
| NB-IoT (R&S FPS-K106)                                                                                                                                                                            | NIOT                       | NB-IoT                 |
| Noise (R&S FPS-K30)                                                                                                                                                                              | NOISE                      | Noise                  |
| Phase Noise (R&S FPS-K40)                                                                                                                                                                        | PNOISE                     | Phase Noise            |
| TD-SCDMA BTS (R&S FPS-K76)                                                                                                                                                                       | BTDS                       | TD-SCDMA BTS           |
| TD-SCDMA UE (R&S FPS-K77)                                                                                                                                                                        | MTDS                       | TD-SCDMA UE            |
| Verizon 5GTF Measurement Application (V5GTF, R&S FPS-K118)                                                                                                                                       | V5GT                       | V5GT                   |
| VSA (R&S FPS-K70)                                                                                                                                                                                | DDEM                       | VSA                    |
| WLAN (R&S FPS-K91)                                                                                                                                                                               | WLAN                       | WLAN                   |
| *) the default channel name is also listed in the table. If the specified name for a new channel already exists, the default name, extended by a sequential number, is used for the new channel. |                            |                        |

### INSTrument:MODE <OpMode>

The operating mode of the R&S FPS determines which applications are available and active. Whenever you change the operating mode, the currently active channels are closed. The default operating mode is Signal and Spectrum Analyzer mode, however, the presetting can be changed.

(See the "Instrument Setup" chapter in the R&S FPS User Manual).

For details on operating modes and applications see [Chapter 5, "Applications, Measurement Channels, and Operating Modes"](#), on page 110.

**Parameters:**

<OpMode>           **SANalyzer**  
Signal and Spectrum Analyzer mode

**MSRAnalyzer**  
Multi-Standard Radio Analysis (MSRA) mode

\*RST:           SAN

**Example:**

INST:MODE MSR  
Switches to Multi-Standard Radio Analysis (MSRA) mode.

**Manual operation:** See ["Switching the operating mode"](#) on page 117

**INSTrument:REName** <ChannelName1>, <ChannelName2>

This command renames a channel.

**Parameters:**

<ChannelName1>   String containing the name of the channel you want to rename.

<ChannelName2>   String containing the new channel name.  
Note that you cannot assign an existing channel name to a new channel; this will cause an error.

**Example:**

INST:REN 'IQAnalyzer2', 'IQAnalyzer3'  
Renames the channel with the name 'IQAnalyzer2' to 'IQAnalyzer3'.

**Usage:**

Setting only

**INSTrument[:SElect]** <ChannelType> | <ChannelName>

This command activates a new channel with the defined channel type, or selects an existing channel with the specified name.

Also see

- [INSTrument:CREate\[:NEW\]](#) on page 624
- [Chapter 12.4.3, "Programming Example: Performing a Sequence of Measurements"](#), on page 631

**Parameters:**

<ChannelType>   Channel type of the new channel.  
For a list of available channel types see [INSTrument:LIST?](#) on page 625.

<ChannelName>   String containing the name of the channel.

- Example:**           INST IQ  
 Activates a channel for the I/Q Analyzer application (evaluation mode).  
 INST 'MyIQSpectrum'  
 Selects the channel named 'MyIQSpectrum' (for example before executing further commands for that channel).
- Manual operation:** See "Spectrum" on page 112  
 See "1xEV-DO BTS" on page 112  
 See "1xEV-DO MS" on page 112  
 See "3G FDD BTS" on page 113  
 See "3G FDD UE" on page 113  
 See "Amplifier" on page 113  
 See "Analog Demodulation" on page 113  
 See "cdma2000 BTS" on page 113  
 See "cdma2000 MS" on page 114  
 See "GSM" on page 114  
 See "I/Q Analyzer" on page 114  
 See "LTE" on page 114  
 See "NB-IoT" on page 114  
 See "Noise Figure" on page 114  
 See "Phase Noise" on page 115  
 See "Pulse Measurements" on page 115  
 See "TD-SCDMA BTS" on page 115  
 See "TD-SCDMA UE" on page 115  
 See "Verizon 5GTF Measurement Application (V5GTF)" on page 115  
 See "Vector Signal Analysis (VSA)" on page 116  
 See "WLAN" on page 116  
 See "Selecting an application" on page 117  
 See "New Channel" on page 118

## 12.4.2 Performing a Sequence of Measurements

The following commands control the sequencer.

For details on the Sequencer see [Chapter 5.4.1, "The Sequencer Concept"](#), on page 119.

|                                                            |     |
|------------------------------------------------------------|-----|
| <a href="#">INITiate&lt;n&gt;:SEQuencer:ABORt.....</a>     | 628 |
| <a href="#">INITiate&lt;n&gt;:SEQuencer:IMMediate.....</a> | 629 |
| <a href="#">INITiate&lt;n&gt;:SEQuencer:MODE.....</a>      | 629 |
| <a href="#">SYSTem:SEQuencer.....</a>                      | 630 |

---

### INITiate<n>:SEQuencer:ABORt

This command stops the currently active sequence of measurements. The Sequencer itself is not deactivated, so you can start a new sequence immediately using [INITiate<n>:SEQuencer:IMMediate](#) on page 629.

To deactivate the Sequencer use [SYSTem:SEQuencer](#) on page 630.

**Suffix:**

&lt;n&gt; irrelevant

**Usage:**

Event

**Manual operation:** See " [Sequencer State](#) " on page 121**INITiate<n>:SEQuencer:IMMEDIATE**

This command starts a new sequence of measurements by the Sequencer.

Its effect is similar to the [INITiate<n>\[:IMMEDIATE\]](#) command used for a single measurement.

Before this command can be executed, the Sequencer must be activated (see [SYSTem:SEQuencer](#) on page 630).

**Suffix:**

&lt;n&gt; irrelevant

**Example:**

SYST:SEQ ON

Activates the Sequencer.

INIT:SEQ:MODE SING

Sets single sequence mode so each active measurement will be performed once.

INIT:SEQ:IMM

Starts the sequential measurements.

**Usage:**

Event

**Manual operation:** See " [Sequencer State](#) " on page 121**INITiate<n>:SEQuencer:MODE <Mode>**

This command selects the way the R&S FPS application performs measurements sequentially.

Before this command can be executed, the Sequencer must be activated (see [SYSTem:SEQuencer](#) on page 630).

A detailed programming example is provided in [Chapter 12.4.3, "Programming Example: Performing a Sequence of Measurements"](#), on page 631.

**Note:** In order to synchronize to the end of a sequential measurement using \*OPC, \*OPC? or \*WAI you must use SINGle Sequence mode.

For details on synchronization see [Chapter 11.1.4, "Command Sequence and Synchronization"](#), on page 584

**Suffix:**

&lt;n&gt; irrelevant

**Parameters:**

&lt;Mode&gt;

**SINGle**

Each measurement is performed once (regardless of the channel's sweep mode), considering each channels' sweep count, until all measurements in all active channels have been performed.

**CONTInuous**

The measurements in each active channel are performed one after the other, repeatedly (regardless of the channel's sweep mode), in the same order, until the Sequencer is stopped.

**CDEFined**

First, a single sequence is performed. Then, only those channels in continuous sweep mode (`INIT:CONT ON`) are repeated.

\*RST:       CONTInuous

**Example:**

```
SYST:SEQ ON
```

Activates the Sequencer.

```
INIT:SEQ:MODE SING
```

Sets single sequence mode so each active measurement will be performed once.

```
INIT:SEQ:IMM
```

Starts the sequential measurements.

**Manual operation:** See "[Sequencer Mode](#)" on page 121

**SYSTem:SEQuencer <State>**

This command turns the Sequencer on and off. The Sequencer must be active before any other Sequencer commands (`INIT:SEQ...`) are executed, otherwise an error will occur.

A detailed programming example is provided in [Chapter 12.4.3, "Programming Example: Performing a Sequence of Measurements"](#), on page 631.

**Parameters:**

&lt;State&gt;

ON | OFF | 0 | 1

**ON | 1**

The Sequencer is activated and a sequential measurement is started immediately.

**OFF | 0**

The Sequencer is deactivated. Any running sequential measurements are stopped. Further Sequencer commands (`INIT:SEQ...`) are not available.

\*RST:       0

**Example:**

```

SYST:SEQ ON
Activates the Sequencer.
INIT:SEQ:MODE SING
Sets single Sequencer mode so each active measurement will
be performed once.
INIT:SEQ:IMM
Starts the sequential measurements.
SYST:SEQ OFF

```

**Manual operation:** See "[Sequencer State](#)" on page 121

### 12.4.3 Programming Example: Performing a Sequence of Measurements

This example demonstrates how to perform several measurements in a sequence in a remote environment.

```

//2xSpectrumAnalyzer + 2xIQ, start Sequencer at the end, test OPC?
// -----

//-----Preparing the instrument and first channel -----
*RST
//Activate new IQ channel
INSTrument:CREate:NEW IQ,'IQ 1'
//Set sweep count for new IQ channel
SENS:SWEEP:COUNT 6
//Change trace modes for IQ channel
DISP:TRAC1:MODE BLANK
DISP:TRAC2:MODE MAXH
DISP:TRAC3:MODE MINH
//Switch to single sweep mode
INIT:CONT OFF
//switch back to first (default) analyzer channel
INST:SEL 'Spectrum';*WAI
//Switch into SEM
SENSe:SWEEp:MODE ESpectrum
//Load Sem standard file for W-CDMA
SENSe:ESpectrum:PRESet:STANdard 'WCDMA\3GPP\DL\3GPP_DL.xml'
//Set sweep count in Spectrum channel
SENS:SWEEP:COUNT 5

//-----Creating a second measurement channel -----

//Create second IQ channel
INSTrument:CREate:NEW IQ,'IQ 2'
//Set sweep count
SENS:SWEEP:COUNT 2
//Change trace modes
DISP:TRAC1:MODE MAXH

```

## Selecting the Operating Mode and Application

```

DISP:TRAC2:MODE MINH
//Create new analyzer channel
INSTrument:CREate:NEW SANalyzer,'Spectrum 2'
//Activate ACLR measurement in channel 'Spectrum 2'
CALCulate:MARKer:FUNCTion:POWer:SElect ACPower
//Load W-CDMA Standard
CALCulate:MARKer:FUNCTion:POWer:PRESet FW3Gppcdma
//Change trace modes
DISP:TRAC2:MODE MAXH
DISP:TRAC1:MODE MINH

//-----Performing a sweep and retrieving results-----

//Change sweep count
SENS:SWEep:COUNT 7
//Single Sweep mode
INIT:CONT OFF
//Switch back to first IQ channel
INST:SEL 'IQ 1';*WAI
//Perform a measurement
INIT:IMM;*OPC?
//Retrieve results
CALC:MARK:Y?
//Activate Multiview
DISPlay:ATAB ON

//-----Performing a sequence of measurements with the Sequencer-----
//Activate Sequencer
SYSTem:SEQuencer ON
//Start sweep in Sequencer
INITiate:SEQuencer:IMMediate;*OPC?
//Switch into first IQ channel to get results
INST:SEL 'IQ 1';*WAI
CALCulate:MARKer:MAXimum
CALC:MARK:Y?
//Change sweep time in IQ
SENS:SWE:TIME 300us
//Switch to single Sequencer mode
INITiate:SEQuencer:MODE SINGLE
//Sweep all channels once, taking the sweep count in each channel into account
INITiate:SEQuencer:IMMediate;*OPC?
//Set marker to maximum in IQ1 and query result
CALCulate:MARKer:MAXimum
CALC:MARK:Y?
//Switch to second IQ channel and retrieve results
INST:SEL 'IQ 2';*WAI
CALCulate:MARKer:MIN
CALC:MARK:Y?
//Switch to first Spectrum channel
INST:SEL 'Spectrum';*WAI

```



```
//Query one of the SEM results
CALCulate:MARKer:FUNCTion:POWer:RESult? CPOWer
//Switch to second Spectrum channel
INST:SEL 'Spectrum 2';*WAI
//Query channel power result
CALCulate:MARKer:FUNCTion:POWer:RESult? ACPower
```

## 12.5 Configuring and Performing Measurements

The following commands are required to configure measurements in a remote environment. The tasks for manual operation are described in [Chapter 6, "Measurements and Results"](#), on page 123.

|                                                                   |     |
|-------------------------------------------------------------------|-----|
| • <a href="#">Performing Measurements</a> .....                   | 633 |
| • <a href="#">Configuring Power Measurements</a> .....            | 636 |
| • <a href="#">Measuring the Channel Power and ACLR</a> .....      | 641 |
| • <a href="#">Measuring the Carrier-to-Noise Ratio</a> .....      | 677 |
| • <a href="#">Measuring the Occupied Bandwidth</a> .....          | 678 |
| • <a href="#">Measuring the Spectrum Emission Mask</a> .....      | 680 |
| • <a href="#">Measuring Spurious Emissions</a> .....              | 715 |
| • <a href="#">Analyzing Statistics (APD, CCDF)</a> .....          | 728 |
| • <a href="#">Measuring the Time Domain Power</a> .....           | 738 |
| • <a href="#">Measuring the Harmonic Distortion</a> .....         | 748 |
| • <a href="#">Measuring the Third Order Intercept Point</a> ..... | 752 |
| • <a href="#">Measuring the AM Modulation Depth</a> .....         | 754 |
| • <a href="#">List Evaluations</a> .....                          | 756 |
| • <a href="#">Measuring the Pulse Power</a> .....                 | 761 |

### 12.5.1 Performing Measurements

#### Useful commands for performing measurements described elsewhere

- [INITiate<n>:ESpectrum](#) on page 682
- [INITiate<n>:SPURious](#) on page 716

#### Remote commands exclusive for performing measurements:

|                                                     |     |
|-----------------------------------------------------|-----|
| <a href="#">ABORt</a> .....                         | 633 |
| <a href="#">INITiate&lt;n&gt;:CONMeas</a> .....     | 634 |
| <a href="#">INITiate&lt;n&gt;:CONTInuous</a> .....  | 635 |
| <a href="#">INITiate&lt;n&gt;:[IMMediate]</a> ..... | 636 |
| <a href="#">[SENSe:]SWEp:COUNT:CURRent?</a> .....   | 636 |

---

#### ABORt

This command aborts the measurement in the current channel and resets the trigger system.

To prevent overlapping execution of the subsequent command before the measurement has been aborted successfully, use the `*OPC?` or `*WAI` command after `ABOR` and before the next command.

For details see [Chapter 11.1.4.1, "Preventing Overlapping Execution"](#), on page 585.

**Note on blocked remote control programs:**

If a sequential command cannot be completed, for example because a triggered sweep never receives a trigger, the remote control program will never finish and the remote channel to the R&S FPS is blocked for further commands. In this case, you must interrupt processing on the remote channel first in order to abort the measurement.

To do so, send a "Device Clear" command from the control instrument to the R&S FPS on a parallel channel to clear all currently active remote channels. Depending on the used interface and protocol, send the following commands:

- **Visa:** `viClear()`

Now you can send the `ABORT` command on the remote channel performing the measurement.

**Example:** `ABOR; :INIT:IMM`  
Aborts the current measurement and immediately starts a new one.

**Example:** `ABOR; *WAI`  
`INIT:IMM`  
Aborts the current measurement and starts a new one once abortion has been completed.

**Usage:** Event

### **INITiate<n>:CONMeas**

This command restarts a (single) measurement that has been stopped (using `ABORT`) or finished in single sweep mode.

The measurement is restarted at the beginning, not where the previous measurement was stopped.

As opposed to `INITiate<n>[:IMMEDIATE]`, this command does not reset traces in maxhold, minhold or average mode. Therefore it can be used to continue measurements using maxhold or averaging functions.

**Suffix:**  
<n> irrelevant

**Example:**

```
INIT:CONT OFF
Switches to single sweep mode.
DISP:WIND:TRAC:MODE AVER
Switches on trace averaging.
SWE:COUN 20
Setting the sweep counter to 20 sweep s.
INIT;*WAI
Starts the measurement and waits for the end of the 20 sweep s.
INIT:CONM;*WAI
Continues the measurement (next 20 sweep s) and waits for the end.
Result: Averaging is performed over 40 sweep s.
```

**Usage:** Event

**Manual operation:** See "[Continue Single Sweep](#)" on page 372

### INITiate<n>:CONTInuous <State>

This command controls the sweep mode for an individual channel.

Note that in single sweep mode, you can synchronize to the end of the measurement with \*OPC, \*OPC? or \*WAI. In continuous sweep mode, synchronization to the end of the measurement is not possible. Thus, it is not recommended that you use continuous sweep mode in remote control, as results like trace data or markers are only valid after a single sweep end synchronization.

For details on synchronization see [Chapter 11.1.4, "Command Sequence and Synchronization"](#), on page 584.

#### Suffix:

<n> irrelevant

#### Parameters:

<State> ON | OFF | 0 | 1  
**ON | 1**  
 Continuous sweep  
**OFF | 0**  
 Single sweep  
 \*RST: 0

**Example:**

```
INIT:CONT OFF
Switches the sweep mode to single sweep .
INIT:CONT ON
Switches the sweep mode to continuous sweep .
```

**Manual operation:** See "[Frequency Sweep](#)" on page 124  
 See "[Zero Span](#)" on page 125  
 See "[Continuous Sweep / Run Cont](#)" on page 371

**INITiate<n>[:IMMediate]**

This command starts a (single) new measurement.

With sweep count or average count > 0, this means a restart of the corresponding number of measurements. With trace mode MAXHold, MINHold and AVERage, the previous results are reset on restarting the measurement.

You can synchronize to the end of the measurement with \*OPC, \*OPC? or \*WAI.

For details on synchronization see [Chapter 11.1.4, "Command Sequence and Synchronization"](#), on page 584.

**Suffix:**

<n> irrelevant

**Example:**

```
INIT:CONT OFF
```

Switches to single sweep mode.

```
DISP:WIND:TRAC:MODE AVER
```

Switches on trace averaging.

```
SWE:COUN 20
```

Sets the sweep counter to 20 sweep s.

```
INIT;*WAI
```

Starts the measurement and waits for the end of the 20 sweep s.

**Usage:** Event

**Manual operation:** See "[Frequency Sweep](#)" on page 124  
 See "[Zero Span](#)" on page 125  
 See "[Single Sweep / Run Single](#)" on page 371

**[SENSe:]SWEep:COUNT:CURRent?**

This query returns the current number of started sweeps or measurements. This command is only available if a sweep count value is defined and the instrument is in single sweep mode.

**Example:**

```
SWE:COUNt 64
```

Sets sweep count to 64

```
INIT:CONT OFF
```

Switches to single sweep mode

```
INIT
```

Starts a sweep (without waiting for the sweep end!)

```
SWE:COUN:CURR?
```

Queries the number of started sweeps

**Usage:** Query only

## 12.5.2 Configuring Power Measurements

The following commands work for several power measurements.

|                                                        |     |
|--------------------------------------------------------|-----|
| CALCulate<n>:MARKer<m>:FUNction:POWer:MODE.....        | 637 |
| CALCulate<n>:MARKer<m>:FUNction:POWer<sb>:RESult?..... | 637 |
| CALCulate<n>:MARKer<m>:FUNction:POWer:SElect.....      | 639 |
| CALCulate<n>:MARKer<m>:FUNction:POWer[:STATe].....     | 639 |
| [SENSe:]POWer:ACHannel:PRESet.....                     | 640 |
| [SENSe:]POWer:ACHannel:PRESet:RLEVel.....              | 640 |
| [SENSe:]POWer:TRACe.....                               | 641 |

---

### CALCulate<n>:MARKer<m>:FUNction:POWer:MODE <Mode>

This command selects the trace display mode for power measurements.

#### Suffix:

|     |        |
|-----|--------|
| <n> | Window |
| <m> | Marker |

#### Parameters:

|        |                                                                                                                                        |
|--------|----------------------------------------------------------------------------------------------------------------------------------------|
| <Mode> | <b>WRITE</b><br>The power is calculated from the current trace.                                                                        |
|        | <b>MAXHold</b><br>The power is calculated from the current trace and compared with the previous power value using a maximum algorithm. |

**Manual operation:** See " [Power Mode](#) " on page 164

---

### CALCulate<n>:MARKer<m>:FUNction:POWer<sb>:RESult? <Measurement>

This command queries the results of power measurements.

To get a valid result, you have to perform a complete measurement with synchronization to the end of the measurement before reading out the result. This is only possible for single sweep mode.

See also [INITiate<n>:CONTinuous](#) on page 635.

#### Suffix:

|          |                                                                                  |
|----------|----------------------------------------------------------------------------------|
| <n>, <m> | irrelevant                                                                       |
| <sb>     | 1   2   3 (4   5)<br>Multi-SEM: 1 to 3<br>for all other measurements: irrelevant |

**Query parameters:**

&lt;Measurement&gt;

**ACPower | MCACpower**

ACLR measurements (also known as adjacent channel power or multicarrier adjacent channel measurements).

Returns the power for every active transmission and adjacent channel. The order is:

- power of the transmission channels
- power of adjacent channel (lower, upper)
- power of alternate channels (lower, upper)

**MSR ACLR results:**

For MSR ACLR measurements, the order of the returned results is slightly different:

- power of the transmission channels
- total power of the transmission channels for each sub block
- power of adjacent channels (lower, upper)
- power of alternate channels (lower, upper)
- power of gap channels (lower1, upper1, lower2, upper2)

The unit of the return values depends on the scaling of the y-axis:

- logarithmic scaling returns the power in the current unit
- linear scaling returns the power in W

**CN**

Carrier-to-noise measurements.

Returns the C/N ratio in dB.

**CNO**

Carrier-to-noise measurements.

Returns the C/N ratio referenced to a 1 Hz bandwidth in dBm/Hz.

**CPOWer**

Channel power measurements.

Returns the channel power. The unit of the return values depends on the scaling of the y-axis:

- logarithmic scaling returns the power in the current unit
- linear scaling returns the power in W

For SEM measurements, the return value is the channel power of the reference range (in the specified sub block).

**PPOWer**

Peak power measurements.

Returns the peak power. The unit of the return values depends on the scaling of the y-axis:

- logarithmic scaling returns the power in the current unit
- linear scaling returns the power in W

For SEM measurements, the return value is the peak power of the reference range (in the specified sub block).

Note that this result is only available if the power reference type is set to peak power (see [\[SENSe:\]ESpectrum<sb>:RTYPE](#) on page 699).

**OBANdwidth | OBWidth**

Occupied bandwidth.

Returns the occupied bandwidth in Hz.

#### **COBandwidth | COBWidth**

<Centroid frequency>,<Frequency offset>

See [Chapter 6.4.2, "OBW Results"](#), on page 200

**Usage:** Query only

**Manual operation:** See " [C/N](#) " on page 197  
See " [C/N0](#) " on page 197

#### **CALCulate<n>:MARKer<m>:FUNCTION:POWer:SElect <MeasType>**

This command selects a power measurement and turns the measurement on.

##### **Suffix:**

<n> [Window](#)

<m> [Marker](#)

##### **Parameters:**

<MeasType>

#### **ACPower | MCACpower**

Adjacent channel leakage ratio (ACLR), also known as adjacent channel power or multicarrier adjacent channel.

The R&S FPS performs the measurement on the trace selected with [\[SENSe:\]POWer:TRACe](#).

#### **CPOWer**

Channel power measurement with a single carrier.

The R&S FPS performs the measurement on the trace selected with [\[SENSe:\]POWer:TRACe](#).

#### **OBANdwidth | OBWidth**

Occupied bandwidth measurement.

The R&S FPS performs the measurement on the trace that marker 1 is positioned on.

#### **CN**

Carrier-to-noise ratio measurement.

#### **CN0**

Carrier-to-noise ratio measurement referenced to 1 Hz bandwidth

**Manual operation:** See " [C/N](#) " on page 197  
See " [C/N0](#) " on page 197

#### **CALCulate<n>:MARKer<m>:FUNCTION:POWer[:STATe] <State>**

This command turns a power measurement on and off.

##### **Suffix:**

<n>, <m> irrelevant

**Parameters:**

<State> ON | OFF | 1 | 0  
**ON | 1**  
 The power measurement selected with `CALCulate<n>`:  
`MARKer<m>:FUNCTION:POWER:SElect` is activated.  
**OFF | 0**  
 A standard frequency sweep is activated.  
 \*RST: 0

**Usage:** Setting only

**Manual operation:** See "C/N" on page 197  
 See "C/N0" on page 197

**[SENSe:]POWER:ACHannel:PRESet <Measurement>**

This command determines the ideal span, bandwidths and detector for the current power measurement.

To get a valid result, you have to perform a complete measurement with synchronization to the end of the measurement before reading out the result. This is only possible for single sweep mode.

See also `INITiate<n>:CONTinuous` on page 635.

**Parameters:**

<Measurement> **ACPower | MCACpower**  
 ACLR measurement  
**CPOWER**  
 channel power measurement  
**OBANdwidth | OBWidth**  
 Occupied bandwidth measurement  
**CN**  
 Carrier to noise ratio  
**CNO**  
 Carrier to noise ration referenced to a 1 Hz bandwidth

**Manual operation:** See "Optimized Settings ( Adjust Settings )" on page 165  
 See " Adjust Settings " on page 197  
 See " Adjust Settings " on page 202

**[SENSe:]POWER:ACHannel:PRESet:RLEVel**

This command determines the ideal reference level for the current measurement.

This automatic routine makes sure that the that the signal power level does not overload the R&S FPS or limit the dynamic range by too small a S/N ratio.

To determine the best reference level, the R&S FPS aborts current measurements and performs a series of test sweeps. After it has finished the test, it continues with the actual measurement.



To get a valid result, you have to perform a complete sweep with synchronization to the sweep end. This is only possible in single sweep mode.

**Usage:** Event

---

**[SENSe:]POWer:TRACe** <TraceNumber>

This command selects the trace channel power measurements are performed on.

For the measurement to work, the corresponding trace has to be active.

**Parameters:**

<TraceNumber> Range: 1 to 6  
\*RST: 1

**Example:** POW:TRAC 2  
Assigns the measurement to trace 2.

**Manual operation:** See " [Selected Trace](#) " on page 164

### 12.5.3 Measuring the Channel Power and ACLR

All remote control commands specific to channel power or ACLR measurements are described here.



See also [Chapter 12.5.2, "Configuring Power Measurements"](#), on page 636.

- [Managing Measurement Configurations](#)..... 641
- [Configuring the Channels](#)..... 643
- [Defining Weighting Filters](#)..... 647
- [Selecting the Reference Channel](#)..... 649
- [Checking Limits](#)..... 650
- [General ACLR Measurement Settings](#)..... 656
- [Configuring MSR ACLR Measurements](#)..... 657
- [Performing an ACLR Measurement](#)..... 671
- [Analyzing Measurement Results](#)..... 671
- [Programming Examples for Channel Power Measurements](#)..... 673

#### 12.5.3.1 Managing Measurement Configurations

The following commands control measurement configurations for ACLR measurements.

- CALCulate<n>:MARKer<m>:FUNction:POWer:PRESet..... 642
- CALCulate<n>:MARKer<m>:FUNction:POWer:STANdard:CATalog?..... 642
- CALCulate<n>:MARKer<m>:FUNction:POWer:STANdard:DELeTe..... 642
- CALCulate<n>:MARKer<m>:FUNction:POWer:STANdard:SAVE..... 643

**CALCulate<n>:MARKer<m>:FUNCTION:POWer:PRESet <Standard>**

This command loads a measurement configuration.

The measurement configuration for power measurements consists of weighting filter, channel bandwidth and spacing, resolution and video bandwidth, detector and sweep time.

If the "Multi-Standard Radio" standard is selected (see " [Standard](#) " on page 161), different commands are required to configure ACLR measurements (see [Chapter 12.5.3.7, "Configuring MSR ACLR Measurements"](#), on page 657).

**Suffix:**

<n> [Window](#)

<m> [Marker](#)

**Parameters:**

<Standard> For more information see [Chapter 6.2.9, "Reference: Predefined CP/ACLR Standards"](#), on page 192.

If you want to load a customized configuration, the parameter is a string containing the file name.

**Manual operation:** See " [Predefined Standards](#) " on page 161  
See " [User Standards](#) " on page 161

**CALCulate<n>:MARKer<m>:FUNCTION:POWer:STANdard:CATalog?**

This command queries all files containing ACLR standards.

**Suffix:**

<n> [Window](#)

<m> [Marker](#)

**Return values:**

<Standards> List of standard files.

**Usage:** Query only

**Manual operation:** See " [User Standards](#) " on page 161

**CALCulate<n>:MARKer<m>:FUNCTION:POWer:STANdard:DELeTe <Standard>**

This command deletes a file containing an ACLR standard.

**Suffix:**

<n> [Window](#)

<m> [Marker](#)

**Parameters:**

<Standard> String containing the file name of the standard.

**Usage:** Event

**Manual operation:** See " [User Standards](#) " on page 161

**CALCulate<n>:MARKer<m>:FUNCTION:POWer:STANdard:SAVE <Standard>**

This command saves the current ACLR measurement configuration as a new ACLR standard.

The measurement configuration for power measurements consists of weighting filter, channel bandwidth and spacing, resolution and video bandwidth, detector and sweep time.

**Suffix:**

<n> [Window](#)

<m> [Marker](#)

**Parameters:**

<Standard> String containing the file name. The file format is xml.

**Manual operation:** See " [User Standards](#) " on page 161

**12.5.3.2 Configuring the Channels**

The following commands configure channels for channel power and ACLR measurements.

|                                                     |     |
|-----------------------------------------------------|-----|
| [SENSe:]POWer:ACHannel:ACPairs.....                 | 643 |
| [SENSe:]POWer:ACHannel:BWIDth:ACHannel.....         | 644 |
| [SENSe:]POWer:ACHannel:BANDwidth:ACHannel.....      | 644 |
| [SENSe:]POWer:ACHannel:BWIDth:ALTerNate<ch>.....    | 644 |
| [SENSe:]POWer:ACHannel:BANDwidth:ALTerNate<ch>..... | 644 |
| [SENSe:]POWer:ACHannel:BWIDth[:CHANnel<ch>].....    | 644 |
| [SENSe:]POWer:ACHannel:BANDwidth[:CHANnel<ch>]..... | 644 |
| [SENSe:]POWer:ACHannel:NAME:ACHannel.....           | 645 |
| [SENSe:]POWer:ACHannel:NAME:ALTerNate<ch>.....      | 645 |
| [SENSe:]POWer:ACHannel:NAME:CHANnel<ch>.....        | 645 |
| [SENSe:]POWer:ACHannel:SPACing[:ACHannel].....      | 646 |
| [SENSe:]POWer:ACHannel:SPACing:ALTerNate<ch>.....   | 646 |
| [SENSe:]POWer:ACHannel:SPACing:CHANnel<ch>.....     | 647 |
| [SENSe:]POWer:ACHannel:TXCHannel:COUNT.....         | 647 |

**[SENSe:]POWer:ACHannel:ACPairs <ChannelPairs>**

This command defines the number of pairs of adjacent and alternate channels.

**Parameters:**

<ChannelPairs> Range: 0 to 12  
\*RST: 1

**Manual operation:** See " [Number of channels: Tx , Adj](#) " on page 162  
See " [Number of Adjacent Channels \( Adj Count \)](#) " on page 178

---

**[SENSe:]POWer:ACHannel:BWIDth:ACHannel** <Bandwidth>

**[SENSe:]POWer:ACHannel:BANDwidth:ACHannel** <Bandwidth>

This command defines the channel bandwidth of the adjacent channels.

The adjacent channels are the first channels to the left and right of the transmission channels. If you set the channel bandwidth for these channels, the R&S FPS sets the bandwidth of the alternate channels to the same value (not for MSR signals).

For asymmetrical MSR signals, this command defines the bandwidth of the lower adjacent channel. To configure the bandwidth for the upper adjacent channel, use the [\[SENSe:\]POWer:ACHannel:BANDwidth:UACHannel](#) command.

Steep-edged channel filters are available for fast ACLR measurements.

**Parameters:**

|             |        |                    |
|-------------|--------|--------------------|
| <Bandwidth> | Range: | 100 Hz to 1000 MHz |
|             | *RST:  | 14 kHz             |

**Manual operation:** See "[Channel Bandwidth](#)" on page 166  
See "[Adjacent Channel Bandwidths](#)" on page 179

---

**[SENSe:]POWer:ACHannel:BWIDth:ALternate<ch>** <Bandwidth>

**[SENSe:]POWer:ACHannel:BANDwidth:ALternate<ch>** <Bandwidth>

This command defines the channel bandwidth of the alternate channels.

For MSR signals, this command defines the bandwidth of the lower alternate channels in asymmetrical configurations. To configure the bandwidth for the upper alternate channel, use the [\[SENSe:\]POWer:ACHannel:BANDwidth:UALternate<ch>](#) command.

If you set the channel bandwidth for the first alternate channel, the R&S FPS sets the bandwidth of the other alternate channels to the same value, but not the other way round (not for MSR signals). The command works hierarchically: to set a bandwidth of the 3rd and 4th channel, you have to set the bandwidth of the 3rd channel first.

Steep-edged channel filters are available for fast ACLR measurements.

**Suffix:**

|      |                          |
|------|--------------------------|
| <ch> | 1 to 11                  |
|      | Alternate channel number |

**Parameters:**

|             |        |                    |
|-------------|--------|--------------------|
| <Bandwidth> | Range: | 100 Hz to 1000 MHz |
|             | *RST:  | 14 kHz             |

**Manual operation:** See "[Channel Bandwidth](#)" on page 166  
See "[Adjacent Channel Bandwidths](#)" on page 179

---

**[SENSe:]POWer:ACHannel:BWIDth[:CHANnel<ch>]** <Bandwidth>

**[SENSe:]POWer:ACHannel:BANDwidth[:CHANnel<ch>]** <Bandwidth>

This command defines the channel bandwidth of the transmission channels.

Steep-edged channel filters are available for fast ACLR measurements.

**Suffix:**

<ch> 1 to 18  
Tx channel number

**Parameters:**

<Bandwidth> Range: 100 Hz to 1000 MHz  
\*RST: 14 kHz

**Manual operation:** See " [Channel Bandwidth](#) " on page 166  
See " [Channel Bandwidth](#) " on page 197  
See " [Channel Bandwidth](#) " on page 202

**[SENSe:]POWer:ACHannel:NAME:ACHannel <Name>**

This command defines a name for the adjacent channel.

For MSR ACLR measurements, this command defines the name for the lower adjacent channel in asymmetric channel definitions. To define the name for the upper adjacent channel use the [\[SENSe:\]POWer:ACHannel:NAME:UACHannel](#) command.

**Parameters:**

<Name> String containing the name of the channel  
\*RST: ADJ

**Manual operation:** See " [Channel Names](#) " on page 168

**[SENSe:]POWer:ACHannel:NAME:ALternate<ch> <Name>**

This command defines a name for an alternate channel.

For MSR ACLR measurements, this command defines the name for the lower alternate channel in asymmetric channel definitions. To define the name for the upper alternate channels use the [\[SENSe:\]POWer:ACHannel:NAME:UALternate<ch>](#) command.

**Suffix:**

<ch> 1 to 11  
Alternate channel number

**Parameters:**

<Name> String containing the name of the channel  
\*RST: ALT<1...11>

**Manual operation:** See " [Channel Names](#) " on page 168

**[SENSe:]POWer:ACHannel:NAME:CHANnel<ch> <Name>**

This command defines a name for a transmission channel.

**Suffix:**

<ch> 1 to 18  
Tx channel number

**Parameters:**

<Name> String containing the name of the channel  
 \*RST: TX<1...12>

**Manual operation:** See " [Channel Names](#) " on page 168

**[SENSe:]POWer:ACHannel:SPACing[:ACHannel] <Spacing>**

This command defines the distance from transmission channel to adjacent channel.

For MSR signals, this command defines the distance from the CF of the first Tx channel in the first sub block to the lower adjacent channel. To configure the spacing for the upper adjacent channel in asymmetrical configurations, use the [\[SENSe:\]POWer:ACHannel:SPACing:UACHannel](#) command.

A change of the adjacent channel spacing causes a change in the spacing of all alternate channels below the adjacent channel (not for MSR signals).

**Parameters:**

<Spacing> Range: 100 Hz to 2000 MHz  
 \*RST: 14 kHz

**Manual operation:** See " [Channel Spacings](#) " on page 167  
 See " [Adjacent Channel Spacings](#) " on page 179

**[SENSe:]POWer:ACHannel:SPACing:ALTErnate<ch> <Spacing>**

This command defines the distance from transmission channel to alternate channels.

For MSR signals, this command defines the distance from the CF of the first Tx channel in the first sub block to the lower alternate channel. To configure the spacing for the upper alternate channel in asymmetrical configurations, use the [\[SENSe:\]POWer:ACHannel:SPACing:UALTErnate<ch>](#) command.

If you set the channel spacing for the first alternate channel, the R&S FPS adjusts the spacing of alternate channels of a lower order, but not the other way round (not for MSR signals). The command works hierarchically: to set a distance from the transmission channel to the 2nd and 3rd alternate channel, you have to define a spacing for the 2nd alternate channel first.

**Suffix:**

<ch> 1 to 11  
 Alternate channel number

**Parameters:**

<Spacing> Range: 100 Hz to 2000 MHz  
 \*RST: 40 kHz (ALT1), 60 kHz (ALT2), 80 kHz (ALT3), ...

**Manual operation:** See " [Channel Spacings](#) " on page 167  
 See " [Adjacent Channel Spacings](#) " on page 179

---

**[SENSe:]POWer:ACHannel:SPACing:CHANnel<ch>** <Spacing>

This command defines the distance between transmission channels.

If you set the channel spacing for a transmission channel, the R&S FPS sets the spacing of the lower transmission channels to the same value, but not the other way round. The command works hierarchically: to set a distance between the 2nd and 3rd and 3rd and 4th channel, you have to set the spacing between the 2nd and 3rd channel first.

**Suffix:**

<ch>                      1 to 18  
Tx channel number

**Parameters:**

<Spacing>                Range:     14 kHz to 2000 MHz  
\*RST:        20 kHz

**Manual operation:**   See " [Channel Spacings](#) " on page 167

---

**[SENSe:]POWer:ACHannel:TXCHannel:COUNT** <Number>

This command defines the number of transmission channels.

The command works for measurements in the frequency domain.

**Parameters:**

<Number>                Range:     1 to 18  
\*RST:        1

**Manual operation:**   See " [Number of channels: Tx , Adj](#) " on page 162

### 12.5.3.3 Defining Weighting Filters

The following commands define weighting filters for ACLR measurements.

|                                                                                   |     |
|-----------------------------------------------------------------------------------|-----|
| <a href="#">[SENSe:]POWer:ACHannel:FILTer:ALPHa:ACHannel</a> .....                | 647 |
| <a href="#">[SENSe:]POWer:ACHannel:FILTer:ALPHa[:ALL]</a> .....                   | 648 |
| <a href="#">[SENSe:]POWer:ACHannel:FILTer:ALPHa:ALTerminate&lt;ch&gt;</a> .....   | 648 |
| <a href="#">[SENSe:]POWer:ACHannel:FILTer:ALPHa:CHANnel&lt;ch&gt;</a> .....       | 648 |
| <a href="#">[SENSe:]POWer:ACHannel:FILTer[:STATe]:ACHannel</a> .....              | 648 |
| <a href="#">[SENSe:]POWer:ACHannel:FILTer[:STATe][:ALL]</a> .....                 | 649 |
| <a href="#">[SENSe:]POWer:ACHannel:FILTer[:STATe]:ALTerminate&lt;ch&gt;</a> ..... | 649 |
| <a href="#">[SENSe:]POWer:ACHannel:FILTer[:STATe]:CHANnel&lt;ch&gt;</a> .....     | 649 |

---

**[SENSe:]POWer:ACHannel:FILTer:ALPHa:ACHannel** <Alpha>

This command defines the roll-off factor for the adjacent channel weighting filter.

**Parameters:**

<Alpha>                      Roll-off factor  
Range:     0 to 1  
\*RST:        0.22

**Manual operation:** See " [Weighting Filters](#) " on page 168  
See " [Weighting Filters](#) " on page 179

**[SENSe:]POWer:ACHannel:FILTer:ALPHA[:ALL] <Value>**

This command defines the alpha value for the weighting filter for all channels.

**Parameters:**

<Value>                    <numeric value>  
\*RST:                    0.22

**Example:**                    POW:ACH:FILT:ALPH:ALL 0.35

**[SENSe:]POWer:ACHannel:FILTer:ALPHA:ALTErnate<ch> <Alpha>**

This command defines the roll-off factor for the alternate channel weighting filter.

**Suffix:**

<ch>                        1 to 11  
Alternate channel number

**Parameters:**

<Alpha>                    Roll-off factor  
Range:                    0 to 1  
\*RST:                    0.22

**Manual operation:** See " [Weighting Filters](#) " on page 168  
See " [Weighting Filters](#) " on page 179

**[SENSe:]POWer:ACHannel:FILTer:ALPHA:CHANnel<ch> <Alpha>**

This command defines the roll-off factor for the transmission channel weighting filter.

**Suffix:**

<ch>                        1 to 18  
Tx channel number

**Parameters:**

<Alpha>                    Roll-off factor  
Range:                    0 to 1  
\*RST:                    0.22

**Manual operation:** See " [Weighting Filters](#) " on page 168

**[SENSe:]POWer:ACHannel:FILTer[:STATE]:ACHannel <State>**

This command turns the weighting filter for the adjacent channel on and off.

**Parameters:**

<State>                    ON | OFF | 1 | 0  
\*RST:                    0



**Manual operation:** See " [Weighting Filters](#) " on page 168  
See " [Weighting Filters](#) " on page 179

---

**[SENSe:]POWer:ACHannel:FILTer[:STATe][:ALL] <State>**

This command turns the weighting filters for all channels on and off.

**Parameters:**

<State>            ON | OFF | 1 | 0  
\*RST:            0

---

**[SENSe:]POWer:ACHannel:FILTer[:STATe]:ALTErnate<ch> <State>**

This command turns the weighting filter for an alternate channel on and off.

**Suffix:**

<ch>                1 to 11  
Alternate channel number

**Parameters:**

<State>            ON | OFF | 1 | 0  
\*RST:            0

**Manual operation:** See " [Weighting Filters](#) " on page 168  
See " [Weighting Filters](#) " on page 179

---

**[SENSe:]POWer:ACHannel:FILTer[:STATe]:CHANnel<ch> <State>**

This command turns the weighting filter for a transmission channel on and off.

**Suffix:**

<ch>                1 to 18  
Tx channel number

**Parameters:**

<State>            ON | OFF | 1 | 0  
\*RST:            0

**Manual operation:** See " [Weighting Filters](#) " on page 168

#### 12.5.3.4 Selecting the Reference Channel

The following commands define the reference channel for relative ACLR measurements.

[SENSe:]POWer:ACHannel:REFerence:AUTO ONCE..... 650  
[SENSe:]POWer:ACHannel:REFerence:TXChannel:AUTO..... 650  
[SENSe:]POWer:ACHannel:REFerence:TXChannel:MANual..... 650

**[SENSe:]POWer:ACHannel:REFerence:AUTO ONCE**

This command sets the channel power as the reference for relative ACLR measurements.

**Example:** POW:ACH:REF:AUTO ONCE

**Usage:** Event

**Manual operation:** See "[Setting a fixed reference for Channel Power measurements \( Set CP Reference \)](#)" on page 164

**[SENSe:]POWer:ACHannel:REFerence:TXCHannel:AUTO <RefChannel>**

This command selects the reference channel for relative measurements.

You need at least one channel for the command to work.

**Parameters:**

<RefChannel>

**MINimum**

Transmission channel with the lowest power

**MAXimum**

Transmission channel with the highest power

**LHIGhest**

Lowest transmission channel for lower adjacent channels and highest transmission channel for upper adjacent channels

**Example:**

POW:ACH:REF:TXCH:AUTO MAX

Selects the channel with the peak power as reference channel.

**Manual operation:** See "[Reference Channel](#)" on page 163

**[SENSe:]POWer:ACHannel:REFerence:TXCHannel:MANual <ChannelNumber>**

This command defines a reference channel for relative ACLR measurements.

You need at least one channel for the command to work.

Note that this command is not available for MSR ACLR measurements (see [CALCulate<n>:MARKer<m>:FUNctIon:POWer:PRESet](#) on page 642).

**Parameters:**

<ChannelNumber>

Range: 1 to 18

\*RST: 1

**Manual operation:** See "[Reference Channel](#)" on page 163

**12.5.3.5 Checking Limits**

The following commands configure and query limit checks for channel power and ACLR measurements.



The results of the power limit checks are also indicated in the `STAT:QUES:ACPL` status registry (see "[STATus:QUESTionable:ACPLimit Register](#)" on page 594).

|                                                                                                   |     |
|---------------------------------------------------------------------------------------------------|-----|
| <code>CALCulate&lt;n&gt;:LIMit&lt;k&gt;:ACPower:ACHannel:ABSolute</code> .....                    | 651 |
| <code>CALCulate&lt;n&gt;:LIMit&lt;k&gt;:ACPower:ACHannel:ABSolute:STATe</code> .....              | 651 |
| <code>CALCulate&lt;n&gt;:LIMit&lt;k&gt;:ACPower:ACHannel[:RELative]</code> .....                  | 652 |
| <code>CALCulate&lt;n&gt;:LIMit&lt;k&gt;:ACPower:ACHannel:RESult?</code> .....                     | 652 |
| <code>CALCulate&lt;n&gt;:LIMit&lt;k&gt;:ACPower:ACHannel[:RELative]:STATe</code> .....            | 653 |
| <code>CALCulate&lt;n&gt;:LIMit&lt;k&gt;:ACPower:ALternate&lt;ch&gt;:ABSolute</code> .....         | 653 |
| <code>CALCulate&lt;n&gt;:LIMit&lt;k&gt;:ACPower:ALternate&lt;ch&gt;:ABSolute:STATe</code> .....   | 654 |
| <code>CALCulate&lt;n&gt;:LIMit&lt;k&gt;:ACPower:ALternate&lt;ch&gt;[:RELative]</code> .....       | 654 |
| <code>CALCulate&lt;n&gt;:LIMit&lt;k&gt;:ACPower:ALternate&lt;ch&gt;:RESult?</code> .....          | 655 |
| <code>CALCulate&lt;n&gt;:LIMit&lt;k&gt;:ACPower:ALternate&lt;ch&gt;[:RELative]:STATe</code> ..... | 655 |
| <code>CALCulate&lt;n&gt;:LIMit&lt;k&gt;:ACPower[:STATe]</code> .....                              | 656 |

**`CALCulate<n>:LIMit<k>:ACPower:ACHannel:ABSolute` <LowerLimit>, <UpperLimit>**

This command defines the absolute limit of the adjacent channels.

If you have defined an absolute limit as well as a relative limit, the R&S FPS uses the lower value for the limit check.

**Suffix:**

<n>, <k>                      irrelevant

**Parameters:**

<LowerLimit>                      The limit of the lower adjacent channel.

Range:                      -200 dBm to 200 dBm

\*RST:                      -200 dBm

<UpperLimit>                      The limit of the upper adjacent channel.

Range:                      -200 dBm to 200 dBm

\*RST:                      -200 dBm

**Manual operation:**              See "[Limit Check](#)" on page 167

See "[Limit Checking](#)" on page 180

**`CALCulate<n>:LIMit<k>:ACPower:ACHannel:ABSolute:STATe` <State>,<State>**

This command turns the absolute limit check for the adjacent channels on and off.

You have to activate the general ACLR limit check before using this command with `CALCulate<n>:LIMit<k>:ACPower[:STATe]`.

**Suffix:**

<n>, <k>                      irrelevant

**Parameters:**

|         |                                                 |
|---------|-------------------------------------------------|
| <State> | ON   OFF   1   0                                |
|         | Absolute limit check for lower adjacent channel |
| *RST:   | 0                                               |
| <State> | ON   OFF   1   0                                |
|         | Absolute limit check for upper adjacent channel |
| *RST:   | 0                                               |

**Manual operation:** See " [Limit Check](#) " on page 167  
 See " [Limit Checking](#) " on page 180

**CALCulate<n>:LIMit<k>:ACPpower:ACHannel[:RELative]** <LowerLimit>, <UpperLimit>

This command defines the relative limit of the adjacent channels. The reference value for the relative limit is the measured channel power.

If you have defined an absolute limit as well as a relative limit, the R&S FPS uses the lower value for the limit check.

**Suffix:**

|     |            |
|-----|------------|
| <n> | irrelevant |
| <k> | irrelevant |

**Parameters:**

|               |                                          |
|---------------|------------------------------------------|
| <LowerLimit>  | The limit of the lower adjacent channel. |
| Range:        | 0 dB to 100 dB                           |
| *RST:         | 0 dB                                     |
| Default unit: | dB                                       |
| <UpperLimit>  | The limit of the upper adjacent channel. |
| Range:        | 0 dB to 100 dB                           |
| *RST:         | 0 dB                                     |
| Default unit: | dB                                       |

**Manual operation:** See " [Limit Check](#) " on page 167  
 See " [Limit Checking](#) " on page 180

**CALCulate<n>:LIMit<k>:ACPpower:ACHannel:RESult?**

This command queries the state of the limit check for the adjacent channels in an ACLR measurement.

To get a valid result, you have to perform a complete measurement with synchronization to the end of the measurement before reading out the result. This is only possible for single sweep mode.

See also [INITiate<n>:CONTinuous](#) on page 635.

**Suffix:**

|          |            |
|----------|------------|
| <n>, <k> | irrelevant |
|----------|------------|

**Return values:**

<LowerACH>, text value  
 <UpperACH> The command returns two results. The first is the result for the lower, the second for the upper adjacent channel.

**PASSED**

Limit check has passed.

**FAIL**

Limit check has failed.

**Example:**

```
INIT: IMM; *WAI;
CALC: LIM: ACP: ACH: RES?
PASSED, PASSED
```

**Usage:**

Query only

**Manual operation:**

See " [Limit Check](#) " on page 167  
 See " [Limit Checking](#) " on page 180

**CALCulate<n>:LIMit<k>:ACPpower:ACHannel[:RELative]:STATe** <State>, <State>

This command turns the relative limit check for the adjacent channels on and off.

You have to activate the general ACLR limit check before using this command with [CALCulate<n>:LIMit<k>:ACPpower\[:STATe\]](#).

**Suffix:**

<n>, <k> irrelevant

**Parameters:**

<State> ON | OFF | 1 | 0  
 Relative limit check for lower adjacent channel

\*RST: 0

<State> ON | OFF | 1 | 0  
 Relative limit check for upper adjacent channel

\*RST: 0

**Manual operation:**

See " [Limit Check](#) " on page 167  
 See " [Limit Checking](#) " on page 180

**CALCulate<n>:LIMit<k>:ACPpower:ALternate<ch>:ABSolute** <LowerLimit>, <UpperLimit>

This command defines the absolute limit of the alternate channels.

If you have defined an absolute limit as well as a relative limit, the R&S FPS uses the lower value for the limit check.

**Suffix:**

<n>, <k> irrelevant

<ch> 1 to 11  
 Alternate channel number

**Parameters:**

|              |                                                                                          |
|--------------|------------------------------------------------------------------------------------------|
| <LowerLimit> | The limit of the lower adjacent channel.<br>Range: -200 dBm to 200 dBm<br>*RST: -200 dBm |
| <UpperLimit> | The limit of the upper adjacent channel.<br>Range: -200 dBm to 200 dBm<br>*RST: -200 dBm |

**Manual operation:** See " [Limit Check](#) " on page 167  
See " [Limit Checking](#) " on page 180

**CALCulate<n>:LIMit<k>:ACPowEr:ALTErnate<ch>:ABSolute:STATe**  
<State>,<State>

This command turns the absolute limit check for the alternate channels on and off.

You have to activate the general ACLR limit check before using this command with [CALCulate<n>:LIMit<k>:ACPowEr\[:STATe\]](#).

**Suffix:**

|          |                                     |
|----------|-------------------------------------|
| <n>, <k> | irrelevant                          |
| <ch>     | 1 to 11<br>Alternate channel number |

**Parameters:**

|         |                                                                                 |
|---------|---------------------------------------------------------------------------------|
| <State> | ON   OFF   1   0<br>Absolute limit check for lower alternate channel<br>*RST: 0 |
| <State> | ON   OFF   1   0<br>Absolute limit check for upper alternate channel<br>*RST: 0 |

**Manual operation:** See " [Limit Check](#) " on page 167  
See " [Limit Checking](#) " on page 180

**CALCulate<n>:LIMit<k>:ACPowEr:ALTErnate<ch>[:RELative]** <LowerLimit>,  
<UpperLimit>

This command defines the relative limit of the alternate channels. The reference value for the relative limit is the measured channel power.

If you have defined an absolute limit as well as a relative limit, the R&S FPS uses the lower value for the limit check.

**Suffix:**

|          |                                     |
|----------|-------------------------------------|
| <n>, <k> | irrelevant                          |
| <ch>     | 1 to 11<br>Alternate channel number |

**Parameters:**

<LowerLimit> The limit of the lower alternate channel.

Range: 0 dB to 100 dB

\*RST: 0 dB

Default unit: dB

<UpperLimit> The limit of the upper alternate channel.

Range: 0 dB to 100 dB

\*RST: 0 dB

Default unit: dB

**Manual operation:** See " [Limit Check](#) " on page 167  
See " [Limit Checking](#) " on page 180

**CALCulate<n>:LIMit<k>:ACPpower:ALternate<ch>:RESult?**

This command queries the state of the limit check for the adjacent or alternate channels in an ACLR measurement.

To get a valid result, you have to perform a complete measurement with synchronization to the end of the measurement before reading out the result. This is only possible for single sweep mode.

See also [INITiate<n>:CONTinuous](#) on page 635.

**Suffix:**

<n>, <k> irrelevant

<ch> 1 to 11  
Alternate channel number

**Return values:**

<LowerChan>, text value

<UpperChan> The command returns two results. The first is the result for the lower, the second for the upper adjacent or alternate channel.

**PASSED**

Limit check has passed.

**FAIL**

Limit check has failed.

**Example:** INIT:IMM;\*WAI;  
CALC:LIM:ACP:ACH:RES?  
PASSED,PASSED

**Usage:** Query only

**CALCulate<n>:LIMit<k>:ACPpower:ALternate<ch>[:RELative]:STATe**  
<State>,<State>

This command turns the relative limit check for the alternate channels on and off.

You have to activate the general ACLR limit check before using this command with [CALCulate<n>:LIMit<k>:ACPpower\[:STATe\]](#).

**Suffix:**

|          |                                     |
|----------|-------------------------------------|
| <n>, <k> | irrelevant                          |
| <ch>     | 1 to 11<br>Alternate channel number |

**Parameters:**

|         |                                                                                 |
|---------|---------------------------------------------------------------------------------|
| <State> | ON   OFF   1   0<br>Relative limit check for lower alternate channel<br>*RST: 0 |
| <State> | ON   OFF   1   0<br>Relative limit check for upper alternate channel<br>*RST: 0 |

**Manual operation:** See " [Limit Check](#) " on page 167  
See " [Limit Checking](#) " on page 180

**CALCulate<n>:LIMit<k>:ACPower[:STATe] <State>**

This command turns the limit check for ACLR measurements on and off.

In addition, limits must be defined and activated individually for each channel (see [CALCulate<n>:LIMit<k>:ACPower:ACHannel\[:RELative\]:STATe](#), [CALCulate<n>:LIMit<k>:ACPower:ALternate<ch>\[:RELative\]:STATe](#), [CALCulate<n>:LIMit<k>:ACPower:GAP<gap>:ABSolute:STATe](#), [CALCulate<n>:LIMit<k>:ACPower:GAP<gap>:ACLR\[:RELative\]:STATe](#) and [CALCulate<n>:LIMit<k>:ACPower:GAP<gap>\[:CACLR\]\[:RELative\]:STATe](#)).

**Suffix:**

|          |            |
|----------|------------|
| <n>, <k> | irrelevant |
|----------|------------|

**Parameters:**

|         |                             |
|---------|-----------------------------|
| <State> | ON   OFF   1   0<br>*RST: 0 |
|---------|-----------------------------|

**Manual operation:** See " [Limit Check](#) " on page 167  
See " [Limit Checking](#) " on page 174  
See " [Limit Checking](#) " on page 180  
See " [Limit Checking](#) " on page 182

**12.5.3.6 General ACLR Measurement Settings**

The following commands control the measurement algorithm.

Useful commands for the ACLR measurement described elsewhere:

- [\[SENSe:\]POWER:NCORrection](#) on page 794
- [\[SENSe:\]POWER:ACHannel:PRESet](#) on page 640
- [\[SENSe:\]POWER:ACHannel:PRESet:RLEVel](#) on page 640
- [\[SENSe:\]POWER:TRACe](#) on page 641



- [CALCulate<n>:MARKer<m>:FUNction:POWer:MODE](#) on page 637

#### Remote commands exclusive to ACLR measurement

[\[SENSe:\]POWer:HSPeed](#)..... 657

#### **[SENSe:]POWer:HSPeed <State>**

This command turns high speed ACLR and channel power measurements on and off.

If on, the R&S FPS performs a measurement on each channel in the time domain. It returns to the frequency domain when the measurement is done.

In some telecommunications standards, high speed measurements use weighting filters with characteristic or steep-edged channel filters for band limitation.

#### Parameters:

<State>                    ON | OFF | 1 | 0  
                               \*RST:            0

**Example:**                POW:HSP ON

**Manual operation:**    See " [Fast ACLR](#) " on page 163

### 12.5.3.7 Configuring MSR ACLR Measurements

If the "Multi-Standard Radio" standard is selected (see [CALCulate<n>:MARKer<m>:FUNction:POWer:PRESet](#) on page 642), the channels for the ACLR measurement are configured differently. (For more information see [Chapter 6.2.3.4, "Measurement on Multi-Standard Radio \(MSR\) Signals"](#), on page 155.)

In this case, use the following commands.

- [General MSR ACLR Measurement Settings](#).....657
- [MSR Sub Block and Tx Channel Setup](#)..... 658
- [MSR Adjacent Channel Setup](#)..... 660
- [MSR Gap Channel Setup](#).....665
- [MSR Channel Names](#)..... 670

#### General MSR ACLR Measurement Settings

Useful commands for configuring general MSR ACLR settings described elsewhere:

- [CALCulate<n>:MARKer<m>:FUNction:POWer:PRESet](#) on page 642
- [CALCulate<n>:MARKer<m>:FUNction:POWer<sb>:RESult?](#) on page 637
- [CALCulate<n>:MARKer<m>:FUNction:POWer:RESult:PHZ](#) on page 672
- [CALCulate<n>:MARKer<m>:FUNction:POWer:MODE](#) on page 637
- [CALCulate<n>:LIMit<k>:ACPower\[:STATE\]](#) on page 656
- [\[SENSe:\]POWer:ACHannel:REference:TXChannel:AUTO](#) on page 650
- [\[SENSe:\]POWer:NCORrection](#) on page 794
- [\[SENSe:\]POWer:TRACe](#) on page 641
- [\[SENSe:\]POWer:ACHannel:MODE](#) on page 672

- [SENSe:]POWer:ACHannel:PRESet on page 640
- [SENSe:]POWer:ACHannel:SSEtup on page 663

### MSR Sub Block and Tx Channel Setup

The functions for manual operation are described in [Chapter 6.2.5.2, "MSR Sub Block and Tx Channel Definition"](#), on page 175.

Useful commands for configuring Tx channels described elsewhere:

- [SENSe:]POWer:ACHannel:SBLOCK<sb>:NAME[:CHANnel<ch>] on page 670

### Remote commands exclusive to configuring sub blocks and Tx channels

|                                                                   |     |
|-------------------------------------------------------------------|-----|
| [SENSe:]POWer:ACHannel:FILTer:ALPHA:SBLOCK<sb>:CHANnel<ch>.....   | 658 |
| [SENSe:]POWer:ACHannel:FILTer[:STATe]:SBLOCK<sb>:CHANnel<ch>..... | 658 |
| [SENSe:]POWer:ACHannel:SBCount.....                               | 659 |
| [SENSe:]POWer:ACHannel:SBLOCK<sb>:BWiDth[:CHANnel<ch>].....       | 659 |
| [SENSe:]POWer:ACHannel:SBLOCK<sb>:BANDwidth[:CHANnel<ch>].....    | 659 |
| [SENSe:]POWer:ACHannel:SBLOCK<sb>:CENTer[:CHANnel<ch>].....       | 659 |
| [SENSe:]POWer:ACHannel:SBLOCK<sb>:FREQuency:CENTer.....           | 660 |

---

#### [SENSe:]POWer:ACHannel:FILTer:ALPHA:SBLOCK<sb>:CHANnel<ch> <Alpha>

This command defines the roll-off factor for the specified transmission channel's weighting filter.

##### Suffix:

|      |                                       |
|------|---------------------------------------|
| <sb> | 1   2   3   4   5<br>sub block number |
| <ch> | 1 to 18<br>Tx channel number          |

##### Parameters:

|         |                 |
|---------|-----------------|
| <Alpha> | Roll-off factor |
|         | Range: 0 to 1   |
|         | *RST: 0.22      |

**Manual operation:** See "[Weighting Filters](#)" on page 177

---

#### [SENSe:]POWer:ACHannel:FILTer[:STATe]:SBLOCK<sb>:CHANnel<ch> <State>

This command turns the weighting filter for the specified transmission channel on and off.

##### Suffix:

|      |                                       |
|------|---------------------------------------|
| <sb> | 1   2   3   4   5<br>sub block number |
| <ch> | 1 to 18<br>Tx channel number          |

**Parameters:**

<State> ON | OFF | 1 | 0  
 \*RST: W-CDMA: 1, other technologies: 0

**Manual operation:** See " [Weighting Filters](#) " on page 177

**[SENSe:]POWer:ACHannel:SBCount <Number>**

This command defines the number of sub blocks, i.e. groups of transmission channels in an MSR signal.

For more information see [Chapter 6.2.3.4, "Measurement on Multi-Standard Radio \(MSR\) Signals"](#), on page 155.

**Parameters:**

<Number> Range: 1 to 5  
 \*RST: 1

**Manual operation:** See " [Number of Sub Blocks](#) " on page 172

**[SENSe:]POWer:ACHannel:SBLock<sb>:BWIDth[:CHANnel<ch>] <Bandwidth>**  
**[SENSe:]POWer:ACHannel:SBLock<sb>:BANDwidth[:CHANnel<ch>]**  
 <Bandwidth>

This command defines the bandwidth of the specified MSR Tx channel.

This command is for MSR signals only (see [CALCulate<n>:MARKer<m>:FUNction:POWer:PRESet](#) on page 642).

**Suffix:**

<sb> 1 | 2 | 3 | 4 | 5  
 sub block number  
 <ch> 1 to 18  
 Tx channel number

**Parameters:**

<Bandwidth> Bandwidth in Hz

**Manual operation:** See " [Tx Channel Bandwidth](#) " on page 177

**[SENSe:]POWer:ACHannel:SBLock<sb>:CENTer[:CHANnel<ch>] <Frequency>**

This command defines the (absolute) center frequency of the specified MSR Tx channel.

Note that the position of the first Tx channel in the first sub block and the last Tx channel in the last sub block also affect the position of the adjacent channels.

This command is for MSR signals only (see [CALCulate<n>:MARKer<m>:FUNction:POWer:PRESet](#) on page 642).

**Suffix:**

|      |                                       |
|------|---------------------------------------|
| <sb> | 1   2   3   4   5<br>sub block number |
| <ch> | 1 to 18<br>Tx channel number          |

**Parameters:**

|             |                          |
|-------------|--------------------------|
| <Frequency> | absolute frequency in Hz |
|-------------|--------------------------|

**Manual operation:** See "Tx Center Frequency" on page 176

**[SENSe:]POWer:ACHannel:SBLock<sb>:FREQUency:CENTer <Frequency>**

This command defines the center of the specified MSR sub block. Note that the position of the sub block also affects the position of the adjacent gap (CACLR) channels.

This command is for MSR signals only (see [CALCulate<n>:MARKer<m>:FUNction:POWer:PRESet](#) on page 642).

**Suffix:**

|      |                                       |
|------|---------------------------------------|
| <sb> | 1   2   3   4   5<br>sub block number |
|------|---------------------------------------|

**Parameters:**

|             |                          |
|-------------|--------------------------|
| <Frequency> | absolute frequency in Hz |
|-------------|--------------------------|

**Manual operation:** See "Sub Block / Center Freq" on page 176

**MSR Adjacent Channel Setup**

The functions for manual operation are described in [Chapter 6.2.5, "MSR ACLR Configuration"](#), on page 169.

Useful commands for MSR adjacent channel setup described elsewhere:

- [Chapter 12.5.3.5, "Checking Limits"](#), on page 650
- ["MSR Channel Names"](#) on page 670

**Remote commands exclusive to MSR adjacent channel setup:**

|                                                                                              |     |
|----------------------------------------------------------------------------------------------|-----|
| <a href="#">[SENSe:]POWer:ACHannel:SBLock&lt;sb&gt;:RFBWidth</a> .....                       | 661 |
| <a href="#">[SENSe:]POWer:ACHannel:SBLock&lt;sb&gt;:TECHnology[:CHANnel&lt;ch&gt;]</a> ..... | 661 |
| <a href="#">[SENSe:]POWer:ACHannel:SBLock&lt;sb&gt;:TXCHannel:COUNT</a> .....                | 662 |
| <a href="#">[SENSe:]POWer:ACHannel:SPACing:UACHannel</a> .....                               | 662 |
| <a href="#">[SENSe:]POWer:ACHannel:SPACing:UALTernate&lt;ch&gt;</a> .....                    | 662 |
| <a href="#">[SENSe:]POWer:ACHannel:SSETup</a> .....                                          | 663 |
| <a href="#">[SENSe:]POWer:ACHannel:BWIDth:UACHannel</a> .....                                | 663 |
| <a href="#">[SENSe:]POWer:ACHannel:BANDwidth:UACHannel</a> .....                             | 663 |
| <a href="#">[SENSe:]POWer:ACHannel:BWIDth:UALTernate&lt;ch&gt;</a> .....                     | 663 |
| <a href="#">[SENSe:]POWer:ACHannel:BANDwidth:UALTernate&lt;ch&gt;</a> .....                  | 663 |
| <a href="#">[SENSe:]POWer:ACHannel:FILTer:ALPHa:UACHannel</a> .....                          | 664 |

|                                                           |     |
|-----------------------------------------------------------|-----|
| [SENSe:]POWer:ACHannel:FiLTer:ALPHa:UALTernate<ch>.....   | 664 |
| [SENSe:]POWer:ACHannel:FiLTer[:STATe]:UACHannel.....      | 664 |
| [SENSe:]POWer:ACHannel:FiLTer[:STATe]:UALTernate<ch>..... | 665 |

---

### [SENSe:]POWer:ACHannel:SBLOCK<sb>:RFBWidth <Bandwidth>

This command defines the bandwidth of the individual MSR sub block. Note that sub block ranges also affect the position of the adjacent gap channels (CACLR).

This command is for MSR signals only (see [CALCulate<n>:MARKer<m>:FUNction:POWer:PRESet](#) on page 642).

#### Suffix:

<sb>                    1 | 2 | 3 | 4 | 5  
                          sub block number

#### Parameters:

<Bandwidth>            Bandwidth in Hz

**Manual operation:** See " [RF Bandwidth](#) " on page 176

---

### [SENSe:]POWer:ACHannel:SBLOCK<sb>:TECHnology[:CHANnel<ch>]                           <Standard>

This command defines the technology used for transmission by the specified MSR Tx channel.

This command is for MSR signals only (see [CALCulate<n>:MARKer<m>:FUNction:POWer:PRESet](#) on page 642).

#### Suffix:

<sb>                    1 | 2 | 3 | 4 | 5  
                          sub block number

<ch>                    1 to 18  
                          Tx channel number

#### Parameters:

<Standard>            GSM | WCDMa | LTE\_1\_40 | LTE\_3\_00 | LTE\_5\_00 |  
                          LTE\_10\_00 | LTE\_15\_00 | LTE\_20\_00 | USER

Technology used for transmission

#### **GSM**

Transmission according to GSM standard

#### **WCDMa**

Transmission according to W-CDMA standard

**LTE\_1\_40 | LTE\_3\_00 | LTE\_5\_00 | LTE\_10\_00 | LTE\_15\_00 |  
LTE\_20\_00**

Transmission according to LTE standard for different channel bandwidths

#### **USER**

User-defined transmission; no automatic preconfiguration possible

**Manual operation:** See " [Technology Used for Transmission](#) " on page 177

---

**[SENSe:]POWer:ACHannel:SBLock<sb>:TXCHannel:COUnT <Number>**

This command defines the number of transmission channels the specific sub block contains.

This command is for MSR signals only (see [CALCulate<n>:MARKer<m>:FUNction:POWer:PRESet](#) on page 642).

**Suffix:**

<sb>                    1 | 2 | 3 | 4 | 5  
                          sub block number

**Parameters:**

<Number>              Range:        1 to 18  
                          \*RST:        1

**Manual operation:** See " [Number of Tx Channels \( Tx Count \)](#) " on page 176

---

**[SENSe:]POWer:ACHannel:SPACing:UACHannel <Spacing>**

This command defines the distance from the transmission channel to the upper adjacent channel.

For MSR signals, this command defines the distance from the CF of the last Tx channel in the last sub block to the upper adjacent channel in asymmetrical configurations. To configure the spacing for the lower adjacent channel use the [\[SENSe:\]POWer:ACHannel:SPACing\[:ACHannel\]](#) command.

**Parameters:**

<Spacing>              Range:        100 Hz to 2000 MHz  
                          \*RST:        14 kHz

**Manual operation:** See " [Adjacent Channel Spacings](#) " on page 179

---

**[SENSe:]POWer:ACHannel:SPACing:UALTernate<ch> <Spacing>**

This command defines the distance from transmission channel to the upper alternate channels.

For MSR signals, this command defines the distance from the CF of the last Tx channel in the last sub block to the upper alternate channel in asymmetrical configurations. To configure the spacing for the lower alternate channel, use the [\[SENSe:\]POWer:ACHannel:SPACing:ALTernate<ch>](#) command.

**Suffix:**

<ch>                    1 to 11  
                          Alternate channel number

**Parameters:**

<Spacing>              Range:        100 Hz to 2000 MHz  
                          \*RST:        40 kHz (ALT1), 60 kHz (ALT2), 80 kHz (ALT3), ...

**Manual operation:** See "[Adjacent Channel Spacings](#)" on page 179

---

**[SENSe:]POWer:ACHannel:SSEtup <State>**

This command defines whether adjacent channels are defined symmetrically or not.

For more information see [Chapter 6.2.3.4, "Measurement on Multi-Standard Radio \(MSR\) Signals"](#), on page 155.

**Parameters:**

<State> ON | OFF | 1 | 0

**ON | 1**

The upper and lower adjacent and alternate channels are defined symmetrically. This is the default behaviour and corresponds to the behavior in firmware versions before 2.10.

**OFF | 0**

The upper and lower channels can be configured differently.

\*RST: 1

**Manual operation:** See "[Symmetrical Adjacent Setup](#)" on page 174

---

**[SENSe:]POWer:ACHannel:BWIDth:UACHannel <Bandwidth>**

**[SENSe:]POWer:ACHannel:BANDwidth:UACHannel <Bandwidth>**

This command defines the channel bandwidth of the upper adjacent channel in asymmetrical configurations.

The adjacent channel is the first pair of channels next to the transmission channels. To configure the bandwidth for the lower adjacent channel, use the [\[SENSe:\]POWer:ACHannel:BANDwidth:ACHannel](#) command.

Steep-edged channel filters are available for fast ACLR measurements.

**Parameters:**

<Bandwidth> Range: 100 Hz to 1000 MHz

\*RST: 14 kHz

**Manual operation:** See "[Adjacent Channel Bandwidths](#)" on page 179

---

**[SENSe:]POWer:ACHannel:BWIDth:UALTernate<ch> <Bandwidth>**

**[SENSe:]POWer:ACHannel:BANDwidth:UALTernate<ch> <Bandwidth>**

This command defines the channel bandwidth of the upper alternate channels in asymmetrical configurations. To configure the bandwidth for the lower alternate channel, use the [\[SENSe:\]POWer:ACHannel:BANDwidth:ALTernate<ch>](#) command.

Steep-edged channel filters are available for fast ACLR measurements.

**Suffix:**

<ch> 1 to 11

Alternate channel number

**Parameters:**

<Bandwidth>            Range:     100 Hz to 1000 MHz  
                              \*RST:     14 kHz

**Manual operation:** See "[Adjacent Channel Bandwidths](#)" on page 179

**[SENSe:]POWer:ACHannel:FILTer:ALPHa:UACHannel <Alpha>**

This command defines the roll-off factor for the upper adjacent channel weighting filter for asymmetrical MSR signals. To configure the factor for the upper adjacent channel, use the `[SENSe:]POWer:ACHannel:FILTer:ALPHa:ACHannel` command.

**Parameters:**

<Alpha>                 Roll-off factor  
                              Range:     0 to 1  
                              \*RST:     0.22

**Manual operation:** See "[Weighting Filters](#)" on page 179

**[SENSe:]POWer:ACHannel:FILTer:ALPHa:UALTernate<ch> <Alpha>**

This command defines the roll-off factor for the upper alternate channels' weighting filter for asymmetrical MSR signals. To configure the factor for the upper alternate channels, use the `[SENSe:]POWer:ACHannel:FILTer:ALPHa:UALTernate<ch>` command.

**Suffix:**

<ch>                     1 to 11  
                              Alternate channel number

**Parameters:**

<Alpha>                 Roll-off factor  
                              Range:     0 to 1  
                              \*RST:     0.22

**Manual operation:** See "[Weighting Filters](#)" on page 179

**[SENSe:]POWer:ACHannel:FILTer[:STATe]:UACHannel <State>**

This command turns the weighting filter for the upper adjacent channel on and off for asymmetrical MSR signals. To configure the factor for the lower adjacent channel, use the `[SENSe:]POWer:ACHannel:FILTer[:STATe]:ACHannel` command.

**Parameters:**

<State>                 ON | OFF | 1 | 0  
                              \*RST:     0

**Manual operation:** See "[Weighting Filters](#)" on page 179



**[SENSe:]POWer:ACHannel:FILTer[:STATe]:UALTernate<ch> <State>**

This command turns the weighting filter for the upper alternate channels on and off for asymmetrical MSR signals. To configure the factor for the lower alternate channels, use the `[SENSe:]POWer:ACHannel:FILTer[:STATe]:ALTernate<ch>` command.

**Suffix:**

<ch> 1 to 11  
Alternate channel number

**Parameters:**

<State> ON | OFF | 1 | 0  
\*RST: 0

**Manual operation:** See " [Weighting Filters](#) " on page 179

**MSR Gap Channel Setup**

The functions for manual operation are described in [Chapter 6.2.5.4, "MSR Gap Channel Setup"](#), on page 180.

|                                                                                                      |     |
|------------------------------------------------------------------------------------------------------|-----|
| <code>CALCulate&lt;n&gt;:LIMit&lt;k&gt;:ACPower:GAP&lt;gap&gt;:ABSolute</code> .....                 | 665 |
| <code>CALCulate&lt;n&gt;:LIMit&lt;k&gt;:ACPower:GAP&lt;gap&gt;:ABSolute:STATe</code> .....           | 666 |
| <code>CALCulate&lt;n&gt;:LIMit&lt;k&gt;:ACPower:GAP&lt;gap&gt;:ACLR[:RELative]</code> .....          | 666 |
| <code>CALCulate&lt;n&gt;:LIMit&lt;k&gt;:ACPower:GAP&lt;gap&gt;:ACLR[:RELative]:STATe</code> .....    | 666 |
| <code>CALCulate&lt;n&gt;:LIMit&lt;k&gt;:ACPower:GAP&lt;gap&gt;[:CACLR][:RELative]</code> .....       | 667 |
| <code>CALCulate&lt;n&gt;:LIMit&lt;k&gt;:ACPower:GAP&lt;gap&gt;[:CACLR][:RELative]:STATe</code> ..... | 667 |
| <code>[SENSe:]POWer:ACHannel:AGCHannels</code> .....                                                 | 668 |
| <code>[SENSe:]POWer:ACHannel:BWIDth:GAP&lt;gap&gt;</code> .....                                      | 668 |
| <code>[SENSe:]POWer:ACHannel:BANDwidth:GAP&lt;gap&gt;</code> .....                                   | 668 |
| <code>[SENSe:]POWer:ACHannel:FILTer:ALPHa:GAP&lt;gap&gt;</code> .....                                | 668 |
| <code>[SENSe:]POWer:ACHannel:FILTer[:STATe]:GAP&lt;gap&gt;</code> .....                              | 669 |
| <code>[SENSe:]POWer:ACHannel:GAP&lt;gap&gt;:MSIZe</code> .....                                       | 669 |
| <code>[SENSe:]POWer:ACHannel:SPACing:GAP&lt;gap&gt;</code> .....                                     | 669 |

**CALCulate<n>:LIMit<k>:ACPower:GAP<gap>:ABSolute <Limit>, <Reserved>**

This command defines the absolute limit of the specified gap (CACLR) channel.

If you have defined an absolute limit as well as a relative limit, the R&S FPS uses the lower value for the limit check.

**Suffix:**

<n>, <k> irrelevant  
<gap> 1 | 2  
Gap (CACLR) channel number

**Parameters:**

<Limit> Defines the absolute limit of the specified gap channel in dBm.  
<Reserved> Ignored.

**Example:** `CALC:LIM:ACP:GAP2:ABS 44.2dBm,0`

**Manual operation:** See " [Limit Checking](#) " on page 182

---

**CALCulate<n>:LIMit<k>:ACPower:GAP<gap>:ABSolute:STATe <State>**

This command turns the absolute limit check for the specified gap (CACLR) channel on and off.

You have to activate the general ACLR limit check before using this command with [CALCulate<n>:LIMit<k>:ACPower\[:STATe\]](#).

**Suffix:**

<n>, <k>                    irrelevant  
 <gap>                        1 | 2  
                                   Gap (CACLR) channel number

**Parameters:**

<State>                      ON | OFF | 1 | 0  
 \*RST:                        0

**Manual operation:** See " [Limit Checking](#) " on page 182

---

**CALCulate<n>:LIMit<k>:ACPower:GAP<gap>:ACLR[:RELative] <Limit>**

This command defines the relative limit for the ACLR power in the specified gap channel. The reference value for the relative limit is the measured channel power.

If you have defined an absolute limit as well as a relative limit, the R&S FPS uses the lower value for the limit check.

**Suffix:**

<n>, <k>                      irrelevant  
 <gap>                        1 | 2  
                                   Gap channel number

**Parameters:**

<Limit>                      Defines the relative limit for the ACLR power in the specified gap channel in dB.

**Example:**                    CALC:LIM:ACP:GAP1:ACLR:REL 3dB

**Manual operation:** See " [Limit Checking](#) " on page 182

---

**CALCulate<n>:LIMit<k>:ACPower:GAP<gap>:ACLR[:RELative]:STATe <State>**

This command turns the relative limit check for the ACLR power in the specified gap channel on and off.

You have to activate the general ACLR limit check before using this command with [CALCulate<n>:LIMit<k>:ACPower\[:STATe\]](#).

**Suffix:**

<n>, <k>                      irrelevant

<gap> 1 | 2  
Gap channel number

**Parameters:**

<State> ON | OFF | 1 | 0  
\*RST: 0

**Example:** CALC:LIM:ACP:GAP1:ACLR:REL:STAT ON

**Manual operation:** See " [Limit Checking](#) " on page 182

**CALCulate<n>:LIMit<k>:ACPower:GAP<gap>[:CACLR][:RELative] <Limit>**

This command defines the relative limit for the CACLR power in the specified gap channel. The reference value for the relative limit is the measured channel power.

If you have defined an absolute limit as well as a relative limit, the R&S FPS uses the lower value for the limit check.

**Suffix:**

<n>, <k> irrelevant

<gap> 1 | 2  
Gap channel number

**Parameters:**

<Limit> Defines the relative limit of the specified gap channel in dB.

**Example:** CALC:LIM:ACP:GAP1:REL 3dB

**Manual operation:** See " [Limit Checking](#) " on page 182

**CALCulate<n>:LIMit<k>:ACPower:GAP<gap>[:CACLR][:RELative]:STATe <State>**

This command turns the relative limit check for the CACLR power in the specified gap channel on and off.

You have to activate the general ACLR limit check before using this command with [CALCulate<n>:LIMit<k>:ACPower\[:STATe\]](#).

**Suffix:**

<n>, <k> irrelevant

<gap> 1 | 2  
Gap channel number

**Parameters:**

<State> ON | OFF | 1 | 0  
\*RST: 0

**Example:** CALC:LIM:ACP:GAP1:REL:STAT ON

**Manual operation:** See " [Limit Checking](#) " on page 182

**[SENSe:]POWer:ACHannel:AGCHannels <State>**

This command activates or deactivates gap channels in an MSR signal.

For more information see [Chapter 6.2.3.4, "Measurement on Multi-Standard Radio \(MSR\) Signals"](#), on page 155.

**Parameters:**

&lt;State&gt;

ON | OFF | 1 | 0

**ON | 1**

The gap channels are displayed and channel power results are calculated and displayed in the Result Summary.

**OFF | 0**

The gap channels are not displayed in the diagram and channel power results are not calculated nor displayed in the Result Summary.

\*RST: 1

**Manual operation:** See "[Activate Gaps](#)" on page 181

**[SENSe:]POWer:ACHannel:BWIDth:GAP<gap> <Bandwidth>****[SENSe:]POWer:ACHannel:BANDwidth:GAP<gap> <Bandwidth>**

This command defines the bandwidth of the specified MSR gap (CACLR) channel.

This command is for MSR signals only (see [CALCulate<n>:MARKer<m>:FUNction:POWer:PRESet](#) on page 642).

**Suffix:**

&lt;gap&gt;

1 | 2

Gap (CACLR) channel number

**Parameters:**

&lt;Bandwidth&gt;

numeric value in Hz

\*RST: 3.84 MHz

**Manual operation:** See "[Gap Channel Bandwidths](#)" on page 182

**[SENSe:]POWer:ACHannel:FILTer:ALPHa:GAP<gap> <Alpha>**

This command defines the roll-off factor for the specified gap (CACLR) channel's weighting filter.

**Suffix:**

&lt;gap&gt;

1 | 2

Gap (CACLR) channel number

**Parameters:**

&lt;Alpha&gt;

Roll-off factor

Range: 0 to 1

\*RST: 0.22

**Manual operation:** See "[Weighting Filters](#)" on page 182

**[SENSe:]POWer:ACHannel:FiLTeR[:STATe]:GAP<gap> <State>**

This command turns the weighting filter for the specified gap (CACLR) channel on and off.

**Suffix:**

<gap> 1 | 2  
Gap (CACLR) channel number

**Parameters:**

<State> ON | OFF | 1 | 0  
\*RST: 0

**Manual operation:** See " [Weighting Filters](#) " on page 182

**[SENSe:]POWer:ACHannel:GAP<gap>:MSIZe <Bandwidth>**

If the gap between the sub blocks does not exceed the specified bandwidth, the gap channels are not displayed in the diagram, and the gap channel results are not calculated in the result summary.

**Suffix:**

<gap> 1 | 2  
Gap channel number

**Parameters:**

<Bandwidth> numeric value in Hz  
\*RST: gap1: 5 MHz; gap2: 10 MHz

**Example:**

POW:ACH:GAP2:MSIZ 5MHZ

**Manual operation:** See " [Minimum gap size to show Gap 1 / Minimum gap size to show Gap 2](#) " on page 181

**[SENSe:]POWer:ACHannel:SPACing:GAP<gap> <Spacing>**

This command defines the distance from sub block to the specified gap channel.

The channels in the upper gap are identical to those in the lower gap. Thus, in the R&S FPS MSR ACLR measurement, only 2 gap channels are configured.

The spacing for gap channels is defined in relation to the outer edges of the surrounding sub blocks, i.e.

Spacing = [CF of the gap channel] - [left sub block center] + ([RF bandwidth of left sub block] / 2)

(See also [Figure 6-24](#) and [Figure 6-25](#).)

**Suffix:**

<gap> 1 | 2  
Gap channel number

**Parameters:**

<Spacing>            numeric value in Hz  
                           \*RST:        2.5 MHz

**Manual operation:** See " [Gap Channel Spacing](#) " on page 182

**MSR Channel Names**

The functions for manual operation are described in [Chapter 6.2.5.5, "MSR Channel Names"](#), on page 183.

[SENSe:]POWer:ACHannel:NAME:UACHannel..... 670  
 [SENSe:]POWer:ACHannel:NAME:UALTernate<ch>.....670  
 [SENSe:]POWer:ACHannel:SBLock<sb>:NAME[:CHANnel<ch>].....670

**[SENSe:]POWer:ACHannel:NAME:UACHannel <Name>**

This command defines the name for the upper adjacent channel in asymmetrical MSR channel definitions. To define the name for the lower adjacent channel use the [SENSe:]POWer:ACHannel:NAME:ACHannel command.

**Parameters:**

<Name>                String containing the name of the channel  
                           \*RST:        ADJ

**[SENSe:]POWer:ACHannel:NAME:UALTernate<ch> <Name>**

This command defines the name for the specified upper alternate channel in asymmetrical MSR channel definitions. To define the name for the lower adjacent channels use the [SENSe:]POWer:ACHannel:NAME:ALTernate<ch> command.

**Suffix:**

<ch>                    1 to 11  
                           Alternate channel number

**Parameters:**

<Name>                String containing the name of the channel  
                           \*RST:        ALT<1...11>

**[SENSe:]POWer:ACHannel:SBLock<sb>:NAME[:CHANnel<ch>] <Name>**

This command defines the name of the specified MSR Tx channel.

This command is for MSR signals only.

**Suffix:**

<sb>                    1 | 2 | 3 | 4 | 5  
                           sub block number  
  
 <ch>                    1 to 18  
                           Tx channel number

**Parameters:**

<Name> String containing the name of the channel

**Example:**

POW:ACH:SBL2:NAME:CHAN2 'B:WCDMA'

**Manual operation:** See "Tx Channel Definition" on page 176

### 12.5.3.8 Performing an ACLR Measurement

The following commands are required to perform an ACLR measurement:

- `CALC:MARK:FUNC:POW:SEL ACP`, see `CALCulate<n>:MARKer<m>:FUNCTION:POWER:SElect` on page 639
- `CALCulate<n>:MARKer<m>:FUNCTION:POWER[:STATe]` on page 639
- `INITiate<n>[:IMMediate]` on page 636

### 12.5.3.9 Analyzing Measurement Results

The following commands analyze and retrieve measurement results for ACLR measurements.

#### Useful commands for channel power measurements described elsewhere

- `CALCulate<n>:MARKer<m>:FUNCTION:POWER<sb>:RESult?` on page 637
- `TRACe<n>[:DATA]` on page 854

#### Remote commands exclusive to channel power measurements

|                                                                                             |     |
|---------------------------------------------------------------------------------------------|-----|
| <code>CALCulate&lt;n&gt;:LIMit&lt;k&gt;:ACPower:GAP&lt;gap&gt;[:CACLR]:RESult?</code> ..... | 671 |
| <code>CALCulate&lt;n&gt;:MARKer&lt;m&gt;:FUNCTION:POWER:RESult:PHZ</code> .....             | 672 |
| <code>[SENSe:]POWER:ACHannel:MODE</code> .....                                              | 672 |

#### `CALCulate<n>:LIMit<k>:ACPower:GAP<gap>[:CACLR]:RESult?`

This command queries the state of the limit check for *all* gap (CACLR) channels in an MSR ACLR measurement.

To get a valid result, you have to perform a complete measurement with synchronization to the end of the measurement before reading out the result. This is only possible for single sweep mode.

See also `INITiate<n>:CONTinuous` on page 635.

The results of the power limit checks are also indicated in the `STAT:QUES:ACPL` status registry (see "`STATus:QUESTionable:ACPLimit Register`" on page 594).

**Suffix:**

|          |                     |
|----------|---------------------|
| <n>, <k> | irrelevant          |
| <gap>    | 1   2<br>irrelevant |

**Return values:**

<LowerGap1>  
 <UpperGap1>  
 <LowerGap2>  
 <UpperGap2>

The command returns the results for the four gap channels for each gap (max. 4).

**PASSED**

Limit check has passed.

**FAIL**

Limit check has failed.

**NONE**

No results available, e.g. because limit checking was deactivated

**Example:**

```
INIT:IMM;*WAI;
CALC:LIM:ACP:GAP2:RES?
PASSED,PASSED,
```

**Usage:**

Query only

**Manual operation:** See "[Limit Checking](#)" on page 182

**CALCulate<n>:MARKer<m>:FUNCTION:POWer:RESult:PHZ <State>**

This command selects the way the R&S FPS returns results for power measurements.

You can query results with `CALCulate<n>:MARKer<m>:FUNCTION:POWer<sb>:RESult?`.

**Suffix:**

<n> [Window](#)

<m> [Marker](#)

**Parameters:**

<State> ON | OFF | 1 | 0

**ON | 1**

Channel power density in dBm/Hz

**OFF | 0**

Channel power in dBm

\*RST: 0

**Example:**

```
CALC:MARK:FUNC:POW:RES:PHZ ON
Output of results referred to the channel bandwidth.
```

**Manual operation:** See "[Channel power level and density \( Power Unit \)](#)" on page 164

**[SENSe:]POWer:ACHannel:MODE <Mode>**

This command selects the way the R&S FPS displays the power of adjacent channels.

You need at least one adjacent channel for the command to work.



**Parameters:**

&lt;Mode&gt;

**ABSolute**

Shows the absolute power of all channels

**RELative**

Shows the power of adjacent and alternate channels in relation to the transmission channel

\*RST: RELative

**Manual operation:** See "[Absolute and Relative Values \(ACLR Mode\)](#)" on page 164**12.5.3.10 Programming Examples for Channel Power Measurements**

The following programming examples are meant to demonstrate the most important commands to perform channel power measurements in a remote environment.

- [Example: Configuring and Performing an ACLR Measurement.....673](#)
- [Example: Configuring and Performing an MSR ACLR Measurement.....675](#)

**Example: Configuring and Performing an ACLR Measurement**

In this example we will configure and perform an adjacent-channel power measurement. Note that this example is primarily meant to demonstrate the remote control commands, it does not necessarily reflect a useful measurement task. For most common measurement standards, the R&S FPS performs the measurement optimally with the predefined settings, without further configuration.

```
//-----Preparing the measurement -----
//Reset the instrument
*RST

//-----Preparing the measurement-----

//Activate adjacent-channel power measurement.
CALC:MARK:FUNC:POW:SEL ACP
//Select the user standard "GSM"
CALC:MARK:FUNC:POW:PRES GSM

//-----Setting Up Channels-----
//Create one transmission channel.
POW:ACH:TXCH:COUN 1
//Name the first transmission channel 'TX Channel'.
POW:ACH:NAME:CHAN1 'TX Channel'
//Create two adjacent channels - one adjacent channel and one alternate channel.
POW:ACH:ACP 2
//Name the adjacent channel 'ABC'
POW:ACH:NAME:ACH 'ABC'
//Name the first alternate channel 'XYZ'.
POW:ACH:NAME:ALT1 'XYZ'
//Define a bandwidth of 30 kHz for the transmission channel.
POW:ACH:BWID:CHAN1 30kHz
//Define a bandwidth of 30 kHz for the adjacent channel.
```

## Configuring and Performing Measurements

```

POW:ACH:BWID:ACH 30kHz
//Define a bandwidth of 30 kHz for the first alternate channel.
POW:ACH:BWID:ALT1 30kHz
//Define a distance of 33 kHz from the center of the transmission channel to the
//center of the adjacent channel.
//Also adjust the distance to the alternate channels (66 kHz).
POW:ACH:SPAC 33kHz
//Define a distance of 100 kHz from the center of the transmission channel to the
//center of the first alternate channel.
POW:ACH:SPAC:ALT1 100kHz

//-----Selecting a Reference Channel--
//Select relative display of the channel power.
POW:ACH:MODE REL
//Define transmission channel 1 as the reference channel.
POW:ACH:REF:TXCH:MAN 1

//-----Saving the settings as a user standard-----
//Save the user standard with the name "my_aclr_standard".
//Weighting filters can only be defined for user-defined standards.
CALC:MARK:FUNC:POW:STAN:SAVE 'my_aclr_standard'

//-----Defining Weighting Filters-----
//Define a roll-off factor of 0.35 for the weighting filter of the first
//transmission channel.
POW:ACH:FILT:ALPH:CHAN1 0.35
//Turn the weighting filter for the first transmission channel on.
POW:ACH:FILT:CHAN1 ON
//Define a roll-off factor of 0.35 for the weighting filter of the adjacent
//channel.
POW:ACH:FILT:ALPH:ACH 0.35
//Turn the weighting filter for the adjacent channel on.
POW:ACH:FILT:ACH ON
//Define a roll-off factor of 0.35 for the weighting filter of the first
//alternate channel.
POW:ACH:FILT:ALPH:ALT1 0.35
//Turn the weighting filter for the first alternate channel on.
POW:ACH:FILT:ALT1 ON

//-----Working with Limits-----
//Define a relative limit of 30 dB below the power of the reference channel
//for both adjacent channels.
CALC:LIM:ACP:ACH 30DB,30DB
//Define a relative limit of 25 dB below the power of the reference channel
//for the first alternate channels.
CALC:LIM:ACP:ALT1 25DB,25DB
//Define an absolute limit of -35 dBm for both adjacent channels.
CALC:LIM:ACP:ACH:ABS -35DBM,-35DBM
//Turn the ACLR limit check on.
CALC:LIM:ACP ON

```

```

//Turn the relative limit check for adjacent channels on.
CALC:LIM:ACP:ACH:STAT ON
//Turn the absolute limit check for adjacent channels on.
CALC:LIM:ACP:ACH:ABS:STAT ON
//Turn the absolute limit check for the first alternate channel on.
CALC:LIM:ACP:ALT1:ABS:STAT ON

//-----Performing the Measurement-----
//Determine the ideal ACLR measurement configuration.
POW:ACH:PRES ACP;*WAI
//Determine the ideal reference level for the measurement.
POW:ACH:PRES:RLEV;*WAI
//Initiate a new measurement and waits until the sweep has finished.
INIT;*WAI

//-----Limit Check-----
//Query the results of the limit check for the adjacent channels.
CALC:LIM:ACP:ACH:RES?
//Query the results of the limit check for the first alternate channels.
CALC:LIM:ACP:ALT1:RES?

//-----Retrieving Results-----
//Query the results for the ACLR measurement.
CALC:MARK:FUNC:POW:RES? ACP

```

### Example: Configuring and Performing an MSR ACLR Measurement

This example demonstrates how to configure and perform an ACLR measurement on a multi-standard radio signal in a remote environment.

Note that this example assumes the instrument 'MyFSW' is configured as described in ["Example: Configuring and Performing an ACLR Measurement"](#) on page 673.

```

//-----Preparing the measurement -----
//Reset the instrument
*RST

// Select ACLR measurement
:CALCulate:MARKer:FUNCTION:POWer:SElect ACPower

// Select MSR Standard :CALCulate:MARKer:FUNCTION:POWer:PRESet MSR

//Configure general measurement settings
:SENSe:FREQuency:CENTer 1.25GHz
:SENSe:FREQuency:SPAN 62.0MHz
:SENSe:POWer:ACHannel:SBCount 3

//----- Configuring Sub block A

:SENSe:POWer:ACHannel:SBLock1:TXChannel:COUNT 3
:SENSe:POWer:ACHannel:SBLock1:FREQuency:CENTer 1.230GHZ

```

## Configuring and Performing Measurements

```

:SENSe:POWer:ACHannel:SBLOCK1:RFBWidth 12MHZ

:SENSe:POWer:ACHannel:SBLOCK1:CENTer:CHANnel1 1.226GHZ
:SENSe:POWer:ACHannel:SBLOCK1:CENTer:CHANnel2 1.230GHZ
:SENSe:POWer:ACHannel:SBLOCK1:CENTer:CHANnel3 1.234GHZ

:SENSe:POWer:ACHannel:SBLOCK1:TECHnology:CHANnel1 WCDMA
:SENSe:POWer:ACHannel:SBLOCK1:TECHnology:CHANnel2 WCDMA
:SENSe:POWer:ACHannel:SBLOCK1:TECHnology:CHANnel3 GSM

:SENSe:POWer:ACHannel:SBLOCK1:BANDwidth:CHANnel1 2.5MHZ
:SENSe:POWer:ACHannel:SBLOCK1:BANDwidth:CHANnel2 2.5MHZ
:SENSe:POWer:ACHannel:SBLOCK1:BANDwidth:CHANnel3 2.5MHZ

//----- Configuring Sub block B

:SENSe:POWer:ACHannel:SBLOCK2:TXCHannel:COUNT 1
:SENSe:POWer:ACHannel:SBLOCK2:FREQuency:CENTer 1.255GHZ
:SENSe:POWer:ACHannel:SBLOCK2:RFBWidth 4MHZ

:SENSe:POWer:ACHannel:SBLOCK2:CENTer:CHANnel1 1.255GHZ

:SENSe:POWer:ACHannel:SBLOCK2:TECHnology:CHANnel1 LTE_1_40

:SENSe:POWer:ACHannel:SBLOCK2:BANDwidth:CHANnel1 3.25MHZ

//----- Configuring Sub block C

:SENSe:POWer:ACHannel:SBLOCK3:TXCHannel:COUNT 2
:SENSe:POWer:ACHannel:SBLOCK3:FREQuency:CENTer 1.268GHZ
:SENSe:POWer:ACHannel:SBLOCK3:RFBWidth 8MHZ

:SENSe:POWer:ACHannel:SBLOCK3:CENTer:CHANnel1 1.266GHZ
:SENSe:POWer:ACHannel:SBLOCK3:CENTer:CHANnel2 1.270GHZ

:SENSe:POWer:ACHannel:SBLOCK3:BANDwidth:CHANnel1 2.75MHZ
:SENSe:POWer:ACHannel:SBLOCK3:BANDwidth:CHANnel2 2.75MHZ

//----- Configuring ADJ channels

:SENSe:POWer:ACHannel:BANDwidth:ACHannel 1.60MHZ
:SENSe:POWer:ACHannel:BANDwidth:ALternate1 1.60MHZ

:SENSe:POWer:ACHannel:SPACing:ACHannel 3MHZ
:SENSe:POWer:ACHannel:SPACing:ALternate1 5MHZ

//----- Configuring gap (CACLR) channels

```

```

:SENSe:POWer:ACHannel:SPACing:GAP1 2.0MHZ
:SENSe:POWer:ACHannel:SPACing:GAP2 5.0MHZ

:SENSe:POWer:ACHannel:BANDwidth:GAP1 2.0MHZ
:SENSe:POWer:ACHannel:BANDwidth:GAP2 2.0MHZ

//-----Performing the Measurement-----

//Select single sweep mode.
INIT:CONT OFF
//Initiate a new measurement and wait until the sweep has finished.
INIT;*WAI

//-----Retrieving Results-----

//Return the results for the ACLR measurement.
CALC:MARK:FUNC:POW:RES? MCAC
//Results:
//Transmission channels in sub block A
//-13.2346727385,-13.2346723793,-13.2390131759,
//Transmission channels in sub block B
//-17.0863336597,
//Transmission channels in sub block C
//-13.2390127767,-13.2390134744,
//Totals for each sub block
//-8.4649064021,-17.0863336597,-10.2287131689,
//Adjacent channels
//-67.9740721019,-67.9740728014,-0.00434041734,-0.00434041734,
//CACLR channels
//-0.52933512766,-64.9990115835,-64.5012521492,-0.33507330922,
//-64.4924159646,-0.52932552499,-0.52932552495,-64.4934163414

```

## 12.5.4 Measuring the Carrier-to-Noise Ratio

The following commands are necessary to perform carrier-to-noise measurements.

- `CALC:MARK:FUNC:POW:SEL CN | CN0`, see `CALCulate<n>:MARKer<m>:FUNCTION:POWER:SElect`
- `CALCulate<n>:MARKer<m>:FUNCTION:POWER[:STATe]`
- `CALCulate<n>:MARKer<m>:FUNCTION:POWER<sb>:RESult?`
- `[SENSe:]POWER:ACHannel:BANDwidth[:CHANnel<ch>]`
- `[SENSe:]POWER:ACHannel:PRESet`

### Programming example: Measuring the carrier-to-noise ratio

This programming example demonstrates how to perform a Carrier-to-noise measurement in a remote environment.

```

//-----Preparing the measurement-----
*RST
//Reset the instrument
FREQ:CENT 800MHz
//Sets the center frequency to the carrier frequency of 800 MHz.
CALC:MARK:FUNC:POW:SEL CN
//Activates carrier-to-noise ratio measurement.
POW:ACH:PRES CN
//Optimizes the instrument settings according to the channel bandwidth.
POW:ACH:PRES:RLEV
//Determines the ideal reference level for the measurement.

//-----Performing the Measurement-----
INIT:CONT OFF
//Selects single sweep mode.
INIT;*WAI
//Initiates a new measurement and waits until the sweep has finished.

// Now turn off the carrier signal and repeat the measurement:
INIT;*WAI
//Initiates a new measurement and waits until the sweep has finished.

//-----Retrieving Results-----
CALC:MARK:FUNC:POW:RES? CN
//Returns the carrier-to-noise ratio.

```

## 12.5.5 Measuring the Occupied Bandwidth

All remote control commands specific to occupied bandwidth measurements are described here.

- [Configuring the Measurement](#).....678
- [Programming Example: OBW Measurement](#).....679

### 12.5.5.1 Configuring the Measurement

The following commands configure measurements of the occupied bandwidth.

#### Useful commands for occupied bandwidth measurements described elsewhere

Configuring the channel:

- `[SENSe:]POWer:ACHannel:BANDwidth[:CHANnel<ch>]`
- `[SENSe:]POWer:ACHannel:PRESet`
- `[SENSe:]POWer:ACHannel:PRESet:RLEVel`

Defining search limits:

- `CALCulate<n>:MARKer<m>:X:SLIMits[:STATe]` on page 870
- `CALCulate<n>:MARKer<m>:X:SLIMits:LEFT` on page 871

- [CALCulate<n>:MARKer<m>:X:SLIMits:RIGHT](#) on page 871

Performing the measurement:

- [CALCulate<n>:MARKer<m>:FUNction:POWer:SElect](#) on page 639
- [CALCulate<n>:MARKer<m>:FUNction:POWer\[:STATe\]](#) on page 639

Retrieving results:

- [CALCulate<n>:MARKer<m>:FUNction:POWer<sb>:RESult?](#) on page 637

**Remote commands exclusive to occupied bandwidth measurements:**

|                                               |     |
|-----------------------------------------------|-----|
| <a href="#">[SENSe:]POWer:BWIDth</a> .....    | 679 |
| <a href="#">[SENSe:]POWer:BANDwidth</a> ..... | 679 |

---

**[SENSe:]POWer:BWIDth <Percentage>**

**[SENSe:]POWer:BANDwidth <Percentage>**

This command selects the percentage of the total power that defines the occupied bandwidth.

**Parameters:**

|              |        |                    |
|--------------|--------|--------------------|
| <Percentage> | Range: | 10 PCT to 99.9 PCT |
|              | *RST:  | 99 PCT             |

**Example:** POW:BAND 95PCT

**Manual operation:** See "[% Power Bandwidth](#)" on page 202

### 12.5.5.2 Programming Example: OBW Measurement

This programming example demonstrates the measurement example described in [Chapter 6.4.5, "Measurement Example"](#), on page 204 in a remote environment.

```
//-----Preparing the measurement -----
//Reset the instrument
*RST

//-----Configuring the Measurement-----
//Set the center frequency to 800 MHz.
FREQ:CENT 800MHz
//Set the reference level to -10 dBm.
DISP:TRAC:Y:RLEV -10dBm
//Activate occupied bandwidth measurement.
CALC:MARK:FUNC:POW:SEL OBW
//Set the percentage of power to 99%.
POW:BWID 99PCT
//Set the channel bandwidth to 21 kHz.
POW:ACH:BAND 21kHz
//Optimize the instrument settings according to the channel bandwidth.
POW:ACH:PRES OBW
//Determine the ideal reference level for the measurement.
POW:ACH:PRES:RLEV
```

```
//Set the trace detector to positive peak.
DET APE

//-----Performing the Measurement-----
//Select single sweep mode.INIT:CONT OFF

//Initiate a new measurement and waits until the sweep has finished.
INIT;*WAI

//-----Retrieving Results-----
//Return the occupied bandwidth.
CALC:MARK:FUNC:POW:RES? OBW
```

## 12.5.6 Measuring the Spectrum Emission Mask

All remote control commands specific to spectrum emission mask measurements are described here.



See also [Chapter 12.5.2, "Configuring Power Measurements"](#), on page 636.

|                                                             |     |
|-------------------------------------------------------------|-----|
| • <a href="#">Managing Measurement Configurations</a> ..... | 680 |
| • <a href="#">Controlling the Measurement</a> .....         | 682 |
| • <a href="#">Configuring a Multi-SEM Measurement</a> ..... | 682 |
| • <a href="#">Configuring a Sweep List</a> .....            | 683 |
| • <a href="#">Configuring the Reference Range</a> .....     | 697 |
| • <a href="#">Configuring the Power Classes</a> .....       | 699 |
| • <a href="#">Configuring MSR SEM Measurements</a> .....    | 704 |
| • <a href="#">Configuring the List Evaluation</a> .....     | 710 |
| • <a href="#">Performing an SEM Measurement</a> .....       | 712 |
| • <a href="#">Retrieving Results</a> .....                  | 712 |
| • <a href="#">Example: SEM Measurement</a> .....            | 712 |

### 12.5.6.1 Managing Measurement Configurations

The following commands control measurement configurations for SEM measurements.

|                                                                                     |     |
|-------------------------------------------------------------------------------------|-----|
| <a href="#">CALCulate&lt;n&gt;:LIMit&lt;k&gt;:ESPectrum&lt;sb&gt;:RESTore</a> ..... | 680 |
| <a href="#">[SENSe:]ESPectrum&lt;sb&gt;:PRESet[:STANdard]</a> .....                 | 681 |
| <a href="#">[SENSe:]ESPectrum&lt;sb&gt;:PRESet:RESTore</a> .....                    | 681 |
| <a href="#">[SENSe:]ESPectrum&lt;sb&gt;:PRESet:STORE</a> .....                      | 681 |

#### **CALCulate<n>:LIMit<k>:ESPectrum<sb>:RESTore**

This command restores the predefined limit lines for the selected Spectrum Emission Mask standard.



All modifications made to the predefined limit lines are lost and the factory-set values are restored.

**Suffix:**

<n>, <k>, <sb>      irrelevant

**Example:**

CALC:LIM:ESP:REST

Resets the limit lines for the current Spectrum Emission Mask standard to the default setting.

**[SENSe:]ESpectrum<sb>:PRESet[:STANdard] <Standard>**

This command loads a measurement configuration.

Standard definitions are stored in an xml file. The default directory for SEM standards is C:\R\_S\INSTR\sem\_std.

**Suffix:**

<sb>                    1 | 2 | 3  
Sub block in a Multi-SEM measurement

**Parameters:**

<Standard>            String containing the file name.  
If you have stored the file in a subdirectory of the directory mentioned above, you have to include the relative path to the file.

**Return values:**

<Standard>            The query returns the name of the currently loaded standard.

**Manual operation:** See "[Standard / MSR Settings](#)" on page 226  
See "[Load Standard](#)" on page 233

**[SENSe:]ESpectrum<sb>:PRESet:RESTore**

This command restores the default configurations of predefined SEM standards.

Note that the command will overwrite customized standards that have the same name as predefined standards.

**Suffix:**

<sb>                    1 | 2 | 3  
Sub block in a Multi-SEM measurement

**Usage:**                Event

**Manual operation:** See "[Restore Standard Files](#)" on page 234

**[SENSe:]ESpectrum<sb>:PRESet:STORE <Standard>**

This command saves the current SEM measurement configuration.

Standard definitions are stored in an xml file. The default directory for SEM standards is C:\R\_S\INSTR\sem\_std.

**Suffix:**

<sb> 1 | 2 | 3  
Sub block in a Multi-SEM measurement

**Parameters:**

<Standard> String containing the file name.  
You can save the file in a subdirectory of the directory mentioned above. In that case, you have to include the relative path to the file.

**Manual operation:** See " [Save Standard](#) " on page 233

**12.5.6.2 Controlling the Measurement**

The following commands control the measurement itself.

|                                                   |     |
|---------------------------------------------------|-----|
| <a href="#">INITiate&lt;n&gt;:ESpectrum</a> ..... | 682 |
| <a href="#">[SENSe:]SWEep:MODE</a> .....          | 682 |

**INITiate<n>:ESpectrum**

This command initiates a Spectrum Emission Mask measurement.

**Suffix:**

<n> irrelevant

**Usage:**

Event

**[SENSe:]SWEep:MODE <Mode>**

This command selects the spurious emission and spectrum emission mask measurements.

You can select other measurements with

- [CALCulate<n>:MARKer<m>:FUNCTION:POWER\[:STATe\]](#)

**Parameters:**

<Mode> **AUTO**  
Turns on basic spectrum measurements.

**ESpectrum**  
Turns on spectrum emission mask measurements.

**LIST**  
Turns on spurious emission measurements.

\*RST: AUTO

**12.5.6.3 Configuring a Multi-SEM Measurement**

In the Spectrum application only, spectrum emissions can be measured for multiple sub blocks of channels (see [Chapter 6.5.4.5, "SEM with Multiple Sub Blocks \("Multi-SEM"\)](#)", on page 215). Up to three sub blocks (with two gaps) can be defined. For each sub block, the familiar configuration settings concerning ranges, limit lines etc. can be

defined in individual tabs (select the sub block using the <sb> suffix in the corresponding commands). In addition, settings on the sub blocks themselves must be configured.

Useful commands for multi-SEM measurements described elsewhere:

- [\[SENSe:\]ESpectrum<sb>:RANGe<range>:MLCalc](#) on page 695

#### Remote commands exclusive to multi-SEM measurements

|                                                            |     |
|------------------------------------------------------------|-----|
| <a href="#">[SENSe:]ESpectrum&lt;sb&gt;:SBCenter</a> ..... | 683 |
| <a href="#">[SENSe:]ESpectrum&lt;sb&gt;:SCENter</a> .....  | 683 |
| <a href="#">[SENSe:]ESpectrum&lt;sb&gt;:SBCount</a> .....  | 683 |
| <a href="#">[SENSe:]ESpectrum&lt;sb&gt;:SCOunt</a> .....   | 683 |

---

**[SENSe:]ESpectrum<sb>:SBCenter** <Frequency>

**[SENSe:]ESpectrum<sb>:SCENter** <Frequency>

This command defines the center frequency of the selected sub block in a Multi-SEM measurement.

**Suffix:**

<sb>                    1 | 2 | 3  
Sub block in a Multi-SEM measurement

**Parameters:**

<Frequency>            Frequency within the currently defined global span (see [\[SENSe:\]FREQuency:SPAN](#) on page 779 and [\[SENSe:\]FREQuency:CENTer](#) on page 777).  
Range:                1 to 3  
\*RST:                 1

**Example:**            ESP1:SCEN 1GHZ

**Manual operation:** See " [Sub Block / Center Freq](#) " on page 226

---

**[SENSe:]ESpectrum<sb>:SBCount** <SubBlocks>

**[SENSe:]ESpectrum<sb>:SCOunt** <SubBlocks>

This command defines the number of sub blocks in the SEM measurement. (<sb> is irrelevant)

**Parameters:**

<SubBlocks>            Number of sub blocks in the SEM measurement.  
Range:                1 to 3  
\*RST:                 1

**Example:**            ESP:SCO 2

**Manual operation:** See " [Sub Block Count](#) " on page 225

#### 12.5.6.4 Configuring a Sweep List

The following commands define a sweep list for SEM measurements.



The sweep list cannot be configured using remote commands during an on-going sweep operation.

See also:

- `CALCulate<n>:LIMit<k>:ESpectrum<sb>:PCLass<PClass>:LIMit[:STATE]` on page 702

|                                                                                                               |     |
|---------------------------------------------------------------------------------------------------------------|-----|
| <code>[SENSe:]ESpectrum&lt;sb&gt;:HighSPeed</code> .....                                                      | 684 |
| <code>[SENSe:]ESpectrum&lt;sb&gt;:RANGe&lt;range&gt;:BANDwidth:RESolution</code> .....                        | 685 |
| <code>[SENSe:]ESpectrum&lt;sb&gt;:RANGe&lt;range&gt;:BANDwidth:VIDeo</code> .....                             | 685 |
| <code>[SENSe:]ESpectrum&lt;sb&gt;:RANGe&lt;range&gt;:COUNT?</code> .....                                      | 685 |
| <code>[SENSe:]ESpectrum&lt;sb&gt;:RANGe&lt;range&gt;:DELete</code> .....                                      | 686 |
| <code>[SENSe:]ESpectrum&lt;sb&gt;:RANGe&lt;range&gt;:FILTer:TYPE</code> .....                                 | 686 |
| <code>[SENSe:]ESpectrum&lt;sb&gt;:RANGe&lt;range&gt;[:FREquency]:START</code> .....                           | 687 |
| <code>[SENSe:]ESpectrum&lt;sb&gt;:RANGe&lt;range&gt;[:FREquency]:STOP</code> .....                            | 687 |
| <code>[SENSe:]ESpectrum&lt;sb&gt;:RANGe&lt;range&gt;:INPut:ATTenuation</code> .....                           | 688 |
| <code>[SENSe:]ESpectrum&lt;sb&gt;:RANGe&lt;range&gt;:INPut:ATTenuation:AUTO</code> .....                      | 688 |
| <code>[SENSe:]ESpectrum&lt;sb&gt;:RANGe&lt;range&gt;:INPut:GAIN:STATE</code> .....                            | 689 |
| <code>[SENSe:]ESpectrum&lt;sb&gt;:RANGe&lt;range&gt;:INSert</code> .....                                      | 689 |
| <code>[SENSe:]ESpectrum&lt;sb&gt;:RANGe&lt;range&gt;:LIMit&lt;PClass&gt;:ABSolute:START</code> .....          | 689 |
| <code>[SENSe:]ESpectrum&lt;sb&gt;:RANGe&lt;range&gt;:LIMit&lt;PClass&gt;:ABSolute:STOP</code> .....           | 690 |
| <code>[SENSe:]ESpectrum&lt;sb&gt;:RANGe&lt;range&gt;:LIMit&lt;PClass&gt;:RELative:START</code> .....          | 690 |
| <code>[SENSe:]ESpectrum&lt;sb&gt;:RANGe&lt;range&gt;:LIMit&lt;PClass&gt;:RELative:START:ABS</code> .....      | 691 |
| <code>[SENSe:]ESpectrum&lt;sb&gt;:RANGe&lt;range&gt;:LIMit&lt;PClass&gt;:RELative:START:FUNCTion</code> ..... | 692 |
| <code>[SENSe:]ESpectrum&lt;sb&gt;:RANGe&lt;range&gt;:LIMit&lt;PClass&gt;:RELative:STOP</code> .....           | 692 |
| <code>[SENSe:]ESpectrum&lt;sb&gt;:RANGe&lt;range&gt;:LIMit&lt;PClass&gt;:RELative:STOP:ABS</code> .....       | 693 |
| <code>[SENSe:]ESpectrum&lt;sb&gt;:RANGe&lt;range&gt;:LIMit&lt;PClass&gt;:RELative:STOP:FUNCTion</code> .....  | 694 |
| <code>[SENSe:]ESpectrum&lt;sb&gt;:RANGe&lt;range&gt;:LIMit&lt;PClass&gt;:STATE</code> .....                   | 694 |
| <code>[SENSe:]ESpectrum&lt;sb&gt;:RANGe&lt;range&gt;:POINts:MINimum[:VALue]</code> .....                      | 695 |
| <code>[SENSe:]ESpectrum&lt;sb&gt;:RANGe&lt;range&gt;:MLCalc</code> .....                                      | 695 |
| <code>[SENSe:]ESpectrum&lt;sb&gt;:RANGe&lt;range&gt;:RLEVel</code> .....                                      | 696 |
| <code>[SENSe:]ESpectrum&lt;sb&gt;:RANGe&lt;range&gt;:SWEep:TIME</code> .....                                  | 696 |
| <code>[SENSe:]ESpectrum&lt;sb&gt;:RANGe&lt;range&gt;:SWEep:TIME:AUTO</code> .....                             | 697 |
| <code>[SENSe:]ESpectrum&lt;sb&gt;:RANGe&lt;range&gt;:TRANsducer</code> .....                                  | 697 |

#### `[SENSe:]ESpectrum<sb>:HighSPeed <State>`

This command turns high speed mode for SEM measurements on and off.

For more information including restrictions see [Chapter 6.5.4.3, "Fast SEM Measurements"](#), on page 213.

#### Suffix:

`<sb>`                    1 | 2 | 3  
                              irrelevant

#### Parameters:

`<State>`                ON | OFF | 1 | 0  
                              \*RST:        0

**Example:**            `ESP:HSP ON`

**Manual operation:** See "Fast SEM" on page 221

---

**[SENSe:]ESpectrum<sb>:RANGe<range>:BANDwidth:RESolution <RBW>**

This command defines the resolution bandwidth for a SEM range.

In case of high speed measurements, the resolution bandwidth has to be identical for all ranges.

**Suffix:**

<sb> 1 | 2 | 3  
irrelevant

<range> 1...30  
Selects the measurement range.

**Parameters:**

<RBW> Resolution bandwidth.  
Refer to the data sheet for available resolution bandwidths.  
\*RST: 30.0 kHz  
Default unit: Hz

**Manual operation:** See "RBW" on page 221

---

**[SENSe:]ESpectrum<sb>:RANGe<range>:BANDwidth:VIDeo <VBW>**

This command defines the video bandwidth for a SEM range.

In case of high speed measurements, the video bandwidth has to be identical for all ranges.

**Suffix:**

<sb> 1 | 2 | 3  
irrelevant

<range> 1...30  
Selects the measurement range.

**Parameters:**

<VBW> Video bandwidth.  
Refer to the data sheet for available video bandwidths.  
\*RST: 10.0 MHz  
Default unit: Hz

**Manual operation:** See "VBW" on page 221

---

**[SENSe:]ESpectrum<sb>:RANGe<range>:COUNT? <Ranges>**

This command queries the number of ranges in the sweep list (<range> is irrelevant).

**Suffix:**

<sb> 1 | 2 | 3  
irrelevant

**Return values:**

<Ranges>                      Number of ranges in the sweep list.

**Usage:**                      Query only

**[SENSe:]ESpectrum<sb>:RANGe<range>:DELete**

This command removes a range from the sweep list.

Note that

- you cannot delete the reference range
- a minimum of three ranges is mandatory.

**Suffix:**

<sb>                              1 | 2 | 3  
irrelevant

<range>                        1...30  
Selects the measurement range.

**Usage:**                      Event

**Manual operation:**    See "[Delete Range](#)" on page 224

**[SENSe:]ESpectrum<sb>:RANGe<range>:FILTer:TYPE <FilterType>**

This command selects the filter type for an SEM range.

In case of high speed measurements, the filter has to be identical for all ranges.

**Suffix:**

<sb>                              1 | 2 | 3  
irrelevant

<range>                        1...30  
Selects the measurement range.

**Parameters:**

<FilterType>                **NORMal**  
Gaussian filters

**CFILter**  
channel filters

**RRC**  
RRC filters

**P5**  
5 Pole filters

                                 \*RST:        NORM  
Refer to the datasheet for available filter bandwidths.

**Manual operation:**    See "[Filter Type](#)" on page 221

---

**[SENSe:]ESpectrum<sb>:RANGe<range>[:FREQUENCY]:START <Frequency>**

This command defines the start frequency of a SEM range.

Make sure to set an appropriate span. If you set a span that is

- smaller than the span the SEM sweep list covers, the R&S FPS will not measure the ranges that are outside the span - results may be invalid.
- greater than the span the SEM sweep list covers, the R&S FPS will adjust the start frequency of the first SEM range and the stop frequency of the last SEM range to the span

For more information see [Chapter 6.5.4.1, "Ranges and Range Settings"](#), on page 209.

**Suffix:**

<sb>                    1 | 2 | 3  
                          irrelevant

<range>                1...30  
                          Selects the measurement range.

**Parameters:**

<Frequency>            Numeric value. Note that the minimum frequency range of a SEM range is 20 Hz.  
                          \*RST:            -12.75 MHz (range 1), -2.515 MHz (range 2), 2.515 MHz (range 3)  
                          Default unit: Hz

**Manual operation:**    See "[Range Start / Range Stop](#)" on page 221

---

**[SENSe:]ESpectrum<sb>:RANGe<range>[:FREQUENCY]:STOP <Frequency>**

This command defines the stop frequency of a SEM range.

Make sure to set an appropriate span. If you set a span that is

- smaller than the span the SEM sweep list covers, the R&S FPS will not measure the ranges that are outside the span - results may be invalid.
- greater than the span the SEM sweep list covers, the R&S FPS will adjust the start frequency of the first SEM range and the stop frequency of the last SEM range to the span

For more information see [Chapter 6.5.4.1, "Ranges and Range Settings"](#), on page 209.

**Suffix:**

<sb>                    1 | 2 | 3  
                          irrelevant

<range>                1...30  
                          Selects the measurement range.

**Parameters:**

<Frequency> Numeric value.  
 \*RST: -2.52 MHz (range 1), 2.52 MHz (range 2), 250.0 MHz (range 3)  
 Default unit: Hz

**Manual operation:** See " [Range Start / Range Stop](#) " on page 221

**[SENSe:]ESpectrum<sb>:RANGe<range>:INPut:ATTenuation <Attenuation>**

This command defines the input attenuation for a SEM range.

In case of high speed measurements, the input attenuation has to be identical for all ranges.

**Suffix:**

<sb> 1 | 2 | 3  
 irrelevant

<range> 1...20  
 Selects the measurement range.

**Parameters:**

<Attenuation> Numeric value.  
 Refer to the data sheet for the attenuation range.  
 \*RST: 10 dB  
 Default unit: dB

**Manual operation:** See " [RF Attenuation](#) " on page 222

**[SENSe:]ESpectrum<sb>:RANGe<range>:INPut:ATTenuation:AUTO <State>**

This command turns automatic selection of the input attenuation for a SEM range on and off.

In case of high speed measurements, the input attenuation has to be identical for all ranges.

**Suffix:**

<sb> 1 | 2 | 3  
 irrelevant

<range> 1..30  
 Selects the measurement range.

**Parameters:**

<State> ON | OFF | 0 | 1  
 \*RST: 1

**Example:**

ESP:RANG2:INP:ATT:AUTO OFF  
 Deactivates the RF attenuation auto mode for range 2.

**Manual operation:** See " [RF Att Mode](#) " on page 222



**[SENSe:]ESpectrum<sb>:RANGe<range>:INPut:GAIN:STATe <State>**

This command turns the preamplifier for a SEM range on and off.

In case of high speed measurements, the state of the preamplifier has to be identical for all ranges.

**Suffix:**

<sb> 1 | 2 | 3  
irrelevant

<range> 1..30  
Selects the measurement range.

**Parameters:**

<State> ON | OFF | 1 | 0  
\*RST: 0

**[SENSe:]ESpectrum<sb>:RANGe<range>:INSert <Mode>**

This command inserts a new SEM range and updates the range numbers accordingly.

**Suffix:**

<sb> 1 | 2 | 3  
irrelevant

<range> 1..30  
Selects the SEM range.

**Parameters:**

<Mode> **AFTer**  
Inserts a range after the selected range.  
**BEFore**  
Inserts a range before the selected range.

**Manual operation:** See " [Insert before Range / Insert after Range](#) " on page 224

**[SENSe:]ESpectrum<sb>:RANGe<range>:LIMit<PClass>:ABSolute:STARt <Level>**

This command defines an absolute limit for a SEM range.

Unlike manual operation, you can define an absolute limit anytime and regardless of the limit check mode.

**Suffix:**

<sb> 1 | 2 | 3  
irrelevant

<range> 1..30  
Selects the measurement range.

<PClass> 1..4  
Power class for which the limit is defined.

**Parameters:**

<Level> Absolute limit at the start frequency of a SEM range.  
 Range: -400 to 400  
 \*RST: -13  
 Default unit: dBm

**Example:**

SENSe:ESpectrum:RANGe:LIMit:ABSolute:START -10  
 For a detailed example see [Chapter 12.5.6.11, "Example: SEM Measurement"](#), on page 712.

**Manual operation:** See "[Abs Limit Start / Stop <n>](#)" on page 223

**[SENSe:]ESpectrum<sb>:RANGe<range>:LIMit<PClass>:ABSolute:STOP**  
 <Level>

This command defines an absolute limit for a SEM range.

Unlike manual operation, you can define an absolute limit anytime and regardless of the limit check mode.

**Suffix:**

<sb> 1 | 2 | 3  
 irrelevant

<range> 1..30  
 Selects the measurement range.

<PClass> 1..4  
 Power class for which the limit is defined.

**Parameters:**

<Level> Absolute limit at the stop frequency of a SEM range.  
 Range: -400 to 400  
 \*RST: -13  
 Default unit: dBm

**Example:**

SENSe:ESpectrum:RANGe:LIMit:ABSolute:STOP -15  
 For a detailed example see [Chapter 12.5.6.11, "Example: SEM Measurement"](#), on page 712.

**Manual operation:** See "[Abs Limit Start / Stop <n>](#)" on page 223

**[SENSe:]ESpectrum<sb>:RANGe<range>:LIMit<PClass>:RELative:START** <Limit>

This command defines a relative limit for a SEM range.

Unlike manual operation, you can define a relative limit regardless of the limit check mode.

**Suffix:**

<sb> 1 | 2 | 3  
 irrelevant

<range> 1..30  
Selects the SEM range.

<PClass> 1..4  
Power class for which the limit is defined.

**Parameters:**

<Level> Relative limit at the start frequency of a SEM range.  
Range: -400 to 400  
\*RST: -50  
Default unit: dBc

**Example:** SENS:ESP:RANG:LIM:REL:STAR -10

**Manual operation:** See " [Rel Limit Start / Stop <n>](#) " on page 223

**[SENSe:]ESpectrum<sb>:RANGe<range>:LIMit<PClass>:RELative:STARt:ABS  
<Limit>**

This command defines an absolute limit for the MAX function of the relative limit for a SEM range.

For more information see "[Relative limit line functions](#)" on page 213.

**Suffix:**

<sb> 1 | 2 | 3  
irrelevant

<range> 1..30  
Selects the SEM range.

<PClass> 1..4  
Power class for which the limit is defined.

**Parameters:**

<Level> Absolute limit at the start frequency of a SEM range to be used in addition to the relative limit if the MAX function is enabled (see [\[SENSe:\]ESpectrum<sb>:RANGe<range>:LIMit<PClass>:RELative:STARt:FUNCTION](#) on page 692).  
Range: -400 to 400  
\*RST: -13  
Default unit: dBm

**Example:** SENSe:ESpectrum:RANGe:LIMit:RELative:STARt:  
ABSolute -10

For a detailed example see [Chapter 12.5.6.11, "Example: SEM Measurement"](#), on page 712.

**Manual operation:** See " [Rel Limit Start / Stop <n>](#) " on page 223

---

**[SENSe:]ESpectrum<sb>:RANGe<range>:LIMit<PClass>:RELative:STARt:  
FUNction <Function>**

This command enables the use of a function when defining the relative limit for a SEM range.

**Suffix:**

|          |                                                     |
|----------|-----------------------------------------------------|
| <sb>     | 1   2   3<br>irrelevant                             |
| <range>  | 1..30<br>Selects the SEM range.                     |
| <PClass> | 1..4<br>Power class for which the limit is defined. |

**Parameters:**

<Function> Defines the function to be used to determine the relative limit line start value

**MAX**

The maximum of the relative *and* the absolute level is used as the limit start value. Use the `[SENSe:]ESpectrum<sb>:RANGe<range>:LIMit<PClass>:RELative:STARt` and `[SENSe:]ESpectrum<sb>:RANGe<range>:LIMit<PClass>:RELative:STARt:ABS` commands to define these values.

**OFF**

No function is used, the relative limit line is defined by a fixed relative start value. Use the `[SENSe:]ESpectrum<sb>:RANGe<range>:LIMit<PClass>:RELative:STARt` command to define this value.

\*RST: OFF

**Example:** `SENSe:ESpectrum:RANGe:LIMit:RELative:STARt:  
FUNction MAX`

For a detailed example see [Chapter 12.5.6.11, "Example: SEM Measurement"](#), on page 712.

**Manual operation:** See "[Rel Limit Start / Stop <n>](#)" on page 223

---

**[SENSe:]ESpectrum<sb>:RANGe<range>:LIMit<PClass>:RELative:STOP <Limit>**

This command defines a relative limit for a SEM range.

Unlike manual operation, you can define a relative limit anytime and regardless of the limit check mode.

**Suffix:**

|         |                                 |
|---------|---------------------------------|
| <sb>    | 1   2   3<br>irrelevant         |
| <range> | 1..30<br>Selects the SEM range. |

<PClass> 1..4  
Power class for which the limit is defined.

**Parameters:**

<Level> Relative limit at the stop frequency of a SEM range.  
Range: -400 to 400  
\*RST: -50  
Default unit: dBc

**Example:** SENSE:ESpectrum:RANGe:LIMit:RELative:STOP -15  
For a detailed example see [Chapter 12.5.6.11, "Example: SEM Measurement"](#), on page 712.

**Manual operation:** See "[Rel Limit Start / Stop <n>](#)" on page 223

**[SENSe:]ESpectrum<sb>:RANGe<range>:LIMit<PClass>:RELative:STOP:ABS  
<Limit>**

This command defines an absolute limit for the MAX function of the relative limit for a SEM range.

For more information see "[Relative limit line functions](#)" on page 213.

**Suffix:**

<sb> 1 | 2 | 3  
irrelevant

<range> 1..30  
Selects the SEM range.

<PClass> 1..4  
Power class for which the limit is defined.

**Parameters:**

<Level> Absolute limit at the stop frequency of a SEM range to be used in addition to the relative limit if the MAX function is enabled (see [\[SENSe:\]ESpectrum<sb>:RANGe<range>:LIMit<PClass>:RELative:STOP:FUNCTION](#) on page 694).  
Range: -400 to 400  
\*RST: -13  
Default unit: dBm

**Example:** SENSE:ESpectrum:RANGe:LIMit:RELative:STOP:  
ABSolute -15  
For a detailed example see [Chapter 12.5.6.11, "Example: SEM Measurement"](#), on page 712.

**Manual operation:** See "[Rel Limit Start / Stop <n>](#)" on page 223

---

**[SENSe:]ESpectrum<sb>:RANGe<range>:LIMit<PClass>:RELative:STOP:  
FUNction <Function>**

This command enables the use of a function when defining the relative limit for a SEM range.

**Suffix:**

<sb>                    1 | 2 | 3  
                          irrelevant

<range>                1..30  
                          Selects the SEM range.

<PClass>               1..4  
                          Power class for which the limit is defined.

**Parameters:**

<Function>            Defines the function to be used to determine the relative limit line stop value

**MAX**

The maximum of the relative *and* the absolute level is used as the limit stop value. Use the `[SENSe:]ESpectrum<sb>:RANGe<range>:LIMit<PClass>:RELative:STOP` and `[SENSe:]ESpectrum<sb>:RANGe<range>:LIMit<PClass>:RELative:STOP:ABS` commands to define these values.

**OFF**

No function is used, the relative limit line is defined by a fixed relative stop value. Use the `[SENSe:]ESpectrum<sb>:RANGe<range>:LIMit<PClass>:RELative:STOP` command to define this value.

\*RST:                OFF

**Example:**            SENSe:ESpectrum:RANGe:LIMit:RELative:STOP:  
                          FUNction MAX

For a detailed example see [Chapter 12.5.6.11, "Example: SEM Measurement"](#), on page 712.

**Manual operation:** See "[Rel Limit Start / Stop <n>](#)" on page 223

---

**[SENSe:]ESpectrum<sb>:RANGe<range>:LIMit<PClass>:STATe <State>**

This command selects the limit check mode for *all* SEM ranges (<range> is irrelevant).

**Suffix:**

<sb>                    1 | 2 | 3  
                          irrelevant

<PClass>               1..4  
                          Power class for which the limit is defined.

**Parameters:**

<State> ABSolute | RELative | AND | OR

**ABSolute**

Checks only the absolute limits defined.

**RELative**

Checks only the relative limits. Relative limits are defined as relative to the measured power in the reference range.

**AND**

Combines the absolute and relative limit. The limit check fails when both limits are violated.

**OR**

Combines the absolute and relative limit. The limit check fails when one of the limits is violated.

\*RST: RELative

**Manual operation:** See "[Limit Check <n>](#)" on page 223

**[SENSe:]ESpectrum<sb>:RANGe<range>:POINts:MINimum[:VALue]**  
<SweepPoint>

Defines the minimum number of sweep points for the range.

**Suffix:**

<sb> 1 | 2 | 3  
irrelevant

<range> 1..30  
Selects the measurement range.

**Parameters:**

<SweepPoints> Minimum number of sweep points per range  
Range: 1 to 32001  
\*RST: 1

**Example:** SENSe1:ESpectrum:RANGe3:POINts:MIN:VALue 400

**Manual operation:** See "[Min Sweep Points](#)" on page 224

**[SENSe:]ESpectrum<sb>:RANGe<range>:MLCalc <Function>**

Defines the function used to calculate the limit line for the n-th power class for overlapping ranges in Multi-SEM measurements. For details see "[Limit calculation for individual ranges](#)" on page 217.

**Suffix:**

<sb> 1 | 2 | 3  
Sub block in a Multi-SEM measurement

<range> 1..30  
Selects the measurement range.

**Parameters:**

|            |                                                                                                                                       |
|------------|---------------------------------------------------------------------------------------------------------------------------------------|
| <Function> | <b>NONE</b><br>(reference ranges only:) the limit of the reference range is used;<br>Reference ranges always use the function "NONE". |
|            | <b>SUM</b><br>sum of the two limit lines (calculated for linear powers) is used                                                       |
|            | <b>MAX</b><br>maximum of the two limit lines is used                                                                                  |
|            | *RST: SUM (reference range: NONE)                                                                                                     |

**Manual operation:** See " [Multi-Limit Calc <n>](#) " on page 224

**[SENSe:]ESpectrum<sb>:RANGe<range>:RLEVel <RefLevel>**

This command defines the reference level for a SEM range.

In case of high speed measurements, the reference level has to be identical for all ranges.

**Suffix:**

|         |                                                   |
|---------|---------------------------------------------------|
| <sb>    | 1   2   3<br>Sub block in a Multi-SEM measurement |
| <range> | 1..30<br>Selects the measurement range.           |

**Parameters:**

|            |                                                                            |
|------------|----------------------------------------------------------------------------|
| <RefLevel> | Reference level.<br>Refer to the data sheet for the reference level range. |
|            | *RST: 0 dBm                                                                |

**Manual operation:** See " [Ref Level](#) " on page 222

**[SENSe:]ESpectrum<sb>:RANGe<range>:SWEep:TIME <SweepTime>**

This command defines the sweep time for a SEM range.

In case of high speed measurements, the sweep time has to be identical for all ranges.

**Suffix:**

|         |                                                   |
|---------|---------------------------------------------------|
| <sb>    | 1   2   3<br>Sub block in a Multi-SEM measurement |
| <range> | 1..30<br>Selects the measurement range.           |

**Parameters:**

|             |                                                                                                                                             |
|-------------|---------------------------------------------------------------------------------------------------------------------------------------------|
| <SweepTime> | Sweep time.<br>The range depends on the ratios of the span to the RBW and the RBW to the VBW. Refer to the data sheet for more information. |
|-------------|---------------------------------------------------------------------------------------------------------------------------------------------|

**Manual operation:** See " [Sweep Time](#) " on page 222



**[SENSe:]ESpectrum<sb>:RANGe<range>:SWEp:TIME:AUTO <State>**

This command turns automatic selection of the sweep time for a SEM range on and off.

In case of high speed measurements, the sweep time has to be identical for all ranges.

**Suffix:**

<sb> 1 | 2 | 3  
irrelevant

<range> 1..30  
Selects the measurement range.

**Parameters:**

<State> ON | OFF | 0 | 1  
\*RST: 1

**Example:** ESP:RANG3:SWE:TIME:AUTO OFF  
Deactivates the sweep time auto mode for range 3.

**Manual operation:** See " [Sweep Time Mode](#) " on page 222

**[SENSe:]ESpectrum<sb>:RANGe<range>:TRANsducer <Transducer>**

This command selects a transducer factor for a SEM range.

Note that

- the transducer must cover at least the span of the range
- the x-axis has to be linear
- the unit has to be dB

**Suffix:**

<sb> 1 | 2 | 3  
Sub block in a Multi-SEM measurement

<range> 1..30  
Selects the measurement range.

**Parameters:**

<Transducer> String containing the transducer file name, including the path information.

**Manual operation:** See " [Transducer Factor](#) " on page 222

**12.5.6.5 Configuring the Reference Range**

The following commands define the reference range for the SEM sweep list.

|                                                 |     |
|-------------------------------------------------|-----|
| [SENSe:]ESpectrum<sb>:BWID.....                 | 698 |
| [SENSe:]ESpectrum<sb>:FILTer[:RRC]:ALPHA.....   | 698 |
| [SENSe:]ESpectrum<sb>:FILTer[:RRC][:STATe]..... | 698 |
| [SENSe:]ESpectrum<sb>:RRANge?.....              | 698 |
| [SENSe:]ESpectrum<sb>:RTYPE.....                | 699 |

**[SENSe:]ESpectrum<sb>:BWID <Bandwidth>**

This command defines the channel bandwidth of the reference range.

The bandwidth is available if the power reference is the channel power.

**Suffix:**

<sb> 1 | 2 | 3  
Sub block in a Multi-SEM measurement

**Parameters:**

<Bandwidth> minimum span  $\leq$  value  $\leq$  span of reference range  
\*RST: 3.84 MHz

**Manual operation:** See " [Tx Bandwidth](#) " on page 227

**[SENSe:]ESpectrum<sb>:FILTer[:RRC]:ALPHA <Alpha>**

This command defines the roll-off factor for the RRC filter.

The RRC filter is available if the power reference is the channel power.

**Suffix:**

<sb> 1 | 2 | 3  
Sub block in a Multi-SEM measurement

**Parameters:**

<Alpha> Range: 0 to 1  
\*RST: 0.22

**Manual operation:** See " [Alpha](#) " on page 227

**[SENSe:]ESpectrum<sb>:FILTer[:RRC][:STATe] <State>**

This command turns the RRC filter in the reference range on and off.

The RRC filter is available if the power reference is the channel power.

**Suffix:**

<sb> 1 | 2 | 3  
Sub block in a Multi-SEM measurement

**Parameters:**

<State> ON | OFF | 0 | 1  
\*RST: 1

**Manual operation:** See " [RRC Filter State](#) " on page 227

**[SENSe:]ESpectrum<sb>:RRANge?**

This command queries the reference range.

**Suffix:**

<sb> 1 | 2 | 3  
Sub block in a Multi-SEM measurement

**Return values:**

<RefRange>            Number of the current reference range.  
                           Range:        1 to 30

**Usage:**                Query only

**[SENSe:]ESpectrum<sb>:RTYPE <Type>**

This command defines the type of the power reference.

**Suffix:**

<sb>                    1 | 2 | 3  
                           Sub block in a Multi-SEM measurement

**Parameters:**

<Type>                **PEAK**  
                           Measures the highest peak within the reference range.

**CPOWer**  
                           Measures the channel power within the reference range (integral bandwidth method).

                          \*RST:        CPOWer

**Manual operation:** See " [Power Reference Type](#) " on page 227

**12.5.6.6 Configuring the Power Classes**

The following commands define the power classes for SEM measurements.

|                                                                       |     |
|-----------------------------------------------------------------------|-----|
| CALCulate<n>:LIMit<k>:ESpectrum<sb>:LIMits.....                       | 699 |
| CALCulate<n>:LIMit<k>:ESpectrum<sb>:MODE.....                         | 700 |
| CALCulate<n>:LIMit<k>:ESpectrum<sb>:VALue.....                        | 701 |
| CALCulate<n>:LIMit<k>:ESpectrum<sb>:PCLass:COUNT.....                 | 701 |
| CALCulate<n>:LIMit<k>:ESpectrum<sb>:PCLass<PClass>[:EXCLUSIVE].....   | 702 |
| CALCulate<n>:LIMit<k>:ESpectrum<sb>:PCLass<PClass>:LIMit[:STATE]..... | 702 |
| CALCulate<n>:LIMit<k>:ESpectrum<sb>:PCLass<PClass>:MAXimum.....       | 703 |
| CALCulate<n>:LIMit<k>:ESpectrum<sb>:PCLass<PClass>:MINimum.....       | 703 |

**CALCulate<n>:LIMit<k>:ESpectrum<sb>:LIMits <Max1>,<Max2>,<Max3>**

This command sets or queries up to 4 power classes in one step. You can only define values for the number of power classes defined by [CALCulate<n>:LIMit<k>:ESpectrum<sb>:PCLass:COUNT](#) on page 701.

**Suffix:**

<n>, <k>                irrelevant

<sb>                    1 | 2 | 3  
                           irrelevant

**Setting parameters:**

- <Max1>** Defines the value range for power class 1 as -200 to <Max1>.  
Only available for `CALC:LIM:ESP:PCL:COUNT >=2`  
If only 2 power classes are defined, the value range for power class 2 is defined as <Max1> to 200.  
Range: -199 to + 199
- <Max2>** Defines the value range for power class 2 as <Max1> to <Max2>.  
Only available for `CALC:LIM:ESP:PCL:COUNT >=3`  
If only 3 power classes are defined, the value range for power class 3 is defined as <Max2> to 200.  
Range: -199 to + 199, <Max2> must be higher than <Max1>
- <Max3>** Defines the value range for power class 3 as <Max2> to <Max3>.  
The value range for power class 4 is defined as <Max3> to 200.  
Only available for `CALC:LIM:ESP:PCL:COUNT = 4`  
Range: -199 to + 199, <Max3> must be higher than <Max2>

**Return values:**

- <RangeLimits>** As a result of the query, the range limits including the beginning of the first power class (-200) and the end of the last power class (+200) are indicated.

**Example:**

```
CALC:LIM:ESP:LIM -50,50,70
Defines the following power classes:
<-200, -50>
<-50, 50>
<50, 70>
<70, 200>
Query:
CALC:LIM:ESP:LIM?
Response:
-200,-50,50,70,200
```

**CALCulate<n>:LIMit<k>:ESPectrum<sb>:MODE <Mode>**

Which limit line is to be used for an SEM measurement depends on the power class the input signal power belongs to. This command defines whether the power class is determined automatically or manually.

**Suffix:**

- <n>, <k>** irrelevant
- <sb>** 1 | 2 | 3  
irrelevant

**Parameters:**

&lt;Mode&gt;

**AUTO**

The power class (and thus the limit line) is assigned dynamically according to the currently measured channel power.

**MANUAL**

One of the specified power classes is selected manually for the entire measurement. The selection is made with the

`CALCulate<n>:LIMit<k>:ESpectrum<sb>:PCLass<PClass>[:EXCLusive]` command.

\*RST: AUTO

**Example:**

`CALC:LIM:ESP:MODE AUTO`

Activates automatic selection of the limit line.

**CALCulate<n>:LIMit<k>:ESpectrum<sb>:VALue <Power>**

This command activates the manual limit line selection as and specifies the expected power as a value. Depending on the entered value, the associated predefined limit lines is selected.

This command has the same effect as a combination of the `CALC:LIM:ESP:MODE MAN` and the `CALCulate<n>:LIMit<k>:ESpectrum<sb>:PCLass<PClass>[:EXCLusive]` commands; however, the power class to be used is not defined directly, but via the expected power. As opposed to `CALC:LIM:ESP:MODE AUTO`, the power class is not re-assigned to the input signal power dynamically, but only once when the command is executed.

**Suffix:**

<n>, <k> irrelevant

<sb> 1 | 2 | 3  
irrelevant

**Parameters:**

&lt;Power&gt;

integer

Range: -200 to 199

\*RST: 0

**Example:**

`CALC:LIM:ESP:VAL 33`

Activates manual selection of the limit line and selects the limit line for P = 33.

**CALCulate<n>:LIMit<k>:ESpectrum<sb>:PCLass:COUNT <NoPowerClasses>**

This command sets the number of power classes to be defined.

This command must be executed before any new power class values can be defined using `CALCulate<n>:LIMit<k>:ESpectrum<sb>:PCLass<PClass>:MAXimum` and `CALCulate<n>:LIMit<k>:ESpectrum<sb>:PCLass<PClass>:MINimum`.

**Suffix:**

<n>, <k> irrelevant

<sb> 1 | 2 | 3  
irrelevant

**Parameters:**

<NoPowerClasses> 1 to 4  
\*RST: 1

**Example:**

CALC:LIM:ESP:PCL:COUN 2  
Two power classes can be defined.

**Manual operation:** See "[Adding or Removing a Power Class](#)" on page 229

**CALCulate<n>:LIMit<k>:ESPectrum<sb>:PCLass<PClass>[:EXCLusive] <State>**

This command selects the power class used by the measurement if [CALCulate<n>:LIMit<k>:ESPectrum<sb>:MODE](#) is set to manual.

Note that:

- You can only use power classes for which limits are defined.

**Suffix:**

<n>, <k> irrelevant  
<sb> 1 | 2 | 3  
irrelevant  
<PClass> 1...4  
power class

**Parameters:**

<State> ON | OFF | 1 | 0  
\*RST: 0

**Example:**

CALC:LIM:ESP:PCL1 ON  
Activates the first defined power class.

**Manual operation:** See "[Used Power Classes:](#)" on page 228

**CALCulate<n>:LIMit<k>:ESPectrum<sb>:PCLass<PClass>:LIMit[:STATe] <State>**

This command selects the limit check mode for each power class.

**Suffix:**

<n>, <k> irrelevant  
<sb> 1 | 2 | 3  
irrelevant  
<PClass> 1...4  
power class

**Parameters:**

&lt;State&gt;

**ABSolute**

Evaluates only limit lines with absolute power values

**RELative**

Evaluates only limit lines with relative power values

**AND**

Evaluates limit lines with relative and absolute power values. A negative result is returned if both limits fail.

**OR**

Evaluates limit lines with relative and absolute power values. A negative result is returned if at least one limit failed.

\*RST: REL

**Example:**

CALC:LIM:ESP:PCL:LIM ABS

**Manual operation:** See " [Used Power Classes](#):" on page 228**CALCulate<n>:LIMit<k>:ESPectrum<sb>:PCLass<PClass>:MAXimum <Level>**

This command defines the upper limit of a particular power class.

## Note:

- The last power class always has an upper limit of 200 dBm.
- The upper limit of a power class must always be the same as the lower limit of the subsequent power class.
- The power class must already exist (see [CALCulate<n>:LIMit<k>:ESPectrum<sb>:PCLass:COUNT](#) on page 701).

**Suffix:**

|          |                         |
|----------|-------------------------|
| <n>, <k> | irrelevant              |
| <sb>     | 1   2   3<br>irrelevant |
| <PClass> | 1...4<br>power class    |

**Parameters:**

&lt;Level&gt; Range: -199.9 dBm to 200 dBm

**Example:**

CALC:LIM:ESP:PCL1:MAX -40 dBm

Sets the maximum power value of the first power class to -40 dBm.

**Manual operation:** See " [PMin / PMax](#) " on page 228**CALCulate<n>:LIMit<k>:ESPectrum<sb>:PCLass<PClass>:MINimum <Level>**

This command defines the lower limit of a particular power class.

## Note:

- The first power class always has a lower limit of -200 dBm.

- The lower limit of a power class must always be the same as the upper limit of the previous power class.
- The power class must already exist (see `CALCulate<n>:LIMit<k>:ESpectrum<sb>:PClass:COUNT` on page 701).

**Suffix:**

|          |                         |
|----------|-------------------------|
| <n>, <k> | irrelevant              |
| <sb>     | 1   2   3<br>irrelevant |
| <PClass> | 1...4<br>power class    |

**Parameters:**

<Level> Range: -200 dBm to 199.9 dBm

**Example:**

`CALC:LIM:ESP:PCL2:MIN -40 dBm`

Sets the minimum power value of the second power class to -40 dBm.

**Manual operation:** See " `PMin / PMax` " on page 228

### 12.5.6.7 Configuring MSR SEM Measurements

The following commands configure MSR SEM measurements. For details see [Chapter 6.5.4.4, "Multi-Standard Radio \(MSR\) SEM Measurements"](#), on page 215.

For manual operation see [Chapter 6.5.5.5, "MSR Settings"](#), on page 229.

|                                                                 |     |
|-----------------------------------------------------------------|-----|
| <code>[SENSe:]ESpectrum&lt;sb&gt;:MSR:APPLY</code> .....        | 704 |
| <code>[SENSe:]ESpectrum&lt;sb&gt;:MSR:BAND</code> .....         | 705 |
| <code>[SENSe:]ESpectrum&lt;sb&gt;:MSR:BCATegory</code> .....    | 705 |
| <code>[SENSe:]ESpectrum&lt;sb&gt;:MSR:CLASs</code> .....        | 706 |
| <code>[SENSe:]ESpectrum&lt;sb&gt;:MSR:GSM:CARRier</code> .....  | 707 |
| <code>[SENSe:]ESpectrum&lt;sb&gt;:MSR:GSM:CPResent</code> ..... | 708 |
| <code>[SENSe:]ESpectrum&lt;sb&gt;:MSR:LTE:CPResent</code> ..... | 708 |
| <code>[SENSe:]ESpectrum&lt;sb&gt;:MSR:MPOWER</code> .....       | 709 |
| <code>[SENSe:]ESpectrum&lt;sb&gt;:MSR:RFBWidth</code> .....     | 709 |

---

#### `[SENSe:]ESpectrum<sb>:MSR:APPLY`

This command configures the SEM sweep list according to the MSR settings defined by previous commands.

**Suffix:**

|      |                                                   |
|------|---------------------------------------------------|
| <sb> | 1   2   3<br>Sub block in a Multi-SEM measurement |
|------|---------------------------------------------------|



**Example:**

```
//Select the band category 1
ESP2:MSR:BCAT 1
//Set the base station class to medium range
ESP2:MSR:CLAS MED
//Set the maximum output power to 10 dBm.
ESP2:MSR:MPOW 10
//Set the frequency range of the base station to > 3 GHz
ESP2:MSR:BAND:HIGH
//Set the base station RF bandwidth to 20 MHz
ESP2:MSR:RFBW 20MHZ
//Calculate limits for MSR SEM
ESP2:MSR:APPL
```

**Usage:** Event

**Manual operation:** See "[Apply to SEM](#)" on page 232

### [SENSe:]ESpectrum<sb>:MSR:BAND <Range>

Defines the frequency range of the bands used by the base station.

**Suffix:**

<sb> 1 | 2 | 3  
Sub block in a Multi-SEM measurement

**Parameters:**

<Range> **LOW**  
≤ 3 GHz  
**HIGH**  
> 3 GHz  
**\*RST:** LOW

**Example:**

```
//Select the band category 1
ESP2:MSR:BCAT 1
//Set the base station class to medium range
ESP2:MSR:CLAS MED
//Set the maximum output power to 10 dBm.
ESP2:MSR:MPOW 10
//Set the frequency range of the base station to > 3 GHz
ESP2:MSR:BAND:HIGH
//Set the base station RF bandwidth to 20 MHz
ESP2:MSR:RFBW 20MHZ
//Calculate limits for MSR SEM
ESP2:MSR:APPL
```

**Manual operation:** See "[Bands](#)" on page 231

### [SENSe:]ESpectrum<sb>:MSR:BCATegory <Category>

This command defines the band category for MSR measurements, i.e. the combination of available carriers to measure.

**Suffix:**

<sb> 1 | 2 | 3  
Sub block in a Multi-SEM measurement

**Parameters:**

<Category> 1 | 2 | 3  
**1**  
 2 carriers: LTE FDD and W-CDMA  
**2**  
 3 carriers: LTE FDD, W-CDMA and GSM/EDGE  
**3**  
 2 carriers: LTE TDD and TD-SCDMA  
 \*RST: 1

**Example:**

```
//Select the band category 1
ESP2:MSR:BCAT 1
//Set the base station class to medium range
ESP2:MSR:CLAS MED
//Set the maximum output power to 10 dBm.
ESP2:MSR:MPOW 10
//Set the frequency range of the base station to > 3 GHz
ESP2:MSR:BAND:HIGH
//Set the base station RF bandwidth to 20 MHz
ESP2:MSR:RFBW 20MHZ
//Calculate limits for MSR SEM
ESP2:MSR:APPL
```

**Manual operation:** See "[Band Category](#)" on page 230

**[SENSe:]ESpectrum<sb>:MSR:CLASs <Class>**

Defines the class of the base station according to its sending range.

**Suffix:**

<sb> 1 | 2 | 3  
Sub block in a Multi-SEM measurement

**Parameters:**

<Class> **WIDE**  
Wide Area  
**MEDium**  
Medium Range  
**LOCal**  
Local Area  
 \*RST: WIDE

**Example:**

```
//Select the band category 1
ESP2:MSR:BCAT 1
//Set the base station class to medium range
ESP2:MSR:CLAS MED
//Set the maximum output power to 10 dBm.
ESP2:MSR:MPOW 10
//Set the frequency range of the base station to > 3 GHz
ESP2:MSR:BAND:HIGH
//Set the base station RF bandwidth to 20 MHz
ESP2:MSR:RFBW 20MHZ
//Calculate limits for MSR SEM
ESP2:MSR:APPL
```

**Manual operation:** See " [Base Station Class](#) " on page 230

### [SENSe:]ESpectrum<sb>:MSR:GSM:CARRier <Power>

Defines the power of the GSM carrier (if available, see [\[SENSe:\]ESpectrum<sb>:MSR:GSM:CPResent](#) on page 708).

This command is only available for band category 2 (see [\[SENSe:\]ESpectrum<sb>:MSR:BCATegory](#) on page 705).

#### Suffix:

<sb>                    1 | 2 | 3  
irrelevant

#### Parameters:

<Power>                numeric value  
Range:                0 dBm to 100 dBm  
\*RST:                 39.0 dBm

**Example:**

```
//Select the band category 2
ESP2:MSR:BCAT BC2
//Set the base station class to medium range
ESP2:MSR:CLAS MED
//Set the maximum output power to 10 dBm.
ESP2:MSR:MPOW 10
//Set the base station RF bandwidth to 20 MHz
ESP2:MSR:RFBW 20MHZ
//GSM/Edge present
ESP2:MSR:GSM:CPR ON
//Power of the GSM carrier is 20dBm
ESP2:MSR:GSM:CARR 20
//Calculate limits for MSR SEM
ESP2:MSR:APPL
```

**Manual operation:** See " [Power Gsm Carrier](#) " on page 231

**[SENSe:]ESpectrum<sb>:MSR:GSM:CPResent <State>**

This command defines whether a GSM/Edge carrier is located at the edge of the specified RF bandwidth. In this case, the specification demands specific limits for the SEM ranges.

This command is only available for band category 2 (see [SENSe:]ESpectrum<sb>:MSR:BCATegory on page 705).

**Suffix:**

<sb>                    1 | 2 | 3  
                          irrelevant

**Parameters:**

<State>                ON | OFF | 1 | 0  
\*RST:                 0

**Example:**

```
//Select the band category 2
ESP2:MSR:BCAT BC2
//Set the base station class to medium range
ESP2:MSR:CLAS MED
//Set the maximum output power to 10 dBm.
ESP2:MSR:MPOW 10
//Set the base station RF bandwidth to 20 MHz
ESP2:MSR:RFBW 20MHZ
//GSM/Edge present
ESP2:MSR:GSM:CPR ON
//Power of the GSM carrier is 20dBm
ESP2:MSR:GSM:CARR 20
```

**Manual operation:** See " [Carrier Adjacent to RF Bandwidth Edge](#) " on page 231

**[SENSe:]ESpectrum<sb>:MSR:LTE:CPResent <State>**

This command defines whether an LTE FDD 1.4 MHz or 3 MHz carrier is located at the edge of the specified RF bandwidth. In this case, the specification demands specific limits for the SEM ranges.

This command is only available for band category 2 (see [SENSe:]ESpectrum<sb>:MSR:BCATegory on page 705).

**Suffix:**

<sb>                    1 | 2 | 3  
                          irrelevant

**Parameters:**

<State>                ON | OFF | 1 | 0  
\*RST:                 0

**Example:**

```
//Select the band category 2
ESP2:MSR:BCAT BC2
//Set the base station class to medium range
ESP2:MSR:CLAS MED
//Set the maximum output power to 10 dBm.
ESP2:MSR:MPOW 10
//Set the base station RF bandwidth to 20 MHz
ESP2:MSR:RFBW 20MHZ
//LTE present
ESP2:MSR:LTE:CPR ON
//Calculate limits for MSR SEM
ESP2:MSR:APPL
```

**Manual operation:** See "[Carrier Adjacent to RF Bandwidth Edge](#)" on page 231

**[SENSe:]ESpectrum<sb>:MSR:MPOWer <Power>**

Defines the maximum output power of the base station.

This setting is only available for base stations with a medium range base station class (see [\[SENSe:\]ESpectrum<sb>:MSR:CLASs](#) on page 706).

**Suffix:**

<sb> 1 | 2 | 3  
Sub block in a Multi-SEM measurement

**Parameters:**

<Power> Range: 0 dBm to 100 dBm  
Increment: 1 dB

**Example:**

```
//Select the band category 1
ESP2:MSR:BCAT 1
//Set the base station class to medium range
ESP2:MSR:CLAS MED
//Set the maximum output power to 10 dBm.
ESP2:MSR:MPOW 10
//Set the frequency range of the base station to > 3 GHz
ESP2:MSR:BAND:HIGH
//Set the base station RF bandwidth to 20 MHz
ESP2:MSR:RFBW 20MHZ
```

**Manual operation:** See "[Base Station Maximum Output Power](#)" on page 231

**[SENSe:]ESpectrum<sb>:MSR:RFBWidth <Bandwidth>**

This command defines the RF bandwidth of the base station for MSR measurements.

**Suffix:**

<sb> 1 | 2 | 3  
Sub block in a Multi-SEM measurement

**Parameters:**

<Bandwidth>            Bandwidth in Hz  
 \*RST:            10.0 MHz

**Example:**

```
//Select the band category 1
ESP2:MSR:BCAT 1
//Set the base station class to medium range
ESP2:MSR:CLAS MED
//Set the maximum output power to 10 dBm.
ESP2:MSR:MPOW 10
//Set the frequency range of the base station to > 3 GHz
ESP2:MSR:BAND:HIGH
//Set the base station RF bandwidth to 20 MHz
ESP2:MSR:RFBW 20MHZ
//Calculate limits for MSR SEM
ESP2:MSR:APPL
```

**Manual operation:** See "[Base Station RF Bandwidth](#)" on page 231

**12.5.6.8 Configuring the List Evaluation**

The following commands configure the list evaluation.

**Useful commands for SEM measurements described elsewhere**

- [MMEMoRY:STORe<n>:LIST](#) on page 963

**Remote commands exclusive to SEM measurements**

|                                                                           |     |
|---------------------------------------------------------------------------|-----|
| <a href="#">CALCulate&lt;n&gt;:ESpectrum:PSEarch:AUTO</a> .....           | 710 |
| <a href="#">CALCulate&lt;n&gt;:ESpectrum:PEAKsearch:AUTO</a> .....        | 710 |
| <a href="#">CALCulate&lt;n&gt;:ESpectrum:PSEarch[:IMMEDIATE]</a> .....    | 711 |
| <a href="#">CALCulate&lt;n&gt;:ESpectrum:PEAKsearch[:IMMEDIATE]</a> ..... | 711 |
| <a href="#">CALCulate&lt;n&gt;:ESpectrum:PSEarch:MARGIN</a> .....         | 711 |
| <a href="#">CALCulate&lt;n&gt;:ESpectrum:PEAKsearch:MARGIN</a> .....      | 711 |
| <a href="#">CALCulate&lt;n&gt;:ESpectrum:PSEarch:PSHOW</a> .....          | 711 |
| <a href="#">CALCulate&lt;n&gt;:ESpectrum:PEAKsearch:PSHOW</a> .....       | 711 |

---

**CALCulate<n>:ESpectrum:PSEarch:AUTO <State>**

**CALCulate<n>:ESpectrum:PEAKsearch:AUTO <State>**

This command turns the list evaluation on and off.

**Suffix:**

<n>            [Window](#)

<m>            [Marker](#)

**Parameters:**

<State>            ON | OFF | 0 | 1  
 \*RST:            1

**Example:** `CALC:ESP:PSE:AUTO OFF`  
Deactivates the list evaluation.

**Manual operation:** See "[List Evaluation State \(Result Summary\)](#)" on page 234  
See "[List Evaluation State](#)" on page 257

**CALCulate<n>:ESpectrum:PSEarch[:IMMediate]**  
**CALCulate<n>:ESpectrum:PEAKsearch[:IMMediate]**

This command initiates a list evaluation.

**Suffix:**  
<n> [Window](#)  
<m> [Marker](#)

**Usage:** Event

**CALCulate<n>:ESpectrum:PSEarch:MARGin <Threshold>**  
**CALCulate<n>:ESpectrum:PEAKsearch:MARGin <Threshold>**

This command defines the threshold of the list evaluation.

**Suffix:**  
<n> [Window](#)  
<m> [Marker](#)

**Parameters:**  
<Margin> Range: -200 to 200  
\*RST: 200  
Default unit: dB

**Example:** `CALC:ESP:PSE:MARG 100`  
Sets the margin to 100 dB.

**Manual operation:** See "[Margin](#)" on page 235  
See "[Margin](#)" on page 257

**CALCulate<n>:ESpectrum:PSEarch:PSHow <State>**  
**CALCulate<n>:ESpectrum:PEAKsearch:PSHow <State>**

This command turns the peak labels in the diagram on and off.

Peak labels are blue squares.

**Suffix:**  
<n> [Window](#)  
<m> [Marker](#)

**Parameters:**  
<State> ON | OFF | 1 | 0  
\*RST: 0

**Example:**                    CALC:ESP:PSE:PSH ON  
Marks all peaks with blue squares.

**Manual operation:** See " Show Peaks " on page 234  
See " Show Peaks " on page 257

### 12.5.6.9 Performing an SEM Measurement

The following commands are required to perform an SEM measurement:

- SENS:SWE:MODE ESP, see [SENSe:]SWEep:MODE on page 682
- INITiate<n>[:IMMediate] on page 636

### 12.5.6.10 Retrieving Results

The following commands analyze and retrieve measurement results for SEM measurements.

- CALCulate<n>:LIMit<k>:FAIL? on page 932
- TRACe<n>[:DATA] on page 854
- TRACe<n>[:DATA]:MEMory? on page 856
- TRACe<n>[:DATA]:X? on page 856
- CALCulate<n>:MARKer<m>:FUNction:POWer<sb>:RESult? on page 637

### 12.5.6.11 Example: SEM Measurement

In this example we will configure and perform an SEM measurement. Note that this example is primarily meant to demonstrate the remote control commands, it does not necessarily reflect a useful measurement task. For most common measurement standards, the R&S FPS performs the measurement optimally with the predefined settings, without further configuration.

```
//-----Preparing the measurement -----
//Reset the instrument
*RST

//----- Preparing the measurement-----
//Activate SEM Measurement
SWE:MODE ESP

//Selects single sweep mode.
//SEM has to be in single sweep mode to be configured and no sweep operation
//may be running!
// If required, a sweep stop can be ensured by INIT:IMM;*WAI
INIT:CONT OFF

//----- Managing Measurement Configurations-----
//Load the 3GPP configuration stored in the file '3GPP_UL.xml'
```



```

ESP:PRES 'WCDMA\3GPP\UL\3GPP_UL.xml'

//----- Defining the Reference Range-----
//Query the current reference range.
ESP:RRAN?
//Select the channel power as the power reference.
ESP:RTYP CPOW
//Define a channel bandwidth of 4 MHz for the power reference.
ESP:BWID 4 MHZ
//Use an RRC filter with a roll-off factor of 0.5 when measuring
//the reference power.
ESP:FILT:RRC ON
ESP:FILT:ALPH 0.5

//----- Configuring Power Classes-----
//Define 3 power classes.
CALC:LIM:ESP:PCL:COUN 3
//Define the value ranges of the three power classes as [dBm]:
//power class 1: -200 to -100
//power class 2: -100 to 0
//power class 3: 0 to 200
CALC:LIM:ESP:LIM -100,0
//Define an absolute limit check for class 1.
CALC:LIM:ESP:PCL1:LIM ABS
//Define a relative limit check for class 2.
CALC:LIM:ESP:PCL2:LIM REL
//Define a manual selection of the power class.
CALC:LIM:ESP:MODE MAN
//Activate the use of the second power class for the entire measurement.
CALC:LIM:ESP:PCL2 ON

//----- Configuring a Sweep List-----
//Insert a range after range 2.
ESP:RANG2:INS AFT
//Insert a range before range 1.
ESP:RANG1:INS BEF
//Query the number of measurement ranges in the sweep list (currently 11).
ESP:RANG:COUNT?
//Delete the 11th range.
ESP:RANG5:DEL

//Define a stop frequency of -9 MHz for range 1.
ESP:RANG1:STOP -10000000

//Define a start frequency of -10 MHz for range 2.
ESP:RANG2:STAR -9000000

//Switch off Fast SEM mode so the ranges can be configured individually.
ESP:HSP OFF

```

```

//Define a resolution bandwidth of 1 MHz for range 2.
ESP:RANG2:BAND:RES 1000000

//Select an RRC filter for range 2.
ESP:RANG2:FILT:TYPE RRC

//Define a video bandwidth of 5 MHz for range 2.
ESP:RANG2:BAND:VID 5000000
//Define a sweep time of 1 second for range 2.
ESP:RANG2:SWE:TIME 1
//Define a reference level of 0 dBm for range 2.
ESP:RANG2:RLEV 0
//Define an input attenuation of 10 dB for range 2.
ESP:RANG2:INP:ATT 10

// Create a transducer that can be used.
// It has to cover the corresponding frequency range

SENSE1:CORREction:TRANsducer:SElect 'Transducer'
SENSE1:CORREction:TRANsducer:UNIT 'DB'
SENSE1:CORREction:TRANsducer:COMment 'Test Transducer'
// Frequency Span 0 MHz bis 20 Ghz
SENSE1:CORREction:TRANsducer:DATA 0e6,5, 20e9,3

//Include a transducer called 'transducer' for range 2.
ESP:RANG2:TRAN 'Transducer'

//----- Configuring the limit check-----

//Check the absolute and relative limits for all ranges in power class 1 and
//fails if both limits are violated. Since power class 2 is set to be used for
//the entire measurement, values for Limit Check 1 are irrelevant. They are
//defined here to demonstrate the use of the MAX function for relative limits.
ESP:RANG:LIM1:STAT AND
//Enable the use of maximum function for relative limit start. If the value
//exceeds the larger of the absolute (-13 dBm) and relative (-10 dBc) start
//values, the check fails.
ESP:RANG2:LIM1:REL:STAR:FUNC MAX
ESP:RANG2:LIM1:REL:STAR -10
ESP:RANG2:LIM1:REL:STAR:ABS -13
ESP:RANG2:LIM1:REL:STOP:FUNC MAX
ESP:RANG2:LIM1:REL:STOP -10
ESP:RANG2:LIM1:REL:STOP:ABS -13

//Check the absolute and relative limits for all ranges in power class 2 and
//fails if either limit is violated. Since power class 2 is set to be used for
//the entire measurement, values for Limit Check 1 are irrelevant.
ESP:RANG:LIM2:STAT OR
//Define an absolute limit of 10 dBm for the entire range 2 for power class 2.

```

```

ESP:RANG2:LIM2:ABS:STAR 10
ESP:RANG2:LIM2:ABS:STOP 10
//Define a relative limit of -20 dBc for the entire range 2 for power class 2.
ESP:RANG2:LIM2:REL:STAR -20
ESP:RANG2:LIM2:REL:STOP -20

//----- Configuring List Evaluation-----
//Activate list evaluation, i.e. the peak is determined for each range
//after each sweep.
CALC:ESP:PSE:AUTO ON
//Define a peak threshold of 10 dB.
CALC:ESP:PSE:MARG 10dB

//----- Managing Measurement Configurations-----

//Save the current configuration in a new file named '3GPP_UL_User'
//in the same directory so the standard is not overwritten.
ESP:PRES:STOR 'WCDMA\3GPP\UL\3GPP_UL_User.xml'

//----- Performing the measurement-----
//One sweep
INIT:ESP

//----- Checking the Results-----
//Query the result of the limit check for all ranges.
CALC:LIM:FAIL?
//Query the peak for each range of the SEM measurement as a list.
TRAC:DATA? LIST

```

## 12.5.7 Measuring Spurious Emissions

All remote control commands specific to spurious emissions measurements are described here.

- [Initializing the Measurement](#)..... 715
- [Configuring a Sweep List](#)..... 716
- [Configuring the List Evaluation](#)..... 723
- [Performing a Spurious Measurement](#)..... 725
- [Retrieving and Saving Settings and Results](#)..... 725
- [Programming Example: Spurious Emissions Measurement](#)..... 726

### 12.5.7.1 Initializing the Measurement

Note that with the R&S FPS, the spurious measurement must be initialized before you can start configuring the sweep list or list evaluation.

- [INITiate<n>:SPURious](#)..... 716

**INITiate<n>:SPURious**

This command initiates a Spurious Emission measurement.

**Suffix:**

<n> irrelevant

**Usage:**

Event

**12.5.7.2 Configuring a Sweep List**

The following commands configure the sweep list for spurious emission measurements.



The sweep list cannot be configured using remote commands during an on-going sweep operation.

Useful commands for configuring the sweep described elsewhere:

- [SENSe:]SWEep:MODE on page 682

**Remote commands exclusive to spurious measurements:**

|                                                       |     |
|-------------------------------------------------------|-----|
| [SENSe:]LIST:RANGe<range>:BANDwidth:RESolution.....   | 716 |
| [SENSe:]LIST:RANGe<range>:BANDwidth:VIDeo.....        | 717 |
| [SENSe:]LIST:RANGe<range>:BREak.....                  | 717 |
| [SENSe:]LIST:RANGe<range>:COUNT?.....                 | 717 |
| [SENSe:]LIST:RANGe<range>:DELeTe.....                 | 717 |
| [SENSe:]LIST:RANGe<range>:DETEctor.....               | 718 |
| [SENSe:]LIST:RANGe<range>:FILTer:TYPE.....            | 718 |
| [SENSe:]LIST:RANGe<range>[:FREQuency]:STARt.....      | 719 |
| [SENSe:]LIST:RANGe<range>[:FREQuency]:STOP.....       | 719 |
| [SENSe:]LIST:RANGe<range>:INPut:ATTenuation.....      | 720 |
| [SENSe:]LIST:RANGe<range>:INPut:ATTenuation:AUTO..... | 720 |
| [SENSe:]LIST:RANGe<range>:LIMit:STARt.....            | 720 |
| [SENSe:]LIST:RANGe<range>:LIMit:STATe.....            | 721 |
| [SENSe:]LIST:RANGe<range>:LIMit:STOP.....             | 721 |
| [SENSe:]LIST:RANGe<range>:POINts.....                 | 721 |
| [SENSe:]LIST:RANGe<range>:RLEVel.....                 | 722 |
| [SENSe:]LIST:RANGe<range>:SWEep:TIME.....             | 722 |
| [SENSe:]LIST:RANGe<range>:SWEep:TIME:AUTO.....        | 722 |
| [SENSe:]LIST:RANGe<range>:TRANsducer.....             | 723 |

**[SENSe:]LIST:RANGe<range>:BANDwidth:RESolution <RBW>**

This command defines the resolution bandwidth for a spurious emission measurement range.

**Suffix:**

<range> 1..30

Selects the measurement range.

**Parameters:**

<RBW> Resolution bandwidth.  
Refer to the data sheet for available resolution bandwidths.  
Default unit: Hz

**Manual operation:** See " [RBW](#) " on page 254

**[SENSe:]LIST:RANGe<range>:BANDwidth:VIDeo <VBW>**

This command defines the video bandwidth for a spurious emission measurement range.

**Suffix:**

<range> 1..30  
Selects the measurement range.

**Parameters:**

<VBW> Video bandwidth.  
Refer to the data sheet for available video bandwidths.  
Default unit: Hz

**Manual operation:** See " [VBW](#) " on page 254

**[SENSe:]LIST:RANGe<range>:BREak <State>**

This command controls the sweep (for all ranges, <range> is irrelevant).

**Parameters:**

<State> **ON | 1**  
The R&S FPS stops after measuring one range.  
To continue with the next range, you have to use [INITiate<n>:CONMeas.](#)

**OFF | 0**  
The R&S FPS sweeps all ranges in one go.  
\*RST: 0

**Manual operation:** See " [Stop After Sweep](#) " on page 255

**[SENSe:]LIST:RANGe<range>:COUNT?**

This command queries the number of ranges in the sweep list (<range> is irrelevant).

**Return values:**

<Ranges> Number of ranges in the sweep list.

**Usage:** Query only

**[SENSe:]LIST:RANGe<range>:DElete**

This command removes a range from the sweep list.

Note that

- you cannot delete the reference range
- a minimum of three ranges is mandatory.

**Suffix:**

<range>                    1..30  
Selects the measurement range.

**Usage:**                    Event

**[SENSe:]LIST:RANGe<range>:DETEctor <Detector>**

This command selects the detector for a spurious emission measurement range.

**Suffix:**

<range>                    1..30  
Selects the measurement range.

**Parameters:**

<Detector>                **APEak**  
Autopeak

**NEGative**  
minimum peak detector

**POSitive**  
peak detector

**SAMPlE**  
sample detector

**RMS**  
RMS detector

**AVERage**  
average detector

\*RST:                    RMS

**Manual operation:** See " [Detector](#) " on page 254

**[SENSe:]LIST:RANGe<range>:FILTEr:TYPE <FilterType>**

This command selects the filter type for a spurious emission measurement range.

**Suffix:**

<range>                    1..30  
Selects the measurement range.

**Parameters:**

&lt;FilterType&gt;

**NORMAL**

Gaussian filters

**CFILTER**

channel filters

**RRC**

RRC filters

**P5**

5 Pole filters

\*RST: NORM

The available bandwidths of the filters are specified in the data sheet.

**Manual operation:** See " [Filter Type](#) " on page 253

**[SENSe:]LIST:RANGe<range>[:FREQUENCY]:START** <Frequency>

This command defines the start frequency of a spurious emission measurement range.

Make sure to set an appropriate span. If you set a span that is

- smaller than the span the sweep list covers, the R&S FPS will not measure the ranges that are outside the span - results may be invalid.
- greater than the span the sweep list covers, the R&S FPS will adjust the start frequency of the first range and the stop frequency of the last range to the span

For more information see [Chapter 6.6, "Spurious Emissions Measurement"](#), on page 248.

**Suffix:**

&lt;range&gt;

1..30

Selects the measurement range.

**Parameters:**

&lt;Frequency&gt;

Numeric value.

\*RST: -12.75 MHz (range 1), -2.515 MHz (range 2), 2.515 MHz (range 3)

Default unit: Hz

**Manual operation:** See " [Range Start / Range Stop](#) " on page 253

**[SENSe:]LIST:RANGe<range>[:FREQUENCY]:STOP** <Frequency>

This command defines the stop frequency of a spurious emission measurement range.

Make sure to set an appropriate span. If you set a span that is

- smaller than the span the sweep list covers, the R&S FPS will not measure the ranges that are outside the span - results may be invalid.
- greater than the span the sweep list covers, the R&S FPS will adjust the start frequency of the first range and the stop frequency of the last range to the span

For more information see [Chapter 6.6, "Spurious Emissions Measurement"](#), on page 248 .

**Suffix:**

<range> 1..30  
Selects the measurement range.

**Parameters:**

<Frequency> Numeric value.  
\*RST: -2.52 MHz (range 1), 2.52 MHz (range 2), 250.0 MHz (range 3)  
Default unit: Hz

**Manual operation:** See "[Range Start / Range Stop](#)" on page 253

**[SENSe:]LIST:RANGe<range>:INPut:ATTenuation <Attenuation>**

This command defines the input attenuation for a spurious emission measurement range.

**Suffix:**

<range> 1..30  
Selects the measurement range.

**Parameters:**

<Attenuation> Numeric value.  
Refer to the data sheet for the attenuation range.  
\*RST: 10 dB  
Default unit: dB

**Manual operation:** See "[RF Attenuation](#)" on page 255

**[SENSe:]LIST:RANGe<range>:INPut:ATTenuation:AUTO <State>**

This command turns automatic selection of the input attenuation for a spurious emission measurement range on and off.

**Suffix:**

<range> 1..30  
Selects the measurement range.

**Parameters:**

<State> ON | OFF | 0 | 1  
\*RST: 1

**Manual operation:** See "[RF Attenuation Mode](#)" on page 255

**[SENSe:]LIST:RANGe<range>:LIMit:STARt <Level>**

This command defines an absolute limit for a spurious emission measurement range.



**Suffix:**

<range> 1..30  
Selects the measurement range.

**Parameters:**

<Level> Absolute limit at the start frequency of a SEM range.  
Range: -400 to 400  
\*RST: 13  
Default unit: dBm

**Manual operation:** See "[Abs Limit Start / Abs Limit Stop](#)" on page 256

**[SENSe:]LIST:RANGe<range>:LIMit:STATe**

This command turns the limit check for all spurious emission measurement ranges on and off (<range> is irrelevant).

**Parameters:**

<State> ON | OFF | 1 | 0  
\*RST: 0

**Manual operation:** See "[Limit Check](#)" on page 255

**[SENSe:]LIST:RANGe<range>:LIMit:STOP <Level>**

This command defines an absolute limit for a spurious emission measurement range.

**Suffix:**

<range> 1..30  
Selects the measurement range.

**Parameters:**

<Level> Absolute limit at the stop frequency of a SEM range.  
Range: -400 to 400  
\*RST: 13  
Default unit: dBm

**Manual operation:** See "[Abs Limit Start / Abs Limit Stop](#)" on page 256

**[SENSe:]LIST:RANGe<range>:POINts <Points>**

This command defines the number of sweep points in a spurious emission measurement range.

**Suffix:**

<range> 1..30  
Selects the measurement range.

**Parameters:**

<Points> For more information on sweep points see [Chapter 7.5.1.8, "How Much Data is Measured: Sweep Points and Sweep Count"](#), on page 365.

\*RST: 1001

**Manual operation:** See "[Sweep Points](#)" on page 255

**[SENSe:]LIST:RANGe<range>:RLEVel <RefLevel>**

This command defines the reference level for a spurious emission measurement range.

**Suffix:**

<range> 1..30  
Selects the measurement range.

**Parameters:**

<RefLevel> Reference level.  
Refer to the data sheet for the reference level range.

\*RST: 0 dBm

**Manual operation:** See "[Reference Level](#)" on page 254

**[SENSe:]LIST:RANGe<range>:SWEep:TIME <SweepTime>**

This command defines the sweep time for a spurious emission measurement range.

**Suffix:**

<range> 1..30  
Selects the measurement range.

**Parameters:**

<SweepTime> Sweep time.  
The range depends on the ratios of the span to the RBW and the RBW to the VBW. Refer to the data sheet for more information.

**Manual operation:** See "[Sweep Time](#)" on page 254

**[SENSe:]LIST:RANGe<range>:SWEep:TIME:AUTO <State>**

This command turns automatic selection of the sweep time for a spurious emission measurement range on and off.

**Suffix:**

<range> 1..30  
Selects the measurement range.

**Parameters:**

<State> ON | OFF | 0 | 1  
\*RST: 1

**Manual operation:** See " [Sweep Time Mode](#) " on page 254

---

**[SENSe:]LIST:RANGe<range>:TRANsducer <Transducer>**

This command selects a transducer factor for a spurious emission measurement range.

Note that

- the transducer must cover at least the span of the range
- the x-axis has to be linear
- the unit has to be dB

**Suffix:**

<range>                      1..30  
Selects the measurement range.

**Parameters:**

<Transducer>                String containing the transducer file name, including the path information.

**Manual operation:** See " [Transducer](#) " on page 255

### 12.5.7.3 Configuring the List Evaluation

The following commands configure the list evaluation.

**Useful commands for spurious emission measurements described elsewhere**

- [MMEMory:STORe<n>:LIST](#) on page 963

**Remote commands exclusive to spurious emission measurements**

|                                                                       |     |
|-----------------------------------------------------------------------|-----|
| <a href="#">CALCulate&lt;n&gt;:PSEarch:AUTO</a> .....                 | 723 |
| <a href="#">CALCulate&lt;n&gt;:PEAKsearch:AUTO</a> .....              | 723 |
| <a href="#">CALCulate&lt;n&gt;:PSEarch:DETails</a> .....              | 724 |
| <a href="#">CALCulate&lt;n&gt;:ESPectrum:PEAKsearch:DETails</a> ..... | 724 |
| <a href="#">CALCulate&lt;n&gt;:PSEarch:MARGin</a> .....               | 724 |
| <a href="#">CALCulate&lt;n&gt;:PEAKsearch:MARGin</a> .....            | 724 |
| <a href="#">CALCulate&lt;n&gt;:PSEarch:PSHow</a> .....                | 724 |
| <a href="#">CALCulate&lt;n&gt;:PEAKsearch:PSHow</a> .....             | 724 |
| <a href="#">CALCulate&lt;n&gt;:PSEarch:SUBRanges</a> .....            | 725 |
| <a href="#">CALCulate&lt;n&gt;:PEAKsearch:SUBRanges</a> .....         | 725 |

---

**CALCulate<n>:PSEarch:AUTO <State>**

**CALCulate<n>:PEAKsearch:AUTO <State>**

This command turns the list evaluation on and off.

**Suffix:**

<n>                              [Window](#)

**Parameters:**

<State> ON | OFF | 0 | 1  
 \*RST: 1

**Example:**

CALC:PSE:AUTO OFF  
 Deactivates the list evaluation.

**CALCulate<n>:PSEarch:DEtails <State>**

**CALCulate<n>:ESPectrum:PEAKsearch:DEtails <State>**

This command configures how detailed the list in the Result Summary is.

**Suffix:**

<n> [Window](#)

**Parameters:**

<State> ON | OFF | 1 | 0  
**ON | 1**

Includes all detected peaks (up to a maximum defined by [CALCulate<n>:PEAKsearch:SUBRanges](#) on page 725).

**OFF | 0**

Includes only one peak per range.

\*RST: 0

**Example:**

CALC:ESP:PSE:DET ON  
 CALC:PSE:SUBR 10  
 Includes up to 10 peaks per range in the list.

**Usage:**

Event

**Manual operation:** See "[Details](#)" on page 257

**CALCulate<n>:PSEarch:MARGin <Threshold>**

**CALCulate<n>:PEAKsearch:MARGin <Threshold>**

This command defines the threshold of the list evaluation.

**Suffix:**

<n> [Window](#)

**Parameters:**

<Margin> Range: -200 to 200  
 \*RST: 200  
 Default unit: dB

**Example:**

CALC:PSE:MARG 100  
 Sets the threshold to 100 dB.

**CALCulate<n>:PSEarch:PSHow <State>**

**CALCulate<n>:PEAKsearch:PSHow <State>**

This command turns the peak labels in the diagram on and off.

Peak labels are blue squares.

**Suffix:**

<n> [Window](#)

**Parameters:**

<State> ON | OFF | 1 | 0

\*RST: 0

**Example:**

CALC:PSE:PSH ON

Marks all peaks with blue squares.

**CALCulate<n>:PSEarch:SUBRanges <NumberPeaks>**

**CALCulate<n>:PEAKsearch:SUBRanges <NumberPeaks>**

This command defines the number of peaks included in the peak list.

After this number of peaks has been found, the R&S FPS stops the peak search and continues the search in the next measurement range.

**Suffix:**

<n> [Window](#)

**Parameters:**

<NumberPeaks> Range: 1 to 50

\*RST: 25

**Example:**

CALC:PSE:SUBR 10

Sets 10 peaks per range to be stored in the list.

**Manual operation:** See "[Peaks per Range](#)" on page 258

#### 12.5.7.4 Performing a Spurious Measurement

The following commands are required to perform a Spurious measurement:

SENS:SWE:MODE LIST, see [[SENSe:](#)] [SWEep:MODE](#) on page 682

[INITiate<n>\[:IMMediate\]](#) on page 636, see [Chapter 12.5.1, "Performing Measurements"](#), on page 633

#### 12.5.7.5 Retrieving and Saving Settings and Results

The following commands analyze and retrieve measurement results for Spurious measurements.

**Useful commands for spurious emission measurements described elsewhere**

- [CALCulate<n>:LIMit<k>:FAIL?](#) on page 932
- [TRACe<n>\[:DATA\]](#) on page 854
- [TRACe<n>\[:DATA\]:MEMory?](#) on page 856
- [TRACe<n>\[:DATA\]:X?](#) on page 856

### 12.5.7.6 Programming Example: Spurious Emissions Measurement

In the following example, the Spurious Emissions measurement is configured by defining ranges and parameters to create the following sweep list.

| Spurious Emissions |          |             |             |
|--------------------|----------|-------------|-------------|
|                    | Range 1  | Range 2     | Range 3     |
| Range Start        | 10 MHz   | 100 MHz     | 100.0000... |
| Range Stop         | 100 MHz  | 100.0000... | 1 GHz       |
| Filter Type        | RRC      | Normal(3... | Normal(3... |
| Res BW             | 24.3 kHz | 10 kHz      | 100 kHz     |
| Video BW           | 5 MHz    | 30 kHz      | 300 kHz     |
| Sweep Time Mode    | Manual   | Auto        | Auto        |
| Sweep Time         | 1 s      | 4.01 ms     | 32.1 ms     |
| Detector           | Sample   | RMS         | RMS         |
| Ref. Level         | -20 dBm  | 0 dBm       | 0 dBm       |
| RF Att. Mode       | Manual   | Auto        | Auto        |
| RF Attenuator      | 10 dB    | 10 dB       | 10 dB       |
| Preamp             | On       | Off         | Off         |
| Sweep Points       | 601      | 4001        | 32001       |
| Stop After Sweep   | Off      | Off         | Off         |
| Transducer         | None     | None        | None        |
| Limit Check        | Absolute | Absolute    | Absolute    |
| Abs Limit Start    | 10 dBm   | -13 dBm     | -13 dBm     |
| Abs Limit Stop     | 10 dBm   | -13 dBm     | -13 dBm     |

Note that this example is primarily meant to demonstrate the remote control commands, it does not necessarily reflect a useful measurement task.

```
//-----Preparing the measurement-----
*RST
//Resets the instrument

SWE:MODE LIST
//Activates spurious emissions measurement

INIT:CONT OFF
//Selects single sweep mode.

//Spurious measurement has to be in single sweep mode to be configured
//and no sweep operation may be running!

// If required, a sweep stop can be ensured by INIT:IMM;*WAI
```

```

//-----Configuring a Sweep List-----

LIST:RANG:COUNT?
//Returns the number of measurement ranges in the sweep list.
LIST:RANG4:DEL
//Deletes the fourth range.
LIST:RANG1:STAR 10000000
//Defines a start frequency of 10 MHz for range 1.
LIST:RANG1:STOP 100000000
//Defines a stop frequency of 100 MHz for range 1.
LIST:RANG1:BAND 500000
//Defines a resolution bandwidth of 500 kHz in range 1.
LIST:RANG1:BAND:VID 5000000
//Defines a video bandwidth of 5 MHz for range 1.
LIST:RANG1:INP:ATT:AUTO OFF
//Turns automatic selection of the input attenuation in range 1 off.

LIST:RANG1:INP:ATT 10
//Defines a input attenuation of 10 dBm for range 1.

LIST:RANG1:FILT:TYPE CFILter
//Selects an Channel filter for range 1.
LIST:RANG1:DET SAMP
//Selects a sample detector for range 1.
LIST:RANG1:POIN 601
//Defines 601 sweep points for range 1.
LIST:RANG1:RLEV -20
//Defines a reference level of -20 dBm for range 1.
LIST:RANG1:SWE:TIME 5
//Defines a manual sweep time of 5 second for range 1.

// Create a transducer that can be used.
// It has to cover the corresponding frequency range
//
SENSE1:CORREction:TRANSDUCER:SElect 'Test'
SENSE1:CORREction:TRANSDUCER:UNIT 'DB'
SENSE1:CORREction:TRANSDUCER:COMment 'Test Transducer'
// Frequency Span 0 MHz to 20 Ghz
SENSE1:CORREction:TRANSDUCER:DATA 0e6,5, 20e9,3

SENS:LIST:RANG1:TRAN 'Test'
//Includes a transducer called 'Test' for range 1.

LIST:RANG1:LIM:STAR 10
LIST:RANG1:LIM:STOP 10
//Defines an absolute limit of 10 dBm at the start and stop frequencies of range 1.
LIST:RANG:LIM:STAT ON
//Turns the limit check for all ranges on.

```

```
//-----Configuring the List Evaluation-----
CALC:PSE:MARG 100
//Sets the threshold to 100 dB.
CALC:PSE:PSH ON
//Marks all peaks in the diagram with blue squares.
CALC:PSE:SUBR 10
//Sets 10 peaks per range to be stored in the list.

//-----Performing the Measurement-----

INIT:SPUR; *WAI
//Performs a spurious emission measurement and waits until the sweep has finished.

//-----Retrieving Results-----
CALC:LIM1:FAIL?
//Queries the result of the check for limit line 1.
TRAC? SPUR
//Queries the peak list of the spurious emission measurement.
```

## 12.5.8 Analyzing Statistics (APD, CCDF)

All remote control commands specific to statistical measurements are described here.

- [Activating Statistical Measurements](#)..... 728
- [Configuring Statistical Measurements](#).....729
- [Using Gate Ranges for Statistical Measurements](#)..... 730
- [Scaling the Diagram](#).....732
- [Performing a Statistical Measurement](#)..... 735
- [Retrieving Results](#)..... 735
- [Programming Example: Measuring Statistics](#)..... 736

### 12.5.8.1 Activating Statistical Measurements

The following commands activate statistical measurements.

[CALCulate<n>:STATistics:APD\[:STATe\]](#)..... 728  
[CALCulate<n>:STATistics:CCDF\[:STATe\]](#)..... 729

---

**CALCulate<n>:STATistics:APD[:STATe] <State>**

This command turns the APD measurement on and off.

**Suffix:**

<n>                      [Window](#)

**Parameters:**

<State>                      ON | OFF | 1 | 0  
 \*RST:                      0

**Example:**

CALC:STAT:APD ON  
 Switches on the APD measurement.



**CALCulate<n>:STATistics:CCDF[:STATe] <State>**

This command turns the CCDF on and off.

**Suffix:**

<n>                    irrelevant

**Parameters:**

<State>                ON | OFF | 1 | 0  
\*RST:                 0

**Example:**

CALC:STAT:CCDF ON  
Switches on the CCDF measurement.

**12.5.8.2 Configuring Statistical Measurements**

The following commands configure the measurement.

Useful commands for configuring statistical measurements described elsewhere:

- [\[SENSe:\]BANDwidth\[:RESolution\]](#) on page 785

**Remote commands exclusive to statistical measurements:**

|                                                                    |     |
|--------------------------------------------------------------------|-----|
| <a href="#">CALCulate&lt;n&gt;:MARKer&lt;m&gt;:Y:PERCent</a> ..... | 729 |
| <a href="#">CALCulate&lt;n&gt;:STATistics:NSAMples</a> .....       | 729 |

**CALCulate<n>:MARKer<m>:Y:PERCent <Probability>**

This command sets a marker to a particular probability value. You can query the corresponding level with [CALCulate<n>:MARKer<m>:X](#).

Using the command turns delta markers into normal markers.

This command is available for CCDF measurements.

**Suffix:**

<n>                    [Window](#)

<m>                    [Marker](#)

**Parameters:**

<Probability>        Range:        0 % to 100 %

**Example:**

CALC1:MARK:Y:PERC 95PCT  
Positions marker 1 to a probability of 95 %.

**Manual operation:** See "[Percent Marker \(CCDF only\)](#)" on page 267

**CALCulate<n>:STATistics:NSAMples <Samples>**

This command defines the number of samples included in the analysis of statistical measurement functions.

**Suffix:**

<n>                    [Window](#)

**Parameters:**

<Samples>                    Range:        Min: 100, Max: depends on the RBW filter  
                                      \*RST:        100000

**Example:**

CALC:STAT:NSAM 500  
 Sets the number of measurement points to be acquired to 500.

**Manual operation:** See " [Number of Samples](#) " on page 267

**12.5.8.3 Using Gate Ranges for Statistical Measurements**

The following commands control gated statistical measurements.

|                                                  |     |
|--------------------------------------------------|-----|
| [SENSe:]SWEep:EGATe:TRACe<t>:COMMENT.....        | 730 |
| [SENSe:]SWEep:EGATe:TRACe:PERiod.....            | 730 |
| [SENSe:]SWEep:EGATe:TRACe<t>:STARt<range>.....   | 730 |
| [SENSe:]SWEep:EGATe:TRACe<t>[:STATe<range>]..... | 731 |
| [SENSe:]SWEep:EGATe:TRACe<t>:STOP<range>.....    | 731 |

---

**[SENSe:]SWEep:EGATe:TRACe<t>:COMMENT <Comment>**

This command defines a comment for the gate of a particular trace.

**Suffix:**

<t>                                    [Trace](#)

**Parameters:**

<Comment>                        String containing the comment.

**Example:**

SWE:EGAT:TRAC1:COMM 'MyComment'  
 Defines a comment for the gate in trace 1.

**Manual operation:** See " [Comment](#) " on page 269

---

**[SENSe:]SWEep:EGATe:TRACe:PERiod <Length>**

This command defines the length of the gate for all traces.

The gate length applies to all traces.

**Parameters:**

<Length>                        Range:        100 ns to 1000 s  
                                      \*RST:        2 ms

**Example:**

SWE:EGAT:TRAC1:PER 5ms  
 Defines the period for gated triggering to 5 ms.

**Manual operation:** See " [Period](#) " on page 269

---

**[SENSe:]SWEep:EGATe:TRACe<t>:STARt<range> <Time>**

This command defines the start time for a gate range.

**Suffix:**

|         |                     |
|---------|---------------------|
| <t>     | Trace               |
| <range> | 1...3<br>gate range |

**Parameters:**

|        |                                                                                                                                                                                                                                                                                                                                                                                                                                                                                                                                                                                                                                  |
|--------|----------------------------------------------------------------------------------------------------------------------------------------------------------------------------------------------------------------------------------------------------------------------------------------------------------------------------------------------------------------------------------------------------------------------------------------------------------------------------------------------------------------------------------------------------------------------------------------------------------------------------------|
| <Time> | The value range depends on the gate period you have set for the selected trace with <code>[SENSe:]SWEep:EGATe:TRACe:PERiod</code> . The following rules apply: <ul style="list-style-type: none"> <li>• the start time may not be higher than the length of the gate</li> <li>• the start time may not be lower than the stop time of the gate range of a lower order</li> </ul> The reset values depend on the gate range. <ul style="list-style-type: none"> <li>• for gate range 1, the start time is 0 ms</li> <li>• for gate range 3, the start time is 2 ms</li> <li>• for gate range 5, the start time is 4 ms</li> </ul> |
|--------|----------------------------------------------------------------------------------------------------------------------------------------------------------------------------------------------------------------------------------------------------------------------------------------------------------------------------------------------------------------------------------------------------------------------------------------------------------------------------------------------------------------------------------------------------------------------------------------------------------------------------------|

**Example:**

`SWE:EGAT:TRAC1:STAR1 3ms`  
Sets the Starting point for range 1 on trace 1 at 3 ms.

**Manual operation:** See " [Range <x> Start/Stop](#) " on page 269

`[SENSe:]SWEep:EGATe:TRACe<t>[:STATe<range>] <State>`

This command includes or excludes a gate range for a particular trace.

**Suffix:**

|         |                     |
|---------|---------------------|
| <t>     | Trace               |
| <range> | 1...3<br>gate range |

**Parameters:**

|         |                  |
|---------|------------------|
| <State> | ON   OFF   1   0 |
| *RST:   | 0                |

**Example:**

`SWE:EGAT:TRAC1:STAT1 ON`  
Activates gate range 1 for trace 1.

**Manual operation:** See " [Gated Trigger](#) " on page 268  
See " [Range <x> Use](#) " on page 269

`[SENSe:]SWEep:EGATe:TRACe<t>:STOP<range> <Time>`

This command defines the stop time for a gate range.

**Suffix:**

|         |                     |
|---------|---------------------|
| <t>     | Trace               |
| <range> | 1...3<br>gate range |

**Parameters:**

<Time> The value range depends on the gate period you have set for the selected trace with `[SENSe:]SWEep:EGATe:TRACe:PERiod`. The following rules apply:

- the stop time may not be higher than the length of the gate
- the stop time may not be lower than the start time

The reset values depend on the gate range.

- for gate range 1, the stop time is 1 ms
- for gate range 3, the stop time is 3 ms
- for gate range 5, the stop time is 5 ms

**Example:**

```
SWE:EGAT:TRAC1:STOP1 5ms
```

Sets the stopping point for range 1 on trace 1 at 5 ms.

**Manual operation:** See " [Range <x> Start/Stop](#) " on page 269

**12.5.8.4 Scaling the Diagram**

The following commands set up the diagram for statistical measurements.

|                                                                  |     |
|------------------------------------------------------------------|-----|
| <code>CALCulate&lt;n&gt;:STATistics:PRESet</code> .....          | 732 |
| <code>CALCulate&lt;n&gt;:STATistics:SCALE:AUTO ONCE</code> ..... | 733 |
| <code>CALCulate&lt;n&gt;:STATistics:SCALE:X:RANGe</code> .....   | 733 |
| <code>CALCulate&lt;n&gt;:STATistics:SCALE:X:RLEVel</code> .....  | 733 |
| <code>CALCulate&lt;n&gt;:STATistics:SCALE:Y:LOWer</code> .....   | 734 |
| <code>CALCulate&lt;n&gt;:STATistics:SCALE:Y:UNIT</code> .....    | 734 |
| <code>CALCulate&lt;n&gt;:STATistics:SCALE:Y:UPPer</code> .....   | 734 |

**CALCulate<n>:STATistics:PRESet**

This command resets the scale of the diagram (x- and y-axis).

- Reference level (x-axis)  
0.0 dBm
- Display range (x-axis) for APD measurements  
100 dB
- Display range (x-axis) for CCDF measurements  
20 dB
- Upper limit of the y-axis  
1.0
- Lower limit of the y-axis  
1E-6

**Suffix:**

<n> [Window](#)

**Example:**

```
CALC:STAT:PRES
```

Resets the scaling for statistical functions

**Usage:**

Event

**Manual operation:** See " [Default Settings](#) " on page 271

**CALCulate<n>:STATistics:SCALE:AUTO ONCE**

This command initiates an automatic scaling of the diagram (x- and y-axis).

To obtain maximum resolution, the level range is set as a function of the measured spacing between peak power and the minimum power for the APD measurement and of the spacing between peak power and mean power for the CCDF measurement. In addition, the probability scale for the number of test points is adapted.

To get valid results, you have to perform a complete sweep with synchronization to the end of the auto range process. This is only possible in single sweep mode.

**Suffix:**

<n> [Window](#)

**Parameters:**

ONCE

**Example:**

`CALC:STAT:SCAL:AUTO ONCE;*WAI`

Adapts the level setting for statistical measurements.

**Usage:**

Event

**Manual operation:** See "[Adjust Settings](#)" on page 268

**CALCulate<n>:STATistics:SCALE:X:RANGe <Range>**

This command defines the display range of the x-axis for statistical measurements.

The effects are identical to `DISPlay[:WINDow<n>]:TRACe<t>:Y[:SCALE]`.

**Suffix:**

<n> [Window](#)

**Parameters:**

<Range> Range: 1 dB to 200 dB  
\*RST: 100 dB

**Example:**

`CALC:STAT:SCAL:X:RANG 20dB`

**Manual operation:** See "[Range](#)" on page 271

**CALCulate<n>:STATistics:SCALE:X:RLEVel <RefLevel>**

This command sets the reference level for statistical measurements. The effects are identical to `DISPlay[:WINDow<n>]:TRACe<t>:Y[:SCALE]:RLEVel`.

Note that in case of statistical measurements the reference level applies to the x-axis.

**Suffix:**

<n> [Window](#)

**Parameters:**

<RefLevel> The unit is variable.  
If a reference level offset is included, the range is adjusted by that offset.

Range: -130 dBm to 30 dBm

\*RST: 0 dBm

**Example:**

CALC:STAT:SCAL:X:RLEV -60dBm

**Manual operation:** See " [Ref Level](#) " on page 271

**CALCulate<n>:STATistics:SCALE:Y:LOWer <Magnitude>**

This command defines the lower vertical limit of the diagram.

**Suffix:**

<n> [Window](#)

**Parameters:**

<Magnitude> The number is a statistical value and therefore dimensionless.

Range: 1E-9 to 0.1

\*RST: 1E-6

**Example:**

CALC:STAT:SCAL:Y:LOW 0.001

**Manual operation:** See " [Y-Max / Y-Min](#) " on page 271

**CALCulate<n>:STATistics:SCALE:Y:UNIT <Unit>**

This command selects the unit of the y-axis.

**Suffix:**

<n> [Window](#)

**Parameters:**

<Unit> PCT | ABS

\*RST: ABS

**Example:**

CALC:STAT:SCAL:Y:UNIT PCT

Sets the percentage scale.

**Manual operation:** See " [Y-Unit](#) " on page 271

**CALCulate<n>:STATistics:SCALE:Y:UPPer <Magnitude>**

This command defines the upper vertical limit of the diagram.

**Suffix:**

<n> [Window](#)

**Parameters:**

<Magnitude> The number is a statistical value and therefore dimensionless.  
 Range: 1E-5 to 1.0  
 \*RST: 1.0

**Example:**

CALC:STAT:SCAL:Y:UPP 0.01

**Manual operation:** See " Y-Max / Y-Min " on page 271

**12.5.8.5 Performing a Statistical Measurement**

The following commands are required to perform a statistical measurement:

INITiate<n>[:IMMEDIATE] on page 636, see [Chapter 12.5.1, "Performing Measurements"](#), on page 633

**12.5.8.6 Retrieving Results**

The following commands are required to retrieve the measurement results.

Useful commands for retrieving results described elsewhere:

- CALCulate<n>:MARKer<m>:X on page 867

**Remote commands exclusive to statistical results**

|                                    |     |
|------------------------------------|-----|
| CALCulate<n>:STATistics:CCDF:X<t>? | 735 |
| CALCulate<n>:STATistics:RESult<t>? | 736 |

**CALCulate<n>:STATistics:CCDF:X<t>? <Probability>**

This command queries the results of the CCDF.

**Suffix:**

<n> [Window](#)  
 <t> [Trace](#)

**Query parameters:**

<Probability> **P0\_01**  
 Level value for 0.01 % probability  
**P0\_1**  
 Level value for 0.1 % probability  
**P1**  
 P1: Level value for 1 % probability  
**P10**  
 Level value for 10 % probability

**Example:**

CALC:STAT:CCDF:X1? P10  
 Returns the level values that are over 10 % above the mean value.

**Usage:**

Query only

**CALCulate**<n>:STATistics:RESult<t>? <ResultType>

This command queries the results of a CCDF or ADP measurement for a specific trace.

**Suffix:**

<n> irrelevant

<t> [Trace](#)

**Query parameters:**

<ResultType>

**MEAN**

Average (=RMS) power in dBm measured during the measurement time.

**PEAK**

Peak power in dBm measured during the measurement time.

**CFACTOR**

Determined crest factor (= ratio of peak power to average power) in dB.

**ALL**

Results of all three measurements mentioned before, separated by commas: <mean power>,<peak power>,<crest factor>

**Example:**

```
CALC:STAT:RES2? ALL
```

Reads out the three measurement results of trace 2. Example of answer string: 5.56,19.25,13.69 i.e. mean power: 5.56 dBm, peak power 19.25 dBm, crest factor 13.69 dB

**Usage:**

Query only

**12.5.8.7 Programming Example: Measuring Statistics**

This example demonstrates how to determine statistical values for a measurement in a remote environment using the gated statistics example described in [Chapter 6.7.4, "APD and CCDF Basics - Gated Triggering"](#), on page 265.



| Gate Ranges   |                   |
|---------------|-------------------|
| Trace 1       |                   |
| Comment       | GSM - useful part |
| Period        | 4.615 ms          |
| Range 1 Use   | On                |
| Range 1 Start | 15 $\mu$ s        |
| Range 1 Stop  | 557.8 $\mu$ s     |
| Range 2 Use   | Off               |
| Range 2 Start | 2 ms              |
| Range 2 Stop  | 3 ms              |
| Range 3 Use   | Off               |
| Range 3 Start | 4 ms              |

```
//-----Configuring the measurement -----
*RST
//Reset the instrument
TRIG:SOUR EXT
//Defines the use of an external trigger.
TRIG:HOLD 25us
//Defines a trigger offset of 25 μ s.
CALC:STAT:APD ON
//Activates APD measurement.
CALC:STAT:NSAM 1000
//Sets the number of samples to be included in the statistical evaluation to 1000.

//-----Defining Gate ranges -----

SWE:EGAT:TRAC1:COMM 'GSM - useful part'
//Defines a comment for the gate
SWE:EGAT:TRAC1:PER 4.61536ms
//Sets the gate period to 4.61536ms.
SWE:EGAT:TRAC1:STAR1 15us
//Sets the start of range 1 to 15 μ s.
SWE:EGAT:TRAC1:STOP1 557.8us
//Sets the end of range 1 to 15 μ s (start time) + 542.77 μ s (useful part) = 557.8 μ s.
SWE:EGAT:TRAC1:STAT1 ON
//Activates the use of range 1.

//-----Performing the Measurement-----
INIT:CONT OFF
//Selects single sweep mode.
INIT;*WAI
//Initiates a new measurement and waits until the sweep has finished.

//-----Retrieving Results-----
```

```

CALC:STAT:RES1? MEAN
//Returns the mean average power for the useful part of the GSM signal.

//----- Determining the CCDF values-----

CALC:STAT:CCDF ON
//Activates CCDF measurement.
CALC:MARK2:Y:PERC 95PCT
//Sets marker 2 to the 95% probability value.
INIT;*WAI
//Initiates a new measurement and waits until the sweep has finished.
CALC:STAT:CCDF:X? P1
//Returns the level value for 10% probability for the CCDF.
CALC:MARK2:X?
//Returns the level for a probability of 95%.

//----- Scaling the diagram -----
CALC:STAT:SCAL:X:RLEV -70dBm
//Sets the reference level to -70 dBm (x-axis!)
CALC:STAT:SCAL:X:RANG 20dB
//Defines a power level range of 20 dB for the x-axis
CALC:STAT:SCAL:Y:LOW 0.0001
//Sets the minimum of the y-axis to 0.01% probability
CALC:STAT:SCAL:Y:UPP 1.0
//Sets the maximum of the y-axis to 100% probability
CALC:STAT:SCAL:Y:UNIT PCT
//Displays percentage values on y-axis scale

```

## 12.5.9 Measuring the Time Domain Power

All remote control commands specific to time domain power measurements are described here.

- [Configuring the Measurement](#).....738
- [Performing a Time Domain Power Measurement](#).....741
- [Retrieving Measurement Results](#).....742
- [Programming Example: Time Domain Power](#).....747

### 12.5.9.1 Configuring the Measurement

The following remote commands measure the time domain power.

**Useful commands for time domain power measurements described elsewhere**

- `CALCulate<n>:MARKer<m>:X:SLIMits:LEFT`
- `CALCulate<n>:MARKer<m>:X:SLIMits:RIGHT`
- `CALCulate<n>:MARKer<m>:X:SLIMits[:STATe]`

**Remote commands exclusive to time domain power measurements**

|                                                                 |     |
|-----------------------------------------------------------------|-----|
| CALCulate<n>:MARKer<m>:FUNCTion:SUMMary:AOff.....               | 739 |
| CALCulate<n>:MARKer<m>:FUNCTion:SUMMary:AVERage.....            | 739 |
| CALCulate<n>:MARKer<m>:FUNCTion:SUMMary:PHOLd.....              | 740 |
| CALCulate<n>:MARKer<m>:FUNCTion:SUMMary[:STATe].....            | 740 |
| CALCulate<n>:MARKer<m>:FUNCTion:SUMMary:MEAN[:STATe].....       | 740 |
| CALCulate<n>:MARKer<m>:FUNCTion:SUMMary:PPEak[:STATe].....      | 741 |
| CALCulate<n>:MARKer<m>:FUNCTion:SUMMary:RMS[:STATe].....        | 741 |
| CALCulate<n>:MARKer<m>:FUNCTion:SUMMary:SDEviation[:STATe]..... | 741 |

**CALCulate<n>:MARKer<m>:FUNCTion:SUMMary:AOff**

This command turns all time domain power evaluation modes off.

**Suffix:**

<n>                      Window

<m>                      Marker

**Usage:**                      Event

**CALCulate<n>:MARKer<m>:FUNCTion:SUMMary:AVERage <State>**

This command switches on or off averaging for the active power measurement in zero span in the window specified by the suffix <n>. If activated, a time domain value is calculated from the trace after each sweep; in the end, all values are averaged to calculate the final result.

The number of results required for the calculation of average is defined with `[SENSe:]AVERage<n>:COUNT`.

Averaging is reset by switching it off and on again.

Synchronization to the end of averaging is only possible in single sweep mode.

**Suffix:**

<n>                      Window

<m>                      Marker

**Parameters:**

<State>                      ON | OFF | 1 | 0

\*RST:                      0

**Example:**

```
INIT:CONT OFF
```

Switches to single sweep mode.

```
CALC:MARK:FUNC:SUMM:AVER ON
```

Switches on the calculation of average.

```
AVER:COUN 200
```

Sets the measurement counter to 200.

```
INIT;*WAI
```

Starts a sweep and waits for the end.

**CALCulate<n>:MARKer<m>:FUNCTION:SUMMARY:PHOLD <State>**

This command switches on or off the peak-hold function for the active power measurement in zero span in the window specified by the suffix <n>. If activated, the peak for each sweep is compared to the previously stored peak; the maximum of the two is stored as the current peak.

The peak-hold function is reset by switching it off and on again.

**Suffix:**

<n> [Window](#)

<m> [Marker](#)

**Parameters:**

<State> ON | OFF | 1 | 0  
\*RST: 0

**CALCulate<n>:MARKer<m>:FUNCTION:SUMMARY[:STATE] <State>**

This command turns time domain power measurements on and off. This measurement is only available in zero span.

When you turn the measurement on, the R&S FPS activates a marker and positions it on the peak power level in the marker search range.

**Suffix:**

<n> [Window](#)

<m> [Marker](#)

**Parameters:**

<State> ON | OFF | 1 | 0  
\*RST: 0

**CALCulate<n>:MARKer<m>:FUNCTION:SUMMARY:MEAN[:STATE] <State>**

This command turns the evaluation to determine the mean time domain power on and off.

The R&S FPS performs the measurement on the trace marker 1 is positioned on.

**Suffix:**

<n> [Window](#)

<m> [Marker](#)

**Parameters:**

<State> ON | OFF | 1 | 0  
\*RST: 0

**Manual operation:** See "[Results](#)" on page 278

**CALCulate<n>:MARKer<m>:FUNCTION:SUMMARY:PPEak[:STATE] <State>**

This command turns the evaluation to determine the positive peak time domain power on and off.

The R&S FPS performs the measurement on the trace marker 1 is positioned on.

**Suffix:**

<n> [Window](#)

<m> [Marker](#)

**Parameters:**

<State> ON | OFF | 1 | 0

\*RST: 0

**Manual operation:** See " [Results](#) " on page 278

**CALCulate<n>:MARKer<m>:FUNCTION:SUMMARY:RMS[:STATE] <State>**

This command turns the evaluation to determine the RMS time domain power on and off.

The R&S FPS performs the measurement on the trace marker 1 is positioned on.

**Suffix:**

<n> [Window](#)

<m> [Marker](#)

**Parameters:**

<State> ON | OFF | 1 | 0

\*RST: 0

**Manual operation:** See " [Results](#) " on page 278

**CALCulate<n>:MARKer<m>:FUNCTION:SUMMARY:SDEVIation[:STATE] <State>**

This command turns the evaluation to determine the standard deviation of the time domain power on and off.

The R&S FPS performs the measurement on the trace marker 1 is positioned on.

**Suffix:**

<n> [Window](#)

<m> [Marker](#)

**Parameters:**

<State> ON | OFF | 1 | 0

\*RST: 0

### 12.5.9.2 Performing a Time Domain Power Measurement

The following commands are required to perform a Time Domain Power measurement:

`INITiate<n>[:IMMediate]` on page 636, see [Chapter 12.5.1, "Performing Measurements"](#), on page 633

### 12.5.9.3 Retrieving Measurement Results

The following commands query the results for time domain measurements.

#### Measuring the Mean Power

|                                                                                             |     |
|---------------------------------------------------------------------------------------------|-----|
| <code>CALCulate&lt;n&gt;:MARKer&lt;m&gt;:FUNCTION:SUMMARY:MEAN:AVERAGE:RESULT?</code> ..... | 742 |
| <code>CALCulate&lt;n&gt;:MARKer&lt;m&gt;:FUNCTION:SUMMARY:MEAN:PHOLD:RESULT?</code> .....   | 742 |
| <code>CALCulate&lt;n&gt;:MARKer&lt;m&gt;:FUNCTION:SUMMARY:MEAN:RESULT?</code> .....         | 743 |

---

#### `CALCulate<n>:MARKer<m>:FUNCTION:SUMMARY:MEAN:AVERAGE:RESULT?`

This command queries the average mean time domain power. The query is only possible if averaging has been activated previously using `CALCulate<n>:MARKer<m>:FUNCTION:SUMMARY:AVERAGE` on page 739.

To get a valid result, you have to perform a complete measurement with synchronization to the end of the measurement before reading out the result. This is only possible for single sweep mode.

See also `INITiate<n>:CONTinuous` on page 635.

#### Suffix:

<n>                      [Window](#)

<m>                      [Marker](#)

#### Return values:

<MeanPower>            Mean power of the signal during the measurement time.

**Usage:**                      Query only

---

#### `CALCulate<n>:MARKer<m>:FUNCTION:SUMMARY:MEAN:PHOLD:RESULT?`

This command queries the maximum mean time domain power. The query is only possible if the peak hold function has been activated previously using `CALCulate<n>:MARKer<m>:FUNCTION:SUMMARY:PHOLD`.

To get a valid result, you have to perform a complete measurement with synchronization to the end of the measurement before reading out the result. This is only possible for single sweep mode.

See also `INITiate<n>:CONTinuous` on page 635.

#### Suffix:

<n>                      [Window](#)

<m>                      [Marker](#)

#### Return values:

<MeanPower>            Mean power of the signal during the measurement time.

**Usage:** Query only

---

#### **CALCulate<n>:MARKer<m>:FUNction:SUMMary:MEAN:RESult?**

This command queries the mean time domain power.

To get a valid result, you have to perform a complete measurement with synchronization to the end of the measurement before reading out the result. This is only possible for single sweep mode.

See also [INITiate<n>:CONTinuous](#) on page 635.

**Suffix:**

<n> [Window](#)

<m> [Marker](#)

**Return values:**

<MeanPower> Mean power of the signal during the measurement time.

**Usage:** Query only

**Manual operation:** See " [Results](#) " on page 278

#### **Measuring the Peak Power**

---

#### **CALCulate<n>:MARKer<m>:FUNction:SUMMary:PPEak:AVERage:RESult?**

This command queries the average positive peak time domain power. The query is only possible if averaging has been activated previously using [CALCulate<n>:MARKer<m>:FUNction:SUMMary:AVERage](#) on page 739.

To get a valid result, you have to perform a complete measurement with synchronization to the end of the measurement before reading out the result. This is only possible for single sweep mode.

See also [INITiate<n>:CONTinuous](#) on page 635.

**Suffix:**

<n> [Window](#)

<m> [Marker](#)

**Parameters:**

<PeakPower> Peak power of the signal during the measurement time.

**Usage:** Query only

---

#### **CALCulate<n>:MARKer<m>:FUNction:SUMMary:PPEak:PHOLd:RESult?**

This command queries the maximum positive peak time domain power. The query is only possible if the peak hold function has been activated previously using [CALCulate<n>:MARKer<m>:FUNction:SUMMary:PHOLd](#).

To get a valid result, you have to perform a complete measurement with synchronization to the end of the measurement before reading out the result. This is only possible for single sweep mode.

See also [INITiate<n>:CONTInuous](#) on page 635.

**Suffix:**

<n> [Window](#)

<m> [Marker](#)

**Parameters:**

<PeakPower> Peak power of the signal during the measurement time.

**Usage:** Query only

**CALCulate<n>:MARKer<m>:FUNCTion:SUMMary:PPEak:RESult?**

This command queries the positive peak time domain power.

To get a valid result, you have to perform a complete measurement with synchronization to the end of the measurement before reading out the result. This is only possible for single sweep mode.

See also [INITiate<n>:CONTInuous](#) on page 635.

**Suffix:**

<n> [Window](#)

<m> [Marker](#)

**Parameters:**

<PeakPower> Peak power of the signal during the measurement time.

**Usage:** Query only

**Manual operation:** See " [Results](#) " on page 278

**Measuring the RMS Power**

**CALCulate<n>:MARKer<m>:FUNCTion:SUMMary:RMS:AVERage:RESult?**

This command queries the average RMS of the time domain power. The query is only possible if averaging has been activated previously using [CALCulate<n>:MARKer<m>:FUNCTion:SUMMary:AVERage](#) on page 739.

To get a valid result, you have to perform a complete measurement with synchronization to the end of the measurement before reading out the result. This is only possible for single sweep mode.

See also [INITiate<n>:CONTInuous](#) on page 635.

**Suffix:**

<n> [Window](#)

<m> [Marker](#)



**Return values:**

<RMSPower>           RMS power of the signal during the measurement time.

**Usage:**               Query only

**CALCulate<n>:MARKer<m>:FUNCTION:SUMMARY:RMS:PHOLD:RESULT?**

This command queries the maximum RMS of the time domain power. The query is only possible if the peak hold function has been activated previously using [CALCulate<n>:MARKer<m>:FUNCTION:SUMMARY:PHOLD](#).

To get a valid result, you have to perform a complete measurement with synchronization to the end of the measurement before reading out the result. This is only possible for single sweep mode.

See also [INITiate<n>:CONTinuous](#) on page 635.

**Suffix:**

<n>                    [Window](#)

<m>                    [Marker](#)

**Return values:**

<RMSPower>           RMS power of the signal during the measurement time.

**Usage:**               Query only

**CALCulate<n>:MARKer<m>:FUNCTION:SUMMARY:RMS:RESULT?**

This command queries the RMS of the time domain power.

To get a valid result, you have to perform a complete measurement with synchronization to the end of the measurement before reading out the result. This is only possible for single sweep mode.

See also [INITiate<n>:CONTinuous](#) on page 635.

**Suffix:**

<n>                    [Window](#)

<m>                    [Marker](#)

**Return values:**

<RMSPower>           RMS power of the signal during the measurement time.

**Usage:**               Query only

**Manual operation:**   See "[Results](#)" on page 278

**Measuring the Standard Deviation****CALCulate<n>:MARKer<m>:FUNCTION:SUMMARY:SDEViation:AVERAGE:RESULT?**

This command queries the average standard deviation of the time domain power. The query is only possible if averaging has been activated previously using [CALCulate<n>:MARKer<m>:FUNCTION:SUMMARY:AVERAGE](#) on page 739.

To get a valid result, you have to perform a complete measurement with synchronization to the end of the measurement before reading out the result. This is only possible for single sweep mode.

See also [INITiate<n>:CONTInuous](#) on page 635.

**Suffix:**

<n> [Window](#)

<m> [Marker](#)

**Return values:**

<StandardDeviation> Standard deviation of the signal during the measurement time.

**Usage:** Query only

**CALCulate<n>:MARKer<m>:FUNction:SUMMary:SDEViation:PHOLd:RESult?**

This command queries the maximum standard deviation of the time domain power. The query is only possible if the peak hold function has been activated previously using [CALCulate<n>:MARKer<m>:FUNction:SUMMary:PHOLd](#).

To get a valid result, you have to perform a complete measurement with synchronization to the end of the measurement before reading out the result. This is only possible for single sweep mode.

See also [INITiate<n>:CONTInuous](#) on page 635.

**Suffix:**

<n> [Window](#)

<m> [Marker](#)

**Return values:**

<StandardDeviation> Standard deviation of the signal during the measurement time.

**Usage:** Query only

**CALCulate<n>:MARKer<m>:FUNction:SUMMary:SDEViation:RESult?**

This command queries the standard deviation of the time domain power.

To get a valid result, you have to perform a complete measurement with synchronization to the end of the measurement before reading out the result. This is only possible for single sweep mode.

See also [INITiate<n>:CONTInuous](#) on page 635.

**Suffix:**

<n> [Window](#)

<m> [Marker](#)

**Return values:**

<StandardDeviation> Standard deviation of the signal during the measurement time.

**Usage:** Query only

#### 12.5.9.4 Programming Example: Time Domain Power

This programming example demonstrates the measurement example described in [Chapter 6.8.6, "Measurement Example"](#), on page 279 in a remote environment.

```
//-----Configuring the Measurement-----
*RST
//Resets the instrument

INIT:CONT OFF
//Turns on single sweep mode.

FREQ:CENT 1.8GHz
//Sets the center frequency to 1.8 GHz.

BAND:RES 100kHz
//Sets the bandwidth to 100 kHz.

SWE:TIME 10ms
//Sets the sweep time to 640 µs.

FREQ:SPAN 0
//Sets the instrument to zero span.

CALC:MARK:FUNC:SUMM:STAT ON
//Turns on time domain power measurements.

CALC:MARK:FUNC:SUMM:MEAN ON
CALC:MARK:FUNC:SUMM:PPE ON
CALC:MARK:FUNC:SUMM:RMS ON
//Turns the evaluation of the mean, peak and RMS time domain power.

CALC:MARK:X:SLIM ON
//Activates limit lines for evaluation.

CALC:MARK:X:SLIM:LEFT 1ms
//Sets the left limit line to 326 µs.

CALC:MARK:X:SLIM:RIGH 6ms
//Sets the right limit line to 538 µs.

//-----Performing the Measurement-----

INIT;*WAI
//Initiates the measurement and waits until the measurement is finished.

//-----Retrieving the Results-----
CALC:MARK:FUNC:SUMM:MEAN:RES?
CALC:MARK:FUNC:SUMM:PPE:RES?
```

```
CALC:MARK:FUNC:SUMM:RMS:RES?
//Queries the mean, peak and RMS time domain power.
```

## 12.5.10 Measuring the Harmonic Distortion

All remote control commands specific to harmonic distortion measurements are described here.

- [Activating the Measurement](#).....748
- [Configuring the Measurement](#).....748
- [Performing the Measurement](#).....750
- [Retrieving Results](#).....750
- [Example: Measuring the Harmonic Distortion](#).....751

### 12.5.10.1 Activating the Measurement

The following command activates harmonic distortion measurement.

```
CALCulate<n>:MARKer<m>:FUNCtion:HARMonics[:STATe]..... 748
```

---

**CALCulate<n>:MARKer<m>:FUNCtion:HARMonics[:STATe] <State>**

This command turns the harmonic distortion measurement on and off.

Note the following:

- If you perform the measurement in the frequency domain, the search range for the frequency of the first harmonic, whose power is determined, is defined by the last span.
- If you perform the measurement in the time domain, the current center frequency is used as the frequency of the first harmonic. Thus, the frequency search is bypassed. The first harmonic frequency is set by a specific center frequency in zero span before the harmonic measurement is started.

**Suffix:**

<n>                      [Window](#)

<m>                      [Marker](#)

**Parameters:**

<State>                ON | OFF | 1 | 0  
                          \*RST:        0

**Example:**

```
CALC:MARK:FUNC:HARM ON
Activates the harmonic distortion measurement.
```

### 12.5.10.2 Configuring the Measurement

The following commands control the harmonic distortion measurement.

**Useful commands for harmonic distortion measurements described elsewhere**

- `CALCulate<n>:MARKer<m>:FUNction:CENTer` on page 776
- `[SENSe:]SWEep:TIME:AUTO` on page 790

**Remote commands exclusive to harmonic distortion measurements**

|                                                                                         |     |
|-----------------------------------------------------------------------------------------|-----|
| <code>CALCulate&lt;n&gt;:MARKer&lt;m&gt;:FUNction:HARMonics:BANDwidth:AUTO</code> ..... | 749 |
| <code>CALCulate&lt;n&gt;:MARKer&lt;m&gt;:FUNction:HARMonics:NHARmonics</code> .....     | 749 |
| <code>CALCulate&lt;n&gt;:MARKer&lt;m&gt;:FUNction:HARMonics:PRESet</code> .....         | 749 |

**CALCulate<n>:MARKer<m>:FUNction:HARMonics:BANDwidth:AUTO <State>**

This command selects the resolution bandwidth of the harmonic in respect to the bandwidth of the first harmonic.

**Suffix:**

<n>                      Window

<m>                      Marker

**Parameters:**

<State>                ON | OFF | 0 | 1

**OFF | 0**

identical

**ON | 1**

a multiple

\*RST:                1

**Manual operation:** See " [Harmonic RBW Auto](#) " on page 285

**CALCulate<n>:MARKer<m>:FUNction:HARMonics:NHARmonics <NoHarmonics>**

This command selects the number of harmonics that the R&S FPS looks for.

**Suffix:**

<n>                      Window

<m>                      Marker

**Parameters:**

<NoHarmonics>      Range:            1 to 26

\*RST:                10

**Manual operation:** See " [Number of Harmonics](#) " on page 285

**CALCulate<n>:MARKer<m>:FUNction:HARMonics:PRESet**

This command initiates a measurement to determine the ideal configuration for the harmonic distortion measurement.

The method depends on the span.

- Frequency domain (span > 0)

Frequency and level of the first harmonic are determined and used for the measurement list.

- Time domain (span = 0)  
The level of the first harmonic is determined. The frequency remains unchanged.

**Suffix:**

<n>                      [Window](#)

<m>                      [Marker](#)

**Usage:**                      Event

**Manual operation:**    See "[Adjust Settings](#)" on page 285

### 12.5.10.3 Performing the Measurement

The following commands are required to perform a harmonic distortion measurement:

[INITiate<n>\[:IMMEDIATE\]](#) on page 636, see [Chapter 12.5.1, "Performing Measurements"](#), on page 633

### 12.5.10.4 Retrieving Results

The following commands retrieve the results of the harmonic distortion measurement.

[CALCulate<n>:MARKer<m>:FUNCTION:HARMonics:DISTortion?](#)..... 750

[CALCulate<n>:MARKer<m>:FUNCTION:HARMonics:LIST?](#)..... 750

---

#### **CALCulate<n>:MARKer<m>:FUNCTION:HARMonics:DISTortion? TOTAL**

This command queries the total harmonic distortion of the signal.

To get a valid result, you have to perform a complete measurement with synchronization to the end of the measurement before reading out the result. This is only possible for single sweep mode.

See also [INITiate<n>:CONTinuous](#) on page 635.

**Suffix:**

<n>                      [Window](#)

<m>                      [Marker](#)

**Return values:**

<Result>                      <Distortion\_%>,<Distortion\_dB>

Pair of values, one showing the THD in %, one in dB.

**Usage:**                      Query only

---

#### **CALCulate<n>:MARKer<m>:FUNCTION:HARMonics:LIST?**

This command queries the position of the harmonics.

To get a valid result, you have to perform a complete measurement with synchronization to the end of the measurement before reading out the result. This is only possible for single sweep mode.

See also `INITiate<n>:CONTInuous` on page 635.

**Suffix:**

<n> [Window](#)

<m> [Marker](#)

**Return values:**

<Harmonics> Returns one value for every harmonic.  
The first value is the absolute power of the first harmonic. The unit is variable.  
The other values are power levels relative to the first harmonic. The unit for these is dB.

**Usage:** Query only

### 12.5.10.5 Example: Measuring the Harmonic Distortion

```
//-----Configuring the Measurement-----
*RST
//Resets the instrument.

INIT:CONT OFF
//Turns on single sweep mode.

CALC:MARK:FUNC:HARM ON
//Turns on the harmonic distortion measurement.
CALC:MARK:FUNC:HARM:NHAR 3
//Defines three harmonics to be found.

CALC:MARK:FUNC:HARM:BAND:AUTO OFF
//Turns off automatic bandwidth selection.
CALC:MARK:FUNC:HARM:PRES
//Determines the ideal configuration.

//-----Performing the Measurement-----

INIT;*WAI
//Initiates the measurement and finishes the sweep.

//-----Retrieving the Results-----
CALC:MARK:FUNC:HARM:LIST?
//Queries the position of the harmonics.
CALC:MARK:FUNC:HARM:DIST? TOT
//Queries the total harmonic distortion.
```

## 12.5.11 Measuring the Third Order Intercept Point

- [Determining the TOI](#).....752
- [Programming Example: Measuring the TOI](#).....753

### 12.5.11.1 Determining the TOI

All remote control commands specific to TOI measurements are described here.

#### Useful commands for TOI measurements described elsewhere

- [CALCulate<n>:DELTaMarker<m>:X](#) on page 865
- [CALCulate<n>:DELTaMarker<m>:X:RELative?](#) on page 880
- [CALCulate<n>:DELTaMarker<m>:Y?](#) on page 880
- [CALCulate<n>:MARKer<m>:X](#) on page 867
- [CALCulate<n>:MARKer<m>:Y?](#) on page 881

#### Remote commands exclusive to TOI measurements

|                                                                                         |     |
|-----------------------------------------------------------------------------------------|-----|
| <a href="#">CALCulate&lt;n&gt;:MARKer&lt;m&gt;:FUNction:TOI[:STATe]</a> .....           | 752 |
| <a href="#">CALCulate&lt;n&gt;:MARKer&lt;m&gt;:FUNction:TOI:SEARChsignal ONCE</a> ..... | 753 |
| <a href="#">CALCulate&lt;n&gt;:MARKer&lt;m&gt;:FUNction:TOI:RESult?</a> .....           | 753 |

---

#### **CALCulate<n>:MARKer<m>:FUNction:TOI[:STATe] <State>**

This command initiates a measurement to determine the third intercept point.

A two-tone signal with equal carrier levels is expected at the RF input of the instrument. Marker 1 and marker 2 (both normal markers) are set to the maximum of the two signals. Delta marker 3 and delta marker 4 are positioned to the intermodulation products. The delta markers can be modified separately afterwards with the [CALCulate<n>:DELTaMarker<m>:X](#) command.

The third-order intercept is calculated from the level spacing between the normal markers and the delta markers.

#### Suffix:

<n>                      [Window](#)

<m>                      [Marker](#)

#### Parameters:

<State>                ON | OFF | 1 | 0

\*RST:                0

#### Example:

`CALC:MARK:FUNC:TOI ON`

Switches on the measurement of the third-order intercept.



**CALCulate<n>:MARKer<m>:FUNction:TOI:SEARchsignal ONCE**

This command initiates a search for signals in the current trace to determine the third intercept point.

**Suffix:**

<n>, <m>                      irrelevant

**Parameters:**

ONCE

**Example:**

```
CALC:MARK:FUNC:TOI:SEAR ONCE
```

Executes the search for 2 signals and their intermodulation product at the currently available trace.

**Usage:**

Event

**Manual operation:** See " [Search Signals](#) " on page 293

**CALCulate<n>:MARKer<m>:FUNction:TOI:RESult?**

This command queries the results for the third order intercept point measurement.

To get a valid result, you have to perform a complete measurement with synchronization to the end of the measurement before reading out the result. This is only possible for single sweep mode.

See also [INITiate<n>:CONTinuous](#) on page 635.

**Suffix:**

<n>                                [Window](#)

<m>                                [Marker](#)

**Parameters:**

<TOI>                              Third order intercept point.

**Example:**

```
INIT:CONT OFF
```

Switches to single sweep mode.

```
CALC:MARK:FUNC:TOI ON
```

Switches the intercept measurement.

```
INIT;*WAI
```

Starts a sweep and waits for the end.

```
CALC:MARK:FUNC:TOI:RES?
```

Outputs the measured value.

**Usage:**

Query only

**12.5.11.2 Programming Example: Measuring the TOI**

This example demonstrates how to determine the TOI in a remote environment.

```
//-----Configuring the measurement -----
*RST
//Reset the instrument
```

```

CALC:MARK:FUNC:TOI ON
//Activate TOI measurement.

//-----Performing the Measurement-----
INIT:CONT OFF
//Selects single sweep mode.

CALC:MARK:FUNC:TOI:SEAR ONCE
//Initiates a search for signals in the current trace.

//-----Retrieving Results-----
CALC:MARK:FUNC:TOI:RES?
//Returns the TOI.

```

## 12.5.12 Measuring the AM Modulation Depth

All remote control commands specific to AM modulation depth measurements are described here.

- [Configuring and Performing the Measurement](#).....754
- [Example: Measuring the AM Modulation Depth](#).....755

### 12.5.12.1 Configuring and Performing the Measurement

The following commands control the measurement.

#### Useful commands for AM modulation depth described elsewhere

- [CALCulate<n>:DELTaMarker<m>:X](#) on page 865
- [CALCulate<n>:DELTaMarker<m>:X:RELative?](#) on page 880
- [CALCulate<n>:MARKer<m>:X](#) on page 867

#### Remote commands exclusive to AM modulation depth measurements

```

CALCulate<n>:MARKer<m>:FUNCTion:MDEPth[:STATe].....754
CALCulate<n>:MARKer<m>:FUNCTion:MDEPth:SEARChsignal ONCE.....755
CALCulate<n>:MARKer<m>:FUNCTion:MDEPth:RESult?.....755

```

---

#### **CALCulate<n>:MARKer<m>:FUNCTion:MDEPth[:STATe]** <State>

This command turns the AM Modulation Depth measurement on and off.

To work correctly, the measurement requires an AM modulated signal.

#### Suffix:

<n>                      [Window](#)  
 <m>                      [Marker](#)

**Parameters:**

<State> ON | OFF | 1 | 0  
 \*RST: 0

**CALCulate<n>:MARKer<m>:FUNCTION:MDEPth:SEARChsignal ONCE**

This command initiates a search for the signals required for the AM depth measurement.

Note that the command does not perform a new measurement, but looks for the signals on the current trace.

**Suffix:**

<n> [Window](#)  
 <m> [Marker](#)

**Parameters:**

ONCE

**Example:**

CALC:MARK:FUNC:MDEP:SEAR ONCE

Executes the search of an AM modulated signal at the currently available trace.

**Usage:** Event

**Manual operation:** See "[Search Signals](#)" on page 298

**CALCulate<n>:MARKer<m>:FUNCTION:MDEPth:RESult?**

This command queries the results of the AM modulation depth measurement..

To get a valid result, you have to perform a complete measurement with synchronization to the end of the measurement before reading out the result. This is only possible for single sweep mode.

See also [INITiate<n>:CONTinuous](#) on page 635.

**Suffix:**

<n> [Window](#)  
 <m> [Marker](#)

**Return values:**

<ModulationDepth> Modulation depth in %.

**Usage:** Query only

**12.5.12.2 Example: Measuring the AM Modulation Depth**

This example demonstrates how to determine the AM modulation depth in a remote environment. Note that without a real input signal this measurement will not return useful results.

```

//-----Configuring the measurement -----
*RST
//Reset the instrument
FREQ:CENT 100MHz
//Set center frequency
FREQ:SPAN 10KHz
// Set span
CALC:MARK:FUNC:MDEP ON
//Activate AM modulation depth measurement.

//-----Performing the Measurement-----
INIT:CONT OFF
//Selects single sweep mode.
INIT:IMM
// Perform a single measurement
CALC:MARK:FUNC:MDEP:SEAR ONCE
//Initiates a search for signals in the current trace.

//-----Retrieving Results-----
CALC:MARK:FUNC:MDEP:RES?
//Queries the measurement results.

//If the results are not accurate, change the position of the
//the temporary markers manually.

//----Changing the position of the temp markers-----
CALC:MARK:X 100MHZ
//Positions the reference marker on 100 MHz.
CALC:DELT2:X 5KHZ
//Positions delta marker 2 and 3 at a distance of 5 kHz to the reference marker.
CALC:DELT3:X 1KHZ
//Corrects the position of delta marker 3 by 1 kHz.

CALC:MARK:FUNC:MDEP:RES?
//Queries the measurement results for the repositioned markers.

```

### 12.5.13 List Evaluations

A list evaluation is a multiple power measurement that measures the power at up to 200 frequencies. The measurement itself is a time domain measurement. Note that if you set a span greater than 0, the R&S FPS aborts the list evaluation.



#### Noise cancellation in list evaluations

Noise cancellation is also available in zero span and thus also for list evaluations. See "[Noise Cancellation](#)" on page 163 for details.

List evaluations allow for a different instrument setup for each frequency you want to measure. You can define most of the settings with the commands described here. Set-

tings not covered by the commands listed below can be controlled with the common commands (see [Chapter 12.7, "Setting Basic Measurement Parameters"](#), on page 775). Note that these commands have to be sent prior to the commands that control the list evaluation.

In case of a triggered measurement, a separate trigger event is required for each frequency to initiate that measurement. Note that you have to make changes to the trigger level in the time domain in order for it to take effect for the List Evaluation commands.



The list evaluation is incompatible to other measurement functions (e.g. marker functionality or statistics). If you use a command that controls those functions, the R&S FPS aborts the list evaluation.

The R&S FPS also aborts the list evaluation if you end the remote session.

The commands can be used in two different ways.

- Instrument setup, measurement and querying of the results in a single command line. This method causes the least delay between the measurement and the result output. However, it requires the control computer to wait for the response from the instrument.
- Instrument setup and querying of the result list at the end of the measurement: With this method, the control computer may be used for other activities while the measurement is being performed. However, more time is needed for synchronization via service request.

### 12.5.13.1 Performing List Evaluations

All remote control commands specific to list evaluations (which are available via remote control only) are described here.

Useful commands for list evaluation described elsewhere:

- [\[SENSe:\]POWer:NCORrection](#) on page 794

#### Remote commands exclusive to list evaluation

|                                                     |     |
|-----------------------------------------------------|-----|
| <a href="#">[SENSe:]LIST:POWer:RESult?</a> .....    | 757 |
| <a href="#">[SENSe:]LIST:POWer[:SEQuence]</a> ..... | 758 |
| <a href="#">[SENSe:]LIST:POWer:SET</a> .....        | 759 |
| <a href="#">[SENSe:]LIST:POWer:STATe</a> .....      | 760 |

#### **[SENSe:]LIST:POWer:RESult?**

This command queries the results of the list evaluation.

This command may be used to obtain measurement results in an asynchronous way, using the service request mechanism for synchronization to the end of the measurement.

If there are no results, the command returns an error.

**Return values:**

<PowerLevel> Power level for each frequency included in the measurement. The command returns up to 3 power levels for each frequency, depending on the number of evaluation modes you have turned on with `[SENSe:]LIST:POWer:SET`. The result is a list of floating point values separated by commas. The unit depends on `CALCulate<n>:UNIT:POWer`.

**Usage:** Query only

---

**[SENSe:]LIST:POWer[SEQUence]** <Frequency>, <RefLevel>, <RFAttenuation>, <EIAttenuation>, <FilterType>, <RBW>, <VBW>, <MeasTime>, <TriggerLevel>

This command configures and initiates the List Evaluation measurement.

The list can contain up to 200 entries (frequencies). You can define a different instrument setup for each frequency that is in the list.

If you synchronize the measurement with `*OPC`, the R&S FPS produces a service request when all frequencies have been measured and the number of individual measurements has been performed.

Note that using the command as a query initiates the measurement and returns the results if all frequencies have been measured. For more information on querying the results see `[SENSe:]LIST:POWer:RESult?`.

**Parameters:**

|                 |                                                                                                                       |
|-----------------|-----------------------------------------------------------------------------------------------------------------------|
| <Frequency>     | Defines the frequency. Each frequency corresponds to one list entry.<br>Range: 0 to Fmax<br>Default unit: Hz          |
| <RefLevel>      | Defines the reference level for a list entry.<br>Range: -130 to 30<br>Increment: 0.01<br>Default unit: dBm            |
| <RFAttenuation> | Defines the RF attenuation for a list entry.<br>Range: 0 to 70<br>Increment: 1<br>Default unit: dB                    |
| <EIAttenuation> | Defines the electronic attenuation for a list entry.<br>Range: 0 to 30<br>Increment: 1<br>Default unit: dB            |
| <FilterType>    | Selects the filter type for a list entry. For more information see <code>[SENSe:]BANDwidth[:RESolution]:TYPE</code> . |
| <RBW>           | Defines the resolution bandwidth for a list entry.                                                                    |
| <VBW>           | Defines the video bandwidth for a list entry.                                                                         |

|                       |                                                                                                                                                                                                                                                                                                                                                                                 |
|-----------------------|---------------------------------------------------------------------------------------------------------------------------------------------------------------------------------------------------------------------------------------------------------------------------------------------------------------------------------------------------------------------------------|
| <MeasTime>            | Defines the measurement time for a list entry.<br>Range: 1 $\mu$ s to 16000 s                                                                                                                                                                                                                                                                                                   |
| <TriggerLevel>        | The trigger level must be 0.                                                                                                                                                                                                                                                                                                                                                    |
| <b>Return values:</b> |                                                                                                                                                                                                                                                                                                                                                                                 |
| <PowerLevel>          | Power level for each frequency included in the measurement.<br>The command returns up to 3 power levels for each frequency, depending on the number of evaluation modes you have turned on with <code>[SENSE:]LIST:POWER:SET</code> .<br>The result is a list of floating point values separated by commas.<br>The unit depends on <code>CALCulate&lt;n&gt;:UNIT:POWER</code> . |

---

**[SENSE:]LIST:POWER:SET** <PeakPower>, <RMSPower>, <AVGPower>, <TriggerSource>, <TriggerSlope>, <TriggerOffset>, <GateLength>

This command defines global List Evaluation parameters.

These parameters are valid for every frequency you want to measure.

The state of the first three parameters (<PeakPower>, <RMSPower> and <AVGPower>) define the number of results for each frequency in the list.

Note that you have to set the trigger level *after* sending this command.

**Parameters:**

|                 |                                                                                                                                                                                 |
|-----------------|---------------------------------------------------------------------------------------------------------------------------------------------------------------------------------|
| <PeakPower>     | ON   OFF   0   1<br>Turns peak power evaluation on and off.<br>*RST: 1                                                                                                          |
| <RMSPower>      | ON   OFF   0   1<br>Turns RMS power evaluation on and off.<br>*RST: 0                                                                                                           |
| <AVGPower>      | ON   OFF   0   1<br>Turns average power evaluation on and off.<br>*RST: 0                                                                                                       |
| <TriggerSource> | EXTernal   EXT2   IMMEDIATE   IFPower   RFPower   VIDEO<br>Selects a trigger source.<br>For more information see <a href="#">Configuring Triggered and Gated Measurements</a> . |
| <TriggerSlope>  | NEGative   POSitive<br>Selects the trigger slop.                                                                                                                                |
| <TriggerOffset> | Defines the trigger delay.<br>Range: negative measurement time to 30 s<br>*RST: 0<br>Default unit: s                                                                            |

<GateLength> Defines the gate length for gated measurements. Setting 0 seconds turns gated measurements off. To perform gated measurements, the trigger source must be different from IMMEDIATE.

Range: 31.25 ns to 30 s  
\*RST: 0 s

---

#### [SENSe:]LIST:POWer:STATe <State>

This command turns the List Evaluation off.

#### Parameters:

<State> OFF | 0  
\*RST: 0

### 12.5.13.2 Example: Performing List Evaluation

The following example shows a list evaluation with the following configuration.

| No | Freq [MHz] | Ref Level [dBm] | RF Attenuation [dB] | EI Attenuation [dB] | Filter  | RBW    | VBW     | Meas Time | Trigger Level |
|----|------------|-----------------|---------------------|---------------------|---------|--------|---------|-----------|---------------|
| 1  | 935.2      | 0               | 10                  | ---                 | Normal  | 1 MHz  | 3 MHz   | 440 µs    | 0             |
| 2  | 935.4      | 0               | 10                  | 10                  | Channel | 30 kHz | 100 kHz | 440 µs    | 0             |
| 3  | 935.6      | 0               | 10                  | 20                  | Channel | 30 kHz | 100 kHz | 440 µs    | 0             |

```
-----Measurement with synchronization via service request-----
```

```
*ESE 1
*SRE 32
// Configures the status reporting system to produce a service request.
LIST:POW:SET ON,ON,OFF,EXT,POS,10us,434us
//Turns on the list evaluation, configures the global list evaluation settings and
//evaluates the peak and RMS power.
LIST:POW
935.2MHZ,0,10,OFF,NORM,1MHZ,3MHZ,440us,0,
935.4MHZ,0,10,10,CFIL,30KHZ,100KHZ,440us,0,
935.6MHZ,0,10,20,CFIL,30KHZ,100KHZ,440us,0;
*OPC
//Defines a list with 3 entries and initiates the measurement with synchronization to the end
//Analyzer produces a service request
//On service request:
SENS:LIST:POW:RES?
//Returns the results of the measurements, two for each frequency (peak and RMS power).

-----Initiliazing the measurement and querying results simultaneously-----
LIST:POW?
```



```

935.2MHZ,0,10,OFF,NORM,1MHZ,3MHZ,440us,0,
935.4MHZ,0,10,10,CFIL,30KHZ,100KHZ,440us,0,
935.6MHZ,0,10,20,CFIL,30KHZ,100KHZ,440us,0
//Defines a list with 3 entries, initiates the measurement and queries the results.
//Result example:
-28.3,-30.6,-38.1

```

## 12.5.14 Measuring the Pulse Power

All remote control commands specific to measuring the mean or peak pulse power (e.g. bursts in various telecommunications standards) are described here. This measurement is available via remote control only.

The Pulse Power measurement is a gated measurement that determines the power over a particular number of pulses. The measurement is controlled by an external trigger or the video signal. A separate trigger event is required for each burst included in the measurement. In case of an external trigger source, the trigger level corresponds to the TTL level. In case of a video signal, you can define any threshold.

The figure below shows the relations between the available trigger settings.

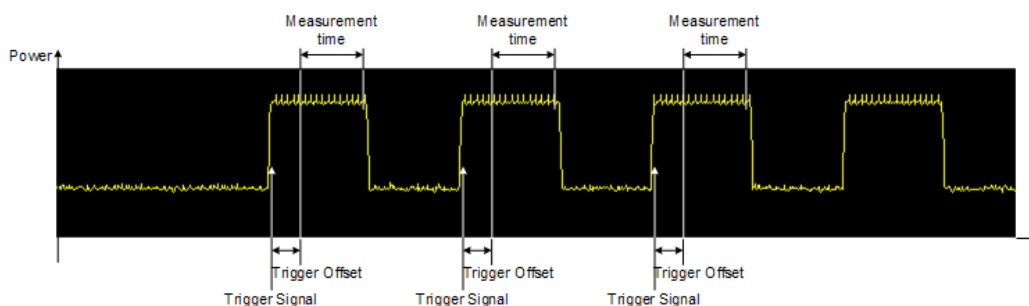

The measurement is always on trace 1, either with the peak detector to determine the peak power or the RMS detector to determine the RMS power. Overall, you can configure the measurement independent of the instrument setup with the commands listed below only, which results in faster measurements.



The Pulse Power measurement is incompatible to other measurement functions (e.g. marker functionality or statistics). If you use a command that controls those functions, the R&S FPS aborts the Pulse Power measurement.

The R&S FPS also aborts the Pulse Power measurement if you end the remote session.

The commands can be used in two different ways.

- Instrument setup, measurement and querying of the results in a single command line. With this method, there is the least delay between the measurement and the result output. However, it requires the control computer to wait for the response from the instrument.
- Instrument setup and querying of the result list at the end of the measurement: With this method, the control computer may be used for other activities while the

measurement is being performed. However, more time is needed for synchronization via service request.

### 12.5.14.1 Performing Pulse Power Measurements

The following commands control pulse power measurements.

|                                               |     |
|-----------------------------------------------|-----|
| CALCulate<n>:MARKer<m>:FUNCTION:MSUMmary..... | 762 |
| [SENSe:]MPOWER:FTYPE.....                     | 763 |
| [SENSe:]MPOWER:RESult[:LIST]?.....            | 763 |
| [SENSe:]MPOWER[:SEQuence].....                | 763 |
| [SENSe:]MPOWER:RESult:MIN?.....               | 764 |

#### CALCulate<n>:MARKer<m>:FUNCTION:MSUMmary

<TimeOffset>,<MeasTime>,<PulsePeriod>,<#OfPulses>

This command configures power measurements on pulses in the time domain.

To evaluate the pulse power, the R&S FPS uses the data captured during a previous measurement. The data recorded during the set measurement time is combined to a measured value for each pulse according to the detector specified and the indicated number of results is output as a list.

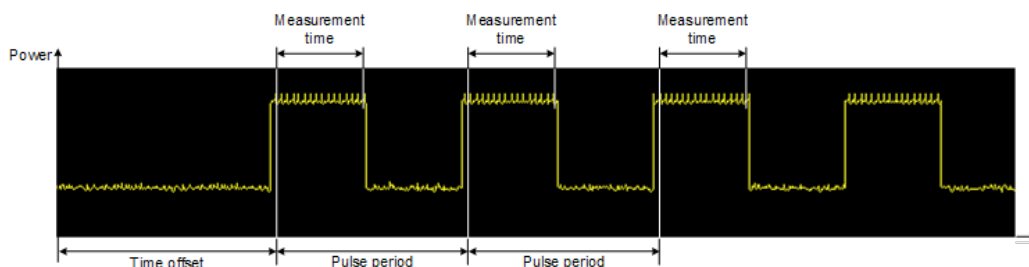

To get a valid result, you have to perform a complete measurement with synchronization to the end of the measurement before reading out the result. This is only possible for single sweep mode.

See also [INITiate<n>:CONTinuous](#) on page 635.

#### Suffix:

<n> [Window](#)

<m> [Marker](#)

#### Parameters:

<TimeOffset> Defines a time offset to start the measurement at the first pulse of a trace.

\*RST: 0

Default unit: s

<MeasTime> Defines the measurement time.

Default unit: s

<PulsePeriod> Defines the pulse period

<#OfPulses> Defines the number of pulses to measure.

**Example:** `CALC:MARK:FUNC:MSUM 50US,450US,576.9US,8`  
Evaluates data that contains 8 pulses during a measurement time of 450  $\mu$ s and a pulse period of 576.9  $\mu$ s. The evaluation starts with an offset of 50  $\mu$ s.

#### [SENSe:]MPOWer:FTYPe <FilterType>

This command selects the filter type for pulse power measurements.

**Parameters:**

|              |                |
|--------------|----------------|
| <FilterType> | <b>CFILter</b> |
|              | <b>NORMal</b>  |
|              | <b>P5</b>      |
|              | <b>RRC</b>     |

#### [SENSe:]MPOWer:RESult[:LIST]?

This command queries the results of the pulse power measurement.

This command may be used to obtain measurement results in an asynchronous way, using the service request mechanism for synchronization to the end of the measurement.

If there are no results, the command returns an error.

**Return values:**

|              |                                                                                                                            |
|--------------|----------------------------------------------------------------------------------------------------------------------------|
| <PulsePower> | List of pulse powers.<br>The number of values depends on the number of pulses you have been measuring.<br>The unit is dBm. |
|--------------|----------------------------------------------------------------------------------------------------------------------------|

**Usage:** Query only

#### [SENSe:]MPOWer[:SEQUence] <Frequency>, <RBW>, <MeasTime>, <TriggerSource>, <TriggerLevel>, <TriggerOffset>, <Detector>, <#OfPulses>

This command configures and initiates the pulse power measurement.

The R&S FPS caches all measurement parameters that you can set with this command. If you use the command repeatedly, the R&S FPS only changes those settings that you have actually changed before initiating the measurement. Thus, measurement times are kept as low as possible.

If you synchronize the measurement with \*OPC, the R&S FPS produces a service request when all frequencies have been measured and the number of individual measurements has been performed.

Note that using the command as a query initiates the measurement and returns the results if all frequencies have been measured. For more information on querying the results see [\[SENSe:\]LIST:POWer:RESult?](#).

**Parameters:**

|                 |                                                                                                                                                                                                                                                               |
|-----------------|---------------------------------------------------------------------------------------------------------------------------------------------------------------------------------------------------------------------------------------------------------------|
| <Frequency>     | Defines the pulse frequency.<br>Range: 0 to Fmax<br>Default unit: Hz                                                                                                                                                                                          |
| <RBW>           | Defines the resolution bandwidth.                                                                                                                                                                                                                             |
| <MeasTime>      | Defines the measurement time.<br>Range: 1 $\mu$ s to 30 s                                                                                                                                                                                                     |
| <TriggerSource> | EXTernal   EXT2   VIDEo<br>Selects a trigger source.<br>For more information see <a href="#">Configuring Triggered and Gated Measurements</a> .                                                                                                               |
| <TriggerLevel>  | Defines a trigger level.<br>The trigger level is available for the video trigger. In that case, the level is a percentage of the diagram height.<br>In case of an external trigger, the R&S FPS uses a fix TTL level.<br>Range: 0 to 100<br>Default unit: PCT |
| <TriggerOffset> | Defines the trigger delay.<br>Range: 0 s to 30 s<br>*RST: 0 s<br>Default unit: s                                                                                                                                                                              |
| <Detector>      | Selects the detector and therefore the way the measurement is evaluated.<br><b>MEAN</b><br>Calculates the RMS pulse power.<br><b>PEAK</b><br>Calculates the peak pulse power.                                                                                 |
| <#OfPulses>     | Defines the number of pulses included in the measurement.<br>Range: 1 to 32001                                                                                                                                                                                |

**Return values:**

|              |                                                                                                              |
|--------------|--------------------------------------------------------------------------------------------------------------|
| <PowerLevel> | Pulse power level.<br>The result is a list of floating point values separated by commas.<br>The unit is dBm. |
|--------------|--------------------------------------------------------------------------------------------------------------|

**[SENSe:]MPOWER:RESult:MIN?**

This command queries the lowest pulse power that has been measured during a pulse power measurement.

If there are no results, the command returns an error.

**Return values:**

|              |                                                                        |
|--------------|------------------------------------------------------------------------|
| <PulsePower> | Lowest power level of the pulse power measurement.<br>The unit is dBm. |
|--------------|------------------------------------------------------------------------|

**Usage:** Query only

### 12.5.14.2 Example: Performing a Pulse Power Measurement

The following example shows a pulse power measurement.

```

-----Measurement with synchronization via service request-----
*ESE 1
*SRE 32
// Configures the status reporting system to produce a service request.
MPOW:FTYP NORM
//Selects a Gaussian filter for the measurement.
MPOW 935.2MHZ,1MHZ,434us,VID,50,5us,MEAN,20;
*OPC
//Configures and initiates a measurement on 20 pulses with synchronization to the end.
//Analyzer produces a service request
//On service request:
MPOW:RES?
//Returns the results of the measurements (20 power levels).
MPOW:RES:MIN?
//Returns the lowest of the 20 power level that have been measured.

-----Initiliazing the measurement and querying results simultaneously-----
MPOW? 935.2MHZ,1MHZ,434us,VID,50,5us,MEAN,20
//Configures, initiates and queries the results of the measurement.
//Result example:
-105.225059509,-105.656074524,-105.423065186,-104.374649048,-103.059822083,-101.29511261,
-99.96534729,-99.7452468872,-99.6610794067,-100.327224731,-100.96686554,-101.450386047,
-102.150642395,-103.240142822,-105.95476532,-110.583129883,-115.7760849,-126.279388428,
-124.620399475,-116.97366333

```

## 12.6 Configuring the Result Display

The commands required to configure the screen display in a remote environment are described here.

The tasks for manual operation are described in [Chapter 8.1, "Result Display Configuration"](#), on page 393.

- [General Window Commands](#)..... 765
- [Working with Windows in the Display](#)..... 766
- [Examples: Configuring the Result Display](#)..... 773

### 12.6.1 General Window Commands

The following commands are required to configure general window layout, independent of the application.

Note that the suffix <n> always refers to the window *in the currently selected channel* (see [INSTrument\[:SElect\]](#) on page 627).

|                                                      |     |
|------------------------------------------------------|-----|
| <a href="#">DISPlay:FORMat</a> .....                 | 766 |
| <a href="#">DISPlay[:WINDow&lt;n&gt;]:SIZE</a> ..... | 766 |

---

### DISPlay:FORMat <Format>

This command determines which tab is displayed.

#### Parameters:

|          |                                                                                                                                                             |
|----------|-------------------------------------------------------------------------------------------------------------------------------------------------------------|
| <Format> | <b>SPLit</b><br>Displays the MultiView tab with an overview of all active channels<br>(See <a href="#">Chapter 5.2, "R&amp;S MultiView"</a> , on page 116). |
|          | <b>SINGLE</b><br>Displays the measurement channel that was previously focused.                                                                              |
| *RST:    | SING                                                                                                                                                        |

**Example:**           DISP:FORM SPL

---

### DISPlay[:WINDow<n>]:SIZE <Size>

This command maximizes the size of the selected result display window *temporarily*. To change the size of several windows on the screen permanently, use the `LAY:SPL` command (see [LAYout:SPLitter](#) on page 770).

#### Suffix:

<n>                   Window

#### Parameters:

|        |                                                                                                                                                                         |
|--------|-------------------------------------------------------------------------------------------------------------------------------------------------------------------------|
| <Size> | <b>LARGE</b><br>Maximizes the selected window to full screen.<br>Other windows are still active in the background.                                                      |
|        | <b>SMALI</b><br>Reduces the size of the selected window to its original size.<br>If more than one measurement window was displayed originally, these are visible again. |
| *RST:  | SMALI                                                                                                                                                                   |

**Example:**           DISP:WIND2:SIZE LARG

## 12.6.2 Working with Windows in the Display

The following commands are required to change the evaluation type and rearrange the screen layout for a channel as you do using the SmartGrid in manual operation. Since the available evaluation types depend on the selected application, some parameters for the following commands also depend on the selected channel.

Note that the suffix <n> always refers to the window *in the currently selected channel* (see `INSTrument[:SElect]` on page 627).

|                                                     |     |
|-----------------------------------------------------|-----|
| <code>LAYout:ADD[:WINDow]?</code> .....             | 767 |
| <code>LAYout:CATalog[:WINDow]?</code> .....         | 768 |
| <code>LAYout:IDENtify[:WINDow]?</code> .....        | 768 |
| <code>LAYout:MOVE[:WINDow]</code> .....             | 769 |
| <code>LAYout:REMOve[:WINDow]</code> .....           | 769 |
| <code>LAYout:REPLace[:WINDow]</code> .....          | 769 |
| <code>LAYout:SPLitter</code> .....                  | 770 |
| <code>LAYout:WINDow&lt;n&gt;:ADD?</code> .....      | 771 |
| <code>LAYout:WINDow&lt;n&gt;:IDENtify?</code> ..... | 772 |
| <code>LAYout:WINDow&lt;n&gt;:REMOve</code> .....    | 772 |
| <code>LAYout:WINDow&lt;n&gt;:REPLace</code> .....   | 772 |

---

### **LAYout:ADD[:WINDow]? <WindowName>,<Direction>,<WindowType>**

This command adds a window to the display in the active channel.

This command is always used as a query so that you immediately obtain the name of the new window as a result.

To replace an existing window, use the `LAYout:REPLace[:WINDow]` command.

#### **Query parameters:**

|                                 |                                                                                                                                                                                                                                                                 |
|---------------------------------|-----------------------------------------------------------------------------------------------------------------------------------------------------------------------------------------------------------------------------------------------------------------|
| <code>&lt;WindowName&gt;</code> | String containing the name of the existing window the new window is inserted next to.<br>By default, the name of a window is the same as its index. To determine the name and index of all active windows, use the <code>LAYout:CATalog[:WINDow]?</code> query. |
| <code>&lt;Direction&gt;</code>  | LEFT   RIGHT   ABOVE   BELOW<br>Direction the new window is added relative to the existing window.                                                                                                                                                              |
| <code>&lt;WindowType&gt;</code> | text value<br>Type of result display (evaluation method) you want to add. See the table below for available parameter values.                                                                                                                                   |

#### **Return values:**

|                                    |                                                                                                         |
|------------------------------------|---------------------------------------------------------------------------------------------------------|
| <code>&lt;NewWindowName&gt;</code> | When adding a new window, the command returns its name (by default the same as its number) as a result. |
|------------------------------------|---------------------------------------------------------------------------------------------------------|

#### **Example:**

```
LAY:ADD? '1', LEFT, MTAB
```

Result:

```
'2'
```

Adds a new window named '2' with a marker table to the left of window 1.

#### **Usage:**

Query only

**Manual operation:** See " [Diagram](#) " on page 394  
 See " [Marker Table](#) " on page 394  
 See " [Marker Peak List](#) " on page 394  
 See " [Result Summary](#) " on page 395  
 See " [Spectrogram](#) " on page 395

**Table 12-3:** <WindowType> parameter values for the Spectrum application

| Parameter value | Window type      |
|-----------------|------------------|
| DIAGram         | Diagram          |
| MTABle          | Marker table     |
| PEAKlist        | Marker peak list |
| RSUMmary        | Result summary   |
| SGRAm           | Spectrogram      |

### LAYout:CATalog[:WINDow]?

This command queries the name and index of all active windows in the active channel from top left to bottom right. The result is a comma-separated list of values for each window, with the syntax:

<WindowName\_1>,<WindowIndex\_1>..<WindowName\_n>,<WindowIndex\_n>

#### Return values:

<WindowName>      string  
 Name of the window.  
 In the default state, the name of the window is its index.

<WindowIndex>    **numeric value**  
 Index of the window.

#### Example:

LAY:CAT?

Result:

'2',2,'1',1

Two windows are displayed, named '2' (at the top or left), and '1' (at the bottom or right).

**Usage:**            Query only

### LAYout:IDENTify[:WINDow]? <WindowName>

This command queries the **index** of a particular display window in the active channel.

**Note:** to query the **name** of a particular window, use the `LAYout:WINDow<n>:IDENTify?` query.

#### Query parameters:

<WindowName>      String containing the name of a window.

#### Return values:

<WindowIndex>    Index number of the window.



**Example:** `LAY:WIND:IDEN? '2'`  
 Queries the index of the result display named '2'.  
**Response:**  
 2

**Usage:** Query only

**LAYout:MOVE[:WINDow] <arg0>, <arg1>, <arg2>**

**Setting parameters:**

**<arg0>** String containing the name of an existing window that is to be moved.  
 By default, the name of a window is the same as its index. To determine the name and index of all active windows in the active channel, use the `LAYout:CATalog[:WINDow]?` query.

**<arg1>** String containing the name of an existing window the selected window is placed next to or replaces.  
 By default, the name of a window is the same as its index. To determine the name and index of all active windows in the active channel, use the `LAYout:CATalog[:WINDow]?` query.

**<arg2>** LEFT | RIGHT | ABOVE | BELOW | REPLACE  
 Destination the selected window is moved to, relative to the reference window.

**Example:** `LAY:MOVE '4', '1', LEFT`  
 Moves the window named '4' to the left of window 1.

**Example:** `LAY:MOVE '1', '3', REPL`  
 Replaces the window named '3' by window 1. Window 3 is deleted.

**Usage:** Setting only

**LAYout:REMOve[:WINDow] <WindowName>**

This command removes a window from the display in the active channel.

**Setting parameters:**

**<WindowName>** String containing the name of the window.  
 In the default state, the name of the window is its index.

**Example:** `LAY:REM '2'`  
 Removes the result display in the window named '2'.

**Usage:** Event

**LAYout:REPLace[:WINDow] <WindowName>, <WindowType>**

This command replaces the window type (for example from "Diagram" to "Result Summary") of an already existing window in the active channel while keeping its position, index and window name.

To add a new window, use the `LAYout:ADD[:WINDow]?` command.

#### Setting parameters:

<WindowName> String containing the name of the existing window.  
By default, the name of a window is the same as its index. To determine the name and index of all active windows in the active channel, use the `LAYout:CATalog[:WINDow]?` query.

<WindowType> Type of result display you want to use in the existing window.  
See `LAYout:ADD[:WINDow]?` on page 767 for a list of available window types.

**Example:** `LAY:REPL:WIND '1',MTAB`  
Replaces the result display in window 1 with a marker table.

**Usage:** Setting only

#### `LAYout:SPLitter <Index1>,<Index2>,<Position>`

This command changes the position of a splitter and thus controls the size of the windows on each side of the splitter.

Compared to the `DISPlay[:WINDow<n>]:SIZE` on page 766 command, the `LAYout:SPLitter` changes the size of all windows to either side of the splitter permanently, it does not just maximize a single window temporarily.

Note that windows must have a certain minimum size. If the position you define conflicts with the minimum size of any of the affected windows, the command will not work, but does not return an error.

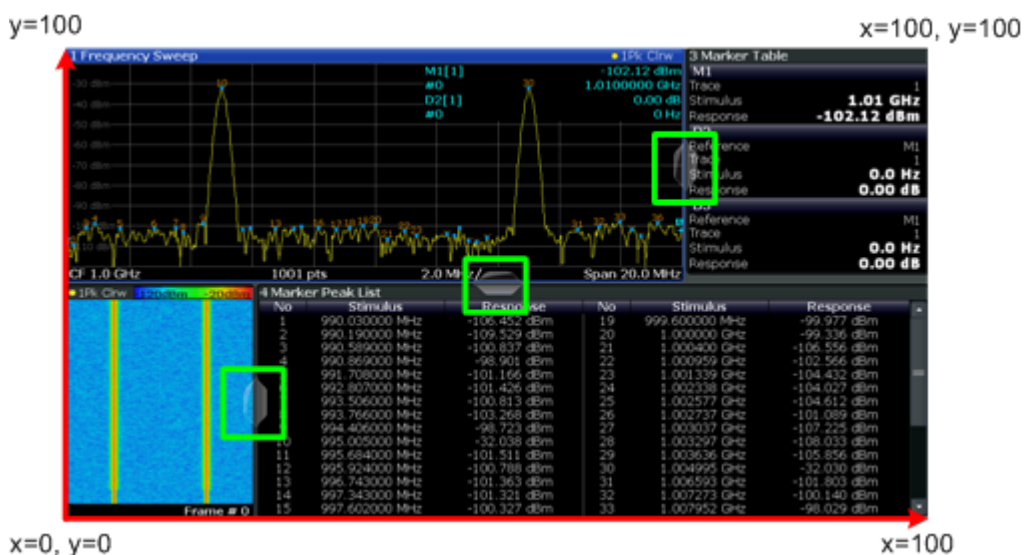

Figure 12-1: SmartGrid coordinates for remote control of the splitters

#### Parameters:

<Index1> The index of one window the splitter controls.

<Index2> The index of a window on the other side of the splitter.

|                         |                                                                                                                                                                                                                                                                                                                                                                                                                                                                                                                                                                                                                              |
|-------------------------|------------------------------------------------------------------------------------------------------------------------------------------------------------------------------------------------------------------------------------------------------------------------------------------------------------------------------------------------------------------------------------------------------------------------------------------------------------------------------------------------------------------------------------------------------------------------------------------------------------------------------|
| <b>&lt;Position&gt;</b> | <p>New vertical or horizontal position of the splitter as a fraction of the screen area (without channel and status bar and softkey menu).</p> <p>The point of origin (x = 0, y = 0) is in the lower left corner of the screen. The end point (x = 100, y = 100) is in the upper right corner of the screen. (See <a href="#">Figure 12-1</a>.)</p> <p>The direction in which the splitter is moved depends on the screen layout. If the windows are positioned horizontally, the splitter also moves horizontally. If the windows are positioned vertically, the splitter also moves vertically.</p> <p>Range: 0 to 100</p> |
| <b>Example:</b>         | <pre>LAY:SPL 1,3,50</pre> <p>Moves the splitter between window 1 ('Frequency Sweep') and 3 ('Marker Table') to the center (50%) of the screen, i.e. in the figure above, to the left.</p>                                                                                                                                                                                                                                                                                                                                                                                                                                    |
| <b>Example:</b>         | <pre>LAY:SPL 1,4,70</pre> <p>Moves the splitter between window 1 ('Frequency Sweep') and 3 ('Marker Peak List') towards the top (70%) of the screen.</p> <p>The following commands have the exact same effect, as any combination of windows above and below the splitter moves the splitter vertically.</p> <pre>LAY:SPL 3,2,70 LAY:SPL 4,1,70 LAY:SPL 2,1,70</pre>                                                                                                                                                                                                                                                         |

---

#### **LAYout:WINDow<n>:ADD? <Direction>,<WindowType>**

This command adds a measurement window to the display. Note that with this command, the suffix <n> determines the existing window next to which the new window is added, as opposed to [LAYout:ADD\[:WINDow\]?](#), for which the existing window is defined by a parameter.

To replace an existing window, use the [LAYout:WINDow<n>:REPLace](#) command.

This command is always used as a query so that you immediately obtain the name of the new window as a result.

**Suffix:**

<n> [Window](#)

**Parameters:**

<Direction> LEFT | RIGHT | ABOVE | BELOW

<WindowType> Type of measurement window you want to add.  
See [LAYout:ADD\[:WINDow\]?](#) on page 767 for a list of available window types.

**Return values:**

<NewWindowName> When adding a new window, the command returns its name (by default the same as its number) as a result.

**Example:**            `LAY:WIND1:ADD? LEFT,MTAB`  
**Result:**  
                       '2'  
 Adds a new window named '2' with a marker table to the left of window 1.

**Usage:**            Query only

#### **LAYout:WINDow<n>:IDENtify?**

This command queries the **name** of a particular display window (indicated by the <n> suffix) in the active channel.

**Note:** to query the **index** of a particular window, use the `LAYout:IDENtify[:WINDow]?` command.

**Suffix:**  
 <n>                    [Window](#)

**Return values:**  
 <WindowName>        String containing the name of a window.  
 In the default state, the name of the window is its index.

**Example:**            `LAY:WIND2:IDEN?`  
 Queries the name of the result display in window 2.  
**Response:**  
                       '2'

**Usage:**            Query only

#### **LAYout:WINDow<n>:REMOve**

This command removes the window specified by the suffix <n> from the display in the active channel.

The result of this command is identical to the `LAYout:REMOve[:WINDow]` command.

**Suffix:**  
 <n>                    [Window](#)

**Example:**            `LAY:WIND2:REM`  
 Removes the result display in window 2.

**Usage:**            Event

#### **LAYout:WINDow<n>:REPLace <WindowType>**

This command changes the window type of an existing window (specified by the suffix <n>) in the active channel.

The effect of this command is identical to the `LAYout:REPLace[:WINDow]` command.

To add a new window, use the `LAYout:WINDow<n>:ADD?` command.

**Suffix:**<n> [Window](#)**Setting parameters:**

<WindowType> Type of measurement window you want to replace another one with.  
See [LAYout:ADD\[:WINDow\]?](#) on page 767 for a list of available window types.

**Example:**

LAY:WIND2:REPL MTAB

Replaces the result display in window 2 with a marker table.

**Usage:**

Setting only

## 12.6.3 Examples: Configuring the Result Display

The following example demonstrates how to configure result displays in a remote environment.

### 12.6.3.1 Example 1: Adding and Arranging Windows

Starting from the default initial display in the Spectrum application (Frequency Sweep), we will configure the following result displays:

|                   |                    |
|-------------------|--------------------|
| 1 Frequency Sweep | 3 Marker Table     |
| 2 Spectrogram     | 4 Marker Peak List |

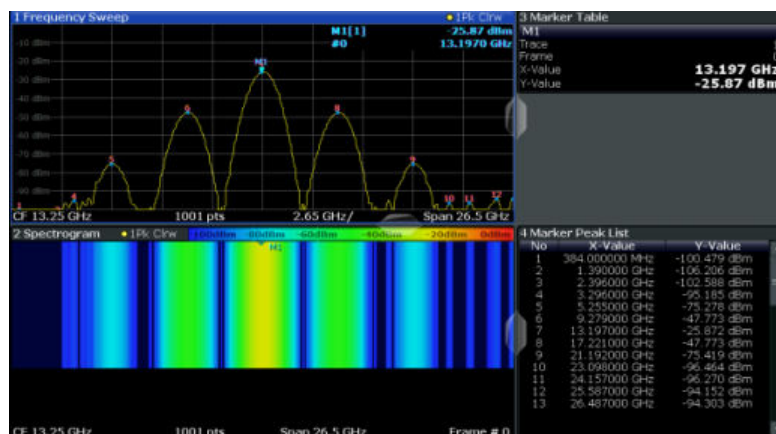

```
//-----Resetting the instrument -----
*RST
//----- Adding new windows -----
//Add a Spectrogram window beneath the Frequency Sweep window
LAY:ADD? '1',BEL,SGR
//Result: window number: '2'
//Add a Marker Table window to the right of the Frequency Sweep window
LAY:ADD? '1',RIGHT,MTAB
//Result: window number: '3'
```

```

//Add a Marker Peak List window to the right of the Spectrogram window
LAY:WIND2:ADD? RIGH,PEAK
//Result: window number: '4'

//----- Changing the size of individual windows -----
//Move the splitter between the Frequency Sweep window and the Marker Table
//window to enlarge the spectrum display to 60% of the entire width.
LAY:SPL 1,3,60
//Move the splitter between the Spectrogram window and the Marker Peak List
//window to enlarge the Spectrogram display to 60% of the entire width.
LAY:SPL 2,4,60

//----- Querying all displayed windows -----
//Query the name and number of all displayed windows
//(from top left to bottom right)
LAY:CAT?
//Result : '1',1,'2',2,'3',3,'4',4

//----- Maximizing a Window -----
//Maximize the window "2 Spectrogram"
DISP:WIND2:SIZE LARG

//-----Restore multiple window display -----
DISP:WIND2:SIZE SMAL

```

### 12.6.3.2 Example 2: Replacing and Removing Windows

Starting from the display configured in [Example 1: Adding and Arranging Windows](#), we will remove and replace result displays to obtain the following configuration:

|                   |
|-------------------|
| 1 Frequency Sweep |
| 4 Marker Table    |

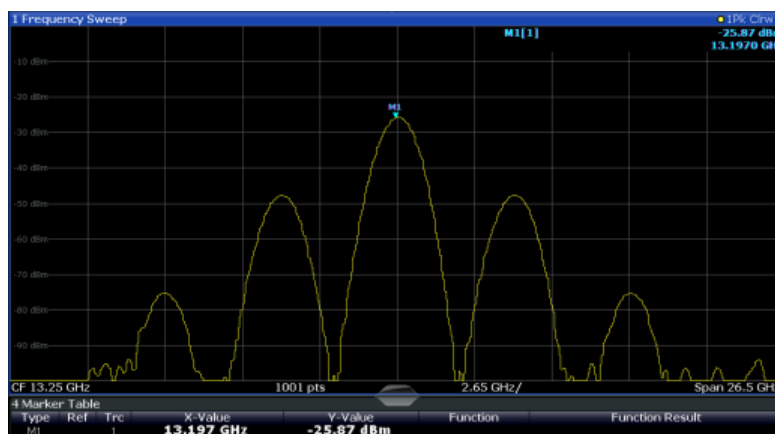

```
//----- Preparing the configuration from example 1 -----
*RST
LAY:ADD? '1',BEL,SGR
LAY:ADD? '1',RIGH,MTAB
LAY:WIND2:ADD? RIGH,PEAK
LAY:CAT?
//Result : '1',1,'2',2,'3',3,'4',4
//Remove Spectrogram
LAY:WIND2:REM //Remove Marker Table window
LAY:REM '3'
//Replace Marker Peak List window by Marker Table
LAY:REPL '4',MTAB

//----- Querying all displayed windows -----
//Query the name and number of all displayed windows (from top left to bottom right)
LAY:CAT?
//Result : '1',1,'4',4

//----- Changing the size of individual windows -----
//Move the splitter between the Frequency Sweep window and the Marker Table window
//to enlarge the spectrum display to 80% of the entire height.
LAY:SPL 1,4,80
```

## 12.7 Setting Basic Measurement Parameters

All commands that set measurement-independent parameters are described here.

- [Defining the Frequency and Span](#).....776
- [Configuring Bandwidth and Sweep Settings](#).....785
- [Configuring the Vertical Axis \(Amplitude, Scaling\)](#).....792
- [Configuring Triggered and Gated Measurements](#).....799
- [Adjusting Settings Automatically](#).....809
- [Configuring the Data Input and Output](#).....812

## 12.7.1 Defining the Frequency and Span

The commands required to configure the frequency and span settings in a remote environment are described here. The tasks for manual operation are described in [Chapter 7.3, "Frequency and Span Configuration"](#), on page 343.

- [Defining the Frequency Range](#)..... 776
- [Adjusting Settings Automatically](#)..... 780
- [Configuring Signal Tracking](#)..... 783

### 12.7.1.1 Defining the Frequency Range

|                                                                          |     |
|--------------------------------------------------------------------------|-----|
| <a href="#">CALCulate&lt;n&gt;:MARKer&lt;m&gt;:FUNCTION:CENTer</a> ..... | 776 |
| <a href="#">CALCulate&lt;n&gt;:MARKer&lt;m&gt;:FUNCTION:CSTep</a> .....  | 776 |
| <a href="#">DISPlay[:WINDow&lt;n&gt;]:TRACe:X:SPACing</a> .....          | 777 |
| <a href="#">[SENSe:]FREQUency:CENTer</a> .....                           | 777 |
| <a href="#">[SENSe:]FREQUency:CENTer:STEP</a> .....                      | 777 |
| <a href="#">[SENSe:]FREQUency:CENTer:STEP:AUTO</a> .....                 | 778 |
| <a href="#">[SENSe:]FREQUency:CENTer:STEP:LINK</a> .....                 | 778 |
| <a href="#">[SENSe:]FREQUency:CENTer:STEP:LINK:FACTor</a> .....          | 779 |
| <a href="#">[SENSe:]FREQUency:OFFSet</a> .....                           | 779 |
| <a href="#">[SENSe:]FREQUency:SPAN</a> .....                             | 779 |
| <a href="#">[SENSe:]FREQUency:SPAN:FULL</a> .....                        | 780 |
| <a href="#">[SENSe:]FREQUency:START</a> .....                            | 780 |
| <a href="#">[SENSe:]FREQUency:STOP</a> .....                             | 780 |

---

#### **CALCulate<n>:MARKer<m>:FUNCTION:CENTer**

This command matches the center frequency to the frequency of a marker.

If you use the command in combination with a delta marker, that delta marker is turned into a normal marker.

#### **Suffix:**

<n>                      [Window](#)

<m>                      [Marker](#)

#### **Example:**

`CALC:MARK2:FUNC:CENT`

Sets the center frequency to the frequency of marker 2.

#### **Usage:**

Event

**Manual operation:** See "[Center Frequency = Marker Frequency](#)" on page 420

---

#### **CALCulate<n>:MARKer<m>:FUNCTION:CSTep**

This command matches the center frequency step size to the current marker frequency.

The command turns delta markers into normal markers.



**Suffix:**  
 <n> [Window](#)  
 <m> [Marker](#)  
**Usage:** Event

### **DISPlay[:WINDow<n>]:TRACe:X:SPACing <ScalingType>**

This command selects the scaling of the x-axis.

**Suffix:**  
 <n> [Window](#)

**Parameters:**  
 <ScalingType> **LOGarithmic**  
 Logarithmic scaling.  
**LINear**  
 Linear scaling.  
 \*RST: LINear

**Example:** DISP:TRAC:X:SPAC LOG

**Manual operation:** See "[Frequency Axis Scaling](#)" on page 347

### **[SENSe:]FREQuency:CENTer <Frequency>**

This command defines the center frequency.

**Parameters:**  
 <Frequency> The allowed range and  $f_{\max}$  is specified in the data sheet.  
**UP**  
 Increases the center frequency by the step defined using the  
[\[SENSe:\]FREQuency:CENTer:STEP](#) command.  
**DOWN**  
 Decreases the center frequency by the step defined using the  
[\[SENSe:\]FREQuency:CENTer:STEP](#) command.  
 \*RST:  $f_{\max}/2$   
 Default unit: Hz

**Example:**  
 FREQ:CENT 100 MHz  
 FREQ:CENT:STEP 10 MHz  
 FREQ:CENT UP  
 Sets the center frequency to 110 MHz.

**Manual operation:** See "[Center Frequency](#)" on page 347  
 See "[Frequency](#)" on page 380

### **[SENSe:]FREQuency:CENTer:STEP <StepSize>**

This command defines the center frequency step size.

You can increase or decrease the center frequency quickly in fixed steps using the `SENS:FREQ UP` AND `SENS:FREQ DOWN` commands, see [\[SENSe:\]FREQuency:CENTer](#) on page 777.

**Parameters:**

<StepSize>  $f_{\max}$  is specified in the data sheet.  
 Range: 1 to fMAX  
 \*RST: 0.1 x span  
 Default unit: Hz

**Example:**

```
//Set the center frequency to 110 MHz.
FREQ:CENT 100 MHz
FREQ:CENT:STEP 10 MHz
FREQ:CENT UP
```

**Manual operation:** See "[Center Frequency Stepsize](#)" on page 348

**[SENSe:]FREQuency:CENTer:STEP:AUTO <State>**

This command couples or decouples the center frequency step size to the span.

In time domain (zero span) measurements, the center frequency is coupled to the RBW.

**Parameters:**

<State> ON | OFF | 0 | 1  
 \*RST: 1

**Example:**

```
FREQ:CENT:STEP:AUTO ON
Activates the coupling of the step size to the span.
```

**[SENSe:]FREQuency:CENTer:STEP:LINK <CouplingType>**

This command couples and decouples the center frequency step size to the span or the resolution bandwidth.

**Parameters:**

<CouplingType> **SPAN**  
 Couples the step size to the span. Available for measurements in the frequency domain.  
**RBW**  
 Couples the step size to the resolution bandwidth. Available for measurements in the time domain.  
**OFF**  
 Decouples the step size.  
 \*RST: SPAN

**Example:**

```
//Couple step size to span
FREQ:CENT:STEP:LINK SPAN
```

**Manual operation:** See "[Center Frequency Stepsize](#)" on page 348

**[SENSe:]FREQUENCY:CENTer:STEP:LINK:FACTOR <Factor>**

This command defines a step size factor if the center frequency step size is coupled to the span or the resolution bandwidth.

**Parameters:**

<Factor> 1 to 100 PCT  
\*RST: 10

**Example:** //Couple frequency step size to span and define a step size factor

```
FREQ:CENT:STEP:LINK SPAN
FREQ:CENT:STEP:LINK:FACT 20PCT
```

**Manual operation:** See "[Center Frequency Stepsize](#)" on page 348

**[SENSe:]FREQUENCY:OFFSet <Offset>**

This command defines a frequency offset.

If this value is not 0 Hz, the application assumes that the input signal was frequency shifted outside the application. All results of type "frequency" will be corrected for this shift numerically by the application.

See also "[Frequency Offset](#)" on page 349.

**Note:** In MSRA mode, the setting command is only available for the MSRA Master. For MSRA slave applications, only the query command is available.

**Parameters:**

<Offset> Range: -100 GHz to 100 GHz  
\*RST: 0 Hz

**Example:** FREQ:OFFS 1GHZ

**Manual operation:** See "[Frequency Offset](#)" on page 349

**[SENSe:]FREQUENCY:SPAN <Span>**

This command defines the frequency span.

If you set a span of 0 Hz in the Spectrum application, the R&S FPS starts a measurement in the time domain.

**Parameters:**

<Span> The minimum span for measurements in the frequency domain is 10 Hz.

Range: 0 Hz to fmax  
\*RST: Full span

**Manual operation:** See "[Zero Span](#)" on page 125  
See "[Span](#)" on page 347  
See "[Zero Span](#)" on page 348  
See "[Last Span](#)" on page 348

**[SENSe:]FREQuency:SPAN:FULL**

This command restores the full span.

**Usage:** Event

**Manual operation:** See " [Full Span](#) " on page 348

**[SENSe:]FREQuency:STARt <Frequency>**

This command defines a start frequency for measurements in the frequency domain.

**Parameters:**

<Frequency> 0 to (fmax - min span)

\*RST: 0

**Example:** `FREQ:STAR 20MHz`

**Manual operation:** See " [Frequency Sweep](#) " on page 124  
See " [Start / Stop](#) " on page 347

**[SENSe:]FREQuency:STOP <Frequency>**

This command defines a stop frequency for measurements in the frequency domain.

**Parameters:**

<Frequency> min span to fmax

\*RST: fmax

**Example:** `FREQ:STOP 2000 MHz`

**Manual operation:** See " [Frequency Sweep](#) " on page 124  
See " [Start / Stop](#) " on page 347

**12.7.1.2 Adjusting Settings Automatically**

The commands required to adjust settings automatically in a remote environment are described here.

The tasks for manual operation are described in [Chapter 7.7, "Adjusting Settings Automatically"](#), on page 389.

**MSRA operating mode**

In MSRA operating mode, settings related to data acquisition (measurement time, hysteresis) can only be adjusted automatically in the MSRA Master, not in the MSRA applications.

|                                                                      |     |
|----------------------------------------------------------------------|-----|
| <a href="#">[SENSe:]ADJust:ALL</a> .....                             | 781 |
| <a href="#">[SENSe:]ADJust:CONFigure[:LEVel]:DURation</a> .....      | 781 |
| <a href="#">[SENSe:]ADJust:CONFigure[:LEVel]:DURation:MODE</a> ..... | 781 |
| <a href="#">[SENSe:]ADJust:CONFigure:HYSTeresis:LOWer</a> .....      | 782 |

|                                                |     |
|------------------------------------------------|-----|
| [SENSe:]ADJust:CONFigure:HYSteresis:UPPer..... | 782 |
| [SENSe:]ADJust:CONFigure:TRIGger.....          | 783 |
| [SENSe:]ADJust:FREQuency.....                  | 783 |
| [SENSe:]ADJust:LEVel.....                      | 783 |

---

### [SENSe:]ADJust:ALL

This command initiates a measurement to determine and set the ideal settings for the current task automatically (only once for the current measurement).

This includes:

- Center frequency
- Reference level

**Example:** ADJ:ALL

**Usage:** Event

**Manual operation:** See "[Adjusting all Determinable Settings Automatically \( Auto All \)](#)" on page 390

---

### [SENSe:]ADJust:CONFigure[:LEVel]:DURation <Duration>

In order to determine the ideal reference level, the R&S FPS performs a measurement on the current input data. This command defines the length of the measurement if `[SENSe:]ADJust:CONFigure[:LEVel]:DURation:MODE` is set to `MANual`.

**Parameters:**

<Duration>            Numeric value in seconds  
 Range:            0.001 to 16000.0  
 \*RST:            0.001  
 Default unit: s

**Example:** ADJ:CONF:DUR:MODE MAN  
 Selects manual definition of the measurement length.  
 ADJ:CONF:LEV:DUR 5ms  
 Length of the measurement is 5 ms.

**Manual operation:** See "[Changing the Automatic Measurement Time \( Meastime Manual \)](#)" on page 391

---

### [SENSe:]ADJust:CONFigure[:LEVel]:DURation:MODE <Mode>

In order to determine the ideal reference level, the R&S FPS performs a measurement on the current input data. This command selects the way the R&S FPS determines the length of the measurement .

**Parameters:**

&lt;Mode&gt;

**AUTO**

The R&S FPS determines the measurement length automatically according to the current input data.

**MANual**

The R&S FPS uses the measurement length defined by `[SENSe:]ADJust:CONFigure[:LEVel]:DURation` on page 781.

\*RST: AUTO

**Manual operation:** See "[Resetting the Automatic Measurement Time \( Meastime Auto \)](#)" on page 391  
See "[Changing the Automatic Measurement Time \( Meastime Manual \)](#)" on page 391

**[SENSe:]ADJust:CONFigure:HYSTerisis:LOWer <Threshold>**

When the reference level is adjusted automatically using the `[SENSe:]ADJust:LEVel` on page 783 command, the internal attenuators and the preamplifier are also adjusted. In order to avoid frequent adaptation due to small changes in the input signal, you can define a hysteresis. This setting defines a lower threshold the signal must fall below (compared to the last measurement) before the reference level is adapted automatically.

**Parameters:**

&lt;Threshold&gt;

Range: 0 dB to 200 dB

\*RST: +1 dB

Default unit: dB

**Example:**

`SENS:ADJ:CONF:HYST:LOW 2`

For an input signal level of currently 20 dBm, the reference level will only be adjusted when the signal level falls below 18 dBm.

**Manual operation:** See "[Lower Level Hysteresis](#)" on page 392

**[SENSe:]ADJust:CONFigure:HYSTerisis:UPPer <Threshold>****Parameters:**

&lt;Threshold&gt;

Range: 0 dB to 200 dB

\*RST: +1 dB

Default unit: dB

**Example:**

`SENS:ADJ:CONF:HYST:UPP 2`

**Example:**

For an input signal level of currently 20 dBm, the reference level will only be adjusted when the signal level rises above 22 dBm.

**Manual operation:** See "[Upper Level Hysteresis](#)" on page 391

**[SENSe:]ADJ:CONF:TRIGger <State>**

Defines the behavior of the measurement when adjusting a setting automatically (using `SENS:ADJ:LEV ON`, for example).

See "[Adjusting settings automatically during triggered measurements](#)" on page 390.

**Parameters:**

&lt;State&gt;

**ON | 1**

The measurement for automatic adjustment waits for the trigger.

**OFF | 0**

The measurement for automatic adjustment is performed immediately, without waiting for a trigger.

\*RST: 1

**[SENSe:]ADJ:FREQuency**

This command sets the center frequency to the frequency with the highest signal level in the current frequency range.

At the same time, the optimal reference level is also set (see [\[SENSe:\]ADJ:LEVel](#) on page 783).

**Example:** ADJ:FREQ**Usage:** Event**Manual operation:** See "[Adjusting the Center Frequency Automatically \( Auto Frequency \)](#)" on page 390**[SENSe:]ADJ:LEVel**

This command initiates a single (internal) measurement that evaluates and sets the ideal reference level for the current input data and measurement settings. This ensures that the settings of the RF attenuation and the reference level are optimally adjusted to the signal level without overloading the R&S FPS or limiting the dynamic range by an S/N ratio that is too small.

**Example:** ADJ:LEV**Usage:** Event**Manual operation:** See "[Setting the Reference Level Automatically \( Auto Level \)](#)" on page 356**12.7.1.3 Configuring Signal Tracking**

When signal tracking is activated, the maximum signal is determined after each frequency sweep and the center frequency is set to the frequency of this signal. Thus with drifting signals the center frequency follows the signal.

For more details see [Chapter 7.3.1, "Impact of the Frequency and Span Settings"](#), on page 343..

|                                                                                    |     |
|------------------------------------------------------------------------------------|-----|
| <a href="#">CALCulate&lt;n&gt;:MARKer&lt;m&gt;:FUNCTION:STRack[:STATe]</a> .....   | 784 |
| <a href="#">CALCulate&lt;n&gt;:MARKer&lt;m&gt;:FUNCTION:STRack:BANDwidth</a> ..... | 784 |
| <a href="#">CALCulate&lt;n&gt;:MARKer&lt;m&gt;:FUNCTION:STRack:THReshold</a> ..... | 784 |
| <a href="#">CALCulate&lt;n&gt;:MARKer&lt;m&gt;:FUNCTION:STRack:TRACe</a> .....     | 785 |

---

#### **CALCulate<n>:MARKer<m>:FUNCTION:STRack[:STATe] <State>**

This command turns signal tracking on and off.

##### **Suffix:**

<n>, <m>                    irrelevant

##### **Parameters:**

<State>                    ON | OFF | 1 | 0  
 \*RST:                    0

**Manual operation:**    See "[Signal Tracking](#)" on page 350

---

#### **CALCulate<n>:MARKer<m>:FUNCTION:STRack:BANDwidth <Bandwidth>**

This command defines the bandwidth around the center frequency that is included in the signal tracking process.

Note that you have to turn on signal tracking before you can use the command.

##### **Suffix:**

<n>, <m>                    irrelevant

##### **Parameters:**

<Bandwidth>              Range:        10 Hz to Max span  
 \*RST:                    (= span/10 on activating the function)  
 Default unit: Hz

**Manual operation:**    See "[Signal Tracking](#)" on page 350

---

#### **CALCulate<n>:MARKer<m>:FUNCTION:STRack:THReshold <Level>**

This command defines the threshold level for the signal tracking process.

Note that you have to turn on signal tracking before you can use the command.

##### **Suffix:**

<n>, <m>                    irrelevant

##### **Parameters:**

<Level>                    The unit depends on [CALCulate<n>:UNIT:POWER](#).  
 Range:                  -130 dBm to 30 dBm  
 \*RST:                    -120 dBm

**Manual operation:**    See "[Signal Tracking](#)" on page 350



---

**CALCulate<n>:MARKer<m>:FUNCTION:STRack:TRACe <TraceNumber>**

This command selects the trace on which the largest signal is searched for.

**Suffix:**

<n>, <m>                      irrelevant

**Parameters:**

<TraceNumber>                1 to 6  
                                          Range:        1 to 6  
                                          \*RST:        1

**Manual operation:**    See " [Signal Tracking](#) " on page 350

## 12.7.2 Configuring Bandwidth and Sweep Settings

The commands required to configure the bandwidth, sweep and filter settings in a remote environment are described here. The tasks for manual operation are described in [Chapter 7.5, "Bandwidth, Filter and Sweep Configuration"](#), on page 360.

- [Configuring the Bandwidth and Filter](#)..... 785
- [Configuring the Sweep](#)..... 788

### 12.7.2.1 Configuring the Bandwidth and Filter

|                                                            |     |
|------------------------------------------------------------|-----|
| <a href="#">[SENSe:]BWIDth[:RESolution]</a> .....          | 785 |
| <a href="#">[SENSe:]BANDwidth[:RESolution]</a> .....       | 785 |
| <a href="#">[SENSe:]BWIDth[:RESolution]:AUTO</a> .....     | 786 |
| <a href="#">[SENSe:]BANDwidth[:RESolution]:AUTO</a> .....  | 786 |
| <a href="#">[SENSe:]BWIDth[:RESolution]:RATio</a> .....    | 786 |
| <a href="#">[SENSe:]BANDwidth[:RESolution]:RATio</a> ..... | 786 |
| <a href="#">[SENSe:]BWIDth[:RESolution]:TYPE</a> .....     | 786 |
| <a href="#">[SENSe:]BANDwidth[:RESolution]:TYPE</a> .....  | 786 |
| <a href="#">[SENSe:]BWIDth:VIDeo</a> .....                 | 787 |
| <a href="#">[SENSe:]BANDwidth:VIDeo</a> .....              | 787 |
| <a href="#">[SENSe:]BWIDth:VIDeo:AUTO</a> .....            | 787 |
| <a href="#">[SENSe:]BANDwidth:VIDeo:AUTO</a> .....         | 787 |
| <a href="#">[SENSe:]BWIDth:VIDeo:RATio</a> .....           | 787 |
| <a href="#">[SENSe:]BANDwidth:VIDeo:RATio</a> .....        | 787 |
| <a href="#">[SENSe:]BWIDth:VIDeo:TYPE</a> .....            | 788 |
| <a href="#">[SENSe:]BANDwidth:VIDeo:TYPE</a> .....         | 788 |

---

**[SENSe:]BWIDth[:RESolution] <Bandwidth>**

**[SENSe:]BANDwidth[:RESolution] <Bandwidth>**

This command defines the resolution bandwidth and decouples the resolution bandwidth from the span.

For statistics measurements, this command defines the **demodulation** bandwidth.

**Parameters:**

<Bandwidth> refer to data sheet  
 \*RST: RBW: AUTO is set to ON; DBW: 3MHz

**Example:**

BAND 1 MHz  
 Sets the resolution bandwidth to 1 MHz

**Manual operation:** See " [Analysis Bandwidth](#) " on page 267  
 See " [RBW](#) " on page 368  
 See " [RBW](#) " on page 380

**[SENSe:]BWIDth[:RESolution]:AUTO <State>**

**[SENSe:]BANDwidth[:RESolution]:AUTO <State>**

This command couples and decouples the resolution bandwidth to the span.

**Parameters:**

<State> ON | OFF | 0 | 1  
 \*RST: 1

**Example:**

BAND:AUTO OFF  
 Switches off the coupling of the resolution bandwidth to the span.

**Manual operation:** See " [RBW](#) " on page 368  
 See " [Default Coupling](#) " on page 370

**[SENSe:]BWIDth[:RESolution]:RATio <Ratio>**

**[SENSe:]BANDwidth[:RESolution]:RATio <Ratio>**

This command defines the ratio between the resolution bandwidth (Hz) and the span (Hz).

Note that the ratio defined with this remote command (RBW/span) is reciprocal to that of the coupling ratio (span/RBW).

**Parameters:**

<Ratio> Range: 0.0001 to 1  
 \*RST: 0.01

**Example:**

BAND:RAT 0.1

**Manual operation:** See " [Span/RBW](#) " on page 369

**[SENSe:]BWIDth[:RESolution]:TYPE <FilterType>**

**[SENSe:]BANDwidth[:RESolution]:TYPE <FilterType>**

This command selects the resolution filter type.

When you change the filter type, the command selects the next larger filter bandwidth if the same bandwidth is unavailable for that filter.

**Parameters:**

&lt;FilterType&gt;

**CFILter**

Channel filters

**NORMal**

Gaussian filters

**P5**

5-pole filters

The 5-pole filter is not available for FFT sweeps.

**RRC**

RRC filters

\*RST:        NORMal

**Example:**

BAND:TYPE NORM

**Manual operation:** See " [Filter Type](#) " on page 369**[SENSe:]BWIDth:VIDeo** <Bandwidth>**[SENSe:]BANDwidth:VIDeo** <Bandwidth>

This command defines the video bandwidth.

The command decouples the video bandwidth from the resolution bandwidths.

**Parameters:**

&lt;Bandwidth&gt;

refer to data sheet

\*RST:        AUTO is set to ON

**Example:**

BAND:VID 10 kHz

**Manual operation:** See " [VBW](#) " on page 368**[SENSe:]BWIDth:VIDeo:AUTO** <State>**[SENSe:]BANDwidth:VIDeo:AUTO** <State>

This command couples and decouples the video bandwidth to the resolution bandwidth.

**Parameters:**

&lt;State&gt;

ON | OFF | 0 | 1

\*RST:        1

**Example:**

BAND:VID:AUTO OFF

**Manual operation:** See " [VBW](#) " on page 368  
See " [RBW/VBW](#) " on page 369  
See " [Default Coupling](#) " on page 370**[SENSe:]BWIDth:VIDeo:RATio** <Ratio>**[SENSe:]BANDwidth:VIDeo:RATio** <Ratio>

This command defines the coupling ratio of the video bandwidth to the resolution bandwidth (RBW/VBW).

**Parameters:**

<Ratio>                    Range:        0,001 to 1000  
                               \*RST:        1

**Example:**

BAND:VID:RAT 3  
 Sets the coupling of video bandwidth to video bandwidth =  
 3\*resolution bandwidth

**Manual operation:** See " RBW/VBW " on page 369

[SENSe:]BWIDth:VIDeo:TYPE <Mode>

[SENSe:]BANDwidth:VIDeo:TYPE <Mode>

This command selects the position of the video filter in the signal path.

**Parameters:**

<Mode>

**LINEar**

The video filter is applied in front of the logarithmic amplifier. In linear mode, measurements with a logarithmic level scale result in flatter falling edges compared to logarithmic mode. The reason is the conversion of linear power values into logarithmic level values: if you halve the linear power, the logarithmic level decreases by 3 dB.

**LOGarithmic**

The video filter is applied after the logarithmic amplifier

\*RST:        LOGarithmic

**Example:**

BAND:VID:TYPE LIN  
 Video filter ahead of the logarithmic amplifier

**12.7.2.2 Configuring the Sweep**

Useful commands for configuring sweeps described elsewhere:

- [SENSe:]AVERage<n>:COUNT on page 841
- [SENSe:]AVERage<n>[:STATe<t>] on page 841
- [SENSe:]AVERage<n>:TYPE on page 842

**Remote commands exclusive to configuring sweeps:**

|                                         |     |
|-----------------------------------------|-----|
| [SENSe:]SWEep:COUNT.....                | 789 |
| [SENSe:]SWEep:OPTimize.....             | 789 |
| [SENSe:]SWEep:POINts.....               | 790 |
| [SENSe:]SWEep:TIME.....                 | 790 |
| [SENSe:]SWEep:TIME:AUTO.....            | 790 |
| [SENSe:]SWEep:TYPE.....                 | 791 |
| [SENSe:]SWEep:TYPE:USED.....            | 791 |
| [SENSe:]BWIDth[:RESolution]:FFT.....    | 791 |
| [SENSe:]BANDwidth[:RESolution]:FFT..... | 791 |

**[SENSe:]SWEep:COUNT** <SweepCount>

This command defines the number of sweep s that the application uses to average traces.

In case of continuous sweep mode, the application calculates the moving average over the average count.

In case of single sweep mode, the application stops the measurement and calculates the average after the average count has been reached.

**Suffix:**

<n> [Window](#)

**Parameters:**

<SweepCount> When you set a sweep count of 0 or 1, the R&S FPS performs one single sweep in single sweep mode. In continuous sweep mode, if the sweep count is set to 0, a moving average over 10 sweep s is performed.

Range: 0 to 200000

\*RST: 0

**Example:**

```
SWE:COUN 64
```

Sets the number of sweep s to 64.

```
INIT:CONT OFF
```

Switches to single sweep mode.

```
INIT;*WAI
```

Starts a sweep and waits for its end.

**Manual operation:** See "[Sweep/Average Count](#)" on page 370

**[SENSe:]SWEep:OPTimize** <Mode>

In FFT mode, several FFT analysis steps are required to cover the entire measurement span. The span which is covered by one FFT analysis step is called *partial span*. The partial span cannot be defined directly, but it can be optimized according to measurement requirements.

**Table 12-4: Optimization parameters in FFT mode**

| Optimization mode | Description                                                                                                                                                                                       |
|-------------------|---------------------------------------------------------------------------------------------------------------------------------------------------------------------------------------------------|
| DYNAMIC           | Optimizes the dynamic range by using the narrowest possible partial span (depending on the RBW).                                                                                                  |
| SPEEd             | Optimizes the sweep rate by using the widest possible partial span (depending on the RBW).<br>It is recommended that you set the <a href="#">Sweep Time</a> to "Auto" to optimize the sweep rate. |
| AUTO              | Uses a medium-sized partial span to obtain a compromise between a large dynamic range and a fast sweep rate.                                                                                      |

**Zero span mode**

For zero span measurements, the optimization mode defines the selection of the A/D converter prefilter.

**Table 12-5: Optimization parameters in zero span mode**

| Optimization mode | Description                                                   |
|-------------------|---------------------------------------------------------------|
| DYNamic           | The narrowest filter possible (depending on the RBW) is used. |
| SPEed             | The widest filter possible (depending on the RBW) is used.    |
| AUTO              | A medium-sized prefilter is used.                             |

**Parameters:**

<Mode> \*RST: AUTO

**Example:**

SWE:OPT DYN  
Selects optimization for dynamic range.

**Manual operation:** See "[Optimization](#)" on page 370

**[SENSe:]SWEep:POINTS <SweepPoints>**

This command defines the number of sweep points to analyze after a sweep .

**Parameters:**

<SweepPoints> Range: 101 to 32001  
\*RST: 1001

**Example:**

SWE:POIN 251

**Manual operation:** See "[Sweep Points](#)" on page 370

**[SENSe:]SWEep:TIME <Time>**

This command defines the sweep time.

**Parameters:**

<Time> refer to data sheet  
\*RST: depends on current settings (determined automatically)

**Example:**

SWE:TIME 10s

**Manual operation:** See "[Sweep Time](#)" on page 165  
See "[Sweep Time](#)" on page 368  
See "[Sweep Time](#)" on page 380

**[SENSe:]SWEep:TIME:AUTO <State>**

This command couples and decouples the sweep time to the span and the resolution and video bandwidths.

**Parameters:**

<State> ON | OFF | 0 | 1  
 \*RST: 1

**Example:**

SWE:TIME:AUTO ON  
 Activates automatic sweep time.

**Manual operation:** See " [Harmonic Sweep Time](#) " on page 285  
 See " [Sweep Time](#) " on page 368  
 See " [Default Coupling](#) " on page 370

**[SENSe:]SWEep:TYPE <Type>**

This command selects the sweep type.

**Parameters:**

<Type> **AUTO**  
 Automatic selection of the sweep type between sweep mode and FFT.

**FFT**  
 FFT mode

**SWE**  
 Sweep list

\*RST: AUTO

**Example:** SWE:TYPE FFT

**Manual operation:** See " [Sweep Type](#) " on page 371

**[SENSe:]SWEep:TYPE:USED**

This command queries the sweep type if you have turned on automatic selection of the sweep type.

**Return values:**

<Type> **SWE**  
 Normal sweep

**FFT**  
 FFT mode

**[SENSe:]BWIDth[:RESolution]:FFT <FilterMode>****[SENSe:]BANDwidth[:RESolution]:FFT <FilterMode>**

Defines the filter mode to be used for FFT filters by defining the partial span size. The partial span is the span which is covered by one FFT analysis.

This command is only available when using the sweep type "FFT".

**Parameters:**

&lt;FilterMode&gt;

WIDE | AUTO | NARRow

**AUTO**

Automatically applies the sweep optimization mode that is best for the current measurement.

**NARRow**

Optimizes the sweep mode for a large dynamic range.

**WIDE**

Optimizes the sweep mode for high performance.

\*RST: AUTO

**Example:**

```
BAND:TYPE FFT
```

Select FFT filter.

**Example:**

```
BAND:FFT NARR
```

Select narrow partial span for FFT filter.

### 12.7.3 Configuring the Vertical Axis (Amplitude, Scaling)

The following commands are required to configure the amplitude and vertical axis settings in a remote environment.

- [Amplitude Settings](#)..... 792
- [Configuring the Attenuation](#).....794
- [Configuring a Preamplifier](#).....796
- [Scaling the Y-Axis](#).....797

#### 12.7.3.1 Amplitude Settings

The tasks for manual configuration are described in [Chapter 7.4.2, "Amplitude Settings"](#), on page 354.

**Useful commands for amplitude configuration described elsewhere:**

- [\[SENSe:\]ADJust:LEVel](#) on page 783

**Remote commands exclusive to amplitude configuration:**

|                                                                                        |     |
|----------------------------------------------------------------------------------------|-----|
| <a href="#">CALCulate&lt;n&gt;:MARKer&lt;m&gt;:FUNction:REFerence</a> .....            | 792 |
| <a href="#">CALCulate&lt;n&gt;:UNIT:POWer</a> .....                                    | 793 |
| <a href="#">UNIT&lt;n&gt;:POWer</a> .....                                              | 793 |
| <a href="#">DISPlay[:WINDow&lt;n&gt;]:TRACe&lt;t&gt;:Y[:SCALe]:RLEVel</a> .....        | 793 |
| <a href="#">DISPlay[:WINDow&lt;n&gt;]:TRACe&lt;t&gt;:Y[:SCALe]:RLEVel:OFFSet</a> ..... | 793 |
| <a href="#">[SENSe:]POWer:NCORrection</a> .....                                        | 794 |

---

**CALCulate<n>:MARKer<m>:FUNction:REFerence**

This command matches the reference level to the power level of a marker.



If you use the command in combination with a delta marker, that delta marker is turned into a normal marker.

**Suffix:**

<n> [Window](#)

<m> [Marker](#)

**Example:**

CALC:MARK2:FUNC:REF

Sets the reference level to the level of marker 2.

**Usage:**

Event

**Manual operation:** See "[Reference Level = Marker Level](#)" on page 420

**CALCulate<n>:UNIT:POWer <Unit>**

**UNIT<n>:POWer <Unit>**

This command selects the unit of the y-axis.

The unit applies to all power-based measurement windows with absolute values.

**Suffix:**

<n> irrelevant

**Parameters:**

<Unit> DBM | V | A | W | DBPW | WATT | DBUV | DBMV | VOLT |  
DBUA | AMPere

\*RST: dBm

**Example:**

UNIT:POW DBM

Sets the power unit to dBm.

**DISPlay[:WINDow<n>]:TRACe<t>:Y[:SCALe]:RLEVel <ReferenceLevel>**

This command defines the reference level (for all traces in all windows).

With a reference level offset  $\neq 0$ , the value range of the reference level is modified by the offset.

**Suffix:**

<n>, <t> irrelevant

**Parameters:**

<ReferenceLevel> The unit is variable.

Range: see datasheet

\*RST: 0 dBm

**Example:**

DISP:TRAC:Y:RLEV -60dBm

**Manual operation:** See "[Reference Level](#)" on page 355

**DISPlay[:WINDow<n>]:TRACe<t>:Y[:SCALe]:RLEVel:OFFSet <Offset>**

This command defines a reference level offset (for all traces in all windows).

**Suffix:**

&lt;n&gt;, &lt;t&gt;                      irrelevant

**Parameters:**<Offset>                      Range:        -200 dB to 200 dB  
\*RST:                          0dB**Example:**

DISP:TRAC:Y:RLEV:OFFS -10dB

**Manual operation:** See "[Shifting the Display \( Offset \)](#)" on page 271  
See "[Shifting the Display \( Offset \)](#)" on page 355**[SENSe:]POWer:NCORrection <State>**

This command turns noise cancellation on and off.

If noise cancellation is on, the R&amp;S FPS performs a reference measurement to determine its inherent noise and subtracts the result from the channel power measurement result (first active trace only).

For more information see "[Noise Cancellation](#)" on page 163.**Parameters:**<State>                      ON | OFF | 1 | 0  
\*RST:                          0**Example:**

POW:NCOR ON

**Manual operation:** See "[Noise Cancellation](#)" on page 163**12.7.3.2 Configuring the Attenuation**

|                                  |     |
|----------------------------------|-----|
| INPut:ATTenuation.....           | 794 |
| INPut:ATTenuation:AUTO.....      | 795 |
| INPut:ATTenuation:AUTO:MODE..... | 795 |
| INPut:EATT.....                  | 795 |
| INPut:EATT:AUTO.....             | 796 |
| INPut:EATT:STAtE.....            | 796 |

**INPut:ATTenuation <Attenuation>**

This command defines the total attenuation for RF input.

If an electronic attenuator is available and active, the command defines a mechanical attenuation (see [INPut:EATT:STAtE](#) on page 796).

If you set the attenuation manually, it is no longer coupled to the reference level, but the reference level is coupled to the attenuation. Thus, if the current reference level is not compatible with an attenuation that has been set manually, the command also adjusts the reference level.

**Parameters:**

<Attenuation>      Range:      see data sheet  
 Increment:      5 dB (with optional electr. attenuator: 1 dB)  
 \*RST:            10 dB (AUTO is set to ON)

**Example:**

INP:ATT 30dB  
 Defines a 30 dB attenuation and decouples the attenuation from the reference level.

**Manual operation:** See "[Attenuation Mode / Value](#)" on page 356

**INPut:ATTenuation:AUTO <State>**

This command couples or decouples the attenuation to the reference level. Thus, when the reference level is changed, the R&S FPS determines the signal level for optimal internal data processing and sets the required attenuation accordingly.

**Parameters:**

<State>            ON | OFF | 0 | 1  
 \*RST:            1

**Example:**

INP:ATT:AUTO ON  
 Couples the attenuation to the reference level.

**Manual operation:** See "[Attenuation Mode / Value](#)" on page 356

**INPut:ATTenuation:AUTO:MODE <OptMode>**

Selects the priority for signal processing *after* the RF attenuation has been applied.

**Parameters:**

<OptMode>        LNOise | LDISTortion  
**LNOise**  
 Optimized for high sensitivity and low noise levels  
**LDISTortion**  
 Optimized for low distortion by avoiding intermodulation  
 \*RST:            LDISTortion

**Example:**

INP:ATT:AUTO:MODE LNO

**INPut:EATT <Attenuation>**

This command defines an electronic attenuation manually. Automatic mode must be switched off (INP:EATT:AUTO OFF, see [INPut:EATT:AUTO](#) on page 796).

If the current reference level is not compatible with an attenuation that has been set manually, the command also adjusts the reference level.

**Parameters:**

<Attenuation>           attenuation in dB  
 Range:            see data sheet  
 Increment:       1 dB  
 \*RST:            0 dB (OFF)

**Example:**

```
INP:EATT:AUTO OFF
INP:EATT 10 dB
```

**Manual operation:** See " [Using Electronic Attenuation](#) " on page 356

**INPut:EATT:AUTO <State>**

This command turns automatic selection of the electronic attenuation on and off.  
 If on, electronic attenuation reduces the mechanical attenuation whenever possible.

**Parameters:**

<State>            1 | 0 | ON | OFF  
**1 | ON**  
**0 | OFF**  
 \*RST:            1

**Example:**

```
INP:EATT:AUTO OFF
```

**Manual operation:** See " [Using Electronic Attenuation](#) " on page 356

**INPut:EATT:STATe <State>**

This command turns the electronic attenuator on and off.

**Parameters:**

<State>            1 | 0 | ON | OFF  
**1 | ON**  
**0 | OFF**  
 \*RST:            0

**Example:**

```
INP:EATT:STAT ON
```

Switches the electronic attenuator into the signal path.

**Manual operation:** See " [Using Electronic Attenuation](#) " on page 356

**12.7.3.3 Configuring a Preamplicifier**

[INPut:GAIN:STATe](#)..... 796

**INPut:GAIN:STATe <State>**

This command turns the preamplifier on and off.

If activated, the input signal is amplified by 20 dB.

If option R&S FPS-B22 is installed, the preamplifier is only active below 7 GHz.

If option R&S FPS-B24 is installed, the preamplifier is active for all frequencies.

**Parameters:**

<State> ON | OFF | 1 | 0  
\*RST: 0

**Example:**

INP:GAIN:STAT ON  
Switches on 20 dB preamplification.

**Manual operation:** See " [Preamplifier \(option B22/B24\)](#)" on page 357

### 12.7.3.4 Scaling the Y-Axis

|                                                       |     |
|-------------------------------------------------------|-----|
| DISPlay[:WINDow<n>]:TRACe<t>:Y[:SCALe].....           | 797 |
| DISPlay[:WINDow<n>]:TRACe<t>:Y[:SCALe]:AUTO ONCE..... | 797 |
| DISPlay[:WINDow<n>]:TRACe<t>:Y[:SCALe]:MODE.....      | 798 |
| DISPlay[:WINDow<n>]:TRACe<t>:Y[:SCALe]:PDIVision..... | 798 |
| DISPlay[:WINDow<n>]:TRACe<t>:Y[:SCALe]:RPOSition..... | 798 |
| DISPlay[:WINDow<n>]:TRACe<t>:Y:SPACing.....           | 799 |

---

#### DISPlay[:WINDow<n>]:TRACe<t>:Y[:SCALe] <Range>

This command defines the display range of the y-axis (for all traces).

Note that the command works only for a logarithmic scaling. You can select the scaling with `DISPlay[:WINDow<n>]:TRACe<t>:Y:SPACing`.

**Suffix:**

<n> [Window](#)  
<t> irrelevant

**Parameters:**

<Range> Range: 1 dB to 200 dB  
\*RST: 100 dB

**Example:**

DISP:TRAC:Y 110dB

**Manual operation:** See " [Range](#) " on page 358

---

#### DISPlay[:WINDow<n>]:TRACe<t>:Y[:SCALe]:AUTO ONCE

Automatic scaling of the y-axis is performed once, then switched off again (for all traces).

**Suffix:**

<n> [Window](#)  
<t> irrelevant

**Manual operation:** See " [Auto Scale Once](#) " on page 359

**DISPlay[:WINDow<n>]:TRACe<t>:Y[:SCALe]:MODE <Mode>**

This command selects the type of scaling of the y-axis (for all traces).

When the display update during remote control is off, this command has no immediate effect.

**Suffix:**

<n> [Window](#)

<t> irrelevant

**Parameters:**

<Mode> **ABSolute**  
absolute scaling of the y-axis

**RELative**  
relative scaling of the y-axis

\*RST: ABSolute

**Example:** `DISP:TRAC:Y:MODE REL`

**Manual operation:** See "[Scaling](#)" on page 359

**DISPlay[:WINDow<n>]:TRACe<t>:Y[:SCALe]:PDIVision <Value>**

This remote command determines the grid spacing on the Y-axis for all diagrams, where possible.

**Suffix:**

<n> [Window](#)

<t> irrelevant

**Parameters:**

<Value> numeric value WITHOUT UNIT (unit according to the result display)

Defines the range per division (total range = 10\*<Value>)

\*RST: depends on the result display

**Example:** `DISP:TRAC:Y:PDIV 10`

Sets the grid spacing to 10 units (e.g. dB) per division

**DISPlay[:WINDow<n>]:TRACe<t>:Y[:SCALe]:RPOSITION <Position>**

This command defines the vertical position of the reference level on the display grid (for all traces).

The R&S FPS adjusts the scaling of the y-axis accordingly.

For measurements with the optional external generator control, the command defines the position of the reference value.

**Suffix:**

<n> [Window](#)

<t> irrelevant

**Parameters:**

<Position> 0 PCT corresponds to the lower display border, 100% corresponds to the upper display border.  
 \*RST: 100 PCT = frequency display; 50 PCT = time display

**Example:** DISP:TRAC:Y:RPOS 50PCT

**Manual operation:** See " [Reference Position](#) " on page 330  
 See " [Ref Level Position](#) " on page 359

**DISPlay[:WINDow<n>]:TRACe<t>:Y:SPACing <ScalingType>**

This command selects the scaling of the y-axis (for all traces, <t> is irrelevant).

**Suffix:**

<n> [Window](#)

<t> [Trace](#)

**Parameters:**

<ScalingType> **LOGarithmic**  
 Logarithmic scaling.  
**LINear**  
 Linear scaling in %.  
**LDB**  
 Linear scaling in the specified unit.  
**PERCent**  
 Linear scaling in %.  
 \*RST: LOGarithmic

**Example:** DISP:TRAC:Y:SPAC LIN  
 Selects linear scaling in %.

**Manual operation:** See " [Scaling](#) " on page 359

## 12.7.4 Configuring Triggered and Gated Measurements

The commands required to configure a triggered or gated measurement in a remote environment are described here. The tasks for manual operation are described in [Chapter 7.6, "Trigger and Gate Configuration"](#), on page 375.



\*OPC should be used after requesting data. This will hold off any subsequent changes to the selected trigger source, until after the sweep is completed and the data is returned.

- [Configuring the Triggering Conditions](#).....800
- [Configuring Gated Measurements](#)..... 804
- [Configuring the Trigger Output](#).....807

#### 12.7.4.1 Configuring the Triggering Conditions

The following commands are required to configure a triggered measurement.

|                                                                       |     |
|-----------------------------------------------------------------------|-----|
| <a href="#">TRIGger[:SEQuence]:DTIME</a> .....                        | 800 |
| <a href="#">TRIGger[:SEQuence]:HOLDoff[:TIME]</a> .....               | 800 |
| <a href="#">TRIGger[:SEQuence]:IFPower:HOLDoff</a> .....              | 801 |
| <a href="#">TRIGger[:SEQuence]:IFPower:HYSteresis</a> .....           | 801 |
| <a href="#">TRIGger[:SEQuence]:LEVel[:EXtErnal&lt;port&gt;]</a> ..... | 801 |
| <a href="#">TRIGger[:SEQuence]:LEVel:IFPower</a> .....                | 802 |
| <a href="#">TRIGger[:SEQuence]:LEVel:IQPower</a> .....                | 802 |
| <a href="#">TRIGger[:SEQuence]:LEVel:RFPower</a> .....                | 802 |
| <a href="#">TRIGger[:SEQuence]:LEVel:VIDeo</a> .....                  | 803 |
| <a href="#">TRIGger[:SEQuence]:SLOPe</a> .....                        | 803 |
| <a href="#">TRIGger[:SEQuence]:SOURce</a> .....                       | 803 |

---

#### **TRIGger[:SEQuence]:DTIME** <DropoutTime>

Defines the time the input signal must stay below the trigger level before a trigger is detected again.

##### **Parameters:**

|               |                              |
|---------------|------------------------------|
| <DropoutTime> | Dropout time of the trigger. |
| Range:        | 0 s to 10.0 s                |
| *RST:         | 0 s                          |

**Manual operation:** See "[Drop-Out Time](#)" on page 383

---

#### **TRIGger[:SEQuence]:HOLDoff[:TIME]** <Offset>

Defines the time offset between the trigger event and the start of the sweep .

A negative offset is possible for time domain measurements.

For the trigger sources "External" or "IF Power", a common input signal is used for both trigger and gate. Therefore, changes to the gate delay will affect the trigger offset as well.

##### **Parameters:**

|          |                                                                                    |
|----------|------------------------------------------------------------------------------------|
| <Offset> | For measurements in the frequency domain, the range is 0 s to 30 s.                |
|          | For measurements in the time domain, the range is the negative sweep time to 30 s. |
| *RST:    | 0 s                                                                                |

**Example:** TRIG:HOLD 500us

**Manual operation:** See "[Trigger Offset](#)" on page 383



---

**TRIGger[:SEquence]:IFPower:HOLDoff** <Period>

This command defines the holding time before the next trigger event.

Note that this command can be used for **any trigger source**, not just IF Power (despite the legacy keyword).

**Note:** If you perform gated measurements in combination with the IF Power trigger, the R&S FPS ignores the holding time for frequency sweep, FFT sweep, zero span and I/Q data measurements.

**Parameters:**

<Period>                   Range:     0 s to 10 s  
                              \*RST:     0 s

**Example:**

```
TRIG:SOUR EXT
Sets an external trigger source.
TRIG:IFP:HOLD 200 ns
Sets the holding time to 200 ns.
```

**Manual operation:** See "[Trigger Holdoff](#)" on page 383

---

**TRIGger[:SEquence]:IFPower:HYSteresis** <Hysteresis>

This command defines the trigger hysteresis, which is only available for "IF Power" trigger sources.

**Parameters:**

<Hysteresis>               Range:     3 dB to 50 dB  
                              \*RST:     3 dB

**Example:**

```
TRIG:SOUR IFP
Sets the IF power trigger source.
TRIG:IFP:HYST 10DB
Sets the hysteresis limit value.
```

**Manual operation:** See "[Hysteresis](#)" on page 383

---

**TRIGger[:SEquence]:LEVel[:EXternal<port>]** <TriggerLevel>

This command defines the level the external signal must exceed to cause a trigger event.

Note that the variable INPUT/OUTPUT connectors (ports 2+3) must be set for use as input using the [OUTPut:TRIGger<port>:DIRection](#) command.

**Suffix:**

<port>                    Selects the trigger port.  
                              1 = trigger port 1 (TRIG IN connector on rear panel)  
                              2 = trigger port 2 (TRIG AUX connector on rear panel)

**Parameters:**

<TriggerLevel>           Range:     0.5 V to 3.5 V  
                              \*RST:     1.4 V

**Example:** TRIG:LEV 2V

**Manual operation:** See " [Trigger Level](#) " on page 382

#### TRIGger[:SEQuence]:LEVel:IFPower <TriggerLevel>

This command defines the power level at the third intermediate frequency that must be exceeded to cause a trigger event. Note that any RF attenuation or preamplification is considered when the trigger level is analyzed. If defined, a reference level offset is also considered.

**Parameters:**

<TriggerLevel> For details on available trigger levels and trigger bandwidths see the data sheet.

\*RST: -10 dBm

**Example:** TRIG:LEV:IFP -30DBM

**Manual operation:** See " [Trigger Level](#) " on page 382

#### TRIGger[:SEQuence]:LEVel:IQPower <TriggerLevel>

This command defines the magnitude the I/Q data must exceed to cause a trigger event. Note that any RF attenuation or preamplification is considered when the trigger level is analyzed.

**Parameters:**

<TriggerLevel> Range: -130 dBm to 30 dBm

\*RST: -20 dBm

**Example:** TRIG:LEV:IQP -30DBM

**Manual operation:** See " [Trigger Level](#) " on page 382

#### TRIGger[:SEQuence]:LEVel:RFPower <TriggerLevel>

This command defines the power level the RF input must exceed to cause a trigger event. Note that any RF attenuation or preamplification is considered when the trigger level is analyzed. If defined, a reference level offset is also considered.

The input signal must be between 500 MHz and 8 GHz.

**Parameters:**

<TriggerLevel> For details on available trigger levels and trigger bandwidths see the data sheet.

\*RST: -20 dBm

**Example:** TRIG:LEV:RFP -30dBm

**Manual operation:** See " [Trigger Level](#) " on page 382

**TRIGger[:SEQUence]:LEVel:VIDeo** <Level>

This command defines the level the video signal must exceed to cause a trigger event. Note that any RF attenuation or preamplification is considered when the trigger level is analyzed.

**Parameters:**

<Level>                      Range:        0 PCT to 100 PCT  
                                      \*RST:        50 PCT

**Example:**                      TRIG:LEV:VID 50PCT

**Manual operation:**    See " [Trigger Level](#) " on page 382

**TRIGger[:SEQUence]:SLOPe** <Type>

For all trigger sources except time you can define whether triggering occurs when the signal rises to the trigger level or falls down to it.

**Parameters:**

<Type>                      POSitive | NEGative  
                                      **POSitive**  
                                      Triggers when the signal rises to the trigger level (rising edge).  
                                      **NEGative**  
                                      Triggers when the signal drops to the trigger level (falling edge).  
                                      \*RST:        POSitive

**Example:**                      TRIG:SLOP NEG

**Manual operation:**    See " [Slope](#) " on page 384

**TRIGger[:SEQUence]:SOURce** <Source>

This command selects the trigger source.

For details on trigger sources see " [Trigger Source](#) " on page 381.

**Note on external triggers:**

If a measurement is configured to wait for an external trigger signal in a remote control program, remote control is blocked until the trigger is received and the program can continue. Make sure this situation is avoided in your remote control programs.

If the 1.2 GHz bandwidth extension option (B1200) or the internal 2 GHz option (B2001) is active, only an external trigger, IF power trigger, or no trigger is available.

For troubleshooting tips see "[Incompleted sequential commands - blocked remote channels](#)" on page 1056.

**Parameters:**

|          |                                                                                                  |
|----------|--------------------------------------------------------------------------------------------------|
| <Source> | <b>IMMediate</b><br>Free Run                                                                     |
|          | <b>EXTernal</b><br>Trigger signal from the TRIGGER IN connector.                                 |
|          | <b>EXT2</b><br>Trigger signal from the TRIGGER AUX connector.                                    |
|          | <b>RFPower</b><br>First intermediate frequency                                                   |
|          | <b>IFPower</b><br>Second intermediate frequency                                                  |
|          | <b>VIDeo</b><br>Video mode is available in the time domain and only in the Spectrum application. |
|          | *RST:       IMMediate                                                                            |

**Example:**

TRIG:SOUR EXT  
Selects the external trigger input as source of the trigger signal

**Manual operation:**

See " [Using the power sensor as an external trigger](#) " on page 311  
See " [Trigger Source](#) " on page 381  
See " [Free Run](#) " on page 381  
See " [External Trigger 1/2](#) " on page 381  
See " [Video](#) " on page 381  
See " [IF Power](#) " on page 382  
See " [RF Power](#) " on page 382

**12.7.4.2 Configuring Gated Measurements**

|                                   |     |
|-----------------------------------|-----|
| [SENSe:]SWEep:EGATe.....          | 804 |
| [SENSe:]SWEep:EGATe:HOLDoff.....  | 805 |
| [SENSe:]SWEep:EGATe:LENGth.....   | 805 |
| [SENSe:]SWEep:EGATe:POLarity..... | 805 |
| [SENSe:]SWEep:EGATe:SOURce.....   | 806 |
| [SENSe:]SWEep:EGATe:TYPE.....     | 806 |

**[SENSe:]SWEep:EGATe <State>**

This command turns gated measurements on and off.

In case of measurements with an external gate, the measured values are recorded as long as the gate is opened. During a sweep the gate can be opened and closed several times. The synchronization mechanisms with \*OPC, \*OPC? and \*WAI remain completely unaffected.

The measurement ends when a particular number of measurement points has been recorded (see [SENSe:]SWEep:POINTs on page 790).

Performing gated measurements turns the squelch off.

**Parameters:**

<State> ON | OFF | 1 | 0  
 \*RST: 0

**Example:**

```
SWE:EGAT ON
Switches on the external gate mode.
SWE:EGAT:TYPE EDGE
Switches on the edge-triggered mode.
SWE:EGAT:HOLD 100US
Sets the gate delay to 100 µs.
SWE:EGAT:LEN 500US
Sets the gate opening time to 500 µs.
INIT;*WAI
Starts a sweep and waits for its end.
```

**[SENSe:]SWEep:EGATe:HOLDoff <DelayTime>**

This command defines the delay time between the gate signal and the continuation of the measurement.

**Note:** If you perform gated measurements in combination with the IF Power trigger, the R&S FPS ignores the holding time for frequency sweep, FFT sweep, zero span and I/Q mode measurements.

**Parameters:**

<DelayTime> Range: 0 s to 30 s  
 \*RST: 0 s

**Example:** SWE:EGAT:HOLD 100us

**Manual operation:** See " [Gate Delay](#) " on page 388

**[SENSe:]SWEep:EGATe:LENGth <GateLength>**

This command defines the gate length.

**Parameters:**

<GateLength> Range: 125 ns to 30 s  
 \*RST: 400µs

**Example:** SWE:EGAT:LENG 10ms

**Manual operation:** See " [Gate Length](#) " on page 389

**[SENSe:]SWEep:EGATe:POLarity <Polarity>**

This command selects the polarity of an external gate signal.

The setting applies both to the edge of an edge-triggered signal and the level of a level-triggered signal.

**Parameters:**

<Polarity> POSitive | NEGative  
 \*RST: POSitive

**Example:** SWE:EGAT:POL POS

**Manual operation:** See " [Slope](#) " on page 384

**[SENSe:]SWEep:EGATe:SOURce <Source>**

This command selects the signal source for gated measurements.

If an IF power signal is used, the gate is opened as soon as a signal at > -20 dBm is detected within the IF path bandwidth (10 MHz).

For more information see " [Trigger Source](#) " on page 381.

**Parameters:**

<Source> EXTernal | EXT2 | IFPower | VIDEo | RFPower  
 \*RST: IFPower

**Example:** SWE:EGAT:SOUR IFP  
 Switches the gate source to IF power.

**Manual operation:** See " [Trigger Source](#) " on page 381  
 See " [External Trigger 1/2](#) " on page 381  
 See " [Video](#) " on page 381  
 See " [IF Power](#) " on page 382  
 See " [RF Power](#) " on page 382

**[SENSe:]SWEep:EGATe:TYPE <Type>**

This command selects the way gated measurements are triggered.

**Parameters:**

<Type> **LEVEL**  
 The trigger event for the gate to open is a particular power level. After the gate signal has been detected, the gate remains open until the signal disappears.

**Note:** If you perform gated measurements in combination with the IF Power trigger, the R&S FPS ignores the holding time for frequency sweep, FFT sweep, zero span and I/Q mode measurements.

**EDGE**  
 The trigger event for the gate to open is the detection of the signal edge.

After the gate signal has been detected, the gate remains open until the gate length is over.

\*RST: EDGE

**Example:** SWE:EGAT:TYPE EDGE

**Manual operation:** See " [Gate Mode](#) " on page 388

### 12.7.4.3 Configuring the Trigger Output

The following commands are required to send the trigger signal to one of the variable TRIGGER INPUT/OUTPUT connectors on the R&S FPS.

|                                                               |     |
|---------------------------------------------------------------|-----|
| <code>OUTPut:TRIGger&lt;port&gt;:DIRection</code> .....       | 807 |
| <code>OUTPut:TRIGger&lt;port&gt;:LEVel</code> .....           | 807 |
| <code>OUTPut:TRIGger&lt;port&gt;:OTYPe</code> .....           | 808 |
| <code>OUTPut:TRIGger&lt;port&gt;:PULSe:IMMediate</code> ..... | 808 |
| <code>OUTPut:TRIGger&lt;port&gt;:PULSe:LENGth</code> .....    | 808 |

---

#### `OUTPut:TRIGger<port>:DIRection <Direction>`

This command selects the trigger direction for trigger ports that serve as an input as well as an output.

**Suffix:**

<port>                      Selects the used trigger port.  
2 = TRG AUX

**Parameters:**

<Direction>                **INPut**  
Port works as an input.

**OUTPut**  
Port works as an output.

\*RST:                      INPut

**Manual operation:**    See "[Trigger 2](#)" on page 341

---

#### `OUTPut:TRIGger<port>:LEVel <Level>`

This command defines the level of the (TTL compatible) signal generated at the trigger output.

This command works only if you have selected a user defined output with `OUTPut:TRIGger<port>:OTYPe`.

**Suffix:**

<port>                      Selects the trigger port to which the output is sent.  
2 = TRG AUX

**Parameters:**

<Level>                     **HIGH**  
5 V

**LOW**  
0 V

\*RST:                      LOW

**Example:**                `OUTPut:TRIG2:LEV HIGH`

**Manual operation:**    See "[Level](#)" on page 341

**OUTPut:TRIGger<port>:OTYPe <OutputType>**

This command selects the type of signal generated at the trigger output.

**Suffix:**

<port>                      Selects the trigger port to which the output is sent.  
2 = TRG AUX

**Parameters:**

<OutputType>

**DEvice**

Sends a trigger signal when the R&S FPS has triggered internally.

**TARMed**

Sends a trigger signal when the trigger is armed and ready for an external trigger event.

**UDEfined**

Sends a user defined trigger signal. For more information see [OUTPut:TRIGger<port>:LEVel](#).

\*RST:            DEvice

**Manual operation:** See " [Output Type](#) " on page 341

**OUTPut:TRIGger<port>:PULSe:IMMediate**

This command generates a pulse at the trigger output.

**Suffix:**

<port>                      Selects the trigger port to which the output is sent.  
2 = TRG AUX

**Usage:**

Event

**Manual operation:** See " [Send Trigger](#) " on page 342

**OUTPut:TRIGger<port>:PULSe:LENGth <Length>**

This command defines the length of the pulse generated at the trigger output.

**Suffix:**

<port>                      Selects the trigger port to which the output is sent.  
2 = TRG AUX

**Parameters:**

<Length>

Pulse length in seconds.

**Example:**

OUTP:TRIG2:PULS:LENG 0.02

**Manual operation:** See " [Pulse Length](#) " on page 342



## 12.7.5 Adjusting Settings Automatically

The commands required to adjust settings automatically in a remote environment are described here.

The tasks for manual operation are described in [Chapter 7.7, "Adjusting Settings Automatically"](#), on page 389.



### MSRA operating mode

In MSRA operating mode, settings related to data acquisition (measurement time, hysteresis) can only be adjusted automatically in the MSRA Master, not in the MSRA applications.

|                                                     |     |
|-----------------------------------------------------|-----|
| [SENSe:]ADJust:ALL.....                             | 809 |
| [SENSe:]ADJust:CONFigure[:LEVel]:DURation.....      | 809 |
| [SENSe:]ADJust:CONFigure[:LEVel]:DURation:MODE..... | 810 |
| [SENSe:]ADJust:CONFigure:HYSTerisis:LOWer.....      | 810 |
| [SENSe:]ADJust:CONFigure:HYSTerisis:UPPer.....      | 811 |
| [SENSe:]ADJust:CONFigure:TRIGger.....               | 811 |
| [SENSe:]ADJust:FREQuency.....                       | 811 |
| [SENSe:]ADJust:LEVel.....                           | 811 |

### [SENSe:]ADJust:ALL

This command initiates a measurement to determine and set the ideal settings for the current task automatically (only once for the current measurement).

This includes:

- Center frequency
- Reference level

**Example:** ADJ:ALL

**Usage:** Event

**Manual operation:** See "[Adjusting all Determinable Settings Automatically \( Auto All \)](#)" on page 390

### [SENSe:]ADJust:CONFigure[:LEVel]:DURation <Duration>

In order to determine the ideal reference level, the R&S FPS performs a measurement on the current input data. This command defines the length of the measurement if `[SENSe:]ADJust:CONFigure[:LEVel]:DURation:MODE` is set to `MANual`.

#### Parameters:

<Duration>            Numeric value in seconds  
 Range:                0.001 to 16000.0  
 \*RST:                 0.001  
 Default unit: s

**Example:** `ADJ:CONF:DUR:MODE MAN`  
 Selects manual definition of the measurement length.  
`ADJ:CONF:LEV:DUR 5ms`  
 Length of the measurement is 5 ms.

**Manual operation:** See "[Changing the Automatic Measurement Time \( Meastime Manual \)](#)" on page 391

#### **[SENSe:]ADJust:CONFigure[:LEVel]:DURation:MODE <Mode>**

In order to determine the ideal reference level, the R&S FPS performs a measurement on the current input data. This command selects the way the R&S FPS determines the length of the measurement .

#### **Parameters:**

<Mode>

#### **AUTO**

The R&S FPS determines the measurement length automatically according to the current input data.

#### **MANual**

The R&S FPS uses the measurement length defined by [\[SENSe:\]ADJust:CONFigure\[:LEVel\]:DURation](#) on page 781.

\*RST: AUTO

**Manual operation:** See "[Resetting the Automatic Measurement Time \( Meastime Auto \)](#)" on page 391  
 See "[Changing the Automatic Measurement Time \( Meastime Manual \)](#)" on page 391

#### **[SENSe:]ADJust:CONFigure:HYSTeresis:LOWer <Threshold>**

When the reference level is adjusted automatically using the [\[SENSe:\]ADJust:LEVel](#) on page 783 command, the internal attenuators and the preamplifier are also adjusted. In order to avoid frequent adaptation due to small changes in the input signal, you can define a hysteresis. This setting defines a lower threshold the signal must fall below (compared to the last measurement) before the reference level is adapted automatically.

#### **Parameters:**

<Threshold>

Range: 0 dB to 200 dB

\*RST: +1 dB

Default unit: dB

**Example:** `SENS:ADJ:CONF:HYST:LOW 2`

For an input signal level of currently 20 dBm, the reference level will only be adjusted when the signal level falls below 18 dBm.

**Manual operation:** See "[Lower Level Hysteresis](#)" on page 392

**[SENSe:]ADJust:CONFigure:HYSTeresis:UPPer <Threshold>****Parameters:**

<Threshold>            Range:     0 dB to 200 dB  
                              \*RST:     +1 dB  
                              Default unit: dB

**Example:**            SENS:ADJ:CONF:HYST:UPP 2

**Example:**            For an input signal level of currently 20 dBm, the reference level will only be adjusted when the signal level rises above 22 dBm.

**Manual operation:** See " [Upper Level Hysteresis](#) " on page 391

**[SENSe:]ADJust:CONFigure:TRIGger <State>**

Defines the behavior of the measurement when adjusting a setting automatically (using SENS:ADJ:LEV ON, for example).

See "[Adjusting settings automatically during triggered measurements](#)" on page 390.

**Parameters:**

<State>                **ON | 1**  
                              The measurement for automatic adjustment waits for the trigger.  
                              **OFF | 0**  
                              The measurement for automatic adjustment is performed immediately, without waiting for a trigger.  
                              \*RST:        1

**[SENSe:]ADJust:FREQuency**

This command sets the center frequency to the frequency with the highest signal level in the current frequency range.

At the same time, the optimal reference level is also set (see [\[SENSe:\]ADJust:LEVel](#) on page 783).

**Example:**            ADJ:FREQ

**Usage:**                Event

**Manual operation:** See " [Adjusting the Center Frequency Automatically \( Auto Frequency \)](#) " on page 390

**[SENSe:]ADJust:LEVel**

This command initiates a single (internal) measurement that evaluates and sets the ideal reference level for the current input data and measurement settings. This ensures that the settings of the RF attenuation and the reference level are optimally adjusted to the signal level without overloading the R&S FPS or limiting the dynamic range by an S/N ratio that is too small.

**Example:**            ADJ:LEV

|                          |                                                                                              |
|--------------------------|----------------------------------------------------------------------------------------------|
| <b>Usage:</b>            | Event                                                                                        |
| <b>Manual operation:</b> | See " <a href="#">Setting the Reference Level Automatically ( Auto Level )</a> " on page 356 |

## 12.7.6 Configuring the Data Input and Output

The following commands are required to configure data input and output.

- [RF Input](#)..... 812
- [External Generator Control](#)..... 814
- [Working with Power Sensors](#)..... 823
- [Configuring the Outputs](#)..... 834

### 12.7.6.1 RF Input

|                                                |     |
|------------------------------------------------|-----|
| <a href="#">INPut:COUPling</a> .....           | 812 |
| <a href="#">INPut:DPATH</a> .....              | 812 |
| <a href="#">INPut:FILTer:YIG[:STATe]</a> ..... | 813 |
| <a href="#">INPut:IMPedance</a> .....          | 813 |
| <a href="#">INPut:IMPedance:PTYPE</a> .....    | 813 |
| <a href="#">INPut:SELEct</a> .....             | 814 |

---

#### INPut:COUPling <CouplingType>

This command selects the coupling type of the RF input.

##### Parameters:

|                |                          |
|----------------|--------------------------|
| <CouplingType> | <b>AC</b><br>AC coupling |
|                | <b>DC</b><br>DC coupling |
|                | *RST: AC                 |

**Example:** INP:COUP DC

**Manual operation:** See " [Input Coupling](#) " on page 304

---

#### INPut:DPATH <State>

Enables or disables the use of the direct path for frequencies close to 0 Hz.

##### Parameters:

|         |                                                                                                   |
|---------|---------------------------------------------------------------------------------------------------|
| <State> | <b>AUTO   1</b><br>(Default) the direct path is used automatically for frequencies close to 0 Hz. |
|         | <b>OFF   0</b><br>The analog mixer path is always used.                                           |
|         | *RST: 1                                                                                           |

**Example:** `INP:DPAT OFF`

---

### **INPut:FILTer:YIG[:STATe] <State>**

This command turns the YIG-preselector on and off.

Note the special conditions and restrictions for the YIG-preselector described in "[YIG-Preselector](#)" on page 305.

#### **Parameters:**

<State>                    ON | OFF | 0 | 1  
 \*RST:                    1 (0 for I/Q Analyzer, GSM, VSA, Pulse, Amplifier measurements)

**Example:** `INP:FILT:YIG OFF`  
 Deactivates the YIG-preselector.

**Manual operation:** See "[YIG-Preselector](#)" on page 305

---

### **INPut:IMPedance <Impedance>**

This command selects the nominal input impedance of the RF input. In some applications, only 50 Ω are supported.

#### **Parameters:**

<Impedance>            50 | 75  
**numeric value**  
 User-defined impedance from 50 Ohm to 100000000 Ohm (=100 MOhm)  
 User-defined values are only available for the Spectrum application, the I/Q Analyzer (and thus MSRA mode, Master only) and some optional applications.  
 \*RST:                    50 Ω

**Example:** `INP:IMP 75`

**Manual operation:** See "[Impedance](#)" on page 304  
 See "[Unit](#)" on page 355

---

### **INPut:IMPedance:PTYPe <PadType>**

Defines the type of matching pad used for impedance conversion for RF input.

#### **Parameters:**

<PadType>                SRESistor | MLPad  
**SRESistor**  
 Series-R  
**MLPad**  
 Minimum Loss Pad  
 \*RST:                    SRESistor

**Example:**            INP:IMP 100  
                      INP:IMP:PTYP MLP

**Manual operation:** See " [Impedance](#) " on page 304

#### **INPut:SElect** <Source>

This command selects the signal source for measurements, i.e. it defines which connector is used to input data to the R&S FPS.

If no additional input options are installed, only RF input is supported.

#### **Parameters:**

<Source>            **RF**  
                      Radio Frequency ("RF INPUT" connector)  
\*RST:                RF

**Manual operation:** See " [Radio Frequency State](#) " on page 304

### 12.7.6.2 External Generator Control

For each measurement channel one external generator can be configured. To switch between different configurations define multiple measurement channels.

For more information on external generator control see [Chapter 7.2.4.2, "Basics on External Generator Control"](#), on page 315.

- [Measurement Configuration](#).....814
- [Interface Configuration](#).....817
- [Source Calibration](#).....819
- [Programming Example for External Generator Control](#)..... 822

#### **Measurement Configuration**

The following commands are required to activate external generator control and to configure a calibration measurement with an external tracking generator.

|                                                                      |     |
|----------------------------------------------------------------------|-----|
| <a href="#">SOURce:EXTernal:FREQuency</a> .....                      | 814 |
| <a href="#">SOURce:EXTernal:FREQuency:COUPling[:STATe]</a> .....     | 815 |
| <a href="#">SOURce:EXTernal:FREQuency[:FACTor]:DENominator</a> ..... | 815 |
| <a href="#">SOURce:EXTernal:FREQuency[:FACTor]:NUMerator</a> .....   | 816 |
| <a href="#">SOURce:EXTernal:FREQuency:OFFSet</a> .....               | 816 |
| <a href="#">SOURce:EXTernal:POWer[:LEVel]</a> .....                  | 816 |
| <a href="#">SOURce:EXTernal[:STATe]</a> .....                        | 817 |
| <a href="#">SOURce:POWer[:LEVel][:IMMediate]:OFFSet</a> .....        | 817 |

#### **SOURce:EXTernal:FREQuency** <Frequency>

This command defines a fixed source frequency for the external generator.

#### **Parameters:**

<Frequency>        Source frequency of the external generator.  
\*RST:                1100050000

**Example:** //Define frequency of the generator  
 SOUR:EXT:FREQ 10MHz

**Manual operation:** See "(Manual) Source Frequency" on page 327

#### **SOURce:EXTernal:FREQuency:COUPling[:STATe] <State>**

This command couples the frequency of the external generator output to the R&S FPS.

#### **Parameters:**

<State> ON | OFF | 0 | 1

#### **ON | 1**

Default setting: a series of frequencies is defined (one for each sweep point), based on the current frequency at the RF input of the R&S FPS; the RF frequency range covers the currently defined span of the R&S FPS (unless limited by the range of the signal generator)

#### **OFF | 0**

The generator uses a single fixed frequency, defined by `SOURce:EXTernal:FREQuency`.

\*RST: 1

**Example:** SOUR:EXT:FREQ:COUP ON

**Manual operation:** See "Source Frequency Coupling" on page 327

#### **SOURce:EXTernal:FREQuency[:FACTor]:DENominator <Value>**

This command defines the denominator of the factor with which the analyzer frequency is multiplied in order to obtain the transmit frequency of the selected generator.

Select the multiplication factor such that the frequency range of the generator is not exceeded if the following formula is applied to the start and stop frequency of the analyzer:

$$F_{Generator} = \left| F_{Analyzer} * \frac{Numerator}{Denominator} + F_{Offset} \right|$$

#### **Parameters:**

<Value> <numeric value>

\*RST: 1

**Example:** //Define multiplication factor of 4/3; the transmit frequency of the generator is 4/3 times the analyzer frequency

SOUR:EXT:FREQ:NUM 4

SOUR:EXT:FREQ:DEN 3

**Manual operation:** See "(Automatic) Source Frequency (Numerator/Denominator/Offset)" on page 327

**SOURce:EXTernal:FREQUENCY[:FACTOR]:NUMerator** <Value>

This command defines the numerator of the factor with which the analyzer frequency is multiplied in order to obtain the transmit frequency of the selected generator.

Select the multiplication factor such that the frequency range of the generator is not exceeded if the following formula is applied to the start and stop frequency of the analyzer:

$$F_{Generator} = \left| F_{Analyzer} * \frac{Numerator}{Denominator} + F_{Offset} \right|$$

**Parameters:**

<Value> <numeric value>

\*RST: 1

**Example:**

//Define multiplication factor of 4/3; the transmit frequency of the generator is 4/3 times the analyzer frequency

SOUR:EXT:FREQ:NUM 4

SOUR:EXT:FREQ:DEN 3

**Manual operation:** See "[\(Automatic\) Source Frequency \(Numerator/Denominator/Offset\)](#)" on page 327

**SOURce:EXTernal:FREQUENCY:OFFSet** <Offset>

This command defines the frequency offset of the generator with reference to the analyzer frequency.

Select the offset such that the frequency range of the generator is not exceeded if the following formula is applied to the start and stop frequency of the analyzer:

$$F_{Generator} = \left| F_{Analyzer} * \frac{Numerator}{Denominator} + F_{Offset} \right|$$

**Parameters:**

<Offset> <numeric value>, specified in Hz, kHz, MHz or GHz, rounded to the nearest Hz

\*RST: 0 Hz

**Example:**

//Define an offset between generator output frequency and analyzer frequency

SOUR:EXT:FREQ:OFFS 10HZ

**Manual operation:** See "[\(Automatic\) Source Frequency \(Numerator/Denominator/Offset\)](#)" on page 327

**SOURce:EXTernal:POWer[:LEVel]** <Level>

This command sets the output power of the selected generator.



**Parameters:**

<Level> <numeric value>  
 \*RST: -20 dBm

**Example:**

```
//Define generator output level
SOUR:EXT:POW -30dBm
```

**Manual operation:** See " [Source Power](#) " on page 326

**SOURce:EXTernal[:STATe] <State>**

This command activates or deactivates the connected external generator.

**Parameters:**

<State> ON | OFF | 1 | 0  
 \*RST: 0

**Manual operation:** See " [Source State](#) " on page 326

**SOURce:POWer[:LEVel][:IMMediate]:OFFSet <Offset>**

This command defines a level offset for the external generator level. Thus, for example, attenuators or amplifiers at the output of the external generator can be taken into account for the setting.

**Parameters:**

<Offset> Range: -200 dB to +200 dB  
 \*RST: 0dB

**Example:**

```
//Define a level offset on the external generator
SOUR:POW:OFFS -10dB
```

**Manual operation:** See " [Source Offset](#) " on page 326

**Interface Configuration**

The following commands are required to configure the interface for the connection to the external generator.

|                                                                          |     |
|--------------------------------------------------------------------------|-----|
| <a href="#">SOURce:EXTernal:ROSCillator[:SOURce]</a> .....               | 817 |
| <a href="#">SYSTem:COMMunicate:RDEvice:GENerator:INTerface</a> .....     | 818 |
| <a href="#">SYSTem:COMMunicate:RDEvice:GENerator:TYPE</a> .....          | 818 |
| <a href="#">SYSTem:COMMunicate:TCPip:RDEvice:GENerator:ADDRess</a> ..... | 818 |

**SOURce:EXTernal:ROSCillator[:SOURce] <Source>**

This command controls selection of the reference oscillator for the external generator.

If the external reference oscillator is selected, the reference signal must be connected to the rear panel of the instrument.

**Parameters:**

&lt;Source&gt;

**INTernal**

Uses the internal reference.

**EXTernal**

Uses the external reference; if none is available, an error flag is displayed in the status bar.

\*RST: INT

**Example:**

```
//Select an external reference oscillator
SOUR:EXT:ROSC EXT
```

**Manual operation:** See "[Reference](#)" on page 325**SYSTem:COMMunicate:RDEvice:GENerator:INTerface <Type>**

Defines the interface used for the connection to the external generator.

This command is only available if external generator control is active (see [SOURCE:EXTernal\[:STATe\]](#) on page 817).**Parameters:**

&lt;Type&gt;

PEXP | TCPip

\*RST: PEXP

**Example:**

```
SYST:COMM:RDEV:GEN:INT TCP
```

**Manual operation:** See "[Interface](#)" on page 324**SYSTem:COMMunicate:RDEvice:GENerator:TYPE <Type>**

This command selects the type of external generator.

For a list of the available generator types see "[Overview of Supported Generators](#)" on page 316.**Parameters:**

&lt;Name&gt;

&lt;Generator name as string value&gt;

\*RST: SMU02

**Example:**

```
//Select an external generator
SYST:COMM:RDEV:GEN:TYPE 'SMW06'
```

**Manual operation:** See "[Generator Type](#)" on page 324**SYSTem:COMMunicate:TCPip:RDEvice:GENerator:ADDRess <Address>**

Configures the TCP/IP address for the external generator.

**Parameters:**

&lt;Address&gt;

TCP/IP address between 0.0.0.0 and 0.255.255.255

\*RST: 0.0.0.0

**Example:**

```
SYST:COMM:TCP:RDEV:GEN:ADDR 130.094.122.195
```

**Manual operation:** See " [TCPIP Address / Computer Name](#) " on page 325

### Source Calibration

The following commands are required to activate the calibration functions of the external tracking generator. However, they are only available if external generator control is active (see [SOURCE:EXTERNAL\[:STATE\]](#) on page 817).

Useful commands for source calibration described elsewhere:

- [Chapter 12.10.3, "Working with Transducers"](#), on page 974
- [DISPLAY\[:WINDOW<n>\]:TRACE<t>:Y\[:SCALE\]:RPOSITION](#) on page 798

### Remote commands exclusive to source calibration:

|                                                                                 |     |
|---------------------------------------------------------------------------------|-----|
| <a href="#">DISPLAY[:WINDOW&lt;n&gt;]:TRACE&lt;t&gt;:Y[:SCALE]:RVALUE</a> ..... | 819 |
| <a href="#">[SENSE:]CORRECTION:COLLECT[:ACQUIRE]</a> .....                      | 819 |
| <a href="#">[SENSE:]CORRECTION:METHOd</a> .....                                 | 820 |
| <a href="#">[SENSE:]CORRECTION:RECall</a> .....                                 | 821 |
| <a href="#">[SENSE:]CORRECTION[:STATE]</a> .....                                | 821 |
| <a href="#">[SENSE:]CORRECTION:TRANSDUCER:GENERate</a> .....                    | 821 |

---

### [DISPLAY\[:WINDOW<n>\]:TRACE<t>:Y\[:SCALE\]:RVALUE <Value>](#)

The command defines the power value assigned to the reference position in the grid (for all traces).

For external generator calibration measurements (requires the optional External Generator Control), this command defines the power offset value assigned to the reference position.

#### Suffix:

|     |                        |
|-----|------------------------|
| <n> | <a href="#">Window</a> |
| <t> | irrelevant             |

#### Parameters:

<Value>                    \*RST:        0 dBm, coupled to reference level

#### Example:

`DISP:TRAC:Y:RVAL -20dBm`

Sets the power value assigned to the reference position to -20 dBm

**Manual operation:** See " [Reference Value](#) " on page 330

---

### [\[SENSE:\]CORRECTION:COLLECT\[:ACQUIRE\] <MeasType>](#)

This command initiates a reference measurement (calibration). The reference measurement is the basis for the measurement normalization. The result depends on whether a reflection measurement or transmission measurement is performed (see [\[SENSE:\]CORRECTION:METHOd](#) on page 820).

To obtain a correct reference measurement, a complete sweep with synchronization to the end of the sweep must have been carried out. This is only possible in the single sweep mode.

This command is only available if external generator control is active (see [SOURCE: EXTERNAL\[:STATe\]](#) on page 817).

**Parameters:**

<MeasType>

**THRough**

"TRANsmission" mode: calibration with direct connection between external generator and device input

"REFLEction" mode: calibration with short circuit at the input

**OPEN**

only allowed in "REFLEction" mode: calibration with open input

**Example:**

```
INIT:CONT OFF
```

Selects single sweep operation

```
CORR:METH TRAN
```

Selects a transmission measurement.

```
CORR:COLL THR;*WAI
```

Starts the measurement of reference data using direct connection between generator and device input and waits for the sweep end.

**Usage:**

Setting only

**Manual operation:**

See ["Calibrate Reflection Short"](#) on page 329

See ["Calibrate Reflection Open"](#) on page 329

**[SENSe:]CORRection:METHod <Type>**

This command selects the type of measurement to be performed with the external generator.

This command is only available if external generator control is active (see [SOURCE: EXTERNAL\[:STATe\]](#) on page 817).

**Parameters:**

<Type>

**REFLEction**

Selects reflection measurements.

**TRANsmission**

Selects transmission measurements.

```
*RST: TRANsmission
```

**Example:**

```
CORR:METH TRAN
```

Sets the type of measurement to "transmission".

**Manual operation:**

See ["Calibrate Transmission"](#) on page 328

See ["Calibrate Reflection Short"](#) on page 329

See ["Calibrate Reflection Open"](#) on page 329

**[SENSe:]CORRection:RECall**

This command restores the measurement configuration used for calibration.

This command is only available if external generator control is active (see [SOURCE: EXTERNAL\[:STATe\]](#) on page 817).

**Example:** CORR:REC

**Usage:** Event

**Manual operation:** See " [Recall](#) " on page 329

**[SENSe:]CORRection[:STATe] <State>**

This command turns correction of measurement results (normalization) on and off.

The command is available after you have created a reference trace for the selected measurement type with [\[SENSe:\]CORRection:COLLect\[:ACQuire\]](#) on page 819.

This command is only available if external generator control is active (see [SOURCE: EXTERNAL\[:STATe\]](#) on page 817).

**Parameters:**

<State> ON | OFF | 1 | 0  
\*RST: 0

**Example:** CORR ON  
Activates normalization.

**Manual operation:** See " [Source Calibration Normalize](#) " on page 329

**[SENSe:]CORRection:TRANsducer:GENerate <Name>**

This command uses the normalized measurement data to generate a transducer factor with up to 1001 points. The trace data is converted to a transducer with unit dB and stored in a file with the specified name and the suffix .trd under `c:\r_s\instr\trd`. The frequency points are allocated in equidistant steps between start and stop frequency.

The generated transducer factor can be further adapted using the commands described in [Chapter 12.10.3, "Working with Transducers"](#), on page 974).

**Parameters:**

<Name> '<name>'

**Example:** CORR:TRAN:GEN 'SMW200A1'  
Creates the transducer file  
`C:\r_s\instr\trd\SMW200A.trd`.

**Manual operation:** See " [Save as Trd Factor](#) " on page 329

### Programming Example for External Generator Control

The following example demonstrates how to work with an external generator in a remote environment.

It assumes a signal generator of the type SMA01A is connected to the R&S FPS via TCP/IP, as described in ["External Generator Connections"](#) on page 315.

```
//-----Preparing the instrument -----

//Reset the instrument
*RST

//Set the frequency span.
SENS:FREQ:STAR 10HZ
SENS:FREQ:STOP 1MHZ

//-----Configuring the interface -----

//Set the generator type to SMW06 with a frequency range of 100 kHz to 3GHz
SYST:COMM:RDEV:GEN:TYPE 'SMA01A'

//Set the interface used to the TCP/IP address 130.094.122.195
SYST:COMM:RDEV:GEN:INT TCP
SYST:COMM:TCP:RDEV:GEN:ADDR 130.094.122.195

//Activate the use of the external reference frequency at 10 MHz on the generator
SOUR:EXT:ROSC EXT

//-----Configuring the calibration measurement -----

//Activate external generator control.
SOUR:EXT:STAT ON
//Set the generator output level to -10 dBm.
SOUR:EXT:POW -10DBM
//Set the frequency coupling to automatic
SOUR:EXT:FREQ:COUP:STAT ON

//-----Configuring the generator frequency range -----

//Define a series of frequencies (one for each sweep point) based on the current
//frequency at the RF input of the analyzer; the generator frequency is half the
//frequency of the analyzer, with an offset of 100 kHz;
// analyzer start: 10 Hz
// analyzer stop: 1 MHz
// analyzer span: 999.99 KHz
// generator frequency start: 100.005 KHz
// generator frequency stop: 600 KHz
// generator span: 499.995 KHz

SOUR:EXT:FREQ:FACT:NUM 1
```

```

SOUR:EXT:FREQ:FACT:DEN 2
SOUR:EXT:FREQ:OFFS 100KHZ

//-----Performing the calibration measurement -----

//Perform a transmission measurement with direct connection between the generator
//and the analyzer and wait till the end
SENS:CORR:METH TRAN
SENS:CORR:COLL:ACQ THR; *WAI

//-----Retrieving the calibration trace results -----

//Retrieve the measured frequencies (10 Hz - 600 kHz)
TRAC:DATA:X? TRACE1

//Retrieve the measured power levels; = 0 between 10 Hz and 100 kHz (below
//generator minimum frequency); nominal -5dBm as of 100 kHz;
TRAC:DATA? TRACE1

//-----Normalizing the calibration trace results -----

//Retrieve the normalized power levels (= power offsets from calibration results)
//Should be 0 for all sweep points directly after calibration
SENS:CORR:STAT ON
TRAC:DATA? TRACE1

//-----Changing the display of the calibration results -----
//Shift the reference line so the -5 dB level is displayed in the center
DISP:TRAC:Y:SCAL:RVAL -5DB
DISP:TRAC:Y:SCAL:RPOS 50PCT

```

### 12.7.6.3 Working with Power Sensors

The following commands describe how to work with power sensors.

These commands require the use of a Rohde & Schwarz power sensor. For a list of supported sensors, see the data sheet.

- [Configuring Power Sensors](#)..... 823
- [Configuring Power Sensor Measurements](#)..... 825
- [Triggering with Power Sensors](#)..... 832

#### Configuring Power Sensors

- [SYSTem:COMMunicate:RDEvice:PMETer<p>:CONFigure:AUTO\[:STATe\]](#)..... 824
- [SYSTem:COMMunicate:RDEvice:PMETer:COUNT?](#)..... 824
- [SYSTem:COMMunicate:RDEvice:PMETer<p>:DEFine](#)..... 824

**SYSTem:COMMunicate:RDEvice:PMETer<p>:CONFigure:AUTO[:STATe] <State>**

This command turns automatic assignment of a power sensor to the power sensor index on and off.

**Suffix:**

<p> 1...4  
Power sensor index

**Parameters:**

<State> ON | OFF | 0 | 1  
\*RST: 1

**Example:**

SYST:COMM:RDEV:PMET:CONF:AUTO OFF

**Manual operation:** See " [Select](#) " on page 309

**SYSTem:COMMunicate:RDEvice:PMETer:COUNT?**

This command queries the number of power sensors currently connected to the R&S FPS.

**Parameters:**

<NumberSensors> Number of connected power sensors.

**Example:**

SYST:COMM:RDEV:PMET:COUN?

**Usage:**

Query only

**Manual operation:** See " [Select](#) " on page 309

**SYSTem:COMMunicate:RDEvice:PMETer<p>:DEFine <Placeholder>, <Type>, <Interface>, <SerialNo>**

This command assigns the power sensor with the specified serial number to the selected power sensor index (configuration).

The query returns the power sensor type and serial number of the sensor assigned to the specified index.

**Suffix:**

<p> 1...4  
Power sensor index

**Parameters:**

<Placeholder> Currently not used  
<Type> Detected power sensor type, e.g. "NRP-Z81".  
<Interface> Interface the power sensor is connected to; always "USB"  
<SerialNo> Serial number of the power sensor assigned to the specified index



**Example:** `SYST:COMM:RDEV:PMET2:DEF '', 'NRP-Z81', '', '123456'`  
 Assigns the power sensor with the serial number '123456' to the configuration "Power Sensor 2".  
`SYST:COMM:RDEV:PMET2:DEF?`  
 Queries the sensor assigned to "Power Sensor 2".  
**Result:**  
`'', 'NRP-Z81', 'USB', '123456'`  
 The NRP-Z81 power sensor with the serial number '123456' is assigned to the "Power Sensor 2".

**Manual operation:** See " [Select](#) " on page 309

### Configuring Power Sensor Measurements

|                                                                                         |     |
|-----------------------------------------------------------------------------------------|-----|
| <a href="#">CALibration:PMETer&lt;p&gt;:ZERO:AUTO ONCE</a> .....                        | 825 |
| <a href="#">CALCulate&lt;n&gt;:PMETer&lt;p&gt;:RELative[:MAGNitude]</a> .....           | 826 |
| <a href="#">CALCulate&lt;n&gt;:PMETer&lt;p&gt;:RELative[:MAGNitude]:AUTO ONCE</a> ..... | 826 |
| <a href="#">CALCulate&lt;n&gt;:PMETer&lt;p&gt;:RELative:STATE</a> .....                 | 826 |
| <a href="#">FETCh:PMETer&lt;p&gt;?</a> .....                                            | 827 |
| <a href="#">READ:PMETer&lt;p&gt;?</a> .....                                             | 827 |
| <a href="#">[SENSe:]PMETer&lt;p&gt;:DCYClE[:STATe]</a> .....                            | 827 |
| <a href="#">[SENSe:]PMETer&lt;p&gt;:DCYClE:VALue</a> .....                              | 827 |
| <a href="#">[SENSe:]PMETer&lt;p&gt;:FREQUency</a> .....                                 | 828 |
| <a href="#">[SENSe:]PMETer&lt;p&gt;:FREQUency:LINK</a> .....                            | 828 |
| <a href="#">[SENSe:]PMETer&lt;p&gt;:MTIME</a> .....                                     | 829 |
| <a href="#">[SENSe:]PMETer&lt;p&gt;:MTIME:AVERAge:COUNT</a> .....                       | 829 |
| <a href="#">[SENSe:]PMETer&lt;p&gt;:MTIME:AVERAge[:STATe]</a> .....                     | 829 |
| <a href="#">[SENSe:]PMETer&lt;p&gt;:ROFFset[:STATe]</a> .....                           | 830 |
| <a href="#">[SENSe:]PMETer&lt;p&gt;[:STATe]</a> .....                                   | 830 |
| <a href="#">[SENSe:]PMETer&lt;p&gt;:UPDate[:STATe]</a> .....                            | 831 |
| <a href="#">UNIT&lt;n&gt;:PMETer&lt;p&gt;:POWer</a> .....                               | 831 |
| <a href="#">UNIT&lt;n&gt;:PMETer&lt;p&gt;:POWer:RATio</a> .....                         | 831 |

---

### CALibration:PMETer<p>:ZERO:AUTO ONCE

This command zeroes the power sensor.

Note that you have to disconnect the signals from the power sensor input before you start to zero the power sensor. Otherwise, results are invalid.

#### Suffix:

<p> 1...4  
 Power sensor index

#### Parameters:

ONCE

#### Example:

`CAL:PMET2:ZERO:AUTO ONCE; *WAI`

Starts zeroing the power sensor 2 and delays the execution of further commands until zeroing is concluded.

#### Usage:

Event

**Manual operation:** See "[Zeroing Power Sensor](#)" on page 309

---

### **CALCulate<n>:PMETer<p>:RELative[:MAGNitude] <RefValue>**

This command defines the reference value for relative measurements.

**Suffix:**

<n> [Window](#)  
 <p> 1...4  
 Power sensor index

**Parameters:**

<RefValue> Range: -200 dBm to 200 dBm  
 \*RST: 0

**Example:**

`CALC:PMET2:REL -30`  
 Sets the reference value for relative measurements to -30 dBm for power sensor 2.

**Manual operation:** See "[Reference Value](#)" on page 310

---

### **CALCulate<n>:PMETer<p>:RELative[:MAGNitude]:AUTO ONCE**

This command sets the current measurement result as the reference level for relative measurements.

**Suffix:**

<n> [Window](#)  
 <p> 1...4  
 Power sensor index

**Parameters:**

ONCE

**Example:**

`CALC:PMET2:REL:AUTO ONCE`  
 Takes the current measurement value as reference value for relative measurements for power sensor 2.

**Usage:** Event

**Manual operation:** See "[Setting the Reference Level from the Measurement Measurements -> Ref](#)" on page 310

---

### **CALCulate<n>:PMETer<p>:RELative:STATe <State>**

This command turns relative power sensor measurements on and off.

**Suffix:**

<n> [Window](#)  
 <p> 1...4  
 Power sensor index

**Parameters:**

<State> ON | OFF | 1 | 0  
 \*RST: 0

**Example:**

CALC:PMET2:REL:STAT ON  
 Activates the relative display of the measured value for power sensor 2.

**FETCH:PMETer<p>?**

This command queries the results of power sensor measurements.

**Suffix:**

<p> 1...4  
 Power sensor index

**Return values:**

<Level> Power level that has been measured by a power sensor.  
 The unit is either dBm (absolute measurements) or dB (relative measurements).

**Usage:** Query only

**READ:PMETer<p>?**

This command initiates a power sensor measurement and queries the results.

**Suffix:**

<p> 1...4  
 Power sensor index

**Usage:** Query only

**[SENSe:]PMETer<p>:DCYCLE[:STATe] <State>**

This command turns the duty cycle correction on and off.

**Suffix:**

<p> 1...4  
 Power sensor index

**Parameters:**

<State> ON | OFF | 1 | 0  
 \*RST: 0

**Example:**

PMET2:DCYC:STAT ON

**Manual operation:** See " [Duty Cycle](#) " on page 311

**[SENSe:]PMETer<p>:DCYCLE:VALue <Percentage>**

This command defines the duty cycle for the correction of pulse signals.

The power sensor uses the duty cycle in combination with the mean power to calculate the power of the pulse.

**Suffix:**

<p> 1...4  
Power sensor

**Parameters:**

<Percentage> Range: 0.001 to 99.999  
\*RST: 99.999  
Default unit: %

**Example:**

PMET2:DCYC:STAT ON  
Activates the duty cycle correction.  
PMET2:DCYC:VAL 0.5  
Sets the correction value to 0.5%.

**Manual operation:** See " [Duty Cycle](#) " on page 311

**[SENSe:]PMETer<p>:FREQuency <Frequency>**

This command defines the frequency of the power sensor.

**Suffix:**

<p> 1...4  
Power sensor index

**Parameters:**

<Frequency> The available value range is specified in the data sheet of the power sensor in use.  
\*RST: 50 MHz

**Example:**

PMET2:FREQ 1GHZ  
Sets the frequency of the power sensor to 1 GHz.

**Manual operation:** See " [Frequency Manual](#) " on page 309

**[SENSe:]PMETer<p>:FREQuency:LINK <Coupling>**

This command selects the frequency coupling for power sensor measurements.

**Suffix:**

<p> 1...4  
Power sensor index

**Parameters:**

<Coupling> **CENTer**  
Couples the frequency to the center frequency of the analyzer  
**MARKer1**  
Couples the frequency to the position of marker 1  
**OFF**  
Switches the frequency coupling off  
\*RST: CENTer

**Example:** `PMET2:FREQ:LINK CENT`  
 Couples the frequency to the center frequency of the analyzer

**Manual operation:** See "[Frequency Coupling](#)" on page 309

**[SENSe:]PMETer<p>:MTIMe <Duration>**

This command selects the duration of power sensor measurements.

**Suffix:**

<p> 1...4  
 Power sensor index

**Parameters:**

<Duration> SHORt | NORMAl | LONG  
 \*RST: NORMAl

**Example:** `PMET2:MTIM SHOR`  
 Sets a short measurement duration for measurements of stationary high power signals for the selected power sensor.

**Manual operation:** See "[Meas Time/Average](#)" on page 310

**[SENSe:]PMETer<p>:MTIMe:AVERAge:COUNT <NumberReadings>**

This command sets the number of power readings included in the averaging process of power sensor measurements.

Extended averaging yields more stable results for power sensor measurements, especially for measurements on signals with a low power, because it minimizes the effects of noise.

**Suffix:**

<p> 1...4  
 Power sensor index

**Parameters:**

<NumberReadings> An average count of 0 or 1 performs one power reading.  
 Range: 0 to 256  
 Increment: binary steps (1, 2, 4, 8, ...)

**Example:** `PMET2:MTIM:AVER ON`  
 Activates manual averaging.  
`PMET2:MTIM:AVER:COUN 8`  
 Sets the number of readings to 8.

**Manual operation:** See "[Average Count \( Number of Readings \)](#)" on page 311

**[SENSe:]PMETer<p>:MTIMe:AVERAge[:STATe] <State>**

This command turns averaging for power sensor measurements on and off.

**Suffix:**  
 <p> 1...4  
 Power sensor index

**Parameters:**  
 <State> ON | OFF | 1 | 0  
 \*RST: 0

**Example:** PMET2:MTIM:AVER ON  
 Activates manual averaging.

**Manual operation:** See " [Meas Time/Average](#) " on page 310

**[SENSe:]PMETer<p>:ROFFset[:STATe] <State>**

This command includes or excludes the reference level offset of the analyzer for power sensor measurements.

**Suffix:**  
 <p> 1...4  
 Power sensor index

**Parameters:**  
 <State> **ON | 1**  
 Includes the reference level offset in the results.  
**OFF | 0**  
 Ignores the reference level offset.  
 \*RST: 1

**Example:** PMET2:ROFF OFF  
 Takes no offset into account for the measured power.

**Manual operation:** See " [Use Ref Level Offset](#) " on page 310

**[SENSe:]PMETer<p>[:STATe] <State>**

This command turns a power sensor on and off.

**Suffix:**  
 <p> 1...4  
 Power sensor index

**Parameters:**  
 <State> ON | OFF | 1 | 0  
 \*RST: 0

**Example:** PMET1 ON  
 Switches the power sensor measurements on.

**Manual operation:** See " [State](#) " on page 308  
 See " [Select](#) " on page 309

**[SENSe:]PMETer<p>:UPDate[:STATe] <State>**

This command turns continuous update of power sensor measurements on and off. If on, the results are update even if a single sweep is complete.

**Suffix:**

<p> 1...4  
Power sensor index

**Parameters:**

<State> ON | OFF | 1 | 0  
\*RST: 0

**Example:**

PMET1:UPD ON  
The data from power sensor 1 is updated continuously.

**Manual operation:** See "[Continuous Value Update](#)" on page 309

**UNIT<n>:PMETer<p>:POWer <Unit>**

This command selects the unit for absolute power sensor measurements.

**Suffix:**

<n> irrelevant  
<p> 1...4  
Power sensor index

**Parameters:**

<Unit> DBM | WATT | W  
\*RST: DBM

**Example:**

UNIT:PMET:POW DBM

**Manual operation:** See "[Unit/Scale](#)" on page 310

**UNIT<n>:PMETer<p>:POWer:RATio <Unit>**

This command selects the unit for relative power sensor measurements.

**Suffix:**

<n> irrelevant  
<p> 1...4  
Power sensor index

**Parameters:**

<Unit> DB | PCT  
\*RST: DB

**Example:**

UNIT:PMET:POW:RAT DB

**Manual operation:** See "[Unit/Scale](#)" on page 310

**Triggering with Power Sensors**

|                                           |     |
|-------------------------------------------|-----|
| [SENSe:]PMETer<p>:TRIGger:DTIME.....      | 832 |
| [SENSe:]PMETer<p>:TRIGger:HOLDoff.....    | 832 |
| [SENSe:]PMETer<p>:TRIGger:HYSteresis..... | 832 |
| [SENSe:]PMETer<p>:TRIGger:LEVel.....      | 833 |
| [SENSe:]PMETer<p>:TRIGger:SLOPe.....      | 833 |
| [SENSe:]PMETer<p>:TRIGger[:STATe].....    | 834 |

**[SENSe:]PMETer<p>:TRIGger:DTIME <Time>**

This command defines the time period that the input signal has to stay below the IF power trigger level before the measurement starts.

**Suffix:**

<p>                      1...4  
Power sensor index

**Parameters:**

<Time>                  Range:      0 s to 1 s  
Increment: 100 ns  
\*RST:        100 µs

**Example:**              PMET2:TRIG:DTIME 0.001

**[SENSe:]PMETer<p>:TRIGger:HOLDoff <Holdoff>**

This command defines the trigger holdoff for external power triggers.

**Suffix:**

<p>                        1...4  
Power sensor index

**Parameters:**

<Holdoff>                Time period that has to pass between the trigger event and the start of the measurement, in case another trigger event occurs.  
Range:            0 s to 1 s  
Increment: 100 ns  
\*RST:            0 s

**Example:**              PMET2:TRIG:HOLD 0.1  
Sets the holdoff time of the trigger to 100 ms

**Manual operation:**   See " [Trigger Holdoff](#) " on page 312

**[SENSe:]PMETer<p>:TRIGger:HYSteresis <Hysteresis>**

This command defines the trigger hysteresis for external power triggers.

The hysteresis in dB is the value the input signal must stay below the IF power trigger level in order to allow a trigger to start the measurement.



**Suffix:**

<p> 1...4  
Power sensor index

**Parameters:**

<Hysteresis> Range: 3 dB to 50 dB  
Increment: 1 dB  
\*RST: 0 dB

**Example:**

PMET2:TRIG:HYST 10  
Sets the hysteresis of the trigger to 10 dB.

**Manual operation:** See " [Hysteresis](#) " on page 311

**[SENSe:]PMETer<p>:TRIGger:LEVel <Level>**

This command defines the trigger level for external power triggers.

**Suffix:**

<p> 1...4  
Power sensor index

**Parameters:**

<Level> -20 to +20 dBm  
Range: -20 dBm to 20 dBm  
\*RST: -10 dBm

**Example:**

PMET2:TRIG:LEV -10 dBm  
Sets the level of the trigger

**Manual operation:** See " [External Trigger Level](#) " on page 311

**[SENSe:]PMETer<p>:TRIGger:SLOPe <Edge>**

This command selects the trigger condition for external power triggers.

**Suffix:**

<p> 1...4  
Power sensor index

**Parameters:**

<Edge> **POSitive**  
The measurement starts in case the trigger signal shows a positive edge.  
**NEGative**  
The measurement starts in case the trigger signal shows a negative edge.

\*RST: POSitive

**Example:**

PMET2:TRIG:SLOP NEG

**Manual operation:** See " [Slope](#) " on page 312

---

**[SENSe:]PMETer<p>:TRIGger[:STATe] <State>**

This command turns the external power trigger on and off.

**Suffix:**

<p>                    1...4  
Power sensor index

**Parameters:**

<State>                ON | OFF | 1 | 0  
\*RST:                0

**Example:**

PMET2:TRIG ON  
Switches the external power trigger on

**Manual operation:** See "[Using the power sensor as an external trigger](#)" on page 311

#### 12.7.6.4 Configuring the Outputs

The following commands are required to provide output from the R&S FPS.



Configuring trigger input/output is described in [Chapter 12.7.4.3, "Configuring the Trigger Output"](#), on page 807.

---

|                                                   |     |
|---------------------------------------------------|-----|
| <a href="#">DIAGnostic:SERVice:NSOource</a> ..... | 834 |
| <a href="#">OUTPut:IF[:SOURce]</a> .....          | 835 |

---

**DIAGnostic:SERVice:NSOource <State>**

This command turns the 28 V supply of the BNC connector labeled NOISE SOURCE CONTROL on the R&S FPS on and off.

**Suffix:**

<n>                    [Window](#)

**Parameters:**

<State>                ON | OFF | 1 | 0  
\*RST:                0

**Example:**

DIAG:SERV:NSO ON

**Manual operation:** See "[Noise Source Control](#)" on page 340

---

**OUTPut:IF[:SOURce]** <Source>

**Parameters:**

&lt;Source&gt;

**IF**

The measured IF value is available at the IF/VIDEO output connector.

**VIDeo**

The displayed video signal (i.e. the filtered and detected IF signal, 200mV) is available at the IF/VIDEO output connector.

This setting is required to provide demodulated audio frequencies at the output.

\*RST: IF

**Example:**

OUTP:IF VID

Selects the video signal for the IF/VIDEO output connector.

**Manual operation:** See " [IF/Video Output](#) " on page 339

## 12.8 Analyzing Measurements (Basics)

The commands for general analysis tasks are described here.

- [Zooming into the Display](#).....835
- [Configuring the Trace Display and Retrieving Trace Data](#).....837
- [Working with Markers](#).....862
- [Configuring Display and Limit Lines](#).....917

### 12.8.1 Zooming into the Display

#### 12.8.1.1 Using the Single Zoom

[DISPlay\[:WINDow<n>\]:ZOOM:AREA](#)..... 835

[DISPlay\[:WINDow<n>\]:ZOOM\[:STATe\]](#)..... 836

---

**DISPlay[:WINDow<n>]:ZOOM:AREA** <x1>,<y1>,<x2>,<y2>

This command defines the zoom area.

To define a zoom area, you first have to turn the zoom on.

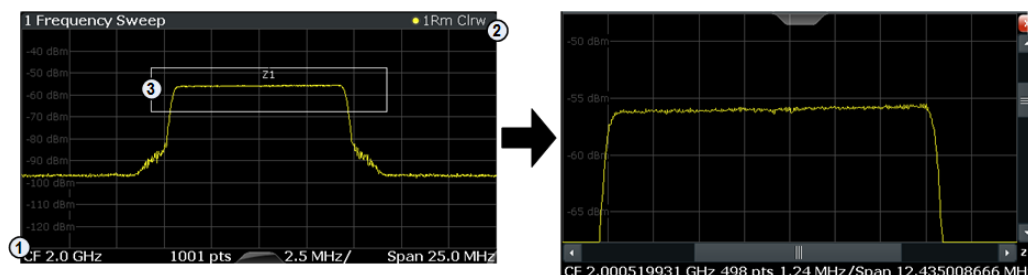

- 1 = origin of coordinate system (x1 = 0, y1 = 0)
- 2 = end point of system (x2 = 100, y2= 100)
- 3 = zoom area (e.g. x1 = 60, y1 = 30, x2 = 80, y2 = 75)

**Suffix:**

<n> Window

**Parameters:**

<x1>,<y1>,  
<x2>,<y2>

Diagram coordinates in % of the complete diagram that define the zoom area.  
The lower left corner is the origin of coordinate system. The upper right corner is the end point of the system.  
Range: 0 to 100  
Default unit: PCT

**Manual operation:** See " [Single Zoom](#) " on page 401

**DISPlay[:WINDow<n>]:ZOOM[:STATe] <State>**

This command turns the zoom on and off.

**Suffix:**

<n> Window

**Parameters:**

<State> ON | OFF | 1 | 0  
\*RST: 0

**Example:**

DISP:ZOOM ON  
Activates the zoom mode.

**Manual operation:** See " [Single Zoom](#) " on page 401  
See " [Restore Original Display](#) " on page 402  
See " [Deactivating Zoom \(Selection Mode\)](#) " on page 402

**12.8.1.2 Using the Multiple Zoom**

DISPlay[:WINDow<n>]:ZOOM:MULTiple<zoom>:AREA.....836  
DISPlay[:WINDow<n>]:ZOOM:MULTiple<zoom>[:STATe].....837

**DISPlay[:WINDow<n>]:ZOOM:MULTiple<zoom>:AREA <x1>,<y1>,<x2>,<y2>**

This command defines the zoom area for a multiple zoom.  
To define a zoom area, you first have to turn the zoom on.

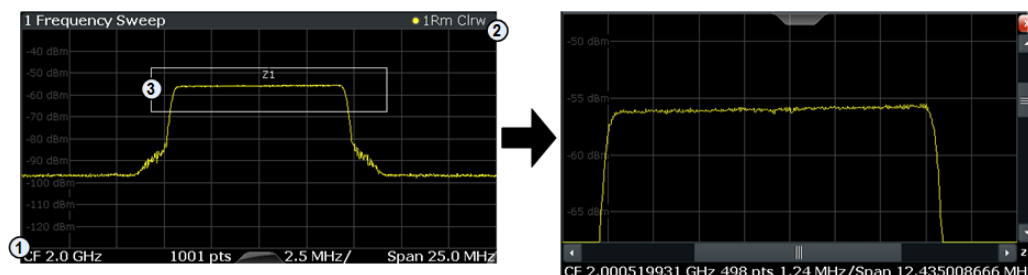

- 1 = origin of coordinate system (x1 = 0, y1 = 0)  
 2 = end point of system (x2 = 100, y2 = 100)  
 3 = zoom area (e.g. x1 = 60, y1 = 30, x2 = 80, y2 = 75)

**Suffix:**

- <n> [Window](#)  
 <zoom> 1...4  
 Selects the zoom window.

**Parameters:**

- <x1>, <y1>,  
 <x2>, <y2>  
 Diagram coordinates in % of the complete diagram that define the zoom area.  
 The lower left corner is the origin of coordinate system. The upper right corner is the end point of the system.  
 Range: 0 to 100  
 Default unit: PCT

**Manual operation:** See "[Multi-Zoom](#)" on page 402

**DISPlay[:WINDow<n>]:ZOOM:MULTiple<zoom>[:STATe] <State>**

This command turns the multiple zoom on and off.

**Suffix:**

- <n> [Window](#)  
 <zoom> 1...4  
 Selects the zoom window.  
 If you turn off one of the zoom windows, all subsequent zoom windows move up one position.

**Parameters:**

- <State> ON | OFF | 1 | 0  
 \*RST: 0

**Manual operation:** See "[Multi-Zoom](#)" on page 402  
 See "[Restore Original Display](#)" on page 402  
 See "[Deactivating Zoom \(Selection Mode\)](#)" on page 402

## 12.8.2 Configuring the Trace Display and Retrieving Trace Data

The commands required to work with traces are described here.



Commands required to export traces (and other result data) are described in [Chapter 12.9.5, "Storing Measurement Results"](#), on page 962.

- [Configuring Standard Traces](#)..... 838
- [Configuring Spectrograms](#)..... 844
- [Using Trace Mathematics](#)..... 851
- [Retrieving Trace Results](#)..... 853
- [Formats for Returned Values: ASCII Format and Binary Format](#)..... 857
- [Importing and Exporting Traces](#)..... 857
- [Programming Example: Configuring a Spectrogram](#)..... 859

### 12.8.2.1 Configuring Standard Traces

#### Useful commands for trace configuration described elsewhere

- [DISPlay\[:WINDow<n>\]:TRACe<t>:Y:SPACing](#) on page 799
- [DISPlay\[:WINDow<n>\]:TRACe<t>:Y\[:SCALE\]](#) on page 797

#### Remote commands exclusive to trace configuration

|                                                                                   |     |
|-----------------------------------------------------------------------------------|-----|
| <a href="#">DISPlay[:WINDow&lt;n&gt;]:TRACe&lt;t&gt;:MODE</a> .....               | 838 |
| <a href="#">DISPlay[:WINDow&lt;n&gt;]:TRACe&lt;t&gt;:MODE:HCONtinuous</a> .....   | 839 |
| <a href="#">DISPlay[:WINDow&lt;n&gt;]:TRACe&lt;t&gt;[:STATe]</a> .....            | 840 |
| <a href="#">DISPlay[:WINDow&lt;n&gt;]:TRACe&lt;t&gt;:SMOothing:APERture</a> ..... | 840 |
| <a href="#">DISPlay[:WINDow&lt;n&gt;]:TRACe&lt;t&gt;:SMOothing[:STATe]</a> .....  | 841 |
| <a href="#">[SENSe:]AVERage&lt;n&gt;:COUNT</a> .....                              | 841 |
| <a href="#">[SENSe:]AVERage&lt;n&gt;[:STATe&lt;t&gt;]</a> .....                   | 841 |
| <a href="#">[SENSe:]AVERage&lt;n&gt;:TYPE</a> .....                               | 842 |
| <a href="#">[SENSe:][WINDow&lt;n&gt;]:DETEctor&lt;t&gt;[:FUNCTion]</a> .....      | 842 |
| <a href="#">[SENSe:][WINDow&lt;n&gt;]:DETEctor&lt;t&gt;[:FUNCTion]:AUTO</a> ..... | 843 |
| <a href="#">TRACe&lt;n&gt;:COPY</a> .....                                         | 843 |

#### **DISPlay[:WINDow<n>]:TRACe<t>:MODE <Mode>**

This command selects the trace mode.

In case of max hold, min hold or average trace mode, you can set the number of single measurements with [\[SENSe:\]SWEep:COUNT](#). Note that synchronization to the end of the measurement is possible only in single sweep mode.

#### **Suffix:**

|                        |        |
|------------------------|--------|
| <code>&lt;n&gt;</code> | Window |
| <code>&lt;t&gt;</code> | Trace  |

**Parameters:**

&lt;Mode&gt;

**WRITE**

Overwrite mode: the trace is overwritten by each sweep. This is the default setting.

**AVERage**

The average is formed over several sweeps. The "Sweep/Average Count" determines the number of averaging procedures.

**MAXHold**

The maximum value is determined over several sweeps and displayed. The R&S FPS saves the sweep result in the trace memory only if the new value is greater than the previous one.

**MINHold**

The minimum value is determined from several measurements and displayed. The R&S FPS saves the sweep result in the trace memory only if the new value is lower than the previous one.

**VIEW**

The current contents of the trace memory are frozen and displayed.

**BLANK**

Hides the selected trace.

\*RST: Trace 1: WRITE, Trace 2-6: BLANK

**Example:**

```
INIT:CONT OFF
```

Switching to single sweep mode.

```
SWE:COUN 16
```

Sets the number of measurements to 16.

```
DISP:TRAC3:MODE WRIT
```

Selects clear/write mode for trace 3.

```
INIT;*WAI
```

Starts the measurement and waits for the end of the measurement.

**Manual operation:** See "[Trace Mode](#)" on page 466

**DISPlay[:WINDow<n>]:TRACe<t>:MODE:HCONTinuous <State>**

This command turns an automatic reset of a trace on and off after a parameter has changed.

The reset works for trace modes min hold, max hold and average.

Note that the command has no effect if critical parameters like the span have been changed to avoid invalid measurement results

**Suffix:**

<n> [Window](#)

<t> [Trace](#)

**Parameters:**

<State>            **ON | 1**  
 The automatic reset is off.

**OFF | 0**  
 The automatic reset is on.

\*RST:            0

**Example:**

DISP:WIND:TRAC3:MODE:HCON ON  
 Switches off the reset function.

**Manual operation:** See " [Hold](#) " on page 467

**DISPlay[:WINDow<n>]:TRACe<t>[:STATe] <State>**

This command turns a trace on and off.

The measurement continues in the background.

**Suffix:**

<n>                    [Window](#)

<t>                    [Trace](#)

**Parameters:**

<State>            ON | OFF | 1 | 0  
 \*RST:            1 for TRACe1, 0 for TRACe 2 to 6

**Example:**

DISP:TRAC3 ON

**Manual operation:** See " [Trace 1 / Trace 2 / Trace 3 / Trace 4 / Trace 5 / Trace 6](#) " on page 466  
 See " [Trace 1 / Trace 2 / Trace 3 / Trace 4 \(Softkeys\)](#) " on page 469

**DISPlay[:WINDow<n>]:TRACe<t>:SMOothing:APERture <Percentage>**

This command defines the degree (aperture) of the trace smoothing, if [DISPlay\[:WINDow<n>\]:TRACe<t>:SMOothing\[:STATe\]](#) TRUE.

**Suffix:**

<n>                    [Window](#)

<t>                    [Trace](#)

**Parameters:**

<Percentage>      Range:        1 to 50  
 \*RST:            2  
 Default unit: PCT

**Example:**

DISP3:TRAC2:SMO:APER 5  
 Defines an aperture of 5% for trace 2 in window 3

**Manual operation:** See " [Smoothing](#) " on page 468



**DISPlay[:WINDow<n>]:TRACe<t>:SMOothing[:STATe] <State>**

This command turns trace smoothing for a particular trace on and off.

If enabled, the trace is smoothed by the value specified using [DISPlay\[:WINDow<n>\]:TRACe<t>:SMOothing:APERture](#) on page 840.

For more information see "Trace Smoothing" on page 464.

**Suffix:**

<n> [Window](#)

<t> [Trace](#)

**Parameters:**

<State> ON | OFF | 1 | 0

\*RST: 0

**Example:**

DISP3:TRAC2:SMO ON

Turns on trace smoothing for trace 2 in window 3

**Manual operation:** See " [Smoothing](#) " on page 468

**[SENSe:]AVERAge<n>:COUNT <AverageCount>**

This command defines the number of sweep s that the application uses to average traces.

In case of continuous sweep mode, the application calculates the moving average over the average count.

In case of single sweep mode, the application stops the measurement and calculates the average after the average count has been reached.

**Suffix:**

<n> irrelevant

**Parameters:**

<AverageCount> If you set an average count of 0 or 1, the application performs one single sweep in single sweep mode.

In continuous sweep mode, if the average count is set to 0, a moving average over 10 sweep s is performed.

Range: 0 to 200000

\*RST: 0

**Manual operation:** See " [Sweep/Average Count](#) " on page 370

See " [Average Count](#) " on page 468

**[SENSe:]AVERAge<n>[:STATe<t>] <State>**

This command turns averaging for a particular trace in a particular window on and off.

**Suffix:**

<n> [Window](#)

<t> [Trace](#)

**Parameters:**

<State> ON | OFF | 1 | 0

**[SENSe:]AVERAge<n>:TYPE <Mode>**

This command selects the trace averaging mode.

**Suffix:**

<n> [Window](#)

**Parameters:**

<Mode>

**VIDeo**

The logarithmic power values are averaged.

**LINear**

The power values are averaged before they are converted to logarithmic values.

**POWer**

The power level values are converted into unit Watt prior to averaging. After the averaging, the data is converted back into its original unit.

\*RST: VIDEo

**Example:**

AVER:TYPE LIN

Switches to linear average calculation.

**Manual operation:** See "[Average Mode](#)" on page 468

**[SENSe:][WINDow<n>:]DETector<t>[:FUNction] <Detector>**

Defines the trace detector to be used for trace analysis.

For details see "[Mapping Samples to sweep Points with the Trace Detector](#)" on page 459.

**Suffix:**

<n> [Window](#)

<t> [Trace](#)

**Parameters:**

|            |                                                       |
|------------|-------------------------------------------------------|
| <Detector> | <b>APEak</b><br>Autoppeak                             |
|            | <b>NEGative</b><br>Negative peak                      |
|            | <b>POSitive</b><br>Positive peak                      |
|            | <b>SAMPIe</b><br>First value detected per trace point |
|            | <b>RMS</b><br>RMS value                               |
|            | <b>AVERAge</b><br>Average                             |
|            | *RST:        APEak                                    |

**Example:**

DET POS  
Sets the detector to "positive peak".

**Manual operation:** See " [Detector](#) " on page 467

**[SENSe:][WINDow<n>:]DETEctor<t>[:FUNction]:AUTO <State>**

This command couples and decouples the detector to the trace mode.

**Suffix:**

|     |                        |
|-----|------------------------|
| <n> | <a href="#">Window</a> |
| <t> | <a href="#">Trace</a>  |

**Parameters:**

<State>        ON | OFF | 0 | 1  
\*RST:        1

**Example:**

DET:AUTO OFF  
The selection of the detector is not coupled to the trace mode.

**Manual operation:** See " [Detector](#) " on page 467

**TRACe<n>:COPY <TraceNumber>, <TraceNumber>**

This command copies data from one trace to another.

**Suffix:**

<n>            [Window](#)

**Parameters:**

<TraceNumber>,  
<TraceNumber>        **TRACE1 | TRACE2 | TRACE3 | TRACE4 | TRACE5 | TRACE6**  
The first parameter is the destination trace, the second parameter is the source.  
(Note the 'e' in the parameter is required!)

**Example:** `TRAC:COPY TRACE1, TRACE2`  
Copies the data from trace 2 to trace 1.

**Manual operation:** See "Copy Trace" on page 469

### 12.8.2.2 Configuring Spectrograms

In addition to the standard "level versus frequency" or "level versus time" spectrum traces, the R&S FPS also provides a spectrogram display of the measured data. A spectrogram shows how the spectral density of a signal varies over time. The x-axis shows the frequency, the y-axis shows the time. The commands required to configure spectrograms in a remote environment are described here. For details and manual operation see [Chapter 8.5.2.2, "Spectrogram Settings"](#), on page 478.



When configuring spectrograms, the window suffix is irrelevant. The settings are always applied to the spectrogram window, or to all spectrogram windows, if several are active for the same channel.

For commands to set markers in spectrograms, see [Chapter 12.8.3.6, "Marker Search \(Spectrograms\)"](#), on page 882.

|                                            |     |
|--------------------------------------------|-----|
| Configuring a Spectrogram Measurement..... | 844 |
| Configuring the Color Map.....             | 849 |

#### Configuring a Spectrogram Measurement

|                                                                     |     |
|---------------------------------------------------------------------|-----|
| <code>CALCulate&lt;n&gt;:SGRam:CLEar[:IMMediate]</code> .....       | 844 |
| <code>CALCulate&lt;n&gt;:SPECtrogram:CLEar[:IMMediate]</code> ..... | 844 |
| <code>CALCulate&lt;n&gt;:SGRam:CONTInuous</code> .....              | 845 |
| <code>CALCulate&lt;n&gt;:SPECtrogram:CONTInuous</code> .....        | 845 |
| <code>CALCulate&lt;n&gt;:SGRam:FRAMe:COUNT</code> .....             | 845 |
| <code>CALCulate&lt;n&gt;:SPECtrogram:FRAMe:COUNT</code> .....       | 845 |
| <code>CALCulate&lt;n&gt;:SGRam:FRAMe:SELEct</code> .....            | 846 |
| <code>CALCulate&lt;n&gt;:SPECtrogram:FRAMe:SELEct</code> .....      | 846 |
| <code>CALCulate&lt;n&gt;:SGRam:HDEPth</code> .....                  | 846 |
| <code>CALCulate&lt;n&gt;:SPECtrogram:HDEPth</code> .....            | 846 |
| <code>CALCulate&lt;n&gt;:SGRam:LAYout</code> .....                  | 847 |
| <code>CALCulate&lt;n&gt;:SPECtrogram:LAYout</code> .....            | 847 |
| <code>CALCulate&lt;n&gt;:SGRam[:STATe]</code> .....                 | 847 |
| <code>CALCulate&lt;n&gt;:SPECtrogram[:STATe]</code> .....           | 847 |
| <code>CALCulate&lt;n&gt;:SGRam:TSTamp:DATA?</code> .....            | 847 |
| <code>CALCulate&lt;n&gt;:SPECtrogram:TSTamp:DATA?</code> .....      | 847 |
| <code>CALCulate&lt;n&gt;:SGRam:TSTamp[:STATe]</code> .....          | 848 |
| <code>CALCulate&lt;n&gt;:SPECtrogram:TSTamp[:STATe]</code> .....    | 848 |

**`CALCulate<n>:SGRam:CLEar[:IMMediate]`**

**`CALCulate<n>:SPECtrogram:CLEar[:IMMediate]`**

This command resets the spectrogram and clears the history buffer.

|                          |                                                                               |
|--------------------------|-------------------------------------------------------------------------------|
| <b>Suffix:</b>           |                                                                               |
| <n>                      | irrelevant                                                                    |
| <b>Example:</b>          | <code>CALC:SGR:CLE</code><br>Resets the result display and clears the memory. |
| <b>Usage:</b>            | Event                                                                         |
| <b>Manual operation:</b> | See " <a href="#">Clear Spectrogram</a> " on page 373                         |

**CALCulate<n>:SGRam:CONTInuous <State>**

**CALCulate<n>:SPECtrogram:CONTInuous <State>**

This command determines whether the results of the last measurement are deleted before starting a new measurement in single sweep mode.

This setting applies to all spectrograms in the channel.

|                    |                  |
|--------------------|------------------|
| <b>Suffix:</b>     |                  |
| <n>                | irrelevant       |
| <b>Parameters:</b> |                  |
| <State>            | 1   0   ON   OFF |
|                    | <b>1   ON</b>    |
|                    | <b>0   OFF</b>   |
| <b>*RST:</b>       | 0                |

|                 |                                                                                                                             |
|-----------------|-----------------------------------------------------------------------------------------------------------------------------|
| <b>Example:</b> | <code>INIT:CONT OFF</code><br>Selects single sweep mode.                                                                    |
|                 | <code>INIT;*WAI</code><br>Starts the sweep and waits for the end of the sweep.                                              |
|                 | <code>CALC:SGR:CONT ON</code><br>Repeats the single sweep measurement without deleting the results of the last measurement. |

|                          |                                                                                                                     |
|--------------------------|---------------------------------------------------------------------------------------------------------------------|
| <b>Manual operation:</b> | See " <a href="#">Single Sweep / Run Single</a> " on page 371<br>See " <a href="#">Continue Frame</a> " on page 372 |
|--------------------------|---------------------------------------------------------------------------------------------------------------------|

**CALCulate<n>:SGRam:FRAME:COUNT <Frames>**

**CALCulate<n>:SPECtrogram:FRAME:COUNT <Frames>**

This command defines the number of frames to be recorded in a single sweep.

This value applies to all spectrograms in the channel.

|                    |                                                            |
|--------------------|------------------------------------------------------------|
| <b>Suffix:</b>     |                                                            |
| <n>                | irrelevant                                                 |
| <b>Parameters:</b> |                                                            |
| <Frames>           | The maximum number of frames depends on the history depth. |
|                    | Range: 1 to history depth                                  |
|                    | Increment: 1                                               |
| <b>*RST:</b>       | 1                                                          |

**Example:**           INIT:CONT OFF  
                           Selects single sweep mode.  
                           CALC:SGR:FRAM:COUN 200  
                           Sets the number of frames to 200.

**Manual operation:** See "[Frame Count](#)" on page 373

**CALCulate<n>:SGRam:FRAM:SElect <Frame> | <Time>**  
**CALCulate<n>:SPECtrogram:FRAM:SElect <Frame> | <Time>**

This command selects a specific frame for further analysis.

The command is available if no measurement is running or after a single sweep has ended.

**Suffix:**  
 <n>                   irrelevant

**Parameters:**

<Frame>             Selects a frame directly by the frame number. Valid if the time stamp is off.  
                           The range depends on the history depth.

<Time>              Selects a frame via its time stamp. Valid if the time stamp is on.  
                           The number is the distance to frame 0 in seconds. The range depends on the history depth.

**Example:**           INIT:CONT OFF  
                           Stop the continuous sweep.  
                           CALC:SGR:FRAM:SEL -25  
                           Selects frame number -25.

**Manual operation:** See "[Select Frame](#)" on page 372

**CALCulate<n>:SGRam:HDEPth <History>**  
**CALCulate<n>:SPECtrogram:HDEPth <History>**

This command defines the number of frames to be stored in the R&S FPS memory.

**Suffix:**  
 <n>                   irrelevant

**Parameters:**

<History>           The maximum number of frames depends on the number of sweep points.  
                           Range:       781 to 20000  
                           Increment: 1  
                           \*RST:       3000

**Example:**           CALC:SGR:SPEC 1500  
                           Sets the history depth to 1500.

**Manual operation:** See "[History Depth](#)" on page 479

---

**CALCulate<n>:SGRam:LAYout <State>**

**CALCulate<n>:SPECtrogram:LAYout <State>**

This command selects the state and size of spectrograms.

The command is available for result displays that support spectrograms.

**Suffix:**

<n> [Window](#)

**Parameters:**

<State> **FULL**  
Only the spectrogram is displayed, the trace diagram is not.

**SPLIT**  
Spectrogram and trace diagram share a window.

**OFF**  
Only the trace diagram is displayed, the spectrogram is not.

\*RST: OFF

**Example:**

CALC4:SPEC:LAY FULL

Shows the spectrogram in window 4. The corresponding trace diagram is hidden.

**Manual operation:** See ["State"](#) on page 479

---

**CALCulate<n>:SGRam[:STATe] <State>**

**CALCulate<n>:SPECtrogram[:STATe] <State>**

This command turns the spectrogram on and off.

**Suffix:**

<n> irrelevant

**Parameters:**

<State> ON | OFF | 1 | 0

\*RST: 0

**Example:**

CALC:SGR ON

Activates the Spectrogram result display.

---

**CALCulate<n>:SGRam:TSTamp:DATA? <Frames>**

**CALCulate<n>:SPECtrogram:TSTamp:DATA? <Frames>**

This command queries the starting time of the frames.

The return values consist of four values for each frame. If the Spectrogram is empty, the command returns '0,0,0,0'. The times are given as delta values, which simplifies evaluating relative results; however, you can also calculate the absolute date and time as displayed on the screen.

The frame results themselves are returned with `TRAC:DATA? SGR`

See [TRACe<n> \[:DATA\]](#) on page 854.

|                          |                                                                                                                                                                            |
|--------------------------|----------------------------------------------------------------------------------------------------------------------------------------------------------------------------|
| <b>Suffix:</b>           |                                                                                                                                                                            |
| <n>                      | irrelevant                                                                                                                                                                 |
| <b>Query parameters:</b> |                                                                                                                                                                            |
| <Frames>                 | <b>CURRent</b><br>Returns the starting time of the current frame.                                                                                                          |
|                          | <b>ALL</b><br>Returns the starting time for all frames. The results are sorted in descending order, beginning with the current frame.                                      |
| <b>Return values:</b>    |                                                                                                                                                                            |
| <Seconds>                | Number of seconds that have passed since 01.01.1970 till the frame start                                                                                                   |
| <Nanoseconds>            | Number of nanoseconds that have passed <i>in addition to the</i> <Seconds> since 01.01.1970 till the frame start.                                                          |
| <Reserved>               | The third and fourth value are reserved for future uses.                                                                                                                   |
| <b>Example:</b>          | <code>CALC:SGR:TST ON</code><br>Activates the time stamp.<br><code>CALC:SGR:TST:DATA? ALL</code><br>Returns the starting times of all frames sorted in a descending order. |
| <b>Usage:</b>            | Query only                                                                                                                                                                 |
| <b>Manual operation:</b> | See " <a href="#">Time Stamp</a> " on page 479                                                                                                                             |

---

**CALCulate<n>:SGRam:TSTamp[:STATe] <State>**  
**CALCulate<n>:SPECTrogram:TSTamp[:STATe] <State>**

This command activates and deactivates the time stamp.

If the time stamp is active, some commands do not address frames as numbers, but as (relative) time values:

- [CALCulate<n>:DELTaMarker<m>:SPECTrogram:FRAMe](#) on page 888
- [CALCulate<n>:MARKer<m>:SPECTrogram:FRAMe](#) on page 883
- [CALCulate<n>:SPECTrogram:FRAMe:SELeCt](#) on page 846

|                          |                                                           |
|--------------------------|-----------------------------------------------------------|
| <b>Suffix:</b>           |                                                           |
| <n>                      | irrelevant                                                |
| <b>Parameters:</b>       |                                                           |
| <State>                  | ON   OFF   1   0<br>*RST: 0                               |
| <b>Example:</b>          | <code>CALC:SGR:TST ON</code><br>Activates the time stamp. |
| <b>Manual operation:</b> | See " <a href="#">Time Stamp</a> " on page 479            |



**Configuring the Color Map**

|                                                    |     |
|----------------------------------------------------|-----|
| DISPlay[:WINDow<n>]:SGRam:COLor:DEFault.....       | 849 |
| DISPlay[:WINDow<n>]:SPECTrogram:COLor:DEFault..... | 849 |
| DISPlay[:WINDow<n>]:SGRam:COLor:LOWer.....         | 849 |
| DISPlay[:WINDow<n>]:SPECTrogram:COLor:LOWer.....   | 849 |
| DISPlay[:WINDow<n>]:SGRam:COLor:SHAPE.....         | 849 |
| DISPlay[:WINDow<n>]:SPECTrogram:COLor:SHAPE.....   | 849 |
| DISPlay[:WINDow<n>]:SGRam:COLor:UPPer.....         | 850 |
| DISPlay[:WINDow<n>]:SPECTrogram:COLor:UPPer.....   | 850 |
| DISPlay[:WINDow<n>]:SGRam:COLor[:STYLe].....       | 850 |
| DISPlay[:WINDow<n>]:SPECTrogram:COLor[:STYLe]..... | 850 |

**DISPlay[:WINDow<n>]:SGRam:COLor:DEFault****DISPlay[:WINDow<n>]:SPECTrogram:COLor:DEFault**

This command restores the original color map.

**Suffix:**

<n>                      Window

**Usage:**                      Event

**Manual operation:**    See " [Set to Default](#) " on page 482

**DISPlay[:WINDow<n>]:SGRam:COLor:LOWer <Percentage>****DISPlay[:WINDow<n>]:SPECTrogram:COLor:LOWer <Percentage>**

This command defines the starting point of the color map.

**Suffix:**

<n>                      Window

**Parameters:**

<Percentage>              Statistical frequency percentage.

Range:              0 to 66

\*RST:              0

Default unit: %

**Example:**                      DISP:WIND:SGR:COL:LOW 10

Sets the start of the color map to 10%.

**Manual operation:**    See " [Start / Stop](#) " on page 481

**DISPlay[:WINDow<n>]:SGRam:COLor:SHAPE <Shape>****DISPlay[:WINDow<n>]:SPECTrogram:COLor:SHAPE <Shape>**

This command defines the shape and focus of the color curve for the spectrogram result display.

**Suffix:**

<n>                      Window

**Parameters:**

<Shape>                    Shape of the color curve.  
 Range:                    -1 to 1  
 \*RST:                    0

**Manual operation:**    See " [Shape](#) " on page 481

**DISPlay[:WINDow<n>]:SGRam:COLor:UPPer** <Percentage>

**DISPlay[:WINDow<n>]:SPECtrogram:COLor:UPPer** <Percentage>

This command defines the end point of the color map.

**Suffix:**

<n>                            [Window](#)

**Parameters:**

<Percentage>                Statistical frequency percentage.  
 Range:                    0 to 66  
 \*RST:                    0  
 Default unit: %

**Example:**

DISP:WIND:SGR:COL:UPP 95

Sets the start of the color map to 95%.

**Manual operation:**    See " [Start / Stop](#) " on page 481

**DISPlay[:WINDow<n>]:SGRam:COLor[:STYLE]** <ColorScheme>

**DISPlay[:WINDow<n>]:SPECtrogram:COLor[:STYLE]** <ColorScheme>

This command selects the color scheme.

**Parameters:**

<ColorScheme>              **HOT**  
 Uses a color range from blue to red. Blue colors indicate low levels, red colors indicate high ones.

**COLD**  
 Uses a color range from red to blue. Red colors indicate low levels, blue colors indicate high ones.

**RADar**  
 Uses a color range from black over green to light turquoise with shades of green in between.

**GRAYscale**  
 Shows the results in shades of gray.  
 \*RST:                    HOT

**Example:**

DISP:WIND:SPEC:COL GRAY

Changes the color scheme of the spectrogram to black and white.

**Manual operation:**    See " [Hot / Cold / Radar / Grayscale](#) " on page 481

### 12.8.2.3 Using Trace Mathematics

The following commands control trace mathematics.

|                                              |     |
|----------------------------------------------|-----|
| CALCulate<n>:MATH[:EXPRession][:DEFine]..... | 851 |
| CALCulate<n>:MATH:MODE.....                  | 851 |
| CALCulate<n>:MATH:POSition.....              | 852 |
| CALCulate<n>:MATH:STATe.....                 | 852 |

---

#### CALCulate<n>:MATH[:EXPRession][:DEFine] <Expression>

This command selects the mathematical expression for trace mathematics.

Before you can use the command, you have to turn trace mathematics on.

##### Suffix:

<n> [Window](#)

##### Parameters:

<Expression>      **(TRACE1-TRACE2)**  
Subtracts trace 2 from trace 1.

**(TRACE1-TRACE3)**  
Subtracts trace 3 from trace 1.

**(TRACE1-TRACE4)**  
Subtracts trace 4 from trace 1.

**(TRACE1-TRACE5)**  
Subtracts trace 5 from trace 1.

**(TRACE1-TRACE6)**  
Subtracts trace 6 from trace 1.

##### Example:

```
CALC:MATH:STAT ON
Turns trace mathematics on.
CALC:MATH:EXPR:DEF (TRACE1-TRACE3)
Subtracts trace 3 from trace 1.
```

**Manual operation:** See "[Trace Math Function](#)" on page 487

---

#### CALCulate<n>:MATH:MODE <Mode>

This command selects the way the R&S FPS calculates trace mathematics.

##### Suffix:

<n> [Window](#)

**Parameters:**

<Mode> For more information on the way each mode works see [Trace Math Mode](#).

**LINEar**

Linear calculation.

**LOGarithmic**

Logarithmic calculation.

**POWER**

Linear power calculation.

\*RST: LOGarithmic

**Example:**

CALC:MATH:MODE LIN  
Selects linear calculation.

**Manual operation:** See "[Trace Math Mode](#)" on page 488

**CALCulate<n>:MATH:POSition <Position>**

This command defines the position of the trace resulting from the mathematical operation.

**Suffix:**

<n> [Window](#)

**Parameters:**

<Position> Vertical position of the trace in % of the height of the diagram area.

100 PCT corresponds to the upper diagram border.

Range: -100 to 200

\*RST: 50

Default unit: PCT

**Example:**

CALC:MATH:POS 100  
Moves the trace to the top of the diagram area.

**Manual operation:** See "[Trace Math Position](#)" on page 488

**CALCulate<n>:MATH:STATe <State>**

This command turns the trace mathematics on and off.

**Suffix:**

<n> [Window](#)

**Parameters:**

<State> ON | OFF | 1 | 0

\*RST: 0

**Example:**

CALC:MATH:STAT ON  
Turns on trace mathematics.

**Manual operation:** See " [Trace Math Function](#) " on page 487  
See " [Trace Math Off](#) " on page 487

#### 12.8.2.4 Retrieving Trace Results

This chapter describes how to retrieve data from standard traces.

For spectrograms see also [Chapter 12.8.3.6, "Marker Search \(Spectrograms\)"](#), on page 882.

For details on the format of the retrieved trace data see also [Chapter 12.8.2.5, "Formats for Returned Values: ASCII Format and Binary Format"](#), on page 857.



Commands required to export traces (and other result data) are described in [Chapter 12.9.5, "Storing Measurement Results"](#), on page 962.

|                                                     |     |
|-----------------------------------------------------|-----|
| <a href="#">FORMat[:DATA]</a> .....                 | 853 |
| <a href="#">TRACe&lt;n&gt;[:DATA]</a> .....         | 854 |
| <a href="#">TRACe&lt;n&gt;[:DATA]:MEMory?</a> ..... | 856 |
| <a href="#">TRACe&lt;n&gt;[:DATA]:X?</a> .....      | 856 |

#### **FORMat[:DATA]** <Format>

This command selects the data format that is used for transmission of trace data from the R&S FPS to the controlling computer.

Note that the command has no effect for data that you send to the R&S FPS. The R&S FPS automatically recognizes the data it receives, regardless of the format.

For details on data formats see [Chapter 12.8.2.5, "Formats for Returned Values: ASCII Format and Binary Format"](#), on page 857.

**Parameters:**

&lt;Format&gt;

**ASCII**

ASCII format, separated by commas.

This format is almost always suitable, regardless of the actual data format. However, the data is not as compact as other formats may be.

**REAL,16**

16-bit floating-point numbers (according to IEEE 754) in the "definite length block format".

In the Spectrum application, the format setting `REAL` is used for the binary transmission of trace data.

Compared to `REAL, 32` format, half as many numbers are returned.

**REAL,32**

32-bit floating-point numbers (according to IEEE 754) in the "definite length block format".

In the Spectrum application, the format setting `REAL` is used for the binary transmission of trace data.

For I/Q data, 8 bytes per sample are returned for this format setting.

**REAL,64**

64-bit floating-point numbers (according to IEEE 754) in the "definite length block format".

In the Spectrum application, the format setting `REAL` is used for the binary transmission of trace data.

Compared to `REAL, 32` format, twice as many numbers are returned.

\*RST: ASCII

**Example:**

```
FORM REAL, 32
```

---

**TRACe<n>[:DATA]** <Trace>, <Data>

**TRACe<n>[:DATA]?** <ResultType>

This command queries current trace data and measurement results.

The data format depends on `FORMat [:DATA]`.

**Suffix:**

&lt;n&gt;

[Window](#)**Parameters:**

&lt;Trace&gt;

Selects the trace to write the data to.

**TRACE1 | ... | TRACE6**

&lt;Data&gt;

Contains the data to transfer.

**Query parameters:**

- <ResultType>** Selects the type of result to be returned.
- TRACE1 | ... | TRACE6**  
Returns the trace data for the corresponding trace.  
For details see [Table 12-6](#).
- LIST**  
Returns the results of the peak list evaluation for Spurious Emission and Spectrum Emission Mask measurements.  
For SEM measurements, one peak per range is returned.  
For details see [Table 12-7](#).
- SPURious**  
Returns the peak list of Spurious Emission measurements.
- SPECTrogram | SGRam**  
Returns the results of the spectrogram result display.  
For details see [Table 12-8](#).
- Return values:**
- <TraceData>** For more information see tables below.
- Example:** `TRAC TRACE1,+A$`  
Transfers trace data ('+A\$') to trace 1.
- Example:** `TRAC? TRACE3`  
Queries the data of trace 3.
- Manual operation:** See "[List Evaluation State \(Result Summary\)](#)" on page 234  
See "[List Evaluation State](#)" on page 257  
See "[Diagram](#)" on page 394

**Table 12-6: Return values for TRACE1 to TRACE6 parameter**

The trace data consists of a list of power levels that have been measured. The number of power levels in the list depends on the currently selected number of sweep points. The unit depends on the measurement and on the unit you have currently set.

If you are measuring with the auto peak detector, the command returns positive peak values only. (To retrieve negative peak values, define a second trace with a negative peak detector.)

For SEM or Spurious Emission measurement results, the x-values should be queried as well, as they are not equidistant (see `TRACe<n>[:DATA]:X?` on page 856).

**Table 12-7: Return values for LIST parameter**

For each peak, the command returns 11 values in the following order:

`<No>,<StartFreq>,<StopFreq>,<RBW>,<PeakFreq>,<PowerAbs>,<PowerRel>,<PowerDelta>,<LimitCheck>,<Unused1>,<Unused2>`

- `<No>`: range number
- `<StartFreq>,<StopFreq>`: start and stop frequency of the range
- `<RBW>`: resolution bandwidth
- `<PeakFreq>`: frequency of the peak in a range
- `<PowerAbs>`: absolute power of the peak in dBm
- `<PowerRel>`: power of the peak in relation to the channel power in dBc
- `<PowerDelta>`: distance from the peak to the limit line in dB, positive values indicate a failed limit check
- `<LimitCheck>`: state of the limit check (0 = PASS, 1 = FAIL)
- `<Unused1>,<Unused2>`: reserved (0.0)

**Table 12-8: Return values for SPECTrogram parameter**

For every frame in the spectrogram, the command returns the power levels that have been measured, one for each sweep point. The number of frames depends on the size of the history depth. The power level depends on the unit you have currently set.

---

**TRACe<n>[:DATA]:MEMory? <Trace>,<OffsSwPoint>,<NoOfSwPoints>**

This command queries the previously captured trace data for the specified trace from the memory. As an offset and number of sweep points to be retrieved can be specified, the trace data can be retrieved in smaller portions, making the command faster than the `TRAC:DATA?` command. This is useful if only specific parts of the trace data are of interest.

If no parameters are specified with the command, the entire trace data is retrieved; in this case, the command returns the same results as `TRAC:DATA? TRACE1`.

For details on the returned values see the [TRAC:DATA? <TRACE...>](#) command.

**Suffix:**

<n> [Window](#)

**Query parameters:**

<Trace> TRACE1 | TRACE2 | TRACE3 | TRACE4 | TRACE5 | TRACE6

<OffsSwPoint> The offset in sweep points related to the start of the measurement at which data retrieval is to start.

<NoOfSwPoints> Number of sweep points to be retrieved from the trace.

**Example:**

`TRAC:DATA:MEM? TRACE1,25,100`

Retrieves 100 sweep points from trace 1, starting at sweep point 25.

**Usage:**

Query only

---

**TRACe<n>[:DATA]:X? <TraceNumber>**

This command queries the horizontal trace data for each sweep point in the specified window, for example the frequency in frequency domain or the time in time domain measurements.

This is especially useful for traces with non-equidistant x-values, e.g. for SEM or Spurious Emissions measurements.

**Suffix:**

<n> [Window](#)

**Query parameters:**

<TraceNumber> Trace number.

**TRACE1 | ... | TRACE6**

**Example:**

`TRAC3:X? TRACE1`

Returns the x-values for trace 1 in window 3.

**Usage:**

Query only



### 12.8.2.5 Formats for Returned Values: ASCII Format and Binary Format

When trace data is retrieved using the `TRAC:DATA` or `TRAC:IQ:DATA` command, the data is returned in the format defined using the `FORMat [:DATA]`. The possible formats are described here.

- **ASCII Format (FORMat ASCII):**  
The data is stored as a list of comma-separated values (CSV) of the measured values in floating point format.
- **Binary Format (FORMat REAL,32):**  
The data is stored as binary data (Definite Length Block Data according to IEEE 488.2), each measurement value being formatted in 32-Bit IEEE 754 Floating-Point-Format.  
The schema of the result string is as follows:  
`#41024<value1><value2>...<value n>` with

|         |                                                                             |
|---------|-----------------------------------------------------------------------------|
| #4      | Number of digits (= 4 in the example) of the following number of data bytes |
| 1024    | Number of following data bytes (= 1024 in the example)                      |
| <Value> | 4-byte floating point value                                                 |



Reading out data in binary format is quicker than in ASCII format. Thus, binary format is recommended for large amounts of data.

### 12.8.2.6 Importing and Exporting Traces

|                                                 |     |
|-------------------------------------------------|-----|
| <code>FORMat:DEXPort:FORMat</code> .....        | 857 |
| <code>FORMat:DEXPort:TRACes</code> .....        | 858 |
| <code>FORMat:DIMPort:TRACes</code> .....        | 858 |
| <code>MMEMory:LOAD&lt;n&gt;:TRACe</code> .....  | 858 |
| <code>MMEMory:STORe&lt;n&gt;:TRACe</code> ..... | 859 |

#### **FORMat:DEXPort:FORMat** <FileFormat>

Determines the format of the ASCII file to be imported or exported. Depending on the external program in which the data file was created or will be evaluated, a comma-separated list (CSV) or a plain data format (DAT) file may be required.

#### **Parameters:**

<FileFormat>            CSV | DAT  
                              \*RST:        DAT

**Example:**                FORM:DEXP:FORM CSV

**Manual operation:**    See " [File Type](#) " on page 493

**FORMat:DEXPort:TRACes** <Selection>

This command selects the data to be included in a data export file (see [MMEMory:STORe<n>:TRACe](#) on page 859).

**Parameters:**

&lt;Selection&gt;

**SINGle**

Only a single trace is selected for export, namely the one specified by the [MMEMory:STORe<n>:TRACe](#) command.

**ALL**

Selects all active traces and result tables (e.g. Result Summary, marker peak list etc.) in the current application for export to an ASCII file.

The <trace> parameter for the [MMEMory:STORe<n>:TRACe](#) command is ignored.

\*RST: SINGle

**Manual operation:** See " [Export all Traces and all Table Results](#) " on page 491

**FORMat:DIMPort:TRACes** <Selection>

This command selects the data to be included in a data import file (see [MMEMory:LOAD<n>:TRACe](#) on page 858).

For details on importing data see [Chapter 8.6.3, "How to Import Traces"](#), on page 494.

**Parameters:**

&lt;Selection&gt;

**SINGle**

Only a single trace is selected for import, namely the one specified by the [MMEMory:LOAD<n>:TRACe](#) command.

**ALL**

Imports several traces at once, overwriting the existing trace data for any active trace in the result display with the same trace number. Data from the import file for currently not active traces is not imported.

The <trace> parameter for the [MMEMory:LOAD<n>:TRACe](#) command is ignored.

\*RST: SINGle

**Manual operation:** See " [Import All Traces / Import to Trace](#) " on page 493

**MMEMory:LOAD<n>:TRACe** <Trace>, <FileName>

This command imports trace data from the specified window to an ASCII file.

For details on the file format see [Chapter 8.6.6, "Reference: ASCII File Export Format"](#), on page 495.

**Suffix:**

&lt;n&gt;

[Window](#)

**Parameters:**

<Trace>                    Number of the trace to be stored  
(This parameter is ignored for `FORMat:DImport:TRACes ALL`).

<FileName>                String containing the path and name of the import file.

**Manual operation:**    See " [Import ASCII File to Trace](#) " on page 493

**MMEMory:STORe<n>:TRACe** <Trace>, <FileName>

This command exports trace data from the specified window to an ASCII file.

For details on the file format see [Chapter 8.6.6, "Reference: ASCII File Export Format"](#), on page 495.

**Secure User Mode**

In secure user mode, settings that are stored on the instrument are stored to volatile memory, which is restricted to 256 MB. Thus, a "memory limit reached" error can occur although the hard disk indicates that storage space is still available.

To store data permanently, select an external storage location such as a USB memory device.

For details, see [Chapter 4.1.6, "Protecting Data Using the Secure User Mode"](#), on page 33.

**Suffix:**

<n>                            [Window](#)

**Setting parameters:**

<Trace>                    Number of the trace to be stored  
(This parameter is ignored if the option "Export all Traces and all Table Results" is activated in the Export configuration settings, see `FORMat:DEXPort:TRACes` on page 858).

<FileName>                String containing the path and name of the target file.

**Example:**                `MMEM:STOR1:TRAC 1, 'C:\TEST.ASC'`  
Stores trace 1 from window 1 in the file `TEST.ASC`.

**Usage:**                    Setting only

**Manual operation:**    See " [Export Trace to ASCII File](#) " on page 492  
See " [Export Trace to ASCII File](#) " on page 514

**12.8.2.7 Programming Example: Configuring a Spectrogram**

This example demonstrates how to configure a spectrogram for a basic frequency sweep in a remote environment. The spectrogram is displayed in addition to the spectrum display, in a new window. In addition, the usage of special spectrogram markers is demonstrated (see [Chapter 12.8.3.6, "Marker Search \(Spectrograms\)"](#), on page 882).



Basic trace settings are demonstrated in the [Chapter 12.15.1, "Programming Example: Performing a Basic Frequency Sweep"](#), on page 1042.

```
//-----Preparing the Measurement -----
*RST
//Resets the instrument
LAY:ADD? '1',BEL,SGR
//Displays a new window below window 1 and activates spectrogram display.
//The new window name is returned as a result: '2'.
//The spectrogram is updated with each new sweep.
INIT:CONT OFF
//Selects single sweep mode.

//-----Configuring the Spectrogram-----
CALC:SGR:CLE
//Clears the displayed spectrogram to start a new one.
CALC:SGR:CONT ON
//Configures a continuous spectrogram for a series of measurements.
//The display is not cleared when a new measurement is started.
CALC:SGR:FRAM:COUN 100
//Sets the number of frames to be recorded per sweep to 100.
CALC:SGR:HDEP 1000
//Sets the number of frames to be stored to 1000 (=10 sweeps)
CALC:SGR:TST ON
//Activates a time stamp for each frame.

//-----Configuring the Color Map-----
DISP:WIND:SGR:COL GRAY
//Defines a gray-scaled coloring: low values light gray, high values dark gray.
DISP:WIND:SGR:COL:LOW 30
DISP:WIND:SGR:COL:UPP 70
DISP:WIND:SGR:COL:SHAP 0.8
//Defines a color map for a range that comprises 40% of the measurement range,
//excluding 30% at each end. The colors are not scaled linearly; the light gray
//colors are stretched to distinguish low values better.

//-----Performing the Measurement-----
SWE:COUN 10
//Defines 10 sweeps to be performed per measurement.
INIT;*WAI
//Initiates a new measurement and waits until the sweeps have finished.
//The spectrogram is updated with each new sweep.

//-----Positioning Markers-----
CALC:MARK:SGR:SAR MEM
//Includes all frames in the memory in the search area

CALC:MARK1:SGR:FRAM -1s
```

```

//Sets marker 1 to the frame 1 second after measurement begin. (Note the
//negative value!
CALC:MARK1:MIN
//Sets marker 1 to the minimum level in this frame.
CALC:MARK1:SGR:Y:MIN
//Sets marker 1 to the minimum level for the same frequency the marker is
//currently positioned at in all frames.

CALC:MARK2:SGR:XY:MAX
//Sets marker 2 to the maximum level in the entire spectrogram.

CALC:DELT1:SGR:FRAM 3s
//Sets the deltamarker 1 to the frame captured 3 seconds after marker 1. By default
//it is set to the peak of that frame and displays the level difference to marker 1.
//Note the positive value!
CALC:DELT1:MIN
//Sets deltamarker 1 to the minimum level in this frame.

CALC:DELT3:SGR:XY:MAX
//Sets deltamarker 3 to the maximum level in the entire spectrogram. By default
//its value is the difference to marker 1. We will change it to refer to marker 2.
CALC:DELT3:MREF 2
//Deltamarker 3 now refers to marker 2, both are positioned on the maximum of the
//spectrogram. Thus, D3=0. We will move deltamarker 3 to the next peak level
//for the same frequency.
CALC:DELT3:SGR:Y:MAX:NEXT

//-----Retrieving Results-----
CALC:MARK1:X?
CALC:MARK1:Y?
CALC:MARK1:SGR:FRAM?
//Queries the frequency (x), level (y) and frame values of marker 1.

CALC:MARK2:X?
CALC:MARK2:Y?
CALC:MARK2:SGR:FRAM?
//Queries the frequency (x), level (y) and frame values of marker 2.

CALC:DELT1:X?
CALC:DELT1:Y?
CALC:DELT1:SGR:FRAM?
//Queries the frequency (x), level (y) and frame values of deltamarker 1.

CALC:DELT3:X?
CALC:DELT3:Y?
CALC:DELT3:SGR:FRAM?
//Queries the frequency (x), level (y) and frame values of deltamarker 3.

CALC:SGR:TST:DATA? ALL
//Queries the time stamps of all stored frames.

```

```

CALC:SGR:FRAM:SEL -1
//Selects the frame that was captured 1 second after measurement start (Note the
//negative value!). This frame is displayed in the Spectrum window.
TRAC:DATA? SGR
//Retrieves the trace data for the spectrogram. For each frame, the power level
//and frequency at each sweep point are returned.
TRAC:DATA? TRACE1
//Retrieves the trace data for the selected frame only.

```

### 12.8.3 Working with Markers

The commands required to work with markers and marker functions in a remote environment are described here. The tasks for manual operation are described in [Chapter 8.3, "Marker Usage"](#), on page 404.



In the Spectrum application, markers are identical in all windows. Thus, the suffix <n> for the window is generally irrelevant.

|                                                                                     |     |
|-------------------------------------------------------------------------------------|-----|
| • <a href="#">Setting Up Individual Markers</a> .....                               | 862 |
| • <a href="#">General Marker Settings</a> .....                                     | 868 |
| • <a href="#">Configuring and Performing a Marker Search</a> .....                  | 869 |
| • <a href="#">Positioning the Marker</a> .....                                      | 873 |
| • <a href="#">Retrieving Marker Results</a> .....                                   | 879 |
| • <a href="#">Marker Search (Spectrograms)</a> .....                                | 882 |
| • <a href="#">Fixed Reference Marker Settings</a> .....                             | 892 |
| • <a href="#">Marker Peak Lists</a> .....                                           | 894 |
| • <a href="#">Noise Measurement Marker</a> .....                                    | 897 |
| • <a href="#">Phase Noise Measurement Marker</a> .....                              | 898 |
| • <a href="#">Band Power Marker</a> .....                                           | 901 |
| • <a href="#">n dB Down Marker</a> .....                                            | 904 |
| • <a href="#">Signal Count Marker</a> .....                                         | 908 |
| • <a href="#">Programming Examples for Using Markers and Marker Functions</a> ..... | 910 |

#### 12.8.3.1 Setting Up Individual Markers

The following commands define the position of markers in the diagram.

|                                                    |     |
|----------------------------------------------------|-----|
| CALCulate<n>:DELTamarker<m>:AOFF.....              | 863 |
| CALCulate<n>:DELTamarker<m>:LINK.....              | 863 |
| CALCulate<n>:DELTamarker<m>:LINK:TO:MARKer<m>..... | 863 |
| CALCulate<n>:DELTamarker<m>:MODE.....              | 864 |
| CALCulate<n>:DELTamarker<m>:MREF.....              | 864 |
| CALCulate<n>:DELTamarker<m>[:STATE].....           | 865 |
| CALCulate<n>:DELTamarker<m>:TRACe.....             | 865 |
| CALCulate<n>:DELTamarker<m>:X.....                 | 865 |
| CALCulate<n>:MARKer<m>:AOFF.....                   | 866 |
| CALCulate<n>:MARKer<m>:LINK:TO:MARKer<m>.....      | 866 |

|                                     |     |
|-------------------------------------|-----|
| CALCulate<n>:MARKer<m>[:STATE]..... | 867 |
| CALCulate<n>:MARKer<m>:TRACe.....   | 867 |
| CALCulate<n>:MARKer<m>:X.....       | 867 |

---

### CALCulate<n>:DELTaMarker<m>:AOFF

This command turns off *all* delta markers.

**Suffix:**

<n>                      Window

<m>                      irrelevant

**Example:**

CALC:DELT:AOFF  
Turns off all delta markers.

**Usage:**                      Event

---

### CALCulate<n>:DELTaMarker<m>:LINK <State>

This command links delta marker <m> to marker 1.

If you change the horizontal position (x-value) of marker 1, delta marker <m> changes its horizontal position to the same value.

**Tip:** to link any marker to a different marker than marker 1, use the [CALCulate<n>:DELTaMarker<m>:LINK:TO:MARKer<m>](#) or [CALCulate<n>:MARKer<m>:LINK:TO:MARKer<m>](#) commands.

**Suffix:**

<n>                      Window

<m>                      Marker

**Parameters:**

<State>                      ON | OFF | 1 | 0  
\*RST:                      0

**Example:**                      CALC:DELT2:LINK ON

**Manual operation:**    See "[Linking to Another Marker](#)" on page 410

---

### CALCulate<n>:DELTaMarker<m1>:LINK:TO:MARKer<m2> <State>

This command links delta marker <m1> to any active normal marker <m2>.

If you change the horizontal position of marker <m2>, delta marker <m1> changes its horizontal position to the same value.

**Suffix:**

<n>                      Window

<m>                      Marker

**Parameters:**

<State> ON | OFF | 1 | 0  
 \*RST: 0

**Example:**

CALC:DELT4:LINK:TO:MARK2 ON  
 Links the delta marker 4 to the marker 2.

**Manual operation:** See " [Linking to Another Marker](#) " on page 410

**CALCulate<n>:DELTamarker<m>:MODE <Mode>**

This command defines whether the position of a delta marker is provided as an absolute value or relative to a reference marker.

Note that when the position of a delta marker is *queried*, the result is always an absolute value (see [CALCulate<n>:DELTamarker<m>:X](#) on page 865)!

**Suffix:**

<n> [Window](#)  
 <m> irrelevant

**Parameters:**

<Mode> **ABSolute**  
 Delta marker position in absolute terms.  
**RELative**  
 Delta marker position in relation to a reference marker.  
 \*RST: RELative

**Example:**

CALC:DELT:MODE ABS  
 Absolute delta marker position.

**CALCulate<n>:DELTamarker<m>:MREF <Reference>**

This command selects a reference marker for a delta marker other than marker 1.

The reference may be another marker or the fixed reference.

**Suffix:**

<n> [Window](#)  
 <m> [Marker](#)

**Parameters:**

<Reference> **FIXed**  
 Selects the fixed reference as the reference.

**Example:**

CALC:DELT3:MREF 2  
 Specifies that the values of delta marker 3 are relative to marker 2.

**Manual operation:** See " [Reference Marker](#) " on page 410



**CALCulate<n>:DELTaMarker<m>[:STATe] <State>**

This command turns delta markers on and off.

If necessary, the command activates the delta marker first.

No suffix at DELTmarker turns on delta marker 1.

**Suffix:**

<n> [Window](#)

<m> [Marker](#)

**Parameters:**

<State> ON | OFF | 1 | 0

\*RST: 0

**Example:**

CALC:DELT2 ON

Turns on delta marker 2.

**Manual operation:**

See "[Marker State](#)" on page 409

See "[Marker Type](#)" on page 409

See "[Select Marker](#)" on page 410

**CALCulate<n>:DELTaMarker<m>:TRACe <Trace>**

This command selects the trace a delta marker is positioned on.

Note that the corresponding trace must have a trace mode other than "Blank".

If necessary, the command activates the marker first.

**Suffix:**

<n> [Window](#)

<m> [Marker](#)

**Parameters:**

<Trace> Trace number the marker is assigned to.

**Example:**

CALC:DELT2:TRAC 2

Positions delta marker 2 on trace 2.

**CALCulate<n>:DELTaMarker<m>:X <Position>**

This command moves a delta marker to a particular coordinate on the x-axis.

If necessary, the command activates the delta marker and positions a reference marker to the peak power.

**Suffix:**

<m> [Marker](#)

<n> [Window](#)

**Parameters:**

**<Position>** Numeric value that defines the marker position on the x-axis. The position is relative to the reference marker. To select an absolute position you have to change the delta marker mode with `CALCulate<n>:DELTAmarker<m>:MODE` on page 864. A query returns the absolute position of the delta marker.

**Range:** The value range and unit depend on the measurement and scale of the x-axis.

**Example:**

`CALC:DELT:X?`  
Outputs the absolute x-value of delta marker 1.

**Manual operation:** See "[Marker 1 / Marker 2 / Marker 3 / Marker 4](#)" on page 293  
See "[Marker 1 / Marker 2 / Marker 3](#)" on page 297  
See "[Marker Position X-value](#)" on page 409

**CALCulate<n>:MARKer<m>:AOFF**

This command turns off all markers.

**Suffix:**

**<n>** [Window](#)

**<m>** [Marker](#)

**Example:**

`CALC:MARK:AOFF`  
Switches off all markers.

**Usage:**

Event

**Manual operation:** See "[All Marker Off](#)" on page 411

**CALCulate<n>:MARKer<m>:LINK:TO:MARKer<m> <State>**

This command links normal marker <m1> to any active normal marker <m2>.

If you change the horizontal position of marker <m2>, marker <m1> changes its horizontal position to the same value.

**Suffix:**

**<n>** [Window](#)

**<m>** [Marker](#)

**Parameters:**

**<State>** ON | OFF | 1 | 0  
\*RST: 0

**Example:**

`CALC:MARK4:LINK:TO:MARK2 ON`  
Links marker 4 to marker 2.

**Manual operation:** See "[Linking to Another Marker](#)" on page 410

**CALCulate<n>:MARKer<m>[:STATe] <State>**

This command turns markers on and off. If the corresponding marker number is currently active as a delta marker, it is turned into a normal marker.

**Suffix:**

<n> [Window](#)

<m> [Marker](#)

**Parameters:**

<State> ON | OFF | 1 | 0

\*RST: 0

**Example:**

CALC:MARK3 ON

Switches on marker 3.

**Manual operation:**

See "[Marker State](#)" on page 409

See "[Marker Type](#)" on page 409

See "[Select Marker](#)" on page 410

**CALCulate<n>:MARKer<m>:TRACe <Trace>**

This command selects the trace the marker is positioned on.

Note that the corresponding trace must have a trace mode other than "Blank".

If necessary, the command activates the marker first.

**Suffix:**

<n> [Window](#)

<m> [Marker](#)

**Parameters:**

<Trace> **1 to 6**

Trace number the marker is assigned to.

**Example:**

CALC:MARK3:TRAC 2

Assigns marker 3 to trace 2.

**Manual operation:**

See "[Assigning the Marker to a Trace](#)" on page 410

**CALCulate<n>:MARKer<m>:X <Position>**

This command moves a marker to a particular coordinate on the x-axis.

If necessary, the command activates the marker.

If the marker has been used as a delta marker, the command turns it into a normal marker.

**Suffix:**

<m> [Marker](#) (query: 1 to 16)

<n> [Window](#)

**Parameters:**

<Position> Numeric value that defines the marker position on the x-axis. The unit is either Hz (frequency domain) or s (time domain) or dB (statistics).  
 Range: The range depends on the current x-axis range.

**Example:**

CALC:MARK2:X 1.7MHz  
 Positions marker 2 to frequency 1.7 MHz.

**Manual operation:**

See " [Marker 1 / Marker 2 / Marker 3 / Marker 4](#) " on page 293  
 See " [Marker 1 / Marker 2 / Marker 3](#) " on page 297  
 See " [Marker Table](#) " on page 394  
 See " [Marker Peak List](#) " on page 394  
 See " [Marker Position X-value](#) " on page 409

**12.8.3.2 General Marker Settings**

The following commands control general marker functionality.

**Remote commands exclusive to general marker functionality**

|                                     |     |
|-------------------------------------|-----|
| DISPlay[:WINDow<n>]:MTABle.....     | 868 |
| DISPlay:MINFo[:STATe].....          | 868 |
| CALCulate<n>:MARKer<m>:X:SSIZe..... | 869 |

**DISPlay[:WINDow<n>]:MTABle <DisplayMode>**

This command turns the marker table on and off.

**Suffix:**

<n> irrelevant

**Parameters:**

<DisplayMode> **ON | 1**  
 Turns on the marker table.  
**OFF | 0**  
 Turns off the marker table.  
**AUTO**  
 Turns on the marker table if 3 or more markers are active.  
 \*RST: AUTO

**Example:**

DISP:MTAB ON  
 Activates the marker table.

**Manual operation:** See " [Marker Table Display](#) " on page 412

**DISPlay:MINFo[:STATe] <DisplayMode>**

This command turns the marker information in all diagrams on and off.

**Parameters:**

<DisplayMode>    **ON | 1**  
 Displays the marker information in the diagrams.

**OFF | 0**  
 Hides the marker information in the diagrams.

\*RST:            1

**Example:**

DISP:MINF OFF  
 Hides the marker information.

**Manual operation:** See " [Marker Info](#) " on page 412

**CALCulate<n>:MARKer<m>:X:SSIZe <StepSize>**

This command selects the marker step size mode for *all* markers in *all* windows.

The step size defines the distance the marker moves when you move it with the rotary knob.

It therefore takes effect in manual operation only.

**Suffix:**

<n>, <m>            irrelevant

**Parameters:**

<StepSize>        **STANdard**  
 the marker moves from one pixel to the next

**POINTs**  
 the marker moves from one sweep point to the next

\*RST:            POINTs

**Example:**

CALC:MARK:X:SSIZ STAN  
 Sets the marker step size to one pixel.

**Manual operation:** See " [Marker Stepsize](#) " on page 412

**12.8.3.3 Configuring and Performing a Marker Search**

The following commands control the marker search.

|                                                    |     |
|----------------------------------------------------|-----|
| CALCulate<n>:MARKer<m>:LOEXclude.....              | 870 |
| CALCulate<n>:MARKer<m>:PEXCursion.....             | 870 |
| CALCulate<n>:MARKer<m>:X:SLIMits[:STATe].....      | 870 |
| CALCulate<n>:MARKer<m>:X:SLIMits:LEFT.....         | 871 |
| CALCulate<n>:MARKer<m>:X:SLIMits:RIGHT.....        | 871 |
| CALCulate<n>:MARKer<m>:X:SLIMits:ZOOM[:STATe]..... | 872 |
| CALCulate<n>:THReshold.....                        | 872 |
| CALCulate<n>:THReshold:STATe.....                  | 873 |

**CALCulate<n>:MARKer<m>:LOEXclude <State>**

This command turns the suppression of the local oscillator during automatic marker positioning on and off (for *all* markers in *all* windows).

**Suffix:**

<n>, <m>                    irrelevant

**Parameters:**

<State>                    ON | OFF | 0 | 1

\*RST:                    1

**Example:**

CALC:MARK:LOEX ON

**Manual operation:** See "[Exclude LO](#)" on page 414

**CALCulate<n>:MARKer<m>:PEXCursion <Excursion>**

This command defines the peak excursion (for *all* markers in *all* windows).

The peak excursion sets the requirements for a peak to be detected during a peak search.

The unit depends on the measurement.

| Application/Result display | Unit |
|----------------------------|------|
| Spectrum                   | dB   |

**Suffix:**

<n>, <m>                    irrelevant

**Parameters:**

<Excursion>                The excursion is the distance to a trace maximum that must be attained before a new maximum is recognized, or the distance to a trace minimum that must be attained before a new minimum is recognized

\*RST:                    6 dB in the Spectrum application and RF displays

**Example:**

CALC:MARK:PEXC 10dB

Defines peak excursion as 10 dB.

**Manual operation:** See "[Peak Excursion](#)" on page 415

**CALCulate<n>:MARKer<m>:X:SLIMits[:STATe] <State>**

This command turns marker search limits on and off for *all* markers in *all* windows.

If you perform a measurement in the time domain, this command limits the range of the trace to be analyzed.

**Suffix:**

<n>, <m>                    irrelevant

**Parameters:**

<State> ON | OFF | 1 | 0  
 \*RST: 0

**Example:**

CALC:MARK:X:SLIM ON  
 Switches on search limitation.

**Manual operation:**

See " [Search Limits \( Left / Right \)](#)" on page 202  
 See " [Deactivating All Search Limits](#) " on page 203  
 See " [Limit State](#) " on page 278

**CALCulate<n>:MARKer<m>:X:SLIMits:LEFT <SearchLimit>**

This command defines the left limit of the marker search range for *all* markers in *all* windows.

If you perform a measurement in the time domain, this command limits the range of the trace to be analyzed.

**Suffix:**

<n>, <m> irrelevant

**Parameters:**

<SearchLimit> The value range depends on the frequency range or sweep time.  
 The unit is Hz for frequency domain measurements and s for time domain measurements.  
 \*RST: left diagram border

**Example:**

CALC:MARK:X:SLIM ON  
 Switches the search limit function on.  
 CALC:MARK:X:SLIM:LEFT 10MHz  
 Sets the left limit of the search range to 10 MHz.

**Manual operation:**

See " [Search Limits \( Left / Right \)](#)" on page 202  
 See " [Left Limit / Right Limit](#) " on page 278

**CALCulate<n>:MARKer<m>:X:SLIMits:RIGHT <SearchLimit>**

This command defines the right limit of the marker search range for *all* markers in *all* windows.

If you perform a measurement in the time domain, this command limits the range of the trace to be analyzed.

**Suffix:**

<n>, <m> irrelevant

**Parameters:**

<Limit> The value range depends on the frequency range or sweep time.  
The unit is Hz for frequency domain measurements and s for time domain measurements.  
\*RST: right diagram border

**Example:**

```
CALC:MARK:X:SLIM ON
Switches the search limit function on.
CALC:MARK:X:SLIM:RIGH 20MHz
Sets the right limit of the search range to 20 MHz.
```

**Manual operation:** See " [Search Limits \( Left / Right \)](#) " on page 202  
See " [Left Limit / Right Limit](#) " on page 278

**CALCulate<n>:MARKer<m>:X:SLIMits:ZOOM[:STATe] <State>**

This command adjusts the marker search range to the zoom area for *all* markers in *all* windows.

**Suffix:**

<n>, <m> irrelevant

**Parameters:**

<State> ON | OFF | 1 | 0  
\*RST: 0

**Example:**

```
CALC:MARK:X:SLIM:ZOOM ON
Switches the search limit function on.
CALC:MARK:X:SLIM:RIGH 20MHz
Sets the right limit of the search range to 20 MHz.
```

**Manual operation:** See " [Use Zoom Limits](#) " on page 415

**CALCulate<n>:THReshold <Level>**

This command defines a threshold level for the marker peak search (for *all* markers in *all* windows).

**Suffix:**

<n> irrelevant

**Parameters:**

<Level> Numeric value. The value range and unit are variable.  
\*RST: -120 dBm

**Example:**

```
CALC:THR -82DBM
Sets the threshold value to -82 dBm.
```

**Manual operation:** See " [Search Threshold](#) " on page 415



**CALCulate<n>:THReshold:STATe <State>**

This command turns a threshold for the marker peak search on and off (for *all* markers in *all* windows).

**Suffix:**

<n> irrelevant

**Parameters:**

<State> ON | OFF | 1 | 0

\*RST: 0

**Example:**

CALC:THR:STAT ON

Switches on the threshold line.

**Manual operation:** See "[Deactivating All Search Limits](#)" on page 203

**12.8.3.4 Positioning the Marker**

This chapter contains remote commands necessary to position the marker on a trace.

- [Positioning Normal Markers](#) ..... 873
- [Positioning Delta Markers](#)..... 877

**Positioning Normal Markers**

The following commands position markers on the trace.

|                                            |     |
|--------------------------------------------|-----|
| CALCulate<n>:MARKer<m>:MAXimum:AUTO.....   | 873 |
| CALCulate<n>:MARKer<m>:MAXimum:LEFT.....   | 874 |
| CALCulate<n>:MARKer<m>:MAXimum:NEXT.....   | 874 |
| CALCulate<n>:MARKer<m>:MAXimum[:PEAK]..... | 874 |
| CALCulate<n>:MARKer<m>:MAXimum:RIGHT.....  | 875 |
| CALCulate<n>:MARKer<m>:MINimum:AUTO.....   | 875 |
| CALCulate<n>:MARKer<m>:MINimum:LEFT.....   | 875 |
| CALCulate<n>:MARKer<m>:MINimum:NEXT.....   | 876 |
| CALCulate<n>:MARKer<m>:MINimum[:PEAK]..... | 876 |
| CALCulate<n>:MARKer<m>:MINimum:RIGHT.....  | 876 |

**CALCulate<n>:MARKer<m>:MAXimum:AUTO <State>**

This command turns an automatic marker peak search for a trace maximum on and off. The R&S FPS performs the peak search after each sweep.

**Suffix:**

<n> [Window](#)

<m> [Marker](#)

**Parameters:**

<State> ON | OFF | 1 | 0

\*RST: 0

**Example:** `CALC:MARK:MAX:AUTO ON`  
Activates the automatic peak search function for marker 1 at the end of each particular sweep.

**Manual operation:** See "[Auto Max Peak Search / Auto Min Peak Search](#)" on page 415

---

**CALCulate<n>:MARKer<m>:MAXimum:LEFT**

This command moves a marker to the next lower peak.

The search includes only measurement values to the left of the current marker position.

In the spectrogram, the command moves a marker horizontally to the maximum level in the currently selected frame. The vertical marker position remains the same.

**Suffix:**

<n> [Window](#)

<m> [Marker](#)

**Usage:** Event

**Manual operation:** See "[Search Next Peak](#)" on page 419

---

**CALCulate<n>:MARKer<m>:MAXimum:NEXT**

This command moves a marker to the next lower peak.

In the spectrogram, the command moves a marker horizontally to the maximum level in the currently selected frame. The vertical marker position remains the same.

**Suffix:**

<n> [Window](#)

<m> [Marker](#)

**Usage:** Event

**Manual operation:** See "[Search Next Peak](#)" on page 419

---

**CALCulate<n>:MARKer<m>:MAXimum[:PEAK]**

This command moves a marker to the highest level.

In the spectrogram, the command moves a marker horizontally to the maximum level in the currently selected frame. The vertical marker position remains the same.

If the marker is not yet active, the command first activates the marker.

**Suffix:**

<n> [Window](#)

<m> [Marker](#)

**Usage:** Event

**Manual operation:** See " [Peak Search](#) " on page 419

### **CALCulate<n>:MARKer<m>:MAXimum:RIGHT**

This command moves a marker to the next lower peak.

The search includes only measurement values to the right of the current marker position.

In the spectrogram, the command moves a marker horizontally to the maximum level in the currently selected frame. The vertical marker position remains the same.

**Suffix:**

<n> [Window](#)

<m> [Marker](#)

**Usage:** Event

**Manual operation:** See " [Search Next Peak](#) " on page 419

### **CALCulate<n>:MARKer<m>:MINimum:AUTO <State>**

This command turns an automatic marker peak search for a trace minimum on and off. The R&S FPS performs the peak search after each sweep.

**Suffix:**

<n> [Window](#)

<m> [Marker](#)

**Parameters:**

<State> ON | OFF | 1 | 0

\*RST: 0

**Example:**

`CALC:MARK:MIN:AUTO ON`

Activates the automatic minimum value search function for marker 1 at the end of each particular sweep.

**Manual operation:** See " [Auto Max Peak Search / Auto Min Peak Search](#) " on page 415

### **CALCulate<n>:MARKer<m>:MINimum:LEFT**

This command moves a marker to the next minimum value.

The search includes only measurement values to the right of the current marker position.

In the spectrogram, the command moves a marker horizontally to the minimum level in the currently selected frame. The vertical marker position remains the same.

**Suffix:**

<n> [Window](#)

<m> [Marker](#)

**Usage:** Event

**Manual operation:** See " [Search Next Minimum](#) " on page 420

---

#### **CALCulate<n>:MARKer<m>:MINimum:NEXT**

This command moves a marker to the next minimum value.

In the spectrogram, the command moves a marker horizontally to the minimum level in the currently selected frame. The vertical marker position remains the same.

**Suffix:**

<n> [Window](#)

<m> [Marker](#)

**Usage:** Event

**Manual operation:** See " [Search Next Minimum](#) " on page 420

---

#### **CALCulate<n>:MARKer<m>:MINimum[:PEAK]**

This command moves a marker to the minimum level.

In the spectrogram, the command moves a marker horizontally to the minimum level in the currently selected frame. The vertical marker position remains the same.

If the marker is not yet active, the command first activates the marker.

**Suffix:**

<n> [Window](#)

<m> [Marker](#)

**Usage:** Event

**Manual operation:** See " [Search Minimum](#) " on page 420

---

#### **CALCulate<n>:MARKer<m>:MINimum:RIGHT**

This command moves a marker to the next minimum value.

The search includes only measurement values to the right of the current marker position.

In the spectrogram, the command moves a marker horizontally to the minimum level in the currently selected frame. The vertical marker position remains the same.

**Suffix:**

<n> [Window](#)

<m> [Marker](#)

**Usage:** Event

**Manual operation:** See " [Search Next Minimum](#) " on page 420

## Positioning Delta Markers

The following commands position delta markers on the trace.

|                                                 |     |
|-------------------------------------------------|-----|
| CALCulate<n>:DELTamarker<m>:MAXimum:LEFT.....   | 877 |
| CALCulate<n>:DELTamarker<m>:MAXimum:NEXT.....   | 877 |
| CALCulate<n>:DELTamarker<m>:MAXimum[:PEAK]..... | 877 |
| CALCulate<n>:DELTamarker<m>:MAXimum:RIGHT.....  | 878 |
| CALCulate<n>:DELTamarker<m>:MINimum:LEFT.....   | 878 |
| CALCulate<n>:DELTamarker<m>:MINimum:NEXT.....   | 878 |
| CALCulate<n>:DELTamarker<m>:MINimum[:PEAK]..... | 879 |
| CALCulate<n>:DELTamarker<m>:MINimum:RIGHT.....  | 879 |

---

### CALCulate<n>:DELTamarker<m>:MAXimum:LEFT

This command moves a delta marker to the next higher value.

The search includes only measurement values to the left of the current marker position.

In the spectrogram, the command moves a marker horizontally to the maximum level in the currently selected frame. The vertical marker position remains the same.

#### Suffix:

<n>                      Window

<m>                      Marker

**Usage:**                      Event

**Manual operation:**    See " [Search Next Peak](#) " on page 419

---

### CALCulate<n>:DELTamarker<m>:MAXimum:NEXT

This command moves a marker to the next higher value.

In the spectrogram, the command moves a marker horizontally to the maximum level in the currently selected frame. The vertical marker position remains the same.

#### Suffix:

<n>                      Window

<m>                      Marker

**Usage:**                      Event

**Manual operation:**    See " [Search Next Peak](#) " on page 419

---

### CALCulate<n>:DELTamarker<m>:MAXimum[:PEAK]

This command moves a delta marker to the highest level.

In the spectrogram, the command moves a marker horizontally to the maximum level in the currently selected frame. The vertical marker position remains the same.

If the marker is not yet active, the command first activates the marker.

**Suffix:**<n> [Window](#)<m> [Marker](#)**Usage:** Event**Manual operation:** See "[Peak Search](#)" on page 419

---

**CALCulate<n>:DELTamarker<m>:MAXimum:RIGHT**

This command moves a delta marker to the next higher value.

The search includes only measurement values to the right of the current marker position.

In the spectrogram, the command moves a marker horizontally to the maximum level in the currently selected frame. The vertical marker position remains the same.

**Suffix:**<n> [Window](#)<m> [Marker](#)**Usage:** Event**Manual operation:** See "[Search Next Peak](#)" on page 419

---

**CALCulate<n>:DELTamarker<m>:MINimum:LEFT**

This command moves a delta marker to the next higher minimum value.

The search includes only measurement values to the right of the current marker position.

In the spectrogram, the command moves a marker horizontally to the minimum level in the currently selected frame. The vertical marker position remains the same.

**Suffix:**<n> [Window](#)<m> [Marker](#)**Usage:** Event**Manual operation:** See "[Search Next Minimum](#)" on page 420

---

**CALCulate<n>:DELTamarker<m>:MINimum:NEXT**

This command moves a marker to the next higher minimum value.

In the spectrogram, the command moves a marker horizontally to the minimum level in the currently selected frame. The vertical marker position remains the same.

**Suffix:**<n> [Window](#)

<m> [Marker](#)

**Usage:** Event

**Manual operation:** See "[Search Next Minimum](#)" on page 420

#### **CALCulate<n>:DELTaMarker<m>:MINimum[:PEAK]**

This command moves a delta marker to the minimum level.

In the spectrogram, the command moves a marker horizontally to the minimum level in the currently selected frame. The vertical marker position remains the same.

If the marker is not yet active, the command first activates the marker.

**Suffix:**

<n> [Window](#)

<m> [Marker](#)

**Usage:** Event

**Manual operation:** See "[Search Minimum](#)" on page 420

#### **CALCulate<n>:DELTaMarker<m>:MINimum:RIGHT**

This command moves a delta marker to the next higher minimum value.

The search includes only measurement values to the right of the current marker position.

In the spectrogram, the command moves a marker horizontally to the minimum level in the currently selected frame. The vertical marker position remains the same.

**Suffix:**

<n> [Window](#)

<m> [Marker](#)

**Usage:** Event

**Manual operation:** See "[Search Next Minimum](#)" on page 420

### 12.8.3.5 Retrieving Marker Results

The following commands are used to retrieve the results of markers.



You can use the marker values to position the center frequency or reference level directly using the following commands:

- [CALCulate<n>:MARKer<m>:FUNction:CENTer](#) on page 776
- [CALCulate<n>:MARKer<m>:FUNction:REFerence](#) on page 792

Useful commands for retrieving results described elsewhere:

- [CALCulate<n>:DELTaMarker<m>:X](#) on page 865
- [CALCulate<n>:MARKer<m>:X](#) on page 867
- [CALCulate<n>:MARKer<m>:FUNction:FPEaks:COUNT?](#) on page 895
- [CALCulate<n>:MARKer<m>:FUNction:FPEaks:X?](#) on page 897
- [CALCulate<n>:MARKer<m>:FUNction:FPEaks:Y?](#) on page 897
- [CALCulate<n>:MARKer<m>:FUNction:NOISE:RESult?](#) on page 897
- [CALCulate<n>:DELTaMarker<m>:FUNction:PNOise:RESult?](#) on page 899
- [CALCulate<n>:DELTaMarker<m>:FUNction:BPOWer:RESult?](#) on page 903
- [CALCulate<n>:MARKer<m>:FUNction:BPOWer:RESult?](#) on page 902
- [CALCulate<n>:MARKer<m>:FUNction:NDBDown:RESult?](#) on page 906
- [CALCulate<n>:MARKer<m>:FUNction:NDBDown:FREQuency?](#) on page 905
- [CALCulate<n>:MARKer<m>:FUNction:NDBDown:QFACTOR?](#) on page 906
- [CALCulate<n>:MARKer<m>:COUNT:FREQuency?](#) on page 909

#### Remote commands exclusive to retrieving marker results

|                                                                           |     |
|---------------------------------------------------------------------------|-----|
| <a href="#">CALCulate&lt;n&gt;:DELTaMarker&lt;m&gt;:X:RELative?</a> ..... | 880 |
| <a href="#">CALCulate&lt;n&gt;:DELTaMarker&lt;m&gt;:Y?</a> .....          | 880 |
| <a href="#">CALCulate&lt;n&gt;:MARKer&lt;m&gt;:Y?</a> .....               | 881 |

---

#### CALCulate<n>:DELTaMarker<m>:X:RELative?

This command queries the relative position of a delta marker on the x-axis.

If necessary, the command activates the delta marker first.

##### Suffix:

<n>                      [Window](#)

<m>                      [Marker](#)

##### Return values:

<Position>              Position of the delta marker in relation to the reference marker.

##### Example:

`CALC:DELT3:X:REL?`

Outputs the frequency of delta marker 3 relative to marker 1 or relative to the reference position.

##### Usage:

Query only

##### Manual operation:

See " [Marker 1 / Marker 2 / Marker 3 / Marker 4](#) " on page 293

See " [Marker 1 / Marker 2 / Marker 3](#) " on page 297

---

#### CALCulate<n>:DELTaMarker<m>:Y?

This command queries the relative position of a delta marker on the y-axis.



If necessary, the command activates the delta marker first.

To get a valid result, you have to perform a complete measurement with synchronization to the end of the measurement before reading out the result. This is only possible for single sweep mode.

See also [INITiate<n>:CONTinuous](#) on page 635.

The unit depends on the application of the command.

**Table 12-9: Base unit**

| Parameter, measuring function or result display | Output unit          |
|-------------------------------------------------|----------------------|
| DBM   DBPW   DBUV   DBMV   DBUA                 | dB (lin/log)         |
| WATT   VOLT   AMPere                            | dB (lin), % (log)    |
| statistics function (APD or CCDF) on            | dimensionless output |

**Suffix:**

<m>                    [Marker](#)

<n>                    [Window](#)

**Return values:**

<Result>            Result at the position of the delta marker.  
The unit is variable and depends on the one you have currently set.

**Example:**

```
INIT:CONT OFF
Switches to single sweep mode.
INIT;*WAI
Starts a sweep and waits for its end.
CALC:DELT2 ON
Switches on delta marker 2.
CALC:DELT2:Y?
Outputs measurement value of delta marker 2.
```

**Usage:**            Query only

**CALCulate<n>:MARKer<m>:Y?**

This command queries the position of a marker on the y-axis.

If necessary, the command activates the marker first.

To get a valid result, you have to perform a complete measurement with synchronization to the end of the measurement before reading out the result. This is only possible for single sweep mode.

See also [INITiate<n>:CONTinuous](#) on page 635.

**Suffix:**

<n>                    [Window](#)

<m>                    [Marker](#)

**Return values:**

<Result> Result at the marker position.  
The unit is variable and depends on the one you have currently set.

**Example:**

```
INIT:CONT OFF
Switches to single measurement mode.
CALC:MARK2 ON
Switches marker 2.
INIT;*WAI
Starts a measurement and waits for the end.
CALC:MARK2:Y?
Outputs the measured value of marker 2.
```

**Usage:** Query only

**Manual operation:** See " [Marker Table](#) " on page 394  
See " [Marker Peak List](#) " on page 394

**12.8.3.6 Marker Search (Spectrograms)**

The following commands automatically define the marker and delta marker position in the spectrogram.



The usage of these markers is demonstrated in [Chapter 12.8.2.7, "Programming Example: Configuring a Spectrogram"](#), on page 859.

**Using Markers**

The following commands control spectrogram markers.

**Useful commands for spectrogram markers described elsewhere**

The following commands define the horizontal position of the markers.

- [CALCulate<n>:MARKer<m>:MAXimum:LEFT](#) on page 874
- [CALCulate<n>:MARKer<m>:MAXimum:NEXT](#) on page 874
- [CALCulate<n>:MARKer<m>:MAXimum\[:PEAK\]](#) on page 874
- [CALCulate<n>:MARKer<m>:MAXimum:RIGHT](#) on page 875
- [CALCulate<n>:MARKer<m>:MINimum:LEFT](#) on page 875
- [CALCulate<n>:MARKer<m>:MINimum:NEXT](#) on page 876
- [CALCulate<n>:MARKer<m>:MINimum\[:PEAK\]](#) on page 876
- [CALCulate<n>:MARKer<m>:MINimum:RIGHT](#) on page 876

**Remote commands exclusive to spectrogram markers**

|                                                                            |     |
|----------------------------------------------------------------------------|-----|
| <a href="#">CALCulate&lt;n&gt;:MARKer&lt;m&gt;:SGRam:FRAME</a> .....       | 883 |
| <a href="#">CALCulate&lt;n&gt;:MARKer&lt;m&gt;:SPEctrogram:FRAME</a> ..... | 883 |
| <a href="#">CALCulate&lt;n&gt;:MARKer&lt;m&gt;:SGRam:SARea</a> .....       | 883 |

|                                                           |     |
|-----------------------------------------------------------|-----|
| CALCulate<n>:MARKer<m>:SPECtrogram:SARea.....             | 883 |
| CALCulate<n>:MARKer<m>:SGRam:XY:MAXimum[:PEAK].....       | 884 |
| CALCulate<n>:MARKer<m>:SPECtrogram:XY:MAXimum[:PEAK]..... | 884 |
| CALCulate<n>:MARKer<m>:SGRam:XY:MINimum[:PEAK].....       | 884 |
| CALCulate<n>:MARKer<m>:SPECtrogram:XY:MINimum[:PEAK]..... | 884 |
| CALCulate<n>:MARKer<m>:SGRam:Y:MAXimum:ABOVE.....         | 884 |
| CALCulate<n>:MARKer<m>:SPECtrogram:Y:MAXimum:ABOVE.....   | 884 |
| CALCulate<n>:MARKer<m>:SGRam:Y:MAXimum:BELOW.....         | 885 |
| CALCulate<n>:MARKer<m>:SPECtrogram:Y:MAXimum:BELOW.....   | 885 |
| CALCulate<n>:MARKer<m>:SGRam:Y:MAXimum:NEXT.....          | 885 |
| CALCulate<n>:MARKer<m>:SPECtrogram:Y:MAXimum:NEXT.....    | 885 |
| CALCulate<n>:MARKer<m>:SGRam:Y:MAXimum[:PEAK].....        | 885 |
| CALCulate<n>:MARKer<m>:SPECtrogram:Y:MAXimum[:PEAK].....  | 885 |
| CALCulate<n>:MARKer<m>:SGRam:Y:MINimum:ABOVE.....         | 886 |
| CALCulate<n>:MARKer<m>:SPECtrogram:Y:MINimum:ABOVE.....   | 886 |
| CALCulate<n>:MARKer<m>:SGRam:Y:MINimum:BELOW.....         | 886 |
| CALCulate<n>:MARKer<m>:SPECtrogram:Y:MINimum:BELOW.....   | 886 |
| CALCulate<n>:MARKer<m>:SGRam:Y:MINimum:NEXT.....          | 886 |
| CALCulate<n>:MARKer<m>:SPECtrogram:Y:MINimum:NEXT.....    | 886 |
| CALCulate<n>:MARKer<m>:SGRam:Y:MINimum[:PEAK].....        | 887 |
| CALCulate<n>:MARKer<m>:SPECtrogram:Y:MINimum[:PEAK].....  | 887 |

---

**CALCulate<n>:MARKer<m>:SGRam:FRAME <Frame> | <Time>**

**CALCulate<n>:MARKer<m>:SPECtrogram:FRAME <Frame> | <Time>**

This command positions a marker on a particular frame.

**Suffix:**

<n>                      Window

<m>                      Marker

**Parameters:**

<Frame>                Selects a frame directly by the frame number. Valid if the time stamp is off.  
The range depends on the history depth.

<Time>                 Selects a frame via its time stamp. Valid if the time stamp is on.  
The number is the (negative) distance to frame 0 in seconds.  
The range depends on the history depth.

**Example:**

CALC:MARK:SGR:FRAM -20

Sets the marker on the 20th frame before the present.

CALC:MARK2:SGR:FRAM -2s

Sets second marker on the frame 2 seconds ago.

**Manual operation:** See " [Frame \(Spectrogram only\)](#)" on page 409

---

**CALCulate<n>:MARKer<m>:SGRam:SARea <SearchArea>**

**CALCulate<n>:MARKer<m>:SPECtrogram:SARea <SearchArea>**

This command defines the marker search area for all spectrogram markers in the channel.

**Suffix:**

<n>, <m>                      irrelevant

**Parameters:**

<SearchArea>

**VISible**

Performs a search within the visible frames.

Note that the command does not work if the spectrogram is not visible for any reason (e.g. if the display update is off).

**MEMory**

Performs a search within all frames in the memory.

\*RST:            VISible

**Manual operation:**    See " [Marker Search Area](#) " on page 418

**CALCulate<n>:MARKer<m>:SGRam:XY:MAXimum[:PEAK]**

**CALCulate<n>:MARKer<m>:SPECTrogram:XY:MAXimum[:PEAK]**

This command moves a marker to the highest level of the spectrogram.

**Suffix:**

<n>                                [Window](#)

<m>                                [Marker](#)

**Usage:**                        Event

**CALCulate<n>:MARKer<m>:SGRam:XY:MINimum[:PEAK]**

**CALCulate<n>:MARKer<m>:SPECTrogram:XY:MINimum[:PEAK]**

This command moves a marker to the minimum level of the spectrogram.

**Suffix:**

<n>                                [Window](#)

<m>                                [Marker](#)

**Usage:**                        Event

**CALCulate<n>:MARKer<m>:SGRam:Y:MAXimum:ABOVE**

**CALCulate<n>:MARKer<m>:SPECTrogram:Y:MAXimum:ABOVE**

This command moves a marker vertically to the next lower peak level for the current frequency.

The search includes only frames above the current marker position. It does not change the horizontal position of the marker.

**Suffix:**

<n>                                [Window](#)

<m>                                [Marker](#)

**Usage:**                        Event

**Manual operation:**    See " [Search Mode for Next Peak in Y-Direction](#) " on page 417

---

**CALCulate<n>:MARKer<m>:SGRam:Y:MAXimum:BELOW****CALCulate<n>:MARKer<m>:SPECTrogram:Y:MAXimum:BELOW**

This command moves a marker vertically to the next lower peak level for the current frequency.

The search includes only frames below the current marker position. It does not change the horizontal position of the marker.

**Suffix:**

<n> [Window](#)

<m> [Marker](#)

**Usage:** Event

**Manual operation:** See "[Search Mode for Next Peak in Y-Direction](#)" on page 417

---

**CALCulate<n>:MARKer<m>:SGRam:Y:MAXimum:NEXT****CALCulate<n>:MARKer<m>:SPECTrogram:Y:MAXimum:NEXT**

This command moves a marker vertically to the next lower peak level for the current frequency.

The search includes all frames. It does not change the horizontal position of the marker.

**Suffix:**

<n> [Window](#)

<m> [Marker](#)

**Usage:** Event

**Manual operation:** See "[Search Mode for Next Peak in Y-Direction](#)" on page 417

---

**CALCulate<n>:MARKer<m>:SGRam:Y:MAXimum[:PEAK]****CALCulate<n>:MARKer<m>:SPECTrogram:Y:MAXimum[:PEAK]**

This command moves a marker vertically to the highest level for the current frequency.

The search includes all frames. It does not change the horizontal position of the marker.

If the marker hasn't been active yet, the command looks for the peak level in the whole spectrogram.

**Suffix:**

<n> [Window](#)

<m> [Marker](#)

**Usage:** Event

---

**CALCulate<n>:MARKer<m>:SGRam:Y:MINimum:ABOVE****CALCulate<n>:MARKer<m>:SPECTrogram:Y:MINimum:ABOVE**

This command moves a marker vertically to the next higher minimum level for the current frequency.

The search includes only frames above the current marker position. It does not change the horizontal position of the marker.

**Suffix:**

<n> [Window](#)

<m> [Marker](#)

**Usage:** Event

**Manual operation:** See "[Search Mode for Next Peak in Y-Direction](#)" on page 417

---

**CALCulate<n>:MARKer<m>:SGRam:Y:MINimum:BELOW****CALCulate<n>:MARKer<m>:SPECTrogram:Y:MINimum:BELOW**

This command moves a marker vertically to the next higher minimum level for the current frequency.

The search includes only frames below the current marker position. It does not change the horizontal position of the marker.

**Suffix:**

<n> [Window](#)

<m> [Marker](#)

**Usage:** Event

**Manual operation:** See "[Search Mode for Next Peak in Y-Direction](#)" on page 417

---

**CALCulate<n>:MARKer<m>:SGRam:Y:MINimum:NEXT****CALCulate<n>:MARKer<m>:SPECTrogram:Y:MINimum:NEXT**

This command moves a marker vertically to the next higher minimum level for the current frequency.

The search includes all frames. It does not change the horizontal position of the marker.

**Suffix:**

<n> [Window](#)

<m> [Marker](#)

**Usage:** Event

**Manual operation:** See "[Search Mode for Next Peak in Y-Direction](#)" on page 417

**CALCulate<n>:MARKer<m>:SGRam:Y:MINimum[:PEAK]****CALCulate<n>:MARKer<m>:SPECTrogram:Y:MINimum[:PEAK]**

This command moves a marker vertically to the minimum level for the current frequency.

The search includes all frames. It does not change the horizontal position of the marker.

If the marker hasn't been active yet, the command first looks for the peak level for all frequencies and moves the marker vertically to the minimum level.

**Suffix:**

<n> [Window](#)

<m> [Marker](#)

**Usage:** [Event](#)

**Using Delta Markers**

The following commands control spectrogram delta markers.

**Useful commands for spectrogram markers described elsewhere**

The following commands define the horizontal position of the delta markers.

- [CALCulate<n>:DELTaMarker<m>:MAXimum:LEFT](#) on page 877
- [CALCulate<n>:DELTaMarker<m>:MAXimum:NEXT](#) on page 877
- [CALCulate<n>:DELTaMarker<m>:MAXimum\[:PEAK\]](#) on page 877
- [CALCulate<n>:DELTaMarker<m>:MAXimum:RIGHT](#) on page 878
- [CALCulate<n>:DELTaMarker<m>:MINimum:LEFT](#) on page 878
- [CALCulate<n>:DELTaMarker<m>:MINimum:NEXT](#) on page 878
- [CALCulate<n>:DELTaMarker<m>:MINimum\[:PEAK\]](#) on page 879
- [CALCulate<n>:DELTaMarker<m>:MINimum:RIGHT](#) on page 879

**Remote commands exclusive to spectrogram markers**

|                                                                                             |     |
|---------------------------------------------------------------------------------------------|-----|
| <a href="#">CALCulate&lt;n&gt;:DELTaMarker&lt;m&gt;:SGRam:FRAMe</a> .....                   | 888 |
| <a href="#">CALCulate&lt;n&gt;:DELTaMarker&lt;m&gt;:SPECTrogram:FRAMe</a> .....             | 888 |
| <a href="#">CALCulate&lt;n&gt;:DELTaMarker&lt;m&gt;:SGRam:SARea</a> .....                   | 888 |
| <a href="#">CALCulate&lt;n&gt;:DELTaMarker&lt;m&gt;:SPECTrogram:SARea</a> .....             | 888 |
| <a href="#">CALCulate&lt;n&gt;:DELTaMarker&lt;m&gt;:SGRam:XY:MAXimum[:PEAK]</a> .....       | 889 |
| <a href="#">CALCulate&lt;n&gt;:DELTaMarker&lt;m&gt;:SPECTrogram:XY:MAXimum[:PEAK]</a> ..... | 889 |
| <a href="#">CALCulate&lt;n&gt;:DELTaMarker&lt;m&gt;:SGRam:XY:MINimum[:PEAK]</a> .....       | 889 |
| <a href="#">CALCulate&lt;n&gt;:DELTaMarker&lt;m&gt;:SPECTrogram:XY:MINimum[:PEAK]</a> ..... | 889 |
| <a href="#">CALCulate&lt;n&gt;:DELTaMarker&lt;m&gt;:SGRam:Y:MAXimum:ABOVe</a> .....         | 889 |
| <a href="#">CALCulate&lt;n&gt;:DELTaMarker&lt;m&gt;:SPECTrogram:Y:MAXimum:ABOVe</a> .....   | 889 |
| <a href="#">CALCulate&lt;n&gt;:DELTaMarker&lt;m&gt;:SGRam:Y:MAXimum:BELow</a> .....         | 890 |
| <a href="#">CALCulate&lt;n&gt;:DELTaMarker&lt;m&gt;:SPECTrogram:Y:MAXimum:BELow</a> .....   | 890 |
| <a href="#">CALCulate&lt;n&gt;:DELTaMarker&lt;m&gt;:SGRam:Y:MAXimum:NEXT</a> .....          | 890 |
| <a href="#">CALCulate&lt;n&gt;:DELTaMarker&lt;m&gt;:SPECTrogram:Y:MAXimum:NEXT</a> .....    | 890 |

|                                                               |     |
|---------------------------------------------------------------|-----|
| CALCulate<n>:DELTamarker<m>:SGRam:Y:MAXimum[:PEAK].....       | 890 |
| CALCulate<n>:DELTamarker<m>:SPECTrogram:Y:MAXimum[:PEAK]..... | 890 |
| CALCulate<n>:DELTamarker<m>:SGRam:Y:MINimum:ABOVe.....        | 891 |
| CALCulate<n>:DELTamarker<m>:SPECTrogram:Y:MINimum:ABOVe.....  | 891 |
| CALCulate<n>:DELTamarker<m>:SGRam:Y:MINimum:BELow.....        | 891 |
| CALCulate<n>:DELTamarker<m>:SPECTrogram:Y:MINimum:BELow.....  | 891 |
| CALCulate<n>:DELTamarker<m>:SGRam:Y:MINimum:NEXT.....         | 891 |
| CALCulate<n>:DELTamarker<m>:SPECTrogram:Y:MINimum:NEXT.....   | 891 |
| CALCulate<n>:DELTamarker<m>:SGRam:Y:MINimum[:PEAK].....       | 892 |
| CALCulate<n>:DELTamarker<m>:SPECTrogram:Y:MINimum[:PEAK]..... | 892 |

---

**CALCulate<n>:DELTamarker<m>:SGRam:FRAMe <Frame> | <Time>**

**CALCulate<n>:DELTamarker<m>:SPECTrogram:FRAMe <Frame> | <Time>**

This command positions a delta marker on a particular frame. The frame is relative to the position of marker 1.

The command is available for the spectrogram.

**Suffix:**

<n>                      Window

<m>                      Marker

**Parameters:**

<Frame>                Selects a frame directly by the frame number. Valid if the time stamp is off.

The range depends on the history depth.

<Time>                 Selects a frame via its time stamp. Valid if the time stamp is on.  
The number is the distance to frame 0 in seconds. The range depends on the history depth.

**Example:**

CALC:DELT4:SGR:FRAM -20

Sets fourth deltamarker 20 frames below marker 1.

CALC:DELT4:SGR:FRAM 2 s

Sets fourth deltamarker 2 seconds above the position of marker 1.

**Manual operation:** See "[Frame \(Spectrogram only\)](#)" on page 409

---

**CALCulate<n>:DELTamarker<m>:SGRam:SARea <SearchArea>**

**CALCulate<n>:DELTamarker<m>:SPECTrogram:SARea <SearchArea>**

This command defines the marker search area for *all* spectrogram markers in the channel.

**Suffix:**

<n>, <m>                irrelevant



**Parameters:**

&lt;SearchArea&gt;

**VISible**

Performs a search within the visible frames.

Note that the command does not work if the spectrogram is not visible for any reason (e.g. if the display update is off).

**MEMory**

Performs a search within all frames in the memory.

\*RST: VISible

**Manual operation:** See "[Marker Search Area](#)" on page 418**CALCulate<n>:DELTamarker<m>:SGRam:XY:MAXimum[:PEAK]****CALCulate<n>:DELTamarker<m>:SPECTrogram:XY:MAXimum[:PEAK]**

This command moves a marker to the highest level of the spectrogram over all frequencies.

**Suffix:**<n> [Window](#)<m> [Marker](#)**Usage:** Event**CALCulate<n>:DELTamarker<m>:SGRam:XY:MINimum[:PEAK]****CALCulate<n>:DELTamarker<m>:SPECTrogram:XY:MINimum[:PEAK]**

This command moves a delta marker to the minimum level of the spectrogram over all frequencies.

**Suffix:**<n> [Window](#)<m> [Marker](#)**Usage:** Event**CALCulate<n>:DELTamarker<m>:SGRam:Y:MAXimum:ABOVE****CALCulate<n>:DELTamarker<m>:SPECTrogram:Y:MAXimum:ABOVE**

This command moves a marker vertically to the next higher level for the current frequency.

The search includes only frames above the current marker position. It does not change the horizontal position of the marker.

**Suffix:**<n> [Window](#)<m> [Marker](#)**Usage:** Event**Manual operation:** See "[Search Mode for Next Peak in Y-Direction](#)" on page 417

---

**CALCulate<n>:DELTaMarker<m>:SGRam:Y:MAXimum:BELOW**  
**CALCulate<n>:DELTaMarker<m>:SPECTrogram:Y:MAXimum:BELOW**

This command moves a marker vertically to the next higher level for the current frequency.

The search includes only frames below the current marker position. It does not change the horizontal position of the marker.

**Suffix:**

<n> [Window](#)

<m> [Marker](#)

**Usage:** Event

**Manual operation:** See "[Search Mode for Next Peak in Y-Direction](#)" on page 417

---

**CALCulate<n>:DELTaMarker<m>:SGRam:Y:MAXimum:NEXT**  
**CALCulate<n>:DELTaMarker<m>:SPECTrogram:Y:MAXimum:NEXT**

This command moves a delta marker vertically to the next higher level for the current frequency.

The search includes all frames. It does not change the horizontal position of the marker.

**Suffix:**

<n> [Window](#)

<m> [Marker](#)

**Usage:** Event

**Manual operation:** See "[Search Mode for Next Peak in Y-Direction](#)" on page 417

---

**CALCulate<n>:DELTaMarker<m>:SGRam:Y:MAXimum[:PEAK]**  
**CALCulate<n>:DELTaMarker<m>:SPECTrogram:Y:MAXimum[:PEAK]**

This command moves a delta marker vertically to the highest level for the current frequency.

The search includes all frames. It does not change the horizontal position of the marker.

If the marker hasn't been active yet, the command looks for the peak level in the whole spectrogram.

**Suffix:**

<n> [Window](#)

<m> [Marker](#)

**Usage:** Event

---

**CALCulate<n>:DELTaMarker<m>:SGRam:Y:MINimum:ABOVE****CALCulate<n>:DELTaMarker<m>:SPECTrogram:Y:MINimum:ABOVE**

This command moves a delta marker vertically to the next minimum level for the current frequency.

The search includes only frames above the current marker position. It does not change the horizontal position of the marker.

**Suffix:**

<n> [Window](#)

<m> [Marker](#)

**Usage:** Event

**Manual operation:** See "[Search Mode for Next Peak in Y-Direction](#)" on page 417

---

**CALCulate<n>:DELTaMarker<m>:SGRam:Y:MINimum:BELOW****CALCulate<n>:DELTaMarker<m>:SPECTrogram:Y:MINimum:BELOW**

This command moves a delta marker vertically to the next minimum level for the current frequency.

The search includes only frames below the current marker position. It does not change the horizontal position of the marker.

**Suffix:**

<n> [Window](#)

<m> [Marker](#)

**Usage:** Event

**Manual operation:** See "[Search Mode for Next Peak in Y-Direction](#)" on page 417

---

**CALCulate<n>:DELTaMarker<m>:SGRam:Y:MINimum:NEXT****CALCulate<n>:DELTaMarker<m>:SPECTrogram:Y:MINimum:NEXT**

This command moves a delta marker vertically to the next minimum level for the current frequency.

The search includes all frames. It does not change the horizontal position of the marker.

**Suffix:**

<n> [Window](#)

<m> [Marker](#)

**Usage:** Event

**Manual operation:** See "[Search Mode for Next Peak in Y-Direction](#)" on page 417

**CALCulate<n>:DELTaMarker<m>:SGRam:Y:MINimum[:PEAK]****CALCulate<n>:DELTaMarker<m>:SPECTrogram:Y:MINimum[:PEAK]**

This command moves a delta marker vertically to the minimum level for the current frequency.

The search includes all frames. It does not change the horizontal position of the marker.

If the marker hasn't been active yet, the command first looks for the peak level in the whole spectrogram and moves the marker vertically to the minimum level.

**Suffix:**

<n> [Window](#)

<m> [Marker](#)

**Usage:** Event

**12.8.3.7 Fixed Reference Marker Settings**

The following commands configure a fixed reference marker.

[CALCulate<n>:DELTaMarker<m>:FUNCTION:FIXed:RPOint:MAXimum\[:PEAK\]](#)..... 892

[CALCulate<n>:DELTaMarker<m>:FUNCTION:FIXed:RPOint:X](#)..... 892

[CALCulate<n>:DELTaMarker<m>:FUNCTION:FIXed:RPOint:Y](#)..... 893

[CALCulate<n>:DELTaMarker<m>:FUNCTION:FIXed:RPOint:Y:OFFSet](#)..... 893

[CALCulate<n>:DELTaMarker<m>:FUNCTION:FIXed\[:STATe\]](#)..... 893

**CALCulate<n>:DELTaMarker<m>:FUNCTION:FIXed:RPOint:MAXimum[:PEAK]**

This command moves the fixed reference marker to the peak power.

**Suffix:**

<n> [Window](#)

<m> [Marker](#)

**Example:**

`CALC:DELT:FUNC:FIX:RPO:MAX`

Sets the reference point level for delta markers to the peak of the selected trace.

**Usage:** Event

**Manual operation:** See "[Defining a Fixed Reference](#)" on page 412  
See "[Defining Reference Point](#)" on page 427

**CALCulate<n>:DELTaMarker<m>:FUNCTION:FIXed:RPOint:X <RefPoint>**

This command defines the horizontal position of the fixed delta marker reference point. The coordinates of the reference may be anywhere in the diagram.

**Suffix:**

<n> [Window](#)

<m> [Marker](#)

**Parameters:**

<RefPoint> Numeric value that defines the horizontal position of the reference.  
 For frequency domain measurements, it is a frequency in Hz.  
 For time domain measurements, it is a point in time in s.  
 \*RST: Fixed Reference: OFF

**Example:**

CALC:DELT:FUNC:FIX:RPO:X 128 MHz  
 Sets the frequency reference to 128 MHz.

**Manual operation:** See "Defining a Fixed Reference" on page 412  
 See "Defining Reference Point" on page 427

**CALCulate<n>:DELTaMarker<m>:FUNCTION:FIXed:RPOint:Y <RefPointLevel>**

This command defines the vertical position of the fixed delta marker reference point. The coordinates of the reference may be anywhere in the diagram.

**Suffix:**

<n> [Window](#)

<m> [Marker](#)

**Parameters:**

<RefPoint> Numeric value that defines the vertical position of the reference. The unit and value range is variable.  
 \*RST: Fixed Reference: OFF

**Example:**

CALC:DELT:FUNC:FIX:RPO:Y -10dBm  
 Sets the reference point level for delta markers to -10 dBm.

**Manual operation:** See "Defining a Fixed Reference" on page 412  
 See "Defining Reference Point" on page 427

**CALCulate<n>:DELTaMarker<m>:FUNCTION:FIXed:RPOint:Y:OFFSet <Offset>**

This command defines a level offset for the fixed delta marker reference point.

**Suffix:**

<n> [Window](#)

<m> [Marker](#)

**Parameters:**

<Offset> Numeric value  
 \*RST: 0  
 Default unit: dB

**CALCulate<n>:DELTaMarker<m>:FUNCTION:FIXed[:STATe] <State>**

This command activates or deactivates a marker that defines a fixed reference point for relative marker analysis.

If necessary, the command activates a marker and positions it on the peak power.

Subsequently, you can change the coordinates of the fixed reference independent of the marker. The fixed reference is independent of the trace and is applied to all active delta markers.

**Suffix:**

<n> [Window](#)

<m> [Marker](#)

**Parameters:**

<State> ON | OFF | 1 | 0

\*RST: 0

**Example:**

CALC:DELT:FUNC:FIX ON

Switches on the measurement with fixed reference value for all delta markers.

CALC:DELT:FUNC:FIX:RPO:X 128 MHZ

Sets the frequency reference to 128 MHz.

CALC:DELT:FUNC:FIX:RPO:Y 30 DBM

Sets the reference level to +30 dBm.

**Manual operation:** See ["Defining a Fixed Reference"](#) on page 412

### 12.8.3.8 Marker Peak Lists

**Useful commands for peak lists described elsewhere**

- [CALCulate<n>:MARKer<m>:PEXCursion](#) on page 870
- [MMEMoRY:STORe<n>:PEAK](#) on page 964
- [Chapter 12.8.3.3, "Configuring and Performing a Marker Search"](#), on page 869

**Remote commands exclusive to peak lists**

|                                                                                                    |     |
|----------------------------------------------------------------------------------------------------|-----|
| <a href="#">CALCulate&lt;n&gt;:MARKer&lt;m&gt;:FUNctio:n:FPEaks:ANNotation:LABel[:STATe]</a> ..... | 894 |
| <a href="#">CALCulate&lt;n&gt;:MARKer&lt;m&gt;:FUNctio:n:FPEaks:COUNT?</a> .....                   | 895 |
| <a href="#">CALCulate&lt;n&gt;:MARKer&lt;m&gt;:FUNctio:n:FPEaks[:IMMediate]</a> .....              | 895 |
| <a href="#">CALCulate&lt;n&gt;:MARKer&lt;m&gt;:FUNctio:n:FPEaks:LIST:SIZE</a> .....                | 896 |
| <a href="#">CALCulate&lt;n&gt;:MARKer&lt;m&gt;:FUNctio:n:FPEaks:SORT</a> .....                     | 896 |
| <a href="#">CALCulate&lt;n&gt;:MARKer&lt;m&gt;:FUNctio:n:FPEaks:STATe</a> .....                    | 896 |
| <a href="#">CALCulate&lt;n&gt;:MARKer&lt;m&gt;:FUNctio:n:FPEaks:X?</a> .....                       | 897 |
| <a href="#">CALCulate&lt;n&gt;:MARKer&lt;m&gt;:FUNctio:n:FPEaks:Y?</a> .....                       | 897 |

**CALCulate<n>:MARKer<m>:FUNctio:n:FPEaks:ANNotation:LABel[:STATe]**  
<State>

This command turns labels for peaks found during a peak search on and off.

The labels correspond to the marker number in the marker peak list.

**Suffix:**<n> [Window](#)<m> [Marker](#)**Parameters:**

&lt;State&gt; ON | OFF | 0 | 1

\*RST: 1

**Example:**

CALC:MARK:FUNC:FPE:ANN:LAB:STAT OFF

Removes the peak labels from the diagram

**Manual operation:** See "[Display Marker Numbers](#)" on page 437**CALCulate<n>:MARKer<m>:FUNCtion:FPEaks:COUNT?**

This command queries the number of peaks that have been found during a peak search.

The actual number of peaks that have been found may differ from the number of peaks you have set to be found because of the peak excursion.

**Suffix:**

&lt;n&gt;, &lt;m&gt; irrelevant

**Return values:**

&lt;NumberOfPeaks&gt;

**Example:**

CALC:MARK:FUNC:FPE:COUN?

Queries the number of peaks.

**Usage:**

Query only

**CALCulate<n>:MARKer<m>:FUNCtion:FPEaks[:IMMEDIATE] <Peaks>**

This command initiates a peak search.

**Suffix:**<n> [Window](#)<m> [Marker](#)**Parameters:**

<Peaks> This parameter defines the number of peaks to find during the search.

Note that the actual number of peaks found during the search also depends on the peak excursion you have set with

[CALCulate<n>:MARKer<m>:PEXCursion](#).

Range: 1 to 200

**Example:**

CALC:MARK:PEXC 5

Defines a peak excursion of 5 dB, i.e. peaks must be at least 5 dB apart to be detected as a peak.

CALC:MARK:FUNC:FPE 10

Initiates a search for 10 peaks on the current trace.

**CALCulate<n>:MARKer<m>:FUNCTION:FPEaks:LIST:SIZE <MaxNoPeaks>**

This command defines the maximum number of peaks that the R&S FPS looks for during a peak search.

**Suffix:**

<n> [Window](#)

<m> [Marker](#)

**Parameters:**

<MaxNoPeaks> Maximum number of peaks to be determined.

Range: 1 to 200

\*RST: 50

**Example:**

CALC:MARK:FUNC:FPE:LIST:SIZE 10

The marker peak list will contain a maximum of 10 peaks.

**Manual operation:** See "[Maximum Number of Peaks](#)" on page 437

**CALCulate<n>:MARKer<m>:FUNCTION:FPEaks:SORT <SortMode>**

This command selects the order in which the results of a peak search are returned.

**Suffix:**

<n> [Window](#)

<m> [Marker](#)

**Parameters:**

<SortMode> **X**

Sorts the peaks according to increasing position on the x-axis.

**Y**

Sorts the peaks according to decreasing position on the y-axis.

\*RST: X

**Example:**

CALC:MARK:FUNC:FPE:SORT Y

Sets the sort mode to decreasing y values

**Manual operation:** See "[Sort Mode](#)" on page 437

**CALCulate<n>:MARKer<m>:FUNCTION:FPEaks:STATe <State>**

This command turns a peak search on and off.

**Suffix:**

<n> [Window](#)

<m> [Marker](#)

**Parameters:**

<State> ON | OFF | 1 | 0

\*RST: 0



**Example:** `CALC:MARK:FUNC:FPE:STAT ON`  
Activates marker peak search

**Manual operation:** See " [Peak List State](#) " on page 437

#### **CALCulate<n>:MARKer<m>:FUNction:FPEaks:X?**

This command queries the position of the peaks on the x-axis.

The order depends on the sort order that has been set with `CALCulate<n>:MARKer<m>:FUNction:FPEaks:SORT`.

**Suffix:**  
<n>, <m>                    irrelevant

**Return values:**  
<PeakPosition>            Position of the peaks on the x-axis. The unit depends on the measurement.

**Usage:**                    Query only

#### **CALCulate<n>:MARKer<m>:FUNction:FPEaks:Y?**

This command queries the position of the peaks on the y-axis.

The order depends on the sort order that has been set with `CALCulate<n>:MARKer<m>:FUNction:FPEaks:SORT`.

**Suffix:**  
<n>, <m>                    irrelevant

**Return values:**  
<PeakPosition>            Position of the peaks on the y-axis. The unit depends on the measurement.

**Usage:**                    Query only

### **12.8.3.9 Noise Measurement Marker**

The following commands control the noise measurement marker function.

`CALCulate<n>:MARKer<m>:FUNction:NOISe:RESult?`..... 897  
`CALCulate<n>:MARKer<m>:FUNction:NOISe[STATe]`..... 898

#### **CALCulate<n>:MARKer<m>:FUNction:NOISe:RESult?**

This command queries the result of the noise measurement.

To get a valid result, you have to perform a complete measurement with synchronization to the end of the measurement before reading out the result. This is only possible for single sweep mode.

See also `INITiate<n>:CONTinuous` on page 635.

**Suffix:**

<n> [Window](#)

<m> [Marker](#)

**Return values:**

<NoiseLevel> Current noise level. The unit is the one currently active.

**Example:**

```
INIT:CONT OFF
```

Switches to single sweep mode.

```
CALC:MARK2 ON
```

Switches on marker 2.

```
CALC:MARK2:FUNC:NOIS ON
```

Switches on noise measurement for marker 2.

```
INIT;*WAI
```

Starts a sweep and waits for the end.

```
CALC:MARK2:FUNC:NOIS:RES?
```

Outputs the noise result of marker 2.

**Usage:** Query only

**Manual operation:** See "[Noise Measurement State](#)" on page 425

**CALCulate<n>:MARKer<m>:FUNCTION:NOISe[:STATE] <State>**

This command turns the noise measurement at the marker position on and off.

**Suffix:**

<n> [Window](#)

<m> [Marker](#)

**Parameters:**

<State> ON | OFF | 1 | 0

\*RST: 0

**Example:**

```
CALC:MARK:FUNC:NOIS ON
```

Switches on the noise measurement.

**Manual operation:** See "[Noise Measurement State](#)" on page 425  
See "[Switching All Noise Measurement Off](#)" on page 425

### 12.8.3.10 Phase Noise Measurement Marker

The following commands control the phase noise measurement marker function.

**Useful commands for phase noise markers described elsewhere**

- [CALCulate<n>:DELTaMarker<m>:FUNCTION:FIXed:RPOint:MAXimum\[:PEAK\]](#)
- [CALCulate<n>:DELTaMarker<m>:FUNCTION:FIXed:RPOint:X](#)
- [CALCulate<n>:DELTaMarker<m>:FUNCTION:FIXed:RPOint:Y](#)

**Remote commands exclusive to phase noise markers**

|                                                          |     |
|----------------------------------------------------------|-----|
| CALCulate<n>:DELTaMarker<m>:FUNction:PNOise:AUTO.....    | 899 |
| CALCulate<n>:DELTaMarker<m>:FUNction:PNOise:RESult?..... | 899 |
| CALCulate<n>:DELTaMarker<m>:FUNction:PNOise[:STATe]..... | 900 |
| CALCulate<n>:MARKer<m>:FUNction:PNOise:RESult?.....      | 900 |
| CALCulate<n>:MARKer<m>:FUNction:PNOise[:STATe].....      | 901 |

**CALCulate<n>:DELTaMarker<m>:FUNction:PNOise:AUTO <State>**

This command turns an automatic peak search for the fixed reference marker at the end of a sweep on and off.

**Suffix:**

<n>                      [Window](#)

<m>                      [Marker](#)

**Parameters:**

<State>                ON | OFF | 1 | 0

\*RST:                0

**Example:**

CALC:DELT:FUNC:PNO:AUTO ON

Activates an automatic peak search for the reference marker in a phase-noise measurement.

**Manual operation:** See "[Defining Reference Point](#)" on page 427

**CALCulate<n>:DELTaMarker<m>:FUNction:PNOise:RESult?**

This command queries the result of a phase noise measurement.

If necessary, the command activates the measurement first.

This command is only available in the Spectrum application.

**Suffix:**

<n>                      [Window](#)

<m>                      [Marker](#)

**Return values:**

<PhaseNoise>        numeric value

The difference in level between the reference point and the noise power density at the position of the specified delta marker.

**Example:**

CALC:DELT2:FUNC:PNO:RES?

Outputs the result of phase-noise measurement of the delta-marker 2.

**Usage:**

Query only

**Manual operation:** See "[Phase Noise Measurement State](#)" on page 427

**CALCulate<n>:DELTaMarker<m>:FUNCTioN:PNOise[:STATe] <State>**

This command turns the phase noise measurement at the delta marker position on and off.

The reference marker for phase noise measurements is either a normal marker or a fixed reference. If necessary, the command turns on the reference marker.

The correction values for the bandwidth and the log amplifier are taken into account in the measurement.

**Suffix:**

<n> [Window](#)

<m> [Marker](#)

**Parameters:**

<State> ON | OFF | 1 | 0

\*RST: 0

**Example:**

```
CALC:DELT:FUNC:PNO ON
```

Switches on the phase-noise measurement with all delta markers.

```
CALC:DELT:FUNC:FIX:RPO:X 128 MHZ
```

Sets the frequency reference to 128 MHz.

```
CALC:DELT:FUNC:FIX:RPO:Y 30 DBM
```

Sets the reference level to +30 dBm

**Manual operation:** See "[Phase Noise Measurement State](#)" on page 427  
See "[Switching All Phase Noise Measurements Off](#)" on page 428

**CALCulate<n>:MARKer<m>:FUNCTioN:PNOise:RESult?**

This command queries the result of a phase noise measurement in the Analog Demodulation application.

If necessary, the command activates the measurement first.

**Suffix:**

<n> [Window](#)

<m> [Marker](#)

**Return values:**

<PhaseNoise> numeric value

The difference between the measured carrier power and the noise power at the position of the specified (normal) marker.

**Example:**

```
CALC:MARK2:FUNC:PNO:RES?
```

Outputs the result of phase-noise measurement of the marker 2.

**Usage:**

Query only

**CALCulate<n>:MARKer<m>:FUNCTION:PNOise[:STATe] <State>**

This command turns the phase noise measurement at the marker position on and off in the Analog Demodulation application.

**Suffix:**

<n> [Window](#)

<m> [Marker](#)

**Parameters:**

<State> ON | OFF | 1 | 0

\*RST: 0

**Example:**

CALC:MARK2:FUNC:PNO ON

Switches on the phase-noise measurement for the marker 2.

**12.8.3.11 Band Power Marker**

The following commands control the marker for band power measurements.

**Using Markers**

[CALCulate<n>:MARKer<m>:FUNCTION:BPOWER:MODE](#)..... 901

[CALCulate<n>:MARKer<m>:FUNCTION:BPOWER:RESult?](#)..... 902

[CALCulate<n>:MARKer<m>:FUNCTION:BPOWER:SPAN](#)..... 902

[CALCulate<n>:MARKer<m>:FUNCTION:BPOWER\[:STATe\]](#)..... 902

**CALCulate<n>:MARKer<m>:FUNCTION:BPOWER:MODE <Mode>**

This command selects the way the results for a band power marker are displayed.

(Note: relative power results are only available for delta markers, see [CALCulate<n>:DELTAmarker<m>:FUNCTION:BPOWER:MODE](#) on page 903.

**Suffix:**

<n> [Window](#)

<m> [Marker](#)

**Parameters:**

<Mode>

**POWER**

Result is displayed as an absolute power. The power unit depends on the [CALCulate<n>:UNIT:POWER](#) setting.

**DENSITY**

Result is displayed as a density in dBm/Hz.

\*RST: POWER

**Example:**

CALC:MARK4:FUNC:BPOW:MODE DENS

Configures marker 4 to show the measurement results in dBm/Hz.

**Manual operation:** See " [Power Mode](#) " on page 433

**CALCulate<n>:MARKer<m>:FUNCtion:BPOWer:RESult?**

This command queries the results of the band power measurement.

**Suffix:**

<n> [Window](#)

<m> [Marker](#)

**Return values:**

<Power> Signal power over the marker bandwidth.

**Example:**

Activate the band power marker:

```
CALC:MARK:FUNC:BPOW:STAT ON
```

Select the density mode for the result:

```
CALC:MARK:FUNC:BPOW:MODE DENS
```

Query the result:

```
CALC:MARK:FUNC:BPOW:RES?
```

Response:

```
20dBm/Hz
```

**Usage:** Query only

**CALCulate<n>:MARKer<m>:FUNCtion:BPOWer:SPAN <Span>**

This command defines the bandwidth around the marker position.

**Suffix:**

<n> [Window](#)

<m> [Marker](#)

**Parameters:**

<Span> Frequency. The maximum span depends on the marker position and R&S FPS model.

\*RST: 5% of current span

Default unit: Hz

**Example:**

```
CALC:MARK:FUNC:BPOW:SPAN 2MHz
```

Measures the band power over 2 MHz around the marker.

**Manual operation:** See "[Span](#)" on page 433

**CALCulate<n>:MARKer<m>:FUNCtion:BPOWer[:STATe] <State>**

This command turns markers for band power measurements on and off.

**Suffix:**

<n> [Window](#)

<m> [Marker](#)

**Parameters:**

<State> ON | OFF | 1 | 0

\*RST: 0

**Example:** `CALC:MARK4:FUNC:BPOW:STAT ON`  
 Activates or turns marker 4 into a band power marker.

**Manual operation:** See " [Band Power Measurement State](#) " on page 433  
 See " [Switching All Band Power Measurements Off](#) " on page 434

### Using Delta Markers

|                                                                                     |     |
|-------------------------------------------------------------------------------------|-----|
| <code>CALCulate&lt;n&gt;:DELTamarker&lt;m&gt;:FUNCTio:n:BPOWer:MODE</code> .....    | 903 |
| <code>CALCulate&lt;n&gt;:DELTamarker&lt;m&gt;:FUNCTio:n:BPOWer:RESult?</code> ..... | 903 |
| <code>CALCulate&lt;n&gt;:DELTamarker&lt;m&gt;:FUNCTio:n:BPOWer:SPAN</code> .....    | 904 |
| <code>CALCulate&lt;n&gt;:DELTamarker&lt;m&gt;:FUNCTio:n:BPOWer[:STATe]</code> ..... | 904 |

---

### `CALCulate<n>:DELTamarker<m>:FUNCTio:n:BPOWer:MODE <Mode>`

This command selects the way the results for a band power delta marker are displayed.

**Suffix:**

<n> [Window](#)

<m> [Marker](#)

**Parameters:**

<Mode>

**POWER**

Result is displayed as an absolute power. The power unit depends on the `CALCulate<n>:UNIT:POWER` setting.

**DENSITY**

Result is displayed as a density in dBm/Hz.

**RPOWER**

This setting is only available for a delta band power marker. The result is the difference between the absolute power in the band around the delta marker and the absolute power for the reference marker. The powers are subtracted logarithmically, so the result is a dB value.

*[Relative band power (Delta2) in dB] = [absolute band power (Delta2) in dBm] - [absolute (band) power of reference marker in dBm]*

For details see "[Relative band power markers](#)" on page 431.

\*RST: POWER

**Manual operation:** See " [Power Mode](#) " on page 433

---

### `CALCulate<n>:DELTamarker<m>:FUNCTio:n:BPOWer:RESult?`

This command queries the results of the band power measurement.

**Suffix:**

<n> [Window](#)

<m> [Marker](#)

**Return values:**

<Power> Signal power over the delta marker bandwidth.

**Usage:**

Query only

**CALCulate<n>:DELTaMarker<m>:FUNCTioN:BPOWer:SPAN <Span>**

This command defines the bandwidth around the delta marker position.

**Suffix:**

<n> [Window](#)

<m> [Marker](#)

**Parameters:**

<Span> Frequency. The maximum span depends on the marker position and R&S FPS model.

\*RST: 5% of current span

Default unit: Hz

**Manual operation:** See "[Span](#)" on page 433

**CALCulate<n>:DELTaMarker<m>:FUNCTioN:BPOWer[:STATe] <State>**

This command turns delta markers for band power measurements on and off.

If necessary, the command also turns on a reference marker.

**Suffix:**

<n> [Window](#)

<m> [Marker](#)

**Parameters:**

<State> ON | OFF | 1 | 0

\*RST: 0

**Manual operation:** See "[Band Power Measurement State](#)" on page 433  
See "[Switching All Band Power Measurements Off](#)" on page 434

**12.8.3.12 n dB Down Marker**

The following commands control the n dB down markers.

|                                                         |     |
|---------------------------------------------------------|-----|
| CALCulate<n>:MARKer<m>:FUNCTioN:NDBDown.....            | 905 |
| CALCulate<n>:MARKer<m>:FUNCTioN:NDBDown:FREQuency?..... | 905 |
| CALCulate<n>:MARKer<m>:FUNCTioN:NDBDown:QFACTOR?.....   | 906 |
| CALCulate<n>:MARKer<m>:FUNCTioN:NDBDown:RESult?.....    | 906 |
| CALCulate<n>:MARKer<m>:FUNCTioN:NDBDown:STATe.....      | 907 |
| CALCulate<n>:MARKer<m>:FUNCTioN:NDBDown:TIME?.....      | 907 |



**CALCulate<n>:MARKer<m>:FUNction:NDBDown <Distance>**

This command defines the distance of the n dB down markers to the reference marker.

**Suffix:**

<n> [Window](#)

<m> [Marker](#)

**Parameters:**

<Distance> Distance of the temporary markers to the reference marker in dB.  
For a positive offset, the markers T1 and T2 are placed *below* the active reference point.  
For a negative offset (for example for notch filter measurements), the markers T1 and T2 are placed *above* the active reference point.

\*RST: 6dB

**Example:**

CALC:MARK:FUNC:NDBD 3dB

Sets the distance to the reference marker to 3 dB.

**CALCulate<n>:MARKer<m>:FUNction:NDBDown:FREquency?**

This command queries the position of the n dB down markers on the x-axis when measuring in the frequency domain.

To get a valid result, you have to perform a complete measurement with synchronization to the end of the measurement before reading out the result. This is only possible for single sweep mode.

See also [INITiate<n>:CONTinuous](#) on page 635.

**Suffix:**

<n>, <m> irrelevant

**Return values:**

<Frequency> **<frequency 1>**  
absolute frequency of the n dB marker to the left of the reference marker in Hz  
**<frequency 2>**  
absolute frequency of the n dB marker to the right of the reference marker in Hz.

**Example:**

```
INIT:CONT OFF
Switches to single sweep mode.
CALC:MARK:FUNC:NDBD ON
Switches on the n dB down function.
INIT;*WAI
Starts a sweep and waits for the end.
CALC:MARK:FUNC:NDBD:FREQ?
This command would return, for example, 100000000,
200000000, meaning that the first marker position is at 100
MHz, the second marker position is at 200 MHz
```

**Usage:** Query only

**Manual operation:** See "[n dB down Delta Value](#)" on page 430

#### **CALCulate<n>:MARKer<m>:FUNCTion:NDBDown:QFACTOR?**

This command queries the Q factor of n dB down measurements.

**Suffix:**

<n>, <m>                      irrelevant

**Return values:**

<QFactor>

**Usage:** Query only

#### **CALCulate<n>:MARKer<m>:FUNCTion:NDBDown:RESult?**

This command queries the distance of the n dB down markers from each other.

To get a valid result, you have to perform a complete measurement with synchronization to the end of the measurement before reading out the result. This is only possible for single sweep mode.

See also [INITiate<n>:CONTinuous](#) on page 635.

**Suffix:**

<n>, <m>                      irrelevant

**Return values:**

<Distance>

The result depends on the span.  
 In case of frequency domain measurements, the command returns the bandwidth between the two n dB down markers in Hz.  
 In case of time domain measurements, the command returns the pulse width between the two n dB down markers in seconds.

**Example:**

```
INIT:CONT OFF
Switches to single sweep mode.
CALC:MARK:FUNC:NDBD ON
Switches on the n dB down function.
INIT;*WAI
Starts a sweep and waits for the end.
CALC:MARK:FUNC:NDBD:RES?
Outputs the measured value.
```

**Usage:** Query only

**Manual operation:** See "[n dB down Marker State](#)" on page 430

#### **CALCulate<n>:MARKer<m>:FUNCTION:NDBDown:STATe <State>**

This command turns the n dB Down marker function on and off.

**Suffix:**  
<n>, <m> irrelevant

**Parameters:**  
<State> ON | OFF | 1 | 0  
\*RST: 0

**Example:**

```
CALC:MARK:FUNC:NDBD:STAT ON
Turns the n dB Down marker on.
```

**Manual operation:** See "[n dB down Marker State](#)" on page 430

#### **CALCulate<n>:MARKer<m>:FUNCTION:NDBDown:TIME?**

This command queries the position of the n dB down markers on the x-axis when measuring in the time domain.

To get a valid result, you have to perform a complete measurement with synchronization to the end of the measurement before reading out the result. This is only possible for single sweep mode.

See also [INITiate<n>:CONTinuous](#) on page 635.

**Suffix:**  
<n>, <m> irrelevant

**Return values:**  
<TimeX1> absolute position in time of the n dB marker to the left of the reference marker in seconds  
  
<TimeX2> absolute position in time of the n dB marker to the right of the reference marker in seconds

**Example:**            `INIT:CONT OFF`  
                          Switches to single sweep mode  
                          `CALC:MARK:FUNC:NDBD ON`  
                          Switches on the n dB down function.  
                          `INIT;*WAI`  
                          Starts a sweep and waits for the end.  
                          `CALC:MARK:FUNC:NDBD:TIME?`  
                          Outputs the time values of the temporary markers.

**Usage:**                Query only

**Manual operation:** See " [n dB down Delta Value](#) " on page 430

### 12.8.3.13 Signal Count Marker

The following commands control the frequency counter.

|                                                                        |     |
|------------------------------------------------------------------------|-----|
| <code>CALCulate&lt;n&gt;:MARKer&lt;m&gt;:COUNT</code> .....            | 908 |
| <code>CALCulate&lt;n&gt;:MARKer&lt;m&gt;:COUNT:FREQUENCY?</code> ..... | 909 |
| <code>CALCulate&lt;n&gt;:MARKer&lt;m&gt;:COUNT:RESolution</code> ..... | 909 |

---

#### `CALCulate<n>:MARKer<m>:COUNT <State>`

This command turns the frequency counter at the marker position on and off.

The frequency counter works for one marker only. If you perform a frequency count with another marker, the R&S FPS deactivates the frequency count of the first marker.

To get a valid result, you have to perform a complete measurement with synchronization to the end of the measurement before reading out the result. This is only possible for single sweep mode.

See also `INITiate<n>:CONTinuous` on page 635.

#### **Suffix:**

<n>                      [Window](#)

<m>                      [Marker](#)

#### **Parameters:**

<State>                ON | OFF | 1 | 0

\*RST:                 0

**Example:**            `INIT:CONT OFF`  
                          Switches to single sweep mode.  
                          `CALC:MARK ON`  
                          Switches on marker 1.  
                          `CALC:MARK:COUN ON`  
                          Switches on the frequency counter for marker 1.  
                          `INIT;*WAI`  
                          Starts a sweep and waits for the end.  
                          `CALC:MARK:COUN:FREQ?`  
                          Outputs the measured value.

**Manual operation:** See " [Signal Count Marker State](#) " on page 422

**CALCulate<n>:MARKer<m>:COUNT:FREQUENCY?**

This command queries the frequency at the marker position.

To get a valid result, you have to perform a complete measurement with synchronization to the end of the measurement before reading out the result. This is only possible for single sweep mode.

See also [INITiate<n>:CONTinuous](#) on page 635.

Before you can use the command, you have to turn on the frequency counter.

**Suffix:**

<n> [Window](#)

<m> [Marker](#)

**Return values:**

<Frequency> Frequency at the marker position.

**Example:**

```
INIT:CONT OFF
Switches to single sweep mode.
CALC:MARK ON
Switches on marker 2.
CALC:MARK:COUN ON
Activates the frequency counter for marker 1.
INIT;*WAI
Starts a sweep and waits for the end.
CALC:MARK:COUN:FREQ?
Outputs the measured value of marker 1.
```

**Usage:** Query only

**Manual operation:** See "[Signal Count Marker State](#)" on page 422

**CALCulate<n>:MARKer<m>:COUNT:RESolution <Resolution>**

This command defines the resolution of the frequency counter.

**Suffix:**

<n> [Window](#)

<m> [Marker](#)

**Parameters:**

<Resolution> 0.001 | 0.01 | 0.1 | 1 | 10 | 100 | 1000 | 10000 Hz  
\*RST: 0.1 Hz

**Example:**

```
CALC:MARK:COUN:RES 1kHz
Sets the resolution of the frequency counter to 1 kHz.
```

**Manual operation:** See "[Resolution](#)" on page 422

### 12.8.3.14 Programming Examples for Using Markers and Marker Functions

Various programming examples on how to use markers and the special marker functions are provided here.



The use of spectrogram markers is demonstrated in [Chapter 12.8.2.7, "Programming Example: Configuring a Spectrogram"](#), on page 859.

|                                                                                                                   |     |
|-------------------------------------------------------------------------------------------------------------------|-----|
| • <a href="#">Example: Basic Markers</a> .....                                                                    | 910 |
| • <a href="#">Example: Marker Search in Spectrograms</a> .....                                                    | 911 |
| • <a href="#">Basic Frequency Sweep Measurement for Marker Function Examples</a> .....                            | 912 |
| • <a href="#">Example: Using a Fixed Reference Marker</a> .....                                                   | 913 |
| • <a href="#">Example: Obtaining a Marker Peak List</a> .....                                                     | 913 |
| • <a href="#">Example: Measuring Noise Density</a> .....                                                          | 914 |
| • <a href="#">Example: Measuring Phase Noise</a> .....                                                            | 914 |
| • <a href="#">Example: Measuring the Power in a Channel Using Band Power Markers</a> .....                        | 915 |
| • <a href="#">Example: Measuring Characteristic Bandwidths (Using the n dB Down Marker)</a> .....                 | 916 |
| • <a href="#">Example: Performing a Highly Accurate Frequency Measurement Using the Signal Count Marker</a> ..... | 916 |

#### Example: Basic Markers

This example demonstrates how to configure and define markers for a basic spectrum measurement in a remote environment. It assumes that the basic frequency sweep described in [Chapter 12.15.1, "Programming Example: Performing a Basic Frequency Sweep"](#), on page 1042 has been performed and thus does not begin by presetting the instrument.

```
//-----Configuring marker behavior -----
DISP:MTAB ON
//Marker information is always displayed in a separate table.
CALC:MARK:X:SSIZ STAN
//The marker moves from one pixel to the next instead of sweep points in manual op.
CALC:MARK:PEXC 6dB
//Defines a peak excursion of 6 dB.
CALC:MARK:X:SLIM ON
CALC:MARK:X:SLIM:LEFT 50MHz
CALC:MARK:X:SLIM:RIGH 150MHz
//Restricts the search area for peaks to the frequencies between 50 and 150 MHz.
CALC:THR -100dBm
CALC:THR:STAT ON
//Configures a threshold level for peak searches at -100 dBm.

//-----Defining and positioning markers -----
CALC:MARK1 ON
//Activates marker 1 and sets it to the peak of trace 1.
CALC:MARK2:TRAC 2
//Activates marker 2 and sets it to the peak of trace 2.
```

```

CALC:MARK3:X 150MHz
//Activates marker 3 and sets it to the freq. 150 MHz on trace 1.
CALC:MARK4:TRAC 4
//Activates marker 4 and sets it to the peak of trace 4.

CALC:MARK1:MAX:AUTO ON
//Moves M1 to the current peak of trace 1 after each sweep.
CALC:MARK2:MAX:NEXT
//Moves M2 to the next lower peak of trace 2.

CALC:DELT5 ON
CALC:DELT5:LINK ON
//Activates delta marker 5 and links it to marker 1. If M1 moves, so does D5.
CALC:DELT5:MREF 4
//Changes the reference for D5 to marker 4. D5 now shows the difference between
//the peak of trace 1 after each sweep and the value at the same position in
//trace 4, which is a copy of trace 1, averaged over 10 sweeps.
CALC:DELT5:MODE REL
//Shows the difference as relative values.

CALC:DELT6 ON
CALC:DELT6:MAX:NEXT
//Activates delta marker 6 and sets it to the next lower maximum of trace 1.
//Thus it shows the difference between the two highest peaks in trace 1.

//-----Retrieving marker values -----
CALC:MARK1:Y?
CALC:MARK2:Y?
CALC:MARK3:Y?
CALC:MARK4:Y?
CALC:DELT5:Y?
CALC:DELT6:Y?
//Retrieves the marker levels of each active normal and delta marker.
CALC:DELT5:X:REL?
CALC:DELT6:X:REL?
//Retrieves the frequency difference between the delta marker and marker 1.

//-----Deactivating all markers -----
//CALC:MARK:AOFF
//CALC:DELT:AOFF

```

### Example: Marker Search in Spectrograms

This example demonstrates how to search for peak values in spectrograms in a remote environment. It assumes a spectrogram is already available (see [Chapter 12.8.2.7, "Programming Example: Configuring a Spectrogram"](#), on page 859) and thus does not begin by presetting the instrument.

```

//----- Analyzing the results using markers -----
//Set marker1 on the peak power in the most recent spectrum and query
//its position

```

```

CALC2:SPEC:FRAM:SEL 0
CALC2:MARK1 ON
CALC2:MARK1:X?
CALC2:MARK1:Y?

//Set marker2 on the peak power in frame at -324ms and query its position
CALC2:MARK2 ON
CALC2:MARK2:SGR:FRAM -324ms
CALC2:MARK2:X?
CALC2:MARK2:Y?

//Set marker3 on peak power level in the entire spectrogram in memory and
//query its position
CALC2:MARK3 ON
CALC2:MARK:SPEC:SAR MEM
CALC2:MARK3:SPEC:XY:MAX
CALC2:MARK3:X?
CALC2:MARK3:Y?

//Move marker 3 to the next lower peak level for the same frequency
CALC2:MARK3:SPEC:Y:MAX:NEXT
CALC2:MARK3:X?
CALC2:MARK3:Y?

//Set marker 4 to the highest level in the (visible) spectrogram.
CALC2:MARK:SPEC:SAR VIS
CALC2:MARK4:SPEC:XY:MAX
//Move marker 4 to the next higher level in the frames above its current position.
CALC2:MARK4:SPEC:Y:MAX:ABOV

```

### Basic Frequency Sweep Measurement for Marker Function Examples

Since markers can only be placed on an existing trace, the following example provides a simple frequency sweep measurement to be used as a basis for the subsequent marker function scripts.

```

//----- Configuring the basic frequency sweep -----
*RST
//Resets the instrument
INIT:CONT OFF
//Selects single sweep mode.
FREQ:CENT 100MHz
//Defines the center frequency
FREQ:SPAN 200MHz
//Sets the span to 100 MHz on either side of the center frequency.
DISP:TRAC1:Y:RLEV 0dBm
//Sets the reference level to 0 dBm.

//----- Performing the measurement -----

```



```
INIT;*WAI
//Performs a measurement and waits for it to end
```

### Example: Using a Fixed Reference Marker

This example demonstrates how to configure and use reference markers in a basic spectrum measurement in a remote environment. It assumes that the basic frequency sweep described in ["Basic Frequency Sweep Measurement for Marker Function Examples"](#) on page 912 has been performed and thus does not begin by presetting the instrument.

```
//-----Configuring the reference marker -----
//Activate a fixed reference marker. It is set to the current maximum of trace 1.
CALC:DELT:FUNC:FIX ON
//Set the reference frequency to 128 MHz.
CALC:DELT:FUNC:FIX:RPO:X 128 MHZ
//Set the reference level to +30 dBm.
CALC:DELT:FUNC:FIX:RPO:Y 30 DBM

//Use the fixed reference marker as a reference for deltamarker 2
CALC:DELT2:MREF FIX

//Reset the reference marker to the current maximum of trace 1
CALC:DELT:FUNC:FIX:RPO:MAX
//Query the new position of the reference marker
CALC:DELT:FUNC:FIX:RPO:X?
CALC:DELT:FUNC:FIX:RPO:Y?
```

### Example: Obtaining a Marker Peak List

This example demonstrates how to obtain a marker peak list in a basic spectrum measurement in a remote environment. It assumes that the basic frequency sweep described in ["Basic Frequency Sweep Measurement for Marker Function Examples"](#) on page 912 has been performed and thus does not begin by presetting the instrument.

In this example, the peak search is restricted to the frequency range of 50 MHz to 150 MHz. The top 5 power levels with a peak excursion of 10dB and a minimum of -100 dBm are to be determined and displayed with their marker numbers. The results are sorted by frequency values. The resulting peak list is then exported to a file.

```
//----- Configuring the peak search -----
CALC:MARK:X:SLIM ON
CALC:MARK:X:SLIM:LEFT 50MHz
CALC:MARK:X:SLIM:RIGH 150MHz
CALC:MARK:PEXC 10DB
CALC:THR -100DBM
CALC:THR:STAT ON

CALC:MARK:FUNC:FPE:STAT ON
CALC:MARK:FUNC:FPE:LIST:SIZE 5
CALC:MARK:FUNC:FPE:SORT X
```

```

CALC:MARK:FUNC:FPE:ANN:LAB ON

//----- Retrieving results -----
CALC:MARK:FUNC:FPE:COUN?
CALC:MARK:FUNC:FPE:X?
CALC:MARK:FUNC:FPE:Y?

//----- Exporting the peak list -----
MMEM:STOR:PEAK 'PeakList'

```

### Example: Measuring Noise Density

This example demonstrates how to measure noise density using noise markers in a basic spectrum measurement in a remote environment. It assumes that the basic frequency sweep described in ["Basic Frequency Sweep Measurement for Marker Function Examples"](#) on page 912 has been performed and thus does not begin by presetting the instrument.

```

CALC:MARK1:FUNC:NOIS ON
//Switches on noise measurement at marker 1.

INIT;*WAI
//Performs a measurement and waits for it to end

CALC:MARK1:FUNC:NOIS:RES?
//Queries the measured noise level (per Hz bandwidth)

```

### Example: Measuring Phase Noise

This example demonstrates how to measure phase noise using markers in a basic spectrum measurement in a remote environment. It assumes that the basic frequency sweep described in ["Basic Frequency Sweep Measurement for Marker Function Examples"](#) on page 912 has been performed and thus does not begin by presetting the instrument.

```

//----- Configuring the phase noise marker -----
DET SAMP
//Switches to Sample detector

CALC:MARK1 ON
//Activates marker1 and sets it to the maximum power level

CALC:DELT:FUNC:PNO ON
//Activates phase noise marker function

CALC:DELT1 ON
CALC:DELT1:X 100kHz

CALC:DELT2 ON
CALC:DELT2:X 500kHz

CALC:DELT3 ON

```

```

CALC:DELT3:X 1MHz

CALC:DELT4 ON
CALC:DELT4:X 1.5MHz

//Activates the phase noise measurement function for offsets 100kHz/500kHz/1MHz/1.5MHz.

BAND:VID?
//Queries the used VBW (= 0.1*RBW)

//----- Querying the phase noise results -----

CALC:DELT1:FUNC:PNO:RES?
CALC:DELT2:FUNC:PNO:RES?
CALC:DELT3:FUNC:PNO:RES?
CALC:DELT4:FUNC:PNO:RES?
//Queries the difference in level between the peak and the noise power density
//measured at the deltamarkers, referred to the carrier power level (dBc)

```

### Example: Measuring the Power in a Channel Using Band Power Markers

This example demonstrates how to measure the power in a specific channel or band using markers in a basic spectrum measurement in a remote environment. It assumes that the basic frequency sweep described in ["Basic Frequency Sweep Measurement for Marker Function Examples"](#) on page 912 has been performed and thus does not begin by presetting the instrument.

```

//----- Configuring the band power marker -----
CALC:MARK1 ON
//Activates marker1 and sets it to the maximum power level
CALC:MARK1:FUNC:BPOW:STAT ON
//Activates the band power measurement for the band around marker 1
CALC:MARK1:FUNC:BPOW:SPAN 30MHz
//Sets the bandwidth to be measured to 30 MHz
CALC:MARK1:FUNC:BPOW:MODE DENS
//Sets the result to be a density (power per Hz bandwidth)

CALC:DELT2 ON
//Activates deltamarker2
CALC:DELT2:FUNC:BPOW:STAT ON
//Activates the band power measurement for the band around deltamarker 2
CALC:DELT2:FUNC:BPOW:SPAN 30MHz
//Sets the bandwidth to be measured to 30 MHz
CALC:DELT2:FUNC:BPOW:MODE DENS
//Sets the result to be a density (power per Hz bandwidth)

CALC:DELT3 ON
//Activates deltamarker3
CALC:DELT3:FUNC:BPOW:STAT ON
//Activates the band power measurement for the band around deltamarker 3

```

```

CALC:DELT3:FUNC:BPOW:SPAN 30MHz
//Sets the bandwidth to be measured to 30 MHz
CALC:DELT3:FUNC:BPOW:MODE DENS
//Sets the result to be a density (power per Hz bandwidth)

//-----Retrieving Results-----
CALC:MARK1:FUNC:BPOW:RES?
//Returns the power sum for the specified bandwidth around marker 1.
CALC:DELT2:FUNC:BPOW:RES?
//Returns the power sum for the specified bandwidth around deltamarker 2.
CALC:DELT3:FUNC:BPOW:RES?
//Returns the power sum for the specified bandwidth around deltamarker 3.

```

### Example: Measuring Characteristic Bandwidths (Using the n dB Down Marker)

This example demonstrates how to measure a characteristic bandwidth using markers in a basic spectrum measurement in a remote environment. It assumes that the basic frequency sweep described in [Chapter 12.15.1, "Programming Example: Performing a Basic Frequency Sweep"](#), on page 1042 has been performed and thus does not begin by presetting the instrument.

```

//----- Configuring the n dB down marker -----
CALC:MARK1 ON
//Activates marker1 and sets it to the maximum power level
CALC:MARK1:FUNC:NDBD 3DB
//Sets the level offset to 3 dB
CALC:MARK1:FUNC:NDBD:STAT ON
//Activates the n dB down measurement

//-----Retrieving Results-----
CALC:MARK:FUNC:NDBD:RES?
//Returns the bandwidth at the specified power offset.
CALC:MARK:FUNC:NDBD:FREQ?
//Returns the frequencies of the temporary markers at the power offsets
CALC:MARK:FUNC:NDBD:QFAC?
//Returns the quality factor of the resulting bandwidth

```

### Example: Performing a Highly Accurate Frequency Measurement Using the Signal Count Marker

This example demonstrates how to determine highly accurate frequency values using signal count markers in a basic spectrum measurement in a remote environment. It assumes that the basic frequency sweep described in [Chapter 12.15.1, "Programming Example: Performing a Basic Frequency Sweep"](#), on page 1042 has been performed and thus does not begin by presetting the instrument.

```

//----- Configuring the signal count marker -----
CALC:MARK1 ON
//Activates marker1
CALC:MARK1:COUN ON
//Switches on the frequency counter for marker 1.
CALC:MARK1:COUN:RES 1kHz

```

```
//Sets the resolution of the frequency counter to 1kHz

//----- Performing the measurement -----
INIT;*WAI
//Performs a measurement and waits for it to end

//-----Retrieving Results-----
CALC:MARK1:COUN:FREQ?
//Returns the signal counter value as the precise marker frequency.
```

## 12.8.4 Configuring Display and Limit Lines

The commands required to configure display and limit lines in a remote environment are described here.

- [Configuring Display Lines](#)..... 917
- [Defining Limit Checks](#)..... 919

### 12.8.4.1 Configuring Display Lines

The following commands configure vertical and horizontal display lines.

|                                                               |     |
|---------------------------------------------------------------|-----|
| <a href="#">CALCulate&lt;n&gt;:DLINe&lt;k&gt;</a> .....       | 917 |
| <a href="#">CALCulate&lt;n&gt;:DLINe&lt;k&gt;:STATe</a> ..... | 918 |
| <a href="#">CALCulate&lt;n&gt;:FLINe&lt;k&gt;</a> .....       | 918 |
| <a href="#">CALCulate&lt;n&gt;:FLINe&lt;k&gt;:STATe</a> ..... | 918 |
| <a href="#">CALCulate&lt;n&gt;:TLINe&lt;k&gt;</a> .....       | 919 |
| <a href="#">CALCulate&lt;n&gt;:TLINe&lt;k&gt;:STATe</a> ..... | 919 |

---

#### **CALCulate<n>:DLINe<k>** <Position>

This command defines the (vertical) position of a display line.

##### **Suffix:**

|     |                            |
|-----|----------------------------|
| <n> | <a href="#">Window</a>     |
| <k> | <a href="#">Limit line</a> |

##### **Parameters:**

|            |                                                                                                                                                                                                                                    |
|------------|------------------------------------------------------------------------------------------------------------------------------------------------------------------------------------------------------------------------------------|
| <Position> | The value range is variable.<br>You can use any unit you want, the R&S FPS then converts the unit to the currently selected unit. If you omit a unit, the R&S FPS uses the currently selected unit.<br><b>*RST:</b> (state is OFF) |
|------------|------------------------------------------------------------------------------------------------------------------------------------------------------------------------------------------------------------------------------------|

##### **Example:**

```
CALC:DLIN2 -20dBm
Positions the second display line at -20 dBm.
```

**Manual operation:** See "[Horizontal Line 1 / Horizontal Line 2](#)" on page 442

**CALCulate<n>:DLINe<k>:STATe <State>**

This command turns a display line on and off

**Suffix:**

<n> [Window](#)

<k> [Limit line](#)

**Parameters:**

<State> ON | OFF | 1 | 0

\*RST: 0

**Example:**

CALC:DLIN2:STAT ON  
Turns on display line 2.

**CALCulate<n>:FLINe<k> <Frequency>**

This command defines the position of a frequency line.

**Suffix:**

<n> [Window](#)

<k> [Limit line](#)

**Parameters:**

<Frequency> Note that you can not set a frequency line to a position that is outside the current span.

Range: 0 Hz to Fmax

\*RST: (STATe to OFF)

**Example:**

CALC:FLIN2 120MHz  
Sets frequency line 2 to a frequency of 120 MHz.

**Manual operation:** See "[Vertical Line 1 / Vertical Line 2](#)" on page 442

**CALCulate<n>:FLINe<k>:STATe <State>**

This command turns a frequency line on and off

**Suffix:**

<n> [Window](#)

<k> [Limit line](#)

**Parameters:**

<State> ON | OFF | 1 | 0

\*RST: 0

**Example:**

CALC:FLIN2:STAT ON  
Turns frequency line 2 on.

**CALCulate<n>:TLINe<k> <Time>**

This command defines the position of a time line.

**Suffix:**

<n> [Window](#)

<k> [Limit line](#)

**Parameters:**

<Time> Note that you can not set a time line to a position that is higher than the current sweep time.

Range: 0 s to 1600 s

\*RST: (STATe to OFF)

**Example:**

CALC:TLIN 10ms

Sets the first time line to 10 ms.

**Manual operation:** See "[Vertical Line 1 / Vertical Line 2](#)" on page 442

**CALCulate<n>:TLINe<k>:STATe <State>**

This command turns a time line on and off

**Suffix:**

<n> [Window](#)

<k> [Limit line](#)

**Parameters:**

<State> ON | OFF | 1 | 0

\*RST: 0

**Example:**

CALC:TLIN:STAT ON

Turns the first time line on.

**12.8.4.2 Defining Limit Checks**

Note that in remote control, upper and lower limit lines are configured using separate commands. Thus, you must decide in advance which you want to configure. The x-values for both upper and lower limit lines are defined as a common control line. This control line is the reference for the y-values for both upper and lower limit lines.

- [Configuring Limit Lines](#)..... 919
- [Managing Limit Lines](#)..... 929
- [Checking the Results of a Limit Check](#)..... 932
- [Programming Example: Using Limit Lines](#)..... 933

**Configuring Limit Lines**

|                                                                        |     |
|------------------------------------------------------------------------|-----|
| <a href="#">CALCulate&lt;n&gt;:LIMit&lt;k&gt;:COMMeNt</a> .....        | 920 |
| <a href="#">CALCulate&lt;n&gt;:LIMit&lt;k&gt;:CONTRol[:DATA]</a> ..... | 920 |
| <a href="#">CALCulate&lt;n&gt;:LIMit&lt;k&gt;:CONTRol:DOMain</a> ..... | 921 |
| <a href="#">CALCulate&lt;n&gt;:LIMit&lt;k&gt;:CONTRol:MODE</a> .....   | 921 |

|                                            |     |
|--------------------------------------------|-----|
| CALCulate<n>:LIMit<k>:CONTRol:OFFSet.....  | 922 |
| CALCulate<n>:LIMit<k>:CONTRol:SHIFt.....   | 922 |
| CALCulate<n>:LIMit<k>:CONTRol:SPACing..... | 922 |
| CALCulate<n>:LIMit<k>:LOWer[:DATA].....    | 923 |
| CALCulate<n>:LIMit<k>:LOWer:MARGin.....    | 923 |
| CALCulate<n>:LIMit<k>:LOWer:MODE.....      | 923 |
| CALCulate<n>:LIMit<k>:LOWer:OFFSet.....    | 924 |
| CALCulate<n>:LIMit<k>:LOWer:SHIFt.....     | 924 |
| CALCulate<n>:LIMit<k>:LOWer:SPACing.....   | 924 |
| CALCulate<n>:LIMit<k>:LOWer:STATe.....     | 925 |
| CALCulate<n>:LIMit<k>:LOWer:THReshold..... | 925 |
| CALCulate<n>:LIMit<k>:NAME.....            | 925 |
| CALCulate<n>:LIMit<k>:UNIT.....            | 926 |
| CALCulate<n>:LIMit<k>:UPPer[:DATA].....    | 926 |
| CALCulate<n>:LIMit<k>:UPPer:MARGin.....    | 927 |
| CALCulate<n>:LIMit<k>:UPPer:MODE.....      | 927 |
| CALCulate<n>:LIMit<k>:UPPer:OFFSet.....    | 927 |
| CALCulate<n>:LIMit<k>:UPPer:SHIFt.....     | 928 |
| CALCulate<n>:LIMit<k>:UPPer:SPACing.....   | 928 |
| CALCulate<n>:LIMit<k>:UPPer:STATe.....     | 928 |
| CALCulate<n>:LIMit<k>:UPPer:THReshold..... | 929 |

---

#### **CALCulate<n>:LIMit<k>:COMMeNt <Comment>**

This command defines a comment for a limit line.

##### **Suffix:**

|     |            |
|-----|------------|
| <n> | irrelevant |
| <k> | Limit line |

##### **Parameters:**

|           |                                                      |
|-----------|------------------------------------------------------|
| <Comment> | String containing the description of the limit line. |
|-----------|------------------------------------------------------|

**Manual operation:** See " [Comment](#) " on page 451

---

#### **CALCulate<n>:LIMit<k>:CONTRol[:DATA] <LimitLinePoints>**

This command defines the horizontal definition points of a limit line.

##### **Suffix:**

|     |            |
|-----|------------|
| <n> | irrelevant |
| <k> | Limit line |



**Parameters:**

<LimitLinePoints> Variable number of x-axis values.  
 Note that the number of horizontal values has to be the same as the number of vertical values set with `CALCulate<n>`:  
`LIMit<k>:LOWer[:DATA]` or `CALCulate<n>:LIMit<k>:UPPer[:DATA]`. If not, the R&S FPS either adds missing values or ignores surplus values.  
 The unit is Hz or s.  
 \*RST: -

**Manual operation:** See " [Data Points](#) " on page 452

**CALCulate<n>:LIMit<k>:CONTrol:DOMain <Type>**

This command selects the domain of the limit line.

**Suffix:**

<n> irrelevant

<k> [Limit line](#)

**Parameters:**

<Type> FREQUENCY | TIME

**FREQUENCY**

For limit lines that apply to a range of frequencies.

**TIME**

For limit lines that apply to a period of time.

\*RST: FREQUENCY

**Example:**

`CALC:LIM:CONT:DOM FREQ`

Select a limit line in the frequency domain.

**Manual operation:** See " [X-Axis](#) " on page 452

**CALCulate<n>:LIMit<k>:CONTrol:MODE <Mode>**

This command selects the horizontal limit line scaling.

**Suffix:**

<n> irrelevant

<k> [Limit line](#)

**Parameters:**

<Mode>

**ABSolute**

Limit line is defined by absolute physical values (Hz or s).

**RELative**

Limit line is defined by relative values related to the center frequency (frequency domain) or the left diagram border (time domain).

\*RST: ABSolute

**CALCulate<n>:LIMit<k>:CONTrol:OFFSet <Offset>**

This command defines an offset for a complete limit line.

Compared to shifting the limit line, an offset does not actually change the limit line definition points.

**Suffix:**

<n> irrelevant

<k> [Limit line](#)

**Parameters:**

<Offset> Numeric value.  
The unit depends on the scale of the x-axis.  
\*RST: 0

**Manual operation:** See "[X-Offset](#)" on page 449

**CALCulate<n>:LIMit<k>:CONTrol:SHIFt <Distance>**

This command moves a complete limit line horizontally.

Compared to defining an offset, this command actually changes the limit line definition points by the value you define.

**Suffix:**

<n> irrelevant

<k> [Limit line](#)

**Parameters:**

<Distance> Numeric value.  
The unit depends on the scale of the x-axis.

**Manual operation:** See "[Shift x](#)" on page 453

**CALCulate<n>:LIMit<k>:CONTrol:SPACing <InterpolMode>**

This command selects linear or logarithmic interpolation for the calculation of limit lines from one horizontal point to the next.

**Suffix:**

<n> [Window](#)

<k> [Limit line](#)

**Parameters:**

<InterpolMode> LINear | LOGarithmic  
\*RST: LIN

**Example:** CALC:LIM:CONT:SPAC LIN

**Manual operation:** See "[X-Axis](#)" on page 452

**CALCulate<n>:LIMit<k>:LOWer[:DATA] <LimitLinePoints>**

This command defines the vertical definition points of a lower limit line.

**Suffix:**

<n> irrelevant

<k> [Limit line](#)

**Parameters:**

<LimitLinePoints> Variable number of level values.  
 Note that the number of vertical values has to be the same as the number of horizontal values set with [CALCulate<n>:LIMit<k>:CONTRol\[:DATA\]](#). If not, the R&S FPS either adds missing values or ignores surplus values.  
 The unit depends on [CALCulate<n>:LIMit<k>:UNIT](#) on page 926.

\*RST: Limit line state is OFF

**Manual operation:** See "[Data Points](#)" on page 452

**CALCulate<n>:LIMit<k>:LOWer:MARGin <Margin>**

This command defines an area around a lower limit line where limit check violations are still tolerated.

**Suffix:**

<n> irrelevant

<k> [Limit line](#)

**Parameters:**

<Margin> **numeric value**  
 \*RST: 0  
 Default unit: dB

**Manual operation:** See "[Margin](#)" on page 452

**CALCulate<n>:LIMit<k>:LOWer:MODE <Mode>**

This command selects the vertical limit line scaling.

**Suffix:**

<n> [Window](#)

<k> [Limit line](#)

**Parameters:**

&lt;Mode&gt;

**ABSolute**

Limit line is defined by absolute physical values.  
The unit is variable.

**RELative**

Limit line is defined by relative values related to the reference level (dB).

\*RST: ABSolute

**Manual operation:** See " [X-Axis](#) " on page 452**CALCulate<n>:LIMit<k>:LOWer:OFFSet <Offset>**

This command defines an offset for a complete lower limit line.

Compared to shifting the limit line, an offset does not actually change the limit line definition points.

**Suffix:**<n> [Window](#)<k> [Limit line](#)**Parameters:**

&lt;Offset&gt; Numeric value.

\*RST: 0

Default unit: dB

**Manual operation:** See " [Y-Offset](#) " on page 450**CALCulate<n>:LIMit<k>:LOWer:SHIFt <Distance>**

This command moves a complete lower limit line vertically.

Compared to defining an offset, this command actually changes the limit line definition points by the value you define.

**Suffix:**<n> [Window](#)<k> [Limit line](#)**Parameters:**

&lt;Distance&gt; Defines the distance that the limit line moves.

The unit depends on [CALCulate<n>:LIMit<k>:UNIT](#) on page 926.

**Manual operation:** See " [Shift y](#) " on page 453**CALCulate<n>:LIMit<k>:LOWer:SPACing <InterpolType>**

This command selects linear or logarithmic interpolation for the calculation of a lower limit line from one horizontal point to the next.

**Suffix:**<n> [Window](#)<k> [Limit line](#)**Parameters:**

&lt;InterpolType&gt; LINear | LOGarithmic

\*RST: LIN

**Manual operation:** See "[Y-Axis](#)" on page 452**CALCulate<n>:LIMit<k>:LOWer:STATe <State>**

This command turns a lower limit line on and off.

Before you can use the command, you have to select a limit line with [CALCulate<n>:LIMit<k>:NAME](#) on page 925.**Suffix:**

&lt;n&gt; irrelevant

<k> [Limit line](#)**Parameters:**

&lt;State&gt; ON | OFF | 1 | 0

\*RST: 0

**Manual operation:** See "[Visibility](#)" on page 449**CALCulate<n>:LIMit<k>:LOWer:THReshold <Threshold>**

This command defines a threshold for relative limit lines.

The R&amp;S FPS uses the threshold for the limit check, if the limit line violates the threshold.

**Suffix:**

&lt;n&gt; irrelevant

<k> [Limit line](#)**Parameters:**

&lt;Threshold&gt; Numeric value.

The unit depends on [CALCulate<n>:LIMit<k>:UNIT](#) on page 926.

\*RST: -200 dBm

**Manual operation:** See "[Threshold](#)" on page 451**CALCulate<n>:LIMit<k>:NAME <Name>**

This command selects a limit line that already exists or defines a name for a new limit line.

**Suffix:**<n> [Window](#)<k> [Limit line](#)**Parameters:**

&lt;Name&gt; String containing the limit line name.

\*RST: REM1 to REM8 for lines 1 to 8

**Manual operation:** See "[Name](#)" on page 451**CALCulate<n>:LIMit<k>:UNIT <Unit>**

This command defines the unit of a limit line.

**Suffix:**

&lt;n&gt; irrelevant

<k> [Limit line](#)**Parameters:**<Unit> DBM | DBPW | WATT | DBUV | DBMV | VOLT | DBUA |  
AMPere | DB | DBUV\_M | DBUA\_M | (unitless)

If you select dB as the limit line unit, the command automatically turns the limit line into a relative limit line.

\*RST: DBM

**Manual operation:** See "[Y-Axis](#)" on page 452**CALCulate<n>:LIMit<k>:UPPer[:DATA] <LimitLinePoints>**

This command defines the vertical definition points of an upper limit line.

**Suffix:**

&lt;n&gt; irrelevant

<k> [Limit line](#)**Parameters:**

&lt;LimitLinePoints&gt; Variable number of level values.

Note that the number of vertical values has to be the same as the number of horizontal values set with [CALCulate<n>:LIMit<k>:CONTrol\[:DATA\]](#). If not, the R&S FPS either adds missing values or ignores surplus values.The unit depends on [CALCulate<n>:LIMit<k>:UNIT](#) on page 926.

\*RST: Limit line state is OFF

**Manual operation:** See "[Data Points](#)" on page 452

**CALCulate<n>:LIMit<k>:UPPer:MARGin <Margin>**

This command defines an area around an upper limit line where limit check violations are still tolerated.

**Suffix:**

<n> irrelevant

<k> [Limit line](#)

**Parameters:**

<Margin> **numeric value**

\*RST: 0

Default unit: dB

**Manual operation:** See "[Margin](#)" on page 452

**CALCulate<n>:LIMit<k>:UPPer:MODE <Mode>**

This command selects the vertical limit line scaling.

**Suffix:**

<n> [Window](#)

<k> [Limit line](#)

**Parameters:**

<Mode>

**ABSolute**

Limit line is defined by absolute physical values.

The unit is variable.

**RELative**

Limit line is defined by relative values related to the reference level (dB).

\*RST: ABSolute

**Manual operation:** See "[X-Axis](#)" on page 452

**CALCulate<n>:LIMit<k>:UPPer:OFFSet <Offset>**

This command defines an offset for a complete upper limit line.

Compared to shifting the limit line, an offset does not actually change the limit line definition points.

**Suffix:**

<n> irrelevant

<k> [Limit line](#)

**Parameters:**

<Offset> Numeric value.

\*RST: 0

Default unit: dB

**Manual operation:** See " [Y-Offset](#) " on page 450

#### **CALCulate<n>:LIMit<k>:UPPer:SHIFt** <Distance>

This command moves a complete upper limit line vertically.

Compared to defining an offset, this command actually changes the limit line definition points by the value you define.

**Suffix:**

<n> irrelevant

<k> [Limit line](#)

**Parameters:**

<Distance> Defines the distance that the limit line moves.  
The unit depends on [CALCulate<n>:LIMit<k>:UNIT](#) on page 926.

**Usage:** Event

**Manual operation:** See " [Shift y](#) " on page 453

#### **CALCulate<n>:LIMit<k>:UPPer:SPACing** <InterpolType>

This command selects linear or logarithmic interpolation for the calculation of an upper limit line from one horizontal point to the next.

**Suffix:**

<n> [Window](#)

<k> [Limit line](#)

**Parameters:**

<InterpolType> LINear | LOGarithmic  
\*RST: LIN

**Manual operation:** See " [Y-Axis](#) " on page 452

#### **CALCulate<n>:LIMit<k>:UPPer:STATe** <State>

This command turns an upper limit line on and off.

Before you can use the command, you have to select a limit line with [CALCulate<n>:LIMit<k>:NAME](#) on page 925.

**Suffix:**

<n> irrelevant

<k> [Limit line](#)

**Parameters:**

<State> ON | OFF | 1 | 0  
\*RST: 0



**Manual operation:** See " [Visibility](#) " on page 449

---

### CALCulate<n>:LIMit<k>:UPPer:THReshold <Limit>

This command defines an absolute limit for limit lines with a relative scale.

The R&S FPS uses the threshold for the limit check, if the limit line violates the threshold.

**Suffix:**

<n> irrelevant

<k> [Limit line](#)

**Parameters:**

<Limit> Numeric value.

The unit depends on [CALCulate<n>:LIMit<k>:UNIT](#) on page 926.

\*RST: -200

Default unit: dBm

**Manual operation:** See " [Threshold](#) " on page 451

### Managing Limit Lines

Useful commands for managing limit lines described in the R&S FPS User Manual:

- `MMEM:SEL[:ITEM]:LIN:ALL`
- `MMEM:STOR:TYPE`
- `MMEM:LOAD:TYPE`

### Remote commands exclusive to managing limit lines:

|                                                                              |     |
|------------------------------------------------------------------------------|-----|
| <a href="#">CALCulate&lt;n&gt;:LIMit&lt;k&gt;:ACTive?</a> .....              | 929 |
| <a href="#">CALCulate&lt;n&gt;:LIMit&lt;k&gt;:COPY</a> .....                 | 930 |
| <a href="#">CALCulate&lt;n&gt;:LIMit&lt;k&gt;:DELeTe</a> .....               | 930 |
| <a href="#">CALCulate&lt;n&gt;:LIMit&lt;k&gt;:STATe</a> .....                | 930 |
| <a href="#">CALCulate&lt;n&gt;:LIMit&lt;k&gt;:TRACe&lt;t&gt;:CHECK</a> ..... | 931 |
| <a href="#">MMEMory:LOAD&lt;n&gt;:LIMit</a> .....                            | 931 |
| <a href="#">MMEMory:STORe&lt;n&gt;:LIMit</a> .....                           | 931 |

---

### CALCulate<n>:LIMit<k>:ACTive?

This command queries the names of *all* active limit lines.

**Suffix:**

<n>, <k> irrelevant

**Return values:**

<LimitLines> String containing the names of all active limit lines in alphabetical order.

**Example:**

`CALC:LIM:ACT?`

Queries the names of all active limit lines.

**Usage:** Query only  
**Manual operation:** See " [Visibility](#) " on page 449

### **CALCulate<n>:LIMit<k>:COPY <Line>**

This command copies a limit line.

**Suffix:**

<n> [Window](#)

<k> [Limit line](#)

**Parameters:**

<Line> **1 to 8**  
 number of the new limit line

**<name>**

String containing the name of the limit line.

**Example:**

`CALC:LIM1:COPY 2`

Copies limit line 1 to line 2.

`CALC:LIM1:COPY 'FM2'`

Copies limit line 1 to a new line named FM2.

**Manual operation:** See " [Copy Line](#) " on page 450

### **CALCulate<n>:LIMit<k>:DELeTe**

This command deletes a limit line.

**Suffix:**

<n> [Window](#)

<k> [Limit line](#)

**Usage:** Event

**Manual operation:** See " [Delete Line](#) " on page 450

### **CALCulate<n>:LIMit<k>:STATe <State>**

This command turns the limit check for a specific limit line on and off.

To query the limit check result, use `CALCulate<n>:LIMit<k>:FAIL?`.

Note that a new command exists to activate the limit check and define the trace to be checked in one step (see `CALCulate<n>:LIMit<k>:TRACe<t>:CHECK` on page 931).

**Suffix:**

<n> irrelevant

<k> [Limit line](#)

**Parameters:**

<State> ON | OFF | 1 | 0  
 \*RST: 0

**Example:**

CALC:LIM:STAT ON  
 Switches on the limit check for limit line 1.

**Manual operation:** See "[Disable All Lines](#)" on page 450

**CALCulate<n>:LIMit<k>:TRACe<t>:CHECK <State>**

This command turns the limit check for a specific trace on and off.

To query the limit check result, use `CALCulate<n>:LIMit<k>:FAIL?`.

Note that this command replaces the two commands from previous signal and spectrum analyzers (which are still supported, however):

- `CALCulate<n>:LIMit<k>:TRACe` on page 1039
- `CALCulate<n>:LIMit<k>:STATe` on page 930

**Suffix:**

<n> [Window](#)  
 <k> [Limit line](#)  
 <t> [Trace](#)

**Parameters:**

<State> ON | OFF | 1 | 0  
 \*RST: 0

**Example:**

CALC:LIM3:TRAC2:CHEC ON  
 Switches on the limit check for limit line 3 on trace 2.

**Manual operation:** See "[Traces to be Checked](#)" on page 449

**MMEMory:LOAD<n>:LIMit <FileName>**

Loads the limit line from the selected file in .CSV format.

**Parameters:**

<FileName> String containing the path and name of the CSV import file.

**Example:**

MMEM:LOAD:LIM 'C:\TEST.CSV'

**Manual operation:** See "[Import](#)" on page 453

**MMEMory:STORe<n>:LIMit <FileName>,<LimitLineName>**

This command exports limit line data to an ASCII (CSV) file.

For details on the file format see [Chapter 8.4.2.4, "Reference: Limit Line File Format"](#), on page 458.

**Suffix:**

<n> irrelevant

**Parameters:**

<FileName> String containing the path and name of the target file.

<LimitLineName> Name of the limit line to be exported.

**Example:**

```
M MEM:STOR:LIM 'C:\TEST', 'UpperLimitLine'
Stores the limit line named "UpperLimitLine" in the file
TEST.CSV.
```

**Manual operation:** See "[Export](#)" on page 453

**Checking the Results of a Limit Check**

[CALCulate<n>:LIMit<k>:CLEar\[:IMMediate\]](#).....932

[CALCulate<n>:LIMit<k>:FAIL?](#).....932

---

**CALCulate<n>:LIMit<k>:CLEar[:IMMediate]**

This command deletes the result of the current limit check.

The command works on *all* limit lines in *all* measurement windows at the same time.

**Suffix:**

<n>, <k> irrelevant

**Example:**

```
CALC:LIM:CLE
Deletes the result of the limit check.
```

---

**CALCulate<n>:LIMit<k>:FAIL?**

This command queries the result of a limit check in the specified window.

To get a valid result, you have to perform a complete measurement with synchronization to the end of the measurement before reading out the result. This is only possible for single sweep mode.

See also [INITiate<n>:CONTinuous](#) on page 635.

**Suffix:**

<n> [Window](#)

<k> [Limit line](#)

**Return values:**

<Result> **0**  
PASS  
**1**  
FAIL

**Example:**

```
INIT;*WAI
Starts a new sweep and waits for its end.
CALC2:LIM3:FAIL?
Queries the result of the check for limit line 3 in window 2.
```

- Usage:** Query only
- Manual operation:** See " [Limit Check <n>](#) " on page 223  
See " [Limit Check](#) " on page 255

### Programming Example: Using Limit Lines

The following examples demonstrate how to work with limit lines in a remote environment.

- [Example: Configuring Limit Lines](#).....933
- [Example: Performing a Limit Check](#).....934

#### Example: Configuring Limit Lines

This example demonstrates how to configure 2 limit lines - an upper and a lower limit - for a measurement in a remote environment.

```
//----- Configuring the limit lines -----
CALC:LIM1:NAME 'FM1'
//Names limit line 1 'FM1'.

CALC:LIM1:CONT:MODE ABS
//Selects absolute scaling for the horizontal axis.
CALC:LIM1:CONT 1 MHz,50MHz,100 MHz,150MHz,200MHz
//Defines 5 horizontal definition points for limit line 1.
CALC:LIM1:UPP:MODE ABS
//Selects an absolute vertical scale for limit line 1.
CALC:LIM1:UNIT DBM
//Selects the unit dBm for limit line 1.
CALC:LIM1:UPP -10,-5,0,-5,-10
//Defines 5 definition points for limit line 1.

CALC:LIM1:UPP:MARG 5dB
//Defines an area of 5 dB around limit line 1 where limit check violations
//are still tolerated.

CALC:LIM1:UPP:SHIF -10DB
//Shifts the limit line 1 by -10 dB.
CALC:LIM1:UPP:OFFS -3dB
//Defines an additional -3 dB offset for limit line 1.

CALC:LIM3:NAME 'FM3'
//Names limit line 3 'FM3'.

CALC:LIM3:LOW:MODE REL
//Selects a relative vertical scale for limit line 3.
CALC:LIM3:UNIT DB

CALC:LIM3:CONT 1 MHz,50MHz,100 MHz,150MHz,200MHz
//Defines 5 horizontal definition points for limit line 3.
CALC:LIM3:LOW -90,-60,-40,-60,-90
```

```
//Defines 5 definition points relative to the reference level for limit line 3.

CALC:LIM3:LOW:SHIF 2
//Shifts the limit line 3 by 2dB.
CALC:LIM3:LOW:OFFS 3
//Defines an additional 3 dB offset for limit line 3.

CALC:LIM3:LOW:THR -200DBM
//Defines a power threshold of -200dBm that must be exceeded for limit to be checked

CALC:LIM3:LOW:MARG 5dB
//Defines an area of 5dB around limit line 3 where limit check violations
//are still tolerated.

//----- Storing the limit lines -----
MMEM:SEL:CHAN:LIN:ALL ON
MMEM:STOR:TYPE CHAN
MMEM:STOR:STAT 1,'LimitLines_FM1_FM3'
```

### Example: Performing a Limit Check

This example demonstrates how to perform a limit check during a basic frequency sweep measurement in a remote environment. The limit lines configured in ["Example: Configuring Limit Lines"](#) on page 933 are assumed to exist and be active.

```
//-----Preparing the instrument -----
*RST
//Resets the instrument
INIT:CONT OFF
//Selects single sweep mode.

//-----Configuring the measurement -----
FREQ:CENT 100MHz
//Defines the center frequency
FREQ:SPAN 200MHz
//Sets the span to 100 MHz on either side of the center frequency.
SENS:SWE:COUN 10
//Defines 10 sweeps to be performed in each measurement.
DISP:TRAC1:Y:RLEV 0dBm
//Sets the reference level to 0 dBm.
TRIG:SOUR IFP
TRIG:LEV:IFP -10dBm
//Defines triggering when the second intermediate frequency rises to a level
//of -10 dBm.

//-----Configuring the Trace-----
DISP:TRAC2 ON
DISP:TRAC2:MODE AVER
DISP:TRAC3 ON
DISP:TRAC3:MODE MAXH
//Configures 3 traces: 1 (default): clear/write; 2: average; 3: max hold
```

```

//----- Configuring the limit check -----
MMEM:LOAD:TYPE REPL
MMEM:LOAD:STAT 1,'LimitLines_FM1_FM3'
//Loads the limit lines stored in 'LimitLines_FM1_FM3'
CALC:LIM1:NAME 'FM1'
CALC:LIM1:UPP:STAT ON
//Activates upper limit FM1 as line 1.
CALC:LIM3:NAME 'FM3'
CALC:LIM3:LOW:STAT ON
//Activates lower limit line FM3 as line 3.
CALC:LIM:ACT?
//Queries the names of all active limit lines
//Result: 'FM1,FM3'
CALC:LIM1:TRAC3:CHEC ON
//Activates the upper limit to be checked against trace3 (maxhold trace)
CALC:LIM3:TRAC2:CHEC ON
//Activates the upper limit to be checked against trace2 (average trace)
CALC:LIM:CLE
//Clears the previous limit check results

//----- Performing the measurement-----
INIT;*WAI
//Initiates a new measurement and waits until the last sweep has finished.

//----- Retrieving limit check results-----

CALC:LIM1:FAIL?
//Queries the result of the upper limit line check
CALC:LIM3:FAIL?
//Queries the result of the lower limit line check

```

## 12.9 Managing Settings and Results

The commands required to store and load instrument settings and import and export measurement results in a remote environment are described here.

The tasks for manual operation are described in [Chapter 9, "Data Management"](#), on page 499.

### Addressing drives

The various drives can be addressed via the "mass storage instrument specifier" <msis> using the conventional Windows syntax. The internal hard disk is addressed by "C:".

For details on storage locations refer to [Chapter 9.3.2.2, "Storage Location and File-name"](#), on page 507.

The file names (<FileName> parameter) are given as string parameters enclosed in quotation marks. They also comply with Windows conventions. Windows file names do not distinguish between uppercase and lowercase notation.

### Wildcards

The two characters "\*" and "?" can be used as "wildcards", i.e., they are variables for a selection of several files. The question mark "?" replaces exactly one character, the asterisk replaces any of the remaining characters in the file name. "\*. \*" thus means all files in a directory.

### Path names

Storage locations can be specified either as absolute (including the entire path) or relative paths (including only subfolders of the current folder). Use the `MMEM:CDIR?` query to determine the current folder.



### Secure user mode

In secure user mode, settings that are to be stored on the instrument are stored to volatile memory, which is restricted to 256 MHz. Thus, a "Memory full" error may occur although the hard disk indicates that storage space is still available.

- [General Data Storage and Loading Commands](#)..... 936
- [Selecting the Items to Store](#)..... 943
- [Storing and Loading Instrument Settings](#)..... 946
- [Storing or Printing Screenshots](#)..... 951
- [Storing Measurement Results](#)..... 962
- [Examples: Managing Data](#)..... 966

## 12.9.1 General Data Storage and Loading Commands

The following commands are available for all applications.

See also:

- [FORMat \[ : DATA \]](#) on page 853

|                                                  |     |
|--------------------------------------------------|-----|
| <a href="#">FORMat:DEXPort:DSEParator</a> .....  | 937 |
| <a href="#">MMEMory:CATalog?</a> .....           | 937 |
| <a href="#">MMEMory:CATalog:LONG?</a> .....      | 938 |
| <a href="#">MMEMory:CDIRectory</a> .....         | 938 |
| <a href="#">MMEMory:COMMent</a> .....            | 938 |
| <a href="#">MMEMory:COPI</a> .....               | 939 |
| <a href="#">MMEMory:DATA</a> .....               | 939 |
| <a href="#">MMEMory:DELeTe</a> .....             | 940 |
| <a href="#">MMEMory:MDIRectory</a> .....         | 940 |
| <a href="#">MMEMory:MOVE</a> .....               | 940 |
| <a href="#">MMEMory:MSIS</a> .....               | 940 |
| <a href="#">MMEMory:NAME</a> .....               | 941 |
| <a href="#">MMEMory:NETWork:DISConnect</a> ..... | 941 |



|                                                     |     |
|-----------------------------------------------------|-----|
| <a href="#">MMEMory:NETWork:MAP</a> .....           | 941 |
| <a href="#">MMEMory:NETWork:UNUSeddrives?</a> ..... | 942 |
| <a href="#">MMEMory:NETWork:USEDdrives?</a> .....   | 942 |
| <a href="#">MMEMory:RDIRECTory</a> .....            | 942 |

---

### FORMat:DEXPort:DSEParator <Separator>

This command selects the decimal separator for data exported in ASCII format.

#### Parameters:

<Separator>

#### COMMa

Uses a comma as decimal separator, e.g. 4,05.

#### POINt

Uses a point as decimal separator, e.g. 4.05.

\*RST:        \*RST has no effect on the decimal separator.  
Default is POINt.

#### Example:

```
FORM:DEXP:DSEP POIN
```

Sets the decimal point as separator.

**Manual operation:** See "[Saving the Result Summary \(Evaluation List\) to a File](#)" on page 235  
See "[Save Evaluation List](#)" on page 258  
See "[Export Peak List](#)" on page 437  
See "[Decimal Separator](#)" on page 493

---

### MMEMory:CATalog? <Path>

This command returns the contents of a particular directory.

#### Query parameters:

<Path>

String containing the path and directory

If you leave out the path, the command returns the contents of the directory selected with [MMEMory:CDIRECTory](#).

The path may be relative or absolute. Using wildcards (\*) is possible to query a certain type of files only.

If you use a specific file as a parameter, the command returns the name of the file if the file is found in the specified directory, or an error if the file is not found ("-256, "File name not found").

#### Return values:

<FileNames>

List of file and directory names, separated by commas

If no files are found, an error is displayed: "-256, "File name not found"

#### Example:

```
MMEM:CAT? 'C:\R_S\INSTR\USER\SPOOL?.PNG'
```

Returns all files in C:\R\_S\INSTR\USER whose names start with SPOOL, have 6 letters and the extension .PNG, e.g.:  
SPOOL1.PNG, SPOOL2.PNG, SPOOL3.PNG

**Example:** MMEM:CAT? 'C:\R\_S\INSTR\USER\SPOOL6.PNG'  
 Query whether the file 'SPOOL6.PNG' also exists in the directory;  
**Result:**  
 -256,"File name not found;:MMEMory:CATalog?  
 'C:\R\_S\INSTR\USER\SPOOL6.PNG'

**Usage:** Query only

**Manual operation:** See "[Selecting Storage Location - Drive/ Path/ Files](#)" on page 233

### MMEMory:CATalog:LONG? <Path>

This command returns the contents of a particular directory with additional information about the files.

#### Query parameters:

<Path> String containing the path and directory.  
 If you leave out the path, the command returns the contents of the directory selected with [MMEMory:CDIRectory](#).  
 The path may be relative or absolute. Using wildcards (\*) is possible to query a certain type of files only.

#### Return values:

<UsedDiskSpace> Byte size of all files in the directory.  
 <FreeDiskSpace> Remaining disk space in bytes.  
 <FileInfo> <NameFileN>,<SuffixFileN>,<SizeFileN>  
 Describes the individual file.  
**<NameFileN>**  
 Name of the file.  
**<SuffixFileN>**  
 Type of the file. Possible suffixes are: ASCii, BINary, DIRectory, STAT  
**<SizeFileN>**  
 Size of the file in bytes.

**Usage:** Query only

### MMEMory:CDIRectory <Directory>

This command changes the current directory.

#### Parameters:

<Directory> String containing the path to another directory.  
 The path may be relative or absolute.

### MMEMory:COMMeNt <Comment>

This command defines a comment for the stored settings.

**Parameters:**

<Comment> String containing the comment.

**Example:**

```
MMEMemory:COMMeNt "ACP measurement with Standard Tetra from 23.05."
```

```
MMEMemory::MMEMemory:STORe1:STATe 1, "ACP_T"
```

As a result, in the selection list for recall settings, the comment "ACP measurement with Standard Tetra from 23.05." is added to the ACP entry.

**Manual operation:** See "[Comment](#)" on page 509

**MMEMemory:COPY** <SourceFile>,<DestinationFile>

This command copies one or more files to another directory.

**Parameters:**

<SourceFile> String containing the path and file name of the source file.

<DestinationFile> String containing the path and name of the target file.  
The path may be relative or absolute.

**MMEMemory:DATA** <FileName>, [<Block>]

This command writes block data into a file. The delimiter must be set to EOI to obtain error-free data transfer.

When you query the contents of a file, you can save them in a file on the remote control computer.

The command is useful for reading stored settings files or trace data from the instrument or for transferring them to the instrument

**Parameters:**

<FileName> String containing the path and name of the target file.

<Block> Data block with the following structure.

**#**

Hash sign.

**<number>**

Length of the length information.

**<number>**

Length information of the binary data (number of bytes).

**<data>**

Binary data with the indicated <number> of bytes.

**Example:** `M MEM:NAME '\Public\User\Testfile.txt'`  
 Creates a new file called 'testfile.txt'.  
`M MEM:DATA 'Testfile.txt',#220` Contents of the file  
 file  
 The parameter means:  
**#2:** hash sign and length of the length information (20 bytes = 2 digits)  
**20:** indicates the number of subsequent binary data bytes.  
 Contents of the file: store 20 binary bytes (characters) to the file.

#### **MMEMory:DELeTe** <FileName>

This command deletes a file.

**Parameters:**

<FileName> String containing the path and file name of the file to delete.  
 The path may be relative or absolute.

**Usage:** Event

#### **MMEMory:MDIRectory** <Directory>

This command creates a new directory.

**Parameters:**

<Directory> String containing the path and new directory name  
 The path may be relative or absolute.

**Usage:** Event

#### **MMEMory:MOVE** <SourceFile>,<NewFileName>

This command moves a file to another directory.

The command also renames the file if you define a new name in the target directory.

If you do not include a path for <NewFileName>, the command just renames the file.

**Parameters:**

<SourceFile> String containing the path and file name of the source file.

<NewFileName> String containing the path and name of the target file.

**Example:** `M MEM:MOVE 'C:\TEST01.CFG', 'SETUP.CFG'`  
 Renames TEST01.CFG in SETUP.CFG in directory C:\.

**Usage:** Event

#### **MMEMory:MSIS** <Device>

This command selects the default storage device used by all MMEMory commands.

**Parameters:**

<Device>            'A:' | 'C:' | ... | 'Z:'  
 String containing the device drive name  
 \*RST:            n.a.

**MMEMory:NAME** <FileName>

This command has several purposes, depending on the context it is used in.

- It creates a new and empty file.
- It defines the file name for screenshots taken with [HCOPY](#) [`IMMEDIATE<device>`]. Note that you have to route the printer output to a file.

**Parameters:**

<FileName>            String containing the path and name of the target file.

**Example:**            `MMEM:NAME 'C:\R_S\INSTR\USER\PRINT1.BMP'`  
 Selects the file name.

**MMEMory:NETWork:DISConnect** <Drive>[, <Force>]

This command disconnects a network drive.

**Parameters:**

<Drive>            String containing the drive name.  
 <Force>            1 | 0 | ON | OFF  
 Optional: determines whether disconnection is forced or not  
**1 | ON**  
 Disconnection is forced.  
**0 | OFF**  
 Disconnect only if not in use.  
 \*RST:            0

**Usage:**            Event

**MMEMory:NETWork:MAP** <Drive>, <HostName> [, <UserName>, <Password>][, <Reconnect>]

This command maps a drive to a server or server directory of the network.

Note that you have to allow sharing for a server or folder in Microsoft networks first.

**Parameters:**

<Drive>            String containing the drive name or path of the directory you want to map.  
 <HostName>        String containing the host name of the computer or the IP address and the share name of the drive.  
 '<host name or IP address\share name>'

|               |                                                                                                                                     |
|---------------|-------------------------------------------------------------------------------------------------------------------------------------|
| <UserName>    | String containing a user name in the network.<br>The user name is optional.                                                         |
| <Password>    | String containing the password corresponding to the <User-Name>.<br>The password is optional.                                       |
| <Reconnect>   | ON   OFF   1   0<br><b>ON   1</b><br>Reconnects at logon with the same user name.<br><b>OFF   0</b><br>Does not reconnect at logon. |
| <b>Usage:</b> | Event                                                                                                                               |

---

#### **MMEMory:NETWork:UNUSeddrives?**

This command returns a list of unused network drives.

##### **Return values:**

<DriveName> List of network drives in alphabetically descending order, e.g. 'W:,V:,U:,...'

**Usage:** Query only

---

#### **MMEMory:NETWork:USEDdrives? <State>**

This command returns a list of all network drives in use.

##### **Parameters:**

<State> You do not have to use the parameter. If you do not include the parameter, the command returns a list of all drives in use. This is the same behavior as if you were using the parameter OFF.

**ON | 1**

Returns a list of all drives in use including the folder information.

**OFF | 0**

Returns a list of all drives in use.

**Usage:** Query only

---

#### **MMEMory:RDIRECTory <Directory>**

This command deletes the indicated directory.

##### **Parameters:**

<Directory> String containing the path of the directory to delete.  
Note that the directory you want to remove must be empty.

**Usage:** Event

## 12.9.2 Selecting the Items to Store

The following commands select the items to be included in the configuration file.

Depending on the used command, either the items from the entire instrument (`MMEMemory:SElect[:ITEM]...`), or only those from the currently selected channel (`MMEM:SElect:CHANnel[:ITEM]...`) are stored.

|                                                                   |     |
|-------------------------------------------------------------------|-----|
| <code>MMEMemory:SElect:CHANnel[:ITEM]:ALL</code> .....            | 943 |
| <code>MMEMemory:SElect[:ITEM]:ALL</code> .....                    | 943 |
| <code>MMEMemory:SElect:CHANnel[:ITEM]:DEFault</code> .....        | 943 |
| <code>MMEMemory:SElect[:ITEM]:DEFault</code> .....                | 943 |
| <code>MMEMemory:SElect:CHANnel[:ITEM]:HWSettings</code> .....     | 944 |
| <code>MMEMemory:SElect[:ITEM]:HWSettings</code> .....             | 944 |
| <code>MMEMemory:SElect:CHANnel[:ITEM]:LINES:ALL</code> .....      | 944 |
| <code>MMEMemory:SElect[:ITEM]:LINES:ALL</code> .....              | 944 |
| <code>MMEMemory:SElect:CHANnel[:ITEM]:NONE</code> .....           | 944 |
| <code>MMEMemory:SElect[:ITEM]:NONE</code> .....                   | 944 |
| <code>MMEMemory:SElect:CHANnel[:ITEM]:SPECTrogram</code> .....    | 945 |
| <code>MMEMemory:SElect:CHANnel[:ITEM]:SGRam</code> .....          | 945 |
| <code>MMEMemory:SElect[:ITEM]:SPECTrogram</code> .....            | 945 |
| <code>MMEMemory:SElect[:ITEM]:SGRam</code> .....                  | 945 |
| <code>MMEMemory:SElect:CHANnel[:ITEM]:TRACe[:ACTive]</code> ..... | 945 |
| <code>MMEMemory:SElect[:ITEM]:TRACe[:ACTive]</code> .....         | 945 |
| <code>MMEMemory:SElect:CHANnel[:ITEM]:TRANsducer:ALL</code> ..... | 945 |
| <code>MMEMemory:SElect[:ITEM]:TRANsducer:ALL</code> .....         | 945 |

---

### **MMEMemory:SElect:CHANnel[:ITEM]:ALL**

#### **MMEMemory:SElect[:ITEM]:ALL**

This command includes all items when storing or loading a configuration file.

The items are:

- Hardware configuration: `MMEMemory:SElect[:ITEM]:HWSettings`
- Limit lines: `MMEMemory:SElect[:ITEM]:LINES:ALL`
- Spectrogram data: `MMEMemory:SElect[:ITEM]:SGRam`
- Trace data: `MMEMemory:SElect[:ITEM]:TRACe[:ACTive]`
- Transducers: `MMEMemory:SElect[:ITEM]:TRANsducer:ALL`

**Example:** `MMEM:SEL:ALL`

**Usage:** Event

**Manual operation:** See "Items:" on page 509

---

### **MMEMemory:SElect:CHANnel[:ITEM]:DEFault**

#### **MMEMemory:SElect[:ITEM]:DEFault**

This command selects the current settings as the only item to store to and load from a configuration file.

**Usage:** Event

**Manual operation:** See " [Items:](#) " on page 509

**MMEMemory:SElect:CHANnel[:ITEM]:HWSettings <State>**

**MMEMemory:SElect[:ITEM]:HWSettings <State>**

This command includes or excludes measurement (hardware) settings when storing or loading a configuration file.

Measurement settings include:

- general channel configuration
- measurement hardware configuration including markers
- limit lines  
Note that a configuration may include no more than 8 limit lines. This number includes active limit lines as well as inactive limit lines that were used last. Therefore the combination of inactivate limit lines depends on the sequence of use with [MMEMemory:LOAD:STATe](#).
- color settings
- configuration for the hardcopy output

**Parameters:**

<State> ON | OFF | 0 | 1  
\*RST: 1

**Example:** MMEM:SEL:HWS ON

**Manual operation:** See " [Items:](#) " on page 509

**MMEMemory:SElect:CHANnel[:ITEM]:LINES:ALL <State>**

**MMEMemory:SElect[:ITEM]:LINES:ALL <State>**

This command includes or excludes all limit lines (active and inactive) when storing or loading a configuration file.

**Parameters:**

<State> ON | OFF | 1 | 0  
\*RST: 0

**Example:** MMEM:SEL:LIN:ALL ON

**Manual operation:** See " [Items:](#) " on page 509

**MMEMemory:SElect:CHANnel[:ITEM]:NONE**

**MMEMemory:SElect[:ITEM]:NONE**

This command does not include any of the following items when storing or loading a configuration file.

- Hardware configuration: [MMEMemory:SElect\[:ITEM\]:HWSettings](#)
- Limit lines: [MMEMemory:SElect\[:ITEM\]:LINES:ALL](#)



- Spectrogram data: `MMEemory:SElect[:ITEM]:SGRam`
- Trace data: `MMEemory:SElect[:ITEM]:TRACe[:ACTive]`
- Transducers: `MMEemory:SElect[:ITEM]:TRANsducer:ALL`

**Example:** `MMEM:SEL:NONE`

**Usage:** Event

**Manual operation:** See " [Items:](#) " on page 509

**MMEemory:SElect:CHANnel[:ITEM]:SPECTrogram <State>**

**MMEemory:SElect:CHANnel[:ITEM]:SGRam <State>**

**MMEemory:SElect[:ITEM]:SPECTrogram <State>**

**MMEemory:SElect[:ITEM]:SGRam <State>**

This command includes or excludes spectrogram data when storing or loading a configuration file.

**Parameters:**

<State> ON | OFF | 1 | 0

\*RST: 0

**Example:** `MMEM:SEL:SGR ON`

Adds the spectrogram data to the list of data subsets.

**Manual operation:** See " [Items:](#) " on page 509

**MMEemory:SElect:CHANnel[:ITEM]:TRACe[:ACTive] <State>**

**MMEemory:SElect[:ITEM]:TRACe[:ACTive] <State>**

This command includes or excludes trace data when storing or loading a configuration file.

**Parameters:**

<State> ON | OFF | 1 | 0

\*RST: 0, i.e. no traces are stored

**Example:** `MMEM:SEL:TRAC ON`

**Manual operation:** See " [Items:](#) " on page 509

**MMEemory:SElect:CHANnel[:ITEM]:TRANsducer:ALL <State>**

**MMEemory:SElect[:ITEM]:TRANsducer:ALL <State>**

This command includes or excludes transducer factors when storing or loading a configuration file.

**Parameters:**

<State> ON | OFF | 1 | 0

\*RST: 0

**Example:** `MMEM:SEL:TRAN:ALL ON`

**Manual operation:** See " [Items](#) " on page 509  
See " [Save](#) " on page 553

### 12.9.3 Storing and Loading Instrument Settings

See also:

- `INSTrument[:SElect]` on page 627 to select the channel.

|                                                      |     |
|------------------------------------------------------|-----|
| <code>MMEMory:CLEar:ALL</code> .....                 | 946 |
| <code>MMEMory:CLEar:STATe</code> .....               | 946 |
| <code>MMEMory:LOAD:AUTO</code> .....                 | 946 |
| <code>MMEMory:LOAD:STATe</code> .....                | 947 |
| <code>MMEMory:LOAD:TYPE</code> .....                 | 948 |
| <code>MMEMory:STORe&lt;n&gt;:STATe</code> .....      | 949 |
| <code>MMEMory:STORe&lt;n&gt;:STATe:NEXT</code> ..... | 949 |
| <code>MMEMory:STORe&lt;n&gt;:TYPE</code> .....       | 950 |
| <code>SYSTem:PRESet</code> .....                     | 950 |
| <code>SYSTem:PRESet:CHANnel[:EXEC]</code> .....      | 951 |

---

#### **MMEMory:CLEar:ALL**

This command deletes all instrument configuration files in the current directory.

You can select the directory with `MMEMory:CDIRectory`.

**Example:** `MMEM:CLE:ALL`

**Usage:** Event

---

#### **MMEMory:CLEar:STATe 1,<FileName>**

This command deletes an instrument configuration file.

**Parameters:**

1

<FileName> String containing the path and name of the file to delete.  
The string may or may not contain the file's extension.

**Example:** `MMEM:CLE:STAT 1, 'TEST'`

**Usage:** Event

---

#### **MMEMory:LOAD:AUTO 1, 'Factory' | <FileName>**

This command restores an instrument configuration and defines that configuration as the default state.

The default state is restored after a preset (`*RST`) or after you turn on the R&S FPS.

**Parameters:**

1

|                           |                                                                                                                                                                                                                                                                                                           |
|---------------------------|-----------------------------------------------------------------------------------------------------------------------------------------------------------------------------------------------------------------------------------------------------------------------------------------------------------|
| 'Factory'  <br><FileName> | <b>'Factory'</b><br>Restores the factory settings as the default state.<br><b>'&lt;file_name&gt;'</b><br>String containing the path and name of the configuration file.<br>Note that only <i>instrument</i> settings files can be selected for the startup recall function; channel files cause an error. |
| <b>Example:</b>           | MMEM:LOAD:AUTO 1, 'C:\R_S\INSTR\USER\TEST'                                                                                                                                                                                                                                                                |
| <b>Usage:</b>             | Event                                                                                                                                                                                                                                                                                                     |
| <b>Manual operation:</b>  | See " <a href="#">Startup Recall</a> " on page 511                                                                                                                                                                                                                                                        |

**MMEMory:LOAD:STATe 1, <FileName>**

This command restores and activates the instrument configuration stored in a \*.dfi file.

Note that files with other formats cannot be loaded with this command.

The contents that are reloaded from the file are defined by the last selection made either in the "Save/Recall" dialogs (manual operation) or through the MMEMory:SElect[:ITEM] commands (remote operation; the settings are identical in both cases).

By default, the selection is limited to the user settings ("User Settings" selection in the dialogs, HWSettings in SCPI). The selection is not reset by PRESET or \*RST.

As a consequence, the results of a SCPI script using the MMEMory:LOAD:STATe command without a previous MMEMory:SElect[:ITEM] command may vary, depending on previous actions in the GUI or in previous scripts, even if the script starts with the \*RST command.

It is therefore recommended that you use the appropriate MMEMory:SElect[:ITEM] command before using MMEMory:LOAD:STATe.

**Parameters:**

1

|            |                                                                                                                     |
|------------|---------------------------------------------------------------------------------------------------------------------|
| <FileName> | String containing the path and name of the file to load.<br>The string may or may not include the file's extension. |
|------------|---------------------------------------------------------------------------------------------------------------------|

**Example:**

```

MEM:SEL:ALL
//Save all items (User Settings, All Traces, All Limit Lines) from
the R&S FPS.
MEM:LOAD:STAT 1, 'C:\R_S\INSTR\USER\TEST01 '
//Reloads all items
In the "Recall" dialog, select only "User Settings" and "All Limit
Lines".
MEM:LOAD:STAT 1, 'C:\R_S\INSTR\USER\TEST01 '
//Reloads user settings and all limit lines.
*RST
//Reset instrument.
MEM:LOAD:STAT 1, 'C:\R_S\INSTR\USER\TEST01 '
//Selected items are retained. Reloads user settings and all limit
lines.
Restart the instrument.
(Switch the ON/OFF key off and on).
MEM:LOAD:STAT 1, 'C:\R_S\INSTR\USER\TEST01 '
// Selected items are set to default. Reloads only the user set-
tings.

```

**Manual operation:**

See " [Recall](#) " on page 506  
 See " [Recall in New Channel / Recall in Current Channel](#) "  
 on page 510

**MMEMory:LOAD:TYPE** <Mode>

This command defines whether the channels that will be loaded with the subsequent `MEM:LOAD:STAT` command will replace the current channel or activate a new channel.

**Parameters:**

&lt;Mode&gt;

NEW | REPLace

**NEW**

The loaded settings will be activated in a new channel.

**REPLace**

The loaded settings will replace the currently active channel.

\*RST: NEW

**Example:**

```

INST:SEL 'SPECTRUM2'
//Selects channel 'SPECTRUM2'.
MMEM:STOR:TYP CHAN
//Specifies that channel data is to be stored.
MMEM:STOR:STAT 1, 'C:\R_S\INSTR\USER\Spectrum'
//Stores the settings from channel
//'SPECTRUM2' to the file 'C:\R_S\INSTR\USER\Spectrum'.
MMEM:LOAD:TYPE NEW
//Specifies that channels are to be loaded
//in a new channel.
MMEM:LOAD:STAT 1, 'C:\R_S\INSTR\USER\Spectrum'
//Loads the channel from the file
//'C:\R_S\INSTR\USER\Spectrum' to the new channel
//'SPECTRUM2*'.

```

---

### MMEMory:STORe<n>:STATe 1,<FileName>

This command saves the current instrument configuration in a \*.df1 file.

#### Secure User Mode

In secure user mode, settings that are stored on the instrument are stored to volatile memory, which is restricted to 256 MB. Thus, a "memory limit reached" error can occur although the hard disk indicates that storage space is still available.

To store data permanently, select an external storage location such as a USB memory device.

For details, see [Chapter 4.1.6, "Protecting Data Using the Secure User Mode"](#), on page 33.

#### Suffix:

<n> irrelevant

#### Parameters:

1

<FileName> String containing the path and name of the target file.  
The file extension is .df1.

**Example:** MMEM:STOR:STAT 1, 'Save'  
Saves the current instrument settings in the file Save.dfl.

**Usage:** Event

**Manual operation:** See "[Save File](#)" on page 509  
See "[Save](#)" on page 553

---

### MMEMory:STORe<n>:STATe:NEXT

This command saves the current instrument configuration in a \*.df1 file.

The file name depends on the one you have set with [MMEMory:STORe<n>:STATe](#). This command adds a consecutive number to the file name.

### Secure User Mode

In secure user mode, settings that are stored on the instrument are stored to volatile memory, which is restricted to 256 MB. Thus, a "memory limit reached" error can occur although the hard disk indicates that storage space is still available.

To store data permanently, select an external storage location such as a USB memory device.

For details, see [Chapter 4.1.6, "Protecting Data Using the Secure User Mode"](#), on page 33.

#### Suffix:

<n> irrelevant

#### Example:

```
MMEM:STOR:STAT 1, 'Save'
```

Saves the current instrument settings in the file `Save.dfl`.

```
MMEM:STOR:STAT:NEXT
```

Saves the current instrument settings in the file `Save_001.dfl`

```
MMEM:STOR:STAT:NEXT
```

Saves the current instrument settings in the file `Save_002.dfl`

#### Usage:

Event

**Manual operation:** See "[Save File](#)" on page 509

### MMEMory:STORe<n>:TYPE <Mode>

This command defines whether the data from the entire instrument or only from the current channel is stored with the subsequent `MMEM:STOR...` command.

#### Suffix:

<n> irrelevant

#### Parameters:

<Mode> INSTRument | CHANnel

#### **INSTRument**

Stores data from the entire instrument.

#### **CHANnel**

Stores data from an individual channel.

```
*RST: INST
```

#### Example:

```
INST:SEL 'SPECTRUM2'
```

Selects channel 'SPECTRUM2'.

```
MMEM:STOR:TYPE CHAN
```

Specifies that channel data is to be stored.

### SYSTem:PRESet

This command presets the R&S FPS.

#### Example:

```
SYST:PRES
```

#### Usage:

Event

**SYSTem:PRESet:CHANnel[:EXEC]**

This command restores the default instrument settings in the current channel.

Use `INST:SEL` to select the channel.

For details see [Chapter 9.1, "Restoring the Default Instrument Configuration \(Preset\)"](#), on page 499.

**Example:**

```
INST:SEL 'Spectrum2'
Selects the channel for "Spectrum2".
SYST:PRESet:CHAN:EXEC
Restores the factory default settings to the "Spectrum2" channel.
```

**Usage:** Event

**Manual operation:** See ["Preset Channel"](#) on page 301

## 12.9.4 Storing or Printing Screenshots

### Useful commands to configure screenshots described elsewhere

- `MMEMoRY:NAME` on page 941

### Remote commands exclusive to configuring screenshots

|                                                                  |     |
|------------------------------------------------------------------|-----|
| <code>DISPlay:LOGO</code> .....                                  | 952 |
| <code>HCOPy:ABORt</code> .....                                   | 952 |
| <code>HCOPy:CONTEnt</code> .....                                 | 952 |
| <code>HCOPy:CMAP&lt;item&gt;:DEFault&lt;colors&gt;</code> .....  | 953 |
| <code>HCOPy:CMAP&lt;item&gt;:HSL</code> .....                    | 954 |
| <code>HCOPy:CMAP&lt;item&gt;:PDEFined</code> .....               | 954 |
| <code>HCOPy:DESTination&lt;device&gt;</code> .....               | 955 |
| <code>HCOPy:DEVice:COLor</code> .....                            | 955 |
| <code>HCOPy:DEVice:LANGUage&lt;device&gt;</code> .....           | 955 |
| <code>HCOPy[:IMMediate&lt;device&gt;]</code> .....               | 956 |
| <code>HCOPy[:IMMediate&lt;device&gt;]:NEXT</code> .....          | 956 |
| <code>HCOPy:ITEM:WINDow:TEXT</code> .....                        | 956 |
| <code>HCOPy:PAGE:COUNt:STATE</code> .....                        | 957 |
| <code>HCOPy:PAGE:MARGin&lt;device&gt;:BOTTom</code> .....        | 957 |
| <code>HCOPy:PAGE:MARGin&lt;device&gt;:LEFT</code> .....          | 957 |
| <code>HCOPy:PAGE:MARGin&lt;device&gt;:RIGHT</code> .....         | 958 |
| <code>HCOPy:PAGE:MARGin&lt;device&gt;:TOP</code> .....           | 958 |
| <code>HCOPy:PAGE:MARGin&lt;device&gt;:UNIT</code> .....          | 958 |
| <code>HCOPy:PAGE:ORientation&lt;device&gt;</code> .....          | 959 |
| <code>HCOPy:PAGE:WINDow&lt;device&gt;:CHANnel:STATE</code> ..... | 959 |
| <code>HCOPy:PAGE:WINDow&lt;device&gt;:COUNt</code> .....         | 960 |
| <code>HCOPy:PAGE:WINDow&lt;device&gt;:SCALE</code> .....         | 960 |
| <code>HCOPy:PAGE:WINDow&lt;device&gt;:STATE</code> .....         | 960 |
| <code>HCOPy:TDSTamp:STATE&lt;device&gt;</code> .....             | 961 |

|                                                   |     |
|---------------------------------------------------|-----|
| SYSTem:COMMunicate:PRINter:ENUMerate:FIRSt?.....  | 961 |
| SYSTem:COMMunicate:PRINter:ENUMerate[:NEXT]?..... | 962 |
| SYSTem:COMMunicate:PRINter:SELEct<device>.....    | 962 |

---

### DISPlay:LOGO <State>

Activates/deactivates the printout of the Rohde & Schwarz company logo at the top of each page.

#### Parameters:

<State>                    1 | 0 | ON | OFF  
                               **1 | ON**  
                               Logo is printed.  
                               **0 | OFF**  
                               Logo is not printed.  
                               \*RST:        1

**Example:**                DISP:LOGO OFF

**Manual operation:**    See " [Print Logo](#) " on page 518

---

### HCOPy:ABORt

This command aborts a running hardcopy output.

**Example:**                HCOP:ABOR

**Usage:**                 Event

---

### HCOPy:CONTent <ContType>

This command determines the type of content included in the printout.

This setting is independent of the printing device.



**Parameters:**

&lt;ContType&gt;

WINDows | HCOPy

**WINDows**

Includes only the selected windows in the printout. All currently active windows for the current channel (or "MultiView") are available for selection. How many windows are printed on a each page of the printout is defined by [HCOPy:PAGE:WINDow<device>:COUNT](#) on page 960.

This option is not available when copying to the clipboard

([HCOP:DEST 'SYST:COMM:CLIP'](#) or an image file (see [HCOPy:DEVIce:LANGUage<device>](#) on page 955).

If the destination is currently set to an image file or the clipboard, it is automatically changed to be a PDF file for the currently selected printing device.

**HCOPy**

Selects all measurement results displayed on the screen for the current channel (or "MultiView"): diagrams, traces, markers, marker lists, limit lines, etc., including the channel bar and status bar, for printout on a single page. Displayed items belonging to the software user interface (e.g. softkeys) are not included. The size and position of the elements in the printout is identical to the screen display.

```
*RST: HCOPy
```

**Example:**

```
HCOP:DEST1 'SYST:COMM:CLIP'
HCOP:CONT WIND
HCOP:DEST1?
//Result: 'MMEM'
HCOP:DEV:LANG1?
//Result: 'PDF'
```

"Print to clipboard" is automatically switched to "print to PDF file" when the contents are switched to "multiple windows".

**Manual operation:**

See " [Print Screenshot](#) " on page 517

See " [Print Multiple Windows](#) " on page 518

**HCOPy:CMAP<item>:DEFault<color>**

This command defines the color scheme for print jobs.

**Suffix:**

&lt;item&gt;

Selects the item for which the color scheme is to be defined. For more information see [Chapter 12.10.4.3, "CMAP Suffix Assignment"](#), on page 983.

<colors> 1...4  
 1  
 Current colors with a white background and a black grid.  
 2  
 Optimized colors.  
 3  
 Customized colors.  
 4  
 Current screen colors (setting for hardcopies).

**Example:** HCOPY:CMAP:DEF2  
 Selects the optimized color set for the color settings of a printout or a hardcopy.

**Usage:** Event

**Manual operation:** See "[Print Colors](#)" on page 542

#### HCOPY:CMAP<item>:HSL <Color>

This command selects the color for various screen elements in print jobs.

**Suffix:**  
 <item> Selects the item for which the color scheme is to be defined. For more information see [Chapter 12.10.4.3, "CMAP Suffix Assignment"](#), on page 983.

**Parameters:**  
 <Color> **hue**  
 tint  
**sat**  
 saturation  
**lum**  
 brightness  
 The value range is 0 to 1 for all parameters.

**Example:** HCOPY:CMAP2:HSL 0.3,0.8,1.0  
 Changes the grid color

**Manual operation:** See "[Defining User-specific Colors](#)" on page 543

#### HCOPY:CMAP<item>:PDEFined <Color>

This command selects a predefined color for various screen elements in print jobs.

**Suffix:**  
 <item> Selects the item for which the color scheme is to be defined. For more information see [Chapter 12.10.4.3, "CMAP Suffix Assignment"](#), on page 983.

**Parameters:**

<Color> BLACK | BLUE | BROWN | GREEN | CYAN | RED | MAGENTA |  
 YELLOW | WHITE | DGRAY | LGRAY | LBLUE | LGREEN |  
 LCYAN | LRED | LMAGENTA

**Example:**

HCOPY:CMAP2:PDEF GRE

**Manual operation:** See " [Predefined Colors](#) " on page 543

**HCOPY:DESTINATION<device> <Destination>**

This command selects the destination of a print job.

**Suffix:**

<device> 1 | 2  
 Printing device.

**Parameters:**

<Destination> **'MMEM'**  
 Sends the hardcopy to a file.  
 You can select the file name with [MMEMory:NAME](#).  
 You can select the file format with [HCOPY:DEVICE:LANGUage<device>](#).

**'SYST:COMM:PRIN'**  
 Sends the hardcopy to a printer.  
 You can select the printer with [SYSTEM:COMMunicate:PRINter:SElect<device>](#).

**'SYST:COMM:CLIP'**  
 Sends the hardcopy to the clipboard.  
 The format should be WEMF.  
 \*RST: 'SYST:COMM:CLIP'

**Manual operation:** See " [Destination](#) " on page 523

**HCOPY:DEVICE:COLOR <State>**

This command turns color printing on and off.

**Parameters:**

<State> **ON | 1**  
 Color printing

**OFF | 0**  
 Black and white printing

\*RST: 1

**Example:**

HCOPY:DEV:COL ON

**HCOPY:DEVICE:LANGUage<device> <Format>**

This command selects the file format for a print job.

**Suffix:**

<device> 1 | 2  
Printing device.

**Parameters:**

<Format> **GDI**  
Graphics Device Interface  
Default format for output to a printer configured under Windows.  
Must be selected for output to the printer interface.  
Can be used for output to a file. The printer driver configured under Windows is used to generate a printer-specific file format.

**BMP, JPG, PNG**

Data format for output to files only.

**Example:**

HCOP:DEV:LANG1 PNG

**Manual operation:** See "[Destination](#)" on page 523

**HCOPy[:IMMEDIATE<device>]**

This command initiates a print job.

If you are printing to a file, the file name depends on [MMEMory:NAME](#).

**Suffix:**

<device> 1 | 2  
Printing device.

**Usage:**

Event

**Manual operation:** See "[Print](#)" on page 521

**HCOPy[:IMMEDIATE<device>]:NEXT**

This command initiates a print job.

If you are printing to a file, the file name depends on [MMEMory:NAME](#). This command adds a consecutive number to the file name.

**Suffix:**

<device> 1 | 2  
Printing device.

**Usage:**

Event

**Manual operation:** See "[Print](#)" on page 521

**HCOPy:ITEM:WINDow:TEXT <Comment>**

This command defines a comment to be added to the printout.

**Parameters:**

<Comment> String containing the comment.

**Manual operation:** See "[Comment](#)" on page 518

**HCOPY:PAGE:COUNT:STATe** <State>

This command includes or excludes the page number for printouts consisting of multiple pages ([HCOPY:CONT WIND](#)).

**Parameters:**

<State>                    1 | 0 | ON | OFF  
                               **1 | ON**  
                               The page number is printed.  
                               **0 | OFF**  
                               The page number is not printed.  
 \*RST:                    1

**Example:**                    HCOPY:PAGE:COUN:STAT ON

**Manual operation:**    See "[Print Page Count](#)" on page 518

**HCOPY:PAGE:MARGin<device>:BOTTom** <Margin>

This command defines the margin at the bottom of the printout page on which no elements are printed. The margins are defined according to [HCOPY:PAGE:MARGin<device>:UNIT](#) on page 958.

**Suffix:**

<device>                    1 | 2  
                               Printing device.

**Parameters:**

<Margin>                    numeric value  
 \*RST:                    4.23 mm

**Example:**                    HCOPY:PAGE:MARG2:BOTT 2

**Manual operation:**    See "[Margins](#)" on page 525

**HCOPY:PAGE:MARGin<device>:LEFT** <Margin>

This command defines the margin at the left side of the printout page on which no elements are printed. The margins are defined according to [HCOPY:PAGE:MARGin<device>:UNIT](#) on page 958.

**Suffix:**

<device>                    1 | 2  
                               Printing device.

**Parameters:**

<Margin>                    numeric value  
 \*RST:                    4.23 mm

**Example:**                    HCOPY:PAGE:MARG2:LEFT 2

**Manual operation:**    See "[Margins](#)" on page 525

**HCOPY:PAGE:MARGIn<device>:RIGHT <Margin>**

This command defines the margin at the right side of the printout page on which no elements are printed. The margins are defined according to [HCOPY:PAGE:MARGIn<device>:UNIT](#) on page 958.

**Suffix:**

<device>            1 | 2  
Printing device.

**Parameters:**

<Margin>            numeric value  
\*RST:            4.23 mm

**Example:**            HCOPI:PAGE:MARG2:RIGH 2

**Manual operation:** See " Margins " on page 525

**HCOPY:PAGE:MARGIn<device>:TOP <Margin>**

This command defines the margin at the top of the printout page on which no elements are printed. The margins are defined according to [HCOPY:PAGE:MARGIn<device>:UNIT](#) on page 958.

**Suffix:**

<device>            1 | 2  
Printing device.

**Parameters:**

<Margin>            numeric value  
\*RST:            4.23 mm

**Example:**            HCOPI:PAGE:MARG2:TOP 2

**Manual operation:** See " Margins " on page 525

**HCOPY:PAGE:MARGIn<device>:UNIT <Unit>**

This command defines the unit in which the margins for the printout page are configured.

**Suffix:**

<device>            1 | 2  
Printing device.

**Parameters:**

<Unit>            MM | IN  
**MM**  
millimeters  
**IN**  
inches  
\*RST:            MM

**Example:** `HCOP:PAGE:MARG2:BOTT 2`

**Manual operation:** See "[Margins](#)" on page 525

**HCOPY:PAGE:ORIENTATION<device> <Orientation>**

The command selects the page orientation of the printout.

The command is only available if the output device is a printer or a PDF file.

**Suffix:**

<device> 1 | 2  
Printing device.

**Parameters:**

<Orientation> LANDscape | PORTrait  
\*RST: PORTrait

**Example:**

`HCOP:DEV:LANG1 PDF`  
`HCOP:PAGE:ORI2 LAND`

**Manual operation:** See "[Orientation](#)" on page 525

**HCOPY:PAGE:WINDOW<device>:CHANNEL:STATE <ChannelName>, <State>**

This command selects all windows of the specified channel to be included in the printout for [HCOPY:CONT WIND](#).

**Suffix:**

<device> 1 | 2  
Printing device.

**Parameters:**

<ChannelName> String containing the name of the channel.  
For a list of available channel types use [INSTRUMENT:LIST?](#) on page 625.

<State> 1 | 0 | ON | OFF  
**1 | ON**  
The channel windows are included in the printout.  
**0 | OFF**  
The channel windows are not included in the printout.  
\*RST: 1

**Example:**

`HCOPY:CONT WIND`  
`HCOPY:PAGE:WIND2:CHAN 'IQ Analyzer',0`  
`HCOPY:PAGE:WIND2:STAT 'IQ Analyzer','1',1`  
Prints only window 1 in the IQ Analyzer channel.

**Manual operation:** See "[Print Multiple Windows](#)" on page 518

**HCOPY:PAGE:WINDow<device>:COUNT <WinPerPage>**

This command defines how many windows are displayed on a single page of the printout for [HCOPY:CONT WIND](#).

**Suffix:**

<device>            1 | 2  
Printing device.

**Parameters:**

<WinPerPage>       integer  
\*RST:                1

**Example:**            HCOPY:PAGE:WIND2:COUNT 2

**Manual operation:** See " [Windows Per Page](#) " on page 525

**HCOPY:PAGE:WINDow<device>:SCALE <Mode>**

This command determines the scaling of the windows in the printout for [HCOPY:CONT WIND](#).

**Suffix:**

<device>            1 | 2  
Printing device.

**Parameters:**

<Mode>                1 | 0 | ON | OFF

**1 | ON**

Each window is scaled to fit the page size optimally, not regarding the aspect ratio of the original display. If more than one window is printed on one page (see [HCOPY:PAGE:WINDow<device>:COUNT](#) on page 960), each window is printed in equal size.  
("Size to fit")

**0 | OFF**

Each window is printed as large as possible while maintaining the aspect ratio of the original display.  
("Maintain aspect ratio")

\*RST:                1

**Example:**            HCOPY:PAGE:WIND2:SCALE 0

**Manual operation:** See " [Scaling](#) " on page 525

**HCOPY:PAGE:WINDow<device>:STATE <ChannelName>, <WindowName>,<State>**

This command selects the windows to be included in the printout for [HCOPY:CONT WIND](#).



**Suffix:**

<device> 1 | 2  
Printing device.

**Parameters:**

<ChannelName> String containing the name of the channel.  
For a list of available channel types use `INSTRument:LIST?` on page 625.

<WindowName> String containing the name of the existing window.  
By default, the name of a window is the same as its index.  
To determine the name and index of all active windows in the active channel, use the `LAYout:CATalog[:WINDow]?` query.

<State> 1 | 0 | ON | OFF  
**1 | ON**  
The window is included in the printout.  
**0 | OFF**  
The window is not included in the printout.  
\*RST: 1

**Example:** `HCOP:PAGE:WIND2:STAT 'IQ Analyzer','1',1`

**Manual operation:** See "[Print Multiple Windows](#)" on page 518

**HCOPy:TDSTamp:STATe<device> <State>**

This command includes or excludes the time and date in the printout.

**Suffix:**

<device> 1 | 2  
Printing device.

**Parameters:**

<State> 1 | 0 | ON | OFF  
**1 | ON**  
The time and date are printed.  
**0 | OFF**  
The time and date are not printed.  
\*RST: 1

**Manual operation:** See "[Print Date and Time](#)" on page 519

**SYSTem:COMMunicate:PRINter:ENUMerate:FIRSt?**

This command queries the name of the first available printer.

To query the name of other installed printers, use `SYSTem:COMMunicate:PRINter:ENUMerate[:NEXT]?`.

**Return values:**

<PrinterName> String containing the name of the first printer as defined in Windows.  
If the command cannot find a printer, it returns an empty string ('').

**Usage:** Query only

**Manual operation:** See " [Printer Name](#) " on page 523

**SYSTem:COMMunicate:PRINter:ENUMerate[:NEXT]?**

This command queries the name of available printers.

You have to use `SYSTem:COMMunicate:PRINter:ENUMerate:FIRSt?` for this command to work properly.

**Return values:**

<PrinterName> String containing the name of one printer as defined in Windows. To get a complete list of printers you have to send this query several times until no more printers could be found. In that case, the return value is an empty string (''). Further queries after the empty string result in an error.

**Usage:** Query only

**Manual operation:** See " [Printer Name](#) " on page 523

**SYSTem:COMMunicate:PRINter:SELEct<device> <PrinterName>**

This command selects the printer that processes jobs sent by the R&S FPS.

Use `HCOPY:DESTination<device>` to select another output destination.

**Suffix:**

<device> 1 | 2  
Printing device.

**Parameters:**

<PrinterName> String containing the printer name.  
Use

- `SYSTem:COMMunicate:PRINter:ENUMerate:FIRSt?` and
- `SYSTem:COMMunicate:PRINter:ENUMerate[:NEXT]?`

to query all available printers.

\*RST: NONE

**Manual operation:** See " [Printer Name](#) " on page 523

## 12.9.5 Storing Measurement Results

The following commands can be used to store the results of a measurement.

Useful commands for storing results described elsewhere:

- [FORMat \[ : DATA \]](#) on page 853

#### Remote commands exclusive to storing results:

|                                                          |     |
|----------------------------------------------------------|-----|
| <a href="#">FORMat:DEXPort:HEADer</a> .....              | 963 |
| <a href="#">FORMat:DEXPort:TRACes</a> .....              | 963 |
| <a href="#">MMEMory:STORe&lt;n&gt;:LIST</a> .....        | 963 |
| <a href="#">MMEMory:STORe&lt;n&gt;:PEAK</a> .....        | 964 |
| <a href="#">MMEMory:STORe&lt;n&gt;:SGRam</a> .....       | 965 |
| <a href="#">MMEMory:STORe&lt;n&gt;:SPECTrogram</a> ..... | 965 |
| <a href="#">MMEMory:STORe&lt;n&gt;:SPURious</a> .....    | 965 |
| <a href="#">MMEMory:STORe&lt;n&gt;:TRACe</a> .....       | 966 |

---

#### **FORMat:DEXPort:HEADer** <State>

If enabled, additional instrument and measurement settings are included in the header of the export file for result data. If disabled, only the pure result data from the selected traces and tables is exported.

See [Chapter 8.6.6, "Reference: ASCII File Export Format"](#), on page 495 for details.

#### Parameters:

<State>                    ON | OFF | 0 | 1  
 \*RST:                    1

**Manual operation:** See "[Include Instrument & Measurement Settings](#)" on page 491

---

#### **FORMat:DEXPort:TRACes** <Selection>

This command selects the data to be included in a data export file (see [MMEMory:STORe<n>:TRACe](#) on page 859).

#### Parameters:

<Selection>                **SINGLE**  
 Only a single trace is selected for export, namely the one specified by the [MMEMory:STORe<n>:TRACe](#) command.

**ALL**  
 Selects all active traces and result tables (e.g. Result Summary, marker peak list etc.) in the current application for export to an ASCII file.  
 The <trace> parameter for the [MMEMory:STORe<n>:TRACe](#) command is ignored.  
 \*RST:                    SINGLE

**Manual operation:** See "[Export all Traces and all Table Results](#)" on page 491

---

#### **MMEMory:STORe<n>:LIST** <FileName>

This command exports the SEM and spurious emission list evaluation to a file.

The file format is \*.dat.

### Secure User Mode

In secure user mode, settings that are stored on the instrument are stored to volatile memory, which is restricted to 256 MB. Thus, a "memory limit reached" error can occur although the hard disk indicates that storage space is still available.

To store data permanently, select an external storage location such as a USB memory device.

For details, see [Chapter 4.1.6, "Protecting Data Using the Secure User Mode"](#), on page 33.

#### Suffix:

<n> [Window](#)

#### Parameters:

<FileName> String containing the path and name of the target file.

#### Example:

MMEM:STOR:LIST 'test'  
Stores the current list evaluation results in the test.dat file.

**Manual operation:** See "[Saving the Result Summary \(Evaluation List\) to a File](#)" on page 235  
See "[Save Evaluation List](#)" on page 258

### MMEMory:STORe<n>:PEAK <FileName>

This command exports the marker peak list to a file.

### Secure User Mode

In secure user mode, settings that are stored on the instrument are stored to volatile memory, which is restricted to 256 MB. Thus, a "memory limit reached" error can occur although the hard disk indicates that storage space is still available.

To store data permanently, select an external storage location such as a USB memory device.

For details, see [Chapter 4.1.6, "Protecting Data Using the Secure User Mode"](#), on page 33.

#### Suffix:

<n> [Window](#)

#### Parameters:

<FileName> String containing the path,name and extension of the target file.

#### Example:

MMEM:STOR:PEAK 'test.dat'  
Saves the current marker peak list in the file test.dat.

**Usage:** Event

**Manual operation:** See "[Export Peak List](#)" on page 437

---

**MMEMory:STORe<n>:SGR**am <FileName>

**MMEMory:STORe<n>:SPECT**rogram <FileName>

This command exports spectrogram data to an ASCII file.

The file contains the data for every frame in the history buffer. The data corresponding to a particular frame begins with information about the frame number and the time that frame was recorded.

Note that, depending on the size of the history buffer, the process of exporting the data can take a while.

#### Secure User Mode

In secure user mode, settings that are stored on the instrument are stored to volatile memory, which is restricted to 256 MB. Thus, a "memory limit reached" error can occur although the hard disk indicates that storage space is still available.

To store data permanently, select an external storage location such as a USB memory device.

For details, see [Chapter 4.1.6, "Protecting Data Using the Secure User Mode"](#), on page 33.

#### Suffix:

<n> [Window](#)

#### Parameters:

<FileName> String containing the path and name of the target file.

#### Example:

MMEM:STOR:SGR 'Spectrogram'  
Copies the spectrogram data to a file.

**Manual operation:** See "[Export Trace to ASCII File](#)" on page 492  
See "[Export Trace to ASCII File](#)" on page 514

---

**MMEMory:STORe<n>:SPUR**ious <FileName>

This command exports the marker peak list available for spurious emission measurements to a file.

#### Secure User Mode

In secure user mode, settings that are stored on the instrument are stored to volatile memory, which is restricted to 256 MB. Thus, a "memory limit reached" error can occur although the hard disk indicates that storage space is still available.

To store data permanently, select an external storage location such as a USB memory device.

For details, see [Chapter 4.1.6, "Protecting Data Using the Secure User Mode"](#), on page 33.

#### Suffix:

<n> irrelevant

#### Parameters:

<FileName> String containing the path and name of the target file.

**Example:** `MMEM:STOR:SPUR 'test'`  
Saves the current marker peak list in the file test.dat.

**Usage:** Event

### **MMEMory:STORe<n>:TRACe <Trace>, <FileName>**

This command exports trace data from the specified window to an ASCII file.

For details on the file format see [Chapter 8.6.6, "Reference: ASCII File Export Format"](#), on page 495.

#### **Secure User Mode**

In secure user mode, settings that are stored on the instrument are stored to volatile memory, which is restricted to 256 MB. Thus, a "memory limit reached" error can occur although the hard disk indicates that storage space is still available.

To store data permanently, select an external storage location such as a USB memory device.

For details, see [Chapter 4.1.6, "Protecting Data Using the Secure User Mode"](#), on page 33.

#### **Suffix:**

<n> [Window](#)

#### **Setting parameters:**

<Trace> Number of the trace to be stored  
(This parameter is ignored if the option "Export all Traces and all Table Results" is activated in the Export configuration settings, see [FORMat:DEXPort:TRACes](#) on page 858).

<FileName> String containing the path and name of the target file.

**Example:** `MMEM:STOR1:TRAC 1, 'C:\TEST.ASC'`  
Stores trace 1 from window 1 in the file TEST.ASC.

**Usage:** Setting only

**Manual operation:** See "[Export Trace to ASCII File](#)" on page 492  
See "[Export Trace to ASCII File](#)" on page 514

## **12.9.6 Examples: Managing Data**

- [Storing Data](#)..... 967
- [Loading Data](#)..... 967
- [Storing Instrument Settings](#)..... 968
- [Loading Instrument Settings](#)..... 968
- [Printing to a File](#)..... 968
- [Printing on a Printer](#)..... 969

### 12.9.6.1 Storing Data

```

MMEM:MSIS 'C:'
//Selects drive C: as the default storage device.

//-----Connecting a network drive-----
MMEM:NETW:USED?
//Returns a list of all drives in use in the network.
MMEM:NETW:UNUS?
//Returns a list of free drive names in the network.
MMEM:NETW:MAP 'Q:', 'Server\ACLRTTest'
//Maps drive Q: to the directory 'Server\ACLRTTest'

//-----Saving data on the instrument-----
MMEM:MDIR 'C:\R_S\INSTR\USER\Results'
//Creates a directory called 'Results' on drive C:
MMEM:NAME 'C:\R_S\INSTR\USER\Results\Test001.txt'
//Defines a file called 'Test001.txt'
MMEM:COMM 'ACLRT test results'
//Creates a comment for the settings to be displayed in gui.
MMEM:DATA 'Test001.txt', #212FileContents
//Creates the file 'Test001.txt' and writes 12 characters to it

//-----Copying the data to another location---
MMEM:COPY 'C:\R_S\INSTR\USER\Results\Test001.txt', 'Q:'
//Copies the specified file to network drive Q:
MMEM:DEL 'C:\R_S\INSTR\USER\Results\Test001.txt'
//Deletes the specified file from the instrument hard disk.
//or
//MMEM:MOVE 'C:\R_S\INSTR\USER\Results\Test001.xml', 'Q:\TestResults.txt'//
//Moves the file 'Test001.txt' to drive Q:, renames it to 'Testresults.txt'
//and removes it from the instrument hard disk.
MMEM:RDIR 'C:\R_S\INSTR\USER\Results'
//Deletes the directory called 'Results' from drive C:, unless it still contains any content.

//-----Disconnecting the network drive---
MMEM:NETW:DISC 'Q:'
//Disconnect drive Q:

```

### 12.9.6.2 Loading Data

```

MMEM:CDIR?
//Returns the path of the current directory.
//e.g.
C:\R_S\Instr\user\
MMEM:CDIR 'C:\R_S\INSTR\USER\Results'
//Changes the current directory.
MMEM:CAT? 'C:\R_S\INSTR\USER\Results*.xml'
//or

```

```

MMEM:CAT? '*.xml'
//Returns a list of all xml files in the directory 'C:\R_S\INSTR\USER\Results'.
MMEM:CAT:LONG? '*.xml'
//Returns additional information about the xml files in the directory 'C:\R_S\INSTR\USER\Resu

```

### 12.9.6.3 Storing Instrument Settings

In this example we will store the instrument settings for the "Spectrum" channel.

```

INST:SEL 'SPECTRUM'
//Selects measurement channel 'SPECTRUM'.
MEMM:STOR:TYPE CHAN
//Specifies that channel-specific data is to be stored.
MMEM:STOR:STAT 1, 'C:\R_S\Instr\user\Spectrum'
//Stores the channel settings from the 'Spectrum' channel
// to the file 'Spectrum.dfl'.

```

### 12.9.6.4 Loading Instrument Settings

In this example we will load the hardware settings from the configuration file Spectrum.dfl to a new "Spectrum2" channel.

```

MEMM:LOAD:TYPE NEW
//Specifies that settings will be loaded to a new channel besides the existing
//'Spectrum' channel.
MMEM:SEL:CHAN:HWS ON
//Selects only hardware settings to be loaded.
MMEM:LOAD:STAT 1, 'C:\R_S\Instr\user\Spectrum'
//Loads the channel-specific settings from the file 'C:\R_S\Instr\user\Spectrum.dfl'
//to a new channel. The new channel is named 'Spectrum2' to avoid a naming conflict
//with the existing 'Spectrum' channel.
INST:REN 'Spectrum2','Spectrum3'
//Renames the loaded channel to 'Spectrum3'.

```

### 12.9.6.5 Printing to a File

```

HCOP:DEST 'MMEM'
//Prints the data to a file.
HCOP:DEV:LANG BMP
//Selects bmp as the file format.
MMEM:NAME 'C:\R_S\INSTR\USER\Screenshot.bmp'
//Selects the file name for the printout.
HCOP:ITEM:ALL
//Prints all screen elements
HCOP:ITEM:WIND:TEXT 'ACLRResults'
//Adds a comment to the printout.
HCOP
//Stores the printout in a file called 'Screenshot.bmp'.

```



```
HCOP:NEXT
//Stores the printout in a file called 'Screenshot_001.bmp'.
```

### 12.9.6.6 Printing on a Printer

```
HCOP:DEST2 'SYST:COMM:PRIN'
//Prints the data on a printer.
SYST:COMM:PRIN:ENUM:FIRS?
SYST:COMM:PRIN:ENUM?
//Returns the available printers, e.g.
'LASER on LPT1'
''
//Means that one printer is available.
SYST:COMM:PRIN:SEL2 'LASER on LPT1'
//Selects the printer for the print job on device 2.
HCOP:PAGE:ORI2 LAND
//Selects the landscape format for the printout.
HCOP:TDST:STAT2 ON
//Includes date and time on the printout.
HCOP:ITEM:ALL
//Prints all screen elements
HCOP
//Initiates the printout.
```

## 12.10 Configuring the R&S FPS

The remote commands required to set up the R&S FPS are described here.

- [Configuring the Reference Frequency](#)..... 969
- [Calibration and Checks](#)..... 971
- [Working with Transducers](#)..... 974
- [Customizing the Screen Layout](#)..... 978
- [Remote Commands for Language Settings](#)..... 984
- [Configuring the Network and Remote Control](#)..... 985
- [Checking the System Configuration](#)..... 989
- [Using Service Functions](#)..... 994

### 12.10.1 Configuring the Reference Frequency

```
SOURce:EXTErnal:ROSCillator:EXTErnal:FREQuency..... 969
[SENSe:]ROSCillator:SOURce..... 970
[SENSe:]ROSCillator:SOURce:EAUTo?..... 970
```

---

**SOURce:EXTErnal:ROSCillator:EXTErnal:FREQuency** <Frequency>

This command defines the frequency of the external reference oscillator.

If the external reference oscillator is selected, the reference signal must be connected to the rear panel of the instrument.

**Parameters:**

<Frequency>            Range:        1 MHz to 20 MHz

**Example:**

```
ROSC:EXT:FREQ 13MHZ
```

Sets the frequency to 13 MHz.

```
SOUR:EXT:ROSC:EXT:FREQ 13MHZ
```

**Manual operation:** See ["Reference Frequency Input"](#) on page 558

**[SENSe:]ROSCillator:SOURce <Source>**

This command selects the reference oscillator.

If you want to select the external reference, it must be connected to the R&S FPS.

**Parameters:**

<Source>

**INTernal**

The internal reference is used (10 MHz)

**EXTernal**

The external reference from REF INPUT 1..20 MHz connector is used with a variable frequency; if none is available, an error flag is displayed in the status bar

**E10**

The external reference from REF INPUT 1..20 MHz connector is used with a fixed 10 MHz frequency; if none is available, an error flag is displayed in the status bar

**EAUTO**

The external reference is used as long as it is available, then the instrument switches to the internal reference

**Example:**

```
ROSC:SOUR EXT
```

**Manual operation:** See ["Reference Frequency Input"](#) on page 558  
See ["Behavior in case of missing external reference"](#) on page 559

**[SENSe:]ROSCillator:SOURce:EAUTO?**

This command queries the current reference type in case you have activated an automatic switch to the internal reference if the external reference is missing.

**Parameters:**

<Reference>

**INT**

internal reference

**EXT**

external reference

**Example:**

```
SENS:ROSC:SOUR:EAUT?
```

Queries the currently available reference type.

**Usage:** Query only

**Manual operation:** See ["Behavior in case of missing external reference"](#) on page 559

## 12.10.2 Calibration and Checks

The following commands control calibration and checks on the R&S FPS.

|                                                                   |     |
|-------------------------------------------------------------------|-----|
| <a href="#">CALibration[:ALL]?</a> .....                          | 971 |
| <a href="#">CALibration:RESult?</a> .....                         | 971 |
| <a href="#">DIAGnostic:SERvice:INPut:PULSed:CFRequency</a> .....  | 972 |
| <a href="#">DIAGnostic:SERvice:INPut:PULSed:MCFRequency</a> ..... | 972 |
| <a href="#">DIAGnostic:SERvice:INPut:PULSed:WBFRequency</a> ..... | 972 |
| <a href="#">DIAGnostic:SERvice:INPut:RF[:SPEctrum]</a> .....      | 973 |
| <a href="#">DIAGnostic:SERvice:INPut[:SElect]</a> .....           | 973 |
| <a href="#">DIAGnostic:SERvice:STESt:RESult?</a> .....            | 974 |

---

### **CALibration[:ALL]?**

This command initiates a calibration (self-alignment) routine and queries if calibration was successful.

During the acquisition of correction data the instrument does not accept any remote control commands.

In order to recognize when the acquisition of correction data is completed, the MAV bit in the status byte can be used. If the associated bit is set in the Service Request Enable (SRE) register, the instrument generates a service request after the acquisition of correction data has been completed.

#### **Return values:**

<CalibrationState> **0**  
The command returns a '0' if calibration was successful.

#### **Example:**

```
*CLS
Resets the status management.
*SRE 16
Enables MAV bit in the Service Request Enable register.
*CAL?
Starts the correction data recording, and then a service request
is generated.
```

**Usage:** Query only

**Manual operation:** See ["Self align"](#) on page 44  
See [" Start Self Alignment "](#) on page 534

---

### **CALibration:RESult?**

This command returns the results collected during calibration.

**Return values:**

<CalibrationData> String containing the calibration data.

**Example:**

```
CAL:RES?
would return, e.g.
Total Calibration Status:
PASSED, Date (dd/mm/yyyy): 12/07/2004,
Time: 16:24:54, Runtime: 00.06
```

**Usage:**

Query only

**Manual operation:** See " [Alignment Results:](#) " on page 534

**DIAGnostic:SERVice:INPut:PULSed:CFrequency** <Frequency>

This command defines the frequency of the calibration signal.

Before you can use the command, you have to feed in a calibration signal with [DIAGnostic:SERVice:INPut\[:SElect\]](#).

**Parameters:**

<Frequency> Possible frequencies of the calibration signal are fix. If you define a frequency that is not available, the R&S FPS uses the next available frequency. Example: a frequency of 20 MHz is rounded up to the next available frequency (21.33 MHz).

\*RST: 64 MHz  
Default unit: Hz

**Manual operation:** See " [Calibration Frequency RF](#) " on page 569

**DIAGnostic:SERVice:INPut:PULSed:MCFrequency** <Frequency>

This command sets the calibration frequency for frequencies greater than 7 GHz. This command only takes effect if a microwave calibration signal is selected for input ([DIAGnostic:SERVice:INPut\[:SElect\]](#) on page 973).

**Parameters:**

<Frequency> <numeric value>

\*RST: 7 GHz

**Example:** DIAG:SERV:INP:PULS:MCFR 7,1 GHz

**Manual operation:** See " [Calibration Frequency MW](#) " on page 570

**DIAGnostic:SERVice:INPut:PULSed:WBFrequency** <Frequency>

Defines the frequency of the internal broadband calibration signal to be used for IF filter calibration.

This command is only available if the bandwidth extension option R&S FPS-B160 is installed.

Before you can use the command, you have to feed in a calibration signal with [DIAGnostic:SERVice:INPut\[:SElect\]](#) on page 973.

**Parameters:**

<Frequency> 2 MHz | 4 MHz | 8 MHz | 16 MHz

If you define a frequency that is not available, the R&S FPS uses the next available frequency.

\*RST: 16 MHz

**Example:**

DIAG:SERV:INP:PULS:WBFR 8 MHz

Defines a calibration signal frequency of 8 MHz.

**Example:**

DIAG:SERV:INP:SEL WBC

DIAG:SERV:INP:PULS:WBFR 4MHz

**Manual operation:** See "[Calibration Frequency Wideband](#)" on page 570

**DIAGnostic:SERVice:INPut:RF[:SPECTrum]** <Bandwidth>

This command selects the bandwidth of the calibration signal.

**Parameters:**

<Bandwidth> **NARRowband**

Narrowband signal for power calibration of the frontend.

**BROadband**

Broadband signal for calibration of the IF filter.

**Manual operation:** See "[Spectrum](#)" on page 570

**DIAGnostic:SERVice:INPut[:SElect]** <Signal>

This command activates or deactivates the use of an internal calibration signal as input for the R&S FPS.

**Parameters:**

<Signal> **CALibration**

Uses the calibration signal as RF input.

**MCALibration**

Uses the calibration signal for the microwave range as RF input.

**RF**

Uses the signal from the RF input.

**WBCal**

Uses the wideband calibration signal (requires bandwidth extension option R&S FPS-B160)

\*RST: RF

**Example:**

DIAG:SERV:INP CAL

Uses the calibration signal as RF input.

**Manual operation:** See " [NONE](#) " on page 569  
 See " [Calibration Frequency RF](#) " on page 569  
 See " [Calibration Frequency MW](#) " on page 570  
 See " [Calibration Frequency Wideband](#) " on page 570

---

#### DIAGnostic:SERVice:STES:RESult?

This command queries the self-test results.

#### Return values:

<Results> String of data containing the results.  
 The rows of the self-test result table are separated by commas.

#### Example:

```
DIAG:SERV:STES:RES?
would return, e.g.
"Total Selftest Status:
PASSED", "Date (dd/mm/yyyy): 09/07/2004 TIME:
16:24:54", "Runtime: 00:06", "...
```

**Usage:** Query only

**Manual operation:** See "[Selftest](#)" on page 44

### 12.10.3 Working with Transducers

The following commands configure and control transducer factors.

#### Useful commands for transducer management described elsewhere

- [MMEMoRY:SElect\[:ITEM\]:TRANsdUcer:ALL](#) on page 945

#### Remote commands exclusive to transducer management

|                                                                           |     |
|---------------------------------------------------------------------------|-----|
| <a href="#">[SENSe:]CORRection:TRANsdUcer:ADJust:RLEVel[:STATe]</a> ..... | 974 |
| <a href="#">[SENSe:]CORRection:TRANsdUcer:CATalog?</a> .....              | 975 |
| <a href="#">[SENSe:]CORRection:TRANsdUcer:COMMeNt</a> .....               | 975 |
| <a href="#">[SENSe:]CORRection:TRANsdUcer:DATA</a> .....                  | 976 |
| <a href="#">[SENSe:]CORRection:TRANsdUcer:DELeTe</a> .....                | 976 |
| <a href="#">[SENSe:]CORRection:TRANsdUcer:SCALing</a> .....               | 976 |
| <a href="#">[SENSe:]CORRection:TRANsdUcer:SElect</a> .....                | 977 |
| <a href="#">[SENSe:]CORRection:TRANsdUcer[:STATe]</a> .....               | 977 |
| <a href="#">[SENSe:]CORRection:TRANsdUcer:UNIT</a> .....                  | 977 |
| <a href="#">MMEMoRY:LOAD&lt;n&gt;:TFACtor</a> .....                       | 978 |
| <a href="#">MMEMoRY:STORe&lt;n&gt;:TFACtor</a> .....                      | 978 |

---

#### [\[SENSe:\]CORRection:TRANsdUcer:ADJust:RLEVel\[:STATe\]](#) <State>

This command turns an automatic adjustment of the reference level to the transducer on and off.

Before you can use the command, you have to select and turn on a transducer.

**Parameters:**

<State> ON | OFF | 1 | 0  
 \*RST: 0

**Manual operation:** See "[Adjust Ref Level](#)" on page 550

**[SENSe:]CORRection:TRANsducer:CATalog?**

This command queries all transducer factors stored on the R&S FPS.

After general data for the transducer storage directory, data for the individual files is listed.

The result is a comma-separated list of values with the following syntax:

<UsedMem>,<FreeMem>,<FileSize>,<FileName>[,<FileSize>,<FileName>]

For details see [Chapter 10.3.1, "Basics on Transducer Factors"](#), on page 546.

**Return values:**

<UsedMem> numeric value in bytes  
 Amount of storage space required by all transducers files in the  
 C:\R\_S\INSTR\trd directory (= sum of all individual <File-  
 Size> values)

<FreeMem> numeric value in bytes  
 Amount of free storage space on the R&S FPS

<FileSize> numeric value in bytes  
 Size of a single transducer file

<FileName> string  
 Name of a single transducer file

**Example:**

```
SENSE:CORR:TRAN:CAT?
//Result: 2743,2312620544,720,'FactorGSM.TDF',2023,'FactorBTS.TDF'
```

**Usage:** Query only

**[SENSe:]CORRection:TRANsducer:COMMeNT <Comment>**

This command defines the comment for the selected transducer factor.

Before you can use the command, you have to select and turn on a transducer.

**Parameters:**

<Comment> \*RST: (empty comment)

**Manual operation:** See "[Comment](#)" on page 552

**[SENSe:]CORRection:TRANsducer:DATA**

<Frequency>,<Level>[,<Frequency>,<Level>]

This command configures transducer factors for specific trace points. A set of transducer factors defines an interpolated transducer line and can be stored on the instrument.

For details see [Chapter 10.3.1, "Basics on Transducer Factors"](#), on page 546.

**Parameters:**

<Frequency>            The unit for <Frequency> is Hz, which may or may not be omitted. Frequencies have to be sorted in ascending order.

<Level>                The unit for <Level> depends on [\[SENSe:\]CORRection:TRANsducer:UNIT](#).

**Example:**

```
SENSe1:CORRection:TRANsducer:UNIT 'DB'
// Frequency Span 0 Hz to 4 Ghz
SENSe1:CORRection:TRANsducer:DATA 0,8,2e6,5,4GHz,3
```

Creates the transducer points:

**Manual operation:** See "[Data Points](#)" on page 552

| Frequency | Level |
|-----------|-------|
| 0 Hz      | 8 dB  |
| 2 GHz     | 5 dB  |
| 4 GHz     | 3 dB  |

**[SENSe:]CORRection:TRANsducer:DELeTe**

This command deletes the currently selected transducer factor.

Before you can use the command, you have to select a transducer.

**Example:**            CORR:TRAN:DEL

**Usage:**              Event

**Manual operation:** See "[Delete Line](#)" on page 551

**[SENSe:]CORRection:TRANsducer:SCALing <ScalingType>**

This command selects the frequency scaling of the transducer factor.

**Parameters:**

<ScalingType>        LINear | LOGarithmic  
\*RST:                LINear

**Manual operation:** See "[X-Axis Scaling](#)" on page 552



**[SENSe:]CORRection:TRANsducer:SElect** <Name>

This command selects a transducer factor.

**Parameters:**

<Name> String containing the name of the transducer factor.  
If the name does not exist yet, the R&S FPS creates a transducer factor by that name.

**Example:** `CORR:TRAN:SEL 'FACTOR1'`

**Manual operation:** See "[Activating / Deactivating](#)" on page 550  
See "[Create New Line](#)" on page 550  
See "[Name](#)" on page 551

**[SENSe:]CORRection:TRANsducer[:STATe]** <State>

This command turns the selected transducer factor on or off.

Before you can use the command, you have to select a transducer.

**Parameters:**

<State> ON | OFF | 1 | 0  
\*RST: 0

**Manual operation:** See "[Activating / Deactivating](#)" on page 550

**[SENSe:]CORRection:TRANsducer:UNIT** <Unit>

This command selects the unit of the transducer factor.

Before you can use the command, you have to select and turn on a transducer.

**Parameters:**

<Unit> string as defined in table below  
\*RST: DB

**Example:** `CORR:TRAN:UNIT 'DBUV'`

**Manual operation:** See "[Unit](#)" on page 552

| String   | Unit         |
|----------|--------------|
| 'DB'     | dB           |
| 'DBM'    | dBm          |
| 'DBMV'   | dBmV         |
| 'DBUV'   | dB $\mu$ V   |
| 'DBUV/M' | dB $\mu$ V/m |
| 'DBUA'   | dB $\mu$ A   |
| 'DBUA/M' | dB $\mu$ A/m |

| String | Unit |
|--------|------|
| 'DBPW' | dBpW |
| 'DBPT' | dBpT |

---

**MMEMory:LOAD<n>:TFACTOR <FileName>**

Loads the transducer factor from the selected file in .CSV format.

**Suffix:**

<n> irrelevant

**Parameters:**

<FileName> String containing the path and name of the CSV import file.

**Example:** `MMEM:LOAD:TFAC 'C:\TEST.CSV'`

**Manual operation:** See " [Import](#) " on page 553

---

**MMEMory:STORe<n>:TFACTOR <FileName>,<TransdName>**

This command exports transducer factor data to an ASCII (CSV) file.

For details on the file format see [Chapter 10.3.3, "Reference: Transducer Factor File Format"](#), on page 553.

**Suffix:**

<n> irrelevant

**Parameters:**

<FileName> String containing the path and name of the target file.

<TransdName> Name of the transducer factor to be exported.

**Example:** `MMEM:STOR:TFAC 'C:\TEST', 'Transducer1'`  
Stores the transducer factor named "Transducer1" in the file TEST.CSV.

**Manual operation:** See " [Export](#) " on page 553

## 12.10.4 Customizing the Screen Layout

The remote commands required to set up the display of the R&S FPS are described here.

- [General Display Settings and Items](#).....979
- [Colors and Themes](#).....981
- [CMAP Suffix Assignment](#).....983

### 12.10.4.1 General Display Settings and Items

The following commands add, remove or customize general display and screen elements.

#### Useful commands for general display settings described elsewhere

- `DISPlay[:WINDow<n>]:MTABle` on page 868

#### Remote commands exclusive to general display settings

|                                                  |     |
|--------------------------------------------------|-----|
| <code>DISPlay:ANNotation:CBAR</code> .....       | 979 |
| <code>DISPlay:ANNotation:FREQuency</code> .....  | 979 |
| <code>DISPlay:SBAR[:STATe]</code> .....          | 979 |
| <code>DISPlay:SKEYs[:STATe]</code> .....         | 980 |
| <code>DISPlay:TBAR[:STATe]</code> .....          | 980 |
| <code>DISPlay[:WINDow]:TIME</code> .....         | 980 |
| <code>DISPlay[:WINDow]:TIME:FORMat</code> .....  | 980 |
| <code>SYSTem:DISPlay:FPANel[:STATe]</code> ..... | 981 |

---

#### `DISPlay:ANNotation:CBAR <State>`

This command hides or displays the channel bar information.

##### Parameters:

`<State>` ON | OFF | 0 | 1  
 \*RST: 1

**Example:** `DISP:ANN:CBAR OFF`

**Manual operation:** See " [Channel Bar](#) " on page 538

---

#### `DISPlay:ANNotation:FREQuency <State>`

This command turns the label of the x-axis on and off.

##### Parameters:

`<State>` ON | OFF | 0 | 1  
 \*RST: 1

**Example:** `DISP:ANN:FREQ OFF`

**Manual operation:** See " [Diagram Footer \(Annotation\)](#) " on page 538

---

#### `DISPlay:SBAR[:STATe] <State>`

This command turns the status bar on and off.

##### Parameters:

`<State>` ON | OFF | 0 | 1  
 \*RST: 1

**Example:** `DISP:SBAR:OFF`

**Manual operation:** See "[Status Bar](#)" on page 537

#### **DISPlay:SKEYs[:STATe] <State>**

This command turns the softkey bar on and off.

**Parameters:**

<State>            ON | OFF | 0 | 1  
 \*RST:            1

**Example:**            DISP:SKEY:OFF

**Manual operation:** See "[Softkey Bar](#)" on page 538

#### **DISPlay:TBAR[:STATe] <State>**

This command turns the toolbar on or off.

**Parameters:**

<State>            ON | OFF | 1 | 0  
 \*RST:            0

**Example:**            DISP:TOOL ON

**Manual operation:** See "[Toolbar](#)" on page 537

#### **DISPlay[:WINDow]:TIME <State>**

This command adds or removes the date and time from the display.

**Parameters:**

<State>            ON | OFF | 1 | 0  
 \*RST:            0

**Example:**            DISP:TIME ON

**Manual operation:** See "[Date and Time](#)" on page 538

#### **DISPlay[:WINDow]:TIME:FORMat <Format>**

This command selects the time and date format.

**Parameters:**

<Format>            **DE**  
                       dd.mm.yyyy hh:mm:ss  
                       24 hour format.  
                       **US**  
                       mm/dd/yyyy hh:mm:ss  
                       12 hour format.  
 \*RST:            DE

**Example:**            `DISP:TIME ON`  
                          Switches the screen display of date and time on.  
                          `DISP:TIME:FORM US`  
                          Switches the date and time format to US.

**Manual operation:** See " [Date and Time Format](#) " on page 536

#### **SYSTem:DISPlay:FPANel[:STATe] <State>**

This command includes or excludes the front panel keys when working with the remote desktop.

**Parameters:**

<State>                `ON | OFF | 0 | 1`  
                          `*RST:        1`

**Manual operation:** See " [Front Panel](#) " on page 538  
                          See " [Mini Front Panel](#) " on page 539

### 12.10.4.2 Colors and Themes

#### **Useful commands to customize display colors described elsewhere**

The HCOPY commands define the print colors and thus only take effect on the display colors, if the display shows the printing colors.

- `HCOPY:CMAP<item>:DEFault<color>` on page 953
- `HCOPY:CMAP<item>:HSL` on page 954
- `HCOPY:CMAP<item>:PDEFined` on page 954

#### **Remote commands exclusive to customize the display colors and themes**

|                                                                  |     |
|------------------------------------------------------------------|-----|
| <code>DISPlay:CMAP&lt;item&gt;:DEFault&lt;color&gt;</code> ..... | 981 |
| <code>DISPlay:CMAP&lt;item&gt;:HSL</code> .....                  | 982 |
| <code>DISPlay:CMAP&lt;item&gt;:PDEFined</code> .....             | 982 |
| <code>DISPlay:THEMe:CATalog?</code> .....                        | 983 |
| <code>DISPlay:THEMe:SElect</code> .....                          | 983 |

#### **DISPlay:CMAP<item>:DEFault<color>**

This command resets the color scheme for the display.

**Suffix:**

<item>                Selects the item for which the color scheme is to be defined.  
                          For more information see [Chapter 12.10.4.3, "CMAP Suffix Assignment"](#), on page 983.

|          |                                                          |
|----------|----------------------------------------------------------|
| <colors> | 1...4                                                    |
|          | 1                                                        |
|          | Current colors with a white background and a black grid. |
|          | 2                                                        |
|          | Optimized colors.                                        |
|          | 3                                                        |
|          | Customized colors.                                       |
|          | 4                                                        |
|          | Current screen colors (setting for hardcopies).          |

**Example:** `DISP:CMAP:DEF2`  
Selects default setting 2 for setting the colors.

**Usage:** Event

**Manual operation:** See " [Screen Colors](#) " on page 541

### **DISPlay:CMAP<item>:HSL <hue>, <sat>, <lum>**

This command selects the color for various screen elements in the display.

**Suffix:**

<item> Selects the item for which the color scheme is to be defined.  
For more information see [Chapter 12.10.4.3, "CMAP Suffix Assignment"](#), on page 983.

**Parameters:**

|       |               |
|-------|---------------|
| <hue> | tint          |
|       | Range: 0 to 1 |
| <sat> | saturation    |
|       | Range: 0 to 1 |
| <lum> | brightness    |
|       | Range: 0 to 1 |

**Example:** `DISP:CMAP2:HSL 0.3,0.8,1.0`  
Changes the grid color.

### **DISPlay:CMAP<item>:PDEFined <Color>**

This command selects a predefined color for various screen elements.

**Suffix:**

<item> Selects the item for which the color scheme is to be defined.  
For more information see [Chapter 12.10.4.3, "CMAP Suffix Assignment"](#), on page 983.

**Parameters:**

|         |                                                                                                                                       |
|---------|---------------------------------------------------------------------------------------------------------------------------------------|
| <Color> | BLACK   BLUE   BROWN   GREEN   CYAN   RED   MAGenta  <br>YELLOW   WHITE   DGRAY   LGRAY   LBLUE   LGREEN  <br>LCYan   LRED   LMAGenta |
|---------|---------------------------------------------------------------------------------------------------------------------------------------|

**Example:** `DISP:CMAP2:PDEF GRE`

**Manual operation:** See ["Restoring the User Settings to Default Colors"](#) on page 544

---

### DISPlay:THEMe:CATalog?

This command queries all available display themes.

**Return values:**

<Themes> String containing all available display themes.

**Example:** DISP:THEMe:CAT?

**Usage:** Query only

---

### DISPlay:THEMe:SElect <Theme>

This command selects the display theme.

**Parameters:**

<Theme> String containing the name of the theme.  
\*RST: SPL

**Example:** DISP:THEM:SEL "OceanBlue"

**Manual operation:** See [" Theme "](#) on page 541

#### 12.10.4.3 CMAP Suffix Assignment

Several commands to change the color settings of individual items of the display or printout are available. Which item is to be configured is defined using a <CMAP> suffix. The following assignment applies:

| Suffix   | Description                     |
|----------|---------------------------------|
| CMAP1    | Background                      |
| CMAP2    | Grid                            |
| CMAP3 *) | Common Text                     |
| CMAP4 *) | Check Status OK                 |
| CMAP5 *) | Check Status Error              |
| CMAP6 *) | Text Special 1                  |
| CMAP7 *) | Text Special 2                  |
| CMAP8    | Trace 1                         |
| CMAP9    | Trace 2                         |
| CMAP10   | Trace 3                         |
| CMAP11   | Marker Info Text                |
| CMAP12   | Limit Lines                     |
| CMAP13   | Limit and Margin Check – "Pass" |

| Suffix    | Description                          |
|-----------|--------------------------------------|
| CMAP14    | Limit and Margin Check – "Fail"      |
| CMAP15 *) | Softkey Text                         |
| CMAP16 *) | Softkey Background                   |
| CMAP17 *) | Selected Field Text                  |
| CMAP18 *) | Selected Field Background            |
| CMAP19 *) | Softkey 3D Bright Part               |
| CMAP20 *) | Softkey 3D Dark Part                 |
| CMAP21 *) | Softkey State "On"                   |
| CMAP22 *) | Softkey State "Dialog open"          |
| CMAP23 *) | Softkey Text Disabled                |
| CMAP24    | Logo                                 |
| CMAP25    | Trace 4                              |
| CMAP26    | Grid – Minorlines                    |
| CMAP27    | Marker                               |
| CMAP28    | Display Lines                        |
| CMAP29 *) | Sweepcount – Text                    |
| CMAP30    | Limit and Margin Check – Text        |
| CMAP31    | Limit and Margin Check – \\"Margin\" |
| CMAP32 *) | Table Overall – Title Text           |
| CMAP33 *) | Table Overall – Title Background     |
| CMAP34 *) | Table Overall – Text                 |
| CMAP35 *) | Table Overall – Background           |
| CMAP36 *) | Table Value – Title Text             |
| CMAP37 *) | Table Value – Title Background       |
| CMAP38 *) | Table Value – Text                   |
| CMAP39 *) | Table Value – Background             |
| CMAP40    | Trace 5                              |
| CMAP41    | Trace 6                              |

\*) these settings can only be defined via the theme (`DISPlay:THEMe:SElect`) and are thus ignored in the SCPI command

### 12.10.5 Remote Commands for Language Settings

`SYSTem:DISPlay:LANGUage`.....985



**SYSTem:DISPlay:LANGuage** <Language>

Defines the language of the software-defined interface elements (such as softkeys, dialog boxes, diagram texts etc.).

**Parameters:**

<Language>            'EN' | 'ZH\_CH' | 'ZH\_TW' | 'JA' | 'KO' | 'RU'  
                           '**ZH\_CH**'  
                           Simplified Chinese  
                           '**ZH\_TW**'  
                           Traditional Chinese  
 \*RST:                'EN'

**Example:**

SYST:DISP:LANG 'JA'  
 Switches the language of the instrument to Japanese.

**12.10.6 Configuring the Network and Remote Control**

The following commands are required to configure a network or remote control for the R&S FPS.

**Remote commands exclusive to configuring a network and remote control**

|                                                 |     |
|-------------------------------------------------|-----|
| SYSTem:COMMunicate:GPIB[:SELF]:ADDRess.....     | 985 |
| SYSTem:COMMunicate:GPIB[:SELF]:RTERminator..... | 985 |
| SYSTem:DISPlay:UPDate.....                      | 986 |
| SYSTem:ERRor:DISPlay.....                       | 986 |
| SYSTem:IDENtify:FACTory.....                    | 987 |
| SYSTem:IDENtify[:STRing].....                   | 987 |
| SYSTem:KLOCK.....                               | 987 |
| SYSTem:LXI:INFO?.....                           | 987 |
| SYSTem:LXI:LANReset.....                        | 988 |
| SYSTem:LXI:MDEscription.....                    | 988 |
| SYSTem:LXI:PASSword.....                        | 988 |
| SYSTem:REVisiOn:FACTory.....                    | 988 |

**SYSTem:COMMunicate:GPIB[:SELF]:ADDRess** <Address>

This command sets the GPIB address of the R&S FPS.

**Parameters:**

<Address>            Range:        0 to 30  
                           \*RST:        (no influence on this parameter, factory default 20)

**Example:**

SYST:COMM:GPIB:ADDR 18

**Manual operation:** See "[GPIB Address](#)" on page 46

**SYSTem:COMMunicate:GPIB[:SELF]:RTERminator** <Terminator>

This command selects the GPIB receive terminator.

Output of binary data from the instrument to the control computer does not require such a terminator change.

**Parameters:**

<Terminator> LFEOI | EOI

**LFEOI**

According to the standard, the terminator in ASCII is <LF> and/or <EOI>.

**EOI**

For binary data transfers (e.g. trace data) from the control computer to the instrument, the binary code used for <LF> might be included in the binary data block, and therefore should not be interpreted as a terminator in this particular case. This can be avoided by using only the receive terminator EOI.

\*RST: LFEOI

**Example:**

SYST:COMM:GPIB:RTER EOI

**Manual operation:** See "[GPIB Terminator](#)" on page 609

**SYSTem:DISPlay:UPDate <State>**

This command turns the display during remote operation on and off.

If on, the R&S FPS updates the diagrams, traces and display fields only.

The best performance is obtained if the display is off during remote control operation.

**Parameters:**

<State> ON | OFF | 1 | 0

\*RST: 0

**Example:**

SYST:DISP:UPD ON

**Manual operation:** See "[Remote Display Update](#)" on page 609

**SYSTem:ERRor:DISPlay <State>**

This command the error display during remote operation on and off.

If activated, the R&S FPS displays a message box at the bottom of the screen that contains the most recent type of error and the command that caused the error.

**Parameters:**

<State> ON | OFF | 1 | 0

\*RST: 0

**Example:**

SYST:ERR:DISP ON

**Manual operation:** See "[Display Remote Errors](#)" on page 609

---

**SYSTem:IDENtify:FACTory**

This command resets the query to \*IDN? to its default value.

**Usage:** Event

**Manual operation:** See "Reset to Factory String" on page 608

---

**SYSTem:IDENtify[:STRing] <String>**

This command defines the response to \*IDN?.

**Parameters:**

<String> String containing the description of the instrument.

**Manual operation:** See "Identification String" on page 608

---

**SYSTem:KLOCK <State>**

This command activates the local lockout (remote control) or returns to the local mode.

**Parameters:**

<State>           **ON**  
                    LLO (local lockout)  
**OFF**  
                    GTL (go to local)  
                    \*RST:     OFF

**Example:**           SYST:KLOCK ON  
                    Activates LLO (remote control)

**Manual operation:** See "Local" on page 616

---

**SYSTem:LXI:INFO?**

This command queries the LXI settings.

**Return values:**

<LXIInfo>           <current version> | <LXI class> | <Computername> |  
                    <MAC adress> | <IP adress> | <Auto MDIX>  
                    String containing the current LXI parameters.  
                    • <version>  
                    • <LXIclass>  
                    • <ComputerName>  
                    • <MACAddress>  
                    • <IPAddress>  
                    • <AutoMDIX>

**Usage:** Query only

**Manual operation:** See "Current LXI Configuration" on page 613

---

---

**SYSTem:LXI:LANReset**

This command resets the LAN configuration as required by the LXI standard. The command also resets the LXI password and instrument description.

**Usage:** Event

**Manual operation:** See "[LAN Reset](#)" on page 44

---

**SYSTem:LXI:MDEscription <Description>**

This command defines the LXI instrument description.

**Parameters:**

<Description> String containing the instrument description.

**Manual operation:** See "[LXI Manufacturer Description](#)" on page 614

---

**SYSTem:LXI:PASSword <Password>**

This command defines the LXI password.

**Parameters:**

<Password> String containing the password.

**Return values:**

<Password> The query returns the current password.

**Manual operation:** See "[LXI Password](#)" on page 613

---

**SYSTem:REVision:FACTory**

Resets the response to the REV? query to the default value, e.g. after a user string was defined using the [SYSTem:REVision\[:STRing\]](#) command. (REV? query available for HP emulation only, see [SYSTem:LANGuage](#) on page 1002.)

**Example:**

Define the system language:

```
SYST:LANG '8563E'
```

Set the response back to factory setting:

```
SYS:REV:FACT
```

Query the revision:

```
REV?
```

Response:

```
920528
```

**Usage:** Event

**Manual operation:** See "[Resetting the Factory Revision](#)" on page 612

## 12.10.7 Checking the System Configuration

The following commands are required to check the system configuration on the R&S FPS.

Useful commands for obtaining system information described elsewhere:

- `DIAGnostic:SERVice:SINfo?` on page 995

### Remote commands exclusive to obtaining system information:

|                                                 |     |
|-------------------------------------------------|-----|
| <code>DIAGnostic:INFO:CCOunt?</code> .....      | 989 |
| <code>DIAGnostic:SERVice:BIOSinfo?</code> ..... | 990 |
| <code>DIAGnostic:SERVice:HWINfo?</code> .....   | 990 |
| <code>DIAGnostic:SERVice:VERSinfo?</code> ..... | 990 |
| <code>SYSTem:ERRor:CLEar:ALL</code> .....       | 991 |
| <code>SYSTem:ERRor:CLEar:REMOte</code> .....    | 991 |
| <code>SYSTem:ERRor:EXTended?</code> .....       | 991 |
| <code>SYSTem:ERRor:LIST?</code> .....           | 992 |
| <code>SYSTem:ERRor[:NEXT]?</code> .....         | 992 |
| <code>SYSTem:FIRMware:UPDate</code> .....       | 993 |
| <code>SYSTem:FORMat:IDENT</code> .....          | 993 |
| <code>SYSTem:PRESet:COMPAtible</code> .....     | 993 |
| <code>SYSTem:SECurity[:STATE]</code> .....      | 994 |

---

### `DIAGnostic:INFO:CCOunt? <Relay>`

This command queries how many switching cycles the individual relays have performed since they were installed.

#### Query parameters:

|                            |                                                |
|----------------------------|------------------------------------------------|
| <code>&lt;Relay&gt;</code> | <b>ACDC</b><br>Mechanical Attenuation Coupling |
|                            | <b>ATT5</b><br>Mechanical Attenuation 05 DB    |
|                            | <b>ATT10</b><br>Mechanical Attenuation 10 DB   |
|                            | <b>ATT20</b><br>Mechanical Attenuation 20 DB   |
|                            | <b>ATT40</b><br>Mechanical Attenuation 40 DB   |
|                            | <b>CAL</b><br>Mechanical Calibration Source    |
|                            | <b>EATT</b><br>Electrical Attenuation Bypass   |
|                            | <b>PREamp</b><br>Preamplifier Bypass           |

#### Return values:

|                             |                             |
|-----------------------------|-----------------------------|
| <code>&lt;Cycles&gt;</code> | Number of switching cycles. |
|-----------------------------|-----------------------------|

**Example:** `DIAG:INFO:CCO? CAL`  
**Usage:** Query only  
**Manual operation:** See "[Relays Cycle Counter](#)" on page 573

---

#### **DIAGnostic:SERVice:BIOSinfo?**

This command queries the BIOS version of the CPU board.

**Return values:**  
<BiosInformation> String containing the BIOS version.

**Example:** `DIAG:SERV:BIOS?`  
Returns the BIOS version.

**Usage:** Query only

---

#### **DIAGnostic:SERVice:HWInfo?**

This command queries hardware information.

**Return values:**  
<Hardware> String containing the following information for every hardware component.  
<component>: name of the hardware component  
<serial#>: serial number of the component  
<order#>: order number of the component  
<model>: model of the component  
<code>: code of the component  
<revision>: revision of the component  
<subrevision>: subrevision of the component

**Example:** `DIAG:SERV:HWIN?`  
Queries the hardware information.  
"FRONTEND|100001/003|1300.3009|03|01|00|00",  
"MOTHERBOARD|123456/002|1300.3080|02|00|00|00",  
...

**Usage:** Query only

---

#### **DIAGnostic:SERVice:VERSinfo?**

This command queries information about the hardware and software components.

**Return values:**  
<Information> String containing the version of hardware and software components including the types of licenses for installed options.

**Example:** `DIAG:SERV:VERS?`  
 Queries the version information.  
**Response:**  
 Instrument Firmware |1.80  
 BIOS |FPS Analyzer BIOS V1.03-1-32-4-3 IPC10  
 Image Version |1.2.0  
 PCI-FPGA |9.01  
 SA-FPGA |2.43  
 MB-FPGA |2.0.8.0  
 SYNTH-FPGA |3.9.0.0  
 REF-FPGA |3.4.0.0  
 Data Sheet Version |01.00  
 Time Control Management |active  
 Analog Demod K7| |permanent

**Usage:** Query only

#### **SYSTem:ERRor:CLEar:ALL**

This command deletes all contents of the "System Messages" table.

**Example:** `SYST:ERR:CLE:ALL`  
**Usage:** Event  
**Manual operation:** See "[Clear All Messages](#)" on page 45

#### **SYSTem:ERRor:CLEar:REMOte**

This command deletes all contents of the "Remote Errors" table.

Note: The remote error list is automatically cleared when the R&S FPS is shut down.

**Example:** `SYST:ERR:CLE:REM`  
**Usage:** Event  
**Manual operation:** See "[Display Remote Errors](#)" on page 609  
 See "[Clear Error List](#)" on page 615

#### **SYSTem:ERRor:EXTended? <MessageType>[, <ChannelName>]**

This command queries all system messages, or all messages of a defined type, displayed in the status bar for a specific channel (application).

**Note:** This command queries the strings displayed for manual operation. For remote programs, do not define processing steps depending on these results. Instead, query the results of the `STATUS:QUESTIONable:EXTended:INFO` status register, which indicates whether messages of a certain type have occurred (see "[STATUS:QUESTIONable:EXTended:INFO Register](#)" on page 595).

**Query parameters:**  
 <MessageType> ALL | INFO | WARNING | ERROR | FATAL | MESSAGE

|                       |                                                                                                                                                                                                                |
|-----------------------|----------------------------------------------------------------------------------------------------------------------------------------------------------------------------------------------------------------|
| <ChannelName>         | String containing the name of the channel.<br>The parameter is optional. If you omit it, the command works for the currently active channel.                                                                   |
| <b>Return values:</b> |                                                                                                                                                                                                                |
| <Messages>            | String containing all messages of the selected type for the specified channel. Each message is separated by a comma and inserted in parentheses. If no messages are available, empty parentheses are returned. |
| <b>Example:</b>       | <code>SYST:ERR:EXT? ALL</code><br>Returns all messages for the currently active application, e.g. "Message 1", "Message 2".                                                                                    |
| <b>Example:</b>       | <code>SYST:ERR:EXT? FAT, 'Spectrum2'</code><br>Queries fatal errors in the 'Spectrum2' application. If none have occurred, the result is: " ".                                                                 |
| <b>Usage:</b>         | Query only                                                                                                                                                                                                     |

---

#### SYSTem:ERRor:LIST? [<MessType>]

This command queries the error messages that occur during R&S FPS operation.

##### Query parameters:

|            |                                                                                                                                                                           |
|------------|---------------------------------------------------------------------------------------------------------------------------------------------------------------------------|
| <MessType> | <b>SMSG</b><br>(default) Queries the system messages which occurred during manual operation.                                                                              |
|            | <b>REMOte</b><br>Queries the error messages that occurred during remote operation.<br>Note: The remote error list is automatically cleared when the R&S FPS is shut down. |

##### Return values:

|                  |                                                                                                                                                                                                                                                                                                                                  |
|------------------|----------------------------------------------------------------------------------------------------------------------------------------------------------------------------------------------------------------------------------------------------------------------------------------------------------------------------------|
| <SystemMessages> | String containing all messages in the "System Messages" table.                                                                                                                                                                                                                                                                   |
| <RemoteErrors>   | <Error_no>   <Description>   <Command>   <Date>   <Time><br>Comma-separated list of errors from the "Remote Errors" table, where:<br><Error_no>: device-specific error code<br><Description>: brief description of the error<br><Command>: remote command causing the error<br><Date>   <Time>: date and time the error occurred |

**Example:** `SYST:ERR:LIST?`

**Usage:** Query only

---

#### SYSTem:ERRor[:NEXT]?

This command queries the most recent error queue entry and deletes it.



Positive error numbers indicate device-specific errors, negative error numbers are error messages defined by SCPI. If the error queue is empty, the error number 0, "No error", is returned.

For details on error queues see [Chapter 11.1.5, "Status Reporting System"](#), on page 586.

**Usage:** Query only

### **SYSTem:FIRMware:UPDate**

This command starts a firmware update using the \*.msi files in the selected directory. The default path is D:\FW\_UPDATE. The path is changed via the [MMEMemory:COMMENT](#) command. To store the update files the [MMEMemory:DATA](#) command is used.

Only user accounts with administrator rights can perform a firmware update.

**Example:** `SYST:FIRM:UPD 'D:\FW_UPDATE'`  
Starts the firmware update from directory "D:\FW\_UPDATE".

**Usage:** Event

### **SYSTem:FORMat:IDENt <IDNFormat>**

This command selects the response format to the \*IDN? query.

**Parameters:**

<IDNFormat>

**LEGacy**

Format is compatible to R&S FSP/FSU/FSQ/FSG family.

**NEW | FSL**

R&S FPS format

Format is also compatible to the R&S FSL and R&S FSV family

\*RST: not reset!

**Example:** `SYST:FORM:IDEN LEG`  
Adapts the return value of \*IDN? to the R&S FSP/FSU/FSQ family.

**Manual operation:** See "[\\*IDN Format](#)" on page 609

### **SYSTem:PRESet:COMPAtible <OpMode>**

This command defines the operating mode that is activated when you switch on the R&S FPS or press the PRESET key.

For details on operating modes see [Chapter 5, "Applications, Measurement Channels, and Operating Modes"](#), on page 110.

**Parameters:**

&lt;OpMode&gt;

**SANalyzer**

(Default:)

Defines Signal and Spectrum Analyzer operating mode as the presetting.

**MSRA**

Defines Multi-Standard Radio Analysis (MSRA) as the preset default operating mode.

**Manual operation:** See "[Preset Mode](#)" on page 565

**SYSTEM:SECurity[:STATe] <State>**

Activates or queries secure user mode.

**Note:** Before you activate secure user mode, store any instrument settings that are required beyond the current session, such as predefined instrument settings, transducer files, or self-alignment data.

**Note:** Initially after installation of the R&S FPS-K33 option, secure user mode must be enabled manually once before remote control is possible. This is necessary to prompt for a change of passwords.

For details on the secure user mode see [Chapter 4.1.6, "Protecting Data Using the Secure User Mode"](#), on page 33.

**Parameters:**

&lt;State&gt;

ON | OFF | 0 | 1

**ON | 1**

The R&S FPS automatically reboots and starts in secure user mode. In secure user mode, no data is written to the instrument's internal solid-state drive. Data that the R&S FPS normally stores on the solid-state drive is redirected to SDRAM.

**OFF | 0**

The R&S FPS is set to normal instrument mode. Data is stored to the internal solid-state drive.

Note: this parameter is for query only. Secure user mode cannot be deactivated via remote operation.

\*RST: 0

**Manual operation:** See "[Enable SecureUser/Disable SecureUser](#)" on page 45

See "[SecureUser Mode](#)" on page 565

**12.10.8 Using Service Functions**

|                                                                   |     |
|-------------------------------------------------------------------|-----|
| <a href="#">DIAGnostic:SERvice:SFUNction</a> .....                | 995 |
| <a href="#">DIAGnostic:SERvice:SFUNction:LASTresult?</a> .....    | 995 |
| <a href="#">DIAGnostic:SERvice:SFUNction:RESults:DELeTe</a> ..... | 995 |
| <a href="#">DIAGnostic:SERvice:SFUNction:RESults:SAVE</a> .....   | 995 |
| <a href="#">DIAGnostic:SERvice:SINFo?</a> .....                   | 995 |

---

**DIAGnostic:SERvice:SFUNction** <ServiceFunction>

This command starts a service function.

The service functions are available after you have entered the level 1 or level 2 system password.

**Parameters:**

<ServiceFunction> String containing the ID of the service function.  
The ID of the service function is made up out of five numbers, separated by a point.

- function group number
- board number
- function number
- parameter 1 (see the Service Manual)
- parameter 2 (see the Service Manual)

**Usage:** Event

**Manual operation:** See " [Service Function](#) " on page 571  
See " [Send](#) " on page 572

---

**DIAGnostic:SERvice:SFUNction:LASTresult?**

This command queries the results of the most recent service function you have used.

**Usage:** Query only

---

**DIAGnostic:SERvice:SFUNction:RESults:DELeTe**

This command deletes the results of the most recent service function you have used.

**Usage:** Event

**Manual operation:** See " [Clear Results](#) " on page 572

---

**DIAGnostic:SERvice:SFUNction:RESults:SAVE** <FileName>

This command saves the results of the most recent service function you have used.

**Parameters:**

<FileName> String containing the file name.

**Manual operation:** See " [Save Results](#) " on page 572

---

**DIAGnostic:SERvice:SINFo?** <FileName>

This command creates a \*.zip file with important support information. The \*.zip file contains the system configuration information ("device footprint"), the current eeprom data and a screenshot of the screen display (if available).

This data is stored to the C:\R\_S\INSTR\USER directory on the instrument.

As a result of this command, the created file name (including the drive and path) is returned.

You can use the resulting file name information as a parameter for the `MMEM: COPY` command to store the file on the controller PC.

(See [MMEMory: COPY](#) on page 939)

If you contact the Rohde&Schwarz support to get help for a certain problem, send this file to the support in order to identify and solve the problem faster.

**Return values:**

<FileName> C:\R\_S\INSTR\USER  
 \<R&S Device ID>\_<CurrentDate>\_<CurrentTime>  
 String containing the drive, path and file name of the created support file, where the file name consists of the following elements:  
**<R&S Device ID>**: The unique R&S device ID indicated in the "Versions + Options" information  
 (See [Chapter 10.5.2, "Information on Versions and Options"](#), on page 560)  
**<CurrentDate>**: The date on which the file is created (<YYYYMMDD>)  
**<CurrentTime>**: The time at which the file is created (<HHMMSS>)

**Example:**

DIAG:SERV:SINF?

Result:

"c:\R&S\instr\user\FPS-26\_1312.8000K26-100005-xx\_20130116\_165858.zip"

MMEM: COPY "c:\R&S\instr\user\FPS-26\_1312.8000K26-100005-xx\_20130116\_165858.zip",  
 "s:\Debug\FPS-26\_1312.8000K26-100005-xx\_20130116\_165858.zip"

**Usage:** Query only

**Manual operation:** See "[Create R&S Support Information](#)" on page 567

## 12.11 Using the Status Register

For more information on the contents of the status registers see:

- "[STATus:OPERation Register](#)" on page 592
- "[STATus:QUEStionable:ACPLimit Register](#)" on page 594
- "[STATus:QUEStionable:EXTended Register](#)" on page 595
- "[STATus:QUEStionable:FREQuency Register](#)" on page 596
- "[STATus:QUEStionable:LIMit Register](#)" on page 597
- "[STATus:QUEStionable:LMARgin Register](#)" on page 597
- "[STATus:QUEStionable:POWer Register](#)" on page 598

- ["STATus:QUEStionable:TIME Register"](#) on page 599
- [General Status Register Commands](#)..... 997
- [Reading Out the CONDition Part](#)..... 997
- [Reading Out the EVENT Part](#)..... 998
- [Controlling the ENABLE Part](#)..... 998
- [Controlling the Negative Transition Part](#)..... 999
- [Controlling the Positive Transition Part](#)..... 1000

### 12.11.1 General Status Register Commands

|                                            |     |
|--------------------------------------------|-----|
| <a href="#">STATus:PRESet</a> .....        | 997 |
| <a href="#">STATus:QUEue[:NEXT]?</a> ..... | 997 |

---

#### STATus:PRESet

This command resets the edge detectors and `ENABLE` parts of all registers to a defined value. All `PTRansition` parts are set to `FFFFh`, i.e. all transitions from 0 to 1 are detected. All `NTRansition` parts are set to 0, i.e. a transition from 1 to 0 in a `CONDition` bit is not detected. The `ENABLE` part of the `STATus:OPERation` and `STATus:QUEStionable` registers are set to 0, i.e. all events in these registers are not passed on.

**Usage:**                      Event

---

#### STATus:QUEue[:NEXT]?

This command queries the most recent error queue entry and deletes it.

Positive error numbers indicate device-specific errors, negative error numbers are error messages defined by SCPI. If the error queue is empty, the error number 0, "No error", is returned.

This command is identical to the `SYSTem:ERRor[:NEXT]?` command.

**Usage:**                      Query only

### 12.11.2 Reading Out the CONDition Part

For more information on the condition part see [Chapter 11.1.5.2, "Structure of a SCPI Status Register"](#), on page 588.

---

**STATus:OPERation:CONDition?**  
**STATus:QUEStionable:CONDition?**  
**STATus:QUEStionable:ACPLimit:CONDition?** <ChannelName>  
**STATus:QUEStionable:EXTended:CONDition?** <ChannelName>  
**STATus:QUEStionable:EXTended:INFO:CONDition?** <ChannelName>  
**STATus:QUEStionable:FREQuency:CONDition?** <ChannelName>  
**STATus:QUEStionable:LIMit<n>:CONDition?** <ChannelName>  
**STATus:QUEStionable:LMARgin<n>:CONDition?** <ChannelName>

**STATus:QUESTionable:POWer:CONDition?** <ChannelName>  
**STATus:QUESTionable:TEMPerature:CONDition?** <ChannelName>  
**STATus:QUESTionable:TIME:CONDition?** <ChannelName>

These commands read out the CONDition section of the status register.

The commands do not delete the contents of the CONDition section.

**Suffix:**

<n> [Window](#)

**Query parameters:**

<ChannelName> String containing the name of the channel.  
 The parameter is optional. If you omit it, the command works for the currently active channel.

**Usage:** Query only

### 12.11.3 Reading Out the EVENT Part

For more information on the event part see [Chapter 11.1.5.2, "Structure of a SCPI Status Register"](#), on page 588.

---

**STATus:OPERation[:EVENT]?**  
**STATus:QUESTionable[:EVENT]?**  
**STATus:QUESTionable:ACPLimit[:EVENT]?** <ChannelName>  
**STATus:QUESTionable:EXTended[:EVENT]?** <ChannelName>  
**STATus:QUESTionable:EXTended:INFO[:EVENT]?** <ChannelName>  
**STATus:QUESTionable:FREQuency[:EVENT]?** <ChannelName>  
**STATus:QUESTionable:LIMit<n>[:EVENT]?** <ChannelName>  
**STATus:QUESTionable:LMARgin<n>[:EVENT]?** <ChannelName>  
**STATus:QUESTionable:POWer[:EVENT]?** <ChannelName>  
**STATus:QUESTionable:TEMPerature[:EVENT]?** <ChannelName>  
**STATus:QUESTionable:TIME[:EVENT]?** <ChannelName>

These commands read out the EVENT section of the status register.

At the same time, the commands delete the contents of the EVENT section.

**Suffix:**

<n> [Window](#)

**Query parameters:**

<ChannelName> String containing the name of the channel.  
 The parameter is optional. If you omit it, the command works for the currently active channel.

**Usage:** Query only

### 12.11.4 Controlling the ENABLE Part

For more information on the enable part see [Chapter 11.1.5.2, "Structure of a SCPI Status Register"](#), on page 588.

---

```

STATus:OPERation:ENABLE <SumBit>
STATus:QUESTionable:ENABLE <SumBit>
STATus:QUESTionable:ACPLimit:ENABLE <SumBit>,<ChannelName>
STATus:QUESTionable:EXTended:ENABLE <SumBit>,<ChannelName>
STATus:QUESTionable:EXTended:INFO:ENABLE <SumBit>,<ChannelName>
STATus:QUESTionable:FREQuency:ENABLE <SumBit>,<ChannelName>
STATus:QUESTionable:LIMit<n>:ENABLE <SumBit>,<ChannelName>
STATus:QUESTionable:LMARgin<n>:ENABLE <SumBit>,<ChannelName>
STATus:QUESTionable:POWer:ENABLE <SumBit>,<ChannelName>
STATus:QUESTionable:TEMPerature:ENABLE <SumBit>,<ChannelName>
STATus:QUESTionable:TIME:ENABLE <SumBit>,<ChannelName>

```

These commands control the ENABLE part of a register.

The ENABLE part allows true conditions in the EVENT part of the status register to be reported in the summary bit. If a bit is 1 in the enable register and its associated event bit transitions to true, a positive transition will occur in the summary bit reported to the next higher level.

**Suffix:**

<n> [Window](#)

**Parameters:**

<SumBit> Range: 0 to 65535

<ChannelName> String containing the name of the channel.  
The parameter is optional. If you omit it, the command works for the currently active channel.

## 12.11.5 Controlling the Negative Transition Part

For more information on the positive transition part see [Chapter 11.1.5.2, "Structure of a SCPI Status Register"](#), on page 588.

---

```

STATus:OPERation:NTRansition <SumBit>
STATus:QUESTionable:NTRansition <SumBit>
STATus:QUESTionable:ACPLimit:NTRansition <SumBit>,<ChannelName>
STATus:QUESTionable:EXTended:NTRansition <SumBit>,<ChannelName>
STATus:QUESTionable:EXTended:INFO:NTRansition <SumBit>,<ChannelName>
STATus:QUESTionable:FREQuency:NTRansition <SumBit>,<ChannelName>
STATus:QUESTionable:LIMit<n>:NTRansition <SumBit>,<ChannelName>
STATus:QUESTionable:LMARgin<n>:NTRansition <SumBit>,<ChannelName>
STATus:QUESTionable:POWer:NTRansition <SumBit>,<ChannelName>
STATus:QUESTionable:TEMPerature:NTRansition <SumBit>,<ChannelName>
STATus:QUESTionable:TIME:NTRansition <SumBit>,<ChannelName>

```

These commands control the Negative TRansition part of a register.

Setting a bit causes a 1 to 0 transition in the corresponding bit of the associated register. The transition also writes a 1 into the associated bit of the corresponding EVENT register.

**Suffix:**<n> [Window](#)**Parameters:**

&lt;SumBit&gt; Range: 0 to 65535

<ChannelName> String containing the name of the channel.  
The parameter is optional. If you omit it, the command works for the currently active channel.

## 12.11.6 Controlling the Positive Transition Part

For more information on the negative transition part see [Chapter 11.1.5.2, "Structure of a SCPI Status Register"](#), on page 588.

---

**STATus:OPERation:PTRansition** <SumBit>  
**STATus:QUEStionable:PTRansition** <SumBit>  
**STATus:QUEStionable:ACPLimit:PTRansition** <SumBit>,<ChannelName>  
**STATus:QUEStionable:EXTended:PTRansition** <SumBit>,<ChannelName>  
**STATus:QUEStionable:EXTended:INFO:PTRansition** <SumBit>,<ChannelName>  
**STATus:QUEStionable:FREQUency:PTRansition** <SumBit>,<ChannelName>  
**STATus:QUEStionable:LIMit<n>:PTRansition** <SumBit>,<ChannelName>  
**STATus:QUEStionable:LMARgin<n>:PTRansition** <SumBit>,<ChannelName>  
**STATus:QUEStionable:POWEr:PTRansition** <SumBit>,<ChannelName>  
**STATus:QUEStionable:TEMPerature:PTRansition** <SumBit>,<ChannelName>  
**STATus:QUEStionable:TIME:PTRansition** <SumBit>,<ChannelName>

These commands control the Positive TRansition part of a register.

Setting a bit causes a 0 to 1 transition in the corresponding bit of the associated register. The transition also writes a 1 into the associated bit of the corresponding EVENT register.

**Suffix:**<n> [Window](#)**Parameters:**

&lt;SumBit&gt; Range: 0 to 65535

<ChannelName> String containing the name of the channel.  
The parameter is optional. If you omit it, the command works for the currently active channel.

## 12.12 Commands for Remote Instrument Operation

The following commands are required to shutdown or reboot the R&S FPS from a remote PC.

[SYSTem:CLOGging](#)..... 1001  
[SYSTem:REBoot](#)..... 1001  
[SYSTem:SHUTdown](#)..... 1001



**SYSTem:CLOGging** <State>

This command turns logging of remote commands on and off.

**Parameters:**

<State>                    **ON | 1**  
 Writes all remote commands that have been sent to a file.  
 The destination is C :  
 \R\_S\INSTR\ScpiLogging\ScpiLog.txt.

**OFF | 0**  
 \*RST:            0

**Manual operation:** See "[I/O Logging](#)" on page 609

**SYSTem:REBoot**

This command reboots the instrument, including the operating system.

**Usage:**                    Event

**Manual operation:** See "[Reboot](#)" on page 45

**SYSTem:SHUTdown**

This command shuts down the instrument.

**Usage:**                    Event

## 12.13 Emulating Other Instruments' Commands

The R&S FPS analyzer family supports a subset of the GPIB commands of several HP and PSA instruments.

For details see [Chapter 11.2, "GPIB Languages"](#), on page 603.

- [Setting up Instrument Emulation](#)..... 1001
- [Reference: GPIB Commands of Emulated HP Models](#)..... 1004
- [Reference: Command Set of Emulated PSA Models](#)..... 1032
- [Reference: Command Set of Emulated PXA Models](#)..... 1036

### 12.13.1 Setting up Instrument Emulation

The following commands are required to set up the use of commands to emulate other instruments.

Useful commands for emulating other instruments described elsewhere:

- [SYSTem:REVision:FACTory](#) on page 988

**Remote commands exclusive to emulating other instruments:**

|                                                |      |
|------------------------------------------------|------|
| <a href="#">SYSTem:HPCoupling</a> .....        | 1002 |
| <a href="#">SYSTem:IFGain:MODE</a> .....       | 1002 |
| <a href="#">SYSTem:LANGuage</a> .....          | 1002 |
| <a href="#">SYSTem:PSA:WIDeband</a> .....      | 1003 |
| <a href="#">SYSTem:REVision[:STRing]</a> ..... | 1003 |
| <a href="#">SYSTem:RSWeep</a> .....            | 1004 |

**SYSTem:HPCoupling** <CouplingType>

Controls the default coupling ratios in the HP emulation mode for:

- span and resolution bandwidth (Span/RBW) and
- resolution bandwidth and video bandwidth (RBW/VBW)

This command is only available if a HP language is selected using [SYSTem:LANGuage](#) on page 1002.

**Parameters:**

<CouplingType>      HP | FSP  
                           \*RST:        FSP

**Example:**            SYSTem:HPC HP

**Manual operation:** See "[Coupling](#)" on page 611

**SYSTem:IFGain:MODE** <Mode>

Configures the internal IF gain settings in HP emulation mode due to the application needs. This setting is only taken into account for resolution bandwidth < 300 kHz and is only available if a HP language is selected using [SYSTem:LANGuage](#).

**Parameters:**

<Mode>                NORM | PULS  
                           **NORM**  
                           Optimized for high dynamic range, overload limit is close to reference level.  
                           **PULS**  
                           Optimized for pulsed signals, overload limit up to 10 dB above reference level.  
                           \*RST:        NORM

**Example:**            SYST:IFG:MODE PULS

**Manual operation:** See "[IF Gain](#)" on page 611

**SYSTem:LANGuage** <Language>

This command selects the system language.

For details see [Chapter 11.2, "GPIB Languages"](#), on page 603.

**Parameters:**

<Language> "SCPI" | "8560E" | "8561E" | "8562E" | "8563E" | "8564E" |  
 "8565E" | "8566A" | "8566B" | "8568A" | "8568A\_DC" | "8568B" |  
 "8568B\_DC" | "8591E" | "8594E" | "71100C" | "71200C" |  
 "71209A" | "PSA89600" | "PSA" | "PXA" | "FSP" | "FSU" |  
 "FSQ" | "FSV" | "FSEA" | "FSEB" | "FSEM" | "FSEK"  
 \*RST: SCPI

**Example:**

```
SYST:LANG 'PSA'
```

Emulates the PSA.

**Manual operation:** See "[Language](#)" on page 610

**Note:** If you use "**PSA89600**", you must switch to an HP language first before returning to SCPI (in remote operation only). For the identical language "PSA", this intermediate step is not necessary.

**SYSTem:PSA:WIDeband** <State>

This command defines which option is returned when the \*OPT? query is executed, depending on the state of the wideband option.

It is only available for PSA89600 emulation.

**Parameters:**

<State> ON | OFF | HIGH

**OFF**  
 The option is indicated as "B7J"

**ON**  
 The 40 MHz wideband is used.  
 The option is indicated as "B7J, 140".

**HIGH**  
 The 80 MHz wideband is used.  
 The option is indicated as "B7J, 122".

\*RST: OFF

**SYSTem:REVision[:STRing]** <Name>

Sets the response to the REV? query to the defined string (HP emulation only, see [SYSTem:LANGuage](#) on page 1002).

**Parameters:**

<Name>

**Example:** Define the system language:  
`SYST:LANG '8563E'`  
 Query the revision:  
`REV?`  
 Response:  
`920528`  
 Set the response to 'NewRevision':  
`SYST:REV:STR 'NewRevision'`  
 Query the response:  
`SYST:REV:STR?`  
 Response:  
`NewRevision`

**Manual operation:** See "[Revision String](#)" on page 611

### **SYSTem:RSweep <State>**

Controls a repeated sweep of the E1 and MKPK HI HP model commands (for details on the commands refer to [Chapter 12.13.2, "Reference: GPIB Commands of Emulated HP Models"](#), on page 1004). If the repeated sweep is OFF, the marker is set without sweeping before.

This command is only available if a HP language is selected using [SYSTem:LANGuage](#) on page 1002

#### **Parameters:**

<State> ON | OFF | 1 | 0  
 \*RST: 0

**Example:** `SYSTem:RSW ON`

**Manual operation:** See "[Sweep Repeat](#)" on page 611

## **12.13.2 Reference: GPIB Commands of Emulated HP Models**

The R&S FPS analyzer family supports a subset of the GPIB commands of HP models 8560E, 8561E, 8562E, 8563E, 8564E, 8565E, 8566A, 8566B, 8568A, 8568B and 8594E.

Despite the differences in system architecture and device features, the supported commands have been implemented in a way to ensure a sufficiently high degree of correspondence with the original.

This includes the support of syntax rules for not only newer device families (B and E models) but for the previous A family as well.

In many cases the selection of commands supported by the R&S FPS is sufficient to run an existing GPIB program without adaptation.

After the introduction, this section includes the following topics:

- [Command Set of Models 8560E, 8561E, 8562E, 8563E, 8564E, 8565E, 8566A/B, 8568A/B, 8591E, 8594E, 71100C, 71200C, and 71209A](#)..... 1005
- [Special Features of the Syntax Parsing Algorithms for 8566A and 8568A Models](#)..... 1028
- [Special Behavior of Commands](#)..... 1029
- [Model-Dependent Default Settings](#)..... 1030
- [Data Output Formats](#)..... 1031
- [Trace Data Output Formats](#)..... 1031
- [Trace Data Input Formats](#)..... 1031
- [GPIB Status Reporting](#)..... 1031

### 12.13.2.1 [Command Set of Models 8560E, 8561E, 8562E, 8563E, 8564E, 8565E, 8566A/B, 8568A/B, 8591E, 8594E, 71100C, 71200C, and 71209A](#)

As with the original units, the R&S FPS includes the command set of the A models in the command set of the B models.



The HP model 8591E is compatible to HP model 8594E, the HP models 71100C, 71200C, and 71209A are compatible to HP models 8566A/B.

| Command             | Supported subset | Function               | Corresp. HP-Models                              | Status    |
|---------------------|------------------|------------------------|-------------------------------------------------|-----------|
| A1                  | A1               | Clear/Write A          | HP 8566A/<br>HP 8568A                           | available |
| A2                  | A2               | Max Hold A             | HP 8566A/<br>HP 8568A                           | available |
| A3                  | A3               | View A                 | HP 8566A/<br>HP 8568A                           | available |
| A4                  | A4               | Blank A                | HP 8566A/<br>HP 8568A                           | available |
| ABORT <sup>1)</sup> | ABORT            | Stop previous function | HP 856xE/<br>HP 8566B/HP<br>8568B/HP<br>8594E   | available |
| ADD                 |                  | Add                    | HP 8566B/<br>HP 8568B/<br>HP 8594E              | available |
| ADJALL              | ADJALL           | Adjust all             | HP 856xE/<br>HP 8566B/<br>HP 8568B/<br>HP 8594E | available |

| Command              | Supported subset                                                  | Function               | Corresp. HP-Models                                                        | Status    |
|----------------------|-------------------------------------------------------------------|------------------------|---------------------------------------------------------------------------|-----------|
| ADJCRT <sup>2)</sup> | ADJCRT                                                            | Adjust CRT             | HP 856xE/<br>HP 8566B/<br>HP 8568B/<br>HP 8594E                           | available |
| ADJIF <sup>2)</sup>  | ADJIF                                                             | Auto adjust IF         | HP 856xE/<br>HP 8566B/<br>HP 8568B/<br>HP 8594E                           | available |
| AMB                  | AMB ON OFF<br>AMB 1 0<br>AMB?                                     | Trace A – B -> Trace A | HP 856xE/<br>HP 8594E                                                     | available |
| AMBPL                | AMBPL ON OFF<br>AMBPL 1 0<br>AMBPL?                               |                        | HP 856xE/<br>HP 8566B/<br>HP 8568B/<br>HP 8594E                           | available |
| ANNOT                | ANNOT ON OFF<br>ANNOT 1 0<br>ANNOT?                               | Annotation             | HP 856xE/<br>HP 8566B/<br>HP 8568B/<br>HP 8594E                           | available |
| APB                  | APB                                                               | Trace A + B -> Trace A | HP 856xE/<br>HP 8566B/<br>HP 8568B/<br>HP 8594E                           | available |
| AT                   | AT <numeric_value> DB<br>  DM<br>AT DN<br>AT UP<br>AT AUTO<br>AT? | Attenuation            | HP 8566A/<br>HP 8568A/<br>HP 856xE/<br>HP 8566B/<br>HP 8568B/<br>HP 8594E | available |
| AUNITS               | AUNITS DBM   DBMV  <br>DBUV  <br>AUNITS?                          | Amplitude Units        | HP 856xE/<br>HP 8566B/<br>HP 8568B/<br>HP 8594E                           | available |
| AUTOCP               | AUTOCP                                                            | Coupling default       | HP 856xE/<br>HP 8566B/<br>HP 8568B/<br>HP 8594E                           | available |

## Emulating Other Instruments' Commands

| Command           | Supported subset             | Function                              | Corresp. HP-Models                              | Status    |
|-------------------|------------------------------|---------------------------------------|-------------------------------------------------|-----------|
| AXB               | AXB                          | Exchange trace A and B                | HP 856xE/<br>HP 8566B/<br>HP 8568B/<br>HP 8594E | available |
| B1                | B1                           | Clear/Write B                         | HP 8566A/<br>HP 8568A                           | available |
| B2                | B2                           | Max Hold B                            | HP 8566A/<br>HP 8568A                           | available |
| B3                | B3                           | View B                                | HP 8566A/<br>HP 8568A                           | available |
| B4                | B4                           | Blank B                               | HP 8566A/<br>HP 8568A                           | available |
| BL                | BL                           | Trace B – Display Line -<br>> Trace B | HP 8566A/<br>HP 8568A                           | available |
| BML               | BML                          | Trace B – Display Line -<br>> Trace B | HP 856xE/<br>HP8594E                            | available |
| BTC               | BTC                          | Transfer Trace B -> C                 | HP 856xE/<br>HP 8566B/<br>HP 8568B/<br>HP 8594E | available |
| BXC               | BXC                          | Exchange Trace B and<br>C             | HP 856xE/<br>HP 8566B/<br>HP 8568B/<br>HP 8594E | available |
| BLANK             | BLANK TRA TRB TRC            | Blank Trace                           | HP 856xE/<br>HP 8566B/<br>HP 8568B/<br>HP 8594E | available |
| C1                | C1                           | A-B off                               | HP 8566A/<br>HP 8568A                           | available |
| C2                | C2                           | A-B -> A                              | HP 8566A/<br>HP 8568A                           | available |
| CA                | CA                           | Couple Attenuation                    | HP 8566A/<br>HP 8568A                           | available |
| CAL <sup>1)</sup> | CAL ALL<br>CAL ON<br>CAL OFF | Start analyzer self align-<br>ment    | HP 856xE/<br>HP 8566B/<br>HP 8568B/<br>HP 8594E | available |

| Command           | Supported subset                                              | Function                  | Corresp. HP-Models                                                        | Status    |
|-------------------|---------------------------------------------------------------|---------------------------|---------------------------------------------------------------------------|-----------|
| CF                | CF <numeric_value><br>HZ KHZ MHZ GHZ<br>CF UP<br>CF DN<br>CF? | Center Frequency          | HP 8566A/<br>HP 8568A/<br>HP 856xE/<br>HP 8566B/<br>HP 8568B/<br>HP 8594E | available |
| CHANPWR           | CHANPWR TRA TRB,<br><numeric_value>,<?>                       | Channel Power Measurement | HP 856xE/<br>HP 8594E                                                     | available |
| CHPWRBW           | CHPWRBW<br><numeric_value> HZ <br>KHZ MHZ GHZ                 | Channel Power Bandwidth   | HP 856xE/<br>HP 8594E                                                     | available |
| CLRW              | CLRW TRA TRB TRC                                              | Clear/Write Trace         | HP 856xE/<br>HP 8566B/<br>HP 8568B/<br>HP 8594E                           | available |
| CLS <sup>1)</sup> | CLS                                                           | Clear all status bits     | HP 856xE/<br>HP 8566B/<br>HP 8568B/<br>HP 8594E                           | available |
| CONTS             | CONTS                                                         |                           | HP 856xE/<br>HP 8566B/<br>HP 8568B/<br>HP 8594E                           | available |
| COUPLE            | COUPLE AC DC                                                  | Input coupling            | HP 856xE/<br>HP 8566B/<br>HP 8568B/<br>HP 8594E                           | available |
| CR                | CR                                                            | Couple RBW                | HP 8566A/<br>HP 8568A                                                     | available |
| CS                | CS                                                            | Couple Step Size          | HP 8566A/<br>HP 8568A                                                     | available |
| CT                | CT                                                            | Couple SWT                | HP 8566A/<br>HP 8568A                                                     | available |
| CTA               |                                                               | Convert to absolute units | HP 8566B/<br>HP 8568B/<br>HP 8594E                                        | available |
| CV                | CV                                                            | Couple VBW                | HP 8566A/<br>HP 8568A                                                     | available |
| D1 <sup>2)</sup>  | D1                                                            | Display Size normal       | HP 8566A/<br>HP 8568A                                                     | available |



## Emulating Other Instruments' Commands

| Command                | Supported subset                                                        | Function                               | Corresp. HP-Models                              | Status    |
|------------------------|-------------------------------------------------------------------------|----------------------------------------|-------------------------------------------------|-----------|
| DA <sup>2)</sup>       | DA                                                                      | Display address                        |                                                 | available |
| DEMOT <sup>1)</sup>    | DEMOT ON OFF AM FM                                                      | AF Demodulator                         | HP 856xE/<br>HP 8566B/<br>HP 8568B/<br>HP 8594E | available |
| DEMOTAGC <sup>2)</sup> | DEMOTAGC ON OFF 1 0<br>DEMOTAGC?                                        | Demodulation AGC                       | HP 856xE/<br>HP 8566B/<br>HP 8568B/<br>HP 8594E | available |
| DEMOT                  | DEMOT <numeric_value> S MS US SC<br>DEMOT UP DN<br>DEMOT?               | Demodulation time                      | HP 856xE/<br>HP 8566B/<br>HP 8568B/<br>HP 8594E | available |
| DET                    | DET POS SMP NEG<br>DET?                                                 | Detector                               | HP 856xE/<br>HP 8566B/<br>HP 8568B/<br>HP 8594E | available |
| DISPOSE <sup>2)</sup>  | ONEOS   TRMATH  <br>ONSWP   ALL  <br><numeric_value>                    |                                        |                                                 | available |
| DIV                    |                                                                         | Divide                                 | HP 8566B/<br>HP 8568B/<br>HP 8594E              | available |
| DL                     | DL <numeric_value><br>DB DM<br>DL DN<br>DL UP<br>DL ON<br>DL OFF<br>DL? | Display Line                           | HP 856xE/<br>HP 8566B/<br>HP 8568B/<br>HP 8594E | available |
| DLE                    | DLE ON OFF                                                              | Display Line enable                    | HP 856xE/<br>HP 8566B/<br>HP 8568B/<br>HP 8594E | available |
| DONE                   | DONE<br>DONE?                                                           | Done query                             | HP 856xE/<br>HP 8566B/<br>HP 8568B/<br>HP 8594E | available |
| DW <sup>2)</sup>       | DW                                                                      | Write to display and increment address |                                                 | available |

## Emulating Other Instruments' Commands

| Command  | Supported subset                                                                                                                                                                                                                                                          | Function                                     | Corresp. HP-Models                                                        | Status            |
|----------|---------------------------------------------------------------------------------------------------------------------------------------------------------------------------------------------------------------------------------------------------------------------------|----------------------------------------------|---------------------------------------------------------------------------|-------------------|
| E1       | E1                                                                                                                                                                                                                                                                        | Peak Search                                  | HP 8566A/<br>HP 8568A                                                     | available         |
| E2       | E2                                                                                                                                                                                                                                                                        | Marker to Center Freq.                       | HP 8566A/<br>HP 8568A                                                     | available         |
| E3       | E3                                                                                                                                                                                                                                                                        | Deltamarker Step Size                        | HP 8566A/<br>HP 8568A                                                     | available         |
| E4       | E4                                                                                                                                                                                                                                                                        | Marker to Ref. Level                         | available                                                                 | available         |
| EDITDONE |                                                                                                                                                                                                                                                                           | limit line edit done                         | HP 856xE                                                                  | available         |
| EDITLIML |                                                                                                                                                                                                                                                                           | edit limit line                              | HP 856xE                                                                  | available         |
| ERR      | ERR 250 cal level error<br>ERR 300 LO unlock<br>ERR 472 cal error digital filter<br>ERR 473 cal error analog filter<br>ERR 552 cal error log amp<br>ERR 902 unscale tracking generator<br>ERR 906 oven cold<br>ERR 117 numeric unit error<br>ERR 112 Unrecognized Command | Now some FSx errors are mapped to HP errors. | HP8568A<br>HP856xE                                                        | not yet available |
| ERR?     | ERR?                                                                                                                                                                                                                                                                      | Error queue query                            | HP 856xE/<br>HP 8566B/<br>HP 8568B/<br>HP 8594E                           | not yet available |
| EX       | EX                                                                                                                                                                                                                                                                        | Exchange trace A and B                       | HP 8566A/<br>HP 8568A                                                     | available         |
| FA       | FA <numeric_value> HZ <br>KHZ MHZ GHZ<br>FA UP<br>FA DN<br>FA?                                                                                                                                                                                                            | Start Frequency                              | HP 8566A/<br>HP 8568A/<br>HP 856xE/<br>HP 8566B/<br>HP 8568B/<br>HP 8594E | available         |
| FB       | FB <numeric_value> HZ <br>KHZ MHZ GHZ<br>FB UP<br>FB DN<br>FB?                                                                                                                                                                                                            | Stop Frequency                               | HP 8566A/<br>HP 8568A/<br>HP 856xE/<br>HP 8566B/<br>HP 8568B/<br>HP 8594E | available         |

| Command               | Supported subset                                          | Function                                                                | Corresp. HP-Models                                 | Status    |
|-----------------------|-----------------------------------------------------------|-------------------------------------------------------------------------|----------------------------------------------------|-----------|
| FDSP                  |                                                           | Frequency display off                                                   | 8560E<br>8561E<br>8562E<br>8563E<br>8564E<br>8565E | available |
| FOFFSET <sup>1)</sup> | FOFFSET<br><numeric_value> HZ <br>KHZ MHZ GHZ<br>FOFFSET? | Frequency Offset                                                        | HP 856xE/<br>HP 8566B/<br>HP 8568B/<br>HP 8594E    | available |
| FREF                  | FREF INT EXT                                              | Reference Frequency                                                     | HP 856xE/<br>HP 8566B/<br>HP 8568B/<br>HP 8594E    | available |
| FS                    | FS                                                        | Full Span                                                               | HP 8566A/<br>HP 8568A                              | available |
| FUNCDEF               |                                                           | Define Function Function<br>must be in one line<br>between delimiters @ | HP 8594E/<br>HP 856xE/<br>HP 8566B                 | available |
| GATE <sup>1)</sup>    | GATE ON OFF<br>GATE 1 0                                   |                                                                         | HP 856xE/<br>HP 8566B/<br>HP 8568B/<br>HP 8594E    | available |
| GATECTL <sup>1)</sup> | GATECTL EDGE LEVEL<br>GATECTL?                            |                                                                         | HP 856xE/<br>HP 8566B/<br>HP 8568B/<br>HP 8594E    | available |
| GD <sup>1)</sup>      | GD <numeric_value><br>US MS SC<br>GD DN<br>GD UP<br>GD?   |                                                                         | HP 856xE/<br>HP 8566B/<br>HP 8568B/<br>HP 8594E    | available |
| GL <sup>1)</sup>      | GL <numeric_value><br>US MS SC<br>GL DN<br>GL UP<br>GL?   |                                                                         | HP 856xE/<br>HP 8566B/<br>HP 8568B/<br>HP 8594E    | available |
| GP <sup>1)</sup>      | GP POS NEG<br>GP?                                         |                                                                         | HP 856xE/<br>HP 8566B/<br>HP 8568B/<br>HP 8594E    | available |

| Command            | Supported subset                                                  | Function                            | Corresp. HP-Models                                                        | Status    |
|--------------------|-------------------------------------------------------------------|-------------------------------------|---------------------------------------------------------------------------|-----------|
| GRAT <sup>2)</sup> | GRAT<br>ON OFF                                                    | Graticule                           | HP 856xE/<br>HP 8566B/<br>HP 8568B/<br>HP 8594E                           | available |
| I1                 | I1                                                                |                                     | HP 8566A/<br>HP 8568A                                                     | available |
| I2                 | I2                                                                |                                     | HP 8566A/<br>HP 8568A                                                     | available |
| ID                 | ID<br>ID?                                                         | Identify                            | HP 8566A/<br>HP 8568A/<br>HP 856xE/<br>HP 8566B/<br>HP 8568B/<br>HP 8594E | available |
| INZ <sup>1)</sup>  | INZ 75<br>INZ 50<br>INZ?                                          | Input Impedance                     | HP 856xE/<br>HP 8566B/<br>HP 8568B/<br>HP 8594E                           | available |
| IP                 | IP                                                                | Instrument preset                   | HP 8566A/<br>HP 8568A                                                     | available |
| KEYDEF             | KEYDEF                                                            | Key definition                      | HP 8566B/<br>HP 856xE/<br>HP 859xE                                        | available |
| KEYEXEC            | KEYEXEC                                                           | Key execute                         | HP 8566B                                                                  | available |
| KS=                | KS= <numeric_value><br>HZ KHZ MHZ GHZ<br>KS= DN<br>KS= UP<br>KS=? | Marker Frequency Counter Resolution | HP 8566A/<br>HP 8568A                                                     | available |
| KS/                | KS/                                                               | Manual Peaking                      | HP 8566A/<br>HP 8568A                                                     | available |
| KS(                | KS(                                                               | Lock register                       | HP 8566A/<br>HP 8568A                                                     | available |
| KS)                | KS)                                                               | Unlock register                     | HP 8566A/<br>HP 8568A                                                     | available |
| KS91               | KS91                                                              | Read Amplitude Error                | HP 8566A/<br>HP 8568A                                                     | available |
| KSA                | KSA                                                               | Amplitude Units in dBm              | HP 8566A/<br>HP 8568A                                                     | available |

| Command           | Supported subset                              | Function                 | Corresp. HP-Models    | Status    |
|-------------------|-----------------------------------------------|--------------------------|-----------------------|-----------|
| KSB               | KSB                                           | Amplitude Units in dBmV  | HP 8566A/<br>HP 8568A | available |
| KSC               | KSC                                           | Amplitude Units in dBuV  | HP 8566A/<br>HP 8568A | available |
| KSD               | KSD                                           | Amplitude Units in V     | HP 8566A/<br>HP 8568A | available |
| KSE               | KSE <numeric_value> <br><char data>@          | Title mode               | HP 8566A/<br>HP 8568A | available |
| KSG               | KSG<br>KSG ON<br>KSG <numeric_value>          | Video Averaging on       | HP 8566A/<br>HP 8568A | available |
| KSH               | KSH                                           | Video Averaging Off      | HP 8566A/<br>HP 8568A | available |
| KSK               |                                               | Marker to Next Peak      | HP 8566A/<br>HP 8568A | available |
| KSL               |                                               | Marker Noise off         | HP 8566A/<br>HP 8568A | available |
| KSM               |                                               | Marker Noise on          | HP 8566A/<br>HP 8568A | available |
| KSO               | KSO                                           | Deltamarker to span      | HP 8566A/<br>HP 8568A | available |
| KSP               | KSP <numeric_value>                           | HPiB address             | HP 8566A/<br>HP 8568A | available |
| KSQ <sup>2)</sup> | KSQ                                           | Band lock off            | HP 8566A/<br>HP 8568A | available |
| KST               | KST                                           | Fast Preset              | HP 8566A/<br>HP 8568A | available |
| KSV               | KSV <numeric_value><br>HZ KHZ MHZ GHZ<br>KSV? | Frequency Offset         | HP 8566A/<br>HP 8568A | available |
| KSW               | KSW                                           | Error Correction Routine | HP 8566A/<br>HP 8568A | available |
| KSX               | KSX                                           | Correction Values On     | HP 8566A/<br>HP 8568A | available |
| KSY               | KSY                                           | Correction Values Off    | HP 8566A/<br>HP 8568A | available |

## Emulating Other Instruments' Commands

| Command           | Supported subset                    | Function               | Corresp. HP-Models    | Status    |
|-------------------|-------------------------------------|------------------------|-----------------------|-----------|
| KSZ               | KSZ <numeric_value><br>DB<br>KSZ?   | Reference Value Offset | HP 8566A/<br>HP 8568A | available |
| KSa               | KSa                                 | Normal Detection       | HP 8566A/<br>HP 8568A | available |
| KSb               | KSb                                 | Pos Peak Detection     | HP 8566A/<br>HP 8568A | available |
| KSd               | KSd                                 | Neg Peak Detection     | HP 8566A/<br>HP 8568A | available |
| KSe               | KSe                                 | Sample Detection       | HP 8566A/<br>HP 8568A | available |
| KSg               |                                     | CRT beam off           |                       | available |
| KSh               |                                     | CRT beam on            |                       | available |
| KSj               | KSj                                 | View Trace C           | HP 8566A/<br>HP 8568A | available |
| KSk               | KSk                                 | Blank Trace C          | HP 8566A/<br>HP 8568A | available |
| KSl               | KSl                                 | Transfer B to C        | HP 8566A/<br>HP 8568A | available |
| KSm               | KSm                                 | Graticule off          | HP 8566A/<br>HP 8568A | available |
| KSn <sup>2)</sup> | KSn                                 | Grid on                | HP 8566A/<br>HP 8568A | available |
| KSo               | KSn                                 | Character display off  | HP 8566A/<br>HP 8568A | available |
| KSp               | KSp                                 | Character display on   | HP 8566A/<br>HP 8568A | available |
| KSr               | KSr                                 | Create service request | HP 8566A/<br>HP 8568A | available |
| KSt <sup>2)</sup> | KSt                                 | Band lock on           | HP 8566A/<br>HP 8568A | available |
| KV <sup>2)</sup>  | KV                                  | Signal ident on        | HP 8566A/<br>HP 8568A | available |
| L0                | L0                                  | Display line off       | HP 8566A/<br>HP 8568A | available |
| LB                | LB <numeric_value> <br><char data>@ | Label                  | HP 8566A/<br>HP 8568A | available |

| Command          | Supported subset                                                    | Function                   | Corresp. HP-Models                              | Status    |
|------------------|---------------------------------------------------------------------|----------------------------|-------------------------------------------------|-----------|
| LF               | LF                                                                  | Low frequency band pre-set | HP 8566A/<br>HP 8568A                           | available |
| LIMD             |                                                                     | limit line delta           | HP 856xE                                        | available |
| LIMF             |                                                                     | limit line frequency       | HP 856xE                                        | available |
| LIMIFAIL         |                                                                     | limit fail query           | HP 856xE                                        | available |
| LIMIPURGE        |                                                                     | purge limit line           | HP 856xE                                        | available |
| LIMIRCL          |                                                                     | recall limit line          | HP 856xE                                        | available |
| LIMIREL          |                                                                     | relative limit line        | HP 856xE                                        | available |
| LIMISAV          |                                                                     | save limit line            | HP 856xE                                        | available |
| LIMITEST         |                                                                     | limit line test            | HP 856xE                                        | available |
| LIML             |                                                                     | lower limit line value     | HP 856xE                                        | available |
| LIMM             |                                                                     | middle limit line value    | HP 856xE                                        | available |
| LIMTFL           |                                                                     | flat limit line segment    | HP 856xE                                        | available |
| LIMTSL           |                                                                     | slope limit line segment   | HP 856xE                                        | available |
| LIMU             |                                                                     | upper limit line value     | HP 856xE                                        | available |
| LG               | LG <numeric_value> DB<br>  DM<br>LG?                                | Amplitude Scale Log        | HP 856xE/<br>HP 8566B/<br>HP 8568B/<br>HP 8594E | available |
| LL <sup>2)</sup> | LL                                                                  | Plot command               | HP 8566A/<br>HP 8568A                           | available |
| LN               | LN                                                                  | Amplitude Scale Lin        | HP 856xE/<br>HP 8566B/<br>HP 8568B/<br>HP 8594E | available |
| M1               | M1                                                                  | Marker Off                 | HP 8566A/<br>HP 8568A                           | available |
| M2               | M2<br>M2 <numeric_value><br>HZ KHZ MHZ GHZ<br>M2 DN<br>M2 UP<br>M2? | Marker Normal              | HP 8566A/<br>HP 8568A                           | available |

| Command            | Supported subset                                                    | Function                 | Corresp. HP-Models                                                        | Status        |
|--------------------|---------------------------------------------------------------------|--------------------------|---------------------------------------------------------------------------|---------------|
| M3                 | M3<br>M3 <numeric_value><br>HZ KHZ MHZ GHZ<br>M3 DN<br>M3 UP<br>M3? | Delta Marker             | HP 8566A/<br>HP 8568A                                                     | available     |
| M4                 | M4 <numeric_value><br>HZ KHZ MHZ GHZ                                | Marker Zoom              | HP 8566A/<br>HP 8568A                                                     | available     |
| MA                 | MA                                                                  | Marker Amplitude         | HP 8566A/<br>HP 8568A                                                     | available     |
| MC0                | MC0                                                                 | Marker Count off         | HP 8566A/<br>HP 8568A                                                     | available     |
| MC1                | MC1                                                                 | Marker Count on          | HP 8566A/<br>HP 8568A                                                     | available     |
| MDS                | MDS                                                                 | Measurement data size    | HP 8566B                                                                  | available     |
| MEAS               |                                                                     | Measurement status       | HP 856xE                                                                  | available     |
| MF                 | MF<br>MF?                                                           | Marker Frequency         | HP 8566A/<br>HP 8568A/<br>HP 856xE/<br>HP 8566B/<br>HP 8568B/<br>HP 8594E | available     |
| MINH <sup>1)</sup> | MINH TRC                                                            | Minimum Hold             | HP 856xE/<br>HP 8566B/<br>HP 8568B/<br>HP 8594E                           | available     |
| MKA                | MKA <numeric_value><br>MKA?                                         | Marker Amplitude         | HP 856xE/<br>HP 8566B/<br>HP 8568B/<br>HP 8594E                           | available     |
| MKACT              | MKACT 1<br>MKACT?                                                   | Select the active marker | HP 856xE/<br>HP 8566B/<br>HP 8568B/<br>HP 8594E                           | not available |
| MKBW <sup>1)</sup> | MKBW <numeric_value><br>MKBW ON<br>MKBW OFF                         | N dB Down                | HP 856xE/<br>HP 8566B/<br>HP 8568B/<br>HP 8594E                           | available     |



| Command             | Supported subset                                                                                  | Function                     | Corresp. HP-Models                              | Status    |
|---------------------|---------------------------------------------------------------------------------------------------|------------------------------|-------------------------------------------------|-----------|
| MKD                 | MKD<br>MKD <numeric_value><br>HZ KHZ <br>MHZ GHZ<br>MKD DN<br>MKD UP<br>MKD ON<br>MKD OFF<br>MKD? | Delta Marker                 | HP 856xE/<br>HP 8566B/<br>HP 8568B/<br>HP 8594E | available |
| MKDR                | MKDR <numeric_value><br>HZ KHZ <br>MHZ GHZ <br>S SC MS MSEC <br>USMKDR?                           | Delta Marker reverse         | HP 856xE/<br>HP 8566B/<br>HP 8568B/<br>HP 8594E | available |
| MKDR?               |                                                                                                   | Delta Marker reverse query   |                                                 | available |
| MKF                 | MKF <numeric_value><br>HZ KHZ MHZ GHZ<br>MKF?                                                     | Set Marker Frequency         | HP 856xE/<br>HP 8566B/<br>HP 8568B/<br>HP 8594E | available |
| MKFC                | MKFC ON OFF                                                                                       | Frequency Counter on/off     | HP 856xE/<br>HP 8566B/<br>HP 8568B/<br>HP 8594E | available |
| MKFCR <sup>1)</sup> | MKFCR<br><numeric_value><br>HZ KHZ  MHZ GHZ<br>MKFCR DN<br>MKFCR UP<br>MKFCR?                     | Frequency Counter Resolution | HP 856xE/<br>HP 8566B/<br>HP 8568B/<br>HP 8594E | available |
| MKMIN               | MKMIN                                                                                             | Marker -> Min                | HP 856xE/<br>HP 8566B/<br>HP 8568B/<br>HP 8594E | available |
| MKN                 | MKN<br>MKN <numeric_value><br>HZ KHZ MHZ GHZ<br>MKN DN<br>MKN UP<br>MKN ON<br>MKN OFF<br>MKN?     | Normal Marker                | HP 856xE/<br>HP 8566B/<br>HP 8568B/<br>HP 8594E | available |

## Emulating Other Instruments' Commands

| Command | Supported subset                                          | Function                  | Corresp. HP-Models                              | Status    |
|---------|-----------------------------------------------------------|---------------------------|-------------------------------------------------|-----------|
| MKNOISE | MKNOISE ON OFF<br>MKNOISE 1 0<br>MKNOISE?                 | Noise Measurement         | HP 856xE/<br>HP 8566B/<br>HP 8568B/<br>HP 8594E | available |
| MKOFF   | MKOFF<br>MKOFF ALL                                        | Marker off                | HP 856xE/<br>HP 8566B/<br>HP 8568B/<br>HP 8594E | available |
| MKP     | MKP <numeric_value><br>MKP?                               | Marker position           | HP 856xE/<br>HP 8566B/<br>HP 8568B/<br>HP 8594E | available |
| MKPK    | MKPK<br>MKPK HI<br>MKPK NH<br>MKPK NR<br>MKPK NL          | Marker Search             | HP 856xE/<br>HP 8566B/<br>HP 8568B/<br>HP 8594E | available |
| MKPT    | MKPT<br>MKPT HI<br>MKPT NH<br>MKPT NR<br>MKPT NL          | Marker Peak Threshold     | HP 856xE/<br>HP 8566B/<br>HP 8568B/<br>HP 8594E | available |
| MKPX    | MKPX <numeric_value><br>DB<br>MKPX DN<br>MKPX UP<br>MKPX? | Peak Excursion            | HP 856xE/<br>HP 8566B/<br>HP 8568B/<br>HP 8594E | available |
| MKRL    | MKRL                                                      | Ref Level = Marker Level  | HP 856xE/<br>HP 8566B/<br>HP 8568B/<br>HP 8594E | available |
| MKSP    | MKSP                                                      | Deltamarker to span       | HP 856xE/<br>HP 8566B/<br>HP 8568B/<br>HP 8594E | available |
| MKSS    | MKSS                                                      | CF Stepsize = Marker Freq | HP 856xE/<br>HP 8566B/<br>HP 8568B/<br>HP 8594E | available |

| Command           | Supported subset                          | Function                        | Corresp. HP-Models                              | Status                     |
|-------------------|-------------------------------------------|---------------------------------|-------------------------------------------------|----------------------------|
| MKT               | MKT <numeric_value><br>S MS US SC<br>MKT? | MKF = fstart + MKT/<br>SWT*Span | HP 856xE/<br>HP 8594E                           | available                  |
| MKTRACE           | MKTRACE TRA TRB <br>TRC                   | Marker to Trace                 | HP 856xE/<br>HP 8566B/<br>HP 8568B/<br>HP 8594E | available                  |
| MKTRACK           | MKTRACK ON OFF<br>MKTRACK 1 0<br>MKTRACK? | Signal Track                    | HP 856xE/<br>HP 8566B/<br>HP 8568B/<br>HP 8594E | available                  |
| MKTYPE            | MKTYPE AMP<br>MK TYPE?                    | Marker type                     | HP 856xE/<br>HP 8566B/<br>HP 8568B/<br>HP 8594E | available                  |
| ML                |                                           | Mixer level                     | HP 856xE                                        | available                  |
| MOV               | MOV TRA TRB TRC,<br>TRA TRB TRC           | Move Trace Contents             | HP 856xE/<br>HP 8566B/<br>HP 8568B/<br>HP 8594E | available                  |
| MPY               |                                           | Multiply                        | HP 8566B/<br>HP 8568B/<br>HP 8594E              | available                  |
| MT0               | MT0                                       | Marker Track Off                | HP 8566A/<br>HP 8568A                           | available                  |
| MT1               | MT1                                       | Marker Track On                 | HP 8566A/<br>HP 8568A                           | available                  |
| MXMH              | MXMH TRA TRB                              | Maximum Hold                    | HP 856xE/<br>HP 8566B/<br>HP 8568B/<br>HP 8594E | available                  |
| NORMALIZE         | NORMALIZE                                 | Normalize trace                 | HP 856xE/<br>HP 8566B/<br>HP 8568B/<br>HP 8594E | not available<br>available |
| NRL <sup>1)</sup> | NRL <numeric_value><br>DB   DM<br>NRL?    | Normalized Reference<br>Level   | HP 856xE/<br>HP 8566B/<br>HP 8568B/<br>HP 8594E | available                  |

| Command  | Supported subset                      | Function                                                 | Corresp. HP-Models                              | Status    |
|----------|---------------------------------------|----------------------------------------------------------|-------------------------------------------------|-----------|
| NRPOS    | NRPOS<br><numeric_value><br>NRL?      | Normalize position                                       | HP 856xE/<br>HP 8566B/<br>HP 8568B/<br>HP 8594E | available |
| O1       | O1                                    | Format ASCII, Values 0 to 4095                           | HP 8566A/<br>HP 8568A                           | available |
| O2       | O2                                    | Format Binary, Values 0 to 4095                          | HP 8566A/<br>HP 8568A                           | available |
| O3       | O3                                    | Format ASCII                                             | HP 8566A/<br>HP 8568A                           | available |
| OA       | OA                                    | Output All                                               | HP 8566A/<br>HP 8568A                           | available |
| OL       | OL <80 characters><br>OL?             | Output Learn String                                      | HP 8566A/<br>HP 8568A                           | available |
| OT       | OT                                    | Output Trace Annotations                                 | HP 8566A/<br>HP 8568A                           | available |
| PA       | PA <numeric_value>,<br><numeric_value | Plot command                                             | HP 8566A/<br>HP 8568A                           | available |
| PD       | PD <numeric_value>,<br><numeric_value | Plot command                                             | HP 8566A/<br>HP 8568A                           | available |
| PH_MKF   |                                       | Spot frequency in Hz                                     | HP 856xE                                        | available |
| PH_FMIN  |                                       | Min offset frequency to be measured                      | HP 856xE                                        | available |
| PH_FMAX  |                                       | Max offset frequency to be measured                      | HP 856xE                                        | available |
| PH_MKA   |                                       | Queries amplitude at the spot frequency                  | HP 856xE                                        | available |
| PH_DRIFT |                                       | 0: for stable signals, 1: for drifty                     | HP 856xE                                        | available |
| PH_RLVL  |                                       | Reference level for the log plot                         | HP 856xE                                        | available |
| PH_SMTHV |                                       | Trace smoothing                                          | HP 856xE                                        | available |
| PH_VBR   |                                       | Filtering                                                | HP 856xE                                        | available |
| PH_RMSPT |                                       | Amount of data points to skip when doing the integration | HP 856xE                                        | available |
| PH_RMSFL |                                       | Lower integration frequency in Hz                        | HP 856xE                                        | available |
| PH_RMSFU |                                       | Upper integration frequency in Hz                        | HP 856xE                                        | available |

| Command               | Supported subset                        | Function                                | Corresp. HP-Models                              | Status    |
|-----------------------|-----------------------------------------|-----------------------------------------|-------------------------------------------------|-----------|
| PH_EXIT               |                                         | Quits phase noise                       | HP 856xE                                        | available |
| PH_F_UDT              |                                         | Updates internal frequency variables    | HP 856xE                                        | available |
| PH_LMT_L              |                                         | Apply limits to PH_FMIN and PH_FMAX     | HP 856xE                                        | available |
| PH_MEAS               |                                         | Generates log frequency plot            | HP 856xE                                        | available |
| PH_MKF_D              |                                         | Updates the spot frequency              | HP 856xE                                        | available |
| PH_RMS                |                                         | Requests the rms phase noise            | HP 856xE                                        | available |
| PH_RMSFT              |                                         | Updates internal frequency variables    | HP 856xE                                        | available |
| PH_RMSX               |                                         | Calculates the rms phase noise          | HP 856xE                                        | available |
| PH_SPOTF              |                                         | Executes the spot frequency measurement | HP 856xE                                        | available |
| PLOTORG <sup>2)</sup> | PLOTORG DSP GRT                         | Plot command                            | HP 856xE/<br>HP 8566B/<br>HP 8568B/<br>HP 8594E | available |
| PLOTSRC <sup>2)</sup> | PLOTSRC ANNT GRT TRB TRA ALLDSP GRT     | Plot command                            | HP 856xE/<br>HP 8566B/<br>HP 8568B/<br>HP 8594E | available |
| PP                    | PP                                      | Preselector Peaking                     | HP 8566A/<br>HP 8568A                           | available |
| PRINT <sup>1)</sup>   | PRINT<br>PRINT 1 0                      | Hardcopy                                | HP 856xE/<br>HP 8566B/<br>HP 8568B/<br>HP 8594E | available |
| PSDAC <sup>2)</sup>   | PSDAC<br><numeric_value><br>PSDAC UP DN | Preselector DAC value                   | HP 856xE/<br>HP 8566B/<br>HP 8568B/<br>HP 8594E | available |
| PSTATE <sup>2)</sup>  | PSTATE ON OFF 1 0                       | Protect State                           | HP 856xE/<br>HP 8566B/<br>HP 8568B/<br>HP 8594E | available |
| PU                    | PU                                      | Pen Up                                  | HP 8566A/<br>HP 8568A                           | available |

| Command | Supported subset                                                         | Function                   | Corresp. HP-Models                              | Status    |
|---------|--------------------------------------------------------------------------|----------------------------|-------------------------------------------------|-----------|
| PWRBW   | PWRBW                                                                    | Power Bandwidth            | HP 8566B/<br>HP 859x/<br>HP 856xE               | available |
| R1      | R1                                                                       | Set Status Bit Enable      | HP 8566A/<br>HP 8568A                           | available |
| R2      | R2                                                                       | Set Status Bit Enable      | HP 8566A/<br>HP 8568A                           | available |
| R3      | R3                                                                       | Set Status Bit Enable      | HP 8566A/<br>HP 8568A                           | available |
| R4      | R4                                                                       | Set Status Bit Enable      | HP 8566A/<br>HP 8568A                           | available |
| RB      | RB <numeric_value><br>HZ KHZ MHZ GHZ<br>RB DN<br>RB UP<br>RB AUTO<br>RB? | Resolution Bandwidth       | HP 856xE/<br>HP 8566B/<br>HP 8568B/<br>HP 8594E | available |
| RBR     | RBR <numeric_value><br>RBR DN<br>RBR UP<br>RBR?                          | Resolution Bandwidth Ratio | HP 856xE/<br>HP 8566B/<br>HP 8568B/<br>HP 8594E | available |
| RC1...6 | RC1...6                                                                  | Recall Last State          | HP 8566A/<br>HP 8568A                           | available |
| RCLS    | RCLS <numeric_value>                                                     | Recall State Register      | HP 856xE/<br>HP 8566B/<br>HP 8568B/<br>HP 8594E | available |
| RCLT    | RCLT TRA TRB, <number>                                                   | Recall Trace               | HP856xE/<br>HP8594E                             | available |
| RESET   | RESET                                                                    | Instrument preset          | HP 856xE/<br>HP 8566B/<br>HP 8568B/<br>HP 8594E | available |
| REV     | REV<br>REV?                                                              | Firmware revision          | HP 856xE/<br>HP 8566B/<br>HP 8568B/<br>HP 8594E | available |

| Command             | Supported subset                                           | Function                    | Corresp. HP-Models                              | Status        |
|---------------------|------------------------------------------------------------|-----------------------------|-------------------------------------------------|---------------|
| RL                  | RL <numeric_value><br>DB DM<br>RL DN<br>RL UP<br>RL?       | Reference Level             | HP 856xE/<br>HP 8566B/<br>HP 8568B/<br>HP 8594E | available     |
| RLCAL               | RLCAL<br><numeric_value><br>RL?                            | Reference Level Calibration | HP 856xE/<br>HP 8566B/<br>HP 8568B/<br>HP 8594E | available     |
| RCLOSCAL            | RCLOSCAL                                                   | Recall Open/Short Average   | HP 856xE/<br>HP 8594E                           | not available |
| RCLTHRU             | RCLTHRU                                                    | Recall Thru                 | HP 856xE/<br>HP 8594E                           | not available |
| RLPOS <sup>1)</sup> | RLPOS<br><numeric_value><br>RLPOS DN<br>RLPOS UP<br>RLPOS? | Reference Level Position    | HP 856xE/<br>HP 8566B/<br>HP 8568B/<br>HP 8594E | available     |
| ROFFSET             | ROFFSET<br><numeric_value> DB  <br>DM<br>ROFFSET?          | Reference Level Offset      | HP 856xE/<br>HP 8566B/<br>HP 8568B/<br>HP 8594E | available     |
| RQS                 | RQS                                                        | Service Request Bit mask    | HP 856xE/<br>HP 8566B/<br>HP 8568B/<br>HP 8594E | available     |
| S1                  | S1                                                         | Continuous Sweep            | HP 8566A/<br>HP 8568A                           | available     |
| S2                  | S2                                                         | Single Sweep                | HP 8566A/<br>HP 8568A                           | available     |
| SADD                |                                                            | add a limit line segment    | HP 856xE                                        | available     |
| SAVES               | SAVES<br><numeric_value>                                   | Save State Register         | HP 856xE/<br>HP 8566B/<br>HP 8568B/<br>HP 8594E | available     |
| SAVET               | SAVET TRA TRB,<number>                                     | Save Trace                  | HP856xE/<br>HP8594E                             | available     |
| SDEL                |                                                            | delete limit line segment   | HP 856xE                                        | available     |
| SDON                |                                                            | limit line segment done     | HP 856xE                                        | available     |

| Command               | Supported subset                                                                                     | Function                | Corresp. HP-Models                                                        | Status        |
|-----------------------|------------------------------------------------------------------------------------------------------|-------------------------|---------------------------------------------------------------------------|---------------|
| SEDI                  |                                                                                                      | edit limit line segment | HP 856xE                                                                  | available     |
| SMOOTH                | SMOOTH TRA TRB <br>TRC, <number of<br>points>                                                        | Smooth Trace            | HP 856xE/<br>HP 8566B/<br>HP 8568B/<br>HP 8594E                           | available     |
| SNGLS                 | SNGLS                                                                                                | Single Sweep            | HP 856xE/<br>HP 8566B/<br>HP 8568B/<br>HP 8594E                           | available     |
| SQUELCH <sup>2)</sup> | SQUELCH<br><numeric_value><br>DM   DB<br>SQUELCH UP DN<br>SQUELCH ON OFF                             | Squelch                 | HP 856xE/<br>HP 8566B/<br>HP 8568B/<br>HP 8594E                           | available     |
| SP                    | SP <numeric_value><br>HZ KHZ MHZ GHZ<br>SP DN<br>SP UP<br>SP?                                        | Span                    | HP 8566A/<br>HP 8568A/<br>HP 856xE/<br>HP 8566B/<br>HP 8568B/<br>HP 8594E | available     |
| SRCNORM <sup>1)</sup> | SRCNORM ON OFF<br>SRCNORM 1 0                                                                        | Source Normalization    | HP 856xE/<br>HP 8566B/<br>HP 8568B/<br>HP 8594E                           | not available |
| SRCPOFS <sup>1)</sup> | SRCPOFS<br><numeric_value> DB  <br>DM<br>SRCPOFS DN<br>SRCPOFS UP<br>SRCPOFS?                        | Source Power Offset     | HP 856xE/<br>HP 8566B/<br>HP 8568B/<br>HP 8594E                           | not available |
| SRCPWR <sup>1)</sup>  | SRCPWR<br><numeric_value> DB  <br>DM<br>SRCPWR DN<br>SRCPWR UP<br>SRCPWR ON<br>SRCPWR OFF<br>SRCPWR? | Source Power            | HP 856xE/<br>HP 8566B/<br>HP 8568B/<br>HP 8594E                           | not available |



## Emulating Other Instruments' Commands

| Command              | Supported subset                                                         | Function                | Corresp. HP-Models                                                        | Status        |
|----------------------|--------------------------------------------------------------------------|-------------------------|---------------------------------------------------------------------------|---------------|
| SS                   | SS <numeric_value><br>HZ KHZ MHZ GHZ<br>SS DN<br>SS UP<br>SS AUTO<br>SS? | CF Step Size            | HP 8566A/<br>HP 8568A/<br>HP 856xE/<br>HP 8566B/<br>HP 8568B/<br>HP 8594E | available     |
| ST                   | ST <numeric_value><br>US MS SC<br>ST DN<br>ST UP<br>ST AUTO<br>ST?       | Sweep Time              | HP 8566A/<br>HP 8568A/<br>HP 856xE/<br>HP 8566B/<br>HP 8568B/<br>HP 8594E | available     |
| STB                  | STB                                                                      | Status byte query       | HP 856xE/<br>HP 8566B/<br>HP 8568B/<br>HP 8594E                           | available     |
| STOREOPEN            | STOREOPEN                                                                | Store Open              | HP 856xE/<br>HP 8594E                                                     | not available |
| STORESHORT           | STORESHORT                                                               | Store Short             | HP 856xE/<br>HP 8594E                                                     | not available |
| STORETHRU            | STORETHRU                                                                | Store Thru              | HP 856xE/<br>HP 8594E                                                     | not available |
| SUB                  |                                                                          | Subtract                | HP 8566B/<br>HP 8568B/<br>HP 8594E                                        | available     |
| SUM                  |                                                                          | sum of trace amplitudes | HP 8566B/<br>HP 8568B/<br>HP 8594E                                        | available     |
| SV1...6              | SV1...6                                                                  | Save State              | HP 8566A/<br>HP 8568A                                                     | available     |
| SWPCPL <sup>2)</sup> | SWPCPL SA   SR<br>SWPCPL?                                                | Sweep Couple            | HP 856xE/<br>HP 8566B/<br>HP 8568B/<br>HP 8594E                           | available     |
| SWPOUT <sup>2)</sup> | SWPOUT FAV FAVA <br>RAMP<br>SWPOUT?                                      | Sweep Output            | HP 856xE/<br>HP 8566B/<br>HP 8568B/<br>HP 8594E                           | available     |
| T0                   | T0                                                                       | Threshold off           | HP 8566A/<br>HP 8568A                                                     | available     |

| Command          | Supported subset                                                                   | Function                                                                                             | Corresp. HP-Models                              | Status        |
|------------------|------------------------------------------------------------------------------------|------------------------------------------------------------------------------------------------------|-------------------------------------------------|---------------|
| T1               | T1                                                                                 | Free Run Trigger                                                                                     | HP 8566A/<br>HP 8568A                           | available     |
| T2 <sup>2)</sup> | T2                                                                                 | Line Trigger                                                                                         | HP 8566A/<br>HP 8568A                           | available     |
| T3               | T3                                                                                 | External Trigger                                                                                     | HP 8566A/<br>HP 8568A                           | available     |
| T4               | T4                                                                                 | Video Trigger                                                                                        | HP 8566A/<br>HP 8568A                           | available     |
| TA               | TA                                                                                 | Transfer A                                                                                           | HP 8566A/<br>HP 8568A                           | available     |
| TACL             | TACL?                                                                              | Returns instantaneous measurement results. See TRACE<trace #>:IMMEDIATE:LEVEL? for full description. |                                                 | not available |
| TBCL             | TBCL?                                                                              |                                                                                                      |                                                 |               |
| TCCL             | TCCL?                                                                              |                                                                                                      |                                                 |               |
| TACR             | TACR?                                                                              | Returns instantaneous measurement results. See TRACE<trace #>:IMMEDIATE:LEVEL? for full description. |                                                 | not available |
| TBCR             | TBCR?                                                                              |                                                                                                      |                                                 |               |
| TCCR             | TCCR?                                                                              |                                                                                                      |                                                 |               |
| TB               | TB                                                                                 | Transfer B                                                                                           | HP 8566A/<br>HP 8568A                           | available     |
| TDF              | TDF P<br>TDF M<br>TDF B<br>TDF A<br>TDF I                                          | Trace Data Format                                                                                    | HP 856xE/<br>HP 8566B/<br>HP 8568B/<br>HP 8594E | available     |
| TH               | TH <numeric_value><br>DB DM<br>TH DN<br>TH UP<br>TH ON<br>TH OFF<br>TH AUTO<br>TH? | Threshold                                                                                            | HP 856xE/<br>HP 8566B/<br>HP 8568B/<br>HP 8594E | available     |

| Command               | Supported subset                              | Function                                         | Corresp. HP-Models                              | Status    |
|-----------------------|-----------------------------------------------|--------------------------------------------------|-------------------------------------------------|-----------|
| THE                   | THE ON  OFF                                   | Threshold Line enable                            | HP 856xE/<br>HP 8566B/<br>HP 8568B/<br>HP 8594E | available |
| TIMEDSP <sup>1)</sup> | TIMEDSP ON OFF<br>TIMEDSP 1 0<br>TIMEDSP?     | Time Display                                     | HP 856xE/<br>HP 8566B/<br>HP 8568B/<br>HP 8594E | available |
| TM                    | TM FREE VID EXT <br>LINE <sup>2)</sup><br>TM? | Trigger Mode                                     | HP 856xE/<br>HP 8566B/<br>HP 8568B/<br>HP 8594E | available |
| TM LINE <sup>2)</sup> | TM LINE                                       | Trigger Line                                     | HP 8566B                                        | available |
| TRA                   | TRA B<br>TRA A<br>TRA I                       | Transfer A                                       | HP 856xE/<br>HP 8566B/<br>HP 8568B/<br>HP 8594E | available |
| TRB                   | TRB B<br>TRB A<br>TRB I                       | Transfer B                                       | HP 856xE/<br>HP 8566B/<br>HP 8568B/<br>HP 8594E | available |
| TRSTAT                | TRSTAT?                                       | Trace State Query                                | HP 856xE/<br>HP 8566B/<br>HP 8568B/<br>HP 8594E | available |
| TS                    | TS                                            | Take Sweep                                       | HP 856xE/<br>HP 8566B/<br>HP 8568B/<br>HP 8594E | available |
| UR <sup>2)</sup>      | UR                                            | Plot Command                                     | HP 8566A/<br>HP 8568A                           | available |
| VARDEF                | VARDEF                                        | Variable definition,<br>arrays are not supported | HP 8566B/<br>HP 8568B/<br>HP 8594E              | available |
| VAVG                  | VAVG<br>VAVG TRA TRB TRC                      | Video Averaging                                  | HP 856xE/<br>HP 8566B/<br>HP 8568B/<br>HP 8594E | available |

| Command                                                      | Supported subset                                                         | Function              | Corresp. HP-Models                              | Status        |
|--------------------------------------------------------------|--------------------------------------------------------------------------|-----------------------|-------------------------------------------------|---------------|
| VB                                                           | VB <numeric_value><br>HZ KHZ MHZ GHZ<br>VB DN<br>VB UP<br>VB AUTO<br>VB? | Video Bandwidth       | HP 856xE/<br>HP 8566B/<br>HP 8568B/<br>HP 8594E | available     |
| VBR <sup>1)</sup>                                            | VBR <numeric_value><br>VBR DN<br>VBR UP<br>VBR?                          | Video Bandwidth Ratio | HP 856xE/<br>HP 8566B/<br>HP 8568B/<br>HP 8594E | available     |
| VIEW                                                         | VIEW TRA TRB TRC                                                         |                       | HP 856xE/<br>HP 8566B/<br>HP 8568B/<br>HP 8594E | available     |
| VTL                                                          | VTL <numeric_value><br>DB DM<br>VTL DN<br>VTL UP<br>VTL?                 | Video Trigger Level   | HP 856xE/<br>HP 8594E                           | not available |
| 1) HP 8594E only                                             |                                                                          |                       |                                                 |               |
| 2) Command is accepted without error message, but is ignored |                                                                          |                       |                                                 |               |

### 12.13.2.2 Special Features of the Syntax Parsing Algorithms for 8566A and 8568A Models

The command syntax is very different for models A and B. Different names are assigned to identical instrument functions, and the command structure likewise differs considerably between models A and models B.

The command structure for models A is as follows:

```
<command> ::= <command
code> [<SPC>] [<data> | <step>] [<SPC>] [<delimiter>] [<command
code>] ... <delimiter>
```

```
<data> ::= <Value> [<SPC>] [<units
code>] [<SPC>] [<delimiter>] [<SPC>] [<data>] ...
```

```
<step> ::= UP | DN
```

where

<command code> = see Table "Supported Commands"

<Value> = integer or floating-point numerical value

<units code> = DM | -DM | DB | HZ | KZ | MZ | GZ | MV | UV | SC | MS | US

<delimiter> = <CR> | <LF> | <, > | <; > | <ETX>

<SPC> = 32<sub>10</sub>

<ETX> = 3<sub>10</sub>

Command sections given in [ ] are optional.

The R&S FPS GPIB hardware differs from that used in the HP analyzers. Therefore, the following constraint exists:

<LF>| <EOI> are still used as delimiters since the GPIB hardware is able to identify them. The other delimiters are identified and evaluated during syntax analysis.

### 12.13.2.3 Special Behavior of Commands

| Command | Known Differences                                                                                                                                                                                                                   |
|---------|-------------------------------------------------------------------------------------------------------------------------------------------------------------------------------------------------------------------------------------|
| ABORT   | Does not automatically set the command complete bit (bit 4) in the status byte. An additional DONE is required for that purpose.                                                                                                    |
| ANNOT   | Only frequency axis annotation is affected.                                                                                                                                                                                         |
| AT      | AT DN/UP: Step size                                                                                                                                                                                                                 |
| CAL     | The CAL commands do not automatically set the command complete bit (bit 4) in the status byte. An additional DONE command is required for that purpose.                                                                             |
| CF      | Default value, range, step size                                                                                                                                                                                                     |
| CR      | Default ratio Span/RBW                                                                                                                                                                                                              |
| CT      | Formula for coupled sweep time                                                                                                                                                                                                      |
| CV      | Default ratio RBW/VBW                                                                                                                                                                                                               |
| DET     | DET? returns SAMP instead of SMP on the R&S FPS.<br>DET not automatically set the command complete bit (bit 4) in the status byte. An additional DONE is required for that purpose.                                                 |
| ERR?    | Deletes the error bit in the status register but always returns a '0' in response.                                                                                                                                                  |
| FA      | Default value, range, step size                                                                                                                                                                                                     |
| FB      | Default value, range, step size                                                                                                                                                                                                     |
| ID      |                                                                                                                                                                                                                                     |
| M2      | Default value, range, step size                                                                                                                                                                                                     |
| M3      | Default value, range, step size                                                                                                                                                                                                     |
| MKACT   | Only marker 1 is supported as the active marker.                                                                                                                                                                                    |
| MKBW    | Default value                                                                                                                                                                                                                       |
| MKPT    | Step size                                                                                                                                                                                                                           |
| MKPX    | Step size                                                                                                                                                                                                                           |
| OL?     | Storage of instrument settings:<br>80 characters are returned as information on the instrument settings.<br>The contents of the 80 characters returned does not correspond to the original data contents of the 8566A/8568A family. |

| Command | Known Differences                                                                                                                                                                                                                                                      |
|---------|------------------------------------------------------------------------------------------------------------------------------------------------------------------------------------------------------------------------------------------------------------------------|
| OL      | Readout of instrument settings:<br>The 80 characters read by means of OL? are accepted as information on the corresponding instrument settings.<br>The contents of the 80 characters read does not correspond to the original data contents of the 8566A/8568A family. |
| RB      | Default value, range, step size                                                                                                                                                                                                                                        |
| RL      | Default value, step size                                                                                                                                                                                                                                               |
| RLPOS   | Adapts the position of the reference level even if the tracking generator normalization is not active.                                                                                                                                                                 |
| RQS     | Supported bits:<br>1 (Units key pressed)<br>2 (End of Sweep)<br>3 (Device error)<br>4 (Command complete)<br>5 (Illegal command)                                                                                                                                        |

#### 12.13.2.4 Model-Dependent Default Settings

If the GPIB language is switched over to an 85xx model, the GPIB address is automatically switched over to 18 provided that the default address of the R&S FPS (20) is still set. If a different value is set, this value is maintained. Upon return to SCPI, this address remains unchanged.

The following table shows the default settings obtained after a change of the GPIB language and for the commands IP, KST and RESET:

| Model   | # of Trace Points | Start Freq. | Stop Freq. | Ref Level | Input Coupling |
|---------|-------------------|-------------|------------|-----------|----------------|
| 8566A/B | 1001              | 2 GHz       | 22 GHz     | 0 dBm     | AC             |
| 8568A/B | 1001              | 0 Hz        | 1.5 GHz    | 0 dBm     | AC             |
| 8560E   | 601               | 0 Hz        | 2.9 GHz    | 0 dBm     | AC             |
| 8561E   | 601               | 0 Hz        | 6.5 GHz    | 0 dBm     | AC             |
| 8562E   | 601               | 0 Hz        | 13.2 GHz   | 0 dBm     | AC             |
| 8563E   | 601               | 0 Hz        | 26.5 GHz   | 0 dBm     | AC             |
| 8564E   | 601               | 0 Hz        | 40 GHz     | 0 dBm     | AC             |
| 8565E   | 601               | 0 Hz        | 50 GHz     | 0 dBm     | AC             |
| 8594E   | 401               | 0 Hz        | 3 GHz      | 0 dBm     | AC             |



### Stop frequency

The stop frequency given in the table may be limited to the corresponding frequency range of the R&S FPS.

Command LF sets the stop frequency for 8566A/B to a maximum value of 2 GHz.

### Test points (trace points)

The number of trace points is switched over only upon transition to the REMOTE state.

#### 12.13.2.5 Data Output Formats

In the case of the SCPI and IEEE488.2 standards, the output formats for numerical data are flexible to a large extent. The output format for the HP units, by contrast, is accurately defined with respect to the number of digits. The memory areas for reading instrument data have therefore been adapted accordingly in the remote-control programs for instruments of this series.

Therefore, in response to a query, the R&S FPS returns data of the same structure as that used by the original instruments; this applies in particular to the number of characters returned.

Two formats are currently supported when trace data is output: Display Units (command O1) and physical values (command O2, O3 or TDF P). As to the "Display Units" format, the level data of the R&S FPS is converted to match the value range and the resolution of the 8566/8568 series. Upon transition to the **REMOTE** state, the R&S FPS is reconfigured such that the number of test points (trace points) corresponds to that of the 85xx families (1001 for 8566A/B and 8568A/B, 601 for 8560E to 8565E, 401 for 8594E).

#### 12.13.2.6 Trace Data Output Formats

All formats are supported for trace data output: display units (command O1), display units in two byte binary data (command O2 or TDF B and MDS W), display units in one byte binary data (command O4 or TDF B and MDS B) and physical values (commands O3 or TDF P). With format "display units" the level data is converted into value range and resolution of the 8566/8568 models. On transition to REMOTE state the number of trace points are reconfigured in order to be conform to the selected instrument model (1001 for 8566A/B and 8568 A/B, 601 for 8560E to 8565E, 401 for 8594E).

#### 12.13.2.7 Trace Data Input Formats

Trace data input is only supported for binary date (TDF B, TDF A, TDF I, MDS W, MDS B).

#### 12.13.2.8 GPIB Status Reporting

The assignment of status bits by commands R1, R2, R3, R4, RQS is supported.

The STB command and the serial poll respond with an 8-bit value with the following assignment:

| Bit enabled by RQS | Description        |
|--------------------|--------------------|
| 0                  | not used (value 0) |
| 1                  | Units key pressed  |
| 2                  | End of Sweep       |
| 3                  | Device Error       |
| 4                  | Command Complete   |
| 5                  | Illegal Command    |
| 6                  | Service Request    |
| 7                  | not used (value 0) |

Bits 0 and 7 are not used and always have the value 0.

Please note that the R&S FPS reports any key pressed on the front panel rather than only the unit keys if bit 1 was enabled.

Another difference is the behavior of bit 6 when using the STB? query. On the HP analyzers this bit monitors the state of the SRQ line on the bus. On the R&S FPS this is not possible. Therefore this bit is set, as soon as one of the bits 1 to 5 is set. It won't be reset by performing a serial poll.

### 12.13.3 Reference: Command Set of Emulated PSA Models

The R&S FPS analyzer family supports a subset of the GPIB commands of PSA89600 and ESA instruments.

Despite the differences in system architecture and device features, the supported commands have been implemented in a way to ensure a sufficiently high degree of correspondence with the original.

In many cases the selection of commands supported by the R&S FPS is sufficient to run an existing GPIB program without adaptation.

| Supported 89600 commands |
|--------------------------|
| *CAL?                    |
| *CLS                     |
| *ESE                     |
| *ESR?                    |
| *IDN?                    |
| *IST?                    |
| *OPC                     |



| Supported 89600 commands                                |
|---------------------------------------------------------|
| *OPT?                                                   |
| *PCB                                                    |
| *PRE                                                    |
| *PSC                                                    |
| *RST                                                    |
| *SRE                                                    |
| *STB?                                                   |
| *TRG                                                    |
| *TST?                                                   |
| *WAI                                                    |
| :CALibration:AUTO OFF ON ALERT                          |
| :CALibration:TCORrections AUTO ON OFF                   |
| :CONFigure:WAVeform                                     |
| :DIAGnostic:EABY ON OFF                                 |
| :DIAGnostic:LATCh:VALue <numeric>                       |
| :DIAGnostic:LATCh:SElect <string>                       |
| :DISPlay:ANNotation:TITLe:DATA <string>                 |
| :DISPlay:ENABle OFF ON                                  |
| :DISPlay:WINDow:TRACe:Y:[SCALe]:PDIVision <numeric>     |
| :DISPlay:WINDow:TRACe:Y:[SCALe]:RLEVel <numeric>        |
| :DISPlay:WINDow:TRACe:Y:[SCALe]:RLEVel:OFFSet <numeric> |
| :FORMat:BORDer NORMAl SWAPped                           |
| :FORMat[:DATA] ASCii REAL UINT MATLAB,<numeric>         |
| :INITiate:CONTInuous OFF ON                             |
| :INITiate[:IMMediate]                                   |
| :INSTrument:CATalog?                                    |
| :INSTrument:NSElect <numeric>                           |
| :MMEMory:CATalog? <dir_name>                            |
| :MMEMory:COpy <'file_name1'>,<'file_name2'>             |
| :MMEMory:DATA <'file_name'>,<definite_length_block>     |
| :MMEMory:DELeTe <'file_name'>                           |
| :MMEMory:LOAD:STATe 1,<'file_name'>                     |
| :MMEMory:LOAD:TRACe 1,<'file_name'>                     |

| Supported 89600 commands                                     |
|--------------------------------------------------------------|
| :MMEMory:MDIRectory <'dir_name'>                             |
| :MMEMory:MOVE <'file_name1'>,<'file_name2'>                  |
| :MMEMory:STORe:STATe 1,<'file_name'>                         |
| :MMEMory:STORe:TRACe <numeric>,<'file_name'>                 |
| :READ:WAVform?                                               |
| [[:SENSe]:FREQUency:CENTer <numeric>                         |
| [[:SENSe]:FREQUency:STARt <numeric>                          |
| [[:SENSe]:FREQUency:STOP <numeric>                           |
| [[:SENSe]:FREQUency:SPAN <numeric>                           |
| [[:SENSe]:POWer:ATTenuation <numeric>                        |
| [[:SENSe]:ROSCillator:EXTernal:FREQUency <numeric>           |
| [[:SENSe]:ROSCillator:OUTPut OFF ON                          |
| [[:SENSe]:ROSCillator:SOURce INTernal EXTernal EAUto         |
| [[:SENSe]:SPECTrum:TRIGger:SOURce EXTernal<1 2> IF IMMediate |
| [[:SENSe]:WAVeform:ADC:RANGe P6                              |
| [[:SENSe]:WAVeform:APER?                                     |
| [[:SENSe]:WAVeform:AVERage:TACount <numeric>                 |
| [[:SENSe]:WAVeform:BWIDth:ACTive?                            |
| [[:SENSe]:WAVeform:BWIDth:TYPE FLAT GAUSSian                 |
| [[:SENSe]:WAVeform:IFGain <numeric>                          |
| [[:SENSe]:WAVeform:IFPath NARRow WIDE                        |
| [[:SENSe]:WAVeform:NCPTTrace ON OFF                          |
| [[:SENSe]:WAVeform:PDIT ON OFF                               |
| [[:SENSe]:WAVeform:SRATe <numeric>                           |
| [[:SENSe]:WAVeform:SWEp:TIME <numeric>                       |
| [[:SENSe]:WAVeform:TRIGger:EOFFset?                          |
| [[:SENSe]:WAVeform:TRIGger:INTerpolation ON OFF              |
| [[:SENSe]:WAVeform:TRIGger:SOURce EXTernal<1 2> IF IMMediate |
| :STATus:QUESTionable:CONDition?                              |
| :STATus:QUESTionable:ENABle <number>                         |
| :STATus:QUESTionable:NTRansition <number>                    |
| :STATus:QUESTionable:PTRansition <number>                    |
| :STATus:QUESTionable[:EVENT]?                                |

| Supported 89600 commands                                                                                                  |
|---------------------------------------------------------------------------------------------------------------------------|
| :STATus:QUESTionable:CALibration:CONDition?                                                                               |
| :STATus:QUESTionable:CALibration:ENABle <number>                                                                          |
| :STATus:QUESTionable:CALibration:NTRansition <number>                                                                     |
| :STATus:QUESTionable:CALibration:PTRansition <number>                                                                     |
| :STATus:QUESTionable:CALibration[:EVENT]?                                                                                 |
| :STATus:QUESTionable:FREQuency:CONDition?                                                                                 |
| :STATus:QUESTionable:FREQuency:ENABle <number>                                                                            |
| :STATus:QUESTionable:FREQuency:NTRansition <number>                                                                       |
| :STATus:QUESTionable:FREQuency:PTRansition <number>                                                                       |
| :STATus:QUESTionable:FREQuency[:EVENT]?                                                                                   |
| :STATus:QUESTionable:INTEgrity:CONDition?                                                                                 |
| :STATus:QUESTionable:INTEgrity:ENABle <number>                                                                            |
| :STATus:QUESTionable:INTEgrity:NTRansition <number>                                                                       |
| :STATus:QUESTionable:INTEgrity:PTRansition <number>                                                                       |
| :STATus:QUESTionable:INTEgrity[:EVENT]?                                                                                   |
| :STATus:OPERation:CONDition?                                                                                              |
| :STATus:OPERation:ENABle <integer>                                                                                        |
| :STATus:OPERation:NTRansition <integer>                                                                                   |
| :STATus:OPERation:PTRansition <integer>                                                                                   |
| :STATus:OPERation[:EVENT]?                                                                                                |
| :SYSTem:COMMunicate:GPIB[:SELF]:ADDRess <integer>                                                                         |
| :SYSTem:DATE <year>,<month>,<day>                                                                                         |
| :SYSTem:ERRor[:NEXT]?                                                                                                     |
| :SYSTem:KLOCK?                                                                                                            |
| :SYSTem:MESSAge <string>                                                                                                  |
| :SYSTem:PRESet                                                                                                            |
| :SYSTem:TIME <hour>,<minute>,<second>                                                                                     |
| :SYSTem:VERSion?                                                                                                          |
| :TRACe:COPY <src_trace>,<dest_trace>                                                                                      |
| :TRACe[:DATA] TRACE1   TRACE2   TRACE3   TRACE4   TRACE5   TRACE6, <definite_length_block>   <comma_separated_ASCII_data> |
| :TRACe:MODE WRITe MAXHold MINHold VIEW BLANK                                                                              |
| :TRIGger[:SEQuence]:DELay <numeric>                                                                                       |
| :TRIGger[:SEQuence]:DELay:STATe OFF ON 0 1                                                                                |

| Supported 89600 commands                                 |
|----------------------------------------------------------|
| :TRIGger[:SEquence]:EXTerMal:DELay <numeric>             |
| :TRIGger[:SEquence]:EXTerMal:LEVel <numeric>             |
| :TRIGger[:SEquence]:EXTerMal:SLOPe POSitive NEGative     |
| :TRIGger[:SEquence]:HOLDoff <numeric>                    |
| :TRIGger[:SEquence]:IF:DELay <numeric>                   |
| :TRIGger[:SEquence]:IF:LEVel <numeric>                   |
| :TRIGger[:SEquence]:IF:SLOPe POSitive NEGative           |
| :TRIGger[:SEquence]:SLOPe POSitive NEGative              |
| :TRIGger[:SEquence]:SOURce IMMEDIATE VIDeo EXTerMal<1 2> |
| :TRIGger[:SEquence]:VIDeo:LEVel <numeric>                |
| :TRIGger[:SEquence]:VIDeo:LEVel:FREQuency <freq>         |

### 12.13.4 Reference: Command Set of Emulated PXA Models

The R&S FPS analyzer family supports a subset of the GPIB commands of PXA instruments.

Despite the differences in system architecture and device features, the supported commands have been implemented in a way to ensure a sufficiently high degree of correspondence with the original.

In many cases the selection of commands supported by the R&S FPS is sufficient to run an existing GPIB program without adaptation.

**Table 12-10: Supported PXA commands**

|                                                                 |
|-----------------------------------------------------------------|
| ABORt                                                           |
| CALCulate:MARKer:AOff                                           |
| CALCulate:MARKer[1] 2 ...12:MAXimum                             |
| CALCulate:MARKer[1] 2 ...12:MAXimum:LEFT                        |
| CALCulate:MARKer[1] 2 ...12:MAXimum:NEXT                        |
| CALCulate:MARKer[1] 2 ...12:MAXimum:RIGHT                       |
| CALCulate:MARKer[1] 2 ...12:MINimum                             |
| CALCulate:MARKer[1] 2 ...12:MODE POSition   DELTa   FIXed   OFF |
| CALCulate:MARKer[1] 2 ...12:MODE[?] SPAN   BAND                 |
| CALCulate:MARKer[1] 2 ...12[:SET]:CENTer                        |
| CALCulate:MARKer[1] 2 ...12[:SET]:RLEVel                        |
| CALCulate:MARKer[1] 2 ...12[:SET]:START                         |
| CALCulate:MARKer[1] 2 ...12[:SET]:STOP                          |

|                                                                   |
|-------------------------------------------------------------------|
| CALCulate:MARKer[1][2]...12:STATe[?] OFF   ON   0   1             |
| CALCulate:MARKer[1][2]...12:X[?] <freq   time>                    |
| CALCulate:MARKer[1][2]...12:X:POSition[?] <real>                  |
| CALCulate:MARKer[1][2]...4:X:SPAN                                 |
| CALCulate:MARKer[1][2]...4:X:START                                |
| CALCulate:MARKer[1][2]...4:X:STOP                                 |
| CALCulate:MARKer[1][2]...12:Y[?] <real>                           |
| CALibration[:ALL][?]                                              |
| CALibration:AUTO[?] ON   PARTial   OFF   ALERT                    |
| CALibration:AUTO:ALERT[?] TEMperature   DAY   WEEK   NONE         |
| CALibration:AUTO:MODE[?] ALL   NRF                                |
| CALibration:AUTO:TIME:OFF?                                        |
| CONFigure? SAN                                                    |
| DISPlay:WINDow[1]:TRACe:Y[:SCALe]:RLEVel[?] <real>                |
| DISPlay:WINDow[1]:TRACe:Y[:SCALe]:RLEVel:OFFSet[?] <rel_ampl>     |
| INITiate:CONTinuous[?] OFF   ON   0   1                           |
| INITiate[:IMMediate]                                              |
| INPut:COUPling[?] AC   DC                                         |
| MMEMory:CATalog? [<directory_name>]                               |
| MMEMory:CDIRectory[?] [<directory_name>]                          |
| MMEMory:COpy <string>, <string>[, <string>, <string>]             |
| MMEMory:DATA[?] <file_name>, <data>                               |
| MMEMory:DELeTe <file_name>[, <directory_name>]                    |
| MMEMory:LOAD:STATe 1, <filename>                                  |
| MMEMory:MDIRectory <directory_name>                               |
| MMEMory:MOVE <string>, <string>[, <string>, <string>]             |
| MMEMory:RDIRectory <directory_name>                               |
| MMEMory:STORe:STATe 1, <filename>                                 |
| [:SENSe]:AVERAge:COUNt[?] <integer>                               |
| [:SENSe]:AVERAge[:STATe][?] ON   OFF   1   0                      |
| [:SENSe]:AVERAge:TYPE[?] RMS   LOG   SCALar[:SENSe]:AVERAge:TYPE? |
| [:SENSe]:BANDwidth BWIDth[:RESolution][?] <freq>                  |
| [:SENSe]:BANDwidth BWIDth[:RESolution]:AUTO[?] OFF   ON   0   1   |
| [:SENSe]:BANDwidth BWIDth:VIDeo[?] <freq>                         |

## Emulating Other Instruments' Commands

|                                                                                                                       |
|-----------------------------------------------------------------------------------------------------------------------|
| [[:SENSe]:BANDwidth BWIDth:VIDeo:AUTO[?]] OFF   ON   0   1                                                            |
| [[:SENSe]:BANDwidth BWIDth:VIDeo:RATio[?]] <real>                                                                     |
| [[:SENSe]:BANDwidth BWIDth:VIDeo:RATio:AUTO[?]] OFF   ON   0   1                                                      |
| [[:SENSe]:DETEctor:AUTO[?]] ON   OFF   1   0                                                                          |
| [[:SENSe]:FREQuency:CENTer[?]] <freq>                                                                                 |
| [[:SENSe]:FREQuency:CENTer:STEP:AUTO[?]] OFF   ON   0   1                                                             |
| [[:SENSe]:FREQuency:OFFSet[?]] <freq>                                                                                 |
| [[:SENSe]:FREQuency:SPAN[?]] <freq>                                                                                   |
| [[:SENSe]:FREQuency:SPAN:FULL                                                                                         |
| [[:SENSe]:FREQuency:STARt[?]] <freq>                                                                                  |
| [[:SENSe]:FREQuency:STOP[?]] <freq>                                                                                   |
| [[:SENSe]:POWEr[:RF]:ATTenuation[?]] <rel_ampl>                                                                       |
| [[:SENSe]:POWEr[:RF]:ATTenuation:AUTO[?]] OFF   ON   0   1                                                            |
| [[:SENSe]:SWEep:POINts? <integer>                                                                                     |
| [[:SENSe]:SWEep:TIME? <time>                                                                                          |
| [[:SENSe]:SWEep:TIME:AUTO? OFF   ON   0   1                                                                           |
| TRIGger[:SEQuence]:EXTernal2:DELay[?] <time>                                                                          |
| TRIGger[:SEQuence]:EXTernal1:DELay[?] <time>                                                                          |
| TRIGger[:SEQuence]:EXTernal2:DELay:STATe[?] OFF   ON   0   1                                                          |
| TRIGger[:SEQuence]:EXTernal1:DELay:STATe[?] OFF   ON   0   1                                                          |
| TRIGger[:SEQuence]:EXTernal2:LEVel[?] <level>                                                                         |
| TRIGger[:SEQuence]:EXTernal1:LEVel[?] <level>                                                                         |
| TRIGger[:SEQuence]:EXTernal2:SLOPe[?] POSitive   NEGative                                                             |
| TRIGger[:SEQuence]:EXTernal1:SLOPe[?] POSitive   NEGative                                                             |
| TRIGger[:SEQuence]:IF:LEVel[?]                                                                                        |
| TRIGger[:SEQuence]:IF:SLOPe[?] NEGative   POSitive                                                                    |
| TRIGger[:SEQuence]:SOURCe EXTernal   IMMEDIATE   VIDEO   LINE   EXTernal1   EXT1   EXTernal2   EXT2   RFBurst   FRAME |
| TRIGger[:SEQuence]:VIDeo:DELay[?] <time>                                                                              |
| TRIGger[:SEQuence]:VIDeo:DELay:STATe[?] OFF   ON   0   1                                                              |
| TRIGger[:SEQuence]:VIDeo:LEVel[?] <ampl>                                                                              |
| TRIGger[:SEQuence]:VIDeo:SLOPe[?] POSitive   NEGative                                                                 |

## 12.14 Deprecated Commands

The following commands are provided for compatibility to other signal analyzers only. For new remote control programs use the specified alternative commands.

|                                         |      |
|-----------------------------------------|------|
| CALCulate<n>:LIMit<k>:TRACe.....        | 1039 |
| DISPlay[:WINDow<n>]:STATe.....          | 1039 |
| DISPlay[:WINDow<n>]:TYPE.....           | 1040 |
| HCOPY:ITEM:ALL.....                     | 1040 |
| [SENSe:]ESpectrum<sb>:SBCenter.....     | 1040 |
| [SENSe:]ESpectrum<sb>:SBCount.....      | 1040 |
| TRIGger[:SEQuence]:RFPower:HOLDoff..... | 1041 |

---

### CALCulate<n>:LIMit<k>:TRACe <TraceNumber>

This command links a limit line to one or more traces.

Note that this command is maintained for compatibility reasons only. Limit lines no longer need to be assigned to a trace explicitly. The trace to be checked can be defined directly (as a suffix) in the new command to activate the limit check (see [CALCulate<n>:LIMit<k>:TRACe<t>:CHECK](#) on page 931).

#### Suffix:

<n>                      Window

<k>                      Limit line

#### Parameters:

<TraceNumber>        1 to 6  
\*RST:                1

#### Example:

CALC:LIM2:TRAC 3  
Assigns limit line 2 to trace 3.

---

### DISPlay[:WINDow<n>]:STATe <State>

This command changes the display state of the selected measurement window.

Note that this command is maintained for compatibility reasons only. Use the `LAYout` commands for new remote control programs

(See [Chapter 12.6.2, "Working with Windows in the Display"](#), on page 766).

#### Suffix:

<n>                      Window

#### Parameters:

<State>                ON | OFF | 1 | 0  
**OFF | 0**  
The window is closed.  
\*RST:                0

---

**DISPlay[:WINDow<n>]:TYPE <WindowType>**

This command selects the results displayed in a measurement window.

Note that this command is maintained for compatibility reasons only. Use the `LAYout` commands for new remote control programs (see [Chapter 12.6.2, "Working with Windows in the Display"](#), on page 766).

The parameter values are the same as for `LAYout:ADD[:WINDow]?` on page 767.

**Suffix:**

<n>                      [Window](#)

---

**HCOPY:ITEM:ALL**

This command is maintained for compatibility reasons only. It has no effect.

**Usage:**                      Setting only

---

**[SENSe:]ESpectrum<sb>:SBCenter <Frequency>**

This command defines the center frequency of the selected sub block in a Multi-SEM measurement.

**Suffix:**

<sb>                      1 | 2 | 3  
Sub block in a Multi-SEM measurement

**Parameters:**

<Frequency>              Frequency within the currently defined global span (see [\[SENSe:\]FREQuency:SPAN](#) on page 779 and [\[SENSe:\]FREQuency:CENTer](#) on page 777).

Range:                  1 to 3

\*RST:                    1

**Example:**                  `ESP2:SBCenter 1GHZ`

---

**[SENSe:]ESpectrum<sb>:SBCount <SubBlocks>**

This command defines the number of sub blocks in the SEM measurement. (<sb> is irrelevant)

**Parameters:**

<SubBlocks>              Number of sub blocks in the SEM measurement.

Range:                  1 to 3

\*RST:                    1

**Example:**                  `ESP:SBCount 2`

---



**TRIGger[:SEQuence]:RFPower:HOLDoff <Time>**

This command defines the holding time before the next trigger event. Note that this command is available for any trigger source, not just RF Power.

Note that this command is maintained for compatibility reasons only. Use the [TRIGger\[:SEQuence\]:IFPower:HOLDoff](#) on page 801 command for new remote control programs.

**Parameters:**

<Time>                      Default unit: S

## 12.15 Programming Examples

Some advanced programming examples for complex measurement tasks are provided here.



Further programming examples for common measurement tasks are described in the individual measurement chapters, for example:

- [Chapter 12.4.3, "Programming Example: Performing a Sequence of Measurements"](#), on page 631
- ["Programming Example: Using Limit Lines"](#) on page 933
- [Chapter 12.5.3.10, "Programming Examples for Channel Power Measurements"](#), on page 673
- ["Programming example: Measuring the carrier-to-noise ratio"](#) on page 677
- [Chapter 12.5.5.2, "Programming Example: OBW Measurement"](#), on page 679
- [Chapter 12.5.6.11, "Example: SEM Measurement"](#), on page 712
- [Chapter 12.5.7.6, "Programming Example: Spurious Emissions Measurement"](#), on page 726
- [Chapter 12.5.8.7, "Programming Example: Measuring Statistics"](#), on page 736
- [Chapter 12.5.9.4, "Programming Example: Time Domain Power"](#), on page 747
- [Chapter 12.5.10.5, "Example: Measuring the Harmonic Distortion"](#), on page 751
- [Chapter 12.5.11.2, "Programming Example: Measuring the TOI"](#), on page 753
- [Chapter 12.5.12.2, "Example: Measuring the AM Modulation Depth"](#), on page 755
- [Chapter 12.5.14.2, "Example: Performing a Pulse Power Measurement"](#), on page 765
- [Chapter 12.8.2.7, "Programming Example: Configuring a Spectrogram"](#), on page 859
- ["Programming Example for External Generator Control"](#) on page 822

- [Programming Example: Performing a Basic Frequency Sweep](#)..... 1042
- [Service Request](#)..... 1044

### 12.15.1 Programming Example: Performing a Basic Frequency Sweep

This example demonstrates how to configure and perform a basic frequency sweep measurement in a remote environment.

```
//-----Preparing the measurement -----
*RST
//Resets the instrument
INIT:CONT OFF
//Selects single sweep mode.

//-----Configuring the Frequency and Span-----
FREQ:CENT 100MHz
//Defines the center frequency
FREQ:SPAN 200MHz
//Sets the span to 100 MHz on either side of the center frequency.

//Activate signal tracking to keep the center frequency on the signal peak:
CALC:MARK:FUNC:STR ON
CALC:MARK:FUNC:STR:BAND 20MHz
CALC:MARK:FUNC:STR:THR -90dBm
CALC:MARK:FUNC:STR:TRAC 1
//After each sweep the maximum on trace 1 is searched within a range of 20 MHz
//around the center frequency. It must have a minimum power of -90dBm.

//-----Configuring the Bandwidth-----
BAND:AUTO OFF
BAND 1MHz
BAND:TYPE RRC
//Defines the RBW as 1 MHz using an RRC filter

BAND:VID:AUTO OFF
BAND:VID 500kHz
//Decouples the VBW from the RBW and decreases it to smooth the trace.

//-----Configuring the Sweep-----
SENS:SWE:COUN 10
//Defines 10 sweeps to be performed in each measurement.
SENS:SWE:POIN 500
//During each sweep, 500 trace points will be measured.
SENS:SWE:TIME:AUTO OFF
SENS:SWE:TIME 50ms
//Decouples the sweep time from the RBW,VBW and span and increases it to
//make the measurement more precise.

//-----Configuring Attenuation-----
//Only if electronic attenuator is available:
//INP:EATT:STAT ON
//Switches on the electronic attenuator.
//INP:EATT 30dB
```

```

//Sets the electronic attenuation to 30 dB.
INP:ATT 10dB
//Sets the mechanical attenuation to 10 dB and couples the reference level
//to the attenuation instead of vice versa.

//-----Configuring the Amplitude and Scaling-----
DISP:TRAC1:Y:RLEV -10dBm
//Sets the reference level to -10 dBm.
DISP:TRAC1:Y:RLEV:OFFS 10dB
//Shifts the trace display in the diagram up by 10dB.
CALC:UNIT:POW V
//Sets the unit of the y-axis to Volt. The reference level is now 70.711 mV.
DISP:TRAC1:Y:SPAC LOG
//Uses logarithmic scaling with absolute values (V).
DISP:TRAC1:Y 110dB
//Increases the displayed range of the y-axis to 110 dB.
DISP:TRAC1:Y:RPOS 80PCT
//Shifts the display of the reference level down, it is no longer the top line
//in the diagram. The reference level is displayed as a red line.

//-----Triggering-----
TRIG:SOUR IFP
TRIG:LEV:IFP -10dBm
TRIG:SLOP POS
TRIG:DTIM 50ms
TRIG:IFP:HYST 5dB
TRIG:HOLD 10ms
//Defines triggering when the second intermediate frequency rises to a level
//of -10 dBm, with a dropout time of 50 ms, a hysteresis of 5 dB and a delay
//of 10 ms.

SWE:EGAT ON
SWE:EGAT:TYPE EDGE
SWE:EGAT:LENG 5ms
//Defines gating. Values are measured for 5 ms after triggering.

OUTP:TRIG2:DIR OUTP
OUTP:TRIG2:OTYP UDEF
OUTP:TRIG2:LEV HIGH
OUTP:TRIG2:PULS:LENG 100us
OUTP:TRIG2:PULS:IMM
//Configures a high trigger signal with a pulse length of 100 us to be output at
//the front TRIGGER INPUT/OUTPUT connector once.

//-----Configuring the Trace-----
DISP:TRAC2 ON
DISP:TRAC2:MODE AVER
DISP:TRAC3 ON
DISP:TRAC3:MODE MAXH

```

```

//Configures 3 traces: 1 (default): clear/write; 2: average; 3: max hold

SENS:DET1 POS
SENS:DET2 RMS
SENS:DET3 POS
//Configures traces 1 and 3 to use the positive peak detector; trace 2 uses
//the RMS detector.

TRAC:COPY TRACE4,TRACE1
//Copies trace 1 to a new trace 4 which will then be averaged.

SENS:AVER:STAT4 ON
SENS:AVER:COUN 10
SENS:AVER:TYPE LIN
//Configures trace 4 to be averaged linearly over 10 sweeps.

CALC:MATH:STAT ON
CALC:MATH:MODE LIN
CALC:MATH (TRACE1-TRACE2)
CALC:MATH:POS 100
//Calculates the linear difference between the measured and average values.
//The resulting trace is displayed at the top of the diagram.

//-----Performing the Measurement-----
INIT;*WAI
//Initiates a new measurement and waits until the last sweep has finished.

//-----Retrieving Results-----
TRAC:DATA? TRACE1
TRAC:DATA? TRACE2
TRAC:DATA? TRACE3
TRAC:DATA? TRACE4
//Returns one power and one frequency value per sweep point for each trace.

```

## 12.15.2 Service Request

The service request routine requires an extended initialization of the instrument in which the relevant bits of the transition and enable registers are set. In addition the service request event must be enabled in the VISA session.

### 12.15.2.1 Initiate Service Request

```

REM ---- Example of initialization of the SRQ in the case
' of errors -----
PUBLIC SUB SetupSRQ()
CALL InstrWrite (analyzer, "*CLS") 'Reset status reporting system
CALL InstrWrite (analyzer, "*SRE 168") 'Enable service request for
'STAT:OPER, STAT:QUES and ESR

```

```

'register
CALL InstrWrite (analyzer, "*ESE 60") 'Set event enable bit for
'command, execution, device-
'dependent and query error
CALL InstrWrite (analyzer, "STAT:OPER:ENAB 32767")
'Set OPERATION enable bit for
'all events
CALL InstrWrite (analyzer, "STAT:OPER:PTR 32767")
'Set appropriate OPERATION
'Ptransition bits
CALL InstrWrite (analyzer, "STAT:QUES:ENAB 32767")
'Set questionable enable bits
'for all events
CALL InstrWrite (analyzer, "STAT:QUES:PTR 32767")
'Set appropriate questionable
'Ptransition bits
CALL viEnableEvent(analyzer, VI_EVENT_SERVICE_REQ, VI_QUEUE, 0)
'Enable the event for service
'request
Status = viWaitOnEvent(analyzer, VI_EVENT_SERVICE_REQ, SRQWaitTimeout, VI_NULL,
VI_NULL)
IF (status = VI_SUCCESS) THEN CALL Srq
'If SRQ is recognized =>
'subroutine for evaluation
END SUB
REM *****

```

### 12.15.2.2 Waiting for the Arrival of a Service Request

There are basically two methods of waiting for the arrival of a service request:

#### **Blocking (user inputs not possible):**

This method is appropriate if the waiting time until the event to be signaled by an SRQ is short (shorter than the selected timeout), if no response to user inputs is required during the waiting time, and if – as the main criterion – the event is absolutely certain to occur.

Reason:

From the time the `viWaitOnEvent()` function is called until the occurrence of the expected event, it does not allow the program to respond to mouse clicks or key entries during the waiting time. Moreover, it returns an error if the SRQ event does not occur within the predefined timeout period.

The method is, therefore, in many cases not suitable for waiting for measurement results, especially when using triggered measurements.

The following function calls are required:

```

Status = viWaitOnEvent(analyzer, VI_EVENT_SERVICE_REQ, SRQWaitTimeout, VI_NULL,
VI_NULL)

```

```

'Wait for service request user
'inputs are not possible during
'the waiting time!
IF (status = VI_SUCCESS) THEN CALL Srq
'If SRQ is recognized =>
'subroutine for evaluation

'----- Sweep in first Spectrum Tab and query marker -----
Dim Status = mbSession.WaitOnEvent(_
MessageBasedSessionEventType.ServiceRequest, SRQWaitTimeout)
'Wait for service request user inputs are not possible
'during the waiting time!
If (Status.EventType() = MessageBasedSessionEventType.ServiceRequest) Then
'If SRQ is recognized => subroutine for evaluation
 Srq()
End If

```

### Non-blocking (user inputs possible):

This method is recommended if the waiting time until the event to be signaled by an SRQ is long (longer than the selected timeout), and user inputs should be possible during the waiting time, or if the event is not certain to occur. This method is, therefore, the preferable choice for waiting for the end of measurements, i.e. the output of results, especially in the case of triggered measurements.

The method necessitates a waiting loop that checks the status of the SRQ line at regular intervals and returns control to the operating system during the time the expected event has not yet occurred. In this way, the system can respond to user inputs (mouse clicks, key entries) during the waiting time.

It is advisable to employ the Hold() auxiliary function, which returns control to the operating system for a selectable waiting time (see section [Waiting Without Blocking the Keyboard and Mouse](#)), so enabling user inputs during the waiting time.

```

result% = 0
For i = 1 To 10 'Abort after max. 10 loop
'iterations
Status = viWaitOnEvent(analyzer, VI_EVENT_SERVICE_REQ, VI_TMO_IMMEDIATE, VI_NULL,
VI_NULL)
'Check event queue
If (status = VI_SUCCESS) Then
result% = 1
CALL Srq 'If SRQ is recognized =>
'subroutine for evaluation
Else
CALL Hold(20) 'Call hold function with
'20 ms 'waiting time. User inputs
'are possible.
Endif
Next i
If result% = 0 Then

```

```

Debug.Print "Timeout Error; Program aborted" 'Output error message
STOP 'Stop software
Endif

```

### 12.15.2.3 Waiting Without Blocking the Keyboard and Mouse

A frequent problem with remote control programs using Visual Basic is to insert waiting times without blocking the keyboard and the mouse.

If the program is to respond to user inputs also during a waiting time, control over the program events during this time must be returned to the operating system. In Visual Basic, this is done by calling the `DoEvents` function. This function causes keyboard-or mouse-triggered events to be executed by the associated elements. For example, it allows the operation of buttons and input fields while the user waits for an instrument setting to be completed.

The following programming example describes the `Hold()` function, which returns control to the operating system for the period of the waiting time selectable in milliseconds.

```

Rem *****
Rem The waiting function below expects the transfer of the desired
Rem waiting time in milliseconds. The keyboard and the mouse remain
Rem operative during the waiting period, thus allowing desired elements
Rem to be controlled
Rem *****
Public Sub Hold(delayTime As Single)
Start = Timer 'Save timer count on calling the
'function
Do While Timer < Start + delayTime/1000 'Check timer count
DoEvents 'Return control to operating
'system to enable control of
'desired elements as long as
'timer has not elapsed
Loop
End Sub
Rem *****

```

The waiting procedure is activated simply by calling `Hold(<Waiting time in milliseconds>)`.

### 12.15.2.4 Service Request Routine

A service request is processed in the service request routine.



The variables `userN%` and `userM%` must be pre-assigned usefully!

```

REM ----- Service request routine -----
Public SUB Srq()

```

```

ON ERROR GOTO noDevice 'No user existing
CALL viReadSTB(analyzer, STB%) 'Serial poll, read status byte
IF STB% > 0 THEN 'This instrument has bits set in
'the STB
SRQFOUND% = 1
IF (STB% AND 16) > 0 THEN CALL Outputqueue
IF (STB% AND 4) > 0 THEN CALL ErrorQueueHandler
IF (STB% AND 8) > 0 THEN CALL Questionablestatus
IF (STB% AND 128) > 0 THEN CALL Operationstatus
IF (STB% AND 32) > 0 THEN CALL Esrread
END IF
noDevice:
END SUB 'End of SRQ routine
REM *****

REM ----- Subroutine for evaluation Service Request Routine -----

Public Sub Srq()
 Try
 Dim mySTB As Short = mbSession.ReadStatusByte()
 'Serial poll, read status byte
 Console.WriteLine("Reading Service Request Routine:" + mySTB.ToString())
 If mySTB > 0 Then 'This instrument has bits set in the STB
 If (mySTB And 16) > 0 Then Call Outputqueue()
 If (mySTB And 4) > 0 Then Call ErrorQueueHandler()
 If (mySTB And 8) > 0 Then Call Questionablestatus()
 If (mySTB And 128) > 0 Then Call Operationstatus()
 If (mySTB And 32) > 0 Then Call Esrread()
 End If
 Catch exp As Exception
 Console.WriteLine(exp.Message)
 End Try
End Sub 'End of SRQ routine

```

Reading out the status event registers, the output buffer and the error/event queue is effected in subroutines.

### 12.15.2.5 Reading Out the Output Buffer

```

REM ----- Subroutine for the individual STB bits -----
Public SUB Outputqueue() 'Reading the output buffer
result$ = SPACE$(100) 'Make space for response
CALL InstrRead(analyzer, result$)
Debug.Print "Contents of Output Queue:"; result$
END SUB
REM *****

REM ----- Subroutine for the output queue -----
Public Sub Outputqueue() 'Reading the output buffer
 Try
 Dim result As String = mbSession.ReadString()

```



```

 Console.WriteLine("Contents of Output Queue:" + result)
 Catch exp As Exception
 Console.WriteLine(exp.Message)
 End Try
End Sub

```

### 12.15.2.6 Reading Error Messages

```

REM ----- Subroutine for reading the error queue -----
Public SUB ErrorQueueHandler()
ERROR$ = SPACE$(100) 'Make space for error variable
CALL InstrWrite (analyzer, "SYSTEM:ERROR?")
CALL InstrRead(analyzer, ERROR$)
Debug.Print "Error Description: "; ERROR$
END SUB
REM *****

REM ----- Subroutine for reading the error queue -----
Sub ErrorQueueHandler()
 Dim result As String
 Dim hasErr As Boolean = True
 Do
 mbSession.Write("SYST:ERR?")
 result = mbSession.ReadString()
 Dim parts As String() = result.Split(",")
 If parts(0) = 0 Then
 hasErr = False
 Console.WriteLine(result)
 Else
 Console.WriteLine(result)
 End If
 Loop While hasErr
End Sub

```

### 12.15.2.7 Evaluation of SCPI Status Registers

```

REM ----- Subroutine for evaluating Questionable Status Register -----
Public SUB Questionablestatus()
Ques$ = SPACE$(20)
'Preallocate blanks to text
'variable
CALL InstrWrite (analyzer, "STATus:QUEStionable:EVENT?")
CALL InstrRead(analyzer, Ques$)
Debug.Print "Questionable Status: "; Ques$
END SUB
REM *****

REM ----- Subroutine for evaluating Operation Status Register -----
Public SUB Operationstatus()
Oper$ = SPACE$(20) 'Preallocate blanks to text

```

```

'variable
CALL InstrWrite (analyzer, "STaTus:OPERation:EVENT?")
CALL InstrRead(analyzer, Oper$)
Debug.Print "Operation Status: "; Oper$
END SUB
REM *****

REM ----- Subroutine for evaluating Questionable Status Register -----
Public Sub Questionablestatus()
 Dim myQSR As String = Nothing
 Try
 myQSR = mbSession.Query("STaTus:QUEStionable:EVENT?") 'Read QSR
 Console.WriteLine("Questionable Status:" + myQSR)
 Catch exp As Exception
 Console.WriteLine(exp.Message)
 End Try
End Sub

REM ----- Subroutine for evaluating Operation Status Register -----
Public Sub Operationstatus()
 Dim myOSR As String = Nothing
 Try
 myOSR = mbSession.Query("STaTus:OPERation:EVENT?") 'Read OSR
 Console.WriteLine("Operation Status:" + myOSR)
 Catch exp As Exception
 Console.WriteLine(exp.Message)
 End Try
End Sub

```

### 12.15.2.8 Evaluation of Event Status Register

```

REM ----- Subroutine for evaluating the Event Status Register -----
Public SUB Esrread()
Esr$ = SPACE$(20) 'Preallocate blanks to text
'variable
CALL InstrWrite (analyzer, "*ESR?") 'Read ESR
CALL InstrRead(analyzer, Esr$)
IF (VAL(Esr$) AND 1) > 0 THEN Debug.Print "Operation complete"
IF (VAL(Esr$) AND 2) > 0 THEN Debug.Print "Request Control"
IF (VAL(Esr$) AND 4) > 0
THEN Debug.Print "Query Error"
IF (VAL(Esr$) AND 8) > 0
THEN Debug.Print "Device dependent error"
IF (VAL(Esr$) AND 16) > 0
THEN Debug.Print "Execution Error; Program aborted" 'Output error message
STOP 'Stop software
END IF
IF (VAL(Esr$) AND 32) > 0
THEN Debug.Print "Command Error; Program aborted" 'Output error message
STOP 'Stop software

```

```
END IF
IF (VAL(Esr$) AND 64) > 0 THEN Debug.Print "User request"
IF (VAL(Esr$) AND 128) > 0 THEN Debug.Print "Power on"END SUB
REM *****
REM ----- Subroutine for evaluating the Event Status Register -----
Public Sub Esrread()
 Try
 Dim myESR As Short = mbSession.Query("*ESR?") 'Read ESR
 If (myESR And 1) > 0 Then Console.WriteLine("Operation complete")
 If (myESR And 2) > 0 Then Console.WriteLine("Request Control")
 If (myESR And 4) > 0 Then Console.WriteLine("Query Error")
 If (myESR And 8) > 0 Then Console.WriteLine("Device dependent error")
 If (myESR And 16) > 0 Then
 Console.WriteLine("Execution Error; Program aborted") 'Output error message
 Stop 'Stop software
 End If
 If (myESR And 32) > 0 Then
 Console.WriteLine("Command Error; Program aborted") 'Output error message
 Stop 'Stop software
 End If
 If (myESR And 64) > 0 Then Console.WriteLine("User request")
 If (myESR And 128) > 0 Then Console.WriteLine("Power on")
 Catch exp As Exception
 Console.WriteLine(exp.Message)
 End Try
End Sub
```

## 13 Maintenance

The R&S FPS does not require regular maintenance. Maintenance is essentially restricted to cleaning the R&S FPS. It is, however, recommended that you check the nominal data from time to time.

The data sheet specifies the storage temperature range for the R&S FPS. Protect the instrument against dust if it is to be stored for a long period.

### 13.1 Cleaning

---

**⚠ WARNING****Risk of electric shock**

If moisture enters the casing, for example if you clean the instrument using a moist cloth, contact with the instrument can lead to electric shock. Before cleaning the instrument other than with a dry cloth, make sure that the instrument is switched off and disconnected from all power supplies.

---

**NOTICE****Instrument damage caused by cleaning agents**

Cleaning agents contain substances such as solvents (thinners, acetone, etc.), acids, bases, or other substances. Solvents can damage the front panel labeling, plastic parts, or screens, for example.

Never use cleaning agents to clean the outside of the instrument. Use a soft, dry, lint-free dust cloth instead.

---

**NOTICE****Risk of instrument damage due to obstructed fans**

If the instrument is operated in dusty areas, the fans become obstructed by dust or other particles over time. Check and clean the fans regularly to ensure that they always operate properly. If the instrument is run with obstructed fans for a longer period, the instrument overheats, which can disturb the operation and even cause damage.

---

1. Clean the outside of the instrument using a soft, dry, lint-free dust cloth.
2. Check and clean the fans regularly to ensure that they always operate properly.
3. Clean the touchscreen as follows:
  - a) Apply a small amount of standard screen cleaner to a soft cloth.
  - b) Wipe the screen gently with the moist, but not wet, cloth.

- c) If necessary, remove any excess moisture with a dry, soft cloth.

# 14 Troubleshooting

If the results do not meet your expectations, the following sections may contain helpful hints and information.



## Error message display

Note that any error messages caused by the Windows 7 operating system are only visible on an external monitor or via RemoteDesktop from a control PC. Thus, if operation of the R&S FPS seems to fail for no obvious reason, try connecting a monitor or a control PC to check for any messages awaiting confirmation or action.

(See [Chapter 4.1.3, "Connecting USB Devices"](#), on page 30 or [Chapter 4.4.6, "How to Set Up Remote Desktop"](#), on page 70)

- [Error Information](#)..... 1054
- [Error Messages in Remote Control Mode](#)..... 1055
- [Troubleshooting Remote Operation](#)..... 1056
- [Miscellaneous Troubleshooting Hints](#)..... 1058
- [Collecting Information for Technical Support](#)..... 1058

## 14.1 Error Information

If errors or irregularities are detected, a keyword and an error message, if available, are displayed in the status bar.



Depending on the type of message, the status message is indicated in varying colors.

**Table 14-1: Status bar information - color coding**

| Color    | Type                   | Description                                                                                                                                                                       |
|----------|------------------------|-----------------------------------------------------------------------------------------------------------------------------------------------------------------------------------|
| Red      | Error                  | An error occurred at the start or during a measurement, e.g. due to missing data or wrong settings, so that the measurement cannot be started or completed correctly.             |
| Orange   | Warning                | An irregular situation occurred during measurement, e.g. the settings no longer match the displayed results, or the connection to an external device was interrupted temporarily. |
| Gray     | Information            | Information on the status of individual processing steps.                                                                                                                         |
| No color | No errors              | No message displayed - normal operation.                                                                                                                                          |
| Green    | Measurement successful | Some applications visualize that the measurement was successful by showing a message.                                                                                             |



If any error information is available for a channel, an exclamation mark is displayed next to the channel name (■). This is particularly useful when the MultiView tab is displayed, as the status bar in the MultiView tab always displays the information for the currently selected measurement only.

Furthermore, a status bit is set in the `STATUS:QUESTIONABLE:EXTENDED:INFO` register for the application concerned (see "[STATUS:QUESTIONABLE:EXTENDED:INFO Register](#)" on page 595). Messages of a specific type can be queried using the `SYST:ERR:EXT?` command, see [SYSTEM:ERROR:EXTENDED?](#) on page 991.

**Table 14-2: List of keywords**

|                   |                                                                                                                                                                                                                                                                                                                                                                                                         |
|-------------------|---------------------------------------------------------------------------------------------------------------------------------------------------------------------------------------------------------------------------------------------------------------------------------------------------------------------------------------------------------------------------------------------------------|
| <b>IF OVLD</b>    | Overload of the IF signal path in the A/D converter or in the digital IF. <ul style="list-style-type: none"> <li>Increase the reference level.</li> </ul>                                                                                                                                                                                                                                               |
| <b>INPUT OVLD</b> | The signal level at the RF input connector exceeds the maximum.<br>The RF input is disconnected from the input mixer to protect the device. To re-enable measurement, decrease the level at the RF input connector and reconnect the RF input to the mixer input.                                                                                                                                       |
| <b>LOUNL</b>      | Error in the instrument's frequency processing hardware was detected.                                                                                                                                                                                                                                                                                                                                   |
| <b>NO REF</b>     | Instrument was set to an external reference but no signal was detected on the reference input.                                                                                                                                                                                                                                                                                                          |
| <b>OVEN</b>       | The optional OCXO reference frequency has not yet reached its operating temperature. The message usually disappears a few minutes after power has been switched on.                                                                                                                                                                                                                                     |
| <b>RF OVLD</b>    | Overload of the input mixer or of the analog IF path. <ul style="list-style-type: none"> <li>Increase the RF attenuation (for RF input).</li> <li>Reduce the input level (for digital input)</li> </ul>                                                                                                                                                                                                 |
| <b>UNCAL</b>      | One of the following conditions applies: <ul style="list-style-type: none"> <li>Correction data has been switched off.</li> <li>No correction values are available, for example after a firmware update.</li> <li>Record the correction data by performing a self alignment (For details refer to <a href="#">Chapter 4.1.4, "Performing a Self Alignment and a Self Test"</a>, on page 31).</li> </ul> |
| <b>WRONG_FW</b>   | The firmware version is out-of-date and does not support the currently installed hardware. Until the firmware version is updated, this error message is displayed and self-alignment fails.<br>(For details refer to <a href="#">Chapter 10.5.4, "Firmware Updates"</a> , on page 563).                                                                                                                 |

## 14.2 Error Messages in Remote Control Mode

In remote control mode error messages are entered in the error/event queue of the status reporting system and can be queried with the command `SYSTEM:ERROR?`. The answer format of R&S FPS to the command is as follows:

```
<error code>, "<error text with queue query>; <remote control command concerned>"
```

The indication of the remote control command with prefixed semicolon is optional.

**Example:**

The command `TEST:COMMAND` generates the following answer to the query

`SYSTEM:ERROR?`

```
-113, "Undefined header;TEST:COMMAND"
```

There are two types of error messages:

- Error messages defined by SCPI are marked by negative error codes. These messages are defined and described in the SCPI standard and not listed here.
- Device-specific error messages use positive error codes. These messages are described below.

**Table 14-3: Device-specific error messages**

| Error code | Error text in the case of queue poll<br>Error explanation                                                                                                                                                                                                                                                                                                                                                                                                       |
|------------|-----------------------------------------------------------------------------------------------------------------------------------------------------------------------------------------------------------------------------------------------------------------------------------------------------------------------------------------------------------------------------------------------------------------------------------------------------------------|
| 1052       | <b>Frontend LO is Unlocked</b><br>This message is displayed when the phase regulation of the local oscillator fails in the RF front-end.                                                                                                                                                                                                                                                                                                                        |
| 1060       | <b>Trigger-Block Gate Delay Error- gate length &lt; Gate Delay</b><br>This message is displayed when the gate signal length is not sufficient for the pull-in delay with a predefined gate delay.                                                                                                                                                                                                                                                               |
| 1064       | <b>Tracking LO is Unlocked</b><br>This message is displayed when the phase regulation of the local oscillator fails on the external generator module.                                                                                                                                                                                                                                                                                                           |
| 2028       | <b>Hardcopy not possible during measurement sequence</b><br>This message is displayed when a printout is started during scan sequences that cannot be interrupted. Such sequences are for example: <ul style="list-style-type: none"> <li>• Recording the system error correction data (alignment)</li> <li>• Instrument self-test</li> </ul> In such cases synchronization to the end of the scan sequence should be performed prior to starting the printout. |
| 2033       | <b>Printer Not Available</b><br>This message is displayed when the selected printer is not included in the list of available output devices. A possible cause is that the required printer driver is missing or incorrectly installed.                                                                                                                                                                                                                          |
| 2034       | <b>CPU Temperature is too high</b><br>This message is displayed when the temperature of the processor exceeds 70 °C.                                                                                                                                                                                                                                                                                                                                            |

## 14.3 Troubleshooting Remote Operation

If problems arise during measurement in remote operation, try the following methods to solve them.

### Incompleted sequential commands - blocked remote channels

If a sequential command cannot be completed, for example because a triggered sweep never receives a trigger, the remote control program will never finish and the remote



channel to the R&S FPS is blocked for further commands. In this case, you must interrupt processing on the remote channel in order to abort the measurement.

### To regain control over a blocked remote channel

Usually, if you wait a minute for the VISA connection to detect the lost connection and clear the control channel by itself, you can then re-establish the connection again. If this fails, try the following:

1. Press "Local" on the front panel of the R&S FPS to return to manual operation (if not disabled). Then re-establish the connection.
2. Send a "Device Clear" command from the control instrument to the R&S FPS to clear all currently active remote channels. Depending on the used interface and protocol, send the following commands:
  - **Visa:** `viClear()`The remote channel currently processing the incompleting command is then ready to receive further commands again.
3. On the remote channel performing the measurement, send the SCPI command `ABORT` to abort the current measurement and reset the trigger system.
4. If the R&S FPS still does not react to the remote commands, switch it off and back on.

### Ignored commands

When a remote command attempts to define incompatible settings, the command is ignored and the instrument status remains unchanged, i.e. other settings are not automatically adapted. Therefore, control programs should always define an initial instrument status (e.g. using the `*RST` command) and then implement the required settings.

### Detecting false commands

If a remote program does not provide the expected results and you are using a GPIB connection, you can log the commands and any errors that may occur. To activate the SCPI error log function, in the "Network + Remote" dialog box, in the "GPIB" tab, select "I/O Logging".

All remote control commands received by the R&S FPS are recorded in the following log file:

```
C:\R_S\INSTR\ScpiLogging\ScpiLog.txt
```

Logging the commands may be extremely useful for debug purposes, e.g. in order to find misspelled keywords in control programs. However, remember to turn off the logging function after debugging to avoid unnecessary access to the hard drive and use of storage space.

## 14.4 Miscellaneous Troubleshooting Hints

|                                                                                                                                       |      |
|---------------------------------------------------------------------------------------------------------------------------------------|------|
| Power levels for low frequency signals not correct.....                                                                               | 1058 |
| Invalid trace display.....                                                                                                            | 1058 |
| The transducer factors/limit lines applied to my measurement are different to those displayed in the Transducer/Lines dialog box..... | 1058 |

### Power levels for low frequency signals not correct

By default, the R&S FPS uses AC coupling for RF input. For very low frequencies, the input signal may be distorted with this setting. In this case, use DC coupling instead. To change the setting, select INPUT/OUTPUT > "Input Source Config > Radio Frequency > Input Coupling > DC".

### Invalid trace display

If output to the IF 2 GHZ OUT connector is activated, the measured values are no longer sent to the display; thus, the trace data currently displayed on the R&S FPS becomes invalid. A message in the status bar indicates this situation.

### The transducer factors/limit lines applied to my measurement are different to those displayed in the Transducer/Lines dialog box

If a transducer file was in use when the save set was stored (with the save item "Current Settings" only) it is anticipated that these transducer values should remain valid after every recall of that save set. Thus, even if the transducer file is changed and the original save set file is recalled later, the *originally stored* transducer values are recalled and applied to the measurement. In the "Transducer" dialog box, however, the *changed* transducer file values are displayed as no updated transducer file was loaded.

The same applies to limit line settings.

If you want to apply the changed transducer values after recalling the save set you must force the application to reload the transducer file. To do so, simply open the "Edit Transducer" dialog box (see [Chapter 10.3.2, "Transducer Settings"](#), on page 548) and toggle the "X-Axis" option from "lin" to "log" and back. Due to that change, the transducer file is automatically reloaded, and the changed transducer values are applied to the current measurement. Now you can create a new save set with the updated transducer values.

Similarly, if you want to apply the changed limit values after recalling the save set you must force the application to reload the limit file. To do so, simply open the "Edit Limit Line" dialog box (see [Chapter 8.4.2.2, "Limit Line Settings and Functions"](#), on page 447) and toggle the "Y-Axis" unit. Due to that change, the limit line file is automatically reloaded, and the changed limit values are applied to the current measurement. Now a new save set with the updated limit values can be created.

## 14.5 Collecting Information for Technical Support

If problems occur, the instrument generates error messages which in most cases will be sufficient for you to detect the cause of an error and find a remedy.

Error messages are described in [Chapter 14.1, "Error Information"](#), on page 1054.

In addition, our customer support centers are there to assist you in solving any problems that you may encounter with your R&S FPS. We will find solutions more quickly and efficiently if you provide us with the information listed below.

- **System Configuration:** The "System Configuration" dialog box (in the "System Configuration" menu of the soft front panel) provides information on:
  - **Hardware Info:** hardware assemblies
  - **Versions and Options:** the status of all software and hardware options installed on your instrument
  - **System Messages:** messages on any errors that may have occurred

An .xml file with information on the system configuration ( "Device Footprint" ) can be created automatically (using the `DIAGnostic:SERVICE:SINfo` command or as described in ["To collect the support information"](#) on page 1059).

- **Error Log:** The `RSError.log` file (in the `C:\R_S\INSTR\log` directory) contains a chronological record of errors.
- **Support file:** a \*.zip file with important support information can be created automatically (in the `C:\R_S\INSTR\user` directory). The \*.zip file contains the system configuration information ( "Device Footprint" ), the current eeprom data and a screenshot of the screen display.

See also [Chapter 10.6.1, "R&S Support Information"](#), on page 567.

#### To collect the support information

1. Select the SETUP key in the soft front panel on the Remote Desktop.
2. Select "Service" > "R&S Support" and then "Create R&S Support Information" .

The file is stored as

```
C:\R_S\INSTR\user\
<inst_model>_<serial-no>_<date_and_time>.zip
```

For example

```
C:\R_S\INSTR\user\
FPS-13_1319.2008K13-100005-xx_20150420_113652.zip
```

Collect the error information and attach it to an email in which you describe the problem. Send the email to the customer support address for your region as listed on the Internet (<http://www.customersupport.rohde-schwarz.com>).



#### Packing and transporting the instrument

If the instrument needs to be transported or shipped, observe the notes described in [Chapter 4.1.1.1, "Unpacking and Checking the Instrument"](#), on page 21.

## List of remote commands (base unit)

|                                                          |     |
|----------------------------------------------------------|-----|
| [SENSe:][WINDow<n>:]DETEctor<t>[:FUNction].....          | 842 |
| [SENSe:][WINDow<n>:]DETEctor<t>[:FUNction]:AUTO.....     | 843 |
| [SENSe:]ADJust:ALL.....                                  | 781 |
| [SENSe:]ADJust:ALL.....                                  | 809 |
| [SENSe:]ADJust:CONFigure:HYSteresis:LOWer.....           | 782 |
| [SENSe:]ADJust:CONFigure:HYSteresis:LOWer.....           | 810 |
| [SENSe:]ADJust:CONFigure:HYSteresis:UPPer.....           | 782 |
| [SENSe:]ADJust:CONFigure:HYSteresis:UPPer.....           | 811 |
| [SENSe:]ADJust:CONFigure:TRIGger.....                    | 783 |
| [SENSe:]ADJust:CONFigure:TRIGger.....                    | 811 |
| [SENSe:]ADJust:CONFigure[:LEVel]:DURation.....           | 781 |
| [SENSe:]ADJust:CONFigure[:LEVel]:DURation.....           | 809 |
| [SENSe:]ADJust:CONFigure[:LEVel]:DURation:MODE.....      | 781 |
| [SENSe:]ADJust:CONFigure[:LEVel]:DURation:MODE.....      | 810 |
| [SENSe:]ADJust:FREQuency.....                            | 783 |
| [SENSe:]ADJust:FREQuency.....                            | 811 |
| [SENSe:]ADJust:LEVel.....                                | 783 |
| [SENSe:]ADJust:LEVel.....                                | 811 |
| [SENSe:]AVERage<n>:COUNT.....                            | 841 |
| [SENSe:]AVERage<n>:TYPE.....                             | 842 |
| [SENSe:]AVERage<n>[:STATe<t>].....                       | 841 |
| [SENSe:]BANDwidth:VIDeo.....                             | 787 |
| [SENSe:]BANDwidth:VIDeo:AUTO.....                        | 787 |
| [SENSe:]BANDwidth:VIDeo:RATio.....                       | 787 |
| [SENSe:]BANDwidth:VIDeo:TYPE.....                        | 788 |
| [SENSe:]BANDwidth[:RESolution].....                      | 785 |
| [SENSe:]BANDwidth[:RESolution]:AUTO.....                 | 786 |
| [SENSe:]BANDwidth[:RESolution]:FFT.....                  | 791 |
| [SENSe:]BANDwidth[:RESolution]:RATio.....                | 786 |
| [SENSe:]BANDwidth[:RESolution]:TYPE.....                 | 786 |
| [SENSe:]BWIDth:VIDeo.....                                | 787 |
| [SENSe:]BWIDth:VIDeo:AUTO.....                           | 787 |
| [SENSe:]BWIDth:VIDeo:RATio.....                          | 787 |
| [SENSe:]BWIDth:VIDeo:TYPE.....                           | 788 |
| [SENSe:]BWIDth[:RESolution].....                         | 785 |
| [SENSe:]BWIDth[:RESolution]:AUTO.....                    | 786 |
| [SENSe:]BWIDth[:RESolution]:FFT.....                     | 791 |
| [SENSe:]BWIDth[:RESolution]:RATio.....                   | 786 |
| [SENSe:]BWIDth[:RESolution]:TYPE.....                    | 786 |
| [SENSe:]CORRection:COLLect[:ACQuire].....                | 819 |
| [SENSe:]CORRection:METhod.....                           | 820 |
| [SENSe:]CORRection:RECall.....                           | 821 |
| [SENSe:]CORRection:TRANsducer:ADJust:RLEVel[:STATe]..... | 974 |
| [SENSe:]CORRection:TRANsducer:CATalog?.....              | 975 |
| [SENSe:]CORRection:TRANsducer:COMMeNt.....               | 975 |
| [SENSe:]CORRection:TRANsducer:DATA.....                  | 976 |
| [SENSe:]CORRection:TRANsducer:DELeTe.....                | 976 |

|                                                                               |     |
|-------------------------------------------------------------------------------|-----|
| [SENSe:]CORRection:TRANsducer:GENerate.....                                   | 821 |
| [SENSe:]CORRection:TRANsducer:SCALing.....                                    | 976 |
| [SENSe:]CORRection:TRANsducer:SElect.....                                     | 977 |
| [SENSe:]CORRection:TRANsducer:UNIT.....                                       | 977 |
| [SENSe:]CORRection:TRANsducer[:STATe].....                                    | 977 |
| [SENSe:]CORRection[:STATe].....                                               | 821 |
| [SENSe:]ESpectrum<sb>:BWID.....                                               | 698 |
| [SENSe:]ESpectrum<sb>:FILTer[:RRC]:ALPHA.....                                 | 698 |
| [SENSe:]ESpectrum<sb>:FILTer[:RRC][:STATe].....                               | 698 |
| [SENSe:]ESpectrum<sb>:HighSPeed.....                                          | 684 |
| [SENSe:]ESpectrum<sb>:MSR:APPLy.....                                          | 704 |
| [SENSe:]ESpectrum<sb>:MSR:BAND.....                                           | 705 |
| [SENSe:]ESpectrum<sb>:MSR:BCATegory.....                                      | 705 |
| [SENSe:]ESpectrum<sb>:MSR:CLASs.....                                          | 706 |
| [SENSe:]ESpectrum<sb>:MSR:GSM:CARRier.....                                    | 707 |
| [SENSe:]ESpectrum<sb>:MSR:GSM:CPResent.....                                   | 708 |
| [SENSe:]ESpectrum<sb>:MSR:LTE:CPResent.....                                   | 708 |
| [SENSe:]ESpectrum<sb>:MSR:MPOWer.....                                         | 709 |
| [SENSe:]ESpectrum<sb>:MSR:RFBWidth.....                                       | 709 |
| [SENSe:]ESpectrum<sb>:PRESet:RESTore.....                                     | 681 |
| [SENSe:]ESpectrum<sb>:PRESet:STORe.....                                       | 681 |
| [SENSe:]ESpectrum<sb>:PRESet[:STANdard].....                                  | 681 |
| [SENSe:]ESpectrum<sb>:RANGe<range>:BANDwidth:RESolution.....                  | 685 |
| [SENSe:]ESpectrum<sb>:RANGe<range>:BANDwidth:VIDeo.....                       | 685 |
| [SENSe:]ESpectrum<sb>:RANGe<range>:COUNT?.....                                | 685 |
| [SENSe:]ESpectrum<sb>:RANGe<range>:DELete.....                                | 686 |
| [SENSe:]ESpectrum<sb>:RANGe<range>:FILTer:TYPE.....                           | 686 |
| [SENSe:]ESpectrum<sb>:RANGe<range>:INPut:ATTenuation.....                     | 688 |
| [SENSe:]ESpectrum<sb>:RANGe<range>:INPut:ATTenuation:AUTO.....                | 688 |
| [SENSe:]ESpectrum<sb>:RANGe<range>:INPut:GAIN:STATe.....                      | 689 |
| [SENSe:]ESpectrum<sb>:RANGe<range>:INSert.....                                | 689 |
| [SENSe:]ESpectrum<sb>:RANGe<range>:LIMit<PClass>:ABSolute:START.....          | 689 |
| [SENSe:]ESpectrum<sb>:RANGe<range>:LIMit<PClass>:ABSolute:STOP.....           | 690 |
| [SENSe:]ESpectrum<sb>:RANGe<range>:LIMit<PClass>:RELative:START.....          | 690 |
| [SENSe:]ESpectrum<sb>:RANGe<range>:LIMit<PClass>:RELative:START:ABS.....      | 691 |
| [SENSe:]ESpectrum<sb>:RANGe<range>:LIMit<PClass>:RELative:START:FUNCTion..... | 692 |
| [SENSe:]ESpectrum<sb>:RANGe<range>:LIMit<PClass>:RELative:STOP.....           | 692 |
| [SENSe:]ESpectrum<sb>:RANGe<range>:LIMit<PClass>:RELative:STOP:ABS.....       | 693 |
| [SENSe:]ESpectrum<sb>:RANGe<range>:LIMit<PClass>:RELative:STOP:FUNCTion.....  | 694 |
| [SENSe:]ESpectrum<sb>:RANGe<range>:LIMit<PClass>:STATe.....                   | 694 |
| [SENSe:]ESpectrum<sb>:RANGe<range>:MLCalc.....                                | 695 |
| [SENSe:]ESpectrum<sb>:RANGe<range>:POINts:MINimum[:VALue].....                | 695 |
| [SENSe:]ESpectrum<sb>:RANGe<range>:RLEVel.....                                | 696 |
| [SENSe:]ESpectrum<sb>:RANGe<range>:SWEep:TIME.....                            | 696 |
| [SENSe:]ESpectrum<sb>:RANGe<range>:SWEep:TIME:AUTO.....                       | 697 |
| [SENSe:]ESpectrum<sb>:RANGe<range>:TRANsducer.....                            | 697 |
| [SENSe:]ESpectrum<sb>:RANGe<range>[:FREQuency]:START.....                     | 687 |
| [SENSe:]ESpectrum<sb>:RANGe<range>[:FREQuency]:STOP.....                      | 687 |
| [SENSe:]ESpectrum<sb>:RRANGe?.....                                            | 698 |
| [SENSe:]ESpectrum<sb>:RTYPE.....                                              | 699 |

|                                                       |      |
|-------------------------------------------------------|------|
| [SENSe:]ESpectrum<sb>:SBCenter.....                   | 683  |
| [SENSe:]ESpectrum<sb>:SBCenter.....                   | 1040 |
| [SENSe:]ESpectrum<sb>:SBCount.....                    | 683  |
| [SENSe:]ESpectrum<sb>:SBCount.....                    | 1040 |
| [SENSe:]ESpectrum<sb>:SCENter.....                    | 683  |
| [SENSe:]ESpectrum<sb>:SCOUNt.....                     | 683  |
| [SENSe:]FREQuency:CENTer.....                         | 777  |
| [SENSe:]FREQuency:CENTer:STEP.....                    | 777  |
| [SENSe:]FREQuency:CENTer:STEP:AUTO.....               | 778  |
| [SENSe:]FREQuency:CENTer:STEP:LINK.....               | 778  |
| [SENSe:]FREQuency:CENTer:STEP:LINK:FACTor.....        | 779  |
| [SENSe:]FREQuency:OFFSet.....                         | 779  |
| [SENSe:]FREQuency:SPAN.....                           | 779  |
| [SENSe:]FREQuency:SPAN:FULL.....                      | 780  |
| [SENSe:]FREQuency:STARt.....                          | 780  |
| [SENSe:]FREQuency:STOP.....                           | 780  |
| [SENSe:]LIST:POWer:RESult?.....                       | 757  |
| [SENSe:]LIST:POWer:SET.....                           | 759  |
| [SENSe:]LIST:POWer:STATe.....                         | 760  |
| [SENSe:]LIST:POWer[:SEQuence].....                    | 758  |
| [SENSe:]LIST:RANGe<range>:BANDwidth:RESolution.....   | 716  |
| [SENSe:]LIST:RANGe<range>:BANDwidth:VIDeo.....        | 717  |
| [SENSe:]LIST:RANGe<range>:BREak.....                  | 717  |
| [SENSe:]LIST:RANGe<range>:COUNt?.....                 | 717  |
| [SENSe:]LIST:RANGe<range>:DELeTe.....                 | 717  |
| [SENSe:]LIST:RANGe<range>:DETEctor.....               | 718  |
| [SENSe:]LIST:RANGe<range>:FILTer:TYPE.....            | 718  |
| [SENSe:]LIST:RANGe<range>:INPut:ATTenuation.....      | 720  |
| [SENSe:]LIST:RANGe<range>:INPut:ATTenuation:AUTO..... | 720  |
| [SENSe:]LIST:RANGe<range>:LIMit:STARt.....            | 720  |
| [SENSe:]LIST:RANGe<range>:LIMit:STATe.....            | 721  |
| [SENSe:]LIST:RANGe<range>:LIMit:STOP.....             | 721  |
| [SENSe:]LIST:RANGe<range>:POINts.....                 | 721  |
| [SENSe:]LIST:RANGe<range>:RLEVel.....                 | 722  |
| [SENSe:]LIST:RANGe<range>:SWEep:TIME.....             | 722  |
| [SENSe:]LIST:RANGe<range>:SWEep:TIME:AUTO.....        | 722  |
| [SENSe:]LIST:RANGe<range>:TRANsducer.....             | 723  |
| [SENSe:]LIST:RANGe<range>[:FREQuency]:STARt.....      | 719  |
| [SENSe:]LIST:RANGe<range>[:FREQuency]:STOP.....       | 719  |
| [SENSe:]MPOWer:FTYPE.....                             | 763  |
| [SENSe:]MPOWer:RESult:MIN?.....                       | 764  |
| [SENSe:]MPOWer:RESult[:LIST]?.....                    | 763  |
| [SENSe:]MPOWer[:SEQuence].....                        | 763  |
| [SENSe:]PMETer<p>:DCYCLe:VALue.....                   | 827  |
| [SENSe:]PMETer<p>:DCYCLe[:STATe].....                 | 827  |
| [SENSe:]PMETer<p>:FREQuency.....                      | 828  |
| [SENSe:]PMETer<p>:FREQuency:LINK.....                 | 828  |
| [SENSe:]PMETer<p>:MTIME.....                          | 829  |
| [SENSe:]PMETer<p>:MTIME:AVERAge:COUNt.....            | 829  |
| [SENSe:]PMETer<p>:MTIME:AVERAge[:STATe].....          | 829  |

|                                                                   |     |
|-------------------------------------------------------------------|-----|
| [SENSe:]PMETer<p>:ROFFset[:STATe].....                            | 830 |
| [SENSe:]PMETer<p>:TRIGger:DTIME.....                              | 832 |
| [SENSe:]PMETer<p>:TRIGger:HOLDoff.....                            | 832 |
| [SENSe:]PMETer<p>:TRIGger:HYSTeresis.....                         | 832 |
| [SENSe:]PMETer<p>:TRIGger:LEVel.....                              | 833 |
| [SENSe:]PMETer<p>:TRIGger:SLOPe.....                              | 833 |
| [SENSe:]PMETer<p>:TRIGger[:STATe].....                            | 834 |
| [SENSe:]PMETer<p>:UPDate[:STATe].....                             | 831 |
| [SENSe:]PMETer<p>[:STATe].....                                    | 830 |
| [SENSe:]POWer:ACHannel:ACPairs.....                               | 643 |
| [SENSe:]POWer:ACHannel:AGCHannels.....                            | 668 |
| [SENSe:]POWer:ACHannel:BANDwidth:ACHannel.....                    | 644 |
| [SENSe:]POWer:ACHannel:BANDwidth:ALTErnatE<ch>.....               | 644 |
| [SENSe:]POWer:ACHannel:BANDwidth:GAP<gap>.....                    | 668 |
| [SENSe:]POWer:ACHannel:BANDwidth:UACHannel.....                   | 663 |
| [SENSe:]POWer:ACHannel:BANDwidth:UALTErnatE<ch>.....              | 663 |
| [SENSe:]POWer:ACHannel:BANDwidth[:CHANnel<ch>].....               | 644 |
| [SENSe:]POWer:ACHannel:BWIDth:ACHannel.....                       | 644 |
| [SENSe:]POWer:ACHannel:BWIDth:ALTErnatE<ch>.....                  | 644 |
| [SENSe:]POWer:ACHannel:BWIDth:GAP<gap>.....                       | 668 |
| [SENSe:]POWer:ACHannel:BWIDth:UACHannel.....                      | 663 |
| [SENSe:]POWer:ACHannel:BWIDth:UALTErnatE<ch>.....                 | 663 |
| [SENSe:]POWer:ACHannel:BWIDth[:CHANnel<ch>].....                  | 644 |
| [SENSe:]POWer:ACHannel:FILTer:ALPHa:ACHannel.....                 | 647 |
| [SENSe:]POWer:ACHannel:FILTer:ALPHa:ALTErnatE<ch>.....            | 648 |
| [SENSe:]POWer:ACHannel:FILTer:ALPHa:CHANnel<ch>.....              | 648 |
| [SENSe:]POWer:ACHannel:FILTer:ALPHa:GAP<gap>.....                 | 668 |
| [SENSe:]POWer:ACHannel:FILTer:ALPHa:SBLOCK<sb>:CHANnel<ch>.....   | 658 |
| [SENSe:]POWer:ACHannel:FILTer:ALPHa:UACHannel.....                | 664 |
| [SENSe:]POWer:ACHannel:FILTer:ALPHa:UALTErnatE<ch>.....           | 664 |
| [SENSe:]POWer:ACHannel:FILTer:ALPHa[:ALL].....                    | 648 |
| [SENSe:]POWer:ACHannel:FILTer[:STATe]:ACHannel.....               | 648 |
| [SENSe:]POWer:ACHannel:FILTer[:STATe]:ALTErnatE<ch>.....          | 649 |
| [SENSe:]POWer:ACHannel:FILTer[:STATe]:CHANnel<ch>.....            | 649 |
| [SENSe:]POWer:ACHannel:FILTer[:STATe]:GAP<gap>.....               | 669 |
| [SENSe:]POWer:ACHannel:FILTer[:STATe]:SBLOCK<sb>:CHANnel<ch>..... | 658 |
| [SENSe:]POWer:ACHannel:FILTer[:STATe]:UACHannel.....              | 664 |
| [SENSe:]POWer:ACHannel:FILTer[:STATe]:UALTErnatE<ch>.....         | 665 |
| [SENSe:]POWer:ACHannel:FILTer[:STATe][:ALL].....                  | 649 |
| [SENSe:]POWer:ACHannel:GAP<gap>:MSIZE.....                        | 669 |
| [SENSe:]POWer:ACHannel:MODE.....                                  | 672 |
| [SENSe:]POWer:ACHannel:NAME:ACHannel.....                         | 645 |
| [SENSe:]POWer:ACHannel:NAME:ALTErnatE<ch>.....                    | 645 |
| [SENSe:]POWer:ACHannel:NAME:CHANnel<ch>.....                      | 645 |
| [SENSe:]POWer:ACHannel:NAME:UACHannel.....                        | 670 |
| [SENSe:]POWer:ACHannel:NAME:UALTErnatE<ch>.....                   | 670 |
| [SENSe:]POWer:ACHannel:PRESet.....                                | 640 |
| [SENSe:]POWer:ACHannel:PRESet:RLEVel.....                         | 640 |
| [SENSe:]POWer:ACHannel:REFerence:AUTO ONCE.....                   | 650 |
| [SENSe:]POWer:ACHannel:REFerence:TXCHannel:AUTO.....              | 650 |

|                                                                 |     |
|-----------------------------------------------------------------|-----|
| [SENSe:]POWer:ACHannel:REFerence:TXCHannel:MANual.....          | 650 |
| [SENSe:]POWer:ACHannel:SBCount.....                             | 659 |
| [SENSe:]POWer:ACHannel:SBLOCK<sb>:BANDwidth[:CHANnel<ch>].....  | 659 |
| [SENSe:]POWer:ACHannel:SBLOCK<sb>:BWIDth[:CHANnel<ch>].....     | 659 |
| [SENSe:]POWer:ACHannel:SBLOCK<sb>:CENTer[:CHANnel<ch>].....     | 659 |
| [SENSe:]POWer:ACHannel:SBLOCK<sb>:FREQUency:CENTer.....         | 660 |
| [SENSe:]POWer:ACHannel:SBLOCK<sb>:NAME[:CHANnel<ch>].....       | 670 |
| [SENSe:]POWer:ACHannel:SBLOCK<sb>:RFBWidth.....                 | 661 |
| [SENSe:]POWer:ACHannel:SBLOCK<sb>:TECHnology[:CHANnel<ch>]..... | 661 |
| [SENSe:]POWer:ACHannel:SBLOCK<sb>:TXCHannel:COUNT.....          | 662 |
| [SENSe:]POWer:ACHannel:SPACing:ALTerNate<ch>.....               | 646 |
| [SENSe:]POWer:ACHannel:SPACing:CHANnel<ch>.....                 | 647 |
| [SENSe:]POWer:ACHannel:SPACing:GAP<gap>.....                    | 669 |
| [SENSe:]POWer:ACHannel:SPACing:UACHannel.....                   | 662 |
| [SENSe:]POWer:ACHannel:SPACing:UALTerNate<ch>.....              | 662 |
| [SENSe:]POWer:ACHannel:SPACing[:ACHannel].....                  | 646 |
| [SENSe:]POWer:ACHannel:SSETup.....                              | 663 |
| [SENSe:]POWer:ACHannel:TXCHannel:COUNT.....                     | 647 |
| [SENSe:]POWer:BANDwidth.....                                    | 679 |
| [SENSe:]POWer:BWIDth.....                                       | 679 |
| [SENSe:]POWer:HSPeed.....                                       | 657 |
| [SENSe:]POWer:NCORrection.....                                  | 794 |
| [SENSe:]POWer:TRACe.....                                        | 641 |
| [SENSe:]ROSCillator:SOURce.....                                 | 970 |
| [SENSe:]ROSCillator:SOURce:EAUTO?.....                          | 970 |
| [SENSe:]SWEep:COUNT.....                                        | 789 |
| [SENSe:]SWEep:COUNT:CURRent?.....                               | 636 |
| [SENSe:]SWEep:EGATE.....                                        | 804 |
| [SENSe:]SWEep:EGATE:HOLDoff.....                                | 805 |
| [SENSe:]SWEep:EGATE:LENGth.....                                 | 805 |
| [SENSe:]SWEep:EGATE:POLarity.....                               | 805 |
| [SENSe:]SWEep:EGATE:SOURce.....                                 | 806 |
| [SENSe:]SWEep:EGATE:TRACe:PERiod.....                           | 730 |
| [SENSe:]SWEep:EGATE:TRACe<t>:COMMeNt.....                       | 730 |
| [SENSe:]SWEep:EGATE:TRACe<t>:STARt<range>.....                  | 730 |
| [SENSe:]SWEep:EGATE:TRACe<t>:STOP<range>.....                   | 731 |
| [SENSe:]SWEep:EGATE:TRACe<t>[:STATe<range>].....                | 731 |
| [SENSe:]SWEep:EGATE:TYPE.....                                   | 806 |
| [SENSe:]SWEep:MODE.....                                         | 682 |
| [SENSe:]SWEep:OPTimize.....                                     | 789 |
| [SENSe:]SWEep:POINts.....                                       | 790 |
| [SENSe:]SWEep:TIME.....                                         | 790 |
| [SENSe:]SWEep:TIME:AUTO.....                                    | 790 |
| [SENSe:]SWEep:TYPE.....                                         | 791 |
| [SENSe:]SWEep:TYPE:USED.....                                    | 791 |
| *CAL?.....                                                      | 619 |
| *CLS.....                                                       | 619 |
| *ESE.....                                                       | 619 |
| *ESR?.....                                                      | 619 |
| *IDN?.....                                                      | 620 |



|                                                                  |     |
|------------------------------------------------------------------|-----|
| *IST?                                                            | 620 |
| *OPC                                                             | 620 |
| *OPT?                                                            | 620 |
| *PCB                                                             | 621 |
| *PRE                                                             | 621 |
| *PSC                                                             | 621 |
| *RST                                                             | 621 |
| *SRE                                                             | 622 |
| *STB?                                                            | 622 |
| *TRG                                                             | 622 |
| *TST?                                                            | 622 |
| *WAI                                                             | 623 |
| ABORT                                                            | 633 |
| CALCulate<n>:DELTamarker<m>:AOFF                                 | 863 |
| CALCulate<n>:DELTamarker<m>:FUNction:BPOwer:MODE                 | 903 |
| CALCulate<n>:DELTamarker<m>:FUNction:BPOwer:RESult?              | 903 |
| CALCulate<n>:DELTamarker<m>:FUNction:BPOwer:SPAN                 | 904 |
| CALCulate<n>:DELTamarker<m>:FUNction:BPOwer[:STATe]              | 904 |
| CALCulate<n>:DELTamarker<m>:FUNction:FIXed:RPOint:MAXimum[:PEAK] | 892 |
| CALCulate<n>:DELTamarker<m>:FUNction:FIXed:RPOint:X              | 892 |
| CALCulate<n>:DELTamarker<m>:FUNction:FIXed:RPOint:Y              | 893 |
| CALCulate<n>:DELTamarker<m>:FUNction:FIXed:RPOint:Y:OFFSet       | 893 |
| CALCulate<n>:DELTamarker<m>:FUNction:FIXed[:STATe]               | 893 |
| CALCulate<n>:DELTamarker<m>:FUNction:PNOise:AUTO                 | 899 |
| CALCulate<n>:DELTamarker<m>:FUNction:PNOise:RESult?              | 899 |
| CALCulate<n>:DELTamarker<m>:FUNction:PNOise[:STATe]              | 900 |
| CALCulate<n>:DELTamarker<m>:LINK                                 | 863 |
| CALCulate<n>:DELTamarker<m>:LINK:TO:MARKer<m>                    | 863 |
| CALCulate<n>:DELTamarker<m>:MAXimum:LEFT                         | 877 |
| CALCulate<n>:DELTamarker<m>:MAXimum:NEXT                         | 877 |
| CALCulate<n>:DELTamarker<m>:MAXimum:RIGHT                        | 878 |
| CALCulate<n>:DELTamarker<m>:MAXimum[:PEAK]                       | 877 |
| CALCulate<n>:DELTamarker<m>:MINimum:LEFT                         | 878 |
| CALCulate<n>:DELTamarker<m>:MINimum:NEXT                         | 878 |
| CALCulate<n>:DELTamarker<m>:MINimum:RIGHT                        | 879 |
| CALCulate<n>:DELTamarker<m>:MINimum[:PEAK]                       | 879 |
| CALCulate<n>:DELTamarker<m>:MODE                                 | 864 |
| CALCulate<n>:DELTamarker<m>:MREF                                 | 864 |
| CALCulate<n>:DELTamarker<m>:SGRam:FRAME                          | 888 |
| CALCulate<n>:DELTamarker<m>:SGRam:SARea                          | 888 |
| CALCulate<n>:DELTamarker<m>:SGRam:XY:MAXimum[:PEAK]              | 889 |
| CALCulate<n>:DELTamarker<m>:SGRam:XY:MINimum[:PEAK]              | 889 |
| CALCulate<n>:DELTamarker<m>:SGRam:Y:MAXimum:ABOVE                | 889 |
| CALCulate<n>:DELTamarker<m>:SGRam:Y:MAXimum:BELOW                | 890 |
| CALCulate<n>:DELTamarker<m>:SGRam:Y:MAXimum:NEXT                 | 890 |
| CALCulate<n>:DELTamarker<m>:SGRam:Y:MAXimum[:PEAK]               | 890 |
| CALCulate<n>:DELTamarker<m>:SGRam:Y:MINimum:ABOVE                | 891 |
| CALCulate<n>:DELTamarker<m>:SGRam:Y:MINimum:BELOW                | 891 |
| CALCulate<n>:DELTamarker<m>:SGRam:Y:MINimum:NEXT                 | 891 |
| CALCulate<n>:DELTamarker<m>:SGRam:Y:MINimum[:PEAK]               | 892 |

|                                                                     |     |
|---------------------------------------------------------------------|-----|
| CALCulate<n>:DELTamarker<m>:SPECtrogram:FRAMe.....                  | 888 |
| CALCulate<n>:DELTamarker<m>:SPECtrogram:SARea.....                  | 888 |
| CALCulate<n>:DELTamarker<m>:SPECtrogram:XY:MAXimum[:PEAK].....      | 889 |
| CALCulate<n>:DELTamarker<m>:SPECtrogram:XY:MINimum[:PEAK].....      | 889 |
| CALCulate<n>:DELTamarker<m>:SPECtrogram:Y:MAXimum:ABOVe.....        | 889 |
| CALCulate<n>:DELTamarker<m>:SPECtrogram:Y:MAXimum:BELOW.....        | 890 |
| CALCulate<n>:DELTamarker<m>:SPECtrogram:Y:MAXimum:NEXT.....         | 890 |
| CALCulate<n>:DELTamarker<m>:SPECtrogram:Y:MAXimum[:PEAK].....       | 890 |
| CALCulate<n>:DELTamarker<m>:SPECtrogram:Y:MINimum:ABOVe.....        | 891 |
| CALCulate<n>:DELTamarker<m>:SPECtrogram:Y:MINimum:BELOW.....        | 891 |
| CALCulate<n>:DELTamarker<m>:SPECtrogram:Y:MINimum:NEXT.....         | 891 |
| CALCulate<n>:DELTamarker<m>:SPECtrogram:Y:MINimum[:PEAK].....       | 892 |
| CALCulate<n>:DELTamarker<m>:TRACe.....                              | 865 |
| CALCulate<n>:DELTamarker<m>:X.....                                  | 865 |
| CALCulate<n>:DELTamarker<m>:X:RELative?.....                        | 880 |
| CALCulate<n>:DELTamarker<m>:Y?.....                                 | 880 |
| CALCulate<n>:DELTamarker<m>[:STATe].....                            | 865 |
| CALCulate<n>:DLINe<k>.....                                          | 917 |
| CALCulate<n>:DLINe<k>:STATe.....                                    | 918 |
| CALCulate<n>:ESPectrum:PEAKsearch:AUTO.....                         | 710 |
| CALCulate<n>:ESPectrum:PEAKsearch:DETAils.....                      | 724 |
| CALCulate<n>:ESPectrum:PEAKsearch:MARGIn.....                       | 711 |
| CALCulate<n>:ESPectrum:PEAKsearch:PSHow.....                        | 711 |
| CALCulate<n>:ESPectrum:PEAKsearch[:IMMEdiate].....                  | 711 |
| CALCulate<n>:ESPectrum:PSEArch:AUTO.....                            | 710 |
| CALCulate<n>:ESPectrum:PSEArch:MARGIn.....                          | 711 |
| CALCulate<n>:ESPectrum:PSEArch:PSHow.....                           | 711 |
| CALCulate<n>:ESPectrum:PSEArch[:IMMEdiate].....                     | 711 |
| CALCulate<n>:FLINe<k>.....                                          | 918 |
| CALCulate<n>:FLINe<k>:STATe.....                                    | 918 |
| CALCulate<n>:LIMit<k>:ACPowEr:ACHannel:ABSolute.....                | 651 |
| CALCulate<n>:LIMit<k>:ACPowEr:ACHannel:ABSolute:STATe.....          | 651 |
| CALCulate<n>:LIMit<k>:ACPowEr:ACHannel:RESult?.....                 | 652 |
| CALCulate<n>:LIMit<k>:ACPowEr:ACHannel[:RELative].....              | 652 |
| CALCulate<n>:LIMit<k>:ACPowEr:ACHannel[:RELative]:STATe.....        | 653 |
| CALCulate<n>:LIMit<k>:ACPowEr:ALTErnate<ch>:ABSolute.....           | 653 |
| CALCulate<n>:LIMit<k>:ACPowEr:ALTErnate<ch>:ABSolute:STATe.....     | 654 |
| CALCulate<n>:LIMit<k>:ACPowEr:ALTErnate<ch>:RESult?.....            | 655 |
| CALCulate<n>:LIMit<k>:ACPowEr:ALTErnate<ch>[:RELative].....         | 654 |
| CALCulate<n>:LIMit<k>:ACPowEr:ALTErnate<ch>[:RELative]:STATe.....   | 655 |
| CALCulate<n>:LIMit<k>:ACPowEr:GAP<gap>:ABSolute.....                | 665 |
| CALCulate<n>:LIMit<k>:ACPowEr:GAP<gap>:ABSolute:STATe.....          | 666 |
| CALCulate<n>:LIMit<k>:ACPowEr:GAP<gap>:ACLR[:RELative].....         | 666 |
| CALCulate<n>:LIMit<k>:ACPowEr:GAP<gap>:ACLR[:RELative]:STATe.....   | 666 |
| CALCulate<n>:LIMit<k>:ACPowEr:GAP<gap>[:CACLR]:RESult?.....         | 671 |
| CALCulate<n>:LIMit<k>:ACPowEr:GAP<gap>[:CACLR]:RELative].....       | 667 |
| CALCulate<n>:LIMit<k>:ACPowEr:GAP<gap>[:CACLR]:RELative]:STATe..... | 667 |
| CALCulate<n>:LIMit<k>:ACPowEr[:STATe].....                          | 656 |
| CALCulate<n>:LIMit<k>:ACTive?.....                                  | 929 |
| CALCulate<n>:LIMit<k>:CLEAr[:IMMEdiate].....                        | 932 |

|                                                                       |      |
|-----------------------------------------------------------------------|------|
| CALCulate<n>:LIMit<k>:COMment.....                                    | 920  |
| CALCulate<n>:LIMit<k>:CONTrOl:DOMain.....                             | 921  |
| CALCulate<n>:LIMit<k>:CONTrOl:MODE.....                               | 921  |
| CALCulate<n>:LIMit<k>:CONTrOl:OFFSet.....                             | 922  |
| CALCulate<n>:LIMit<k>:CONTrOl:SHIFt.....                              | 922  |
| CALCulate<n>:LIMit<k>:CONTrOl:SPACing.....                            | 922  |
| CALCulate<n>:LIMit<k>:CONTrOl[:DATA].....                             | 920  |
| CALCulate<n>:LIMit<k>:COPY.....                                       | 930  |
| CALCulate<n>:LIMit<k>:DELeTe.....                                     | 930  |
| CALCulate<n>:LIMit<k>:ESPEctrum<sb>:LIMits.....                       | 699  |
| CALCulate<n>:LIMit<k>:ESPEctrum<sb>:MODE.....                         | 700  |
| CALCulate<n>:LIMit<k>:ESPEctrum<sb>:PCLass:COUNT.....                 | 701  |
| CALCulate<n>:LIMit<k>:ESPEctrum<sb>:PCLass<PClass>:LIMit[:STATe]..... | 702  |
| CALCulate<n>:LIMit<k>:ESPEctrum<sb>:PCLass<PClass>:MAXimum.....       | 703  |
| CALCulate<n>:LIMit<k>:ESPEctrum<sb>:PCLass<PClass>:MINimum.....       | 703  |
| CALCulate<n>:LIMit<k>:ESPEctrum<sb>:PCLass<PClass>[:EXCLusive].....   | 702  |
| CALCulate<n>:LIMit<k>:ESPEctrum<sb>:REStore.....                      | 680  |
| CALCulate<n>:LIMit<k>:ESPEctrum<sb>:VALue.....                        | 701  |
| CALCulate<n>:LIMit<k>:FAIL?.....                                      | 932  |
| CALCulate<n>:LIMit<k>:LOWer:MARGin.....                               | 923  |
| CALCulate<n>:LIMit<k>:LOWer:MODE.....                                 | 923  |
| CALCulate<n>:LIMit<k>:LOWer:OFFSet.....                               | 924  |
| CALCulate<n>:LIMit<k>:LOWer:SHIFt.....                                | 924  |
| CALCulate<n>:LIMit<k>:LOWer:SPACing.....                              | 924  |
| CALCulate<n>:LIMit<k>:LOWer:STATe.....                                | 925  |
| CALCulate<n>:LIMit<k>:LOWer:THReshold.....                            | 925  |
| CALCulate<n>:LIMit<k>:LOWer[:DATA].....                               | 923  |
| CALCulate<n>:LIMit<k>:NAME.....                                       | 925  |
| CALCulate<n>:LIMit<k>:STATe.....                                      | 930  |
| CALCulate<n>:LIMit<k>:TRACe.....                                      | 1039 |
| CALCulate<n>:LIMit<k>:TRACe<t>:CHECK.....                             | 931  |
| CALCulate<n>:LIMit<k>:UNIT.....                                       | 926  |
| CALCulate<n>:LIMit<k>:UPPer:MARGin.....                               | 927  |
| CALCulate<n>:LIMit<k>:UPPer:MODE.....                                 | 927  |
| CALCulate<n>:LIMit<k>:UPPer:OFFSet.....                               | 927  |
| CALCulate<n>:LIMit<k>:UPPer:SHIFt.....                                | 928  |
| CALCulate<n>:LIMit<k>:UPPer:SPACing.....                              | 928  |
| CALCulate<n>:LIMit<k>:UPPer:STATe.....                                | 928  |
| CALCulate<n>:LIMit<k>:UPPer:THReshold.....                            | 929  |
| CALCulate<n>:LIMit<k>:UPPer[:DATA].....                               | 926  |
| CALCulate<n>:MARKer<m>:AOFF.....                                      | 866  |
| CALCulate<n>:MARKer<m>:COUNT.....                                     | 908  |
| CALCulate<n>:MARKer<m>:COUNT:FREQuency?.....                          | 909  |
| CALCulate<n>:MARKer<m>:COUNT:RESolution.....                          | 909  |
| CALCulate<n>:MARKer<m>:FUNction:BPOWer:MODE.....                      | 901  |
| CALCulate<n>:MARKer<m>:FUNction:BPOWer:RESult?.....                   | 902  |
| CALCulate<n>:MARKer<m>:FUNction:BPOWer:SPAN.....                      | 902  |
| CALCulate<n>:MARKer<m>:FUNction:BPOWer[:STATe].....                   | 902  |
| CALCulate<n>:MARKer<m>:FUNction:CENter.....                           | 776  |
| CALCulate<n>:MARKer<m>:FUNction:CStep.....                            | 776  |

|                                                                      |     |
|----------------------------------------------------------------------|-----|
| CALCulate<n>:MARKer<m>:FUNction:FPEaks:ANNotation:LABel[:STATe]..... | 894 |
| CALCulate<n>:MARKer<m>:FUNction:FPEaks:COUNT?.....                   | 895 |
| CALCulate<n>:MARKer<m>:FUNction:FPEaks:LIST:SIZE.....                | 896 |
| CALCulate<n>:MARKer<m>:FUNction:FPEaks:SORT.....                     | 896 |
| CALCulate<n>:MARKer<m>:FUNction:FPEaks:STATe.....                    | 896 |
| CALCulate<n>:MARKer<m>:FUNction:FPEaks:X?.....                       | 897 |
| CALCulate<n>:MARKer<m>:FUNction:FPEaks:Y?.....                       | 897 |
| CALCulate<n>:MARKer<m>:FUNction:FPEaks[:IMMediate].....              | 895 |
| CALCulate<n>:MARKer<m>:FUNction:HARMonics:BANDwidth:AUTO.....        | 749 |
| CALCulate<n>:MARKer<m>:FUNction:HARMonics:DIStortion?.....           | 750 |
| CALCulate<n>:MARKer<m>:FUNction:HARMonics:LIST?.....                 | 750 |
| CALCulate<n>:MARKer<m>:FUNction:HARMonics:NHARmonics.....            | 749 |
| CALCulate<n>:MARKer<m>:FUNction:HARMonics:PRESet.....                | 749 |
| CALCulate<n>:MARKer<m>:FUNction:HARMonics[:STATe].....               | 748 |
| CALCulate<n>:MARKer<m>:FUNction:MDEPth:RESult?.....                  | 755 |
| CALCulate<n>:MARKer<m>:FUNction:MDEPth:SEARChsignal ONCE.....        | 755 |
| CALCulate<n>:MARKer<m>:FUNction:MDEPth[:STATe].....                  | 754 |
| CALCulate<n>:MARKer<m>:FUNction:MSUMmary.....                        | 762 |
| CALCulate<n>:MARKer<m>:FUNction:NDBDown.....                         | 905 |
| CALCulate<n>:MARKer<m>:FUNction:NDBDown:FREQuency?.....              | 905 |
| CALCulate<n>:MARKer<m>:FUNction:NDBDown:QFACtor?.....                | 906 |
| CALCulate<n>:MARKer<m>:FUNction:NDBDown:RESult?.....                 | 906 |
| CALCulate<n>:MARKer<m>:FUNction:NDBDown:STATe.....                   | 907 |
| CALCulate<n>:MARKer<m>:FUNction:NDBDown:TIME?.....                   | 907 |
| CALCulate<n>:MARKer<m>:FUNction:NOISe:RESult?.....                   | 897 |
| CALCulate<n>:MARKer<m>:FUNction:NOISe[:STATe].....                   | 898 |
| CALCulate<n>:MARKer<m>:FUNction:PNOise:RESult?.....                  | 900 |
| CALCulate<n>:MARKer<m>:FUNction:PNOise[:STATe].....                  | 901 |
| CALCulate<n>:MARKer<m>:FUNction:POWer:MODE.....                      | 637 |
| CALCulate<n>:MARKer<m>:FUNction:POWer:PRESet.....                    | 642 |
| CALCulate<n>:MARKer<m>:FUNction:POWer:RESult:PHZ.....                | 672 |
| CALCulate<n>:MARKer<m>:FUNction:POWer:SELEct.....                    | 639 |
| CALCulate<n>:MARKer<m>:FUNction:POWer:STANdard:CATalog?.....         | 642 |
| CALCulate<n>:MARKer<m>:FUNction:POWer:STANdard:DELEte.....           | 642 |
| CALCulate<n>:MARKer<m>:FUNction:POWer:STANdard:SAVE.....             | 643 |
| CALCulate<n>:MARKer<m>:FUNction:POWer[:STATe].....                   | 639 |
| CALCulate<n>:MARKer<m>:FUNction:POWer<sb>:RESult?.....               | 637 |
| CALCulate<n>:MARKer<m>:FUNction:REFerence.....                       | 792 |
| CALCulate<n>:MARKer<m>:FUNction:STRack:BANDwidth.....                | 784 |
| CALCulate<n>:MARKer<m>:FUNction:STRack:THReshold.....                | 784 |
| CALCulate<n>:MARKer<m>:FUNction:STRack:TRACe.....                    | 785 |
| CALCulate<n>:MARKer<m>:FUNction:STRack[:STATe].....                  | 784 |
| CALCulate<n>:MARKer<m>:FUNction:SUMMery:AOFF.....                    | 739 |
| CALCulate<n>:MARKer<m>:FUNction:SUMMery:AVERAge.....                 | 739 |
| CALCulate<n>:MARKer<m>:FUNction:SUMMery:MEAN:AVERAge:RESult?.....    | 742 |
| CALCulate<n>:MARKer<m>:FUNction:SUMMery:MEAN:PHOLd:RESult?.....      | 742 |
| CALCulate<n>:MARKer<m>:FUNction:SUMMery:MEAN:RESult?.....            | 743 |
| CALCulate<n>:MARKer<m>:FUNction:SUMMery:MEAN[:STATe].....            | 740 |
| CALCulate<n>:MARKer<m>:FUNction:SUMMery:PHOLd.....                   | 740 |
| CALCulate<n>:MARKer<m>:FUNction:SUMMery:PPEak:AVERAge:RESult?.....   | 743 |

|                                                                    |     |
|--------------------------------------------------------------------|-----|
| CALCulate<n>:MARKer<m>:FUNction:SUMMary:PPEak:PHOLd:RESult?        | 743 |
| CALCulate<n>:MARKer<m>:FUNction:SUMMary:PPEak:RESult?              | 744 |
| CALCulate<n>:MARKer<m>:FUNction:SUMMary:PPEak[:STATe]              | 741 |
| CALCulate<n>:MARKer<m>:FUNction:SUMMary:RMS:AVERage:RESult?        | 744 |
| CALCulate<n>:MARKer<m>:FUNction:SUMMary:RMS:PHOLd:RESult?          | 745 |
| CALCulate<n>:MARKer<m>:FUNction:SUMMary:RMS:RESult?                | 745 |
| CALCulate<n>:MARKer<m>:FUNction:SUMMary:RMS[:STATe]                | 741 |
| CALCulate<n>:MARKer<m>:FUNction:SUMMary:SDEViation:AVERage:RESult? | 745 |
| CALCulate<n>:MARKer<m>:FUNction:SUMMary:SDEViation:PHOLd:RESult?   | 746 |
| CALCulate<n>:MARKer<m>:FUNction:SUMMary:SDEViation:RESult?         | 746 |
| CALCulate<n>:MARKer<m>:FUNction:SUMMary:SDEViation[:STATe]         | 741 |
| CALCulate<n>:MARKer<m>:FUNction:SUMMary[:STATe]                    | 740 |
| CALCulate<n>:MARKer<m>:FUNction:TOI:RESult?                        | 753 |
| CALCulate<n>:MARKer<m>:FUNction:TOI:SEARChsignal ONCE              | 753 |
| CALCulate<n>:MARKer<m>:FUNction:TOI[:STATe]                        | 752 |
| CALCulate<n>:MARKer<m>:LINK:TO:MARKer<m>                           | 866 |
| CALCulate<n>:MARKer<m>:LOEXclude                                   | 870 |
| CALCulate<n>:MARKer<m>:MAXimum:AUTO                                | 873 |
| CALCulate<n>:MARKer<m>:MAXimum:LEFT                                | 874 |
| CALCulate<n>:MARKer<m>:MAXimum:NEXT                                | 874 |
| CALCulate<n>:MARKer<m>:MAXimum:RIGHT                               | 875 |
| CALCulate<n>:MARKer<m>:MAXimum[:PEAK]                              | 874 |
| CALCulate<n>:MARKer<m>:MINimum:AUTO                                | 875 |
| CALCulate<n>:MARKer<m>:MINimum:LEFT                                | 875 |
| CALCulate<n>:MARKer<m>:MINimum:NEXT                                | 876 |
| CALCulate<n>:MARKer<m>:MINimum:RIGHT                               | 876 |
| CALCulate<n>:MARKer<m>:MINimum[:PEAK]                              | 876 |
| CALCulate<n>:MARKer<m>:PEXCursion                                  | 870 |
| CALCulate<n>:MARKer<m>:SGRam:FRAME                                 | 883 |
| CALCulate<n>:MARKer<m>:SGRam:SARea                                 | 883 |
| CALCulate<n>:MARKer<m>:SGRam:XY:MAXimum[:PEAK]                     | 884 |
| CALCulate<n>:MARKer<m>:SGRam:XY:MINimum[:PEAK]                     | 884 |
| CALCulate<n>:MARKer<m>:SGRam:Y:MAXimum:ABOVE                       | 884 |
| CALCulate<n>:MARKer<m>:SGRam:Y:MAXimum:BELOW                       | 885 |
| CALCulate<n>:MARKer<m>:SGRam:Y:MAXimum:NEXT                        | 885 |
| CALCulate<n>:MARKer<m>:SGRam:Y:MAXimum[:PEAK]                      | 885 |
| CALCulate<n>:MARKer<m>:SGRam:Y:MINimum:ABOVE                       | 886 |
| CALCulate<n>:MARKer<m>:SGRam:Y:MINimum:BELOW                       | 886 |
| CALCulate<n>:MARKer<m>:SGRam:Y:MINimum:NEXT                        | 886 |
| CALCulate<n>:MARKer<m>:SGRam:Y:MINimum[:PEAK]                      | 887 |
| CALCulate<n>:MARKer<m>:SPECTrogram:FRAME                           | 883 |
| CALCulate<n>:MARKer<m>:SPECTrogram:SARea                           | 883 |
| CALCulate<n>:MARKer<m>:SPECTrogram:XY:MAXimum[:PEAK]               | 884 |
| CALCulate<n>:MARKer<m>:SPECTrogram:XY:MINimum[:PEAK]               | 884 |
| CALCulate<n>:MARKer<m>:SPECTrogram:Y:MAXimum:ABOVE                 | 884 |
| CALCulate<n>:MARKer<m>:SPECTrogram:Y:MAXimum:BELOW                 | 885 |
| CALCulate<n>:MARKer<m>:SPECTrogram:Y:MAXimum:NEXT                  | 885 |
| CALCulate<n>:MARKer<m>:SPECTrogram:Y:MAXimum[:PEAK]                | 885 |
| CALCulate<n>:MARKer<m>:SPECTrogram:Y:MINimum:ABOVE                 | 886 |
| CALCulate<n>:MARKer<m>:SPECTrogram:Y:MINimum:BELOW                 | 886 |

|                                                            |     |
|------------------------------------------------------------|-----|
| CALCulate<n>:MARKer<m>:SPECTrogram:Y:MINimum:NEXT.....     | 886 |
| CALCulate<n>:MARKer<m>:SPECTrogram:Y:MINimum[:PEAK].....   | 887 |
| CALCulate<n>:MARKer<m>:TRACe.....                          | 867 |
| CALCulate<n>:MARKer<m>:X.....                              | 867 |
| CALCulate<n>:MARKer<m>:X:SLIMits:LEFT.....                 | 871 |
| CALCulate<n>:MARKer<m>:X:SLIMits:RIGHT.....                | 871 |
| CALCulate<n>:MARKer<m>:X:SLIMits:ZOOM[:STATe].....         | 872 |
| CALCulate<n>:MARKer<m>:X:SLIMits[:STATe].....              | 870 |
| CALCulate<n>:MARKer<m>:X:SSIZe.....                        | 869 |
| CALCulate<n>:MARKer<m>:Y:PERCent.....                      | 729 |
| CALCulate<n>:MARKer<m>:Y?.....                             | 881 |
| CALCulate<n>:MARKer<m>[:STATe].....                        | 867 |
| CALCulate<n>:MATH:MODE.....                                | 851 |
| CALCulate<n>:MATH:POSition.....                            | 852 |
| CALCulate<n>:MATH:STATe.....                               | 852 |
| CALCulate<n>:MATH[:EXPRession][:DEFine].....               | 851 |
| CALCulate<n>:PEAKsearch:AUTO.....                          | 723 |
| CALCulate<n>:PEAKsearch:MARGin.....                        | 724 |
| CALCulate<n>:PEAKsearch:PSHow.....                         | 724 |
| CALCulate<n>:PEAKsearch:SUBRanges.....                     | 725 |
| CALCulate<n>:PMETer<p>:RELative:STATe.....                 | 826 |
| CALCulate<n>:PMETer<p>:RELative[:MAGNitude].....           | 826 |
| CALCulate<n>:PMETer<p>:RELative[:MAGNitude]:AUTO ONCE..... | 826 |
| CALCulate<n>:PSEarch:AUTO.....                             | 723 |
| CALCulate<n>:PSEarch:DETAils.....                          | 724 |
| CALCulate<n>:PSEarch:MARGin.....                           | 724 |
| CALCulate<n>:PSEarch:PSHow.....                            | 724 |
| CALCulate<n>:PSEarch:SUBRanges.....                        | 725 |
| CALCulate<n>:SGRam:CLEAr[:IMMEdiate].....                  | 844 |
| CALCulate<n>:SGRam:CONTInuous.....                         | 845 |
| CALCulate<n>:SGRam:FRAMe:COUNt.....                        | 845 |
| CALCulate<n>:SGRam:FRAMe:SELEct.....                       | 846 |
| CALCulate<n>:SGRam:HDEPth.....                             | 846 |
| CALCulate<n>:SGRam:LAYout.....                             | 847 |
| CALCulate<n>:SGRam:TSTamp:DATA?.....                       | 847 |
| CALCulate<n>:SGRam:TSTamp[:STATe].....                     | 848 |
| CALCulate<n>:SGRam[:STATe].....                            | 847 |
| CALCulate<n>:SPECTrogram:CLEAr[:IMMEdiate].....            | 844 |
| CALCulate<n>:SPECTrogram:CONTInuous.....                   | 845 |
| CALCulate<n>:SPECTrogram:FRAMe:COUNt.....                  | 845 |
| CALCulate<n>:SPECTrogram:FRAMe:SELEct.....                 | 846 |
| CALCulate<n>:SPECTrogram:HDEPth.....                       | 846 |
| CALCulate<n>:SPECTrogram:LAYout.....                       | 847 |
| CALCulate<n>:SPECTrogram:TSTamp:DATA?.....                 | 847 |
| CALCulate<n>:SPECTrogram:TSTamp[:STATe].....               | 848 |
| CALCulate<n>:SPECTrogram[:STATe].....                      | 847 |
| CALCulate<n>:STATistics:APD[:STATe].....                   | 728 |
| CALCulate<n>:STATistics:CCDF:X<t>?.....                    | 735 |
| CALCulate<n>:STATistics:CCDF[:STATe].....                  | 729 |
| CALCulate<n>:STATistics:NSAMPles.....                      | 729 |

|                                                  |     |
|--------------------------------------------------|-----|
| CALCulate<n>:STATistics:PRESet.....              | 732 |
| CALCulate<n>:STATistics:RESult<t>?.....          | 736 |
| CALCulate<n>:STATistics:SCALe:AUTO ONCE.....     | 733 |
| CALCulate<n>:STATistics:SCALe:X:RANGe.....       | 733 |
| CALCulate<n>:STATistics:SCALe:X:RLEVel.....      | 733 |
| CALCulate<n>:STATistics:SCALe:Y:LOWer.....       | 734 |
| CALCulate<n>:STATistics:SCALe:Y:UNIT.....        | 734 |
| CALCulate<n>:STATistics:SCALe:Y:UPPer.....       | 734 |
| CALCulate<n>:THReshold.....                      | 872 |
| CALCulate<n>:THReshold:STATe.....                | 873 |
| CALCulate<n>:TLINe<k>.....                       | 919 |
| CALCulate<n>:TLINe<k>:STATe.....                 | 919 |
| CALCulate<n>:UNIT:POWer.....                     | 793 |
| CALibration:PMETer<p>:ZERO:AUTO ONCE.....        | 825 |
| CALibration:RESult?.....                         | 971 |
| CALibration[:ALL]?.....                          | 971 |
| DIAGnostic:INFO:CCOunt?.....                     | 989 |
| DIAGnostic:SERVice:BIOSinfo?.....                | 990 |
| DIAGnostic:SERVice:HWINfo?.....                  | 990 |
| DIAGnostic:SERVice:INPut:PULSed:CFRequency.....  | 972 |
| DIAGnostic:SERVice:INPut:PULSed:MCFRequency..... | 972 |
| DIAGnostic:SERVice:INPut:PULSed:WBFRequency..... | 972 |
| DIAGnostic:SERVice:INPut:RF[:SPECTrum].....      | 973 |
| DIAGnostic:SERVice:INPut[:SElect].....           | 973 |
| DIAGnostic:SERVice:NSource.....                  | 834 |
| DIAGnostic:SERVice:SFUNction.....                | 995 |
| DIAGnostic:SERVice:SFUNction:LASTresult?.....    | 995 |
| DIAGnostic:SERVice:SFUNction:RESults:DELeTe..... | 995 |
| DIAGnostic:SERVice:SFUNction:RESults:SAVE.....   | 995 |
| DIAGnostic:SERVice:SINFo?.....                   | 995 |
| DIAGnostic:SERVice:STESt:RESult?.....            | 974 |
| DIAGnostic:SERVice:VERSinfo?.....                | 990 |
| DISPlay:ANNotation:CBAR.....                     | 979 |
| DISPlay:ANNotation:FREQuency.....                | 979 |
| DISPlay:ATAB.....                                | 623 |
| DISPlay:CMAp<item>:DEFault<color>.....           | 981 |
| DISPlay:CMAp<item>:HSL.....                      | 982 |
| DISPlay:CMAp<item>:PDEFined.....                 | 982 |
| DISPlay:FORMat.....                              | 766 |
| DISPlay:LOGO.....                                | 952 |
| DISPlay:MINFo[:STATe].....                       | 868 |
| DISPlay:SBAR[:STATe].....                        | 979 |
| DISPlay:SKEYs[:STATe].....                       | 980 |
| DISPlay:TBAR[:STATe].....                        | 980 |
| DISPlay:THEMe:CATalog?.....                      | 983 |
| DISPlay:THEMe:SElect.....                        | 983 |
| DISPlay[:WINDow]:TIME.....                       | 980 |
| DISPlay[:WINDow]:TIME:FORMat.....                | 980 |
| DISPlay[:WINDow<n>]:MTABle.....                  | 868 |
| DISPlay[:WINDow<n>]:SGRam:COLor:DEFault.....     | 849 |

|                                                           |      |
|-----------------------------------------------------------|------|
| DISPlay[:WINDow<n>]:SGRam:COLor:LOWer.....                | 849  |
| DISPlay[:WINDow<n>]:SGRam:COLor:SHAPE.....                | 849  |
| DISPlay[:WINDow<n>]:SGRam:COLor:UPPer.....                | 850  |
| DISPlay[:WINDow<n>]:SGRam:COLor[:STYLe].....              | 850  |
| DISPlay[:WINDow<n>]:SIZE.....                             | 766  |
| DISPlay[:WINDow<n>]:SPECTrogram:COLor:DEFault.....        | 849  |
| DISPlay[:WINDow<n>]:SPECTrogram:COLor:LOWer.....          | 849  |
| DISPlay[:WINDow<n>]:SPECTrogram:COLor:SHAPE.....          | 849  |
| DISPlay[:WINDow<n>]:SPECTrogram:COLor:UPPer.....          | 850  |
| DISPlay[:WINDow<n>]:SPECTrogram:COLor[:STYLe].....        | 850  |
| DISPlay[:WINDow<n>]:STATe.....                            | 1039 |
| DISPlay[:WINDow<n>]:TRACe:X:SPACing.....                  | 777  |
| DISPlay[:WINDow<n>]:TRACe<t>:MODE.....                    | 838  |
| DISPlay[:WINDow<n>]:TRACe<t>:MODE:HCONTinuous.....        | 839  |
| DISPlay[:WINDow<n>]:TRACe<t>:SMOothing:APERture.....      | 840  |
| DISPlay[:WINDow<n>]:TRACe<t>:SMOothing[:STATe].....       | 841  |
| DISPlay[:WINDow<n>]:TRACe<t>:Y:SPACing.....               | 799  |
| DISPlay[:WINDow<n>]:TRACe<t>:Y[:SCALe].....               | 797  |
| DISPlay[:WINDow<n>]:TRACe<t>:Y[:SCALe]:AUTO ONCE.....     | 797  |
| DISPlay[:WINDow<n>]:TRACe<t>:Y[:SCALe]:MODE.....          | 798  |
| DISPlay[:WINDow<n>]:TRACe<t>:Y[:SCALe]:PDIVision.....     | 798  |
| DISPlay[:WINDow<n>]:TRACe<t>:Y[:SCALe]:RLEVel.....        | 793  |
| DISPlay[:WINDow<n>]:TRACe<t>:Y[:SCALe]:RLEVel:OFFSet..... | 793  |
| DISPlay[:WINDow<n>]:TRACe<t>:Y[:SCALe]:RPOSition.....     | 798  |
| DISPlay[:WINDow<n>]:TRACe<t>:Y[:SCALe]:RVALue.....        | 819  |
| DISPlay[:WINDow<n>]:TRACe<t>[:STATe].....                 | 840  |
| DISPlay[:WINDow<n>]:TYPE.....                             | 1040 |
| DISPlay[:WINDow<n>]:ZOOM:AREA.....                        | 835  |
| DISPlay[:WINDow<n>]:ZOOM:MULTiple<zoom>:AREA.....         | 836  |
| DISPlay[:WINDow<n>]:ZOOM:MULTiple<zoom>[:STATe].....      | 837  |
| DISPlay[:WINDow<n>]:ZOOM[:STATe].....                     | 836  |
| FETCh:PMETer<p>?.....                                     | 827  |
| FORMat:DEXPort:DSEParator.....                            | 937  |
| FORMat:DEXPort:FORMat.....                                | 857  |
| FORMat:DEXPort:HEADer.....                                | 963  |
| FORMat:DEXPort:TRACes.....                                | 858  |
| FORMat:DEXPort:TRACes.....                                | 963  |
| FORMat:DIMPort:TRACes.....                                | 858  |
| FORMat[:DATA].....                                        | 853  |
| HCOPY:ABORt.....                                          | 952  |
| HCOPY:CMAP<item>:DEFault<color>.....                      | 953  |
| HCOPY:CMAP<item>:HSL.....                                 | 954  |
| HCOPY:CMAP<item>:PDEFined.....                            | 954  |
| HCOPY:CONTent.....                                        | 952  |
| HCOPY:DESTination<device>.....                            | 955  |
| HCOPY:DEVice:COLor.....                                   | 955  |
| HCOPY:DEVice:LANGUage<device>.....                        | 955  |
| HCOPY:ITEM:ALL.....                                       | 1040 |
| HCOPY:ITEM:WINDow:TEXT.....                               | 956  |
| HCOPY:PAGE:COUNT:STATe.....                               | 957  |



|                                              |     |
|----------------------------------------------|-----|
| HCOPY:PAGE:MARGIn<device>:BOTTom.....        | 957 |
| HCOPY:PAGE:MARGIn<device>:LEFT.....          | 957 |
| HCOPY:PAGE:MARGIn<device>:RIGHT.....         | 958 |
| HCOPY:PAGE:MARGIn<device>:TOP.....           | 958 |
| HCOPY:PAGE:MARGIn<device>:UNIT.....          | 958 |
| HCOPY:PAGE:ORlentation<device>.....          | 959 |
| HCOPY:PAGE:WINDow<device>:CHANnel:STATe..... | 959 |
| HCOPY:PAGE:WINDow<device>:COUNT.....         | 960 |
| HCOPY:PAGE:WINDow<device>:SCALE.....         | 960 |
| HCOPY:PAGE:WINDow<device>:STATe.....         | 960 |
| HCOPY:TDSamp:STATe<device>.....              | 961 |
| HCOPY[:IMMEDIATE<device>].....               | 956 |
| HCOPY[:IMMEDIATE<device>]:NEXT.....          | 956 |
| INITiate<n>:CONMeas.....                     | 634 |
| INITiate<n>:CONTinuous.....                  | 635 |
| INITiate<n>:ESPeCtRum.....                   | 682 |
| INITiate<n>:SEQuencer:ABORt.....             | 628 |
| INITiate<n>:SEQuencer:IMMEDIATE.....         | 629 |
| INITiate<n>:SEQuencer:MODE.....              | 629 |
| INITiate<n>:SPURious.....                    | 716 |
| INITiate<n>[:IMMEDIATE].....                 | 636 |
| INPut:ATTenuation.....                       | 794 |
| INPut:ATTenuation:AUTO.....                  | 795 |
| INPut:ATTenuation:AUTO:MODE.....             | 795 |
| INPut:COUPling.....                          | 812 |
| INPut:DPATH.....                             | 812 |
| INPut:EATT.....                              | 795 |
| INPut:EATT:AUTO.....                         | 796 |
| INPut:EATT:STATe.....                        | 796 |
| INPut:FILTer:YIG[:STATe].....                | 813 |
| INPut:GAIN:STATe.....                        | 796 |
| INPut:IMPedance.....                         | 813 |
| INPut:IMPedance:PTYPE.....                   | 813 |
| INPut:SElect.....                            | 814 |
| INSTRument:CREate:DUPLicate.....             | 624 |
| INSTRument:CREate:REPLace.....               | 625 |
| INSTRument:CREate[:NEW].....                 | 624 |
| INSTRument:DELeTe.....                       | 625 |
| INSTRument:LIST?.....                        | 625 |
| INSTRument:MODE.....                         | 626 |
| INSTRument:REName.....                       | 627 |
| INSTRument[:SElect].....                     | 627 |
| LAYout:ADD[:WINDow]?.....                    | 767 |
| LAYout:CATalog[:WINDow]?.....                | 768 |
| LAYout:IDENtify[:WINDow]?.....               | 768 |
| LAYout:MOVE[:WINDow].....                    | 769 |
| LAYout:REMOve[:WINDow].....                  | 769 |
| LAYout:REPLace[:WINDow].....                 | 769 |
| LAYout:SPLitter.....                         | 770 |
| LAYout:WINDow<n>:ADD?.....                   | 771 |

|                                              |     |
|----------------------------------------------|-----|
| LAYout:WINDow<n>:IDENtify?                   | 772 |
| LAYout:WINDow<n>:REMOve                      | 772 |
| LAYout:WINDow<n>:REPLace                     | 772 |
| MMEMory:CATalog:LONG?                        | 938 |
| MMEMory:CATalog?                             | 937 |
| MMEMory:CDIRectory                           | 938 |
| MMEMory:CLEar:ALL                            | 946 |
| MMEMory:CLEar:STATe                          | 946 |
| MMEMory:COMMeNt                              | 938 |
| MMEMory:COpy                                 | 939 |
| MMEMory:DATA                                 | 939 |
| MMEMory:DELeTe                               | 940 |
| MMEMory:LOAD:AUTO                            | 946 |
| MMEMory:LOAD:STATe                           | 947 |
| MMEMory:LOAD:TYPE                            | 948 |
| MMEMory:LOAD<n>:LIMit                        | 931 |
| MMEMory:LOAD<n>:TFACtor                      | 978 |
| MMEMory:LOAD<n>:TRACe                        | 858 |
| MMEMory:MDIRectory                           | 940 |
| MMEMory:MOVE                                 | 940 |
| MMEMory:MSIS                                 | 940 |
| MMEMory:NAME                                 | 941 |
| MMEMory:NETWork:DISConnect                   | 941 |
| MMEMory:NETWork:MAP                          | 941 |
| MMEMory:NETWork:UNUSeddrives?                | 942 |
| MMEMory:NETWork:USEDdrives?                  | 942 |
| MMEMory:RDIRectory                           | 942 |
| MMEMory:SELEct:CHANnel[:ITEM]:ALL            | 943 |
| MMEMory:SELEct:CHANnel[:ITEM]:DEFault        | 943 |
| MMEMory:SELEct:CHANnel[:ITEM]:HWSettings     | 944 |
| MMEMory:SELEct:CHANnel[:ITEM]:LINES:ALL      | 944 |
| MMEMory:SELEct:CHANnel[:ITEM]:NONE           | 944 |
| MMEMory:SELEct:CHANnel[:ITEM]:SGRam          | 945 |
| MMEMory:SELEct:CHANnel[:ITEM]:SPECTrogram    | 945 |
| MMEMory:SELEct:CHANnel[:ITEM]:TRACe[:ACTive] | 945 |
| MMEMory:SELEct:CHANnel[:ITEM]:TRANsdUcer:ALL | 945 |
| MMEMory:SELEct[:ITEM]:ALL                    | 943 |
| MMEMory:SELEct[:ITEM]:DEFault                | 943 |
| MMEMory:SELEct[:ITEM]:HWSettings             | 944 |
| MMEMory:SELEct[:ITEM]:LINES:ALL              | 944 |
| MMEMory:SELEct[:ITEM]:NONE                   | 944 |
| MMEMory:SELEct[:ITEM]:SGRam                  | 945 |
| MMEMory:SELEct[:ITEM]:SPECTrogram            | 945 |
| MMEMory:SELEct[:ITEM]:TRACe[:ACTive]         | 945 |
| MMEMory:SELEct[:ITEM]:TRANsdUcer:ALL         | 945 |
| MMEMory:STORe<n>:LIMit                       | 931 |
| MMEMory:STORe<n>:LIST                        | 963 |
| MMEMory:STORe<n>:PEAK                        | 964 |
| MMEMory:STORe<n>:SGRam                       | 965 |
| MMEMory:STORe<n>:SPECTrogram                 | 965 |

|                                                     |      |
|-----------------------------------------------------|------|
| MMEMory:STORe<n>:SPURious.....                      | 965  |
| MMEMory:STORe<n>:STATe.....                         | 949  |
| MMEMory:STORe<n>:STATe:NEXt.....                    | 949  |
| MMEMory:STORe<n>:TFACtor.....                       | 978  |
| MMEMory:STORe<n>:TRACe.....                         | 859  |
| MMEMory:STORe<n>:TRACe.....                         | 966  |
| MMEMory:STORe<n>:TYPE.....                          | 950  |
| OUTPut:IF[:SOURce].....                             | 835  |
| OUTPut:TRIGger<port>:DIRectioN.....                 | 807  |
| OUTPut:TRIGger<port>:LEVel.....                     | 807  |
| OUTPut:TRIGger<port>:OTYPE.....                     | 808  |
| OUTPut:TRIGger<port>:PULSe:IMMediate.....           | 808  |
| OUTPut:TRIGger<port>:PULSe:LENGth.....              | 808  |
| READ:PMETer<p>?.....                                | 827  |
| SOURce:EXTErnal:FREQuency.....                      | 814  |
| SOURce:EXTErnal:FREQuency:COUPling[:STATe].....     | 815  |
| SOURce:EXTErnal:FREQuency:OFFSet.....               | 816  |
| SOURce:EXTErnal:FREQuency[:FACtor]:DENominator..... | 815  |
| SOURce:EXTErnal:FREQuency[:FACtor]:NUMerator.....   | 816  |
| SOURce:EXTErnal:POWEr[:LEVel].....                  | 816  |
| SOURce:EXTErnal:ROSCillator:EXTErnal:FREQuency..... | 969  |
| SOURce:EXTErnal:ROSCillator[:SOURce].....           | 817  |
| SOURce:EXTErnal[:STATe].....                        | 817  |
| SOURce:POWEr[:LEVel][:IMMediate]:OFFSet.....        | 817  |
| STATus:OPERation:CONDition?.....                    | 997  |
| STATus:OPERation:ENABle.....                        | 999  |
| STATus:OPERation:NTRansition.....                   | 999  |
| STATus:OPERation:PTRansition.....                   | 1000 |
| STATus:OPERation[:EVENT]?.....                      | 998  |
| STATus:PRESet.....                                  | 997  |
| STATus:QUEStionable:ACPLimit:CONDition?.....        | 997  |
| STATus:QUEStionable:ACPLimit:ENABle.....            | 999  |
| STATus:QUEStionable:ACPLimit:NTRansition.....       | 999  |
| STATus:QUEStionable:ACPLimit:PTRansition.....       | 1000 |
| STATus:QUEStionable:ACPLimit[:EVENT]?.....          | 998  |
| STATus:QUEStionable:CONDition?.....                 | 997  |
| STATus:QUEStionable:ENABle.....                     | 999  |
| STATus:QUEStionable:EXTended:CONDition?.....        | 997  |
| STATus:QUEStionable:EXTended:ENABle.....            | 999  |
| STATus:QUEStionable:EXTended:INFO:CONDition?.....   | 997  |
| STATus:QUEStionable:EXTended:INFO:ENABle.....       | 999  |
| STATus:QUEStionable:EXTended:INFO:NTRansition.....  | 999  |
| STATus:QUEStionable:EXTended:INFO:PTRansition.....  | 1000 |
| STATus:QUEStionable:EXTended:INFO[:EVENT]?.....     | 998  |
| STATus:QUEStionable:EXTended:NTRansition.....       | 999  |
| STATus:QUEStionable:EXTended:PTRansition.....       | 1000 |
| STATus:QUEStionable:EXTended[:EVENT]?.....          | 998  |
| STATus:QUEStionable:FREQuency:CONDition?.....       | 997  |
| STATus:QUEStionable:FREQuency:ENABle.....           | 999  |
| STATus:QUEStionable:FREQuency:NTRansition.....      | 999  |

|                                                                  |      |
|------------------------------------------------------------------|------|
| STATus:QUESTionable:FREQuency:PTRansition.....                   | 1000 |
| STATus:QUESTionable:FREQuency[:EVENT]?.....                      | 998  |
| STATus:QUESTionable:LIMit<n>:CONDition?.....                     | 997  |
| STATus:QUESTionable:LIMit<n>:ENABle.....                         | 999  |
| STATus:QUESTionable:LIMit<n>:NTRansition.....                    | 999  |
| STATus:QUESTionable:LIMit<n>:PTRansition.....                    | 1000 |
| STATus:QUESTionable:LIMit<n>[:EVENT]?.....                       | 998  |
| STATus:QUESTionable:LMARgin<n>:CONDition?.....                   | 997  |
| STATus:QUESTionable:LMARgin<n>:ENABle.....                       | 999  |
| STATus:QUESTionable:LMARgin<n>:NTRansition.....                  | 999  |
| STATus:QUESTionable:LMARgin<n>:PTRansition.....                  | 1000 |
| STATus:QUESTionable:LMARgin<n>[:EVENT]?.....                     | 998  |
| STATus:QUESTionable:NTRansition.....                             | 999  |
| STATus:QUESTionable:POWer:CONDition?.....                        | 998  |
| STATus:QUESTionable:POWer:ENABle.....                            | 999  |
| STATus:QUESTionable:POWer:NTRansition.....                       | 999  |
| STATus:QUESTionable:POWer:PTRansition.....                       | 1000 |
| STATus:QUESTionable:POWer[:EVENT]?.....                          | 998  |
| STATus:QUESTionable:PTRansition.....                             | 1000 |
| STATus:QUESTionable:TEMPerature:CONDition?.....                  | 998  |
| STATus:QUESTionable:TEMPerature:ENABle.....                      | 999  |
| STATus:QUESTionable:TEMPerature:NTRansition.....                 | 999  |
| STATus:QUESTionable:TEMPerature:PTRansition.....                 | 1000 |
| STATus:QUESTionable:TEMPerature[:EVENT]?.....                    | 998  |
| STATus:QUESTionable:TIME:CONDition?.....                         | 998  |
| STATus:QUESTionable:TIME:ENABle.....                             | 999  |
| STATus:QUESTionable:TIME:NTRansition.....                        | 999  |
| STATus:QUESTionable:TIME:PTRansition.....                        | 1000 |
| STATus:QUESTionable:TIME[:EVENT]?.....                           | 998  |
| STATus:QUESTionable[:EVENT]?.....                                | 998  |
| STATus:QUEEue[:NEXT]?.....                                       | 997  |
| SYSTem:CLOGging.....                                             | 1001 |
| SYSTem:COMMunicate:GPIB[:SELF]:ADDResS.....                      | 985  |
| SYSTem:COMMunicate:GPIB[:SELF]:RTERminator.....                  | 985  |
| SYSTem:COMMunicate:PRINter:ENUMerate:FIRSt?.....                 | 961  |
| SYSTem:COMMunicate:PRINter:ENUMerate[:NEXT]?.....                | 962  |
| SYSTem:COMMunicate:PRINter:SELEct<device>.....                   | 962  |
| SYSTem:COMMunicate:RDEvice:GENerator:INTerface.....              | 818  |
| SYSTem:COMMunicate:RDEvice:GENerator:TYPE.....                   | 818  |
| SYSTem:COMMunicate:RDEvice:PMETER:COUNT?.....                    | 824  |
| SYSTem:COMMunicate:RDEvice:PMETER<p>:CONFigure:AUTO[:STATE]..... | 824  |
| SYSTem:COMMunicate:RDEvice:PMETER<p>:DEFine.....                 | 824  |
| SYSTem:COMMunicate:TCPip:RDEvice:GENerator:ADDResS.....          | 818  |
| SYSTem:DISPlay:FPANel[:STATE].....                               | 981  |
| SYSTem:DISPlay:LANGuage.....                                     | 985  |
| SYSTem:DISPlay:UPDate.....                                       | 986  |
| SYSTem:ERRor:CLEar:ALL.....                                      | 991  |
| SYSTem:ERRor:CLEar:REMOte.....                                   | 991  |
| SYSTem:ERRor:DISPlay.....                                        | 986  |
| SYSTem:ERRor:EXTended?.....                                      | 991  |

|                                                |      |
|------------------------------------------------|------|
| SYSTem:ERRor:LIST?.....                        | 992  |
| SYSTem:ERRor[:NEXT]?.....                      | 992  |
| SYSTem:FIRMware:UPDate.....                    | 993  |
| SYSTem:FORMat:IDENT.....                       | 993  |
| SYSTem:HPCoupling.....                         | 1002 |
| SYSTem:IDENtify:FACTory.....                   | 987  |
| SYSTem:IDENtify[:STRing].....                  | 987  |
| SYSTem:IFGain:MODE.....                        | 1002 |
| SYSTem:KLOCK.....                              | 987  |
| SYSTem:LANGuage.....                           | 1002 |
| SYSTem:LXI:INFO?.....                          | 987  |
| SYSTem:LXI:LANReset.....                       | 988  |
| SYSTem:LXI:MDEScription.....                   | 988  |
| SYSTem:LXI:PASSword.....                       | 988  |
| SYSTem:PRESet.....                             | 950  |
| SYSTem:PRESet:CHANnel[:EXEC].....              | 951  |
| SYSTem:PRESet:COMPAtible.....                  | 993  |
| SYSTem:PSA:WIDeband.....                       | 1003 |
| SYSTem:REBoot.....                             | 1001 |
| SYSTem:REVisiOn:FACTory.....                   | 988  |
| SYSTem:REVisiOn[:STRing].....                  | 1003 |
| SYSTem:RSWeep.....                             | 1004 |
| SYSTem:SECurity[:STATe].....                   | 994  |
| SYSTem:SEQuencer.....                          | 630  |
| SYSTem:SHUTdown.....                           | 1001 |
| TRACe<n>:COPY.....                             | 843  |
| TRACe<n>[:DATA].....                           | 854  |
| TRACe<n>[:DATA]:MEMory?.....                   | 856  |
| TRACe<n>[:DATA]:X?.....                        | 856  |
| TRIGger[:SEQuence]:DTIME.....                  | 800  |
| TRIGger[:SEQuence]:HOLDoff[:TIME].....         | 800  |
| TRIGger[:SEQuence]:IFPower:HOLDoff.....        | 801  |
| TRIGger[:SEQuence]:IFPower:HYSTeresis.....     | 801  |
| TRIGger[:SEQuence]:LEVel:IFPower.....          | 802  |
| TRIGger[:SEQuence]:LEVel:IQPower.....          | 802  |
| TRIGger[:SEQuence]:LEVel:RFPower.....          | 802  |
| TRIGger[:SEQuence]:LEVel:VIDeo.....            | 803  |
| TRIGger[:SEQuence]:LEVel[:EXTernal<port>]..... | 801  |
| TRIGger[:SEQuence]:RFPower:HOLDoff.....        | 1041 |
| TRIGger[:SEQuence]:SLOPe.....                  | 803  |
| TRIGger[:SEQuence]:SOURce.....                 | 803  |
| UNIT<n>:PMETer<p>:POWER.....                   | 831  |
| UNIT<n>:PMETer<p>:POWER:RATIo.....             | 831  |
| UNIT<n>:POWER.....                             | 793  |

# Index

## Symbols

|                     |     |
|---------------------|-----|
| *IDN                |     |
| Format              | 609 |
| *OPC                | 585 |
| *OPC?               | 585 |
| *RST                | 603 |
| *WAI                | 585 |
| # of Samples        |     |
| Softkey (APD, CCDF) | 267 |
| "% Power Bandwidth" |     |
| Softkey             | 202 |
| 1xEV-DO BTS         |     |
| Application         | 112 |
| 1xEV-DO MS          |     |
| Application         | 112 |
| 3G FDD BTS          |     |
| Application         | 113 |
| 3G FDD UE           |     |
| Application         | 113 |
| 9.91E37             |     |
| Remote control      | 583 |
| 75 Ω (channel bar)  | 93  |

## A

|                         |               |
|-------------------------|---------------|
| Aborting                |               |
| Sweep                   | 371, 372, 480 |
| AC (channel bar)        | 93            |
| AC/DC coupling          | 304           |
| ACLR                    |               |
| MSR signals             | 155           |
| Programming example     | 673           |
| Results (remote)        | 637           |
| see CP/ACLR             | 145           |
| ACLR Mode               |               |
| Softkey                 | 164, 173      |
| Active                  |               |
| Transducer lines        | 550           |
| Adjacent channels       |               |
| MSR                     | 178           |
| MSR ACLR                | 177           |
| MSR, bandwidth          | 179           |
| MSR, configuring        | 178           |
| MSR, spacing            | 179           |
| MSR, weighting filters  | 179           |
| Adjust settings         |               |
| Softkey (APD)           | 268, 272      |
| Softkey (C/N)           | 197           |
| "Adjust Settings"       |               |
| Softkey (CP/ACLR)       | 165, 174      |
| Softkey (OBW)           | 202           |
| Adjust X-Axis           |               |
| Softkey                 | 256           |
| Alignment               |               |
| Basics                  | 532           |
| Performing              | 535           |
| Results                 | 533, 534      |
| Settings                | 533           |
| All Functions Off       | 437           |
| Alpha                   |               |
| RRC filter (SEM)        | 227           |
| Alphanumeric parameters | 99            |

|                                 |          |
|---------------------------------|----------|
| AM modulation                   |          |
| Measurement example             | 136, 137 |
| AM modulation depth             | 296      |
| About                           | 296      |
| Configuring                     | 297      |
| Determining                     | 299      |
| Markers                         | 297      |
| Markers (remote control)        | 754      |
| Measurement (remote control)    | 754      |
| Programming example             | 755      |
| Results                         | 296      |
| Results (remote control)        | 754      |
| Search signals                  | 298      |
| Search signals (remote control) | 754      |
| Amplifier Measurement           |          |
| Application                     | 113      |
| Amplitude                       |          |
| Configuration                   | 354      |
| Distribution, white noise       | 274      |
| Optimizing display              | 359      |
| Probability, white noise        | 274      |
| Scaling                         | 359      |
| Settings                        | 354      |
| Analog Demodulation             |          |
| Application                     | 113      |
| Analysis bandwidth              | 267      |
| Statistics                      | 267, 276 |
| Analysis BW                     |          |
| Softkey (APD, CCDF)             | 267      |
| AnBW (channel setting)          | 92       |
| Annotations                     |          |
| Hiding/restoring                | 538      |
| AP (trace information)          | 94       |
| APD                             | 261      |
| About                           | 261      |
| Activating (remote control)     | 728      |
| Application                     | 262      |
| Configuring                     | 266      |
| Gate (remote control)           | 730      |
| Gate ranges                     | 268      |
| Gated trigger                   | 265, 268 |
| Measurement (remote control)    | 728      |
| Measurement example             | 274      |
| Performing                      | 266, 272 |
| Results                         | 262      |
| Results (remote control)        | 729      |
| Scaling (remote control)        | 732      |
| see also Statistics             | 261      |
| Using gate ranges               | 272      |
| Application cards               | 18       |
| Application notes               | 18       |
| Applications                    |          |
| 1xEV-DO BTS                     | 112      |
| 1xEV-DO MS                      | 112      |
| 3G FDD BTS                      | 113      |
| 3G FDD UE                       | 113      |
| Amplifier Measurement           | 113      |
| Analog Demodulation             | 113      |
| Available                       | 111      |
| cdma2000 BTS                    | 113      |
| cdma2000 MS                     | 114      |
| GSM                             | 114      |
| I/Q Analyzer                    | 114      |

- LTE ..... 114
  - NB-IoT ..... 114
  - Noise Figure ..... 114
  - Phase Noise ..... 115
  - Pulse ..... 115
  - Setting ..... 117
  - Signal and Spectrum Analyzer mode ..... 110
  - Spectrum ..... 112
  - TD-SCDMA BTS ..... 115
  - TD-SCDMA UE ..... 115
  - Transient Analysis ..... 115
  - Vector Signal Analysis (VSA) ..... 116
  - WLAN ..... 116
  - APR (channel bar) ..... 93
  - APX
    - External generator ..... 318, 322
  - Arranging
    - Windows ..... 105, 399
  - Arrow keys ..... 88
  - ASCII trace export ..... 495
  - Att (channel setting) ..... 92
  - Attenuation ..... 356
    - Auto ..... 356
    - Electronic ..... 356
    - Impact ..... 353
    - Manual ..... 356
    - Option ..... 356
  - Audio signals
    - Output (remote) ..... 339, 835
  - Auto adjustment
    - Triggered measurement ..... 783, 811
  - Auto all ..... 390
  - Auto frequency ..... 390
  - Auto level
    - Hysteresis ..... 391, 392
    - Reference level ..... 356, 391
    - Softkey ..... 356, 391
  - Auto Peak detector ..... 459
  - Auto scaling ..... 359
  - Auto settings
    - Meastime Auto ..... 391
    - Meastime Manual ..... 391
  - Automatic coupling
    - Frequencies, external generator ..... 321, 327
  - Automatic login mechanism
    - Activating/Deactivating ..... 68
  - AV (trace information) ..... 94
  - Average count ..... 365, 370, 468
    - Power sensor ..... 311
  - Average detector ..... 459
  - Average mode
    - Traces ..... 468
  - Averaging
    - Continuous sweep ..... 463
    - Single sweep ..... 463
    - Sweep count ..... 463
    - Traces ..... 464
    - Traces (algorithm) ..... 463
    - Traces (remote control) ..... 842
- B**
- Band power markers
    - Programming example ..... 915
  - Band power measurement
    - Activating/Deactivating ..... 433
    - Deactivating ..... 434
    - Power mode ..... 433
    - Span ..... 433
  - Band power measurement (remote control) ..... 901
  - Bandwidth
    - Configuration (Softkey) ..... 366
    - Coupling ..... 362, 363
    - CP/ACLR ..... 166
    - Default settings ..... 360
    - MSR sub blocks ..... 176
    - MSR, adjacent channels ..... 179
    - MSR, gap channels ..... 182
    - MSR, Tx channel ..... 177
    - Resolution ..... 361, 368
    - Video ..... 362, 368
  - Block data ..... 581
  - Boolean parameters ..... 580
  - Brackets ..... 581
  - Brochures ..... 18
  - Burst signals
    - Measurement example ..... 139
- C**
- C/N, C/N0
    - see Carrier-to-Noise ..... 194
  - Calibration
    - External generator ..... 317
    - External generator, remote ..... 819
    - Frequency ..... 569
    - Frequency MW ..... 570
    - Frequency RF ..... 569
    - How to, external generator ..... 331
    - Normalization, external generator ..... 329
    - Performing with external generator ..... 330
    - Reference trace, external generator ..... 318
    - Reflection open measurement, external generator ... 329
    - Reflection short measurement, external generator ... 329
    - Remote ..... 619
    - Remote control ..... 971
    - Removing component effects, external generator ... 332
    - Restoring settings, external generator ..... 319, 329
    - Results (remote control) ..... 971
    - RF ..... 569
    - Settings ..... 569
    - Signal ..... 569
    - Storing results, external generator ..... 318
    - Transmission measurement, external generator ..... 328
  - Calibration Frequency MW ..... 972
  - Capture time
    - see also Measurement time ..... 790
  - Carrier Noise Config
    - Softkey ..... 196
  - Carrier-to-Noise ..... 194
    - Activating ..... 197
    - Channel bandwidth ..... 197
    - Channel bandwidth (remote control) ..... 677
    - Configuring ..... 196
    - Determining ..... 197
    - Measurement ..... 194
    - Measurement (remote control) ..... 677
    - Measurement process ..... 195
    - Results ..... 195
    - Results (remote control) ..... 677
    - Span ..... 195
  - Case-sensitivity
    - SCPI ..... 577

- CCDF ..... 261
  - About ..... 261
  - Activating (remote control) ..... 728
  - Application ..... 262
  - Configuring ..... 266
  - Crest factor ..... 264
  - Gate (remote control) ..... 730
  - Gate ranges ..... 268
  - Gated trigger ..... 265, 268
  - Measurement (remote control) ..... 728
  - Measurement example ..... 274
  - Percent marker ..... 264, 267
  - Percent marker (remote control) ..... 729
  - Performing ..... 266, 272
  - Results ..... 263
  - Results (remote control) ..... 729
  - Scaling (remote control) ..... 732
  - see also Statistics ..... 261
  - Using gate ranges ..... 272
- cdma2000 BTS
  - Application ..... 113
- cdma2000 MS
  - Application ..... 114
- Center = Mkr Freq ..... 420
- Center frequency ..... 347
  - Automatic configuration ..... 390
  - MSR sub blocks ..... 176
  - MSR Tx channel ..... 176
  - Setting to marker ..... 420
  - Softkey ..... 347
  - Step size ..... 344, 348, 351
  - Sub blocks (Multi-SEM) ..... 226
- Centroid frequency
  - OBW measurement ..... 200
- Channel
  - Creating (remote) ..... 624, 625, 626, 627
  - Deleting (remote) ..... 625
  - Duplicating (remote) ..... 624
  - Querying (remote) ..... 625
  - Renaming (remote) ..... 627
  - Replacing (remote) ..... 625
  - Selecting (remote) ..... 626, 627
- Channel bandwidth
  - C/N ..... 197
  - CP/ACLR ..... 166
  - MSR Tx channel ..... 177
  - MSR, adjacent channels ..... 179
  - MSR, gap channels ..... 182
- "Channel Bandwidth"
  - OBW ..... 202
  - Softkey ..... 202
- Channel bar
  - Hiding/restoring ..... 538
  - Information ..... 91
  - Information, external generator ..... 322
- Channel power
  - Comparing (CP/ACLR) ..... 188
  - Density (CP/ACLR) ..... 164, 173
  - SEM results ..... 206
  - Settings (SEM) ..... 227
- channel settings
  - Presetting ..... 500
- Channel settings
  - Display ..... 91, 92
- Channel-defined Sequencer
  - Softkey ..... 121
- Channels
  - Activating ..... 100
  - CP/ACLR ..... 165, 175, 185
  - CP/ACLR measurements ..... 162
  - Duplicating ..... 118
  - Names (CP/ACLR) ..... 168
  - New ..... 118
  - Operating modes ..... 110
  - Replacing ..... 118
  - Sequential operation ..... 119
  - Spacings (CP/ACLR) ..... 167
  - Spacings, configuring ..... 185
  - Switching ..... 91
  - Weighting filters ..... 168
- Cleaning ..... 1052
- Clear status
  - Remote ..... 619
- Closing
  - Channels (remote) ..... 625
  - Windows ..... 104, 399
  - Windows (remote) ..... 769, 772
- CLRW (trace information) ..... 94
- CMT
  - Display ..... 283
- CNT (marker functions) ..... 95
- Colon ..... 581
- Color curve
  - Shape ..... 475, 481
  - Spectrograms ..... 475, 485
- Color mapping
  - Color curve ..... 481
  - Color range ..... 481, 482
  - Color scheme ..... 481
  - Softkey ..... 480
  - Spectrograms ..... 474, 480, 484
  - Step by step ..... 484
  - Value range ..... 475
- Color scheme
  - Spectrogram ..... 474, 481
- Colors
  - Assigning to object ..... 543
  - Configuring ..... 542, 545
  - Display ..... 540
  - Editing ..... 540
  - Editing (remote) ..... 981
  - Predefined ..... 543
  - Print ..... 542
  - Printing ..... 540
  - Restoring ..... 544
  - Screen ..... 541
  - User-defined ..... 542
  - User-specific ..... 543
- Comma ..... 581
- Command sequence
  - Recommendation ..... 603
  - Remote ..... 623
- Commands ..... 575
  - Brackets ..... 581
  - Colon ..... 206
  - Comma ..... 581
  - Command line structure ..... 582
  - Common ..... 575
  - Double dagger ..... 581
  - GBIP, addressed ..... 59
  - GBIP, universal ..... 59
  - Instrument control ..... 575
  - Overlapping ..... 584



- Question mark ..... 581
- Quotation mark ..... 581
- SCPI confirmed ..... 575
- Sequential ..... 584
- Syntax elements ..... 581
- Tracking ..... 609
- Vertical stroke ..... 581
- White space ..... 581
- Comment
  - Gate ranges (statistics) ..... 269
  - Limit lines ..... 451
  - Screenshots ..... 518
  - Softkey ..... 518
  - Transducer lines ..... 552
- Common commands
  - Syntax ..... 576
- Compatibility
  - FSQ, FSP, FSU, FSV ..... 610
  - GPIO ..... 610
  - Limit lines ..... 443, 449
  - Mode ..... 610
  - Transducer lines ..... 550
- Compatible mode (channel setting) ..... 92
- Compensation
  - After calibration, external generator ..... 333
- Computer name ..... 43, 47, 606
- CONDition ..... 588
- Connector
  - AC power supply ..... 40
  - Display Port ..... 40
  - DVI ..... 40
  - IF/VIDEO/DEMODO ..... 39
  - LAN ..... 40
  - Noise source control ..... 39
  - OCXO ..... 41
  - REF INPUT ..... 39
  - RF Input 50Ω ..... 37, 38
  - TRIGGER INPUT / OUTPUT ..... 39
  - USB ..... 36, 40
- Connectors
  - EXT REF ..... 558
  - IF/VIDEO/DEMODO ..... 339
  - SYNC TRIGGER ..... 558
- Continue single sweep
  - Softkey ..... 125, 372
- Continuous Sequencer
  - Softkey ..... 121
- Continuous sweep
  - Softkey ..... 125, 371, 480
- Conventions
  - SCPI commands ..... 617
- Copying
  - Channel (remote) ..... 624
  - Traces ..... 469, 471
- Coupling
  - Automatic, external generator ..... 321, 327
  - Frequencies, external generator ..... 320
  - GPIO ..... 611
  - GPIO (remote control) ..... 1002
  - Input (remote) ..... 812
  - Manual, external generator ..... 327
  - Span/RBW ..... 363
  - VBW/RBW ..... 362
- Coupling ratio
  - Span/RBW (remote) ..... 786
- Coupling ratios
  - Default ..... 370
  - RBW/VBW ..... 369
  - Span/RBW ..... 369
- CP/ACLR ..... 145
  - About ..... 146
  - Absolute/relative values ..... 164, 173
  - "Adjust Settings" ..... 165, 174
  - Channel bandwidths ..... 166
  - Channel bandwidths (remote control) ..... 643
  - Channel names ..... 168
  - Channel names (remote control) ..... 643
  - Channel power density ..... 164, 173
  - Channel setup ..... 165, 175
  - Channel setup (remote control) ..... 643
  - Channel spacing ..... 185
  - Channel spacing (remote control) ..... 643
  - Channel spacings ..... 167
  - Clear/Write ..... 164, 174
  - Comparing channel powers ..... 188
  - Configuring ..... 159
  - Configuring MSR signals ..... 169
  - Detector ..... 154
  - Fast ACLR ..... 149, 163
  - Fixed reference for CP ..... 164
  - Frequency span ..... 153
  - General Settings ..... 160
  - General Settings for MSR ..... 169
  - IBW method ..... 149
  - Limit check ..... 167
  - Limit check (remote control) ..... 650
  - Max Hold ..... 164, 174
  - Measurement (remote control) ..... 641
  - Measurement examples ..... 188
  - Measurement methods ..... 148
  - Mode ..... 164, 173
  - Multicarrier ..... 148
  - Noise cancellation ..... 163, 172, 357
  - Number of channels ..... 162
  - Number of channels (remote control) ..... 643
  - Optimizing ..... 192
  - Performing ..... 159
  - Performing measurement ..... 184, 186
  - Power mode ..... 164, 174
  - "Power Unit" ..... 164, 173
  - Predefined Settings ..... 161, 170
  - Predefined standards ..... 192, 193
  - RBW ..... 153
  - Reference channel ..... 163, 172
  - Reference channel (remote control) ..... 649
  - Reference level ..... 155
  - Repeatability ..... 150
  - Results ..... 146, 671
  - Setting up channels ..... 185
  - Setting up channels (remote control) ..... 643
  - Standards ..... 161, 170
  - Standards (remote control) ..... 641
  - Standards (Softkey) ..... 161, 170
  - "Sweep Time" ..... 152, 165
  - Trace averaging ..... 155
  - Trace Selection ..... 164, 173
  - Troubleshooting ..... 192
  - User-defined standards ..... 161, 171, 187
  - VBW ..... 154
  - Weighting filters ..... 168
  - Weighting filters (remote control) ..... 647

- Crest factor
  - APD ..... 263
  - CCDF ..... 264
- Cumulated Measurement Time (CMT)
  - Harmonics ..... 283
- D**
- Data format
  - ASCII ..... 857
  - Binary ..... 857
  - Remote ..... 853, 858, 963
- Data sheets ..... 18
- Date
  - Format ..... 536
  - Hiding/restoring ..... 538
  - Instrument setting ..... 536
- Date and Time
  - Printing ..... 519
- DC (channel bar) ..... 93
- DCL ..... 59
- Debugging
  - Remote control programs ..... 1057
- Decimal separator
  - Trace export ..... 493
- DEF ..... 579
- Default
  - Restoring settings ..... 499
- Default coupling ..... 370
- Default values
  - Remote ..... 621
- Deleting
  - Limit line values ..... 453
  - Settings files ..... 233
  - Standards ..... 233
  - Transducer factors ..... 552
- Delta markers ..... 410
  - Defining ..... 409, 425
  - Fixed reference marker ..... 438
  - Remote control ..... 862
- Denominator
  - Frequencies, external generator ..... 321, 327
- Detectors
  - CP/ACLR ..... 154
  - Overview ..... 459
  - Remote control ..... 842
  - Spurious Emissions range ..... 254
  - Trace ..... 467
- Device
  - Softkey ..... 518, 522, 524
- Device-specific commands ..... 575
- DHCP ..... 43, 62, 607
- Diagnostics
  - Hardware ..... 572
- Diagram area
  - Channel settings ..... 92
  - Status display ..... 96
  - Trace information ..... 94
- Diagram footer ..... 95
  - Hiding/restoring ..... 538
- Diagrams
  - Evaluation method ..... 394
- Dialogs
  - Printing ..... 519
  - Suppressing file selection ..... 523
- Direct path
  - Remote ..... 812
- Display
  - Changing - see User Manual ..... 106
  - Colors ..... 540, 545
  - Config (Softkey) ..... 393
  - Deactivating - see User Manual ..... 106
  - Evaluation bar ..... 104, 398
  - Evaluation methods ..... 393
  - Information ..... 90
  - Settings ..... 535
  - Settings (remote control) ..... 978
  - SmartGrid ..... 101, 395
  - Theme ..... 540
  - Theme (remote) ..... 981
  - Update (remote) ..... 609
  - Update rate ..... 536
- Display colors ..... 49
  - Changing - see User Manual ..... 106
- Display lines ..... 441
  - Defining ..... 442
  - Remote control ..... 917
  - Settings ..... 441
- Display Port
  - Connector ..... 40
- Display theme
  - Selecting - see User Manual ..... 106
- Double dagger ..... 581
- DOWN ..... 579
- Drop-out time
  - Trigger ..... 377, 383
  - Trigger (Power sensor) ..... 312
- Duplicating
  - Channel (remote) ..... 624
- Duty cycle
  - Power sensor ..... 311
- DVI
  - Connector ..... 40
- Dynamic range
  - Intermodulation-free ..... 290
  - Measuring ..... 281
- E**
- Edge gate
  - Slope ..... 384
- Electronic input attenuation ..... 356
- Electrostatic discharge ..... 21
- ENABle ..... 588
- Enable registers
  - Remote ..... 621
- Entering data ..... 98
- EOI
  - GPIB terminator ..... 609
- Error log ..... 1058
- Error messages
  - Status bar ..... 97, 1054
- Error queue ..... 590
- Errors
  - External generator ..... 322
  - IF OVLD ..... 97, 355, 598, 1055
  - INPUT OVLD ..... 598, 1055
  - LOUNL ..... 97, 1055
  - Messages, device-specific ..... 1056
  - NO REF ..... 97, 1055
  - OVEN ..... 97, 1055
  - Queues, recommendations ..... 603
  - Remote control programming ..... 603
  - RF OVLD ..... 97, 598, 1055

- UNCAL ..... 97, 1055
- UNLD ..... 598
- WRONG\_FW ..... 97, 532, 563, 1055
- ESD ..... 21
- ESE (event status enable register) ..... 591
- ESR (event status register) ..... 591
- Evaluation
  - Lists (SEM) ..... 234
  - Lists (Spurious) ..... 256
  - Modes ..... 393
  - Modes, adding ..... 104, 398
- Evaluation bar
  - Using ..... 104, 398
- Evaluation list
  - Details (Spurious Emissions) ..... 257
  - Peaks (Spurious Emissions) ..... 258
  - Spurious Emissions ..... 249
- Evaluation methods
  - Remote ..... 767
- EVENT ..... 588
- Event status enable register (ESE) ..... 591
  - Remote ..... 619
- Event status register (ESR) ..... 587, 591
  - Remote ..... 619
- Example
  - Calibration with an external generator ..... 333
  - Remote control of an external generator ..... 822
- Exclude LO ..... 414, 418
  - Remote ..... 870
- Export format
  - SEM results ..... 247
  - Spurious Emissions results ..... 259
  - Traces ..... 495
- Exporting
  - Data ..... 515
  - Functions ..... 507
  - I/Q data ..... 515
  - Measurement settings ..... 491
  - Peak list ..... 437, 495
  - SEM result files ..... 239
  - Softkey ..... 514
  - Spurious Emissions result files ..... 259
  - Trace data ..... 494
  - Traces ..... 490, 492, 514, 515
- EXREF (status display) ..... 98, 1055
- EXT REF
  - Status message ..... 96
- Ext.Gen (channel bar) ..... 93
- External generator ..... 314
  - Activating/Deactivating ..... 326
  - Basics ..... 314, 315
  - Calibration functions ..... 328
  - Calibration measurement settings ..... 325
  - Channel bar information ..... 322
  - Connections ..... 315
  - Coupling frequencies ..... 320
  - Errors ..... 322
  - Generators, supported ..... 316
  - Interface ..... 324
  - Interface settings ..... 324
  - Normalizing ..... 329
  - Overloading ..... 323
  - Recalling calibration settings ..... 329
  - Reference level ..... 319
  - Reference line ..... 319
  - Reference line position ..... 330
  - Reference line value ..... 330
- Reference position ..... 330
- Reference trace ..... 319
- Reference value ..... 330
- Reflection measurement ..... 315
- Reflection open measurement ..... 329
- Reflection short measurement ..... 329
- Remote control ..... 814
- Settings ..... 323
- Transducer factor ..... 319, 329
- Transmission measurement ..... 315, 328
- External monitor
  - Connectors ..... 40
- External reference
  - External generator ..... 316
  - External generator control ..... 325
  - Frequency ..... 559
  - Input ..... 558
  - Missing ..... 559
  - Settings ..... 558
  - Settings (remote control) ..... 969
  - Status message ..... 96
- External trigger ..... 381
  - Configuring power sensor ..... 314
  - Level (power sensor) ..... 311
  - Level (remote) ..... 801
  - Power sensor ..... 311
- F**
- Falling
  - Slope (Power sensor) ..... 312
- Fast ACLR
  - Activating/Deactivating ..... 163
  - Measurement method ..... 149
- Fast SEM ..... 213
  - Consequences ..... 214
  - Example ..... 215
  - Multi-SEM ..... 214, 216
  - Prerequisites ..... 213
  - SEM ..... 221
- FFT filters
  - Mode ..... 370
- FFT sweep ..... 363, 371
- File format
  - Export Files ..... 495
  - SEM export files ..... 247
  - SEM settings files ..... 241
  - Spurious Emissions export files ..... 259
  - Trace export ..... 495
- File type
  - Storage settings ..... 509
- filename
  - Data files ..... 507
  - Settings ..... 233, 509, 511
- Filter types ..... 364, 369
  - SEM range ..... 221
  - Spurious Emissions range ..... 253
- Filters
  - 5-pole ..... 365
  - Channel ..... 364
  - Configuration ..... 366
  - FFT ..... 370
  - Gaussian (3dB) ..... 364
  - Overview ..... 373
  - RBW ..... 361
  - RRC ..... 365
  - VBW ..... 362

- Weighting (remote) ..... 648
  - YIG (remote) ..... 813
  - Firmware
    - Updating ..... 563
  - Firmware Update
    - Remote control ..... 993
  - Firmware updates
    - see User Manual ..... 20
  - Fixed reference
    - Configuring ..... 438
    - Defining ..... 412, 430
    - Delta markers ..... 438
    - Remote control ..... 892
  - Focus
    - Changing ..... 98
  - Focus area
    - Switching between windows ..... 85
  - Format
    - Data ..... 857
    - Data (remote) ..... 853, 858, 963
    - Date and time ..... 536
    - see also File format ..... 495
  - Frame count
    - Softkey ..... 373
    - Spectrograms ..... 473
  - Frames
    - Spectrogram marker ..... 409
  - Free Run
    - Trigger ..... 381
  - Frequencies
    - Multi-SEM ..... 216
  - Frequency
    - Configuration (Softkey) ..... 345
    - Coupling (power sensor) ..... 309
    - External generator ..... 327
    - External reference ..... 559
    - IF Out ..... 339
    - Offset ..... 349
    - Power sensor ..... 309
    - Range ..... 343
    - Range, defining ..... 350
    - Reference ..... 558
    - Reference (remote control) ..... 969
    - Span ..... 347
    - Start ..... 347
    - Step size ..... 344
    - Stop ..... 347
    - Sweep ..... 371
  - Frequency axis
    - Scaling ..... 344, 347
  - Frequency coupling
    - Automatic, external generator ..... 321
    - External generator ..... 320, 327
    - Reverse sweep, external generator ..... 322
  - Frequency denominator
    - External generator ..... 327
  - Frequency lines
    - Remote control ..... 917
  - Frequency numerator
    - External generator ..... 327
  - Frequency offset
    - External generator ..... 321, 327
  - Frequency range
    - Calibration sweep, external generator ..... 321, 328
  - Frequency span
    - CP/ACLR ..... 153
  - Frequency sweep
    - Measurement ..... 124
    - Programming example ..... 1042
  - Frequency-converting measurements
    - External generator ..... 321
  - Front panel
    - Hiding/restoring ..... 538
  - Front Panel
    - Displaying - see User Manual ..... 106
  - Front Panels
    - Using ..... 83
  - FRQ
    - External generator ..... 322
  - Frq (channel bar) ..... 93
  - Full span
    - Softkey ..... 348
  - Function keys
    - Details - see User Manual ..... 85
    - Overview ..... 85
  - FXD (marker functions) ..... 95
- ## G
- Gap
    - MSR, spacing ..... 182
  - Gap channels
    - MSR ACLR ..... 180
    - MSR, bandwidth ..... 182
    - MSR, configuring ..... 181
    - MSR, weighting filters ..... 182
  - GAT (channel bar) ..... 93
  - Gate
    - Delay ..... 388
    - Length ..... 389
    - Measurements ..... 385
    - Mode ..... 388
    - Ranges (statistics) ..... 265
    - Settings ..... 388
  - Gate ranges
    - Activating (statistics) ..... 269
    - Comment (statistics) ..... 269
    - Period (statistics) ..... 269
    - Start/Stop (statistics) ..... 269
    - Statistics ..... 268
  - Gated trigger
    - Activating ..... 388
    - Configuring (statistics) ..... 268, 272
    - Delay ..... 388
    - Example ..... 273
    - Length ..... 389
    - Mode ..... 388
    - Softkey ..... 268
    - Statistics ..... 265, 268, 276
  - Gating
    - Source ..... 381
  - Generator
    - Frequencies, external generator ..... 321, 327
    - Frequency coupling, external generator ..... 327
    - Frequency offset, external generator ..... 326
    - Output power, external generator ..... 326
  - Generator type
    - External generator ..... 324
  - Generators
    - Frequency range, external generator ..... 325
    - Power range, external generator ..... 325
    - Setup files, external generator ..... 317, 324, 325
    - Supported, external generator ..... 316

- GET ..... 59
- Getting started ..... 17
- GPIB ..... 51
  - Address ..... 46, 66, 608
  - Characteristics ..... 56
  - Coupling ..... 611
  - IF Gain (remote control) ..... 1002
  - interface messages ..... 57
  - Language ..... 610
  - Language (remote control) ..... 1002
  - Settings ..... 607
  - Terminator ..... 609
- GPIB bus control
  - Remote ..... 621
- GPIB Language ..... 603
- Graphical user interface
  - Overview ..... 81
- Group delay
  - Smoothing ..... 468
- GSM
  - Application ..... 114
- GTL ..... 59
- H**
- Hardware
  - Check ..... 563
  - Diagnostics ..... 572
  - Information ..... 560
  - Supported ..... 563
- Harmonic Distortion ..... 280
  - About ..... 281
  - Activating (remote control) ..... 748
  - Basics ..... 281
  - Configuring ..... 284
  - Measurement (remote control) ..... 748
  - Measuring ..... 286
  - RBW ..... 285
  - Results ..... 283
  - Results (remote control) ..... 748
  - Sweep time ..... 285
- Harmonics
  - Basics ..... 281
  - High-sensitivity ..... 283
  - Measurement example ..... 439
  - Measurement rules ..... 282
  - Measurement time ..... 283
  - Number ..... 285
  - Origin ..... 283
  - Power ..... 284
  - Second harmonic intercept ..... 281
- Help ..... 107
  - Search for topic ..... 108
  - Using ..... 108
- Hiding
  - Screen elements - see User Manual ..... 106
- Hiding/restoring
  - Display items ..... 536
- HiSLIP ..... 52
  - Protocol ..... 53
  - Resource string ..... 52
- History
  - Spectrograms ..... 479
- History Depth
  - Softkey ..... 479
- Hold
  - Trace setting ..... 467
- Horizontal Line 1/2
  - Softkeys ..... 442
- HP emulation ..... 1004
- Hysteresis
  - Lower (Auto level) ..... 392
  - Trigger ..... 383
  - Trigger (Power sensor) ..... 311
  - Upper (Auto level) ..... 391
- I**
- I/O Logging ..... 609
- I/Q Analyzer
  - Application ..... 114
- I/Q data
  - Exporting ..... 515
- I/Q Power
  - Trigger level (remote) ..... 802
- IBW method
  - CP/ACLR measurements ..... 149
- ID String User ..... 603
- Identification
  - Remote ..... 620
  - String, R&S FPS ..... 608
  - String, resetting (R&S FPS) ..... 608
- IEC/IEEE bus
  - see GPIB ..... 51
- IECWIN
  - Accessing ..... 30
- IF frequency
  - Output ..... 303, 339
  - Output (remote) ..... 835
- IF Gain
  - GPIB ..... 611
  - GPIB (remote control) ..... 1002
- IF Out Frequency ..... 339
- IF output ..... 339
  - Remote ..... 835
- IF OVLD
  - Error ..... 97, 1055
  - External generator ..... 318, 322
- IF OVLD (status display) ..... 97, 1055
- IF Power
  - Trigger ..... 382
  - Trigger level (remote) ..... 802
- IF/VIDEO/DEMOD
  - Connector ..... 39, 303
  - Output ..... 339
- IFC ..... 59
- Impedance
  - Remote ..... 813
  - Setting ..... 304
- Importing
  - Functions ..... 507
  - Softkey ..... 514
- INF ..... 579
- Information
  - Hardware ..... 560
  - Options ..... 560
  - Version ..... 560
- Inherent noise
  - Cancelation ..... 163, 172, 357
- Input
  - Coupling ..... 304
  - Coupling (remote) ..... 812
  - RF ..... 304
  - Settings ..... 303, 357

|                                      |                    |
|--------------------------------------|--------------------|
| Signal, parameters .....             | 302                |
| Source Configuration (softkey) ..... | 303                |
| Source, Radio frequency (RF) .....   | 303                |
| INPUT OVLD                           |                    |
| Error .....                          | 1055               |
| INPUT OVLD (status display) .....    | 97, 1055           |
| Inserting                            |                    |
| Limit line values .....              | 453                |
| Transducer factors .....             | 552                |
| Installing                           |                    |
| Options .....                        | 561                |
| Instrument messages .....            | 575                |
| Instrument security procedures ..... | 18                 |
| Instrument settings                  |                    |
| Secure user mode .....               | 503                |
| Instrument Settings                  |                    |
| see User Manual .....                | 49                 |
| Interface messages .....             | 575                |
| Interfaces                           |                    |
| GPIB .....                           | 56                 |
| LAN .....                            | 51                 |
| USB .....                            | 59                 |
| Intermodulation products .....       | 287                |
| Interrupt .....                      | 599                |
| Invalid results                      |                    |
| Remote control .....                 | 583                |
| IP address .....                     | 52                 |
| Assigning .....                      | 62                 |
| Network .....                        | 43, 607            |
| IP configuration                     |                    |
| LXI .....                            | 65                 |
| IST .....                            | 587                |
| IST flag .....                       | 591                |
| Remote .....                         | 620                |
| Items                                |                    |
| Saving .....                         | 506                |
| Settings .....                       | 509                |
| <b>K</b>                             |                    |
| Key                                  |                    |
| DOWN .....                           | 88                 |
| LEFT .....                           | 89                 |
| POWER .....                          | 36                 |
| REDO .....                           | 87                 |
| RIGHT .....                          | 89                 |
| UNDO .....                           | 87                 |
| UP .....                             | 88                 |
| Keyboard                             |                    |
| On-screen .....                      | 89                 |
| Keypad .....                         | 99                 |
| Key layout .....                     | 100                |
| Overview .....                       | 87                 |
| Keys                                 |                    |
| MKR .....                            | 408                |
| MKR -> .....                         | 413, 419           |
| MKR FUNCT .....                      | 420                |
| Peak Search .....                    | 419                |
| PRESET .....                         | 499                |
| RUN CONT .....                       | 125, 371, 480      |
| RUN SINGLE .....                     | 125, 371, 372, 480 |
| Keywords                             |                    |
| see Mnemonics .....                  | 576                |

**L**

|                                       |               |
|---------------------------------------|---------------|
| LAN                                   |               |
| Configuration - see user Manual ..... | 20            |
| Configuring .....                     | 63            |
| Connector .....                       | 40            |
| Interface .....                       | 51            |
| IP address .....                      | 52            |
| Remote control interface .....        | 51            |
| Reset .....                           | 44, 614       |
| VISA .....                            | 52            |
| VXI protocol .....                    | 53            |
| Last span                             |               |
| Softkey .....                         | 348           |
| Legacy format                         |               |
| *IDN .....                            | 609           |
| LFEOI                                 |               |
| GPIB terminator .....                 | 609           |
| Limit check                           |               |
| Activating/Deactivating .....         | 454           |
| CP/ACLR .....                         | 167           |
| MSR channels .....                    | 180, 182      |
| MSR, activating .....                 | 174           |
| Remote control .....                  | 919           |
| Results .....                         | 445           |
| SEM range .....                       | 223           |
| Spurious Emissions .....              | 252           |
| Spurious Emissions range .....        | 255           |
| Limit lines .....                     | 443, 447      |
| Activating/Deactivating .....         | 449           |
| Calculation (Multi-SEM) .....         | 216, 217, 224 |
| Comment .....                         | 451           |
| Compatibility .....                   | 443, 449      |
| Compatible .....                      | 454           |
| Copying .....                         | 450, 455      |
| Creating .....                        | 450, 455      |
| Data points .....                     | 452           |
| Deactivating .....                    | 450           |
| Defining .....                        | 454           |
| Deleting .....                        | 450, 455      |
| Deleting values .....                 | 453           |
| Details .....                         | 450           |
| Editing .....                         | 450, 455      |
| Inserting values .....                | 453           |
| Managing .....                        | 447           |
| Margin .....                          | 452           |
| Margins .....                         | 444           |
| Name .....                            | 451           |
| OBW .....                             | 202, 415, 418 |
| Offsets .....                         | 445           |
| Peak search .....                     | 202, 415, 418 |
| Recalling .....                       | 503           |
| Remote control .....                  | 919           |
| Saving .....                          | 453, 503, 506 |
| Selecting .....                       | 449           |
| SEM .....                             | 211, 454      |
| Shifting .....                        | 445, 453, 456 |
| Spurious .....                        | 454           |
| Spurious Emissions .....              | 251           |
| Storing .....                         | 447           |
| Threshold .....                       | 444, 451      |
| Time Domain Power measurement .....   | 277           |
| Traces .....                          | 449           |
| View filter .....                     | 449           |
| Violation .....                       | 445           |
| Visibility .....                      | 449           |
| X-axis .....                          | 452           |

- X-Offset ..... 449
- Y-axis ..... 452
- Y-Offset ..... 450
- Limits
  - Absolute (SEM range) ..... 223
  - Absolute (Spurious Emissions range) ..... 256
  - Relative (SEM range) ..... 223
- Linear scaling
  - X-axis ..... 344, 347
- Lines
  - Configuration ..... 447
  - Display ..... 441, 442
  - Horizontal ..... 442
  - Limit, see Limit lines ..... 447
  - Vertical ..... 442
- Linking
  - Markers ..... 410
- List evaluation ..... 756
  - Evaluations ..... 234, 256
  - Saving (SEM) ..... 235
  - Saving (Spurious Emissions) ..... 258
  - SEM ..... 234
  - Softkey ..... 234
  - Spurious Emissions ..... 256
  - State (SEM) ..... 234
  - State (Spurious Emissions) ..... 257
- LLO ..... 59
- Loading
  - Functions ..... 507
  - Instrument settings ..... 511
  - Settings ..... 502, 504
  - Settings files ..... 233
- Logarithmic scaling
  - Sweep points ..... 344
  - X-axis ..... 344, 347
- Login
  - Network ..... 66
  - Operating system ..... 26
  - Secure user mode ..... 27
- Logo
  - Printing ..... 518
- LOUNL
  - Error ..... 97, 1055
- LOUNL (status display) ..... 97, 1055
- Lower Level Hysteresis ..... 392
- LTE
  - Application ..... 114
- LVL
  - External generator ..... 322
- LVL (channel bar) ..... 93
- LXI
  - Browser interface ..... 63
  - Configuration ..... 613
  - LAN configuration ..... 65
  - Manufacturer Description ..... 614
  - Password ..... 613
  - Ping ..... 65
  - Remote control ..... 54
  - Reset (LCI) ..... 44, 614
  - Settings ..... 612
- M**
- Maintenance ..... 1052
- Margins
  - Limit lines ..... 444, 452
  - Peaks (SEM) ..... 235
- Peaks (Spurious Emissions) ..... 257
- Violation ..... 445
- Marker
  - Information ..... 94
  - Search area (softkey) ..... 418
  - Search type (softkey) ..... 417
- Marker functions
  - Deactivating ..... 437
  - Measurement example ..... 439
- Marker peak list
  - see Peak list ..... 437
- Marker Peak List
  - Programming example ..... 913
- Marker search
  - Spectrograms, programming example ..... 911
- Marker search area
  - Remote control ..... 869
- Marker table
  - Evaluation method ..... 394
  - Information ..... 95
- Marker to Trace ..... 410
- Markers ..... 406
  - AM Modulation Depth measurement ..... 297
  - Analyzing in detail ..... 438
  - Assigned trace ..... 410
  - Band power (remote control) ..... 901
  - Basic settings ..... 408
  - Configuration ..... 408, 411
  - Configuration (remote control) ..... 862
  - Deactivating ..... 411
  - Delta markers ..... 409, 425
  - Fixed reference (remote control) ..... 868, 892
  - Function configuration ..... 420
  - Linking ..... 410
  - Minimum ..... 420
  - Minimum (remote control) ..... 869, 873
  - n dB down ..... 430
  - n dB down (remote control) ..... 904
  - Next minimum ..... 420
  - Next minimum (remote control) ..... 869, 873
  - Next peak ..... 419
  - Next peak (remote control) ..... 869, 873
  - Noise measurement ..... 422
  - Noise measurement (remote control) ..... 897
  - Peak ..... 419
  - Peak (remote control) ..... 869, 873
  - Peak list (remote control) ..... 894
  - Phase noise measurement ..... 425
  - Phase noise measurement (remote control) ..... 898
  - Position ..... 409
  - Positioning ..... 419
  - Positioning (remote control) ..... 862
  - Programming example ..... 910
  - Querying position (remote) ..... 881
  - Remote control ..... 862
  - Search (remote control) ..... 869
  - Setting center frequency ..... 420
  - Setting reference level ..... 420
  - Signal count ..... 422
  - Signal count (remote control) ..... 908
  - Softkeys (AM Modulation Depth) ..... 297
  - Softkeys (TOI) ..... 293
  - Spectrograms ..... 477, 483
  - Spectrograms (remote control) ..... 882
  - State ..... 409, 424
  - Step size ..... 412
  - Step size (remote control) ..... 868

|                                             |          |                                          |               |
|---------------------------------------------|----------|------------------------------------------|---------------|
| Table .....                                 | 412      | MIN .....                                | 579           |
| Table (evaluation method) .....             | 394      | MINH (trace information) .....           | 94            |
| Table (remote control) .....                | 868      | Mini front panel                         |               |
| Tips .....                                  | 405      | Hiding/restoring .....                   | 539           |
| TOI measurement .....                       | 293      | Key combination .....                    | 540           |
| Type .....                                  | 409, 425 | Mini Front Panel                         |               |
| X-value .....                               | 409      | Displaying - see User Manual .....       | 106           |
| Mask monitoring                             |          | Using .....                              | 84            |
| SEM .....                                   | 206      | Minimum .....                            | 420           |
| MAX .....                                   | 579      | Marker positioning .....                 | 420           |
| MAXH (trace information) .....              | 94       | Next .....                               | 420           |
| Maximize                                    |          | MKR                                      |               |
| Window .....                                | 106      | Key .....                                | 408           |
| Maximizing                                  |          | MKR ->                                   |               |
| Display .....                               | 85       | Key .....                                | 413, 419      |
| Windows (remote) .....                      | 766      | MKR FUNCT                                |               |
| Meas Time (channel setting) .....           | 92       | Key .....                                | 420           |
| Measurement accuracy                        |          | Mnemonics .....                          | 576           |
| External generator .....                    | 318      | Optional .....                           | 578           |
| Measurement examples                        |          | MOD (marker functions) .....             | 95            |
| AF of AM-modulated signal .....             | 137      | Mode (channel setting) .....             | 92            |
| AM modulation .....                         | 136      | Modes                                    |               |
| CP/ACLR .....                               | 188, 189 | see Operating mode .....                 | 110           |
| Harmonics .....                             | 439      | Monitor                                  |               |
| Intermodulation .....                       | 293      | External .....                           | 544           |
| Level and frequency .....                   | 127      | Settings .....                           | 544           |
| Marker functions .....                      | 439      | MSR ACLR                                 |               |
| OBW .....                                   | 204      | Adjacent channel bandwidths .....        | 179           |
| Power of burst signals .....                | 139      | Adjacent channel definition .....        | 178           |
| Separating signals .....                    | 132      | Adjacent channel setup .....             | 177           |
| Signal frequency using signal counter ..... | 128      | Adjacent channel spacing .....           | 179           |
| Signal-to-noise ratio .....                 | 143      | Adjacent channel weighting filters ..... | 179           |
| Statistics .....                            | 274      | Adjacent channels .....                  | 158           |
| Time Domain Power .....                     | 279      | CACLR .....                              | 157           |
| TOI .....                                   | 293      | Channel definition .....                 | 156           |
| Measurement results                         |          | Channel display .....                    | 158           |
| SEM .....                                   | 234      | Configuration .....                      | 169           |
| Spurious Emissions .....                    | 256      | Gap channel bandwidths .....             | 182           |
| Measurement time                            |          | Gap channel definition .....             | 181           |
| Auto settings .....                         | 391      | Gap channel setup .....                  | 180           |
| Power sensor .....                          | 310      | Gap channel spacing .....                | 182           |
| Remote .....                                | 790      | Gap channel weighting filters .....      | 182           |
| Measurements                                |          | Gap channels .....                       | 157           |
| All Functions off .....                     | 125      | Limit check .....                        | 180, 182      |
| APD .....                                   | 261      | Limit checks, activating .....           | 174           |
| Carrier-to-Noise .....                      | 194      | Measurement .....                        | 155           |
| CCDF .....                                  | 261      | Number of adj. channels .....            | 178           |
| Correlating .....                           | 110      | Programming example .....                | 675           |
| CP/ACLR .....                               | 145      | Results .....                            | 159           |
| Evaluation methods .....                    | 393      | Results (remote) .....                   | 637           |
| Frequency sweep .....                       | 124      | Signal structure .....                   | 155           |
| Harmonic Distortion .....                   | 280      | Sub block definition .....               | 156           |
| OBW .....                                   | 198      | Tx channel bandwidth .....               | 177           |
| SEM .....                                   | 205      | Weighting filters .....                  | 177           |
| Spurious Emissions .....                    | 248      | MSR SEM                                  |               |
| Statistics .....                            | 261      | Basics .....                             | 215           |
| Time Domain Power .....                     | 276      | Configuration .....                      | 229           |
| TOI .....                                   | 286      | Configuration (softkey) .....            | 229           |
| Zero span .....                             | 125      | Settings (Multi-SEM) .....               | 226           |
| Measurementsition time                      |          | Multi-SEM                                |               |
| Statistics .....                            | 267      | Basics .....                             | 215           |
| Messages                                    |          | Center frequencies .....                 | 226           |
| Commands .....                              | 575      | Fast SEM .....                           | 214, 216      |
| Instrument .....                            | 575      | Frequency definition .....               | 216           |
| Instrument responses .....                  | 576      | Limit line calculation .....             | 216, 217, 224 |
| Interface .....                             | 575      | MSR settings .....                       | 226           |
| MI (trace information) .....                | 94       | Number of sub blocks .....               | 225           |



- Results ..... 208
- Settings ..... 225
- Standard files ..... 232
- Standard settings files ..... 226
- Multi-standard radio
  - see MSR ..... 215
- Multicarrier ACLR measurement ..... 148
- Multiple signals
  - Measurement example ..... 132
- Multiple zoom ..... 400, 402
- MultiView
  - Tab ..... 116, 119
- N**
- n dB down
  - Delta value ..... 430
  - Marker ..... 430
  - Remote control ..... 904
- n dB down markers
  - Programming example ..... 916
- Name
  - CP/ACLR channels ..... 168
  - Limit lines ..... 451
  - Transducer lines ..... 551
- NAN ..... 579
- NAN (not a number)
  - Remote control ..... 583
- Navigation keys ..... 37
- NB-IoT
  - Application ..... 114
- NCor (enhancement label) ..... 94
- Negative Peak detector ..... 459
- Network
  - Automatic login ..... 68
  - Changing user passwords ..... 67
  - Configuration (dialog box) ..... 607
  - Configuring ..... 61, 574
  - Connecting the instrument ..... 61
  - Creating users ..... 66
  - Login ..... 66
  - Setting up ..... 50
  - Settings ..... 605
  - Settings (remote) ..... 985
  - Sharing directories ..... 69
- Next Minimum ..... 420
  - Marker positioning ..... 420
- Next Mode X
  - Softkey ..... 416
- Next Mode Y
  - Softkey ..... 417
- Next Peak ..... 419
  - Marker positioning ..... 419
- NINF ..... 579
- NO REF
  - Error ..... 97, 1055
- NOI (marker functions) ..... 95
- Noise
  - Cancelation (CP/ACLR) ..... 163, 172, 357
  - Cancelation (softkey) ..... 163, 172, 357
  - Cancellation (remote control) ..... 794
  - Correction, see Cancelation ..... 163, 172, 357
  - Floor (RF attenuation) ..... 353
  - Saving settings ..... 506
  - Source ..... 340
- Noise Figure
  - Application ..... 114
- Noise markers
  - Programming example ..... 914
- Noise measurement
  - Activating/Deactivating ..... 425
  - Deactivating ..... 425
  - Marker ..... 422
  - Remote control ..... 897
- Noise source control
  - Connector ..... 39
- NOR
  - External generator ..... 318, 322
- NOR (channel bar) ..... 93
- Normalization
  - Approximate, external generator ..... 318
  - External generator ..... 318, 329
- NormalUser ..... 45
- NTRansition ..... 588
- Number of Readings
  - Power sensor ..... 311
- Numerator
  - Frequencies, external generator ..... 321, 327
- Numeric parameters ..... 98, 579
- Numeric values
  - Special ..... 579
- O**
- OBW ..... 198
  - % Power (remote control) ..... 678
  - "% Power Bandwidth" ..... 202
  - "Adjust Settings" ..... 202
  - "Channel Bandwidth" ..... 202
  - Channel bandwidth (remote control) ..... 678
  - Configuring ..... 201
  - Deactivating limits ..... 203, 416, 419
  - Determining ..... 201, 203
  - Limits ..... 202, 415, 418
  - Measurement ..... 198
  - Measurement (remote control) ..... 678
  - Measurement example ..... 204
  - Multicarrier signal ..... 199, 201, 203
  - Prerequisites ..... 199
  - Results ..... 200
  - Search limits ..... 199, 201, 203
- OBW measurement
  - Centroid frequency ..... 200
- Occupied Bandwidth
  - see OBW ..... 198
- OCCO
  - Connector ..... 41
- Offset
  - Frequency ..... 349
  - Limit lines ..... 445
  - Reference level ..... 355
  - X-axis (statistics) ..... 271
- Offset (channel setting) ..... 92
- On-screen keyboard ..... 89, 99
- Online help
  - Working with ..... 107
- Open-circuit reflection measurement
  - Calibration, external generator ..... 329
- Operating mode ..... 110
  - Changing ..... 111
  - Presetting ..... 565
- Operating system ..... 25
  - Login ..... 26
  - service packs ..... 26

- Operation complete
  - Remote ..... 620
- Options
  - Electronic attenuation ..... 356
  - External generator control (B10) ..... 314
  - Identification (remote) ..... 620
  - Information ..... 560
  - Installing ..... 560, 561
  - Preamplifier (B24) ..... 357
  - Secure user mode (K33) ..... 33, 500
- Orientation
  - Screenshot ..... 525
- Output
  - Audio ..... 835
  - Buffer ..... 587
  - Configuration ..... 338
  - Configuration (remote) ..... 834
  - IF frequencies ..... 303
  - IF Out Frequency ..... 339
  - IF source (remote) ..... 835
  - Noise source ..... 340
  - Parameters ..... 302
  - Settings ..... 338
  - Trigger ..... 340, 341
  - Video ..... 339, 835
  - Video signal ..... 303
- OVEN
  - Error ..... 97, 1055
- OVEN (status display) ..... 98, 1055
- Overlapping commands ..... 584
  - Preventing ..... 585
- Overload
  - External generator ..... 318
- Overloading
  - External generator ..... 323
- Overview (configuration) ..... 300
- OVL D
  - External generator ..... 318
- P**
- Pa (channel bar) ..... 93
- Paint
  - Accessing ..... 30
- Parallel poll register enable
  - Remote ..... 621
- Parameters
  - Block data ..... 581
  - Boolean ..... 580
  - Entering ..... 98, 99
  - Input signal ..... 302
  - Numeric values ..... 579
  - Output ..... 302
  - Passing between applications ..... 117
  - Passing between slave applications ..... 111
  - SCPI ..... 578
  - Special numeric values ..... 579
  - String ..... 580
  - Text ..... 580
- partial spans ..... 363, 364
- Password
  - Secure user mode ..... 566
- Passwords
  - Changing ..... 67
  - Service functions ..... 572
- Peak excursion ..... 415, 418, 435, 437
- Peak list ..... 436
  - Configuring ..... 434
  - Displaying ..... 434
  - Evaluation method ..... 394
  - Exporting ..... 437, 495
  - Marker numbers ..... 437
  - Maximum number of peaks ..... 437
  - Peak excursion ..... 415, 418, 437
  - Remote control ..... 894
  - Sort mode ..... 437
  - State ..... 437
- Peak search
  - Area (spectrograms) ..... 418
  - Automatic ..... 415, 418, 436
  - Deactivating limits ..... 203, 416, 419
  - Excursion ..... 435
  - Key ..... 419
  - Limits ..... 202, 415, 418, 434
  - List ..... 436
  - Mode ..... 414, 416
  - Mode (spectrograms) ..... 416, 417
  - Reference marker ..... 412
  - Threshold ..... 415, 419
  - Type (spectrograms) ..... 417
  - Zoom limits ..... 415, 419
- Peaks
  - Displaying (SEM) ..... 234
  - Displaying (Spurious Emissions) ..... 257
  - Margin (SEM) ..... 235
  - Margin (Spurious Emissions) ..... 257
  - Marker positioning ..... 419
  - Next ..... 419
  - per range (Spurious Emissions) ..... 258
  - SEM results ..... 207
  - Softkey ..... 419
  - Spurious Emissions ..... 250
- Percent marker
  - CCDF ..... 264
  - Softkey (CCDF) ..... 267
- Period
  - Gate ranges (statistics) ..... 269
- Persistence spectrum
  - Spectrogram ..... 475
- Phase noise markers
  - Programming example ..... 914
- Phase noise measurement
  - Activating/Deactivating ..... 427
  - Application ..... 115
  - Deactivating ..... 428
  - Marker ..... 425
  - Reference point ..... 427
  - Remote control ..... 898
- PHN (marker functions) ..... 95
- Ping ..... 65
- PK (trace information) ..... 94
- Position
  - Limit line values ..... 452
  - Transducer factors ..... 552
- Positive Peak detector ..... 459
- Power
  - Channel, see Channel power ..... 146
  - Harmonics ..... 284
  - Mean (time domain) ..... 276
  - Peak (time domain) ..... 276
  - Percent (OBW) ..... 202
  - RMS (time domain) ..... 276

- Standard deviation (time domain) ..... 276
- Time domain ..... 276
- POWER
- Key ..... 36
- Power classes
- Adding/Removing (SEM) ..... 229
- Ranges (SEM) ..... 228
- SEM ..... 211, 227
- SEM results ..... 206
- Softkey ..... 227
- Used (SEM) ..... 228
- Power mode
- Band power measurement ..... 433
- CP/ACLR ..... 164, 174
- Softkey ..... 164, 174
- Power sensors
- Activating/Deactivating ..... 308
- Applications ..... 305
- Average count ..... 311
- Configuration (softkey) ..... 307
- Configuring ..... 306
- Configuring as trigger ..... 314
- Connecting ..... 306
- Continuous Value Update ..... 309
- Duty cycle ..... 311
- External power trigger ..... 311
- External trigger level ..... 311
- Frequency ..... 309
- Frequency Coupling ..... 309
- Measurement time ..... 310
- Number of readings ..... 311
- R&S NRP ..... 306
- R&S Power Viewer ..... 306
- Reference level ..... 310
- Reference level offset ..... 310
- Results ..... 306
- Selecting ..... 309
- Setting up ..... 312
- Settings ..... 307
- Unit/Scale ..... 310
- Using ..... 312
- Zeroing ..... 309, 313
- Power supply
- Connector ..... 40
- "Power Unit"
- Softkey ..... 164, 173
- Power-save mode
- Activating - see User Manual ..... 106
- PPC ..... 59
- PPE register ..... 587, 591
- PPU ..... 59
- Preamplifier
- Setting ..... 357
- Softkey ..... 357
- Predefined standards
- CP/ACLR ..... 161, 170, 192, 193
- Preset
- channel settings ..... 500
- Key ..... 499
- Recalling settings ..... 513
- Presetting
- Channels ..... 301
- Pretrigger ..... 383
- Preview
- Trigger/Gate settings ..... 380
- Print colors
- Changing - see User Manual ..... 106
- Print Screen
- Softkey ..... 521
- Printer
- Selecting ..... 523
- Printer configuration
- see user Manual ..... 20
- Printers
- Installing ..... 523
- Printing
- Colors ..... 540, 542, 545
- Colors (remote) ..... 981
- Medium ..... 523
- Screenshots ..... 521, 526
- Probability range
- Statistics ..... 271
- Product IDs ..... 60
- Programming examples
- ACLR ..... 673
- AM Modulation Depth ..... 755
- Band power markers ..... 915
- Carrier-to-Noise ratio ..... 677
- Frequency sweep ..... 1042
- Marker Peak List ..... 913
- Marker search (spectrograms) ..... 911
- Markers ..... 910
- MSR ACLR ..... 675
- n dB down markers ..... 916
- Noise markers ..... 914
- Phase noise markers ..... 914
- Reference Marker ..... 913
- SEM ..... 712
- Sequencer ..... 631
- Service request ..... 1044
- Signal count markers ..... 916
- Spectrogram ..... 859
- Spurious Emissions measurement ..... 726
- Statistics ..... 736, 912, 933, 934
- TOI ..... 753
- Protocol
- VXI ..... 53
- PSA emulation ..... 1032
- PTRansition ..... 588
- Pulse
- Application ..... 115
- PXA emulation ..... 1036
- Q**
- Queries ..... 575, 583
- Status ..... 601
- Question mark ..... 581, 583
- Quick Config
- Traces ..... 469
- Quick recall
- Settings ..... 504
- Quick save
- Settings ..... 504
- Quotation mark ..... 581
- R**
- R&S FSP
- Emulating ..... 610
- Emulating (remote) ..... 1002
- R&S FSQ
- Emulating ..... 610
- Emulating (remote) ..... 1002

- R&S FSU
  - Emulating ..... 610
  - Emulating (remote) ..... 1002
- R&S FSV
  - Emulating ..... 610
  - Emulating (remote) ..... 1002
- R&S NRP
  - Power sensors ..... 306
- R&S Power Viewer Plus ..... 306
- R&S SMA
  - External generator ..... 316
- R&S SMW
  - External generator ..... 316
- R&S Support ..... 567
- Rackmounting ..... 24
- Range ..... 358
  - Scaling ..... 359
  - X-axis (statistics) ..... 271
- Ranges
  - Definition (SEM) ..... 210
  - Deleting (SEM) ..... 224
  - Deleting (Spurious Emissions) ..... 256
  - Inserting (SEM) ..... 224
  - Inserting (Spurious Emissions) ..... 256
  - Reference (SEM) ..... 210, 226
  - Remote control (Spurious Emissions) ..... 251
  - Rules (SEM) ..... 210
  - Rules (Spurious Emissions) ..... 250
  - SEM ..... 209
  - Symmetrical (SEM) ..... 211
- RBW
  - see Resolution Bandwidth ..... 361
- RBW (channel setting) ..... 92
- Ready for trigger
  - Status register ..... 592
- Rear panel
  - Overview ..... 37
- Rebooting
  - Remote control ..... 1001
- Recalling
  - Calibration settings, external generator ..... 329
  - Settings ..... 502, 504, 507, 511
  - Settings for preset ..... 513
  - Softkey ..... 507
- Recommendations
  - Remote control programming ..... 602
- REDO
  - Key ..... 87
- REF INPUT
  - Connector ..... 39
- Ref Level (channel setting) ..... 92
- Ref Lvl = Mkr Lvl ..... 420
- Reference
  - External ..... 558
  - Fixed ..... 412, 430
  - Fixed (channel power) ..... 164
  - Fixed (Delta marker) ..... 438
  - Frequency ..... 558
  - Frequency (remote control) ..... 969
  - Internal ..... 558
  - Marker ..... 412, 430
  - Phase noise measurement ..... 427
  - Power (SEM) ..... 227
  - Range (SEM) ..... 210, 226
  - Softkey ..... 558
- Reference channel
  - CP/ACLR ..... 163, 172
- Reference frequency
  - Default ..... 559
  - External generator ..... 316, 325
  - Input ..... 558
- Reference level ..... 352, 355
  - Adjusting to transducer factors ..... 550
  - Auto level ..... 356, 391
  - CP/ACLR ..... 155
  - External generator ..... 319
  - Offset ..... 355
  - Offset (Power sensor) ..... 310
  - Position ..... 359
  - Power sensor ..... 310
  - SEM range ..... 222
  - Setting to marker ..... 420
  - Spurious Emissions range ..... 254
  - Statistics ..... 271
  - Unit ..... 355
  - Value ..... 355
- Reference line
  - External generator ..... 319
  - Position, external generator ..... 330
  - Shifting, external generator ..... 320, 330
  - Value, external generator ..... 330
- Reference marker ..... 410
- Reference Marker
  - Programming example ..... 913
- Reference range
  - Softkey ..... 226
- Reference trace
  - External generator ..... 318, 319
  - Storing as transducer factor, external generator ..... 319, 329
- Reflection measurement
  - External generator ..... 315
  - How to, external generator ..... 331
- Registers ..... 587
- Relay Cycle Counter ..... 573
- Release notes ..... 18
- Remote commands
  - Deprecated ..... 1039
- Remote control
  - Blocked ..... 1056
  - Errors ..... 1056
  - Ignored commands ..... 602
  - Interfaces ..... 51
  - LXI settings ..... 612
  - Protocols ..... 51
  - Sequential commands ..... 1056
- Remote Desktop ..... 50, 70
  - Client ..... 71
  - Ending session ..... 73
  - Setting up a connection ..... 73
  - Setting up controller ..... 71
  - Setting up instrument ..... 70
- Remote display
  - Update ..... 609
- Remote operation
  - Configuring ..... 574
  - Deactivating the instrument ..... 75
  - GPIB address ..... 66
  - GPIB settings ..... 607
  - see also Remote control ..... 574
  - Setting up ..... 50
  - Settings ..... 605
  - Starting ..... 69

- Repeatability
  - CP/ACLR measurements ..... 150
- Reset values
  - Remote ..... 621
- Resolution bandwidth
  - Auto (Softkey) ..... 368
  - CP/ACLR ..... 153
  - Harmonics ..... 285
  - Impact ..... 361
  - Manual (Softkey) ..... 368
  - SEM range ..... 221
  - Spurious Emissions range ..... 254
  - Statistics ..... 274
- Restoring
  - Channel settings ..... 301
  - Standard files ..... 234
- Restricted operation
  - Secure user mode ..... 34, 501
- Restrictions
  - Storage space ..... 34, 501
- Result displays
  - Diagram ..... 394
  - Marker table ..... 394
  - Peak list ..... 394
  - Programming example ..... 773
  - Result Summary ..... 395
  - Spectrogram ..... 395
- Result frequency
  - External generator ..... 328
- Result Summary
  - Configuration (SEM) ..... 234
  - Evaluation method ..... 395
  - Result display ..... 395
  - Saving (SEM) ..... 235
- Results
  - CP/ACLR measurements ..... 146
  - Data format (remote) ..... 853, 858, 963
  - Displaying ..... 100
  - Exporting ..... 491
  - Managing ..... 499
  - OBW ..... 200
  - SEM ..... 206
  - SEM (remote) ..... 209
  - Storing (remote) ..... 962
- Reverse sweep
  - External generator ..... 322, 327
- Revision string
  - GPIO ..... 611, 1003
  - GPIO (remote control) ..... 988
  - Resetting ..... 612
- RF attenuation
  - Auto ..... 356
  - Impact ..... 353
  - Manual ..... 356
  - Mode (SEM range) ..... 222
  - Mode (Spurious Emissions range) ..... 255
  - Noise floor ..... 353
  - SEM range ..... 222
  - Spurious Emissions range ..... 255
- RF input
  - Remote ..... 812, 814
- RF Input
  - Connector ..... 37, 38
- RF OVLD
  - Error ..... 97, 1055
  - External generator ..... 322
- RF OVLD (status display) ..... 98, 1055
- RF Power
  - Trigger ..... 382
  - Trigger level (remote) ..... 802
- Rising
  - Slope (Power sensor) ..... 312
- RM (trace information) ..... 94
- RMS
  - VBW ..... 461
- RMS detector ..... 459
  - VBW ..... 362
- RRC filter
  - SEM ..... 227
- RUN CONT
  - Key ..... 125, 371, 480
- RUN SINGLE
  - Key ..... 125, 371, 372, 480
- S**
- S/N ratio
  - Measurement example ..... 129, 143
- SA (trace information) ..... 94
- Safety instructions ..... 18
- Sample detector ..... 459
- Samples
  - Statistics ..... 267, 276
- Save/Recall Mode
  - Settings ..... 509
- Savesets
  - Settings ..... 505
- Saving
  - Classified data ..... 33, 500
  - Data types ..... 506
  - Functions ..... 507
  - Instrument settings ..... 511
  - Limit lines ..... 453
  - Screenshots ..... 526
  - SEM result files ..... 239
  - Settings ..... 233, 507
  - Softkey ..... 507
  - Spurious Emissions result files ..... 259
  - Transducer lines ..... 553
- Scalar reflection measurement
  - External generator ..... 315
- Scaling
  - Amplitude range, automatically ..... 359
  - Configuration ..... 358
  - Default (statistics) ..... 271
  - Statistics ..... 270
  - X-axis (remote control) ..... 777
  - Y-axis ..... 354, 359
  - Y-axis (remote control) ..... 799
- SCPI
  - Parameters ..... 578
  - Syntax ..... 576
  - version ..... 574
- SCPI confirmed commands ..... 575
- Screenshots
  - Printing ..... 521, 526
  - Saving ..... 521, 526
- SDC ..... 59
- Search limits
  - Deactivating ..... 203, 416, 419
  - OBW ..... 199, 201
- "Search Limits"
  - Activating ..... 202, 415, 418

- Search Mode
  - Spectrogram markers ..... 416
- Search range
  - Zoom area ..... 401
- Search Signals
  - Softkey ..... 293, 298
- Searching
  - Configuration ..... 413
  - Configuration (softkey) ..... 416
  - In help ..... 108
- Second harmonic intercept ..... 281
- Secure user mode
  - Activating ..... 565
  - Activating/deactivating ..... 34, 501
  - Background information ..... 33, 500
  - Instrument settings ..... 503
  - Login ..... 27
  - Redirecting storage ..... 33, 500
  - Remote ..... 994
  - Restricted operation ..... 34, 501
  - Self-alignment ..... 534, 560, 563, 605
  - Self-alignment data ..... 34, 501
  - Storage location ..... 233, 507, 508, 511
  - Transducer settings ..... 548
- SecureUser ..... 34, 45, 501
- Security procedures ..... 18
- Select Frame
  - Softkey ..... 372, 479
- Select Marker ..... 410
- Self-alignment ..... 533
  - Aborting ..... 534
  - Secure user mode ..... 34, 501, 534, 560, 563, 605
  - Starting ..... 534
- Self-test
  - Performing ..... 534, 568
  - Remote ..... 622
  - Results ..... 568, 974
  - Settings ..... 568
  - Temperature ..... 534
- Selftest
  - Remote ..... 994
- SEM ..... 205
  - About ..... 205
  - Adding power classes ..... 229
  - Alpha value (RRC filter) ..... 227
  - Applications ..... 205
  - Channel power settings ..... 227
  - Configuring ..... 219, 235
  - Deleting ranges ..... 224
  - Displaying peaks ..... 234
  - Exporting results ..... 239
  - Fast mode ..... 213, 221
  - Filter type ..... 221
  - Format description of export files ..... 247
  - Format description of settings files ..... 241
  - Inserting ranges ..... 224
  - Limit absolute ..... 223
  - Limit check ..... 223
  - Limit lines ..... 211
  - Limit relative ..... 223
  - List evaluation ..... 234
  - List evaluation (remote control) ..... 710
  - List evaluation state ..... 234
  - Measurement (remote control) ..... 680
  - Measurement result list ..... 234
  - MSR (remote control) ..... 704
  - Multiple sub blocks (Multi-SEM) ..... 215
  - Peak margins ..... 235
  - Performing ..... 235
  - Power class ranges ..... 228
  - Power classes ..... 211, 227
  - Power classes (remote control) ..... 699
  - Programming example ..... 712
  - Provided settings files ..... 241
  - Range start/stop ..... 221
  - Ranges ..... 209
  - RBW ..... 221
  - Reference level ..... 222
  - Reference power ..... 227
  - Reference range ..... 226
  - Reference range (remote control) ..... 697
  - Restoring standard files ..... 234
  - Result files ..... 239
  - Results ..... 206
  - Results (Multi-SEM) ..... 208
  - Results (remote control) ..... 712, 725
  - Results (remote) ..... 209
  - RF attenuation ..... 222
  - RF attenuation mode ..... 222
  - RRC filter ..... 227
  - Saving result summary ..... 235
  - Settings files ..... 232, 238
  - Standard files ..... 232
  - Standards (remote control) ..... 680
  - "Sweep List" ..... 220
  - Sweep list (remote control) ..... 683
  - "Sweep Points" ..... 224
  - "Sweep Time" ..... 222
  - "Sweep Time Mode" ..... 222
  - Transducer ..... 222
  - "Tx Bandwidth" ..... 227
  - Used power classes ..... 228
  - VBW ..... 221
- Sensitivity
  - RBW ..... 361
- Sequencer ..... 92
  - Aborted ..... 534, 568
  - Aborting (remote) ..... 628
  - Activating (remote) ..... 629
  - Channels ..... 119
  - Example ..... 120
  - Mode ..... 119, 121
  - Mode (remote) ..... 629
  - Programming example ..... 631
  - Remote ..... 635
  - Remote control ..... 623
  - RUN SINGLE ..... 120
  - Setting up ..... 121
  - Single Sweep ..... 120
  - Softkey ..... 121
  - State ..... 121
- Sequential commands ..... 584
  - Errors ..... 1056
- Service functions ..... 566, 570, 571
  - Numeric mode ..... 571
  - Passwords ..... 572
  - Results ..... 572
- Service manual ..... 17
- Service packs ..... 26
- Service request (SRQ) ..... 574, 587, 590, 599
- Service request enable register (SRE) ..... 587, 590
  - Remote ..... 622
- Set CP Reference
  - Softkey ..... 164

- Setting commands ..... 575
- Settings
  - filename ..... 233, 509, 511
  - Format description (SEM) ..... 241
  - Loading ..... 511
  - Managing ..... 499
  - Provided files (SEM) ..... 241
  - Recalling ..... 502, 504
  - Recalling; restrictions ..... 503
  - Restoring files ..... 234
  - Saving ..... 506, 511
  - Storage location ..... 233, 508, 511
  - Storing ..... 502, 504
- Settings files
  - Deleting ..... 233
  - Deleting (SEM) ..... 238
  - Loading ..... 233
  - Loading (SEM) ..... 238
  - Managing (SEM) ..... 238
  - Restoring (SEM) ..... 238
  - Saving ..... 233
  - Saving (SEM) ..... 238
- Setup files
  - External generator ..... 317, 324, 325
- Sgl (channel bar) ..... 93
- Shift x
  - Limit lines ..... 453
  - Transducer lines ..... 552
- Shift y
  - Limit lines ..... 453
  - Transducer lines ..... 553
- Shifting
  - Limit lines ..... 445
- Short-circuit reflection measurement
  - Calibration, external generator ..... 329
- Shutdown
  - Remote control ..... 1001
- Signal count
  - Marker ..... 422
  - Remote control ..... 908
  - Resolution ..... 422
- Signal count markers
  - Programming example ..... 916
- Signal counter
  - Measurement example ..... 128
- Signal source
  - Remote ..... 814
- Signal tracking ..... 349
  - Bandwidth ..... 350
  - Softkey ..... 350
  - State ..... 350
  - Threshold ..... 350
  - Trace ..... 350
- Single Sequencer
  - Softkey ..... 121
- Single sweep
  - Softkey ..... 125, 371, 480
- Single zoom ..... 400, 401
- Sinusoidal signals
  - Measurement example ..... 126
- Slope
  - Edge gate ..... 384
  - Power sensor trigger ..... 312
  - Trigger ..... 384, 803
  - Trigger (Power sensor) ..... 312
- SmartGrid
  - Activating ..... 103, 398
  - Arranging windows ..... 105, 399
  - Display ..... 101, 395
  - Evaluation bar ..... 104, 398
  - Features ..... 101, 395
  - Mode ..... 103, 398
  - Programming example ..... 773
- Smoothing
  - Traces ..... 464
  - Traces (group delay) ..... 468
- Soft front panel
  - Overview ..... 81
- softkey
  - Calibration Frequency WB ..... 972
  - Filter Type (remote control) ..... 791
  - Trace Mode (remote control) ..... 739, 740
- Softkey
  - Calibrate Reflection Open (remote control) ..... 820
  - Calibrate Reflection Short (remote control) ..... 820
  - Calibrate Transmission (remote control) ..... 820
  - Normalize (remote control) ..... 821
- Softkey bar
  - Hiding/restoring ..... 538
- Softkeys
  - # of Samples (APD, CCDF) ..... 267
  - "% Power Bandwidth" ..... 202
  - ACLR Mode ..... 164, 173
  - "Adjust Settings" ..... 165, 174, 197, 202, 285
  - Adjust Settings (APD) ..... 268, 272
  - Adjust X-Axis ..... 256
  - All Functions Off ..... 437
  - Amplitude Config ..... 354
  - Analysis BW (APD, CCDF) ..... 267
  - Auto All ..... 390
  - Auto Freq ..... 390
  - Auto Level ..... 356, 391
  - Bandwidth Config ..... 366
  - C/N ..... 197
  - C/No ..... 197
  - Carrier Noise Config ..... 196
  - Center ..... 347
  - Center = Mkr Freq ..... 420
  - Channel Bandwidth ..... 197, 202
  - Channel-defined Sequencer ..... 121
  - Clear All Messages (remote control) ..... 992
  - Clear Spectrogram ..... 373, 480
  - Color Mapping ..... 480
  - Comment ..... 518
  - Continue Single Sweep ..... 125, 372
  - Continuous Sequencer ..... 121
  - Continuous Sweep ..... 125, 371, 480
  - Copy Trace ..... 471
  - CP/ACLR Settings ..... 160
  - CP/ACLR Standard ..... 161, 170
  - Device ..... 518, 522, 524
  - Display Config ..... 393
  - Export ..... 514
  - Export config ..... 515
  - External ..... 381
  - Frame count ..... 373
  - Free Run ..... 381
  - Frequency Config ..... 345
  - Full Span ..... 348
  - Gated Trigger ..... 268
  - Harmonic RBW Auto ..... 285
  - Harmonic Sweep Time ..... 285

|                               |               |                                        |               |
|-------------------------------|---------------|----------------------------------------|---------------|
| History Depth .....           | 479           | Startup Recall .....                   | 510           |
| Horizontal Line 1/2 .....     | 442           | Startup Recall (On/Off) .....          | 511           |
| I/Q Export .....              | 515           | Status .....                           | 83            |
| IF Power .....                | 382           | Stop .....                             | 347           |
| Import .....                  | 514           | Sweep Config .....                     | 366           |
| Input Source Config .....     | 303           | "Sweep Count" .....                    | 370           |
| Install Printer .....         | 523           | "Sweep List" .....                     | 220           |
| Last Span .....               | 348           | "Sweep Time" .....                     | 165           |
| Line Config .....             | 447           | "Sweep Time" Auto .....                | 368           |
| List evaluation .....         | 234           | "Sweep Time" Manual .....              | 368           |
| Lower Level Hysteresis .....  | 392           | System Messages (remote control) ..... | 992           |
| Marker 1/2/3 .....            | 297           | Timestamp .....                        | 479           |
| Marker 1/2/3/4 .....          | 293           | Trace 1/2/3/4 .....                    | 469           |
| Marker Config .....           | 408, 411      | Trace Config .....                     | 465, 486      |
| Marker Search Area .....      | 418           | Transducer .....                       | 548           |
| Marker Search Type .....      | 417           | Trigger Offset .....                   | 383           |
| Marker to Trace .....         | 410           | Trigger/Gate Config .....              | 379           |
| Meastime Auto .....           | 391           | Upper Level Hysteresis .....           | 391           |
| Meastime Manual .....         | 391           | Vertical Line 1/2 .....                | 442           |
| Min .....                     | 420           | Video .....                            | 381           |
| MSR Configuration .....       | 229           | Video BW Auto .....                    | 368           |
| Next Min .....                | 420           | Video BW Manual .....                  | 368           |
| Next Mode X .....             | 416           | Zero Span .....                        | 348           |
| Next Mode Y .....             | 417           | Sort mode                              |               |
| Next Peak .....               | 419           | Peak list .....                        | 437           |
| No. of Harmonics .....        | 285           | Source offset                          |               |
| Noise cancellation .....      | 163, 172, 357 | External generator .....               | 326           |
| Norm/Delta .....              | 409, 425      | Source power                           |               |
| Outputs Config .....          | 338           | External generator .....               | 326           |
| Peak .....                    | 419           | Spacing                                |               |
| Percent Marker .....          | 267           | MSR, adjacent channels .....           | 179           |
| Power classes .....           | 227           | MSR, gap channels .....                | 182           |
| Power Mode .....              | 164, 174      | Spacings                               |               |
| Power Sensor Config .....     | 307           | CP/ACLR .....                          | 167           |
| "Power Unit" .....            | 164, 173      | Span .....                             | 347           |
| Preamp .....                  | 357           | Band power measurement .....           | 433           |
| Print Screen .....            | 521           | Carrier-to-Noise .....                 | 195           |
| R&S Support .....             | 567           | CP/ACLR .....                          | 153           |
| Recall .....                  | 507           | Manual .....                           | 347           |
| Recall File .....             | 506, 510      | Span/RBW coupling .....                | 363           |
| Ref Level .....               | 355           | SPD .....                              | 59            |
| "Ref Level" (APD; CCDF) ..... | 271           | SPE .....                              | 59            |
| Ref Level Offset .....        | 355           | Spectrograms                           |               |
| Ref Lvl = Mkr Lvl .....       | 420           | Activating/Deactivating .....          | 479           |
| Reference .....               | 558           | Clearing .....                         | 373, 480      |
| Reference range .....         | 226           | Color curve .....                      | 475, 481, 485 |
| Res BW Auto .....             | 368           | Color mapping .....                    | 474, 480, 484 |
| Res BW Auto (remote) .....    | 786           | Color mapping (remote control) .....   | 849           |
| Res BW Manual .....           | 368           | Color scheme .....                     | 474, 481      |
| RF Atten Auto .....           | 356           | Configuring .....                      | 483           |
| RF Atten Manual .....         | 356           | Configuring (remote control) .....     | 844           |
| RF Power .....                | 382           | Continue frame .....                   | 473           |
| Save .....                    | 507           | Display .....                          | 471           |
| Save File .....               | 509           | Displaying .....                       | 482           |
| Scale Config .....            | 358           | Evaluation method .....                | 395           |
| Search Config .....           | 413, 416      | Frame count .....                      | 473           |
| Search Signals .....          | 293, 298      | Frames (remote control) .....          | 844           |
| Select Frame .....            | 372, 479      | History depth .....                    | 479           |
| Select Marker .....           | 410           | Markers .....                          | 477, 483      |
| Sequencer .....               | 121           | Markers (remote control) .....         | 882           |
| Set CP Reference .....        | 164           | Programming example .....              | 859           |
| Signal Track .....            | 350           | Removing .....                         | 483           |
| Single Sequencer .....        | 121           | Scaling .....                          | 473           |
| Single Sweep .....            | 125, 371, 480 | Selecting frames .....                 | 372, 479      |
| Span Manual .....             | 347           | Settings .....                         | 478           |
| Standard files .....          | 232           | Size .....                             | 479           |
| Start .....                   | 347           | Sweep count .....                      | 473           |



- Time frames ..... 472
- Timestamps ..... 474, 479
- Value range ..... 475, 484
- Spectrum
  - Application ..... 112
- Spectrum Emission Mask
  - see SEM ..... 205
- Split
  - Window ..... 106
- Split display ..... 85
- Splitters
  - Window size ..... 105
- Spurious Emissions ..... 248
  - About ..... 248
  - Configuring ..... 252
  - Deleting ranges ..... 256
  - Detector ..... 254
  - Displaying peaks ..... 257
  - Evaluation list ..... 249
  - Exporting results ..... 259
  - Filter type ..... 253
  - Format description of export files ..... 259
  - Inserting ranges ..... 256
  - Limit absolute ..... 256
  - Limit check ..... 255
  - Limit lines ..... 251
  - List details ..... 257
  - List evaluation ..... 256
  - List evaluation state ..... 257
  - Measurement (remote control) ..... 715
  - Measurement result list ..... 256
  - Peak margins ..... 257
  - Peaks ..... 250
  - Peaks per range ..... 258
  - Performing ..... 252, 258
  - Programming example ..... 726
  - Range start/stop ..... 253
  - Ranges ..... 250
  - RBW ..... 254
  - Reference level ..... 254
  - Result files ..... 259
  - Results ..... 249
  - RF attenuation ..... 255
  - RF attenuation mode ..... 255
  - Saving list evaluation ..... 258
  - Sweep behavior ..... 255
  - Sweep list ..... 252, 716
  - Sweep points ..... 255
  - Sweep time ..... 254
  - Sweep time mode ..... 254
  - Transducer ..... 255
  - VBW ..... 254
- SRE (service request enable register) ..... 590
- SRQ (service request) ..... 590, 599
- Standard
  - MSR Tx channel ..... 177
- Standard deviation
  - Power (time domain) ..... 276
- Standard files
  - Multi-SEM ..... 232
  - Softkey ..... 232
- Standards
  - CP/ACLR measurements ..... 161, 170
  - Format description (SEM) ..... 241
  - Provided files (SEM) ..... 241
  - Restoring files (SEM) ..... 234
- Settings files (Multi-SEM) ..... 226
- Settings files (SEM) ..... 232
- Start frequency
  - Softkey ..... 347
- Startup recall
  - Remote ..... 946
- Startup Recall
  - Softkey ..... 511
- Statistics
  - Default scaling ..... 271
  - Gate (remote control) ..... 730
  - Gated trigger ..... 265
  - Measurements ..... 261
  - Measurements (remote control) ..... 728
  - Optimizing ..... 276
  - Programming example ..... 736, 912, 933, 934
  - Scaling ..... 270
  - Scaling (remote control) ..... 732
  - see also APD, CCDF ..... 261
- Status
  - Queries ..... 601
- Status bar
  - Color coding ..... 97, 1054
  - Error messages ..... 97, 1054
  - Error messages, external generator ..... 323
  - Hiding/restoring ..... 537
  - Secure user mode ..... 34, 501
- Status byte
  - Remote ..... 619, 622
- Status byte (STB) ..... 590
- Status byte register (STB) ..... 587
- Status display ..... 96
- Status registers ..... 587
  - CONDITION ..... 588
  - ENABLE ..... 588
  - EVENT ..... 588
  - model ..... 588
  - NTRansition ..... 588
  - parts ..... 588
  - PTRansition ..... 588
  - STATus:OPERation ..... 592
  - STATus:QUESTionable ..... 593
  - STATus:QUESTionable:ACPLimit ..... 594
  - STATus:QUESTionable:EXTended ..... 595
  - STATus:QUESTionable:EXTended:INFO ..... 595
  - STATus:QUESTionable:FREQUENCY ..... 596
  - STATus:QUESTionable:LIMit ..... 597
  - STATus:QUESTionable:LMARgin ..... 597
  - STATus:QUESTionable:POWER ..... 598
  - STATus:QUESTionable:TIME ..... 599
- Status reporting system ..... 586
  - Application ..... 599
  - Common commands ..... 618
- Step size
  - Markers ..... 412
  - Markers (remote control) ..... 868
- Stop frequency
  - Softkey ..... 347
- Storage location
  - Data files ..... 507
  - Secure user mode ..... 233, 507, 508, 511
  - Settings ..... 233, 508, 511
- Storage settings
  - File type ..... 509
- Storing
  - Settings ..... 502, 504
- String in remote commands ..... 580

- Sub blocks
  - Configuring ..... 176
  - MSR, Center frequency ..... 176
  - MSR, number of Tx channels ..... 176
  - MSR, RF bandwidth ..... 176
  - MSR, Tx channel definition ..... 176
  - Number (Multi-SEM) ..... 225
  - Standard files ..... 232
- Subnet Mask ..... 43, 607
- Subwindows
  - Spectrogram ..... 479
- Suffixes ..... 577
  - Common ..... 618
- Support ..... 1058
  - Information ..... 567
  - Information (remote) ..... 994
- Suppressing
  - File name dialog ..... 523
- Sweep
  - Aborting ..... 371, 372, 480
  - Behavior (Spurious Emissions) ..... 255
  - Configuration (Softkey) ..... 366
  - Continuous ..... 125
  - Count ..... 365
  - Count (Spectrograms) ..... 473
  - Default settings ..... 360
  - Mode ..... 125, 366
  - Performing ..... 125
  - Points ..... 365, 459
  - Points (SEM range) ..... 224
  - Points (Spurious Emissions range) ..... 255
  - Settings (Spectrogram) ..... 372
  - Single ..... 125
  - Time (remote) ..... 790
  - Type ..... 363, 371
  - Type (remote) ..... 791
- "Sweep Count" ..... 370
- Sweep list
  - Deleting ranges ..... 256
  - Detector ..... 254
  - Filter type ..... 253
  - Inserting ranges ..... 256
  - Limit absolute ..... 256
  - Limit check ..... 255
  - Range start/stop (Spurious Emissions) ..... 253
  - RBW ..... 254
  - Reference level ..... 254
  - RF attenuation ..... 255
  - RF attenuation mode ..... 255
  - Spurious Emissions ..... 252
  - Sweep behavior ..... 255
  - Sweep points ..... 255
  - Sweep time ..... 254
  - Sweep time mode ..... 254
  - Transducer ..... 255
  - VBW ..... 254
- "Sweep List"
  - Deleting ranges ..... 224
  - Fast SEM ..... 221
  - Filter type ..... 221
  - Inserting ranges ..... 224
  - Limit absolute ..... 223
  - Limit check ..... 223
  - Limit relative ..... 223
  - Range start/stop (SEM) ..... 221
  - RBW ..... 221
  - Reference level ..... 222
  - RF attenuation ..... 222
  - RF attenuation mode ..... 222
  - SEM ..... 220
  - Softkey ..... 220
  - "Sweep Points" (SEM) ..... 224
  - "Sweep Time" ..... 222
  - "Sweep Time Mode" ..... 222
  - Symmetrical ..... 225
  - Transducer ..... 222
  - VBW ..... 221
- Sweep points
  - Logarithmic x-axis scaling ..... 344
- "Sweep Points" ..... 370
- Sweep Repeat
  - GPIB ..... 611
  - GPIB (remote control) ..... 1004
- Sweep status
  - Status register ..... 592
- Sweep time
  - Harmonics ..... 285
  - Spurious Emissions range ..... 254
  - Statistics ..... 267
- "Sweep Time" ..... 365
  - Auto (Softkey) ..... 368
  - CP/ACLR ..... 152, 165
  - Manual (Softkey) ..... 368
  - SEM range ..... 222
  - Softkey ..... 165
  - Values ..... 368
- Sweep time mode
  - Spurious Emissions range ..... 254
- "Sweep Time Mode"
  - SEM range ..... 222
- Sweeps
  - Reverse, external generator ..... 322
- Switching
  - Focus area ..... 85
  - Keyboard display ..... 85
  - Maximized/split display ..... 85
- SWT (channel setting) ..... 92
- Symmetric setup
  - SEM ..... 225
  - SEM ranges ..... 211
- Syntax elements
  - SCPI ..... 581
- System
  - Configuration ..... 559
  - Configuration (remote) ..... 989
  - Messages ..... 562
  - Preset operating mode ..... 565
- SYSTEM
  - Keys ..... 85
- System messages
  - Deleting ..... 45
- T**
- Tabs
  - All ..... 100
  - Channels ..... 110
  - MultiView ..... 116
  - Switching ..... 91
- Task bar
  - Accessing ..... 30
- TCP/IP
  - Address, External generator ..... 325
  - External generator ..... 324

- TD-SCDMA BTS
  - Application ..... 115
- TD-SCDMA UE
  - Application ..... 115
- Tdf (channel bar) ..... 93
- Technology
  - MSR Tx channel ..... 177
- Text paramters in remote commands ..... 580
- Theme
  - Display ..... 540, 541
  - Display (remote) ..... 981
- Third order intercept point
  - see TOI ..... 286
- Threshold
  - Limit lines ..... 444, 451
  - Peak search ..... 415, 419
  - Signal tracking ..... 350
- Time
  - Format ..... 536
  - Hiding/restoring ..... 538
  - Instrument setting ..... 536
- Time Domain Power ..... 276
  - About ..... 276
  - Configuring ..... 278
  - Limit lines ..... 277, 278
  - Measurement (remote control) ..... 738
  - Measurement example ..... 279
  - Measuring ..... 279
  - Restricting range ..... 277
  - Results ..... 276, 278
- Time frames
  - Configuring ..... 372
  - Continuing ..... 372
  - Navigating ..... 372, 474
  - per sweep ..... 373
  - Selecting ..... 372, 479
  - Spectrograms ..... 472
- Time lines
  - Remote control ..... 917
- Timestamps
  - Softkey (Spectrogram) ..... 479
  - Spectrograms ..... 474, 479
- TOI ..... 286
  - About the measurement ..... 287
  - Basics ..... 287
  - Calculation method ..... 289
  - Configuring ..... 292
  - Determining ..... 293
  - Markers ..... 293
  - Programming example ..... 753
  - Results ..... 291
  - Search signals ..... 293
- TOI (marker functions) ..... 95
- Toolbar
  - Hiding/restoring ..... 537
  - Overview ..... 82
- Total Harmonic Distortion
  - Measurement ..... 284
- Trace information ..... 94
  - Detector type ..... 94
  - Trace number ..... 94
  - Window title bar ..... 94
- Trace math
  - Functions ..... 487
  - Settings ..... 486
- Trace smoothing ..... 464
- Traces ..... 469
  - Average mode ..... 468
  - Averaging ..... 464
  - Averaging (algorithm) ..... 463
  - Averaging (remote control) ..... 842
  - Configuration ..... 465
  - Configuration (Softkey) ..... 486
  - Configuring ..... 470
  - Configuring (remote control) ..... 838
  - Copying ..... 469, 471
  - Copying (remote control) ..... 843
  - Detector ..... 459, 467
  - Detector (remote control) ..... 842
  - Export format ..... 493
  - Exporting ..... 490, 491, 492, 494, 514
  - Hold ..... 467
  - Mode ..... 466
  - Mode (CP/ACLR) ..... 155
  - Mode (remote) ..... 838
  - Saving ..... 506
  - Settings ..... 459
  - Settings (remote control) ..... 838
  - Settings, predefined ..... 469
- Traces to be Checked
  - Limit lines ..... 449
- Tracking
  - see External generator ..... 326
- Tracking bandwidth ..... 350
- Tracking generator
  - see External generator ..... 314
- Tracking threshold ..... 350
- Transducers
  - Activating/Deactivating ..... 550
  - Adjusting reference level ..... 550
  - Calibration with external generator ..... 319, 329
  - Checking ..... 555
  - Comment ..... 552
  - Compatibility ..... 550
  - Compatible ..... 554
  - Configuration ..... 547
  - Configuration (remote control) ..... 974
  - Configuring ..... 554
  - Copying ..... 550, 555
  - Creating ..... 550, 556
  - Data points ..... 552
  - Deleting ..... 551, 556
  - Deleting values ..... 552
  - Editing ..... 550, 555
  - Factors ..... 546
  - Inserting values ..... 552
  - Managing ..... 548
  - Name ..... 551
  - Recalling ..... 503
  - Saving ..... 503, 506, 553
  - Secure user mode ..... 548
  - SEM range ..... 222
  - Settings ..... 548
  - Shifting ..... 552, 553, 556
  - Softkey ..... 548
  - Spurious Emissions range ..... 255
  - Storing ..... 547
  - Unit ..... 552
  - Validity ..... 547
  - View filter ..... 550
  - X-axis ..... 552
  - Y-axis unit ..... 547

- Transient Analysis
  - Application ..... 115
- Transmission measurement
  - Calibration, external generator ..... 328
  - External generator ..... 315
  - How to, external generator ..... 331
- TRG (channel bar) ..... 93
- Trigger
  - Configuration preview ..... 380
  - Drop-out time ..... 383
  - Drop-Out Time ..... 377
  - Drop-out time (Power sensor) ..... 312
  - Event (remote) ..... 622
  - External (remote) ..... 803
  - External power ..... 311
  - External, errors ..... 1056
  - Holdoff ..... 378, 383
  - Holdoff (Power sensor) ..... 312
  - Hysteresis ..... 376, 383
  - Hysteresis (Power sensor) ..... 311
  - Level (Power sensor) ..... 311
  - Measurements ..... 375
  - Offset ..... 376, 383
  - Output ..... 340, 341
  - Power sensor ..... 311, 314
  - Slope ..... 384, 803
  - Slope (Power sensor) ..... 312
  - Status register ..... 592
- TRIGGER INPUT / OUTPUT
  - Connectors ..... 39
- Trigger level ..... 382
  - External trigger (remote) ..... 801
  - I/Q Power (remote) ..... 802
  - IF Power (remote) ..... 802
  - RF Power (remote) ..... 802
- Trigger source ..... 376, 381
  - External ..... 381
  - Free Run ..... 381
  - IF Power ..... 382
  - RF Power ..... 382
  - Video ..... 381
- Trigger/Gate
  - Configuration (Softkey) ..... 379
- TRK (marker functions) ..... 95
- Troubleshooting
  - CP/ACLR ..... 192
  - File name error ..... 946
  - Hardware ..... 572
  - Low frequencies ..... 1058
  - Overload, external generator ..... 323
  - Remote control programs ..... 609, 1057
  - Trace display ..... 1058
- "Tx Bandwidth"
  - SEM ..... 227
- Tx channel
  - MSR, Center frequency ..... 176
  - MSR, technology ..... 177
- Tx channels
  - in MSR sub blocks ..... 176
  - MSR, configuring ..... 176
  - MSR, weighting filters ..... 177
- U**
- UNCAL
  - Error ..... 97, 1055
- UNCAL (status display) ..... 98, 1055
- UNDO
  - Key ..... 87
- Units
  - Power sensor ..... 310
  - Reference level ..... 355
  - Transducer factors ..... 552
  - Y-axis (statistics) ..... 271
- UP ..... 579
- Update Path
  - Remote control ..... 993
- Update rate
  - Display ..... 536
- Updating
  - Firmware ..... 563
- Upper Level Hysteresis ..... 391
- USB
  - Address ..... 59
  - Connector ..... 40
  - Connectors ..... 36
  - Interfaces ..... 59
- User standards
  - CP/ACLR ..... 161, 171
  - Loading (CP/ACLR) ..... 187
  - Managing ..... 161, 171
  - Storing (CP/ACLR) ..... 187
- Users
  - Network ..... 66
  - Password ..... 67
- V**
- VBW
  - CP/ACLR ..... 154
  - RMS detector ..... 461
  - see Video bandwidth ..... 362
  - SEM range ..... 221
  - Spurious Emissions range ..... 254
- VBW (channel setting) ..... 92
- VBW/RBW coupling ..... 362
- Vendor ID
  - Rohde & Schwarz ..... 59
- Version information ..... 560
- Vertical Line 1/2
  - Softkeys ..... 442
- Vertical stroke ..... 581
- Video
  - Output ..... 303
  - Trigger source ..... 381
- Video bandwidth ..... 368
  - Auto (Softkey) ..... 368
  - Impact ..... 362
  - Manual (Softkey) ..... 368
  - RMS detector ..... 362
- Video output ..... 339, 835
- View filter
  - Limit lines ..... 449
  - Transducer lines ..... 550
- Virus protection ..... 26
- VISA ..... 51, 52
  - Libraries ..... 60
  - Resource string ..... 52, 60
- Visible
  - Limit lines ..... 449
- Volatile memory
  - Secure user mode ..... 33, 500
- VSA (Vector Signal Analysis)
  - Application ..... 116

- VXI protocol ..... 53
- W**
- Wait  
  Remote ..... 623
- Waiting for trigger  
  Status register ..... 592
- Web browser  
  Configuration interface ..... 63
- Weighting filters  
  CP/ACLR ..... 168  
  MSR ACLR ..... 177  
  MSR, adjacent channels ..... 179  
  MSR, gap channels ..... 182  
  Remote ..... 648
- White noise  
  Measurement example (statistics) ..... 274
- White papers ..... 18
- White space ..... 581
- Window title bar ..... 94
- Windows  
  Adding ..... 104, 398  
  Adding (remote) ..... 767  
  Arranging ..... 105, 399  
  Closing ..... 104, 399  
  Closing (remote) ..... 769, 772  
  Layout (remote) ..... 770  
  Maximizing (remote) ..... 766  
  Querying (remote) ..... 768  
  Replacing (remote) ..... 769  
  Size ..... 105  
  Splitting (remote) ..... 766  
  Types (remote) ..... 767
- Windows 7 ..... 25  
  Access ..... 29
- WLAN  
  Application ..... 116
- WordPad  
  Accessing ..... 30
- WRONG\_FW  
  Error ..... 97, 532, 563, 1055
- X**
- X-axis  
  Adjusting (Spurious Emissions) ..... 256  
  Limit lines ..... 452  
  Scaling ..... 344, 347  
  Transducer lines ..... 552
- X-Offset  
  Limit lines ..... 449
- X-value  
  Marker ..... 409
- Y**
- Y-axis  
  Limit lines ..... 452  
  Max/Min (statistics) ..... 271  
  Optimizing display ..... 359  
  Scaling ..... 354, 359  
  Settings ..... 358
- Y-Offset  
  Limit lines ..... 450
- YIG filter  
  Channel bar ..... 93
- YIG-preselector  
  Activating/Deactivating ..... 305  
  Activating/Deactivating (remote) ..... 813
- Z**
- Zero span  
  Measurement ..... 125  
  Measurement examples ..... 139  
  Softkey ..... 348
- Zeroing  
  Power sensor ..... 309
- Zoom limits  
  Search range ..... 401  
  Using for searches ..... 415, 419
- Zooming ..... 400, 402  
  Activating (remote) ..... 836  
  Area (Multiple mode, remote) ..... 836  
  Area (remote) ..... 835  
  Deactivating ..... 402  
  Multiple mode ..... 400, 402  
  Multiple mode (remote) ..... 836, 837  
  Remote ..... 835  
  Restoring original display ..... 402  
  see User Manual ..... 106  
  Single mode ..... 400, 401  
  Single mode (remote) ..... 835