

DT4221
DT4222
DT4223
DT4224

HIOKI

Instruction Manual

DIGITAL MULTIMETER



EN

Aug. 2016 Revised edition 2
DT4221A981-02 16-08H



Contents

Introduction.....	1
Verifying Package Contents	1
Options (sold separately)	2
Safety Notes.....	3
Usage Notes.....	8

1 Overview **11**

1.1 Overview and Features.....	11
1.2 Parts Names and Functions	13
1.3 Display	18
1.4 Voltage Input Protected (DT4223, DT4224)	19
1.5 Alarm Display and Battery Indicator	20

2 Preparation for Measurements **21**

2.1 Measurement Workflow	21
2.2 Inserting/Replacing the Battery	22
2.3 Using Test Leads.....	24
2.4 Installation in Measurement Location... Hanging the instrument with the strap	27

3 Performing Measurements **29**

3.1 Inspection Before Use	29
3.2 Measuring Voltage.....	33
Measuring AC voltage.....	33
Measuring DC voltage	34
Measurement using the AC/DC automatic judgment (DT4221, DT4223)	34
3.3 Measuring Frequencies	35

3.4	Checking Continuity	36
3.5	Measuring Diode (DT4222, DT4224)	37
3.6	Measuring Resistance (DT4222, DT4223, DT4224)	38
3.7	Measuring Capacitance (DT4222, DT4224)	39
3.8	Checking the Electric Charge (DT4221, DT4223)	40

4 **Using Instrument Conveniently** **41**

4.1	Selecting the Measurement Range.....	41
	Measuring with the auto range	41
	Measuring with the manual range.....	42
4.2	Retaining the Measured Value	43
	Retaining the measured value manually (HOLD)	43
	Automatically retaining the measured value when the value stabilizes (AUTO HOLD) (DT4223, DT4224).....	44
4.3	Reducing the Noise (FILTER)	46
4.4	Checking the Relative Value/ Performing Zero Adjustment.....	48
	Checking the relative value (REL)	48
	Performing zero adjustment.....	49
4.5	Turning On the Backlight.....	51
4.6	Using the Auto Power Save (APS).....	51
4.7	Power-on Option Table	52

5 **Specifications** **55**

5.1	General Specifications	55
5.2	Electrical Characteristics	57
5.3	Accuracy Table	59

6 Maintenance and Service 65

- 6.1 Repair, Inspection, and Cleaning..... 65
- 6.2 Troubleshooting 66
- 6.3 Error Display..... 68

Appendix Appx.1

- Appx. 1 RMS and Average Appx.1

Introduction

Thank you for purchasing the Hioki DT4221, DT4222, DT4223, DT4224 Digital Multimeter. To obtain maximum performance from the product, please read this manual first, and keep it handy for future reference.

Verifying Package Contents

When you receive the instrument, inspect it carefully to ensure that no damage occurred during shipping. In particular, check the accessories, panel switches, and connectors. If damage is evident, or if it fails to operate according to the specifications, contact your authorized Hioki distributor or reseller.

Check the package contents as follows.

Instrument

(The holster has been attached.)

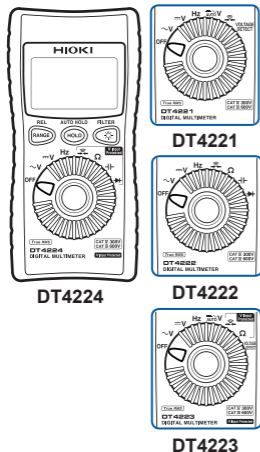

DT4911 Test Lead (p. 24)



LR03 Alkaline battery



Instruction Manual



(English)

Instruction manuals may also be available in other languages.
Please visit our website at <http://www.hioki.com>

Options (sold separately)

Options (sold separately)

The following options are available for the instrument. Contact your authorized Hioki distributor or reseller when ordering.

Connecting cables (p. 24)

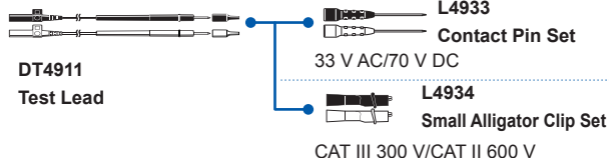

C0200 Carrying Case



The instrument, test leads, instruction manual, and others can be stored in the case.

Z5004, Z5020 Magnetic Strap (p. 27)



Attach this strap to the instrument and secure it on the wall surface such as a metal plate for use.

Safety Notes

This instrument is designed to conform to IEC 61010 Safety Standards, and has been thoroughly tested for safety prior to shipment. However, using the instrument in a way not described in this manual may negate the provided safety features.

Before using the instrument, be certain to carefully read the following safety notes.

DANGER



Mishandling during use could result in injury or death, as well as damage to the instrument. Be certain that you understand the instructions and precautions in the manual before use.

WARNING



With regard to the electricity supply, there are risks of electric shock, heat generation, fire, and arc discharge due to short circuits. If persons unfamiliar with electricity measuring instruments are to use the instrument, another person familiar with such instruments must supervise operations.

Protective gear







WARNING









To avoid electric shock when measuring live lines, wear appropriate protective gear, such as insulated rubber gloves, boots and a safety helmet.

Notation



In this manual, the risk seriousness and the hazard levels are classified as follows.

 DANGER	<p>Indicates an imminently hazardous situation that will result in death or serious injury to the operator.</p>
 WARNING	<p>Indicates a potentially hazardous situation that may result in death or serious injury to the operator.</p>
 CAUTION	<p>Indicates a potentially hazardous situation that may result in minor or moderate injury to the operator or damage to the instrument or malfunction.</p>
<p>IMPORTANT</p>	<p>Indicates information related to the operation of the instrument or maintenance tasks with which the operators must be fully familiar.</p>
	<p>Indicates a high voltage hazard. If a particular safety check is not performed or the instrument is mishandled, this may give rise to a hazardous situation; the operator may receive an electric shock, may get burnt or may even be fatally injured.</p>
	<p>Indicates a strong magnetic-field hazard. The effects of the magnetic force can cause abnormal operation of heart pacemakers and/or medical electronics.</p>
	<p>Indicates prohibited actions.</p>
	<p>Indicates the action which must be performed.</p>
<p>*</p>	<p>Additional information is presented below.</p>

Symbols affixed to the instrument

	Indicates cautions and hazards. When the symbol is printed on the instrument, refer to a corresponding topic in the Instruction Manual.
	Indicates that dangerous voltage may be present at this terminal.
	Indicates a double-insulated device.
	Indicates a grounding terminal.
	Indicates DC (Direct Current).
	Indicates AC (Alternating Current).
	Indicates DC (Direct Current) or AC (Alternating Current).

Symbols for various standards

	Indicates the Waste Electrical and Electronic Equipment Directive (WEEE Directive) in EU member states.
	Indicates that the instrument conforms to regulations set out by the EC Directive.

Screen display

This instrument uses the following screen displays.

A	B	C	D	E	F	G	H	I	J	K	L	M	N	O	P	Q	R	S	T	U	V	W	X	Y	Z
A	b	C	d	E	F	G	H		i	j	k	l	m	n	o	P	q	r	S	t	U	u	Y	y	z

1	2	3	4	5	6	7	8	9	0
1	2	3	4	5	6	7	8	9	0

Accuracy

We define measurement tolerances in terms of rdg. (reading) and dgt. (digit) values, with the following meanings:

rdg.	(Reading or displayed value) The value currently being measured and indicated on the measuring instrument.
dgt.	(Resolution) The smallest displayable unit on a digital measuring instrument, i.e., the input value that causes the digital display to show a “1” as the least significant digit.

Measurement categories

To ensure safe operation of measuring instruments, IEC 61010 establishes safety standards for various electrical environments, categorized as CAT II to CAT IV, and called measurement categories.

DANGER



- **Using a measuring instrument in an environment designated with a higher-numbered category than that for which the instrument is rated could result in a severe accident, and must be carefully avoided.**
- **Using a measuring instrument without categories in an environment designated with the CAT II to CAT IV category could result in a severe accident, and must be carefully avoided.**

This instrument conforms to the safety requirements for CAT III 600 V, CAT IV 300 V measuring instruments.

CAT II: When directly measuring the electrical outlet receptacles of the primary electrical circuits in equipment connected to an AC electrical outlet by a power cord (portable tools, household appliances, etc.)

CAT III: When measuring the primary electrical circuits of heavy equipment (fixed installations) connected directly to the distribution panel, and feeders from the distribution panel to outlets

CAT IV: When measuring the circuit from the service drop to the service entrance, and to the power meter and primary overcurrent protection device (distribution panel)

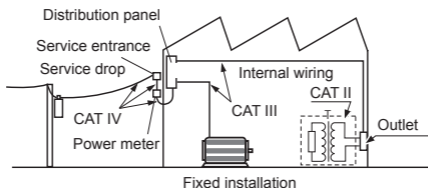

See: “2.3 Using Test Leads” (p. 24)

Usage Notes

Follow these precautions to ensure safe operation and to obtain the full benefits of the various functions.

DANGER

If the test lead or the instrument is damaged, there is a risk of electric shock. Before using the instrument, perform the following inspection.



- Before using the instrument, check that the coating of the test leads are neither ripped nor torn and that no metal parts are exposed. Using the instrument under such conditions could result in electrocution. Replace the test leads with those specified by our company.
- Before using the instrument the first time, verify that it operates normally to ensure that no damage occurred during storage or shipping. If you find any damage, contact your authorized Hioki distributor or reseller.

Installation

Installing the instrument in inappropriate locations may cause a malfunction of instrument or may give rise to an accident. Avoid the following locations.

CAUTION



- Exposed to direct sunlight or high temperature
- Exposed to corrosive or combustible gases
- Exposed to water, oil, chemicals, or solvents
- Exposed to high humidity or condensation
- Exposed to a strong electromagnetic field or electrostatic charge
- Exposed to high quantities of dust particles
- Near induction heating systems (such as high-frequency induction heating systems and IH cooking equipment)
- Susceptible to vibration

Handling the cables

WARNING

To prevent electric shock, when measuring the voltage of a power line use a test lead that satisfies the following criteria:

- Conforms to safety standards IEC61010 or EN61010
- Of measurement category III or IV
- Its rated voltage is higher than the voltage to be measured



All of the optional test leads for this instrument conform to the safety standard EN61010. Use a test lead in accordance with its defined measurement category and rated voltage.



To avoid electric shock, do not exceed the lower of the ratings shown on the instrument and test leads.

CAUTION



- Avoid stepping on or pinching the cable, which could damage the cable insulation.
- To avoid damaging the cables, do not bend or pull the leads and the probe bases.



The ends of the test leads are sharp. Be careful to avoid injury.

Precautions during measurement

WARNING

If the instrument is used in locations where the rating indicated on the instrument or probes is exceeded, the instrument may be damaged resulting in personal injury. Do not use the instrument in such locations. See “Measurement categories” (p. 7).



CAUTION

- Do not input voltage exceeding the specified measurement range. Doing so may damage the instrument.
- During the continuity check, diode test, or measurement of resistance or capacitance, measurement signals are generated in the terminals of the instrument. Depending on the target for measurement, the measurement signal may cause damage.



Seeing “Measurement current” and “Open circuit voltage” in the accuracy table (p. 59), check, in advance, that there are no adverse effects of the measurement current and the open circuit voltage.

Precautions during shipment

Observe the following during shipment. Hioki cannot be responsible for damage that occurs during shipment.

CAUTION

- During shipment of the instrument, handle it carefully so that it is not damaged due to a vibration or shock.
- To avoid damage to the instrument, remove the accessories and optional equipment from the instrument before shipment.



If the instrument is not to be used for an extended period of time

IMPORTANT

To avoid corrosion and/or damage to the instrument due to battery leakage, remove the battery from the instrument if it is to be kept in storage for an extended period.

1.1 Overview and Features

This measuring instrument is a multi-function digital multimeter that ensures both safety and durability.

Main features and functions

- Speedy display of the RMS measured value
- Environmental performance (can be used anywhere)
(Operation temperature: DT4221, DT4222: -10 to 50°C
DT4223, DT4224: -10 to 65°C)
- Filter function that controls the influence of noise
- Hold function that retains the screen display
- Solid body which can be used for an extended period of time (drop-proof)
- Speedy measurement via a fast response*
* Response time of 0 V to 100 V is approx. 0.6 seconds
(until the value falls within the accuracy specification range)
- Voltage input protection function to ensure safe measurement (DT4223, DT4224)
Protective circuitry to ensure safety in the event of voltage measurement using the continuity, resistance, capacitance, or diode range (Voltage Input Protected)
Red backlight to warn user of erroneous voltage input
- Protective circuitry operates in the event of erroneous voltage input to limit the amount of current flowing to the instrument to 1.5 mA or less.
- This safe design keeps circuit breakers from tripping and sparks from being produced at the tips of test leads.
- Although the DT4221 and DT4222 will not break if they are used to measure voltage in continuity, resistance, capacitance, or diode range, those models do not provide functionality to limit the amount of current flowing to the instrument in the event of such measurement to 1.5 mA or less, or to warn the user of erroneous voltage input by turning the backlight red.

Problem finding a suitable installation location?

The strap with magnet allows the instrument to be hung conveniently.



Large, easily-viewable display

Backlighting to allow users to read the measurement values in dark environments



For various purposes

The measurement test leads and end pins can be selected.



1.2 Parts Names and Functions

Front

Some indications are different among the models.

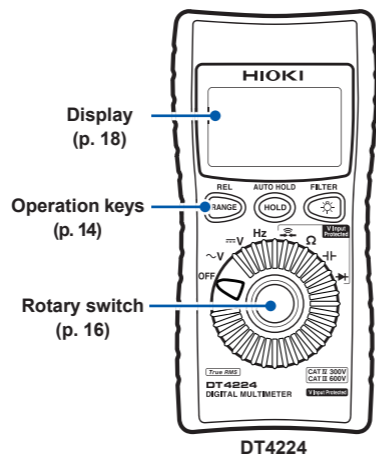

DT4224

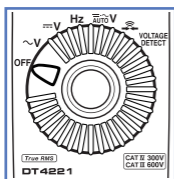

DT4221

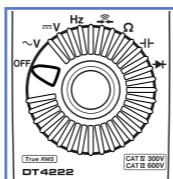

DT4222

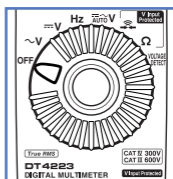



DT4223

Operation keys

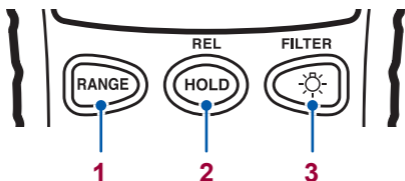
DT4221, DT4222



	Normal	Pressed down for at least 1 second	Power-on option (p. 52)
1 	Sets the manual range/switches the range.	Cancels the manual range.	All LCDs light up and the software version is displayed.
RANGE: AUTO / RANGE: MANUAL			
2 	Manually sets/cancels the hold function for the displayed value.	Sets/cancels the display of the relative value (REL).	Cancels the auto power save function (APS).
HOLD lights up/goes off.		REL lights up/goes off.	APS goes off.
3 	Turns on/off the backlight.	Switches/cancels the low pass filter and passband settings.	Turns off the automatic backlight deactivation.

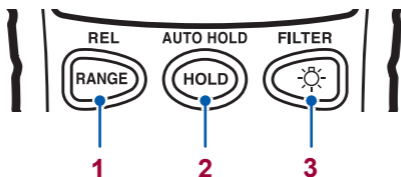

DT4223, DT4224

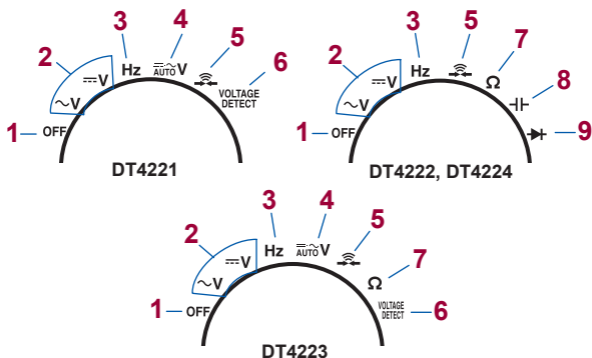

		Normal	Pressed down for at least 1 second	Power-on option (p. 52)
1		Sets the auto and manual range/ switches the range.	Sets/cancels the display of the relative value (REL).	All LCDs light up. The software version and serial number is displayed.
		RANGE:AUTO / RANGE:MANUAL		
2		Manually sets/ cancels the hold function for the displayed value.	Automatically sets/cancels the hold function for the displayed value.	Cancels the auto power save function (APS).
		HOLD lights up.	HOLD blinks.	
3		Turns on/off the backlight.	Switches/cancels the low pass filter and passband settings.	Turns off the automatic backlight deactivation.

Rotary switches and measurement descriptions



Function		DT4221	DT4222 DT4224	DT4223
1	OFF			
2	$\sim V$ AC voltage measurement	√	√	√
3	$\equiv V$ DC voltage measurement	√	√	√
4	$\equiv \sim V$ DC/AC voltage measurement (Automatic judgment)	√	-	√
5	 Continuity check	√	√	√
6	VOLTAGE DETECT Electric charge detection	√	-	√
7	Ω Resistance measurement	-	√	√
8	 Capacitance measurement	-	√	-
9	 Diode test	-	√	-

Rear

DT4224

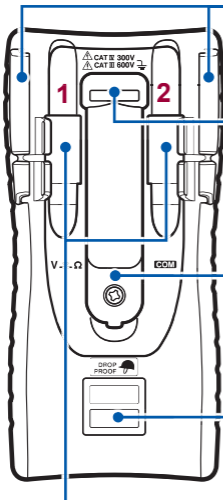
**Test lead holder**

The test lead can be held.

Strap hole

The optional Z5004, Z5020 Magnetic Strap can be attached. (p. 27)

Battery cover

When replacing the battery (p. 22), remove the cover.

⚠ (See p. 22)

Serial number label

It is necessary for production control such as product warranty.
Do not peel off the label.

Measurement terminals

⚠ (See p. 26)

- 1** The red test lead is connected.
Hereafter referred to as "V terminal".
- 2** The black test lead is connected.
Hereafter referred to as "COM terminal".

1.3 Display

For error displays, see “6.3 Error Display” (p.68).

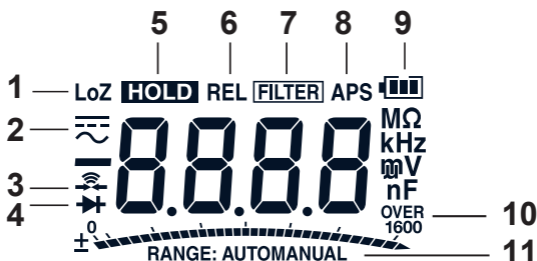

1	LoZ	AC/DC automatic judgment * ¹ When the input impedance is low for continuity/resistance/capacitance/diode.* ²	8	APS	The auto power save function is activated. (p. 51)
2		AC, DC	9		Battery indicator (p. 19)
3		Continuity check (p.36)	10		Indication (example): In the case of 30 V input in the 60 V range, the bar is displayed to the center of the scale.
4		Diode (p. 37)	RANGE: AUTOMANUAL		
5	HOLD	Retention of the measured value (p. 43)	11	Auto range, manual range (p. 41)	
6	REL	Relative value display (p. 48)	*1: DT4221		
7	FILTER	The filter function is activated. (p. 46)	*2: DT4223, DT4224		

1.4 Voltage Input Protected (DT4223, DT4224)

Erroneous voltage warning for continuity, resistance, capacitance, or diode range

The red backlight flashes to warn the user. Immediately move the test leads away from the measurement object.

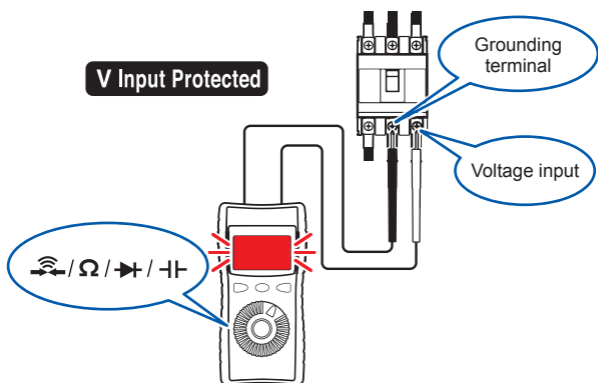

- Protective circuitry operates in the event of erroneous voltage input to limit the amount of current flowing to the instrument to 1.5 mA or less.
- This safe design keeps circuit breakers from tripping and sparks from being produced at the tips of test leads.

1.5 Alarm Display and Battery Indicator

When the measured value exceeds the maximum input range in each range



Voltage measurement

The measured value and **[OVER]** blinks.

Corrective action:

When the input exceeds the maximum rating, immediately move the test leads away from the measurement object.



Measurement other than voltage

The measured value and **[OVER]** blinks.

Battery warning indicator



Fully charged.



As the battery charge diminishes, black charge bars disappear, one by one, from the left of the battery indicator.



The battery voltage is low. Replace the battery as soon as possible.



(Blinks) The battery is exhausted. Replace the battery.

The charge is only a reference for the continuous operation time.

Power shutdown



When there is no charge, **[bAtt]** appears in the display for 3 seconds and the power is shut down.

2

Preparation for Measurements

2.1 Measurement Workflow

Before using the instrument, be sure to read “Usage Notes” (p. 8).

Installation and connection

Insert the battery. (p. 22)

Perform the startup check. (p. 29)

As necessary, have other optional items available and ready.

Measurement

Turn on the power and select the measurement function.

Attach the test leads to the measurement terminals. (p. 24)
As necessary, perform zero adjustment. (p. 49)

Connect the test leads to the measurement object.

(As necessary)

Hold the measured value. (p. 43)

To ensure safe operation, make sure to select a measurement function and then connect the test leads to the measurement object.

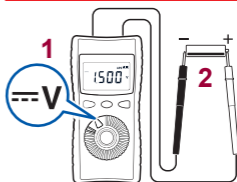

End of the measurement

Move the test leads away from the measurement object and then turn off the power.

2.2 Inserting/Replacing the Battery

Before using the instrument, insert one LR03 alkaline battery. Before measurements, check that the battery level is sufficient. When the battery charge is low, replace the battery.

Nickel-metal hydride batteries

Nickel-metal hydride batteries can be used. However, the discharge characteristic of these batteries is different from that of alkaline batteries. Be aware that the remaining battery power display does not function properly.

WARNING



To avoid electric shock, move the tips of the test leads away from the measurement object before replacing the battery.



To avoid the possibility of explosion, do not short circuit, charge, disassemble, or incinerate batteries.



After battery replacement but before using the instrument, reattach and screw down the battery cover.

CAUTION

Poor performance or damage from battery leakage could result. Observe the cautions listed below.



- Do not use old batteries.
- Be careful to observe the battery polarity during installation.
- Do not use batteries after their recommended expiry date.
- Do not allow the used battery to remain in the instrument.



- To avoid corrosion from battery leakage and/or damage to the instrument, remove the battery from the instrument if it is to be kept in storage for an extended period.

- The  indicator appears when the battery charge diminishes. Replace the battery as soon as possible. The power may be turned off when the backlight lights up or a buzzer sounds.
- After use, be sure to turn off the instrument.
- Handle and dispose of batteries in accordance with local regulations.

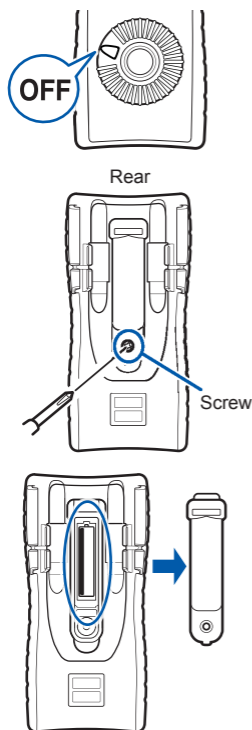

- 1** Have the following items available and ready.
 - Phillips screwdriver
 - Alkaline (LR03) battery × 1
- 2** Move the tips of the test leads away from the measurement object.
- 3** Set the rotary switch to OFF.
- 4** Using a Phillips screwdriver, remove the screw (1 location) from the battery cover on the rear of the instrument.
- 5** Remove the battery cover.
- 6** Remove the old battery.
- 7** Insert one new battery (LR03), being careful of the battery polarity.
- 8** Reattach the battery cover.
- 9** Secure the cover with the screw.

WARNING

 To prevent instrument damage or electric shock, use only the screw (M3×7.5 mm) for securing the battery cover in place that are originally installed. If you have lost a screw or find that a screw is damaged, please contact your Hioki distributor for replacement.

2.3 Using Test Leads

The DT4911 Test Leads supplied with the instrument are used for measurements. Depending on measurement locations, use our optional parts. For details on the optional items, see “Options (sold separately)” (p. 2).

WARNING

-  • To prevent a short circuit accident, be sure to use the test leads with the sleeves attached when performing measurements in the CAT III and CAT IV measurement categories. (See “Measurement categories” (p. 7))
- If the sleeves are inadvertently removed during measurement, stop the measurement.

CAUTION

-  • To ensure safe operation, use only test leads specified by our company.
- When carrying out measurements with the sleeves in place, be careful to avoid damaging the sleeves.
- The tips of the metal pins are sharp and may cause injury. Do not touch the tips.

DT4911 Test Lead

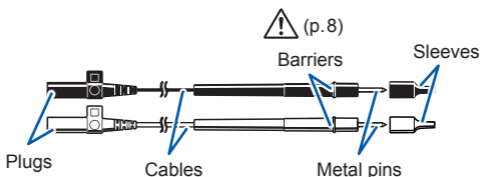

Metal pin Connect to the object to be measured.
Approx. 3 mm (sleeve attached)
Approx. 15 mm (sleeve removed)

Sleeve Attach to the metal pins to prevent short circuit accidents.

Barrier Represents the safe handling distance from the metal pins.

During measurement, do not touch the area between the barrier and the tip of the sleeve.

Plug Connect to the measurement terminals on this instrument.

Cable Double sheathed cables (Length: approx. 540 mm)

When the white portion inside the cable is exposed, replace with a new DT4911 Test Lead.

Removing and attaching the sleeves

Removing the sleeves

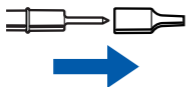

Gently hold the bottom of the sleeves and pull the sleeves off. Safely store the removed sleeves so as not to lose them.

Attaching the sleeves

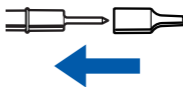

Insert the metal pins of the test leads into the holes of the sleeves, and firmly push them all the way in.

Connecting to the instrument

CAUTION



- When removing the test leads from the measurement terminals, hold the end of the plugs.
- Do not pull the cables with excessive force, as they may be broken.

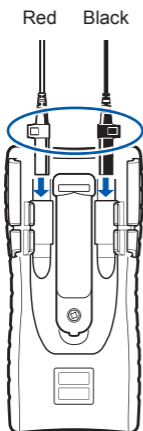

When connecting the test leads to the instrument, push them as far as possible into the measurement terminals while holding the end of the plugs.

COM terminal Connect the black test lead.
V terminal Connect the red test lead.

2.4 Installation in Measurement Location

Hanging the instrument with the strap

Attach the optional Z5004, Z5020 Magnetic Strap to the instrument and attach the magnet to the wall surface (with metal plate affixed).

DANGER



Those with medical electronics such as pacemakers should not use the Z5004, Z5020 Magnetic Strap. Nor should such persons approach the Z5004, Z5020. It is extremely dangerous. The electronics may not operate properly and the life of the operator may be put at great risk.

CAUTION



- Do not use the Z5004, Z5020 in locations where it may be exposed to rainwater, dust, or condensation. In those conditions, the Z5004, Z5020 may be decomposed or deteriorated. The magnet adhesion may be diminished. In such case, the instrument may not be hung in place and may fall.
- Do not bring the Z5004, Z5020 near magnetic media such as floppy disks, magnetic cards, pre-paid cards, or magnetized tickets. Doing so may corrupt and may render them unusable. Furthermore, if the Z5004, Z5020 is brought near precision electronic equipment such as PCs, TV screens, or electronic wrist watches, they may fail.

Example: Z5004

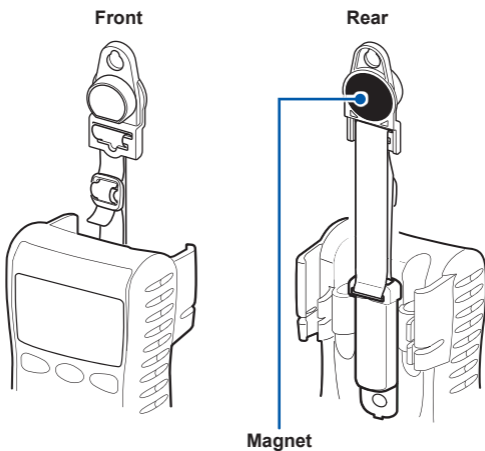
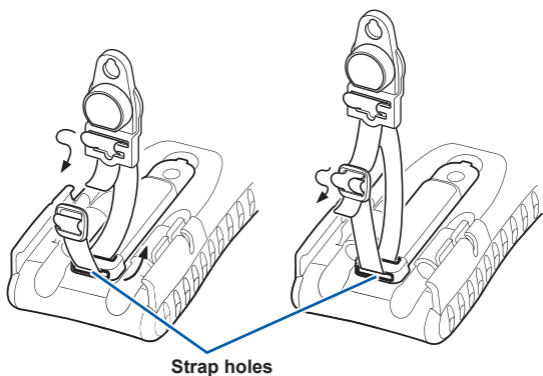

Attach it to the wall surface
(with metal plate affixed).

3

Performing Measurements

3.1 Inspection Before Use

Before using the instrument the first time, verify that it operates normally to ensure that no damage occurred during storage or shipping. If you find any damage, contact your authorized Hioki distributor or reseller.

Appearance check of the instrument and test leads

Check item	Action
The instrument is neither damaged nor cracked. The internal circuits are not exposed.	Visually check the instrument. If it is damaged, there is a risk of electric shock. Do not use the instrument but send it for repair.
The terminals are not contaminated with debris.	Remove contamination with a cotton swab.
The coating of the test leads is neither broken nor frayed, or the white portion or metal part within the lead is exposed.	If the test lead is damaged, there is a risk of electric shock. Do not use the instrument but send it for repair.

Check when turning on the power

(Set the rotary switch to any position other than OFF.)

Check item	Action
The battery voltage is sufficient.	When the  indicator appears in the top right corner of the display, the battery voltage is low. Replace the battery as soon as possible. The power may be turned off when the backlight lights up or a buzzer sounds.

Check item	Action
No indicators are missing.	Display all indicators and ensure that no indicators are missing. (p. 52) If any of the indicators are missing, send the instrument for repair.

Operation check

This section introduces some of the operation checks. Periodical calibration is necessary in order to ensure that this instrument operates according to its specifications.

1 Check that the test leads are not broken.

Check method	Action
<p>Regarding the continuity check, deliberately short circuit the test leads and then check the display.</p>  <p>For the DT4221 (The position of the rotary switch varies depending on the model.)</p>	<p>Normal: A buzzer sounds and the value stabilizes at around 0 Ω.</p> <p>Abnormal: A buzzer does not sound and a numeric value other than the above appears.</p> <p>Corrective action: The test leads may be broken. Replace with those specified by our company. If the same phenomena persist even after the test leads are replaced, a malfunction may have occurred. Halt inspection and then send the instrument for repair.</p>

2 Measure samples (such as battery, commercial power supply, and resistor) of which values have already been known, and check that the appropriate values appear.

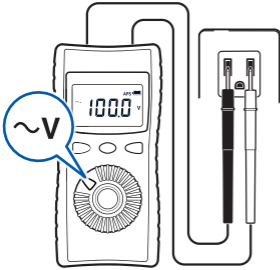
Check method	Action
<p>Example: Perform the AC voltage measurement to measure the commercial power supply, and then check the display.</p> 	<p>Normal: An already-known value appears. (In this example, the commercial voltage level should appear.)</p> <p>Abnormal: The measured value does not appear. A malfunction may have occurred. Stop the inspection and do not use the instrument.</p>

3 Check that the electric charge detection function operates normally. (DT4221, DT4223)

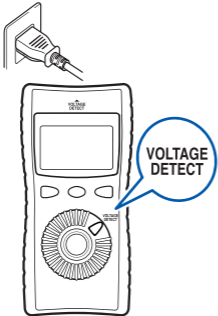
Check method	Action
<p>Position the detector on a known power supply, such as a power outlet.</p> 	<p>Normal: A buzzer sounds.</p> <p>Abnormal: A buzzer does not sound and the display does not change.</p> <p>Solution: A malfunction may have occurred. Stop the inspection and do not use the instrument.</p>

To check the electric charge properly, do not use the instrument with test leads wrapped around the instrument. The detection sensitivity of electric charge detection deteriorates.

Before measurements

WARNING

Observe the following to avoid short circuit accidents.

- Always verify the appropriate setting of the rotary switch before connecting the test leads.
- Disconnect the test leads from the measurement object before switching the rotary switch.
- Operate or connect the instrument by following the procedure of each measurement example (or procedure steps).



3.2 Measuring Voltage

AC or DC voltage measurement and measurement using the AC/DC automatic judgment (DT4221, DT4223) can be performed.

Before measurements

WARNING



If the instrument is used in locations where the rating indicated on the instrument or probes is exceeded, the instrument may be damaged resulting in personal injury. Do not use the instrument in such locations. See “Measurement categories” (p. 7).

The auto ranging function of this instrument automatically selects the optimum measurement range. To change the range arbitrarily, use the manual range. (p. 42)

Measuring AC voltage

Measure the AC voltage. The measured value is a true RMS. (p. Appx.1)

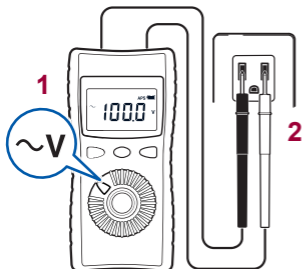

Measuring DC voltage

Measure the DC voltage.

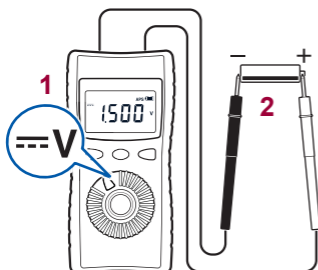

Measurement using the AC/DC automatic judgment (DT4221, DT4223)

The AC or DC are automatically judged and the voltage is measured.
(The instrument does not measure both AC and DC at the same time.)

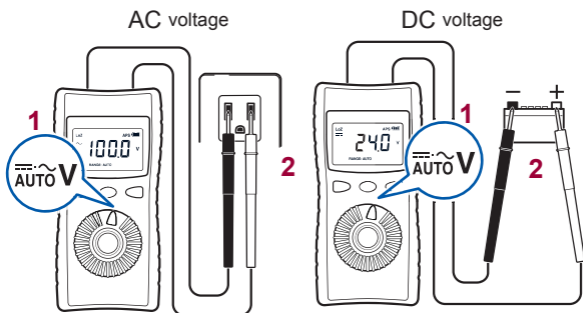

3.3 Measuring Frequencies

The frequency can be checked. The frequency display is auto ranging. The AC voltage range can be changed by pressing the RANGE key.



- If signals out of the range of frequency measurement are measured, “-----” appears. Be aware of it.
- In a measurement environment with a large amount of noise, the frequency may be displayed even with no input. This does not indicate a malfunction of the instrument.
- The sensitivity of the frequency measurement is regulated by range. (Minimum sensitivity voltage (p. 60))
When the value is less than the minimum sensitivity voltage, the indicated value may fluctuate. When the voltage range is lowered, the value stabilizes. This does not apply to cases where the value fluctuates due to noise.
- During the measurement of low frequency voltage, if the auto range does not stabilize and the frequency cannot be measured, fix the voltage range and measure again.

The frequency is measured.

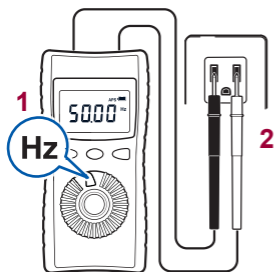

3.4 Checking Continuity

The input short circuit is detected and informed via a buzzer.

WARNING



Before measuring, be sure to turn off the power to the measurement circuit. Otherwise, electric shock may occur or the instrument may be damaged.

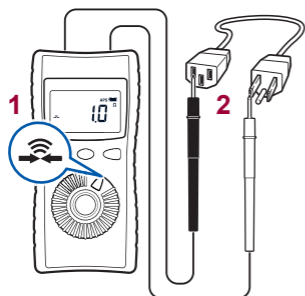

For the DT4223
(The position of the rotary switch varies depending on the model.)

Detection	Threshold	Buzzer
Short circuit detection	$25 \Omega \pm 10 \Omega$	Sounds (continuous buzzer sound)
Open detection	$245 \Omega \pm 10 \Omega$	Does not sound

3.5 Measuring Diode (DT4222, DT4224)

The forward voltage of the diode is measured. If the forward voltage is within the range from 0.15 V to 1.5 V, it is indicated via a buzzer (intermittent buzzer sound).

WARNING



Before measuring, be sure to turn off the power to the measurement circuit. Otherwise, electric shock may occur or the instrument may be damaged.

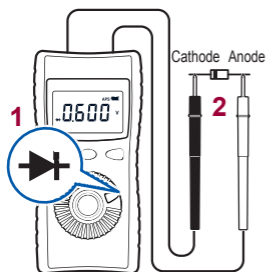

In the case of the opposite connection



The open terminal voltage is approx. 2.5 V or less.
To avoid damage to the measurement object, check the specifications of the measurement object before use.

3.6 Measuring Resistance (DT4222, DT4223, DT4224)

Resistance is measured.

To measure the low resistance accurately, it is necessary to cancel the resistance of the test leads. Perform zero adjustment for the displayed value using the relative value display (relative function) in advance.

WARNING



Before measuring, be sure to turn off the power to the measurement circuit. Otherwise, electric shock may occur or the instrument may be damaged.

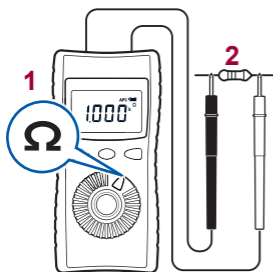

The open terminal voltage is approx. 2.0 V or less. The measurement current (DC) varies depending on the range. To avoid damage to the measurement object, check the specifications before use.

3.7 Measuring Capacitance (DT4222, DT4224)

The capacity of the capacitor is measured.

WARNING



Before measuring, be sure to turn off the power to the measurement circuit. Otherwise, electric shock may occur or the instrument may be damaged.



Do not measure the capacitor which has been charged.

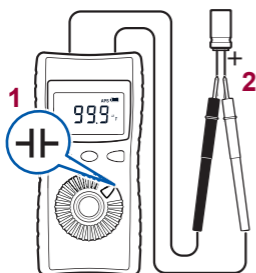

When measuring the polar capacitor

- Connect the V terminal (red test lead) to the + terminal of the capacitor and the COM terminal (black test lead) to the - terminal.
- For components on a circuit board, measurement may not be possible due to the effect of the peripheral circuit.

3.8 Checking the Electric Charge (DT4221, DT4223)

Whether a power line is energized can be checked easily. If the power line is energized, it is indicated via a buzzer and display. Use this function for coated power lines. The detection may not be made depending on the measurement conditions.

WARNING



To avoid electric shock, do not use the instrument with test leads fixed to the lead holders.

- To check the electric charge properly, do not use the instrument with test leads wrapped around the instrument. The detection sensitivity of electric charge detection deteriorates.
- Check that the detection function operates normally before use. (p. 32)

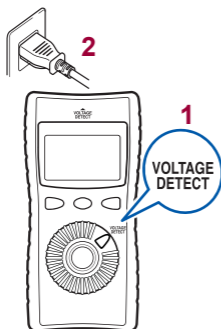

1 Select the measurement function.

2 Move the instrument close to the power line.

When the detection level is exceeded, a buzzer sounds.

Reference detection level
Reference detection level for the power line
80 V AC to 600 V AC



4

Using Instrument Conveniently

4.1 Selecting the Measurement Range

Auto or manual range can be selected. In the case of measurement where the desired range can be selected, **[RANGE:]** lights up at the bottom of the display.

- Auto range Sets the optimum range automatically in accordance with the actual measurement.
- Manual range Sets the specific range manually.
(When the relative value (REL) function is enabled, the range cannot be changed.)

Measuring with the auto range



[RANGE: AUTO] lights up.

When the measurement function is switched using the rotary switch, the auto range is enabled.

Measuring with the manual range

DT4221, DT4222

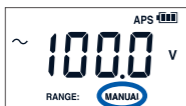

Press **RANGE**.

[RANGE: MANUAL] lights up.

Each time **RANGE** is pressed, the range is switched. When the key is pressed at the highest range, the lowest range is specified once again.

Example: When the range is 6.000 V to 600.0 V
6 V → 60 V → 600 V → 6 V

To switch from the manual range to the auto range, press **RANGE** for at least 1 second.

DT4223, DT4224



Press **RANGE**.

[RANGE: MANUAL] lights up.

Each time **RANGE** is pressed, the range is switched. When the key is pressed at the highest range, it returns to auto range.

Example: When the range is 6.000 V to 600.0 V
6 V → 60 V → 600 V → auto range → 6 V

4.2 Retaining the Measured Value

The measured value is retained. (The bar graph is updated.)

Retaining the measured value manually (HOLD)



To retain the measured value,
press **HOLD**.

(**HOLD** lights up and the measured value is retained.)

To cancel the hold state, press it again.
(**HOLD** goes off.)

Automatically retaining the measured value when the value stabilizes (AUTO HOLD) (DT4223, DT4224)

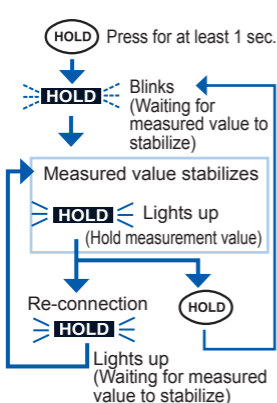

Press (HOLD) for at least 1 sec.

[HOLD] blinks, the instrument is waiting for the measured value to stabilize.)

When the measured value stabilizes, a beeping sound is generated and the value is retained.

[HOLD] lights up.)

When the test leads are moved away from the measurement object, reconnected again, and the measured value stabilizes, a beeping sound is generated and the new measured value is retained.

When (HOLD) is pressed while **[HOLD]** is lit, the instrument returns to the wait state. (**[HOLD]** blinks.)

Press (HOLD) for at least 1 second to cancel auto hold mode.

- If the input signal is too small for the relevant range, the measured value cannot be automatically retained.
- The measured value is automatically retained after it remains stable (for approx. 2 seconds) within the stable range.

Conceptual diagram (AC voltage)

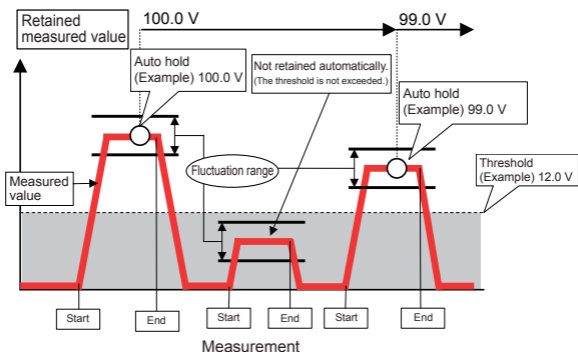

Conditions for auto holding

Measurement Function*	Fluctuation range	Threshold value
AC voltage DC voltage (excluding the 600.0 mV range)	6.000 V/ 60.00 V/ 600.0 V range: within 120 counts	6.000 V/ 60.00 V/ 600.0 V range: 120 counts
AUTO V	within 120 counts	120 counts
Resistance, Continuity	within 100 counts	4900 counts
Diode	within 40 counts	1460 counts

* The auto hold function only operates for the listed measurement functions.

4.3 Reducing the Noise (FILTER)

WARNING



To avoid electric shock or other personal injury, select the appropriate passband setting when measuring the AC voltage. If an inappropriate frequency is selected, the measured value displayed will not be correct.

The influence of high-frequency noise can be reduced with the low pass filter (digital filter).

This function can be used when measuring the AC voltage and the AC/DC automatic judgment.

The passband setting for the low pass filter can be selected.

Example 1 (FILTER: OFF)



Press  for at least 1 second.

(Current FILTER setting is displayed.)

Example 2 (FILTER: 100 Hz)



Each time  is pressed while the current FILTER setting is displayed, the passband setting is changed.

[OFF] → [100 Hz] → [500 Hz] → [OFF]

- When the desired passband setting is displayed for 2 seconds, the setting is applied and then the measurement display reappears.
- If the FILTER setting is changed, the relative value function (REL) will be canceled.

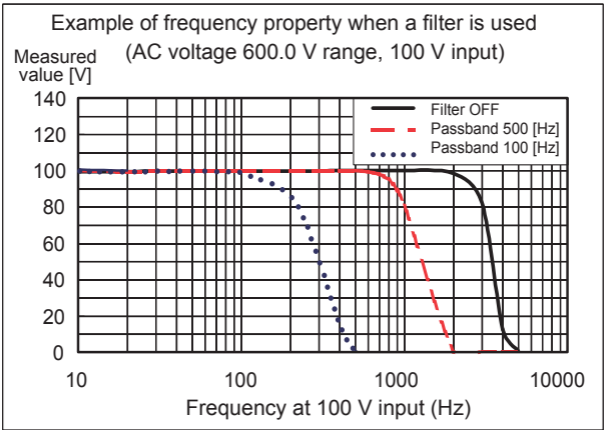

Example: Power frequency on an aircraft or marine vessel is 400 Hz
 When voltage is 100 V

	FILTER setting	Displayed value
Normal	OFF	Approx. 100 V
	500 Hz	
Abnormal	100 Hz	Around 0 V

4.4 Checking the Relative Value/ Performing Zero Adjustment

The relative value comparing to the standard value can be checked (relative function).

It can also be used as the zero adjustment function.

Zero adjustment eliminates the influences of the test lead wiring resistance (continuity, resistance measurement) and the wiring capacity (capacitor measurement).

- When the following measurement function is selected, this function is disabled.

AUTO V, Frequency, Diode, Electric charge detection

- The DT4223 and DT4224 can display relative values for frequency input.

Checking the relative value (REL)

Example 1: DC voltage measurement

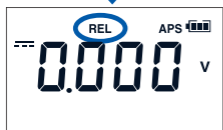
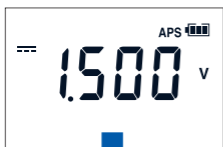

For the DT4221, DT4222

When the standard value is measured, press **HOLD** for at least 1 second.

For the DT4223, DT4224

When the standard value is measured, press **RANGE** for at least 1 second.

[REL] lights up.

The relative value is displayed.



To cancel the state, press it for at least 1 second again.

([REL] goes off.)

Performing zero adjustment

When performing zero adjustment, the condition of the test leads varies depending on the measurement function.

Perform zero adjustment, referring to the table below.

Measurement function	V, Ω , 	
Condition of the test leads	Short circuit	Open

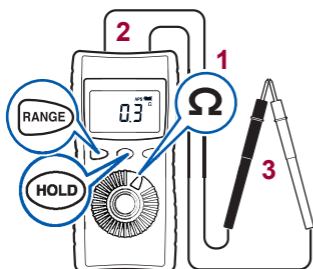

Example 1:

Resistance measurement
(DT4222, DT4223, DT4224)

- 1** Select the measurement function.
- 2** Connect the test leads to the measurement terminals.
- 3** Allow the test leads to short circuit.

DT4222: Press **HOLD** for at least 1 second.

DT4223, DT4224: Press **RANGE** for at least 1 second.

(After zero adjustment: 0.0 Ω)

- 4** Measure the resistance.

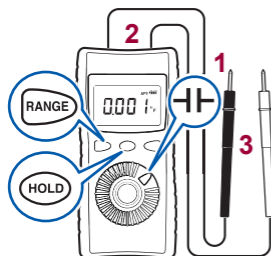

Example 2:
Capacitor measurement
(DT4222, DT4224)

- 1** Select the measurement function.
- 2** Connect the test leads to the measurement terminals.
- 3** Allow the test leads to open.

DT4222: Press **HOLD** for at least 1 second.

DT4224: Press **RANGE** for at least 1 second.

(After zero adjustment: 0.000 μ F)

- 4** Measure the capacitor.

4.5 Turning On the Backlight

The backlight can be turned on/off by pressing  .

The backlight automatically turns off if the instrument is not operated for 40 seconds.

The automatic backlight deactivation function can be disabled. (p. 52)

4.6 Using the Auto Power Save (APS)

The auto power save function saves on battery consumption. If the instrument has not been operated for 15 minutes, it enters the sleep mode. When the sleep mode continues for approx. 45 minutes, the power turns off automatically.

In the default setting, the auto power save function is set to enabled. (**APS** lights up.)

It is also possible to disable the auto power save function. At 30 seconds before the instrument enters the sleep mode, the APS blinks to indicate its status. To continuously use the instrument, press any key or turn the rotary switch.

Auto power save function

- When the instrument is in the sleep mode, press any key or turn the rotary switch to recover from the sleep mode.
- If the instrument will be used for an extended period of time, disable the auto power save function. (p.52)
- After use, set the rotary switch to OFF. The sleep mode consumes a small amount of current.









Recovering from a power shutdown









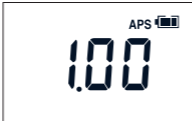

Set the rotary switch to OFF and turn on the power again.

4.7 Power-on Option Table

The settings in the instrument can be changed or checked. When the operation key is released after changing the setting, the regular display then reappears.

- +  Turn on the power while pressing the operation key.
(Turn the rotary switch from OFF.)

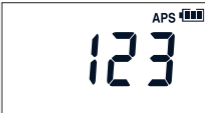
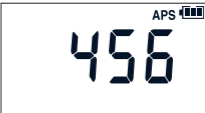



Setting change	Method
Canceling the auto power save function (APS)	<p> +  (APS goes off.) (See p. 51)</p> <p>The APS and OFF displays are shown alternately.</p> <div style="display: flex; justify-content: space-around;"> <div style="border: 1px solid black; padding: 5px; text-align: center;">  </div> <div style="border: 1px solid black; padding: 5px; text-align: center;">  </div> </div> <p>When the power is turned off, the settings are disabled.</p>
Disabling the automatic backlight deactivation	<p> +  (See p. 51)</p> <p>The backlight-auto and OFF displays are shown alternately.</p> <div style="display: flex; justify-content: space-around;"> <div style="border: 1px solid black; padding: 5px; text-align: center;">  </div> <div style="border: 1px solid black; padding: 5px; text-align: center;">  </div> </div> <ul style="list-style-type: none"> • When the power is turned off, the settings are disabled. (DT4221, DT4222) • The setting is retained even if the instrument is turned off. To enable the setting again, repeat the same action. (DT4223, DT4224)

Setting change	Method
<p>Checking the software version</p>	<p> +  (First position from OFF)</p> <div style="display: flex; align-items: center; justify-content: center;"> <div style="border: 1px solid black; padding: 5px; text-align: center;">  </div> <div style="margin-left: 20px;">Example: Ver 1.00</div> </div>
<p>Displaying all indicators</p>	<p> +  (Second position from OFF)</p> <p>Check that there are no missing indicators. If any indicator is missing, stop using the instrument and send it for repair.</p> <div style="text-align: center;">  </div>
<p>Displaying the serial number</p>	<p> +  (Third position from OFF)</p> <p>The 9-digit serial number is displayed 3 digits at a time. Example: 123456789</p> <div style="display: flex; flex-wrap: wrap; justify-content: center; align-items: center;"> <div style="border: 1px solid black; padding: 5px; text-align: center; margin: 5px;">  </div> <div style="margin: 0 10px;">→</div> <div style="border: 1px solid black; padding: 5px; text-align: center; margin: 5px;">  </div> <div style="margin: 0 10px;">↓</div> <div style="border: 1px solid black; padding: 5px; text-align: center; margin: 5px;">  </div> <div style="margin: 0 10px;">←</div> <div style="border: 1px solid black; padding: 5px; text-align: center; margin: 5px;">  </div> <div style="margin: 0 10px;">↑</div> </div>

5

Specifications

5.1 General Specifications

Power supply	LR03 Alkaline battery × 1
Battery indicator warning voltage	<ul style="list-style-type: none"> •  lights up. 1.4 V or more^{*1,*2} •  lights up. Less than 1.3 V to 1.4 V^{*1,*2} •  lights up. Less than 1.2 V to 1.3 V^{*1} Less than 1.15 V to 1.3 V^{*2} •  blinks. Less than 1.15 V to 1.2 V^{*1} Less than 1.05 V to 1.15 V^{*2} • Power shutdown Less than 1.15 V^{*1} Less than 1.05 V^{*2} <p>*1: ±0.2 V (DT4221, DT4222) *2: ±0.15 V (DT4223, DT4224)</p>
Dimensions	Approx. 72W × 149H × 38D mm (2.83"W × 5.87"H × 1.50"D) (including the holster and rotary switch)
Mass	Approx. 190 g (6.7 oz.) (including the battery and holster)
Operating environment	Indoors, pollution degree 2, altitude up to 2000 m (6562 ft.)
Operating temperature and humidity	<ul style="list-style-type: none"> • Temperature <ul style="list-style-type: none"> –10°C to 50°C (14°F to 122°F) (DT4221, DT4222) –10°C to 65°C (14°F to 149°F) (DT4223, DT4224) • Humidity <ul style="list-style-type: none"> –10°C to 40°C (14°F to 104°F): 80% RH or less (no condensation) 40°C to 45°C (104°F to 113°F): 60% RH or less (no condensation) 45°C to 65°C (113°F to 149°F): 50% RH or less (no condensation)

General Specifications

Storage temperature and humidity	-30°C to 60°C (-22°F to 140°F) (DT4221, DT4222) -30°C to 70°C (-22°F to 158°F) (DT4223, DT4224) 80% RH or less (no condensation)
Dust-proof and water-proof	IP42 (EN60529)
Drop-proof distance	1 m on concrete (with the holster attached)
Product warranty period	3 years (excluding the measurement accuracy)
Accessories	<ul style="list-style-type: none">• DT4911 Test Lead• Holster (attached to the instrument, with a test lead holder)• Instruction Manual• LR03 Alkaline battery × 1 (not installed in the instrument)
Options	See: “Options (sold separately)” (p. 2)
Standards	<ul style="list-style-type: none">• Safety: EN61010• EMC: EN61326

5.2 Electrical Characteristics

Noise suppression NMRR	<ul style="list-style-type: none"> • DCV: -60 dB or more (50 Hz/60 Hz)
Noise suppression CMRR	<ul style="list-style-type: none"> • DCV: -100 dB or more (DC/50 Hz/60 Hz, 1 kΩ unbalance) • ACV: -60 dB or more (DC/50 Hz/60 Hz, 1 kΩ unbalance)
Response time (Auto range)	<ul style="list-style-type: none"> • Power ON time: Within 2 seconds (When the range does not move until the measured value is displayed on the LCD screen) • DCV: 0.7 to 0.8 seconds (0 V \rightarrow 100 V auto range operation)^{*1} • ACV: 0.6 to 0.7 seconds (0 V \rightarrow 100 V auto range operation)^{*1} • Ω: 1.0 to 1.1 seconds (Infinity \rightarrow 0 Ω auto range operation)^{*1} • Continuity: Open circuit or short circuit is detected for at least 0.5 ms.^{*1,*3} Open circuit or short circuit is detected for at least 600 ms.^{*1,*4}
Display update rate	<ul style="list-style-type: none"> • Measured value: 5 times/s (excluding capacitance and frequency after the range is fixed)^{*2} 0.05 to 5 times/s (varies depending on the capacitance)^{*2} 1 to 2 times/s (frequency)^{*2} • Bar graph: Updated 40 times/s
Maximum rated voltage between terminals	600 V DC/AC or 3×10^6 V \cdot Hz

Maximum rated voltage between measurement terminals and ground	600 V AC (Measurement category III) 300 V AC (Measurement category IV) Anticipated transient overvoltage: 6000 V
Rated power voltage	1.5 V DC × 1 LR03 Alkaline battery × 1
Maximum rated power	220 mVA Power voltage 1.5 V, continuity measurement input short-circuited, backlight lit
Rated power	<ul style="list-style-type: none"> • 36 mVA +20% or less Power voltage 1.5 V, DCV measurement, backlight off • 6 mVA +20% or less Power voltage 1.5 V, auto power save function activated
Continuous operating time	LR03 alkaline battery Backlight off: Approx. 40 hours* ³ Approx. 35 hours* ⁴

*1: Until the values stabilize within the accuracy specification range.

*2: Measured within the measurement range (excluding range movement).

*3: DT4221, DT4222

*4: DT4223, DT4224

5.3 Accuracy Table

Accuracy warranty period	1 year
Regulated power supply range	Until the power shutdown (1.15 V \pm 0.2 V) (DT4221, DT4222) Until the power shutdown (1.05 V \pm 0.15 V) (DT4223, DT4224)
Accuracy guarantee for temperature and humidity	23°C \pm 5°C (73°F \pm 9°F), 80%RH or less (no condensation)
Temperature characteristic	<ul style="list-style-type: none"> • “Measurement accuracy \times 0.1/°C” is added (excluding 23°C\pm5°C (73°F\pm9°F)). • For resistance 60.00 MΩ range, “Measurement accuracy \times 0.4/°C” is added (excluding 23°C\pm5°C (73°F\pm9°F)). (only the DT4222)

- rdg. (reading or displayed value): The value currently being measured and displayed on the measuring instrument.
- dgt. (resolution): The smallest displayable unit, i.e., the input value that causes the digital display to show a “1” as the least significant digit.

1 AC voltage

Range	Accuracy* ¹		Input impedance
	40 to 500 Hz	Over 500 Hz to 1 kHz	
6.000 V	\pm 1.0% rdg. \pm 3 dgt.	\pm 2.5% rdg. \pm 3 dgt.	11.2 M Ω \pm 2.0% 100 pF or less
60.00 V	\pm 1.0% rdg. \pm 3 dgt.	\pm 2.0% rdg. \pm 3 dgt.	10.3 M Ω \pm 2.0% 100 pF or less
600.0 V	\pm 1.0% rdg. \pm 3 dgt.	\pm 2.0% rdg. \pm 3 dgt.	10.2 M Ω \pm 1.5% 100 pF or less

- Overload protection: 660 V DC/660 V AC or 3×10^6 V \cdot Hz (energized for 1 minute) (DT4221, DT4222)
- Overload protection: 750 V DC/750 V AC or 3×10^6 V \cdot Hz (energized for 1 minute) (DT4223, DT4224)
- Transient overvoltage: 6000 V

Accuracy Table

- Crest factor: The crest factor is 3 up to 4000 counts and reduces linearly to 2 at 6000 counts.
- Connection method: AC coupling
- Auto range movement threshold: 6,000 counts or more for upper range, 540 counts or less for lower range
- *1: The accuracy is specified in 1% or more of the range, however, ± 5 dgt. should be added to 5% or less of the range.
- Accuracy guarantee range for frequency: 40 Hz to 1 kHz (Measured values outside the accuracy guarantee range for frequency are also displayed.) The accuracy is not specified for strain waveforms outside the range of 40 Hz to 1 kHz.
- For 100 Hz with the filter ON, $\pm 1.5\%$ rdg. is added to the accuracy specification between 40 Hz and 100 Hz and the accuracy is not specified in 100 Hz or more.
- For 500 Hz with the filter ON, $\pm 0.5\%$ rdg. is added to the accuracy specification between 40 Hz and 500 Hz and the accuracy is not specified in 500 Hz or more.

2 Frequency

Range	Accuracy
99.99 Hz	$\pm 0.1\%$ rdg. ± 2 dgt.
999.9 Hz	$\pm 0.1\%$ rdg. ± 2 dgt.
9.999 kHz	$\pm 0.1\%$ rdg. ± 2 dgt.

- Auto range movement threshold: 9999 counts or more for upper range, 900 counts or less for lower range.

Frequency minimum sensitivity voltage (sine wave)

Range	Measurement range	AC voltage range		
		6.000 V	60.00 V	600.0 V
99.99 Hz	5.00 Hz to 99.99 Hz ^{*1}	0.600 V or more	6.00 V or more	60.0 V or more
999.9 Hz	100.0 Hz to 999.9 Hz	0.600 V or more	6.00 V or more	60.0 V or more

Range	Measurement range	AC voltage range		
		6.000 V	60.00 V	600.0 V
9.999 kHz	1.000 kHz to 9.999 kHz	0.600 V or more	6.00 V or more	60.0 V or more

- The input is up to $3 \times 10^6 \text{ V} \cdot \text{Hz}$.
 - “-----” appears when no measurement can be made.
- *1: The measurement range from 5.00 Hz is only for the 6.000 V range.
The measurement range for other voltage ranges is 40.00 Hz to 99.99 Hz.

3 DC voltage

Range	Accuracy	Input impedance
600.0 mV	$\pm 0.5\%$ rdg. ± 5 dgt.	$11.2 \text{ M}\Omega \pm 2.0\%$
6.000 V	$\pm 0.5\%$ rdg. ± 5 dgt.	$11.2 \text{ M}\Omega \pm 2.0\%$
60.00 V	$\pm 0.5\%$ rdg. ± 5 dgt.	$10.3 \text{ M}\Omega \pm 2.0\%$
600.0 V	$\pm 0.5\%$ rdg. ± 5 dgt.	$10.2 \text{ M}\Omega \pm 1.5\%$

- Overload protection: 660 V DC/660 V AC or $3 \times 10^6 \text{ V} \cdot \text{Hz}$ (energized for 1 minute) (DT4221, DT4222)
- Overload protection: 750 V DC/750 V AC or $3 \times 10^6 \text{ V} \cdot \text{Hz}$ (energized for 1 minute) (DT4223, DT4224)
- Auto range movement threshold: 6000 counts or more for upper range, 540 counts or less for lower range.

4 AUTO V

Range	Accuracy* ¹		Input impedance
	DC, 40 to 500 Hz	Over 500 Hz to 1 kHz	
600.0 V	$\pm 2.0\%$ rdg. ± 3 dgt.	$\pm 4.0\%$ rdg. ± 3 dgt.	$900 \text{ k}\Omega \pm 20\%$

- Overload protection: 660 V DC/660 V AC or $3 \times 10^6 \text{ V} \cdot \text{Hz}$ (energized for 1 minute) (DT4221, DT4222)
- Overload protection: 750 V DC/750 V AC or $3 \times 10^6 \text{ V} \cdot \text{Hz}$ (energized for 1 minute) (DT4223, DT4224)

Accuracy Table

- Transient overvoltage: 6000 V
- Crest factor: The crest factor is 3 up to 4000 counts and reduces linearly to 2 at 6000 counts.
- Connection method: DC coupling
- *1: For AC voltage, the accuracy is specified in 1% or more of the range, however, ± 5 dgt. should be added to 5% or less of the range.
- Accuracy guarantee range for frequency: 40 Hz to 1 kHz (Measured values outside the accuracy guarantee range for frequency are also displayed.)
The accuracy is not specified for strain waveforms outside the range of 40 Hz to 1 kHz.
- For 100 Hz with the filter ON, $\pm 1.5\%$ rdg. is added to the accuracy specification between 40 Hz and 100 Hz and the accuracy is not specified in 100 Hz or more.
- For 500 Hz with the filter ON, $\pm 0.5\%$ rdg. is added to the accuracy specification between 40 Hz and 500 Hz and the accuracy is not specified in 500 Hz or more.

5 Continuity

Range	Accuracy	Measurement current
600.0 Ω	$\pm 1.0\%$ rdg. ± 5 dgt.	200 μ A $\pm 20\%$

- Open circuit voltage: 1.8 V DC or less (DT4221, DT4222)
2.0 V DC or less (DT4223, DT4224)
- Overload protection: 600 V DC/600 V AC or 3×10^6 V \cdot Hz (energized for 1 minute)
Current under overload: Steady state 15 mA or less, transient state 0.8 A or less (DT4221, DT4222)
- Overload protection: 750 V DC/750 V AC or 3×10^6 V \cdot Hz (energized for 1 minute)
Current under overload: 1.5 mA or less (DT4223, DT4224)
- Continuity ON threshold: 25 $\Omega \pm 10 \Omega$ (continuous buzzer sound)
- Continuity OFF threshold: 245 $\Omega \pm 10 \Omega$
- Accuracy guarantee condition: After zero adjustment has been performed

6 Resistance

Range	Accuracy	Measurement current
600.0 Ω	$\pm 0.9\%$ rdg. ± 5 dgt.	200 $\mu\text{A} \pm 20\%$
6.000 k Ω	$\pm 0.9\%$ rdg. ± 5 dgt.	100 $\mu\text{A} \pm 20\%$
60.00 k Ω	$\pm 0.9\%$ rdg. ± 5 dgt.	10 $\mu\text{A} \pm 20\%$
600.0 k Ω	$\pm 0.9\%$ rdg. ± 5 dgt.	1 $\mu\text{A} \pm 20\%$
6.000 M Ω	$\pm 0.9\%$ rdg. ± 5 dgt.	100 nA $\pm 20\%$
60.00 M Ω	$\pm 1.5\%$ rdg. ± 5 dgt.	10 nA $\pm 20\%$

- Open circuit voltage: 1.8 V DC or less (DT4221, DT4222)
2.0 V DC or less (DT4223, DT4224)
- Overload protection: 600 V DC/600 V AC or 3×10^6 V \cdot Hz (energized for 1 minute)
Current under overload: Steady state 15 mA or less, transient state 0.8 A or less (DT4221, DT4222)
- Overload protection: 750 V DC/750 V AC or 3×10^6 V \cdot Hz (energized for 1 minute)
Current under overload: 1.5 mA or less (DT4223, DT4224)
- Maximum capacity load: 10 mF
- Maximum inductive load: 10 H
- Accuracy guarantee condition: After zero adjustment has been performed
- Auto range movement threshold: 6000 counts or more for upper range.
Switches to the high impedance 60.00 M Ω range when the test leads are open, regardless of the range.
540 counts or less for lower range.

7 Capacitance

Range	Accuracy	Charging current
1.000 μF	$\pm 1.9\%$ rdg. ± 5 dgt.	10 n/100 n/1 $\mu\text{A} \pm 20\%$
10.00 μF	$\pm 1.9\%$ rdg. ± 5 dgt.	100 n/1 μ /10 $\mu\text{A} \pm 20\%$
100.0 μF	$\pm 1.9\%$ rdg. ± 5 dgt.	1 μ /10 μ /100 $\mu\text{A} \pm 20\%$
1.000 mF	$\pm 1.9\%$ rdg. ± 5 dgt.	10 μ /100 μ /200 $\mu\text{A} \pm 20\%$
10.00 mF	$\pm 5.0\%$ rdg. ± 20 dgt.	100 μ /200 $\mu\text{A} \pm 20\%$

- Open circuit voltage: 1.8 V DC or less (DT4221, DT4222)
2.0 V DC or less (DT4223, DT4224)

Accuracy Table

- Overload protection: 600 V DC/600 V AC or $3 \times 10^6 \text{ V} \cdot \text{Hz}$ (energized for 1 minute)
Current under overload: Steady state 15 mA or less, transient state 0.8 A or less (DT4221, DT4222)
- Overload protection: 750 V DC/750 V AC or $3 \times 10^6 \text{ V} \cdot \text{Hz}$ (energized for 1 minute)
Current under overload: 1.5 mA or less (DT4223, DT4224)
- Maximum count for each range: 1100 (1000 for 10.00 mF)
- Auto range movement threshold: 1100 counts or more for upper range, 100 counts or less for lower range.
Switches to the high impedance 1.000 μF range when the test leads are open, regardless of the range.

8 Diode

Range	Accuracy	Measurement current	Open circuit voltage
1.500 V	$\pm 0.9\%$ rdg. ± 5 dgt.	0.5 mA $\pm 20\%$ (DT4221, DT4222) 0.2 mA $\pm 20\%$ (DT4223, DT4224)	2.5 V DC or less Voltage drop due to battery consumption

- Overload protection: 600 V DC/600 V AC or $3 \times 10^6 \text{ V} \cdot \text{Hz}$ (energized for 1 minute)
Current under overload: Steady state 15 mA or less, transient state 0.8 A or less (DT4221, DT4222)
- Overload protection: 750 V DC/750 V AC or $3 \times 10^6 \text{ V} \cdot \text{Hz}$ (energized for 1 minute)
Current under overload: 1.5 mA or less (DT4223, DT4224)
- During the forward connection, an intermittent buzzer sounds (threshold: 0.15 V to 1.5 V).
- A continuous buzzer sounds at 0.15 V or less.

9 Electric charge detection

Detection voltage range* ¹	Detection target frequency
80 V AC to 600 V AC	50 Hz/60 Hz

- During voltage detection, a continuous buzzer sounds.

*1: In contact with the insulated wire that is equivalent to $1\text{V}2 \text{ mm}^2$.

6.1 Repair, Inspection, and Cleaning

DANGER



Customers are not allowed to modify, disassemble, or repair the instrument.

Doing so may cause fire, electric shock, or injury.

Calibrations

IMPORTANT

Periodic calibration is necessary in order to ensure that the instrument provides correct measurement results of the specified accuracy.

The calibration frequency varies depending on the status of the instrument or installation environment. We recommend that the calibration frequency is determined in accordance with the status of the instrument or installation environment and that you request that calibration be performed periodically.

Cleaning

- To clean the instrument, wipe it gently with a soft cloth moistened with water or mild detergent.
- Wipe the display gently with a soft, dry cloth.

IMPORTANT

Never use solvents such as benzene, alcohol, acetone, ether, ketones, thinners or gasoline, as they can deform and discolor the case.

Disposal

Handle and dispose of the instrument in accordance with local regulations.

6.2 Troubleshooting

- When a malfunction of the instrument is suspected, check the information in “Before sending the instrument for repair” and then, if necessary, contact your authorized Hioki distributor or reseller.
- When sending the instrument for repair, remove the battery and pack it carefully to prevent damage during transportation. Include cushioning material so the instrument cannot move within the package. Be sure to include details of the problem. Hioki cannot be responsible for damage that occurs during transportation.

Before sending the instrument for repair

Question	Solution
Can zero adjustment be performed?	Using the relative value display function, zero adjustment can be performed. (p. 49)
Can rechargeable batteries be used?	Rechargeable batteries can be used. However, the discharge characteristic of these batteries is different from that of alkaline batteries. Be aware that the remaining battery power display does not function properly.

Symptom	Check and/or corrective action
<p>Nothing appears in the display.</p> <p>Or the display disappears after a short time.</p>	<p>Check that the battery is not exhausted. Replace with a new battery. (p. 22)</p> <p>Check that the auto power save function has not been activated. Check the setting of the auto power save function. (p. 51)</p>
<p>The measurement value does not appear.</p> <p>Even after the measurement, 0 (zero) still appears.</p> <p>Even after short circuit of the probe, the measured value does not appear.</p> <p>Zero adjustment is not possible.</p>	<p>Check that the test lead is not broken. Perform the continuity check to confirm the continuity of the test leads. (p. 30)</p> <p>If the test lead is broken, replace the lead.</p> <p>Check that the test leads have been inserted at the ends.</p> <p>Check that the measurement method is correct.</p> <p>If no problems have been found, the instrument may be malfunctioning. Send the instrument for repair.</p>
<p>The display does not stabilize and the value fluctuates; it is difficult to read the value.</p>	<p>Check that the input signal is within the input range for the instrument.</p> <p>If there is any influence from noise, use the filter function of the instrument. (p. 46)</p>
<p>Turning on the power brings up the error display.</p> <p>When nothing is connected, the error display appears.</p>	<p>Reset the instrument. If the same symptom still occurs even after resetting the instrument, send the instrument for repair.</p>

6.3 Error Display

Error display	Description	Solution
Err 1	ROM error Program	When the error appears in the display, it is necessary to repair the instrument. Contact your authorized Hioki distributor or reseller.
Err 2	ROM error Adjustment data	
Err 4	EEPROM error Memory data	
Err 5	ADC error Hardware malfunction	

Appendix

Appx. 1 RMS and Average

Difference between the RMS and Average

When converting AC to RMS, 2 methods are available, “True RMS method (True RMS indication)” and “Average method (Average rectifying RMS indication)”.

In the case of the sine wave where no skew is included, the same values are indicated in both methods. However, if the waveform is skewed, a difference occurs between the 2 methods.

The true RMS method is applied to this instrument.

In the true RMS method, the high frequency component is also included and displayed.

In the average method, the input waveform is handled as a sine wave where no skew is included (only single frequency).

The average of the AC signal is obtained, converted to the RMS, and then displayed. If the waveform is skewed, a greater measurement error occurs.

Measurement example	True RMS	Average rectifying
100 V sine wave	100 V	100 V
100 V square wave	100 V	111 V

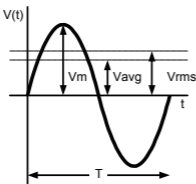

Sine wave

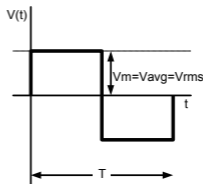

Square wave

V_m : Maximum value, V_{avg} : Average value, V_{rms} : RMS, T : Time period

Warranty Certificate

HIOKI

Model	Serial No.	Warranty period Three (3) years from date of purchase (__ / __)
-------	------------	--

This product passed a rigorous inspection process at Hioki before being shipped.

In the unlikely event that you experience an issue during use, please contact the distributor from which you purchased the product, which will be repaired free of charge subject to the provisions of this Warranty Certificate. This warranty is valid for a period of three (3) years from the date of purchase. If the date of purchase is unknown, the warranty is considered valid for a period of three (3) years from the product's date of manufacture. Please present this Warranty Certificate when contacting the distributor. Accuracy is guaranteed for the duration of the separately indicated guaranteed accuracy period.

1. Malfunctions occurring during the warranty period under conditions of normal use in conformity with the Instruction Manual, product labeling (including stamped markings), and other precautionary information will be repaired free of charge, up to the original purchase price. Hioki reserves the right to decline to offer repair, calibration, and other services for reasons that include, but are not limited to, passage of time since the product's manufacture, discontinuation of production of parts, or unforeseen circumstances.
2. Malfunctions that are determined by Hioki to have occurred under one or more of the following conditions are considered to be outside the scope of warranty coverage, even if the event in question occurs during the warranty period:
 - a. Damage to objects under measurement or other secondary or tertiary damage caused by use of the product or its measurement results
 - b. Malfunctions caused by improper handling or use of the product in a manner that does not conform with the provisions of the Instruction Manual
 - c. Malfunctions or damage caused by repair, adjustment, or modification of the product by a company, organization, or individual not approved by Hioki
 - d. Consumption of product parts, including as described in the Instruction Manual
 - e. Malfunctions or damage caused by transport, dropping, or other handling of the product after purchase
 - f. Changes in the product's appearance (scratches on its enclosure, etc.)
 - g. Malfunctions or damage caused by fire, wind or flood damage, earthquakes, lightning, power supply anomalies (including voltage, frequency, etc.), war or civil disturbances, radioactive contamination, or other acts of God
 - h. Damage caused by connecting the product to a network
 - i. Failure to present this Warranty Certificate
 - j. Failure to notify Hioki in advance if used in special embedded applications (space equipment, aviation equipment, nuclear power equipment, life-critical medical equipment or vehicle control equipment, etc.)
 - k. Other malfunctions for which Hioki is not deemed to be responsible

***Requests**

- Hioki is not able to reissue this Warranty Certificate, so please store it carefully.
- Please fill in the model, serial number, and date of purchase on this form.

16-01 EN

--	--