

MILITARY COTS

VITA 62 COMPLIANT POWER SUPPLY

18V - 40V Continuous Input Voltage	Input EMI Filtering	6 Outputs	500W Maximum Output Power	91% Typical Efficiency
--	----------------------------	---------------------	-------------------------------------	----------------------------------

Operation: -40 °C to 85 °C (at card edges)



VPX Features

◆ Outputs:

VS1: +12V @ 40A = 480W
 VS2: +3.3V @ 25A = 82.5W
 VS3: +5.0V @ 30A = 150W
 (AUX) +3.3V_{AUX} @ 6A = 20W
 (AUX) +12V_{AUX} @ 1A = 12W
 (AUX) -12V_{AUX} @ 1A = 12W

◆ Maximum Total Output Power: 500W

◆ Input EMI Filtering

◆ -40 °C to 85 °C Operating Temperature (at card edge)

◆ Over-current, over-voltage and over-temperature protection

◆ Current Sharing on VS1, VS2, and VS3

◆ Remote Sense

◆ Standard VITA 62 Controls

◆ No Electrolytic Capacitors

◆ Compliance:

(Full Load Operation Down to 18V_{IN})

- VITA 62
- MIL-STD-704
- MIL-STD-461
 - CE102 ▪ CS101 ▪ CS114
 - CS115 ▪ CS116
- VITA 47 / MIL-STD-810G
 - ESD Protection
 - Shock
 - Vibration
 - Rapid Decompression
 - Corrosion Resistance
 - Fungus Resistance
 - Altitude
 - Humidity



BLOCK DIAGRAM FOR VPX-3U-DC28P-002

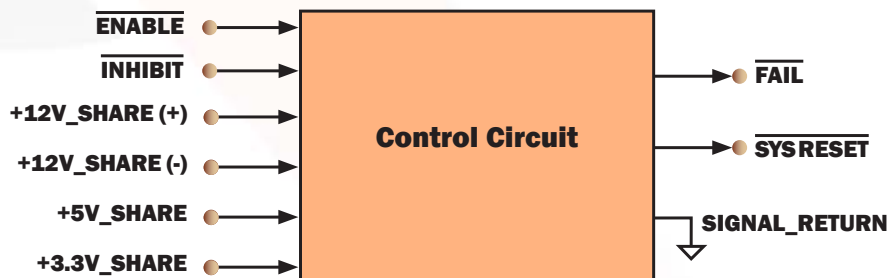
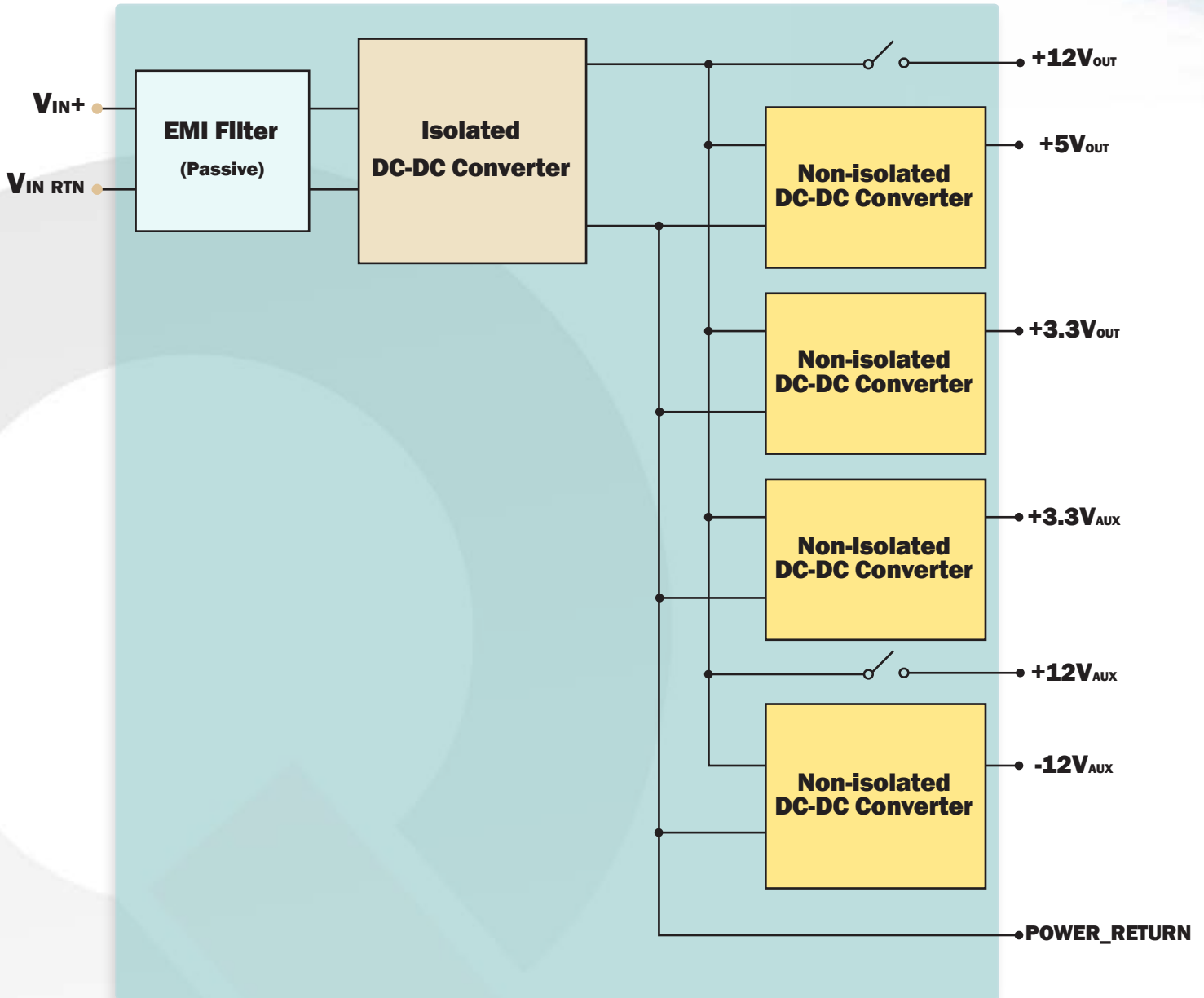



VPX 3U
VPX-3U-DC28P-002

TECHNICAL SPECIFICATION

VPX-3U-DC28P-002 INPUT CHARACTERISTICS

Parameter	Min.	Typ.	Max.	Units	Notes & Conditions
ABSOLUTE MAXIMUM RATINGS					
Input Voltage					
Non-Operating	-1		60	V	Continuous
Operating			40	V	Continuous
Operating Transient Protection			50	V	100ms transient, square wave
Isolation Voltage			1500	V	Input to Output and Input/Output to Case
Operating Temperature	-40		85	°C	Card Edge Temperature
Storage Temperature	-55		105	°C	
ELECTRICAL CHARACTERISTICS					
Input Voltage					
Continuous	18		40	V	
Transient	18		50	V	50V Transient for 100ms
Under-Voltage Lockout					
Turn-On Input Voltage Threshold	15	15.5	16	V	
FEATURE CHARACTERISTICS					
VITA 62 ON/OFF Control					
ENABLE* high-state Voltage	2		3.6	V	Control signals referenced to SIGNAL_RETURN ENABLE* regards a no-connect as a high
ENABLE* low-state Voltage			0.8	V	
INHIBIT* high-state Voltage	2		3.6	V	INHIBIT* regards a no-connect as a high
INHIBIT* low-state Voltage			0.8	V	

INPUT VOLTAGE SPIKE COMPLIANCE

INPUT VOLTAGE SPIKE SUPPRESSION	
Module Operates through these Spikes	
Input Voltage Spike (Centered on Vin)	
±250V, 100µs, Emax = 15mJ	MIL-STD-1275D
±200V, 10µs, Rs ≤ 0.5Ω	MIL-STD-461C (CS06); DEF-STAN 61-5
±400V, 5µs, Rs ≤ 0.5Ω	MIL-STD-461C (CS06)
±600V, 10µs, Rs = 50Ω	RTCA/DO-160E

VPX-3U-DC28P-002 OUTPUT CHARACTERISTICS

Parameter	+12V	+5V	+3.3V	+3.3V _{AUX}	+12V _{AUX}	-12V _{AUX}
OUTPUT CHARACTERISTICS						
Output Voltage Set Point See Note 1	12V (+/-1%)	5V (+/-1%)	3.3V (+/-1%)	3.3V (+/-1%)	12V (+/-1%)	-12V (+/-1%)
Total Output Voltage Range See Note 2	12V (+/-4%)	5V (+/-3%)	3.3V (+/-3%)	3.3V (+/-2%)	12V (+/-4%)	-12V (+/-3%)
Output Voltage Ripple (pk-pk) See Note 3	80mV	50mV	40mV	40mV	80mV	50mV
Operating Current Range Maximum Total Output Power = 500W	0-40A	0-30A	0-25A	0-6A	0-1A	0-1A
Over-Voltage Protection	14.8V	6.0V	6.0V	6.0V	14.8V	NA
Current-Limit Inception	50.4A	40A	35A	10A	2A	1.8A
Maximum Output Capacitance	10mF	10mF	10mF	10mF	1mF	10mF
MAXIMUM TOTAL OUTPUT POWER	500W					

Note 1: 28V_{in}, 50% load

Note 2: Over line, load, temperature

Note 3: Full Load, measured with 1µF capacitor and 10µF tantalum capacitor

Maximum Total Output Power = 500W (Full Temperature Range)

Temperature specifications are relative to the temperature at the thermal interface, on the flange opposite the wedge locks.

PIN DESCRIPTIONS

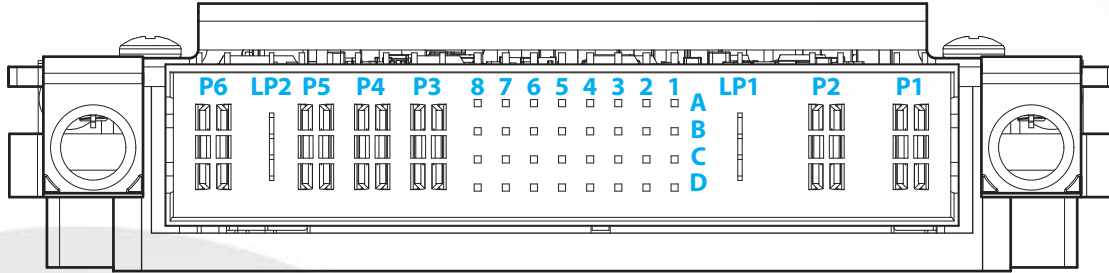

3U PO Connector

PIN	FUNCTION	DESCRIPTION
P1	-DC_IN	Vin-
P2	+DC_IN	Vin+
LP1	CHASSIS	Chassis
A1	STARTUP_SYNC	Startup synchronization
B1	Not currently used	
C1	Not currently used	
D1	Not currently used	
A2	Not currently used	
B2	FAIL*	When any of the output is not within specification, FAIL* signal will be driven low to indicate a failure
C2	INHIBIT*	Input control signal as defined in VITA 62, referenced to SIGNAL_RETURN
D2	ENABLE*	Input control signal as defined in VITA 62, referenced to SIGNAL_RETURN
A3	+3.3V_SHARE	Active current share for +3.3V_MAIN
B3	+12V_AUX	+12V auxiliary output voltage, 1A rated
C3	Not currently used	
D3	Not currently used	
A4	+3.3V_AUX	+3.3V auxiliary output voltage, 6A rated (1.5A per pin)
B4		
C4		
D4		
A5	Not currently used	
B5	Not currently used	
C5	Not currently used	
D5	Not currently used	
A6	Not currently used	
B6	Not currently used	
C6	-12V_AUX	-12V auxiliary output voltage, 1A rated
D6	SYSRESET*	System Reset is actively low. It will float when all outputs are within specification.
A7	+12V_SHARE(+)	Active current share differential pair for +12V_MAIN
B7	+12V_SHARE(-)	
C7	+5V_SHARE	Active current share for +5V_MAIN
D7	SIGNAL_RETURN	Ground pin for control signals
A8	+12V_SENSE(+)	Should be connected to +12V_MAIN either remotely or at the connector
B8	+3.3V_SENSE(+)	Should be connected to +3.3V_MAIN either remotely or at the connector
C8	+5V_SENSE(+)	Should be connected to +5V_MAIN either remotely or at the connector
D8	SENSE_RETURN	Should be connected to POWER_RETURN either remotely or at the connector
P3	+5V_MAIN	+5V main output voltage, 30A rated
P4	POWER_RETURN	Common output voltage return pin, 40A rated per pin
P5	POWER_RETURN	
LP2	+3.3V_MAIN	+3.3V main output voltage, 25A rated
P6	+12V_MAIN	+12V main output voltage, 40A rated

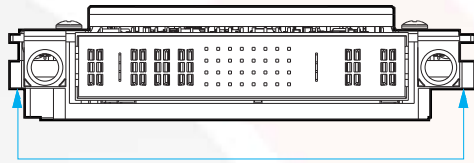
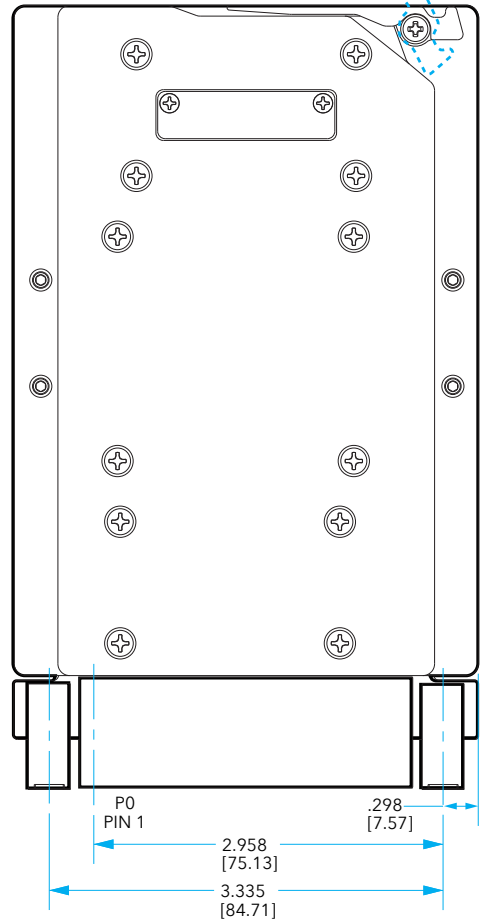
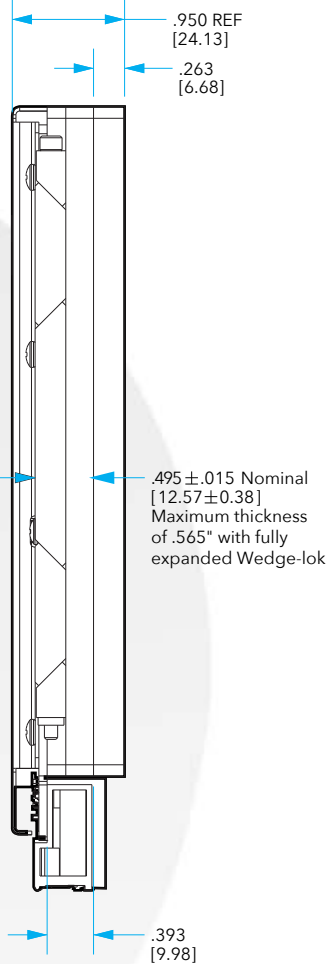
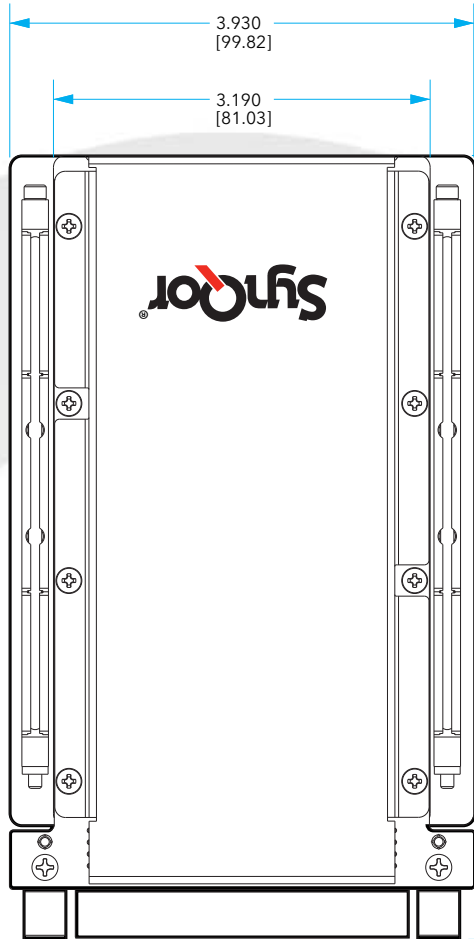

- NOTES:
1. ALL DIMENSIONS IN INCHES
2. TOLERANCES: X.XX ±0.02in [0,5mm]
X.XXX ±.010in [0,25mm]
3. CONNECTOR PART NUMBERS:
P0 - TE CONNECTIVITY 6450849-7 (or equivalent)
4. WEIGHT: 1.62 lbs (.73 kg)
5. SEE TABLE FOR KEYWAY POSITION AND ANGLE.

VPX-3U-DC28P-002		
Key Position	Alignment Angle	TE Connectivity Part Number
1	0°	1-1469492-1
2	0°	1-1469492-1



VPX 3U
VPX-3U-DC28P-002

TECHNICAL SPECIFICATION

APPLICATION NOTES

CONTROL FEATURES

ENABLE*	Standard VITA 62 control signal. It is used to turn off all of the output voltages when it is high, including +3.3V_AUX. When it is pulled low to SIGNAL_RETURN, +3.3V_AUX will be turned on and the status of the other outputs will be dependent on the state of INHIBIT*. ENABLE* signal regards a no-connect as a high.
INHIBIT*	Standard VITA 62 control signal. It is used to turn off all the output voltages except +3.3V_AUX. When it is pulled low to SIGNAL_RETURN, VS1, VS2, VS3, +12V_AUX and -12V_AUX will be turned off. INHIBIT* signal regards a no-connect as a high. At power-on, if ENABLE* and INHIBIT* are configured to turn all outputs on, +3.3V_AUX will be powered up 100ms prior to when the other outputs are powered up.
FAIL*	FAIL* signal is used to indicate a failure has occurred. It will be pulled low when any of the outputs are outside the voltage specification. FAIL* is an active low open-drain signal. It is expected there will be a pull-up resistor on the backplane to 3.3V. A typical resistor value is 4.7kΩ.
SYSRESET*	SYSRESET* signal is an output generated from the module. It is used to indicate that startup has completed. At power-on, SYSRESET* is pulled low. It will be high impedance when all outputs are within voltage specification. It will be pulled low if any failure has occurred or if the outputs are disabled by the user during operation. SYSRESET* signal is an active low open-drain signal. It is expected there will be a pull-up resistor on the backplane to 3.3V. A typical resistor value is 4.7kΩ.

VITA 62 CONTROL STATES

ENABLE*	INHIBIT*	+3.3V_AUX	VS1, VS2, VS3, +12V_AUX, -12V_AUX
HIGH	HIGH	OFF	OFF
LOW	HIGH	ON	ON
HIGH	LOW	OFF	OFF
LOW	LOW	ON	OFF

PARALLEL OPERATION

+12V_MAIN	Active current sharing on +12V_MAIN is supported. To implement the current share function, +12V_SHARE(+) and +12V_SHARE(-) pins should be routed between all paralleled modules as a differential pair. ENABLE*, INHIBIT* and STARTUP_SYNC should be connected together. High speed data communication is transmitted on these two lines. Control state is transmitted between the master unit and slave units on a cycle-by-cycle basis. Adding capacitance to these share lines must be avoided.
+5V_MAIN & +3.3V_MAIN	Active current sharing on +5V_MAIN and +3.3V_MAIN is also supported, but with an analog sharing scheme that is different than the digital sharing scheme for the +12V_MAIN. To implement the current sharing function, +5V_SHARE, +3.3V_SHARE, ENABLE*, INHIBIT* and STARTUP_SYNC should be connected together between all paralleled modules. These SHARE pins are referenced to POWER_RETURN. A clean ground plane is important, and ground drop between each module should be minimized.
+3.3V_AUX, +12V_AUX & -12V_AUX	Active current sharing is not supported on auxiliary outputs. However, all these auxiliary rails have OR'ing MOSFETs or OR'ing diodes implemented, so that they can still be operated in parallel. Total output current on these rails should not exceed the current rating of a single module.



VPX 3U
VPX-3U-DC28P-002

QUALIFICATIONS AND SCREENING

VPX MODULE QUALIFICATION (VITA 47 COMPLIANT)

Test Name	Method
Random Vibration	MIL-STD-810, 514.6 - Procedure I, Class V3
Shock	MIL-STD-810, 516.6 - Procedure I, VI, Class OS2
Altitude	MIL-STD-810, 500.5 - Procedure I, II, III
Fungus Resistance	MIL-STD-810, 508.6
Corrosion Resistance	ASTM G85, Annex A4
Humidity	MIL-STD-810, 507.5 - Procedure II
High Temperature	MIL-STD-810, 501.5 - Procedure I, II
Low Temperature	MIL-STD-810, 502.5 - Procedure I, II
Temperature Cycling	MIL-STD-202, 107 - Class C4
ESD	EN61000-4-2, Level 3; 8kV Air Discharge

DC-DC CONVERTER AND FILTER SCREENING

Screening	Process Description	S-Grade	M-Grade
Baseplate Operating Temperature		-55 °C to +100 °C	-55 °C to +100 °C
Storage Temperature		-65 °C to +135 °C	-65 °C to +135 °C
Pre-Cap Inspection	IPC-610, Class III	Yes	Yes
Temperature Cycling	Method 1010, Condition B, 10 Cycles		Yes
Burn-In	100 °C Baseplate	12 Hours	96 Hours
Final Electrical Test	100%	25 °C	-55 °C, +25 °C, +100 °C
Final Visual Inspection	MIL-STD-2008	Yes	Yes



VPX 3U
VPX-3U-DC28P-002

ORDERING / PART NUMBERING

ORDERING INFORMATION / PART NUMBERING

Series	Package Size (U)	Input Range	Mil Std Filtering	Output Voltage Combination Code	Packaging Options
VPX -	3U -	DC28	P	- 002 -	Y ₁ Y ₂ Y ₃
VPX	3U 6U	DC28: 28V DC270:270V	P: P -MIL-STD-704 (B-F) T: T -MIL-STD-704 A MIL-STD-1275 (B,D) DEF-STAN 61-5 (P6)/6	002: 002	Y1: Screening S - Standard (MCOTS) M - Military (MCOTS) Y2: Conformal Coating N - No Conformal Coating C - Conformal Coating Y3: TBD

Examples: VPX-3U-DC28P-002-SN

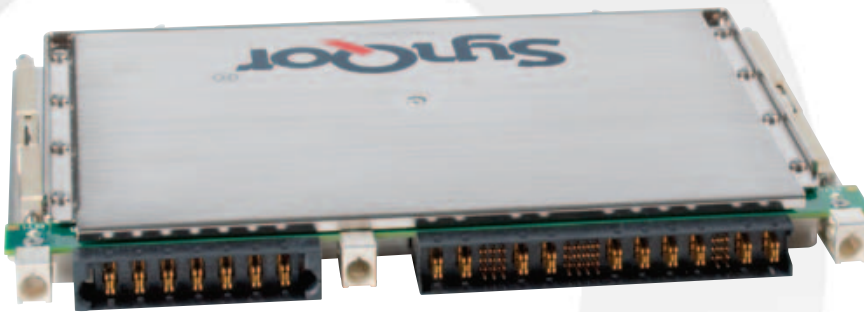

APPLICATION NOTES

A variety of application notes and technical white papers can be downloaded in PDF format from our [website](#).

PATENTS

SynQor holds the following U.S. patents, one or more of which apply to each product listed in this document. Additional patent applications may be pending or filed in the future.

5,999,417 6,222,742 6,545,890 6,577,109 6,594,159 6,731,520
6,894,468 6,896,526 6,927,987 7,050,309 7,072,190 7,085,146
7,119,524 7,269,034 7,272,021 7,272,023 7,558,083 7,564,702
7,765,687 7,787,261 8,023,290 8,149,597 8,493,751 8,644,027

CONTACT SYNQOR FOR FURTHER INFORMATION AND TO ORDER:

Phone: _____ 978-849-0600
Toll Free: _____ 888-567-9596
Fax: _____ 978-849-0602
E-mail: _____ power@synqor.com
Web: _____ www.synqor.com
Address: _____ 155 Swanson Road
Boxborough, MA 01719 USA

Warranty

SynQor offers a two (2) year limited warranty. Complete warranty information is listed on our website or is available upon request from SynQor.

Information furnished by SynQor is believed to be accurate and reliable. However, no responsibility is assumed by SynQor for its use, nor for any infringements of patents or other rights of third parties which may result from its use. No license is granted by implication or otherwise under any patent or patent rights of SynQor.