

**ME SERIES MINI LIMIT SWITCHES**

**FEATURES**

- Metal case housing
- IP65
- 5A 250 VAC
- -15°C to +70°C
- NO/NC contacts
- Wide choice of heads and actuators

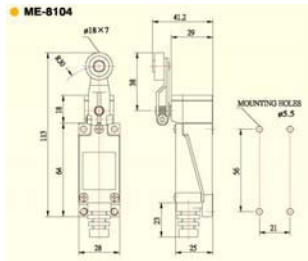

Item nr	Specification
ME-8104	Mini limit switch
ME-8104F	Mini limit switch, flat cover
ME-8104-M	Mini limit switch, metal roller
ME-8104-L	Mini limit switch, 50mm big rubber roller

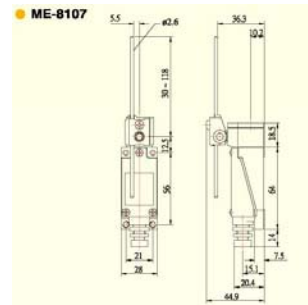

ME-8107	Mini limit switch
ME-8107F	Mini limit switch, flat cover

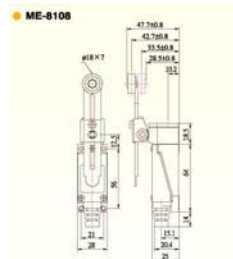

ME-8108	Mini limit switch
ME-8108F	Mini limit switch, flat cover
ME-8108-M	Mini limit switch, metal roller
ME-8108-L	Mini limit switch, 50mm big rubber roller

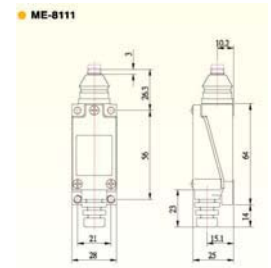

ME-8111	Mini limit switch
ME-8111F	Mini limit switch, flat cover

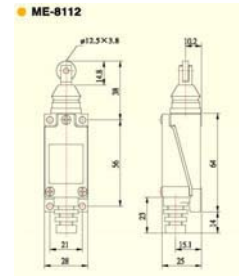

ME-8112	Mini limit switch
ME-8112F	Mini limit switch, flat cover
ME-8112-P	Mini limit switch, plastic roller

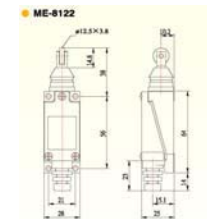

ME-8122	Mini limit switch
ME-8122F	Mini limit switch, flat cover
ME-8122-P	Mini limit switch, plastic roller

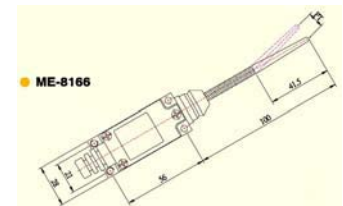

ME-8166	Mini limit switch
ME-8166F	Mini limit switch, flat cover

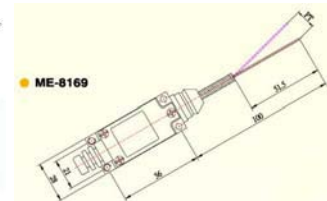

ME-8169	Mini limit switch
ME-8169F	Mini limit switch, flat cover

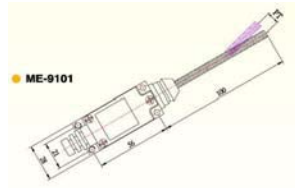

ME-9101 Mini limit switch  
ME-9101F Mini limit switch, flat cover

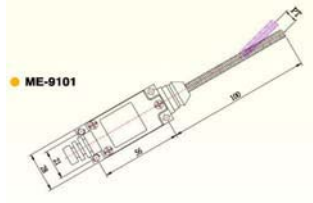

ME-9101-HI Mini limit switch, actuator 1/4 steel & 3/4 spring



ME-8000 Switch block