

OEM Pressure Sensors “MobilTrans”

For mobile hydraulics

Accuracy 1%

Standard output: 4...20mA;	2-wire
or 0...5VDC;	3-wire
or 0...10VDC;	3-wire
or 0.5...4.5VDC;	ratiometric



Description

Our new pressure sensor MobilTrans is designed for rough environments and extreme applications e.g. mobile hydraulics systems where shock and vibration but also pressure peaks or steam jet cleaning are daily routine. All of these effects have no impact on the accuracy and reliability of our measurements. Due to fully automated production we can offer very attractive prices and high quantities.

A high degree of automation is used to produce the MobilTrans pressure transducer, which enhances consistency and reliability.

Features

- o Measuring ranges from 0...60bar to 0...600bar
- o Highly resistant to shock and vibrations
- o High EMC-protection (100V/m) according to EN 61 326
- o Compact design
- o Protection up to IP69K
- o Excellent temperature performance (-40°C to 125°C)
- o Resistance to pressure peaks (CDS - system)

Applications

Mobile hydraulics
 Hydraulics
 Pumps
 Machine and plant construction

Model: P3354

Technical data

Model P3354

Pressure type	Positive guage pressure						
	[bar]	60	100	160	250	400	600
- Ranges	[bar]	60	100	160	250	400	600
- Overload limit	[bar]	120	200	320	500	800	1200
- Burst pressure	[bar]	550	800	1000	1200	1700	2400
Sensor element	Thin film						
Output signal	4...20mA 2-wire 1...5VDC 3-wire 0...10VDC 3-wire 0.5...4.5VDC ratiometric other signals on request						
Accuracy ¹⁾	≤ 1.0% of F.S. (≤ 0.5% BFSL)						
Non linearity ²⁾	≤ 0.4% of F.S. BFSL						
Repeatability	≤ ± 0.3% of F.S.						
Stability (annual)	≤ ± 0.3% of F.S. (in rated condition)						
Material, Case Wetted parts	Fibre reinforced plastic (PBT) stainless steel 1.4435 and 1.4542						
Pressure connection	G 1/4 according to DIN 3852-E M14x1,5 according to DIN 3852-E 7/16-20 UNF-2A, male O-Ring 1/4 NPT other pressure connections on request						
Electrical connection	connector Metri Pack Serie 150 round connector M12x1 (4-pin) cable outlet with 1.5m cable AMP Superseal connector 1.5 (3-pin) Deutsch connector other electrical connections on request						
Power supply / load	4...20mA 1...5V 0...10V 0.5...4.5V ratiometric	10...36VDC 8...36VDC 14...36VDC 5 ± 0.5VDC	R _A [Ω] ≤ (U _B [V] – 10V) / 0,02A R _A > 2,5kΩ R _A > 5kΩ R _A > 4.5kΩ				
Response time	≤ 2ms within 10% to 90% of F.S.						
Protection type Packard Metri Pack 150 Round connector M12x1 Cable outlet AMP Superseal connector	according to EN 60529 IP67 IP67 IP69K (steam jet cleaning) IP67						
EMC Interference Resistance	according to EN 61 326 according to EN 61 326						
Electrical protection type	reverse polarity, overload and short-circuit protection except ratiometric output signals						
Temperature influence Median TC zero point Median TC measuring range	≤ ± 0.15% / 10K ³⁾ ≤ ± 0.15% / 10K						
Temperature ranges Compensated range Storage Media Ambient	0...80°C -40...120°C -40...125°C -40...100°C						
Loading capacity Shock (mechanical shock) Vibration (under resonance)	500g according to IEC 60068-2-27 20g according to IEC 60068-2-6						
Weight	approx. 70g						

¹⁾ Including non-linearity, hysteresis, non-repeatability, zero point and full scale error (corresponds to error of measurement per IEC 61298-2).

²⁾ According to IEC 61298-2

³⁾ For special pressure ranges increased TC of zero

BFSL = Best fitt straight line
of F.S. = of full scale value

Dimensions (mm)

Housing

Connector Metri Pack 150

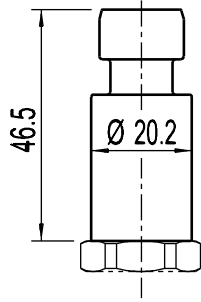

Round connector M12x1

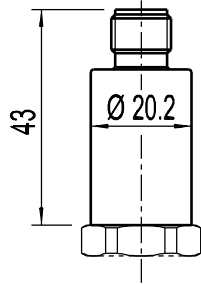

Cable outlet

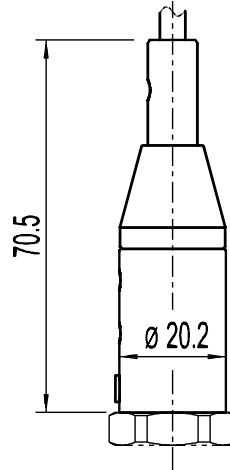

AMP Superseal 1.5

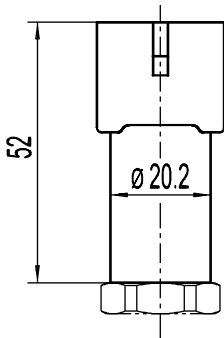

Deutsch connector

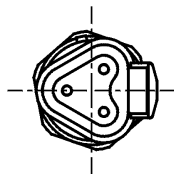
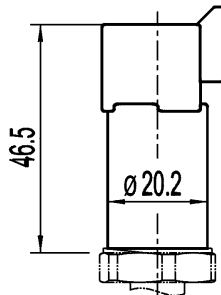

Pressure connections

G 1/4B according to DIN 3852-E

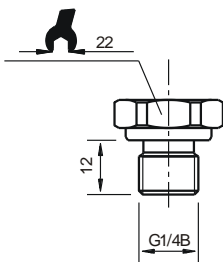

M14x1.5

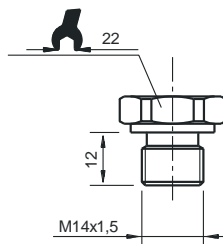

1/4 NPT

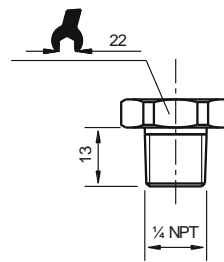

7/16-20 UNF-2A

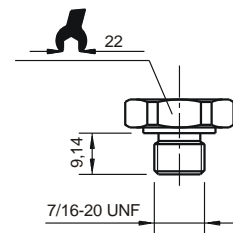

Electrical connection

Two-wire system

Round connector M12x1

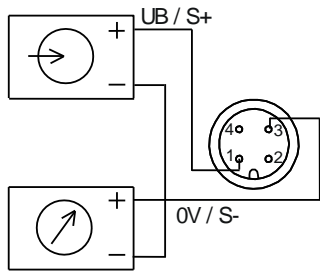

Connector Metri Pack 150

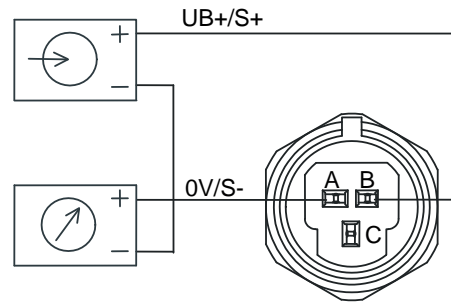

Cable outlet

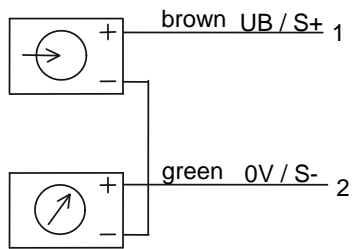

AMP Superseal

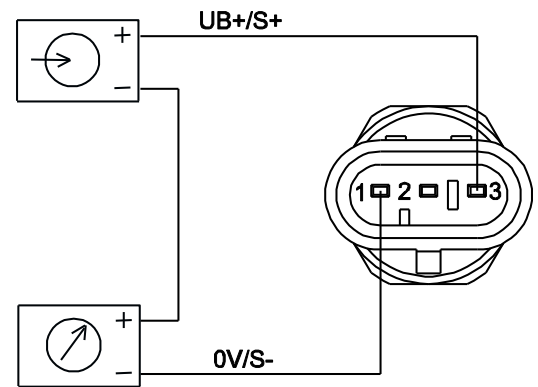

Deutsch connector

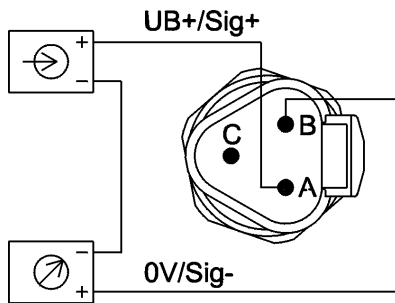

Three-wire system

Round connector M12x1

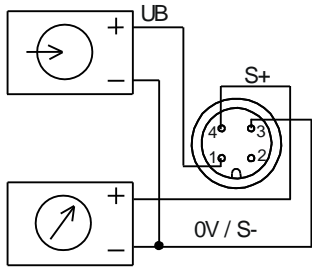

Connector for Metri Pack150

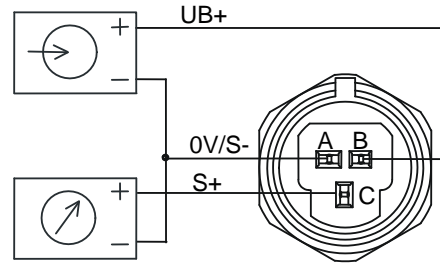

Cable outlet

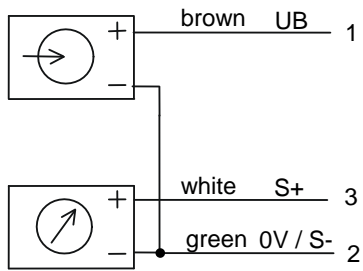

AMP Superseal

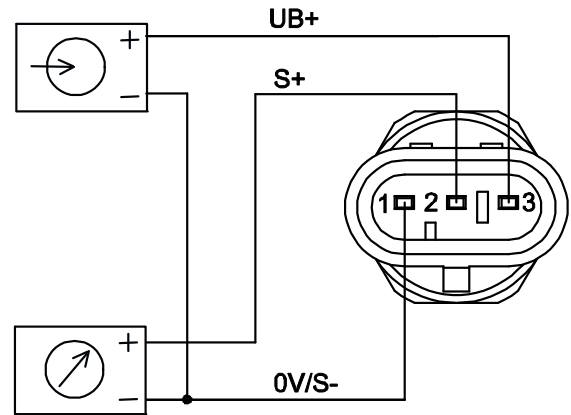

Deutsch connector

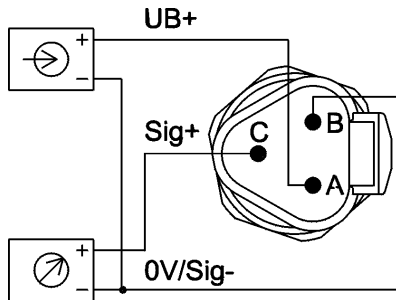

Subject to technical alternations