

CARATTERISTICHE SPECIFICATIONS

ATTACCHI PIPES in → out	Ø mm	CODICE CODE	KV m ³ /h	M.O.P.D. bar		DIMENSIONI/DIMENSIONS mm				PESO/WEIGHT Kg
				AC	DC	A	B	C	D	
3/8"	10	8613	1.86	10	10	61	89	48	77	0.540
1/2"	12	8614	2.10	10	10	61	89	48	77	0.500
3/4"	20	8615	5.70	10	10	87	101	69	84	0.800
1"	25	8616	9.60	10	10	100	106	80	86	1.100
1" 1/4	32	8617	22.00	10	10	131	122	112	95	2.500
1" 1/2	39	8618	27.00	10	10	146	128	128	98	3.000
2"	51	8619	35.00	10	10	174	145	146	108	4.600
2" 1/2	65	8620	63.00	10	10	245	180	184	134	9.400
3"	75	8621	83.00	10	10	250	190	184	139	11.230
3/8" NPT	12	8623	2.10	10	10	61	89	48	77	0.540
1/2" NPT	12	8624	2.10	10	10	69	89	48	77	0.510
3/4" NPT	20	8625	5.70	10	10	87	101	69	84	0.800
1" NPT	25	8626	9.60	10	10	108	106	80	86	1.130

CARATTERISTICHE ELETTRICHE ELECTRICAL INFORMATION

							POTENZA/POWER				
							NOMINALE HOLDING	SPUNTO IN RUSH			
V~	12	24	48	110	230	400	50	60	Hz	11VA	24VA
V=	12	24	48	110							16W

Per dettagli costruttivi sulle bobine vedi capitolo "INFORMAZIONI DI PROGETTO"
For construction details of the coils see chapter "PROJECT INFORMATION"
Ausführliche Daten über die Ventilspulen finden Sie unter Abschnitt "TECHNISCHE INFORMATIONEN"

MAX TEMPERATURA MAX TEMPERATURE

FLUIDI/FLUIDS				AMBIENTE/AMBIENT
NBR	EPDM	EPDM-KTW	FPM	80°C
90°C	130°C	130°C	150°C	

DIAGRAMMA PERDITA DI CARICO PRESSURE LOSS DIAGRAM

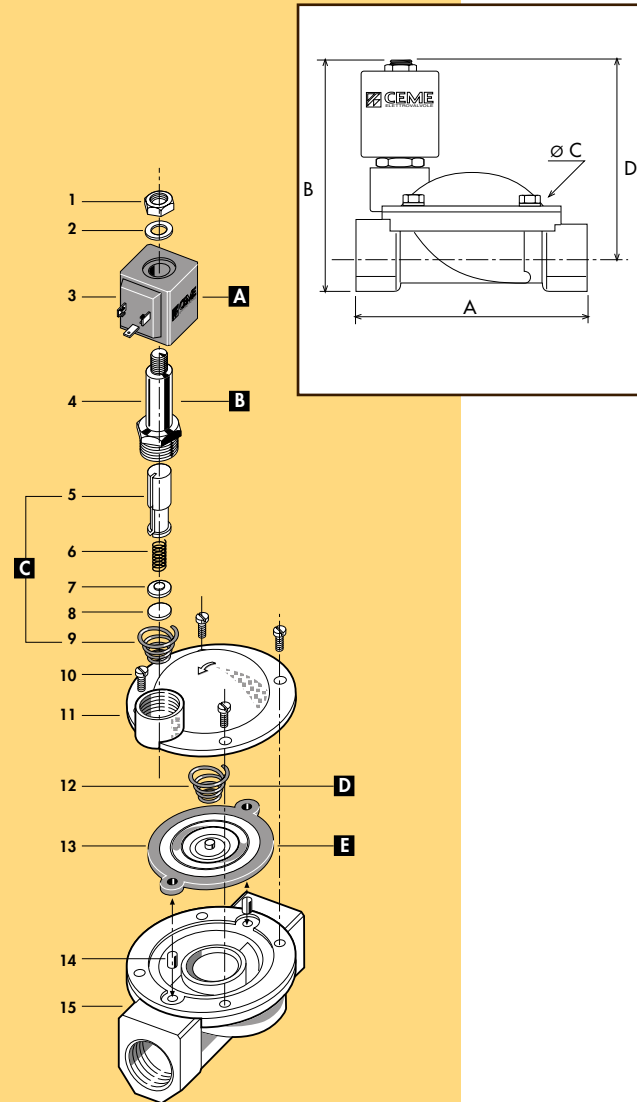
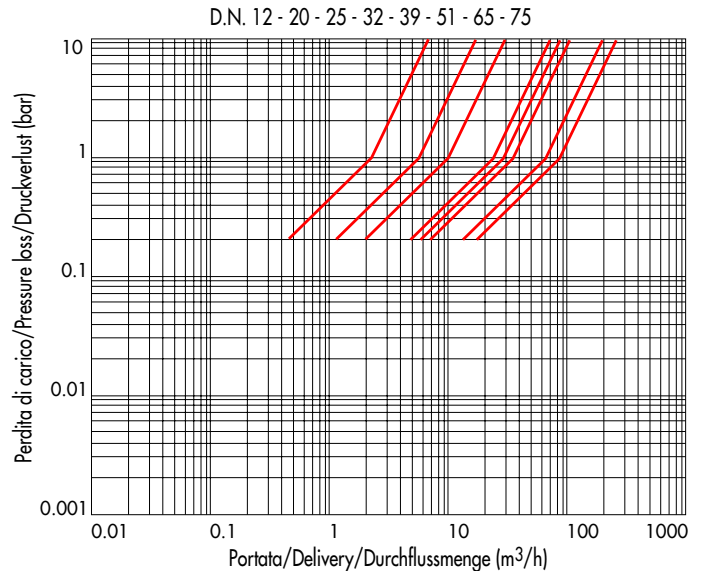

1 Dado	Lock nut	Mutter
2 Rondella	Washer	Beilagscheibe
3 Bobina	Coil	Magnetspule
4 Cannotto	Tube guide	Plungerrohr
5 Nucleo mobile	Plunger	Plunger
6 Molla	Spring	Feder
7 Piattello	Support	Scheibe
8 Pastiglia	Seal	Dichtung
9 Molla	Spring	Feder
10 Vite	Screw	Schraube
11 Coperchio	Valve body top	Deckel
12 Molla	Spring	Feder
13 Membrana	Diaphragm	Membrane
14 Bussola	Bush	Buchse
15 Corpo	Valve body base	Grundkörper

RICAMBI	SPARE PARTS	ERSATZTEILE
A Bobina	Coil	Magnetspule
B Cannotto	Tube guide	Plungerrohr
C Nucleo mobile	Plunger	Plunger
D Molla	Spring	Feder
E Membrana	Diaphragm	Membrane

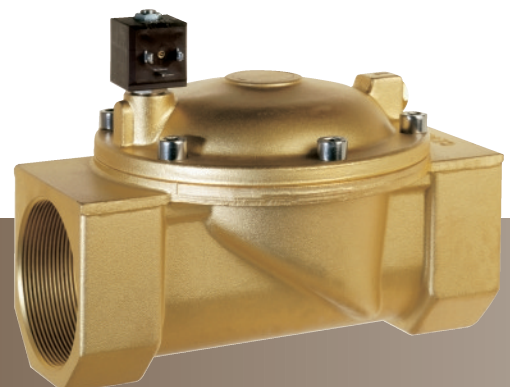

serie 86

ELETTROVALVOLA SERVOCOMANDATA 2/2 VIE N.C.
SOLENOID VALVE PILOT OPERATED 2/2 WAY N.C.
SERVOGESTEUERTES MAGNETVENTIL 2/2 WEGE S.G.



KTW



I CARATTERISTICHE GENERALI
PRESSIONE MINIMA DIFFERENZIALE DI FUNZIONAMENTO 0,3 bar
PARTI A CONTATTO CON IL FLUIDO
TENUTA

NBR a richiesta FPM - EPDM
 EPDM-KTW tenuta adatta e certificata DVGW per l'intercettazione di acqua potabile
 OTTONE

CORPO
TUBO GUIDA INOX

- Tenuta metallica con il corpo per tenute sicure anche ad alte temperature di impiego.
 - Migliore resistenza alla corrosione.

ORGANI INTERNI

ACCIAIO INOX
 ARIA, ACQUA, OLII LEGGERI

FLUIDI
VALVOLA UNIDIREZIONALE
VALVOLA ISPEZIONABILE
VALVOLA FORNITA CON
POSIZIONE DI MONTAGGIO
TEMPERATURA AMBIENTE
ESECUZIONI SPECIALI

CONNETTORE TRIPOLARE UNI ISO 4400 (DIN 43650A) - IP65
 Qualsiasi; sconsigliata quella con bobina rivolta verso il basso.
 80°C, in D.C. per temperature superiori a 40°C, le performances (M.O.P.D.) potrebbero diminuire
 VERSIONE ANTI COLPO D'ARIETE CON TEMPO DI CHIUSURA PIU' LENTO
 VERSIONE CON COMANDO MANUALE APERTURA/CHIUSURA (DISPONIBILE PER I MODELLI
 8616 - 8617 - 8618 - 8619 - 8620 - 8621)
 VERSIONE CON MEMBRANA RINFORZATA PER UTILIZZO AD ALTA PRESSIONE E ALTA FREQUENZA
 D'INTERVENTO (DISPONIBILE PER I MODELLI 8615 - 8616 - 8617 - 8618 - 8619)

ACCESSORI

BOBINA CON CAVI (IP 67)

UK GENERAL FEATURES
MINIMUM DIFFERENTIAL WORKING PRESSURE 0,3 bar
PARTS IN CONTACT WITH THE FLUID

SEALING

NBR on request FPM - EPDM
 EPDM-KTW sealing approved and DVGW certified for interception of potable water

BODY
STAINLESS STEEL TUBE GUIDE

BRASS
 - Metallic sealing with the body for safety sealing also for high temperature applications.
 - Improved corrosion resistance.

INTERNAL PARTS

STAINLESS STEEL
 AIR, WATER, LIGHT OILS

ONE WAY DIRECTION VALVE
SERVICEABLE VALVE
VALVE SUPPLIED WITH
MOUNTING POSITION
AMBIENT TEMPERATURE
SPECIAL EXECUTIONS

THREE POLE PLUG CONNECTOR UNI ISO 4400(DIN 43650A) -IP65
 Any, the position with the coil downwards is not recommended.
 80°C in D.C. for temperatures higher than 40°C, the performances (M.O.P.D.) could decrease.
 VERSION WITH WATER HAMMER DEVICE FOR SLOWER CLOSING TIME
 VERSION WITH MANUAL OVERRIDE (AVAILABLE FOR MODELS 8616-8617-8618-8619-8620 8621)
 VERSION WITH REINFORCED DIAPHRAGM FOR HIGH PRESSURE USE AND HIGH FREQUENCY
 APPLICATIONS (AVAILABLE for MODELS 8615-8616-8617-8618-8619)

ACCESSORIES

CABLED COIL (IP 67)

D ALLGEMEINE MERKMALE
MINIMALER DIFFERENTIALARBEITSDRUCK 0,3 bar
MEDIUMS BERUEHRTE TEILE
DICHTUNG

NBR auf Nachfrage FPM - EPDM
 EPDM-KTW Dichtung, DVGW-KTW zertifiziert fuer den Trinkwassereinsatz.

KOERPER
PLUNGERROHR AUS EDELSTAHL

MESSING
 - Metallische Dichtung fuer einen sicheren Einsatz auch bei hohen Medien-temperaturen.
 - Bessere Korrosionsbestaendigkeit.

INNERE ELEMENTE

EDELSTAHL
 LUFT, WASSER, LEICHTE OELE

MEDIEN
UNIDIREKTIONALES VENTIL
VENTIL WARTUNGSFREUNDLICH
LIEFERUMFANG
MOUNTING POSITION

DREIPOLIGER STECKER UNI ISO 4400 (DIN 43650A) -IP65
 Keine Einschränkungen. Fuer Montage mit dem Spulenkopf senkrecht nach unten, auf Anfrage.

UMGEBUNGSTEMPERATUR

80°C ,im D.C.- Betrieb koennen Temperaturen ueber 40°C, die Schaltkraefte (M.O.P.D.) des Ventils beeintraechtigen.

SONDERAUSFUEHRUNGEN

VERSION LANGSAM SCHLIESSEND
 VERSION MIT HANDBETAETIGUNG (VERFUEGBAR FUER MODELLE 8616-8617-8618-8619-8620-8621)
 VERSION MIT VERSTAERKTER MEMBRANE FUER DEN EINSATZ MIT HOHEN DRUECKEN UND HOHER SCHALTHAEUEFIGKEIT (VERFUEGBAR FUER MODELLE 8615-8616-8617-8618-8619)

ZUBEHOER

MAGNETSPULE MIT ANGEGOSSENEN KABELN (IP 67)

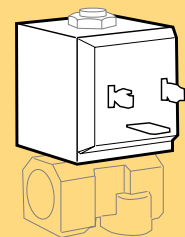
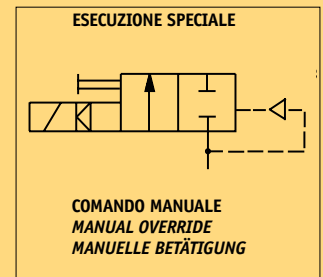
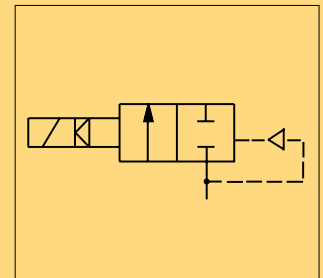
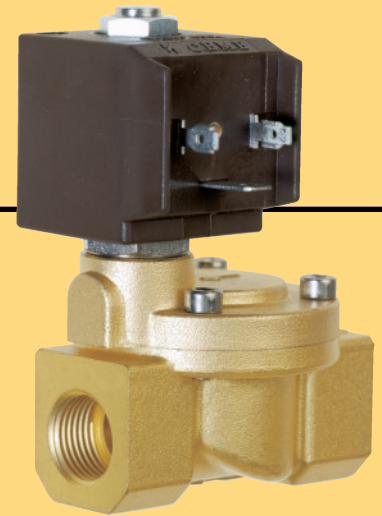

BOBINA TIPO B6
COIL TYPE B6
SPULE TYP B6



昆山苏美自动化科技有限公司

Kunshan Sumei Automation Technology Co., LTD

TEL: (+86) 512-57914649 57910267 FAX: (+86) 512-82092939

Mail: kssumei@163.com

Web: http://www.smzdh.com

serie 86