

Pneumatic High-Speed Pressure Controller

CPC3000



Pneumatic High-Speed Pressure Controller Model CPC3000

Version 1.1



Part of your business



Warning

This Warning symbol indicates that danger of injury for persons and the environment and/or considerable material damage (mortal danger, danger of injury) will occur if the respective safety precautions are not taken.



Caution

This Caution symbol indicates danger for the system and material if the respective safety precautions are not taken.



Notice

This Notice symbol does not indicate safety notices but information for a better understanding of the facts.

Contents

1.	General notices	5
1.1	FCC Radio frequency emission notice	6
1.2	Software license agreement	6
1.3	Accreditations	6
1.4	Packaging for Shipment	7
2.	Safety notices	7
2.1	User Responsibilities	7
2.2	General safety notices	7
2.3	Safety notices regarding operation	8
3.	Product description	10
3.1	Proper use	10
3.2	Features	11
3.3	Turning on the CPC3000	12
3.4	Front panel	12
3.5	Main menu	13
3.5.1	Keys, Tabs, Check Boxes, Labels/Graphics	13
3.6	Front Panel Variations and Navigation	14
3.6.1	Operating modes	14
3.7	Main menu setpoint entry options	16
4.	Specifications	17
5.	Installation	18
5.1	Introduction	18
5.2	Unpacking of the system	18
5.3	Dimensions of the available version in mm	18
5.4	Installation of the system	19
5.5	Rear panel	20
5.6	Pressure connections	20
5.7	Function of pressure connections	21
5.8	Electrical connections	22
5.8.1	Connecting the power supply and turning on the instrument	22
5.8.2	Connecting the Communications interfaces	22
6.	Starting operation	23
7.	Operation via Touch-screen	24
7.1	Setting the operating language	24
7.2	Display configuration	24
7.3	Setpoint Entry	26
7.4	Operating modes	27
7.5	Data Entry	30
7.6	Pressure unit, Pressure mode and Emulation mode	30
7.7	Bar Chart	31

7.8	SETUP Menus	31
7.8.1	SETUP Display	32
7.8.2	SETUP Control	33
7.8.3	SETUP Remote	34
7.8.4	SETUP Info	35
7.8.5	SETUP Service	36
8.	Remote Operation	40
8.1	Remote SETUP	40
8.2	Remote SETUP - Ethernet	41
8.3	Remote SETUP - USB	41
8.4	Remote SETUP - IEEE-488	42
8.5	Remote Command Set	42
8.5.1	Mensor Command Set	43
8.5.2	PCS 400 Commands Emulated	48
8.5.3	PCS 200 Commands Emulated	50
8.5.4	DPI 510 Commands Emulated	52
8.5.5	IEEE 488.2 Commands	52
8.5.6	SCPI Commands	53
9.	Trouble-shooting measures	56
9.1	Table: Fault description and measures	56
10.	Re-calibrating and servicing	58
11.	Removal of the system	59
12.	Transport of the system	60
13.	Storage of the system	61
14.	Placing out of service	62
15.	Appendix	63
	1. Table - Measurement Units	64
	2. Table - Conversion factors, Pascal	65

1. General notices

In the following chapters detailed information on the pneumatic high-speed pressure controller model CPC3000 and its proper use can be found.

Should you require further information, or should there be problems which are not dealt with in detail in the manual, please contact the following address:

WIKA Alexander Wiegand SE & Co. KG
Alexander Wiegand Strasse
D-63911 Klingenberg
Tel. +49 - (0) 93 72 / 132-9986
Fax +49 - (0) 93 72 / 132-217
E-mail: testequip@wika.de

All integrated pressure sensors are calibrated.

The warranty period for the pneumatic high-speed pressure controller model CPC3000 is 24 months according to the general terms of supply of ZVEI.
All guarantee claims lapse if the system is put to improper use or if the operating instructions are not observed or if an attempt is made to open the system.

We also point out that the contents of these operating instructions does not form part of an earlier or existing agreement, assurance or legal relationship or is meant to change these. All obligations of WIKA Alexander Wiegand SE & Co. KG result from the respective sales contract and the general business terms of WIKA Alexander Wiegand SE & Co. KG.

WIKA is a registered trade mark of WIKA Alexander Wiegand SE & Co. KG. All other brand and product names are trademarks or registered trademarks of their respective companies.

We reserve the right to effect reasonable changes on the basis of technical improvements.

Any reproduction of this manual or parts thereof by any means is prohibited.

Version key regarding firmware and respective manual

Manual	Firmware
V1.1	V 1.0

© 2009 Copyright WIKA Alexander Wiegand SE & Co. KG.

1.1 FCC Radio frequency emission notice

This equipment has been tested and found to comply with the limits for a Class A digital device, pursuant to Part 15 of the FCC Rules. These limits are designed to provide reasonable protection against harmful interference when the equipment is operated in a commercial environment. This equipment generates, uses, and can radiate radio frequency energy and, if not installed and used in accordance with the instruction manual, may cause harmful interference to radio communications. Operation of this equipment in a residential area is likely to cause harmful interference in which case the user will be required to correct the interference at his or her own expense.



Notice

Use shielded cables to connect external devices to this instrument to minimize rf radiation.

1.2 Software license agreement

This product contains intellectual property, i.e., software programs, that are licensed for use by the end user/customer (hereinafter “end user”).

This is not a sale of such intellectual property.

The end user shall not copy, disassemble or reverse compile the software program.



Notice

The software programs are provided to the end user “as is” without warranty of any kind, either express or implied, including, but not limited to, warranties of merchantability and fitness for a particular purpose. The entire risk of the quality and performance of the software program is with the end user.

WIKA, Mensor and its suppliers shall not be held to any liability for any damages suffered or incurred by the end user (including, but not limited to, general, special, consequential or incidental damages including damages for loss of business profits, business interruption, loss of business information and the like), arising from or in connection with the delivery, use or performance of the software program.

1.3 Accreditations

WIKA is registered to ISO 9001:2000. The calibration program at WIKA is accredited by DKD, as complying with both the ISO/IEC 17025:2005 standards. All Mensor primary standards are traceable to PTB.

1.4 Packaging for Shipment

If the product must be shipped to a different location or returned to WIKA for any reason through a common carrier it must be packaged properly to minimize the risk of damage.

The recommended method of packing is to place the instrument in a container, surrounded on all sides with at least 10 cm of shock attenuation material such as styrofoam peanuts.

2. Safety notices

2.1 User Responsibilities

To ensure safety, the user must make sure that:

- The system is used properly (refer to 3.1 "Proper use" in the chapter 3. "Product description"), no dangerous media are used and that all technical specifications are observed.
- Safety mechanisms exist, which exclude any danger to persons or machinery through improper pressurisation.
- The system is only operated in perfect operative condition.
- This operation manual is legible and accessible to the user at the system's location.
- The system is operated, serviced and repaired only by staff which is authorised and qualified to do so.
- The operator receives instruction on industrial safety and environmental protection, and is knowledgeable of the operating instructions and the safety notices contained therein.

2.2 General safety notices



Caution

The system should only be operated by trained personnel who are familiar with this manual and the operation of the instrument.

A condition for trouble-free and safe operation of this system is proper transport, proper storage, installation, assembly and proper use as well as careful operation and maintenance.



Warning

Any operation not described in the following instructions should be prohibited. The system must be handled with the care required for an electronic precision instrument (protect from humidity, impacts, strong magnetic fields, static electricity and extreme temperatures). Do not insert any objects into the instrument.

The system is powered via the power cable with a voltage that can cause physical injury. Even after disconnecting the system from the power supply, dangerous voltages can temporarily occur due to capacitance.



Warning

Extreme care must be taken with pressure connections when using hazardous or toxic media.

Repairs must only be performed by authorized service personnel.

Additional safety notices are found throughout this manual.

2.3 Safety notices regarding operation



Warning

HIGH PRESSURE! High pressure gases are potentially hazardous. Energy stored in these gases can be released suddenly and with extreme force. High pressure systems should be assembled and operated only by personnel who have been trained in proper safety practices.

POSSIBLE INJURY! The tubing, valves and other apparatus attached to the controller must be adequate for the maximum pressure which will be applied, otherwise physical injury to the operator or bystander is possible.



Caution

Caution: use the proper pressure medium. Use only clean, dry non-corrosive gases. This instrument is not designed for oxygen use.



Warning

The user must use caution when controlling from a very high pressure down to a very low pressure when a vacuum pump is connected to the Vacuum/Exhaust port. Large volumes of gas may be present in the device under test and will exhaust through the Vacuum/Exhaust port in excess of the capacity of the internal relief valve, possibly causing damage to the vacuum pump.

HIGH SOUND LEVELS! Pressures from 40 bar and up can generate sound levels above 100 db for brief periods when they are exhausted directly to atmosphere. If no muffling devices are attached to the VACUUM/EXHASUT or VENT port, then ear protection is advised for personnel in the vicinity of the instruments that will be operated under such conditions.

NOT EXPLOSION PROOF! Installation of this instrument in an area requiring devices rated as intrinsically safe is not recommended.



Caution

Caution: ESD protection required.

The proper use of grounded work surfaces and personal wrist straps are required when coming into contact with exposed circuits (printed circuit boards) to prevent static discharge damage to sensitive electronic components.



Warning

Before the system is switched on, the user must verify that the system was installed correctly and that all connections meet current regulations. The user must ensure that all specifications such as supply voltage, operating temperature, humidity, sensor-specific pressure media and pressure ranges are observed.



Warning

Before pressurizing, the user must ensure through appropriate protective measures that the system or the device will not be overpressurized. When working with or on an instrument, safety glasses should be worn.

In areas where the system is operated there must be sufficient air ventilation due to inert gases that will escape during use.

High pressure can accelerate parts in a manner that could be hazardous and cause physical injury.

Additional warning and caution notes are included throughout this manual.

3. Product description

3.1 Proper use

The Pneumatic High-Speed Controller model CPC3000 is a bench top or rack mounted Digital Pressure Calibrator/Controller used for test and calibration of mechanical pressure gauges, pressure switches, sensors, transducers, transmitters and any pressure related devices where time to set point is the most critical requirement.



Warning

Only dry clean air or nitrogen should be used as the pressure medium. Shop air should be avoided and corrosive, oxidizing, condensing, explosive gasses should be strictly avoided.

The maximum permissible supply pressure at the SUPPLY port should be 10 % over full scale value of the sensor installed.

Very fast pressure changes can damage the sensor, due to mechanical stress on the sensor; especially if the fast pressure change leads to an internal pressure which is higher than the full scale of the internal sensor (even if it is only for a fraction of a second). In some cases, the internal relief valves cannot react quickly enough to protect the sensor.



Notice

The Internal pressure sensors have a calibration certificate (see enclosure: calibration certificate) for the entire measuring chain.



Warning

The system is not suitable for use in areas with an explosion hazard.

If the CPC3000 is not used according to this manual, safe operation of the system is not guaranteed.

The user of the system and not the manufacturer is responsible for all personal and material damage resulting from improper use!

3.2 Features

1. The CPC3000 will control (up scale or down scale) into a 150 ml volume, to within 0.025 % of the set point, in 3 seconds or less.
2. Accuracy of 0.025 % FS, one year calibration interval.
3. Lightweight compact case with bezel and handle or 19" rack mount kit.
4. Manual operation via the color touch screen and easy access to auxiliary screens allow quick changes to the set point using the "STEP" and "JOG" screens.
5. Remote operation over IEEE-488, USB 2.0, or Ethernet.
6. Emulation of other conventional controllers.
7. An optional internal high accuracy barometric reference sensor for emulation of gauge pressure and absolute pressure.
8. A large color SVGA LCD display with a touch screen for intuitive operator interface.
9. Multiple languages.



3.3 Turning on the CPC3000

The power switch is located on the rear of the instrument as shown in "Figure - Rear Panel".

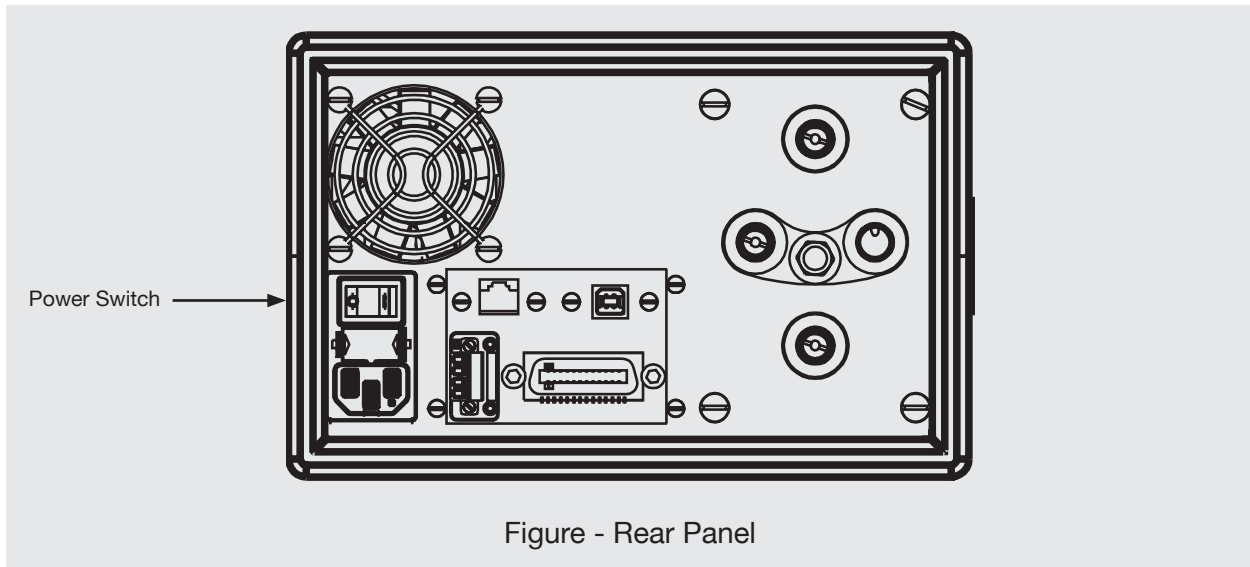

3.4 Front panel

The CPC3000 front panel (see above: "Figure - Front panel") includes a 7 inch colour SVGA display featuring touch screen technology. Operator input is accomplished by pressing the number, words or symbols presented on the display. There are no mechanical keypads or switches on the front panel.

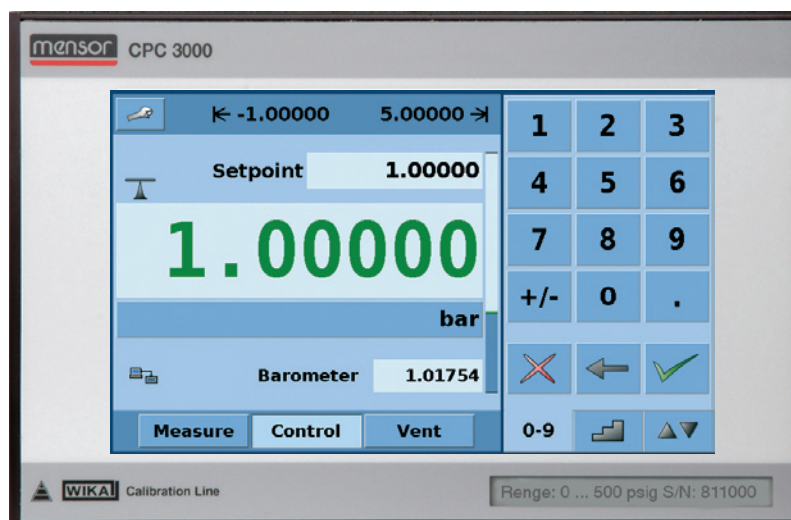

Figure - Front Panel

3.5 Main menu

When the CPC3000 is powered up it takes about one minute for initialization, then displays a screen similar to the "Figure - Initial Screen" below.

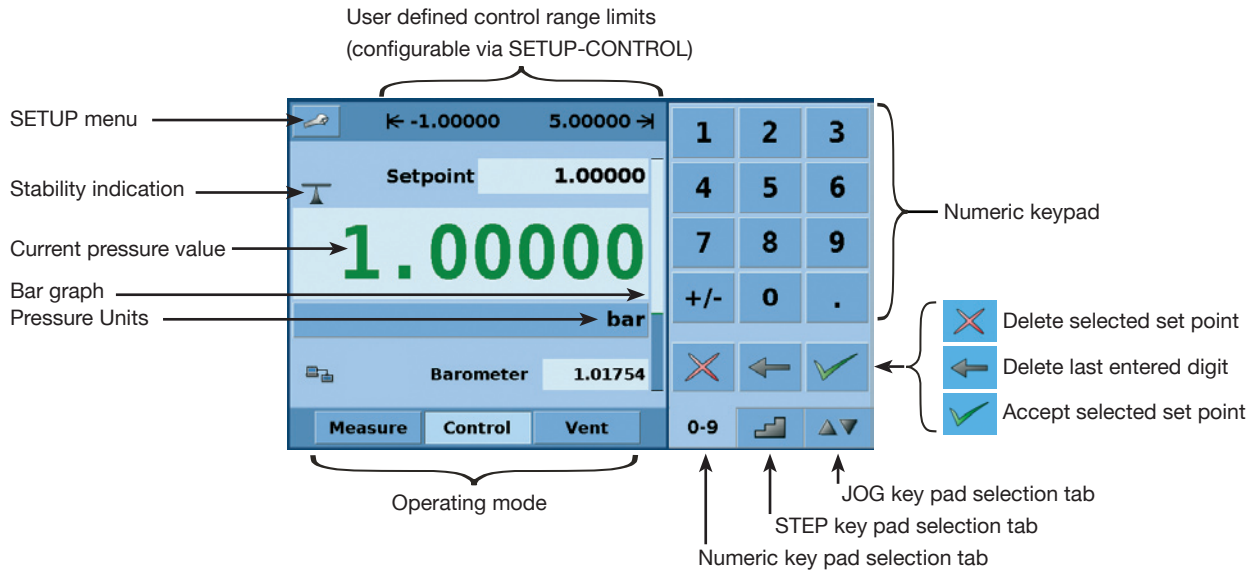

Figure - Initial Screen

3.5.1 Keys, Tabs, Check Boxes, Labels/Graphics

- Keys:** There are two types of keys: those that act as a switch to change a condition and those that open a data entry screen when pressed. Keys have borders with a three dimensional, shadowed effect (examples: **Measure** **Control** **Vent** , **1.00000**). Throughout this manual keys are represented with the displayed characters enclosed in brackets (Example **[MEASURE]**) or a description and the actual graphic icon (Example **[SETUP]**). Pressing a key will have one of the following results: 1) instant, single step response, 2) continuously repeating steps while the key is held down, 3) the key will change colors indicating that the associated function is active or 4) a data entry dialog box will open. Operators will quickly become accustomed to the particular characteristics of the frequently used keys.
- Tabs:** Tabs are analogous to tabs in a notebook that allow switching quickly between related screens. Tabs are keys that allow the operator to switch between a group of screens that have a similar purpose, for example the **0-9** tabs allow the operator to quickly switch between three screens used to enter the setpoint.
- Check Boxes:** Check Boxes allow for the inclusion or exclusion of specific elements or conditions.
- Labels and Graphics:** Labels and Graphics are text, or graphic that display information, but do not respond to being touched (examples: **← -1.00000 5.00000 →**). They indicate choices that have been made in the SETUP menus or indicate existing conditions as pressure is controlled or measured.

3.6 Front panel variations and navigation

Bar Graph: The bar graph shows the relative indication of the range of the internal sensor, the user defined limits on the internal sensor, the unused portion of the internal pressure sensor range, the setpoint and the magnitude of the actual controlled pressure. The user defined control limits can be selected in the **MAIN -> [SETUP] -> CONTROL SCREEN** and can be set to correspond to the range of the device under test. **It is important to note that when the STEP key pad is active in percent mode each step is a percent of the user defined limit not the full scale of the internal sensor.** This is useful when calibrating or testing various range devices. "Figure - Bar Graph" shows the bar graph when the CPC3000 is in control mode controlling a pressure at the setpoint.

Bar graph shows relative indication of:

- Range of the Internal sensor
- User defined limits
- Unused portion of the internal sensor range
- Setpoint
- Current pressure reading

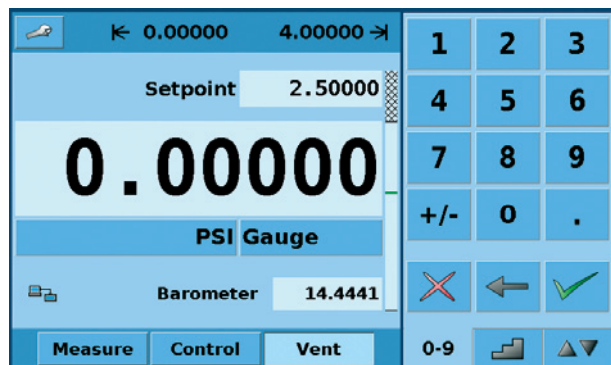

Figure - Bar Graph

3.6.1 Operating modes

Press **Measure** **Control** **Vent** to select mode:

- **MEASURE**
In MEASURE mode, the instrument measures the pressure connected to the MEASURE port (on changing from CONTROL mode: the last controlled pressure will be held/sealed in the connected test assembly).
- **CONTROL**
In CONTROL mode the instrument provides a very precise pressure at the MEASURE port.
- **VENT**
VENT opens MEASURE port to atmospheric pressure.

Optional elements can be chosen in the [SETUP-DISPLAY] screen explained in chapter 7.8.1 of this manual. Each optional element is displayed in the area below the pressure units.

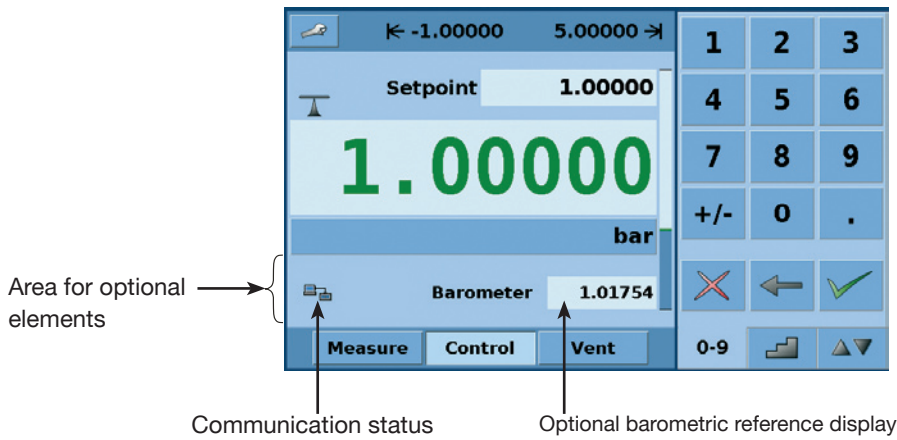

Figure - Optional Display elements

Navigation to the SETUP screens is achieved pressing the icon. SETUP "Figure - SETUP Display Screen" shows the SETUP screen with the display table activated. Other tabs at the bottom are used to navigate to additional SETUP screens. SETUP screens will be discussed in detail in chapter 7.8 of this manual.

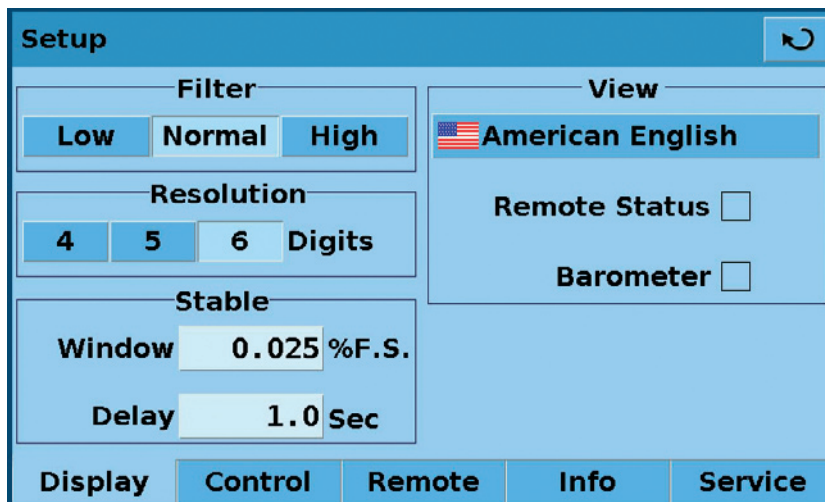



Figure - SETUP Display Screen

3.7 Main menu setpoint entry options

Pressure setpoint entry options are chosen using the tab keys **0-9**  .

"Figure - Numeric Keypad" shows the main menu with the numeric keypad selected.

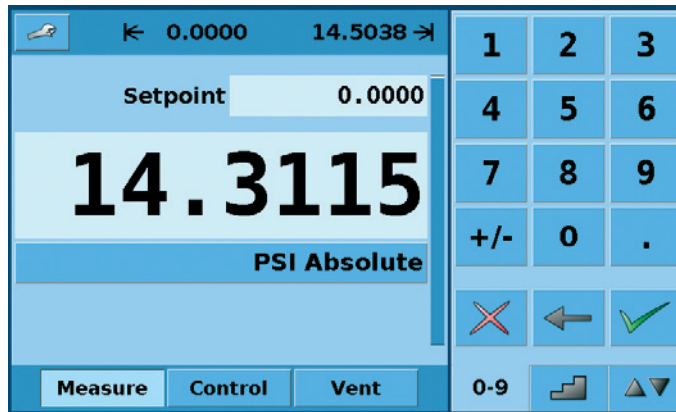

Figure - Numeric Keypad

"Figure - STEP Keypad" shows the main menu with the STEP keypad selected.

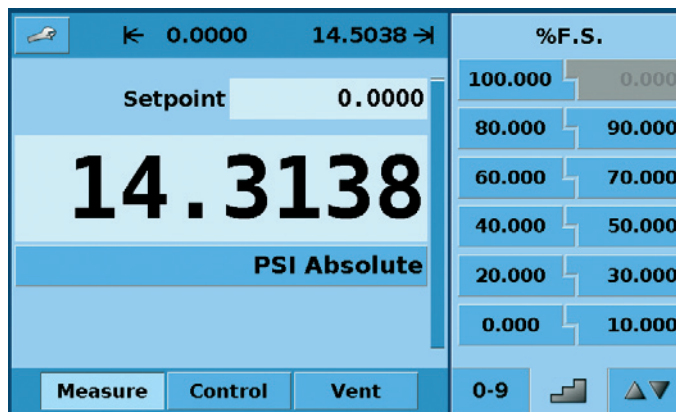

Figure - STEP Keypad

"Figure - JOG Keypad" shows the main menu with the JOG keypad selected.

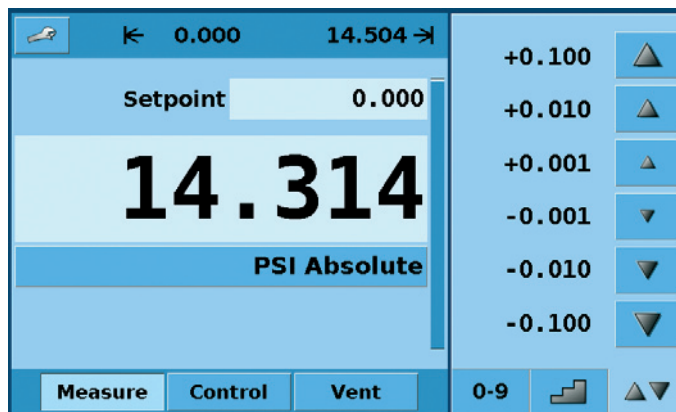

Figure - JOG Keypad

4. Specifications

Specifications	CPC3000	
Pressure ranges	bar	-1 ... +70 (depending on sensor)
Pressure types		Absolute, gauge or bi-directional ranges
Precision	% FS	< 0.015
Accuracy	% FS	< 0.025
Pressure units		33 selectable and 2 freely definable
Control stability	% FS	< 0.004
Slew rate	sec.	< 3 (with a sudden pressure increase of 10 % FS in a 150 ml test volume)
Control range	% FS	0 up to 100
Test volume	ccm	50 ... 1,000 (without throttle)
Pressure ports	mm	4 ports with 7/16" - 20 F SAE. incl. 6 mm tube fitting adaptors
Filter elements		40 micron filter element included in each pressure port
Permissible pressure media		clean dry non-corrosive gases
Wetted parts		aluminium, brass, 316 and 316L stainless steel, Buna N, FPM/FKM, glass filled epoxy, RTV, Nylon, Ceramic
Overpressure protection		safety relief valve
Instrument version		desk top/optional: incl. rack mounting kit
Screen		7.0" colour LCD with touch-screen
Resolution	digits	4 ... 6
Internal measuring rate	1/sec	25
Display update	1/sec	4
Warm-up time	min	approx. 15
Digital Interface		Ethernet, IEEE-488, USB
Command sentences		Mensor, SCPI, others optional
Power Supply	V AC	100 ... 240, 50-60 Hz
Energy Consumption	VA	maximum 90
Permissible pressure		
■ Supply port	% FS	~ 110
■ Measure/Control port	% FS	max. 105
Permissible		
■ Operating temperature	°C	10 ... 50
■ Storage temperature	°C	0 ... 70
■ Air humidity	%	0 ... 95 (relative humidity without moisture condensation)
■ Operating position		Horizontal or slightly tilted
Compensated temperature range	°C	15 ... 45
Weight	kg	approx. 9.1
Dimensions	mm	see technical drawings
CE-mark		Conformity certificate
Calibration*		Incl. factory calibration certificate 3.1 per DIN EN 10 204

* Calibration in a horizontal position.

5. Installation

5.1 Introduction

The initial installation of the CPC3000 includes the following steps: Unpack the system, place it in a suitable workspace, connect it, switch it on and configure.

5.2 Unpacking the system

Unpack all components of the CPC3000 carefully and check the parts for damage. Report any damage immediately to the forwarding agent.

Apart from any additional components ordered, a shipment consists of:

- CPC3000 controller
- ¼" and 6 mm tube fitting adapters
- Main cable
- Manual with calibration certificates in the enclosure
- Optional: recommend Interface cable or any other accessories ordered

5.3 Dimensions of the available version in mm

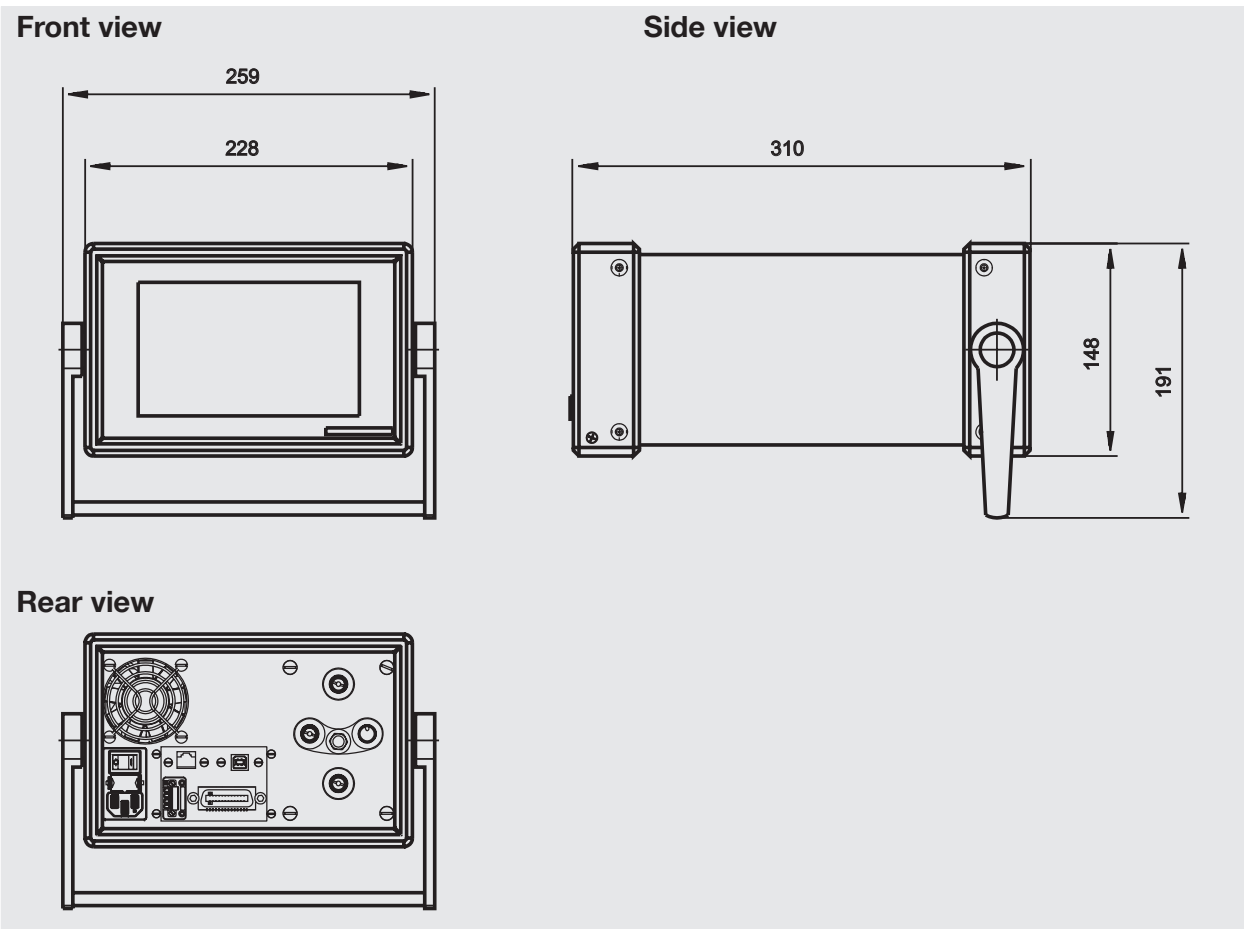

The instrument can be set up on a table top or it can be rack-mounted. Rack mount adapters are optional on the CPC3000 and require an adapter panel.

5.4 Installation of the system

The installation site must meet the following conditions:

- Operating Temperature: 10 to 50 °C
- Humidity: 0 to 95 % relative humidity non-condensation
- Flat, horizontal location; secure fixed working surface (desk top model) or installation in a 19" rack mount.
- At the back of the instrument sufficient air circulation must be provided for to avoid an accumulation of the heat conducted to the outside via the fan.
- During operation, pressure escapes through the VENT port in the back of the instrument. Personnel should not have access to the rear VENT and EXHAUST port during operation.

Avoid the following influences:

- Direct sunlight or proximity to hot objects
- Unstable installation position
- Mechanical vibration
- Proximity to sources of strong electromagnetic fields, such as high tension appliances, mobile telephones or mains
- Soot, steam, dust and corrosive gases
- Environment with explosion hazard, inflammable atmospheres

Pressure supply requirements:

- Stable supply pressure 10 % higher than the full scale of the internal transducer
- Permissible media: dry, clean air or nitrogen
- Vacuum: min. 50 litres/min (if required)



Notice

An angle of inclination of the system of more than 3 degrees can cause a deviation in the measured pressure and should be avoided. Zeroing the unit at the angle of inclination will nullify this deviation.



Warning

Applying supply pressure higher than the recommended pressure can cause permanent damage to the control channel!

5.5 Rear panel

Four pneumatic pressure ports are located on the rear panel (see below: "Figure - Rear panel"). Positioned on the left are the ethernet and RS-232 and GPIB connector, the off/on switch, the line fuses, and a protective grill covering the ventilating fan.

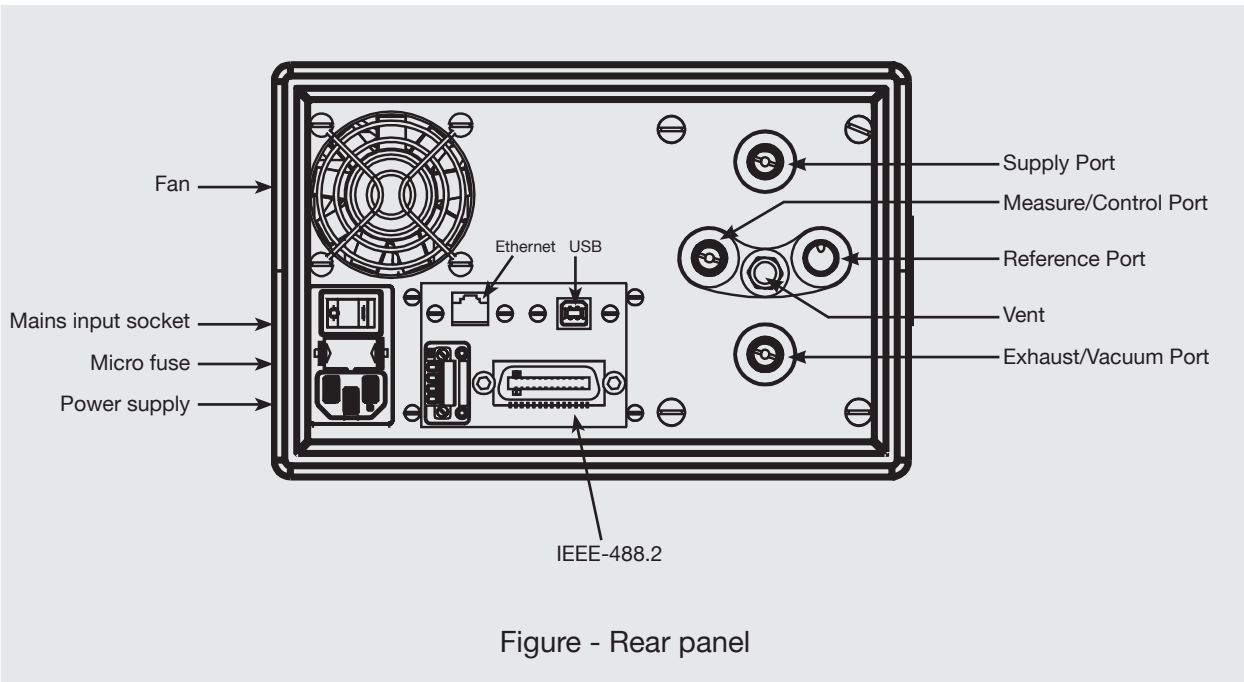

5.6 Pressure connections



Warning

The pressure connections must be installed according to the following instructions, observing the relevant regulations. The installation should be performed by persons familiar with, and who can work according to, the safety regulations for working on pneumatic/hydraulic systems.



Notice

When making up a connection to an o-ring adapter port use a back-up wrench to prevent over-stressing the threads in the manifold block.

All of the pressure ports on the rear are female 7/16 - 20 SAE/MS straight threads per MS16142 and SAE J514 table 14.

They require a tube fitting boss seal with an o-ring per MS33656.

WIKA provides female 1/4 inch and 6 mm tube fittings with the instrument.

The pressure connections can be made to these adapters with the proper mating hardware.

Do not use sealant on fittings sealed with an o-ring.

5.7 Function of pressure connections

■ MEASURE/CONTROL port

Below the label "MEASURE/CONTROL" is a pressure connection. In MEASURE mode this connection connects the pressure applied to the internal sensor where the pressure is measured (within the range of the internal sensor). In CONTROL mode this connection supplies an output pressure controlled by the internal regulator at the commanded setpoint.

■ SUPPLY port

Below the label "SUPPLY" is a pressure connection. This connection should be supplied with a pressure that is approximately equal to 110 % of the full scale pressure of the internal sensor. In other words, 10 % above the full scale pressure of the internal sensor (see "SUPPLY Pressure" in the specifications chapter for supply pressure and pressure media requirements.)

■ EXHAUST/VACUUM port

Below the label "EXHAUST/VACUUM" is a pressure connection.

If a sub-atmospheric control pressure is required a vacuum pump must be connected to this port. Otherwise, this port may be left open to atmosphere.



Warning

The user must use caution when controlling from a very high pressure down to a very low pressure when a vacuum pump is connected to the exhaust port. Large volumes of gas may be present in the device under test and will exhaust through the EXHAUST/VACUUM port in excess of the capacity of the internal relief valve, possibly causing damage to the vacuum pump.

■ VENT outlet

Below the label "VENT" is the pressure outlet. In VENT mode the pressure within the system is released through this outlet.



Warning

HIGH SOUND LEVELS! Pressures from 40 bar and up can generate sound levels above 100 db for brief periods when they are exhausted directly to atmosphere. If no muffling devices are attached to the EXHAUST/VACUUM and VENT port, then ear protection is advised for personnel in the vicinity of the instruments that will be operated under such conditions.

■ REFERENCE port

On gauge units this port is connected to the reference side of the transducer, and on absolute units it is internally capped. This port is normally left open to atmosphere.



Warning

The controller must be protected from over pressure.

Pipes, couplings and other components used for connecting the supply exhaust and the MEASURE/CONTROL port must be suitable for the application and rated for the applied pressures.

The user must ensure that the pressure media are clean and dry. If necessary, the internal sensors and mechanisms must be protected by using a liquid trap or coalescing filter.

5.8 Electrical connections



Warning

The electrical installation has to be carried out according to the following instructions while observing the relevant regulations. It is to be carried out by a qualified electrician.

5.8.1 Connecting the power supply and turning on the instrument



Warning

Before connecting the power supply, make sure that the mains voltage agrees with the specification of the power unit. Switch off the system before connecting the mains via the main switch at the rear of the instrument.

Only the mains cable supplied should be used.

The 3-pole mains cable supplied is fitted with an earth lead. You should therefore operate the system only from a three-pin socket and always make sure that the earth lead is properly connected.

The mains input socket is to be connected according to the regulations with the country-specific connection cable supplied to a power supply that lies within the required specification. To power-on the instrument switch the power switch ON (located on the rear of the instrument; also see chapter "6. Starting operation").

5.8.2 Connecting the Communications interfaces

USB 2.0 FS Interface

The USB 2.0 FS connection on the rear panel of the CPC3000 is a USB-B Type connector. The manufacturer of the USB interface board provides the drivers and product information on a CD that is included with the CPC3000.

IEEE-488 Interface (GPIB)

The connection of the IEEE-488 interface is designed as a 24 pole IEEE-488-socket. The manufacturer of the host IEEE-488 interface board provides software to allow communication between the board and various programming languages.

An interactive program for debugging is usually provided as well. Refer to the board manufacturer's documentation for more information.

ETHERNET Interface

The ethernet communication port allows the CPC3000 to communicate with computers using 10/100 Based-T specifications.



Warning

Please consult your Computer Resources Department prior to connecting this instrument to your network to verify there are no conflicts with existing IP addresses.

Ethernet communications are transmitted over a standard RJ-45 cable.

Prior to first time use of ethernet communication, the four parameters "IP", "Netmask", "Gateway" and "Port" must be SETUP. These are configured in the communications SETUP screen.

6. Starting operation



Warning

Before the system is switched on, verify that the system was installed according to the instructions of the previous chapter and that all connections installed are fitted according to the current regulations.

Operators must ensure that all specifications that apply to supply voltage, operating temperature, humidity, pressure media and pressure ranges are observed.

Condensation can occur inside the system when the temperature changes abruptly. Give the system sufficient time for acclimatisation in such cases.

Before pressurizing, the operator must ensure that the system and the device under test will not be over pressurized. When working with or on the instrument, safety glasses have to be worn.

In the rooms in which the CPC3000 is operated sufficient air ventilation has to be ensured.

When the above points have been met you can switch on the system, (the switch is located on the rear of the instrument) and configure it as required after you have familiarised yourself with the operation (see chapter: "7. Operation via Touch-screen").

After turning the power switch to ON, the instrument will go through a brief initialization process and system check, which will take about 40 seconds.

As soon as the system check is completed the system will default to an operating screen similar to "Figure - Initial screen" in chapter 3.6.



Allow at least 15 minutes of warm up time to achieve thermal equilibrium between the controller and its environment before performing critical pressure measurements.

7. Operation via Touch-screen

This chapter describes the procedures for operating the CPC3000 from the front panel.



- **Tabs, Keys, Value Entry and Check Boxes:**
Local operation is accomplished by observing the data presented in the display menus, then pressing the on-screen **tab**, **key**, **value entry** or **check box** for the desired sub-menu, function or selection. Tabs are used to access the subset of a menu, keys open new menus, make selections or change a parameter, value entry opens a keypad to enter a value, and check boxes allow choice of associated display option.
- **Screen hierarchy:**
Navigation within the CPC3000 is similar to a computer file system or a web page. Keys or tabs activate sub-menus. Within the sub-menus there may be related sub-menus or selections. To return back through the hierarchy of screens the **[BACK]**  key is provided. Throughout this manual screen hierarchy will be designated using the following convention: "**MAIN -> SUB-MENU -> SELECTION**" or "**MAIN -> SUB-MENU -> TAB -> SELECTION**". The hierarchical menu structure is very intuitive and will become more obvious after reviewing following examples.

7.1 Setting the operating language

In the upper left corner of the main display is the **[SETUP]** key . To change the language select the SETUP key and select the **[DISPLAY]** tab if not already active. In the box labelled "VIEW" on the upper right side of the resulting "**MAIN -> SETUP -> DISPLAY**" screen there is a **[FLAG]**  key. Press the **[FLAG]** key and a selection of language keys will appear. Select the desired language. Then press the **[BACK]** key to return to the main menu which will now display in the selected language. Using our convention, selecting English would be described by the following: "**MAIN -> SETUP -> DISPLAY -> FLAG -> ENGLISH**".

7.2 Display configuration

The CPC3000 main menu "Figure - Main Menu" shows the main screen that appears when the unit is turned on. A point by point description of each element is shown in this figure. The **[SETUP]** key  opens the SETUP menu where changes can be made and information viewed. Each sub-menu in the SETUP menu can be activated by pressing the **[DISPLAY]**, **[CONTROL]**, **[REMOTE]**, **[INFO]** or **[SERVICE]** tab. Each of these SETUP sub-menus will be discussed in detail in chapter 7.8.

The points on the main menu that are independent of the SETUP menus are the setpoint indication, the actual pressure reading, the units of measure and the control modes (**MEASURE**, **CONTROL** and **VENT**), plus the three tab menus **0-9**    used for selecting a setpoint. The **[PRESSURE UNIT]** key indicates the currently chosen pressure unit and can be pressed to open a menu that allows selection of English, metric, or user defined pressure units.

The CPC3000 main menu shown in "Figure - Optional Elements" shows elements that can be displayed on the main menu and describes the three choices available for setpoint entry (Numeric keypad, STEP and JOG). Optional elements include the Communication status icon which indicates a connection or disconnection from a remote computer, and the barometric reference indication showing the value of the atmospheric pressure measured by the optional internal barometric reference sensor.

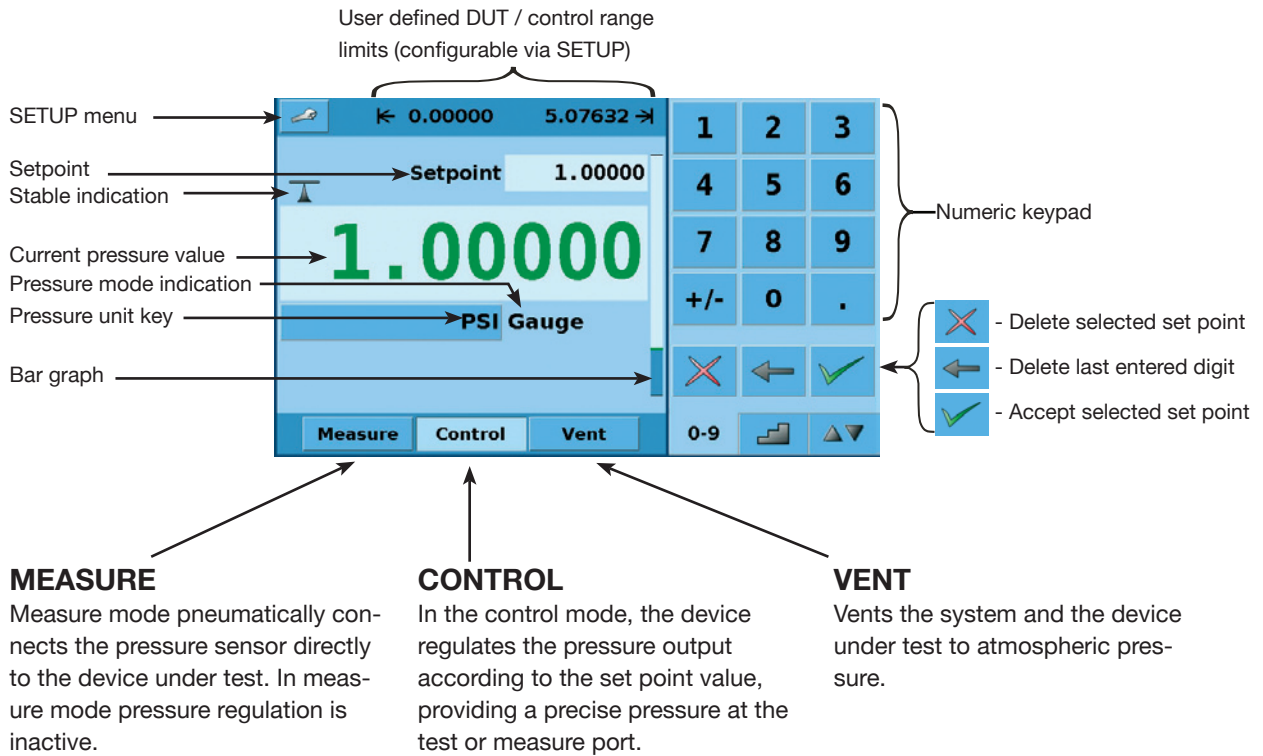

Figure - Main Menu

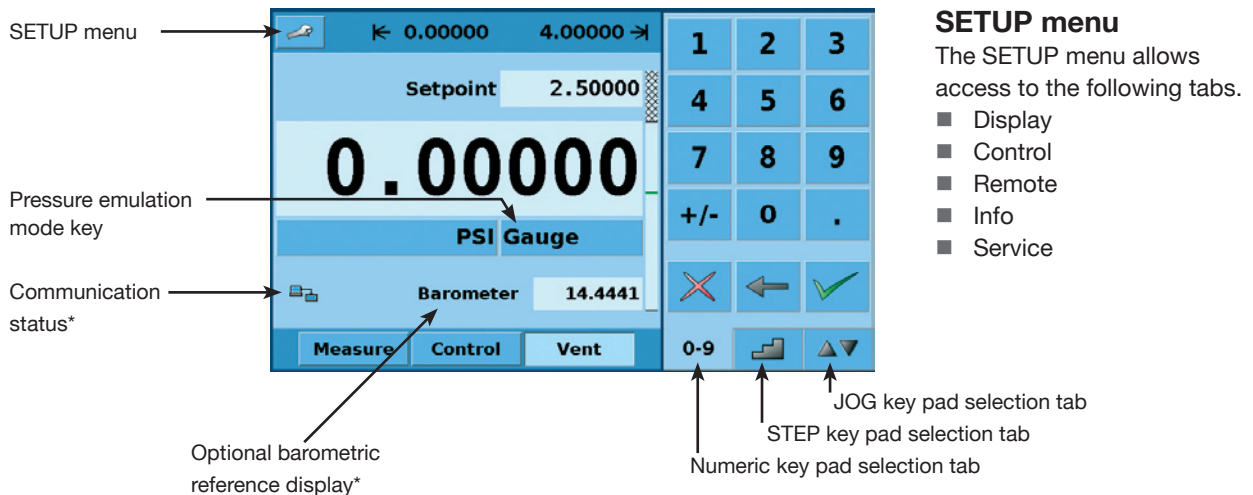

Figure - Optional Elements

Note: See the following page for detailed information on each set point entry screen.

7.3 Setpoint Entry





The control setpoint can be entered using the default numeric keypad or the alternate STEP or JOG keypads that appear on the right side of the main menu when selected using the **[SETPOINT ENTRY SIDE-MENU]** tabs **0-9**   on the lower right hand side of the main menu. These alternative methods of entering the setpoint have advantages in different situations and have been designed to increase ease of use and productivity.



Figure - Numeric Keypad

The numeric keypad shown in "Figure - Numeric Keypad" to the left, is the default keypad that appears every time the unit is turned on or can be activated using the **[0-9]** tab. A setpoint value can be entered directly using this keypad. As the value of the setpoint is entered the setpoint field will turn blue and the entered value will appear in the field. The Setpoint value can be deleted completely using the **[DELETE]**  key, the last digit of the entered setpoint can be deleted using the **[CLEAR ENTRY]**  key or the setpoint value can be accepted using the **[ACCEPT ENTRY]**  key. When the **[ACCEPT ENTRY]** key is pressed the setpoint field will turn white and the new setpoint will become active. In control mode, the controller output will ramp to the entered setpoint. **Caution:** If the **[ACCEPT ENTRY]** key is not pressed the previously entered setpoint will remain active.

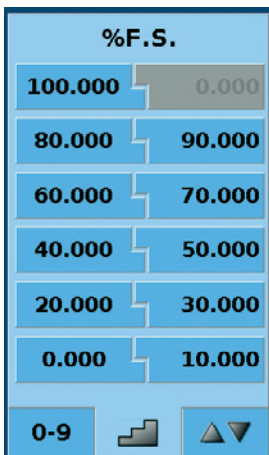
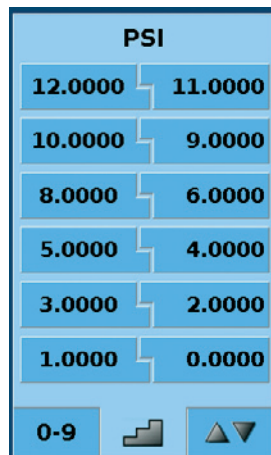

Figure - STEP Keypads



The STEP keypads shown in "Figure - STEP Keypads", provide a way to increment the setpoint by defined steps. Steps are a percent of the user defined limits set in the **MAIN -> SETUP -> CONTROL** or actual pressure values that are displayed in the pressure units selected in the main menu. A total of 12 steps are provided. When a step is pressed the related setpoint is immediately entered as the active setpoint. In control mode, the controller output will ramp to this setpoint. The STEP Keypad can be modified in the **MAIN -> SETUP -> DISPLAY** menu discussed in chapter 7.8.1.



Figure - JOG Keypad

The JOG Keypad shown in "Figure - JOG Keypad", provides a way to jog the setpoint up or down by small increments. The increments are determined by the resolution, the maximum control limit and/or the units of measure. For example, if the resolution is set to display four decimals then the small triangle pointing up will change the setpoint by +0.0001 and the small triangle pointing down will change the setpoint by -0.0001. In the same way, the medium triangles will change the setpoint by ± 0.0010 and the large triangles will change the setpoint by ± 0.0100 as shown in the figure. When the Resolution, the maximum control limit or the units of measure are changed so that three decimals are displayed, then the JOG functions will change to ± 0.001 , ± 0.010 and ± 0.100 respectively. This is useful when adjusting the pointer of a manometer congruent to the scale.

7.4 Operating modes

The selection keys for the operating modes MEASURE, CONTROL and VENT are located at the bottom of the main menu.

■ [MEASURE]:

In MEASURE mode, the instrument measures the pressure connected to the **MEASURE/CONTROL** port. "Figure - MEASURE Mode" shows the state of the isolation valves in MEASURE mode.



When the CPC3000 is turned off all the valves close and could trap pressurized gas within the pneumatics. It is safe practice to vent after use and before connecting any devices to the MEASURE/CONTROL port.

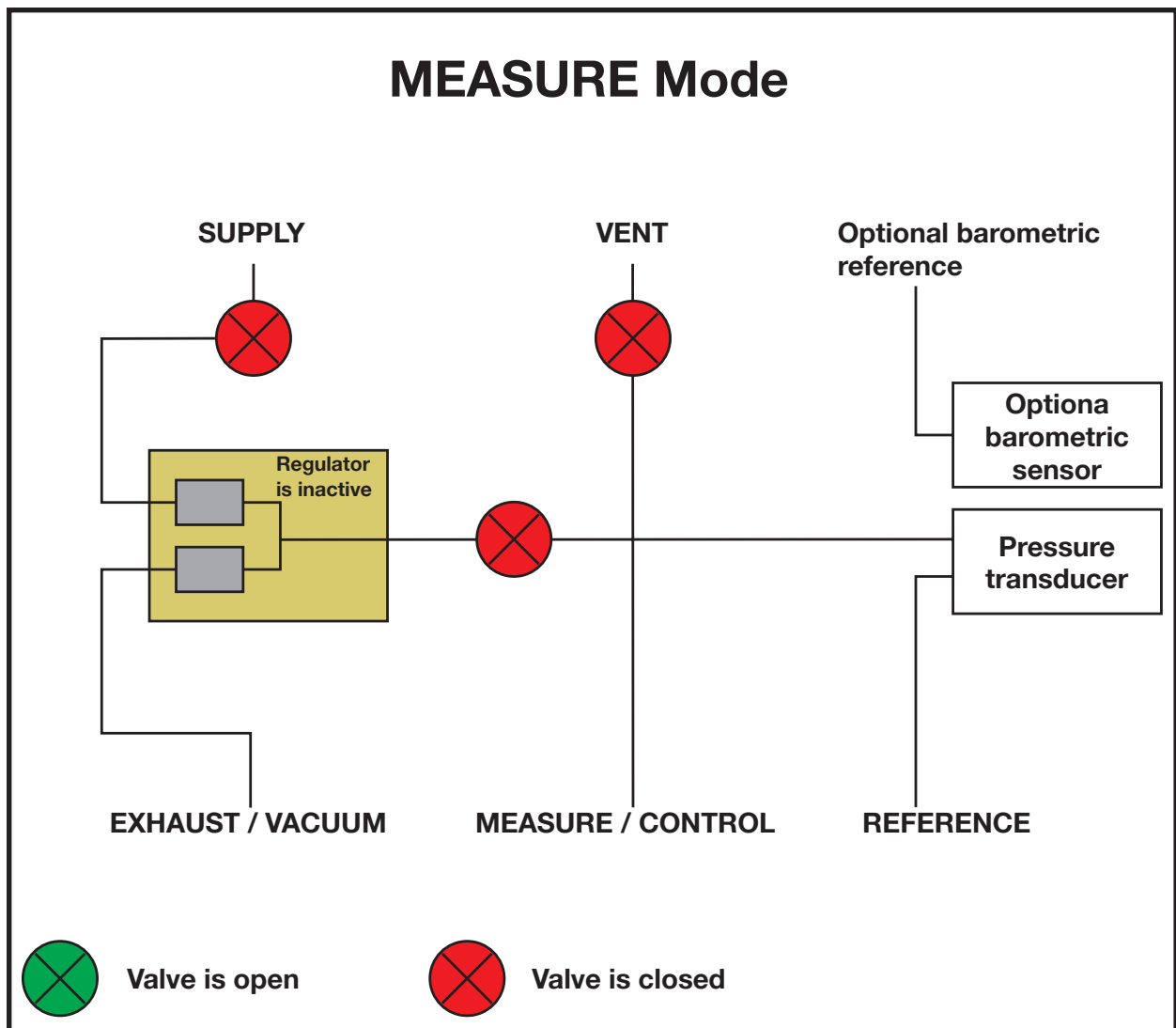

Figure - MEASURE Mode

■ **[CONTROL]:**

In CONTROL mode the instrument provides a precise pressure output (equal to the setpoint +/- the stability specification) at the **MEASURE/CONTROL** port. The indication of the current pressure value will turn green when the setpoint has been reached and the stable window settings have been satisfied. "Figure - CONTROL Mode" shows the state of the isolation valves in measure mode. Notice that the regulator is active in the CONTROL mode.

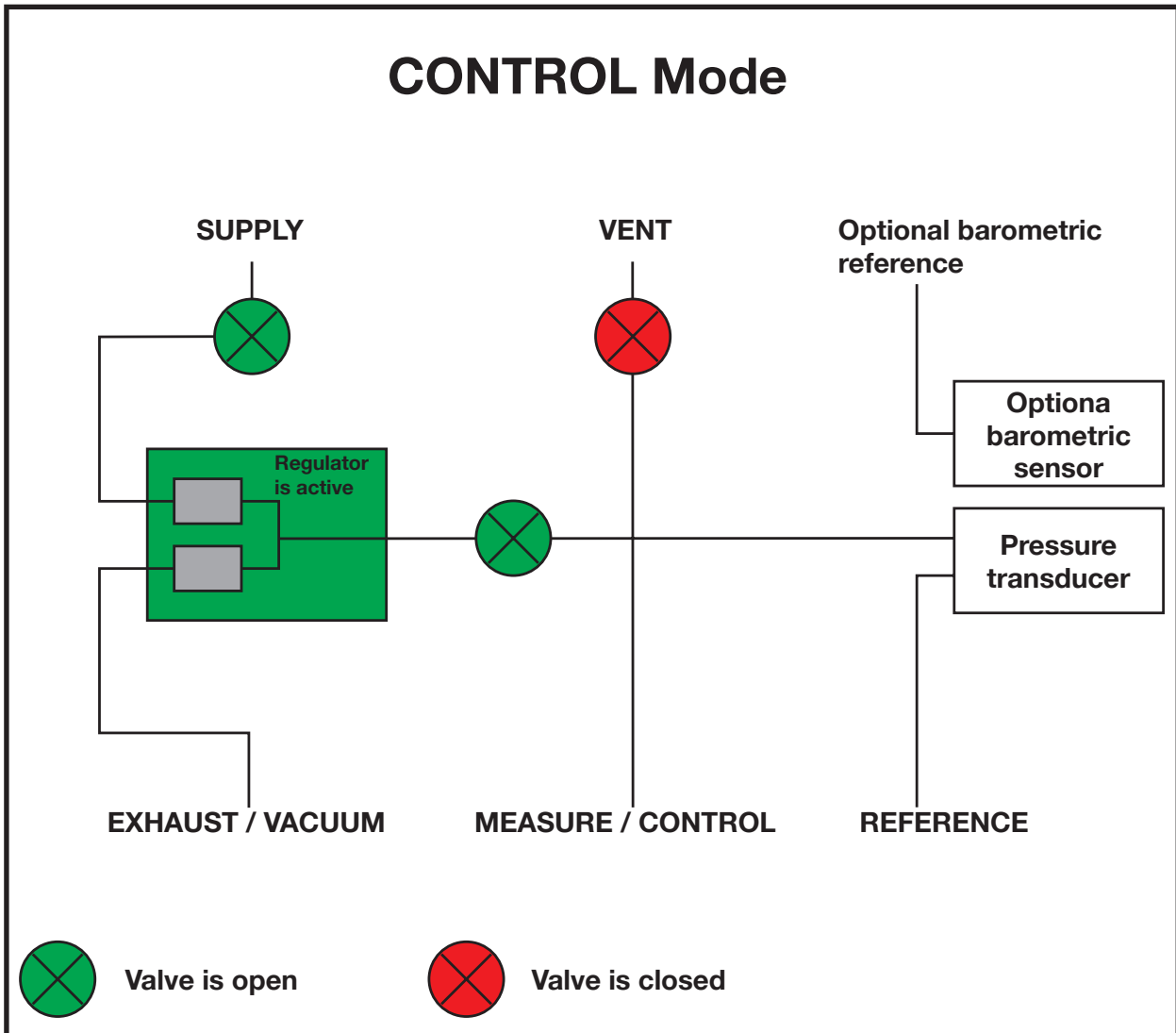

Figure - CONTROL Mode

■ **[VENT]:**

VENT mode vents the pneumatic system and shuts off the supply. "Figure - VENT mode" shows the state of the isolation valves in VENT mode.

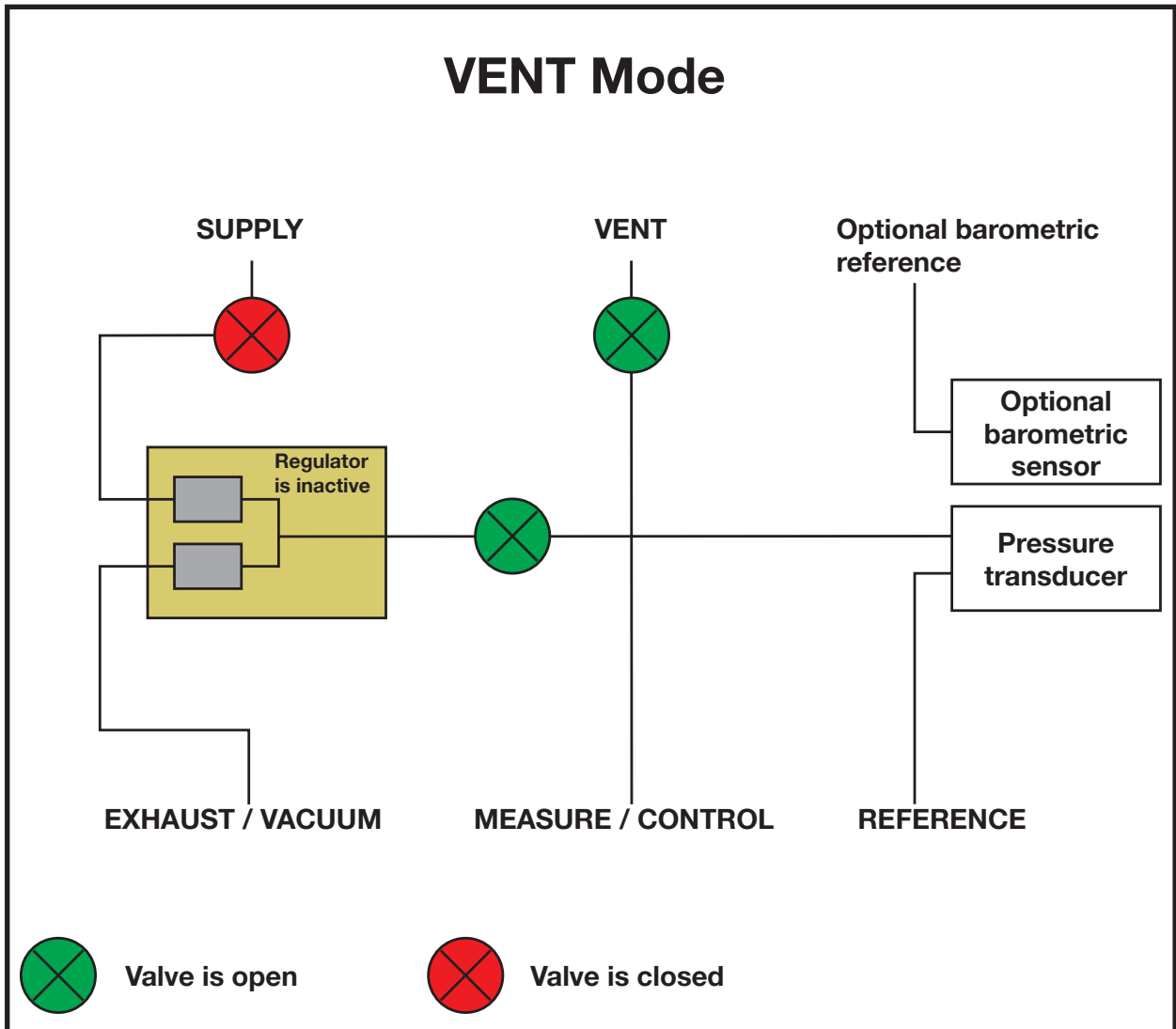





Figure - VENT Mode

7.5 Data Entry

When there is a requirement to enter specific numeric or alpha values into the system, the method of entry is consistent for all instances. When a **[VALUE ENTRY]** key is pressed a dialog box will appear similar to "Figure - Value Entry". This Value Entry dialog box will have a numeric or alpha keypad, when appropriate minimum and maximum value limits, current value and a window that shows the new value entered. The value can be deleted completely using the **[DELETE]**  key, the last digit of the entered setpoint can be deleted using the **[CLEAR ENTRY]**  key or the setpoint value can be accepted using the **[ACCEPT ENTRY]**  key.

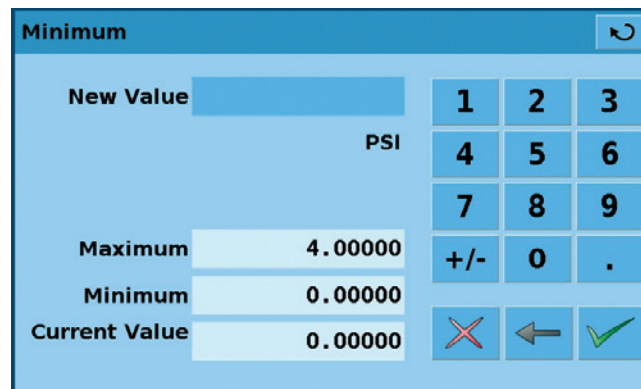

Figure - Value Entry

7.6 Pressure unit, Pressure mode and Emulation mode

The Pressure **[UNIT]** key is shown on the main screen below the current pressure value and displays the most recently chosen pressure units and the mode (absolute or gauge). If the optional barometric reference is installed a **[MODE]** key replaces the mode indication to the right of the units key. This **[MODE]** key indicates absolute or gauge mode. When the key is pressed it will switch between the "native mode" of the internal sensor to the emulation mode. The "native mode" is the mode of the sensor that is installed and is either absolute or gauge. Emulation mode uses the value of the barometric reference to emulate the mode that is alternate to the native mode. The CPC3000 can emulate gauge from a native absolute sensor or absolute from a native gauge sensor. The **[MODE]** key indicates the native mode with a blue key background and emulation mode with a light blue key background. The units and mode chosen remain the same when the CPC3000 is turned off then back on.

PSI Gauge	Native sensor is gauge, no barometric reference installed.
PSI Gauge	Native sensor is gauge, barometric reference installed.
PSI Absolute	Native sensor is gauge, barometric reference installed and absolute emulation active.

Pressing the **[UNITS]** Key will open a dialog box that shows the available pressure units with a tabs for **[ENGLISH]**, **[METRIC]** and **[USER UNITS]** units. Pressing a tab will open a menu with the related set of units available. The **[USER UNITS]** tab menu includes **[USER 1]** and **[USER 2]** keys and allows the user to enter customized pressure units. Press the **[MULTIPLIER VALUE]** key to enter a multiplier that defines the user unit as the multiplier times one psi or one Pascal, whichever is currently pressed.

A gray background on a **[PRESSURE UNITS]** key indicates that it is the current selection. Touch any other **[PRESSURE UNITS]** key, and press **[BACK]** key to enable change and return to previous operation screen. All of the displayed pressure values will have changed to correspond to the newly selected units.

7.7 Bar Chart

The Bar chart shows the relative indication of the current pressure value with respect to the full scale value of the internal sensor and the user defined minimum and maximum limits (see chapter "7.8.7 for SETUP of user defined limits"). The full height of the bar graph is proportional to the internal sensor range. The green line indicates the magnitude of the setpoint. The blue column indicates the magnitude of the current pressure. The cross hatched section indicates the portion of the internal sensor above or below the user defined limits that is not being used.

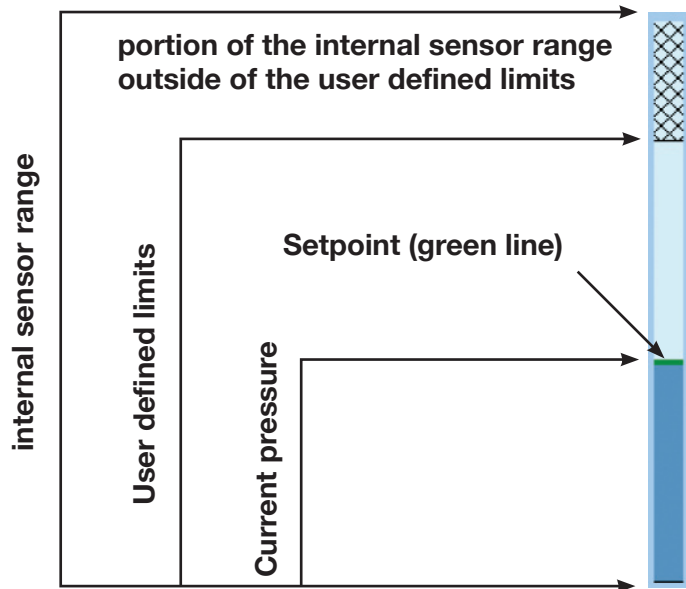

7.8 SETUP Menus

The SETUP menus are opened by pressing the **[SETUP]**  key. This opens the menu shown in "Figure - SETUP". The SETUP menu has five tabs: **[DISPLAY]**, **[CONTROL]**, **[REMOTE]**, **[INFO]** and **[SERVICE]**. Each tab is described in detail in the following chapters. The screen below has the **[DISPLAY]** tab active.

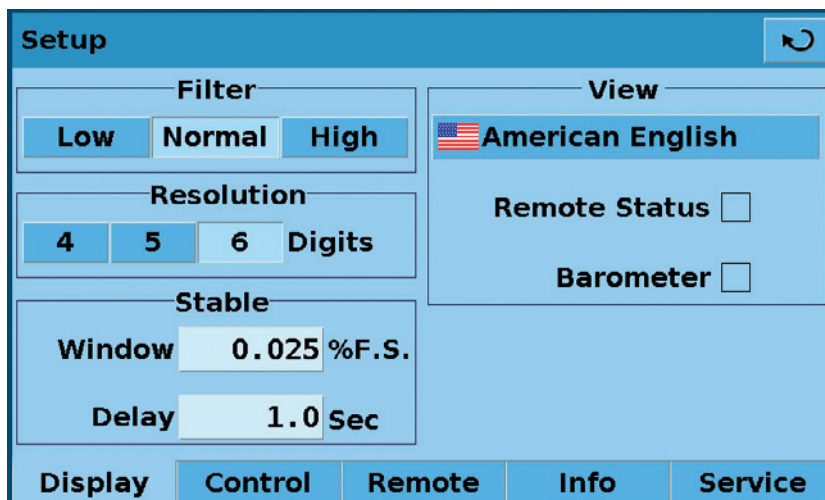

Figure - SETUP

7.8.1 SETUP Display

The **MAIN -> SETUP -> DISPLAY** menu contains elements that change the appearance and function of components displayed on the main menu. Following is a description of the elements of this menu.

- **Filter:** The filter selection keys **[LOW]**, **[NORMAL]**, and **[HIGH]** dampen the pressure display to reduce the affect of pneumatic noise associated with the device under test or the test environment.
- **Resolution:** The resolution section of the SETUP Display menus allows the user to change the resolution of the current pressure reading to be **[4]**, **[5]** or **[6]** digits.
- **Stable Window and Delay:** The stable window is the percentage of the full scale value of the internal sensor that the current pressure can deviate (+/-) from the setpoint and still display a stable indication. The stable delay is the number of seconds that the instrument must remain within the stable window before the stable indication is displayed.
- **Language:** The "VIEW" section of the SETUP display menu shows a flag, a country and a language on a key. This is the current language. Press this key to access a menu containing other languages that are available. "Figure - Languages" below shows the language selection screen.



Figure - Languages

- **Remote Status Checkbox:** The Remote status check box enables or disables the remote status icon on the main menu. This icon will show a broken wire when there is no connection to a remote computer or a connected wire if the computer is connected.
- **Barometer (optional):** The Barometer check box enables or disables the indication of the barometric pressure on the main menu.

7.8.2 SETUP Control

Configuration of parameters associated with setting limits and adjusting parameters used to control pressure are configured in the **MAIN -> [SETUP] -> [CONTROL]** menu shown in "Figure - SETUP Control".

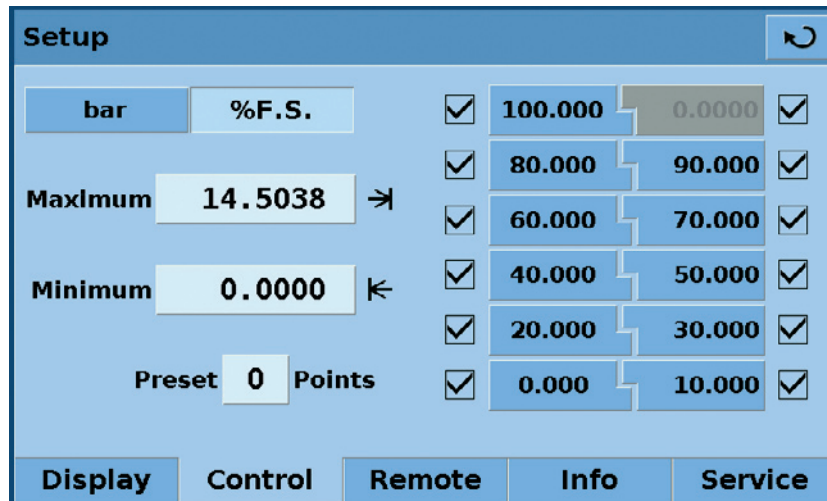

Figure - SETUP Control

- Maximum and Minimum Control Limits:** The **[DATA ENTRY]** keys next to the **[MINIMUM]** and **[MAXIMUM]** labels in "Figure - SETUP Control" allow the operator to select any range within the full scale range of the internal sensor. This is the "user defined range". For example: if the CPC3000 has a 0-5 bar internal sensor, the user can define a range of 0-4 bar. When the user defined range is changed, a corresponding change occurs in the STEP menu so that the percent STEP will equal the corresponding value within the user defined range. For example: the 80 % value of a 0-4 bar user defined value range will be 3.2 bar but for a user defined range of 0-2 the 80 % value equals 1.6 bar. **The user defined range can be set to the same range as the pressure device being tested. This useful when there is a test that requires calibration at intervals equal to a percentage of the range.** Each individual step can also be changed by pressing the **[STEP]** **80.000** key and entering a new value.
- Bar or %FS:** The **[SELECTED UNITS]** and **[%FS]** **bar** **%F.S.** keys switch the STEP keypad display in the main menu and on the SETUP screen from the user selected units to percent of the full scale of the user defined range. The values when shown in the **[SELECTED UNITS]** mode correspond to the values in the **[%FS]** mode. For example, in "Figure - PSI Mode", the **[PSI]** key is pressed and the value shown in the 100 % step is 4.0000 corresponding to the maximum limit chosen in this same screen. Individual steps in %FS or selected units mode can be included or excluded from the step menu by changing the **[Check Box]** next to the STEP.

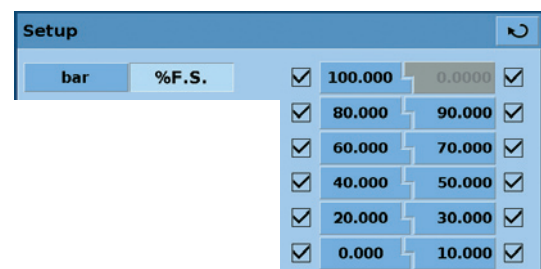

Figure - "PSI Mode"

- **[Preset Points]** allows the operator to select the number of points that appear as steps. For example: in "Figure - preset points" [5] is entered as the preset points value, this automatically configures 5 points from 0 to 100 % of user defined range. It automatically calculates the steps that populate the STEP keypad in the main menu.

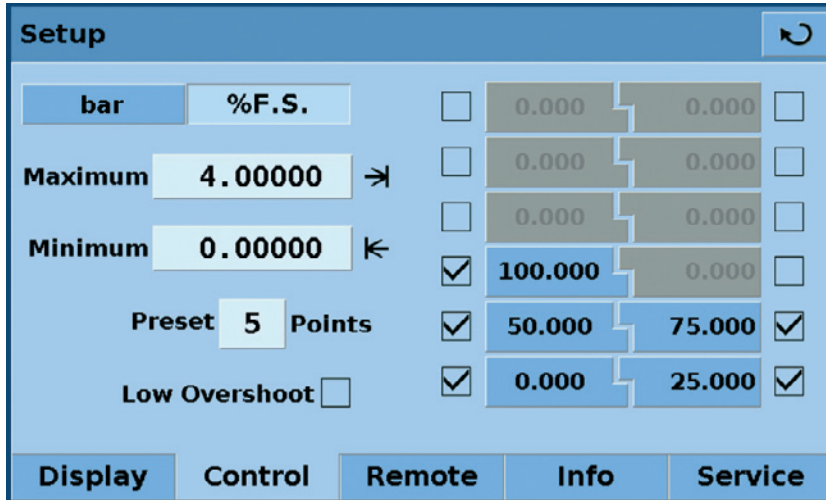

Figure - Preset Points

7.8.3 SETUP Remote

Configuration of parameters associated with remote communication are set up in the **MAIN -> [SETUP] -> [REMOTE]** screen. Detailed information on SETUP of Ethernet USB and IEEE-488 are given in chapter 8. "Remote Operation".

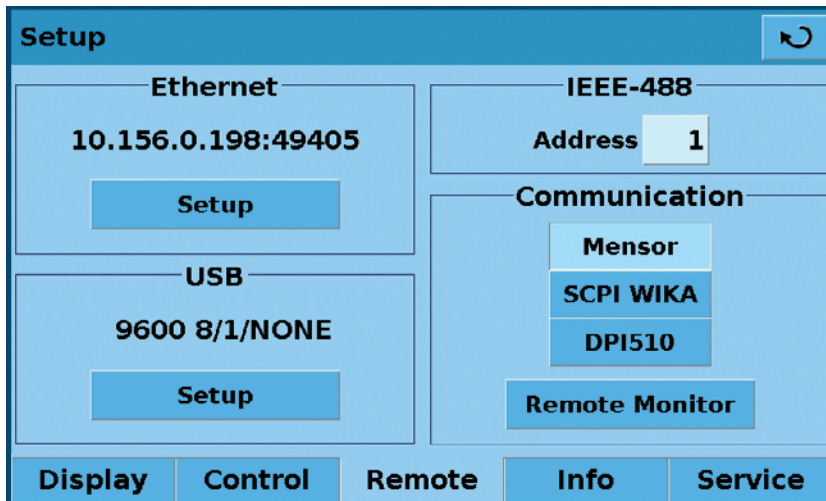

Figure - SETUP Remote

- The ethernet SETUP key opens a dialog box where host name, IP, netmask, gateway, port, and client IP can be entered. There is also a check box that will activate (checked) or deactivate (unchecked) Dynamic Host Configuration Protocol (DHCP). DHCP is a protocol used by networked devices (clients) to obtain the parameters necessary for operation in an Internet Protocol network. This protocol reduces system administration workload, allowing devices to be added to the network with little or no manual configuration.

- The USB SETUP key opens a dialog box where baud rate (9600, 19200, 38400, 57600, or 115200), data bit (7 or 6), stop bit (1 or 2), parity (none, odd or even) can be chosen. There is also a check box that turns echo on (checked) or off (unchecked).
- The IEEE address data entry button when pressed will open a data entry dialog box where the IEEE address can be entered.
- In the Communication section there are three remote command set emulation settings. The **[MENSOR]** key enables the standard mensor command set, the **[SCPI WIKA]** key enables the WIKA SCPI (Standard Commands for Programmable Instrumentation) command set structure, and the **[DPI510]** key enables the command set that will communicate with the Druck DPI 500 series of controllers. In this section there is also a **[REMOTE MONITOR]** key that will open a screen that shows the most recent commands and responses sent and received plus any errors. Details of each command set are given in chapter 8.5.

7.8.4 SETUP Info

The **MAIN -> [SETUP] -> [INFO]** screen, "Figure - SETUP info", provides MENSOR contact information plus the Model number, serial number, min and max range and the native pressure units of the internal sensor, date of calibration and the software version installed. This is an information screen only and does not contain any interactive keys.



Figure - SETUP Info

7.8.5 SETUP Service

The SETUP service screen is a password protected area where calibration of the sensor and SETUP of the regulator is accomplished.

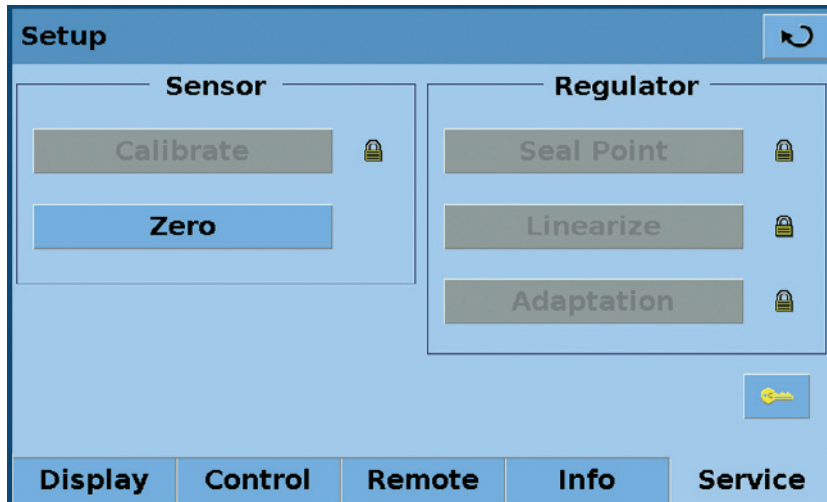

Figure - SETUP Service

The SETUP service screen allows zero adjustment without entering the password. A zero adjustment screen, "Figure - Zero", opens when the **[ZERO]** button is pressed. A new zero value can be entered in this screen.

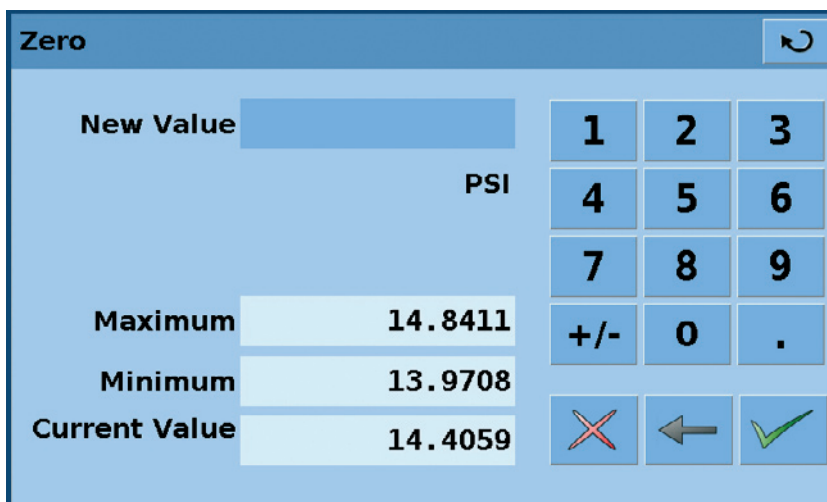



Figure - Zero

To access the password protected portion of the SETUP service screen press the  key. This opens a password entry screen, "Figure - Password", where the password can be entered. Entering the password will open the SETUP service screen, "Figure - SETUP Service Unlocked", and allow access to all the SETUP options.

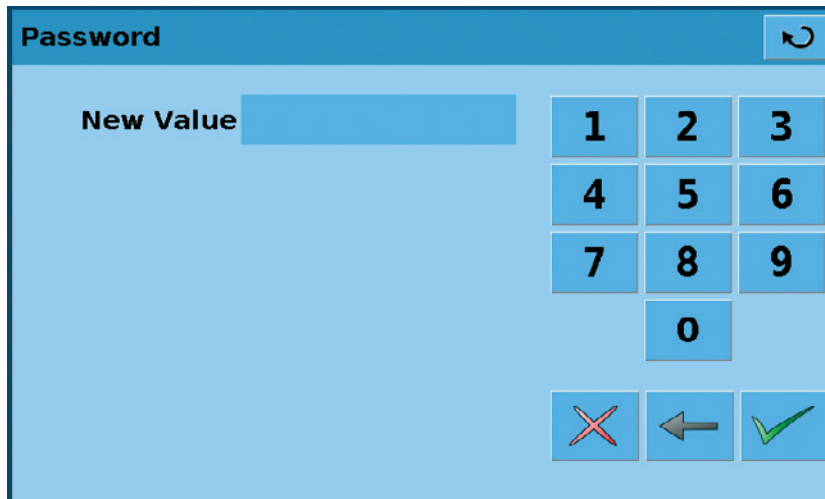

Figure - Password

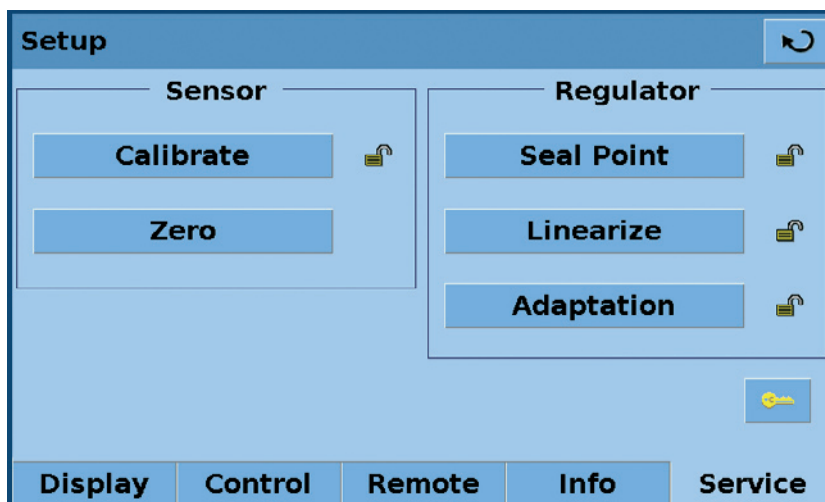

Figure - SETUP Service Unlocked

After the password has been entered the SETUP Service screen allows access to the Calibrate, Seal Point, Linerize, and Adaptation screens.



Warning

Consult factory before changing any Seal Point, Linerization or Adaptation parameters.

Press the **[CALIBRATE]** key to access the calibrate screen, "Figure - Calibrate Data".

The screenshot shows the 'Calibrate' screen with the following data:

Serial Number	780005	14.4060 PSI
Zero	0.0000	Measure Vent
Span	1.000000	
Date of Calibration	09/18/2008	

At the bottom, there are three tabs: **Data**, **Edit**, and **Calibrate**.

Figure - Calibrate Data

The Calibrate screen contains three tabs: DATA, EDIT AND CALIBRATE. When entering the calibrate screen the first time the Data Screen is the default. The Data screen allows changes to be made to the Zero, Span, Date of calibration and displays the sensor reading.

The screen accessed by pressing the **[EDIT]** Tab, "Figure - Calibration Edit", allows calibration using data available from a previous calibration. An example of this is when an As-Found calibration is performed and the applied and measured pressures from the calibration are available. The low true pressure should be less than 20 %FS and the high true pressure should be greater than 80 %FS for best results. To edit the calibration from known data, enter the applied pressures in the Desired column and the measured pressures in the Actual column by pressing the number to be adjusted. When the values are changed, a new key "APPLY" will appear on the screen. Press the Apply key to save the calibration data.

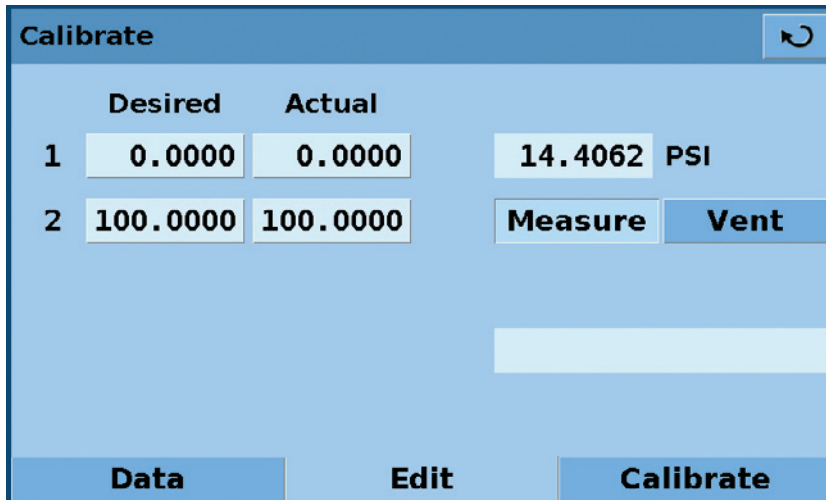

Figure - Calibrate Edit

The Screen accessed by pressing the **[CALIBRATE]** tab, "Figure - Calibrate Calibrate", allows the operator to perform a live calibration while connected directly to a primary standard. In this mode, the CPC3000 will display the currently measured pressure in the Actual column when the measured pressure is within a few percent of the value in the Desired column. The Desired column allows the actual pressures applied to the CPC3000 to be entered. Press the Apply key to save changes. For best results, the two points should be as near the endpoints of the sensor's calibration as possible. When calibrating an absolute transducer, set the low calibration point at or above a pressure of 0.4 mbar. At or above that pressure the system will have a viscous flow so that the entire system should have the same pressures after a few minutes.

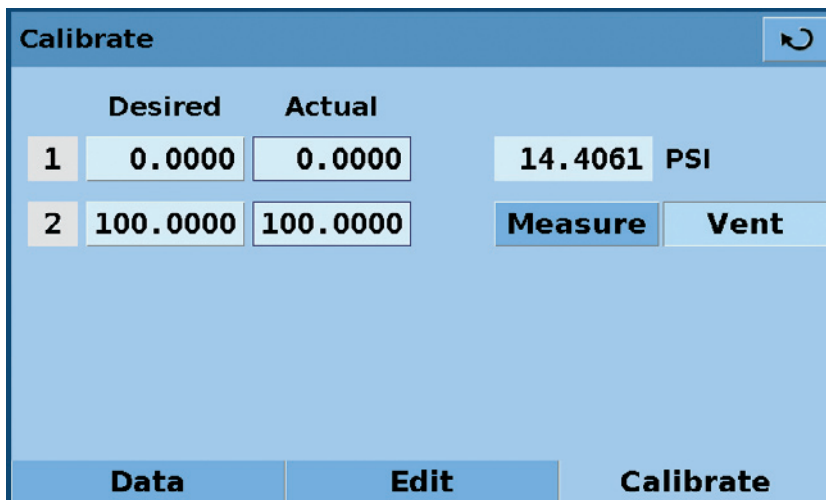

Figure - Calibrate Calibrate

8. Remote Operation

When the instrument is turned on, BIOS routines test the system CPU board. These tests may take up to 60 seconds. After the BIOS tests, LINUX is loaded. LINUX will then call the executable file. The executable file will go through a series of software and hardware initialization. The following hardware/software is initialised:

8.1 Remote SETUP

To SETUP any of the remote communication protocols start in the SETUP remote screen, "Figure - Remote SETUP".

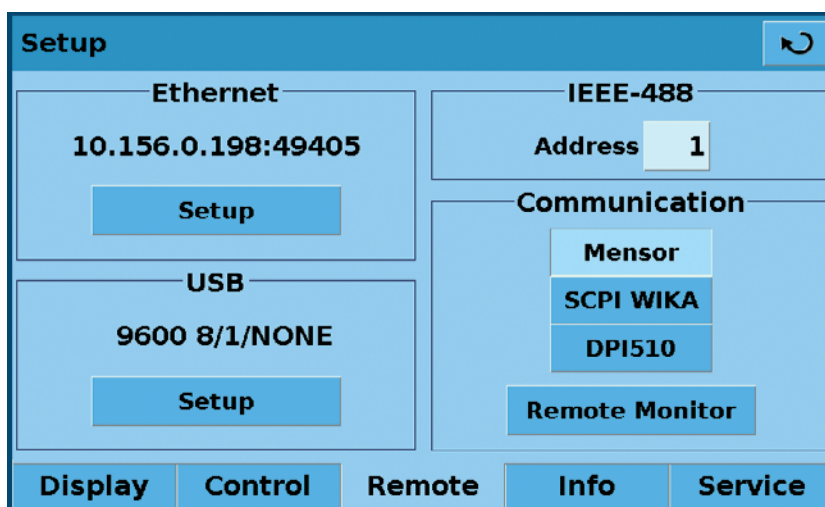

Figure - Remote SETUP

8.2 Remote SETUP – Ethernet

The Ethernet communication port allows the CPC3000 to communicate with computers using 10/100 Bases-T specification. Ethernet communications are transmitted over a standard RJ-45 cable. Connecting directly to a PC requires a crossover Ethernet cable. Hub or router connections require a straight Ethernet cable.

Before using Ethernet communication, four parameters must be set up: IP, Netmask, Gateway and Port. In "Figure - Ethernet SETUP" the Ethernet SETUP screen is shown. Each value entry key opens an alpha or numeric data entry screen to change values of the Ethernet parameters.

The screenshot shows the 'Ethernet' configuration screen. It features a title bar with a refresh icon. The main area contains several input fields and a checkbox. The 'Hostname' field is set to 'MENSOR-CPC3000-810009'. The 'IP' field is '10.156.0.149' and the 'Client IP' field is '10.156.0.173'. The 'Netmask' field is '255.255.255.0' and there is a 'Reset' button to its right. The 'Gateway' field is '10.156.0.16'. The 'Port' field is '49405'. At the bottom, the 'DHCP' checkbox is checked.

Figure - Ethernet SETUP

8.3 Remote SETUP – USB

The USB communication port allows the CPC3000 to communicate with computers using a USB cable. The connection on the back panel of the CPC3000 is a Type B receptical.

The screenshot shows the 'USB RS-232 Emulation' configuration screen. It features a title bar with a refresh icon. The main area contains several settings. The 'Baud' rate is set to '9600', with other options '19200', '38400', '57600', and '115200' visible. The 'Data' bits are set to '7', with '8' as an alternative. The 'Stop' bits are set to '1', with '2' as an alternative. The 'Parity' is set to 'None', with 'Odd' and 'Even' as alternatives. The 'Echo' checkbox is unchecked.

Figure - USB SETUP

8.4 Remote SETUP – IEEE-488

The IEEE-488 communication port allows the CPC3000 to communicate with computers using an IEEE-488 cable. This screen, "Figure - IEEE-488 Address", is accessed by pressing the IEEE-488 numeric value box in the SETUP Remote screen. After pressing the numeric value box a number entry keypad will appear for entering the new IEEE-488 address. The manufacturer of the host IEEE-488 interface board provides software to allow communication between the board and various programming languages. An interactive program for debugging is usually provided as well. Refer to the board manufacturer's documentation for more information.

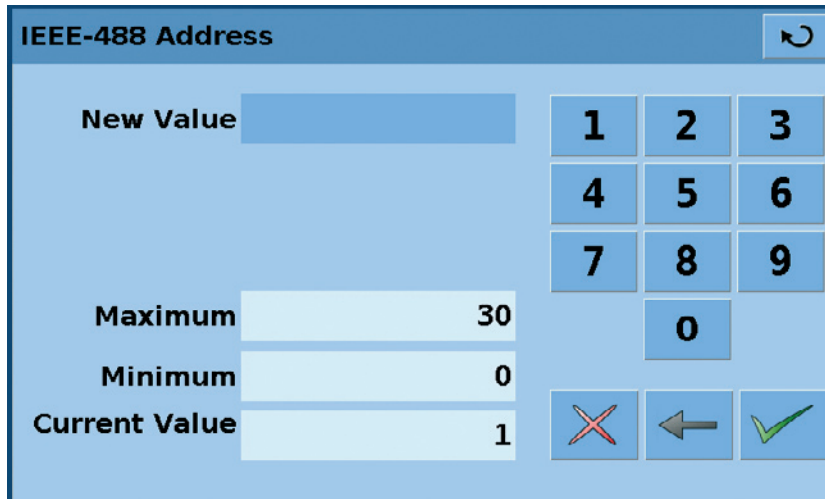

Figure - IEEE-488 Address

8.5 Remote Command Set

This remote command set is the default set available on the CPC3000. All CPC3000 remote operation commands are included in the lists below. All commands must be terminated with a <CR> or a <LF>.

For a query command (ends with a ?), the data column represents the response of the CPC3000. All response strings begin with a space character or an "E" representing that there is an error in the CPC3000 error queue. All response strings are terminated with a <CR> and a <LF>. The error queue holds the last 10 errors identified by the CPC3000.

For all commands without a question mark (?), the data column represents the required parameters to be sent to the CPC3000 following the string in the command column. For any command that requires multiple parameters to be sent to the CPC3000, the parameters must be separated by commas.

8.5.1 Mensor Command Set

Command	Data	Response/Function
?	See Table Below	Returns data per the current output format.
Acquire?	15 char string. Ex: Acquire? Test_stand_1 Returns: <sp>(Yes or No), CCC... CCC<cr><lf>	This command is used when multiple computers would like to control the instrument. Yes if acquisition is successful, No if instrument is being controlled with another computer. CCC... = name of controlling computer See: Release? and Unlock
Address	0-31	Sets the GPIB Address.
Address?	<sp> xx <cr><lf>	Returns the GPIB Address.
A?	<sp>n.nnnnne+nn<cr><lf>	Returns the A channel pressure reading.
AR?	<sp>n.nnnnne+nn<cr><lf>	Returns the A channel rate.
ARS?	<sp>(Yes or No)<cr><lf>	Returns the A channel rate stable flag.
AS?	<sp>(Yes or No)<cr><lf>	Returns the A channel stable flag.
Autorange	On or Off	Sets whether the auto range function is enabled or disabled.
Autorange?	<sp>(on or off)<cr><lf>	Returns whether the autorange function is enabled or disabled.
Baro?	<sp>n.nnnnne+nn<cr><lf>	Returns reading from barometric sensor.
Caldisable	Yes,no	Sets whether or not calibration of the active sensor is disabled.
Caldisable?	<sp>(Yes or No)<cr><lf>	Returns whether or not calibration of the active sensor is disabled.
Cerr	None	Clears the error queue.
CID?		Returns the ID string of the regulator for the active channel.
Cmdset	Mensor, DPI510, DPR60c, SCPI	Activates remote command set for instrument emulation modes.
Cmdset?	<sp>X<cr><lf>	Returns active command set identifier.
Control		Instrument placed in Control Mode.
Control?	<sp>(yes or no)<cr><lf>	Returns Yes if instrument is in control, No if otherwise.
Crate	Slow, Medium, Fast	Sets the control rate.
Crate?	<sp>CCCC<cr><lf>	Returns the control rate – CCCC is variable in length and corresponds to the parameters for the CRATE command.
Ctype?	<sp>HPSVR<cr><lf>	Returns the type of regulator for the active channel.

Pneumatic High-Speed Pressure Controller CPC3000

Command	Data	Response/Function
Decpt?	<sp>n<cr><lf>	Returns the number of decimal points for the active channel. (see Resolution)
Default	None	Sets the default values.
DHCP		Reserved for DHCP SETUP
DHCP?		Reserved for DHCP SETUP
DIO	Integer	2 turns on digital output, 0 turns it off.
DIO?		Bit0 = input, bit1 = output
DOC	mm/dd/yyyy	Sets the date of cal for the active sensor and turndown.
DOC?	<sp>mmddy<cr><lf>	Returns the date of cal for the active sensor and turndown.
DOM?	<sp> mm/dd/yyyy<cr><lf>	Returns the date of manufacture.
DUTLABEL		Reserved for DUT option
DUTLABEL?		Reserved for DUT option
DUTTYPE		Reserved for DUT option
DUTTYPE?		Reserved for DUT option
DUTAMIN		Reserved for DUT option
DUTAMIN?		Reserved for DUT option
DUTAMAX		Reserved for DUT option
DUTAMAX?		Reserved for DUT option
DUTLOOP		Reserved for DUT option
Error?	<sp> text message <cr><lf>	Returns the next error in the error queue.
Errorno?	<sp>Enn-text<cr><lf>	Returns pcs400 error code and text.
Filter	Off, Low, Normal, High	Sets the reading filter 0, 80 %, 92 %, 95 %.
Filter?	<sp> (filter)<cr><lf>	Returns the reading filter.
Gasdensity	Value in lb/cuft	Sets the head pressure gas density in lb/cuft.
Gasdensity?	<sp>n.nnnnne+nn<cr><lf>	Returns the head pressure gas density.
Gastemp	Value in degrees F	Sets the head pressure gas temperature in degrees F.
Gastemp?	<sp>n.nnnnne+nn<cr><lf>	Returns the head pressure gas temperature.
Gateway	nnn.nnn.nnn.nnn	Sets the Ethernet gateway address.
Gateway?	<sp>nnn.nnn.nnn.nnn<cr><lf>	Returns the Ethernet gateway address.
Height	Value in inches	Sets the head pressure height in inches.
Height?	<sp>n.nnnnne+nn<cr><lf>	Returns the head pressure height.
Id?	<sp> MENSOR, CPC3000, ssssss,v.v.vv	Ssssss is the serial number, v.vv is the CPC3000 software version.
Install		Start software installer.
IP	nnn.nnn.nnn.nnn	Sets the IP address of the instrument.

11498171.01 08/2009 GB

Command	Data	Response/Function
IP?	<sp>nnn.nnn.nnn.nnn<cr><lf>	Returns the IP address of the instrument.
Keylock	Yes or No	Locks or unlocks keyboard.
Keylock?	<sp>(Yes or No)<cr><lf>	Returns Yes or No.
List?	<sp>Pri,X,X;Sec,X,X;Bar,1<cr><lf>	Returns list of available turn-downs on installed sensors in the active channel. X will be non-existent if the turndown isn't available.
Listrange?	PRI,1, min,max,2, min, max;SEC,1, min,max,2, min,max,Bar,min,max	Returns the ranges of the installed sensors for the active channel.
Localgravity	Value in ft/s ²	Sets the local gravity in feet/sec ² .
Localgravity?	<sp>n.nnnne+nn<cr><lf>	Returns the local gravity in feet/sec ² .
LowerLimit	Value inside primary xducer Range on turndown #1 in current units.	Sets the lower control limit for the instrument.
LowerLimit?	<sp>xxxxxxx<cr><lf>	Returns the lower control limit for the instrument in current units.
Measure	None	Instrument placed in Measure Mode.
Measure?	<sp>(Yes or No)<cr><lf>	Returns YES if instrument is in measure, No if otherwise.
Netmask	nnn.nnn.nnn.nnn	Sets the Ethernet network mask.
Netmask?	<sp>nnn.nnn.nnn.nnn<cr><lf>	Returns the Ethernet network mask.
Outform	1 to 8 – see table below	Sets the output format.
Outform?	<sp>X<cr><lf>	Returns the output format – see table below
Peakmax?	<sp>n.nnnne+nn<cr><lf>	Returns the maximum pressure since peakreset was sent.
Peakmin?	<sp>n.nnnne+nn<cr><lf>	Returns the minimum pressure since peakreset was sent.
Peakreset	None	Resets the peak values.
Port	nnnnnn	Sets the Ethernet port of the instrument
Port?	<sp>nnnnn<cr><lf>	Returns the Ethernet port of the instrument
Ptype	Absolute or Gauge	Sets the instrument pressure type – gauge only works if the optional barometric sensor is installed
Ptype?	<sp>CCCCC<cr><lf>	Returns “Absolute” or “Gauge” for the pressure type
RangeMax?	<sp>XXXXXXX<cr><lf>	Returns the maximum range of the active transducer and turndown in the current units.
RangeMin?	<sp>XXXXXXX<cr><lf>	Returns the minimum range of the active transducer and turndown in the current units.
Rate?	<sp>XXXXXXX<cr><lf>	Returns the rate reading of the instrument in current units/second.

Pneumatic High-Speed Pressure Controller CPC3000

Command	Data	Response/Function
Rdecpt?	<sp>n<cr><lf>	Returns the number of rate decimal points for the active channel. (see Resolution)
Release?	15 char string. Ex: Release? Test_stand_1 Returns: <sp>(Yes or No), CCC... CCCcr><lf>	This command is used to release control of the instrument in a multiple computer environment. Yes if release is successful. No if instrument is being controlled with another computer. CCC... = name of controlling computer or AVAILABLE See: Acquire? and Unlock
Resolution	n	Sets the number of significant digits. See decpt.
Resolution?	<sp>n<cr><lf>	Returns the number of significant digits. See decpt.
Rfilter	Value in %	Sets the % of the rate filter
Rfilter?	<sp>n.nnnnne+nn<cr><lf>	Returns the rate filter.
Rsetpt	Value in current units	Sets the rate setpoint
Rsetpt?	<sp>n.nnnnne+nn<cr><lf>	Returns the rate setpoint
Rfreq	Value in frequency	Sets rate Butterworth corner frequency.
Rfreq?	<sp>n.nnnnne+nn<cr><lf>	Returns rate Butterworth corner frequency.
Rwindow	Value in current units	Sets rate exponential filter window.
Rwindow?	<sp>n.nnnnne+nn<cr><lf>	Returns rate exponential filter window.
Sbaud	9600, 19200, 38400, 57600	Sets the serial baud rate.
Sbaud?	<sp>XXXX<cr><lf>	Returns the serial baud data.
Sdata	7 or 8	Sets the serial data bits.
Sdata?	<sp>X<cr><lf>	Returns the serial data bits number.
Sensor	C, X	Sets the active sensor where C = Primary or Secondary and X is the turndown.
Sensor?	<sp>C,X<cr><lf>	Returns active sensor as above.
Sensorid?	<sp>Mensor QRS,SN XXXXXX,VER V.VV	Returns the active sensor's serial number and firmware version.
Setpt	value inside upper and lower limits and inside the range of the active sensor and turndown.	Sets the control setpoint for the instrument.
Setpt?	<sp>XXXXXXXX<cr><lf>	Returns the control setpoint in current units.
Setpt%	Value in % of current range	Sets the control setpoint in % of current range.
Setptpct	Value in % of current range	Sets the control setpoint in % of current range.
Setptpct?	<sp>n.nnnnne+nn<cr><lf>	Returns the current setpoint in % of current range.

11498171.01 08/2009 GB

Pneumatic High-Speed Pressure Controller CPC3000

Command	Data	Response/Function
Span	desired pressure or ?	Sets span on active transducer or for ?, clears previous value, must be > 50 %FS and has a 1 % limit.
Span?	<sp>XXXXXXX<cr><lf>	Returns span scale factor for active transducer.
Sparity	Even, Odd, None	Sets the serial parity.
Sparity?	<sp>CCCC<cr><lf>	Returns the serial parity.
Sstop	1 or 2	Sets the serial stop bits.
Sstop?	<sp>X<cr><lf>	Returns the serial stop bits.
Stable?	<sp>(Yes or No)<cr><lf>	Returns YES if instrument is stable, or No.
Stabledelay	0 to 65535	Sets the stable time to the number of seconds specified.
Stabledelay?	<sp>XXXXXXX<cr><lf>	Returns the stable time.
stabletime	0 to 65535	Sets the stable time to the number of seconds specified.
Stabletime?	<sp>XXXXXXX<cr><lf>	Returns the stable time.
StableWin	%fs value	Sets the stable window as a %FS for the active sensor and turndown.
StableWin?	<sp>XX<cr><lf>	Returns the stable window.
Standby	None	Instrument placed in Standby Mode.
Standby?	<sp>(Yes or No)<cr><lf>	Returns Yes if instrument is in Standby, No if otherwise.
Step	value inside upper and lower limits and inside the range of the active sensor and turndown.	Sets the control step size for the instrument.
Step-	Optional value	Jogs the setpoint down one step.
Step+	Optional value	Jogs the setpoint up one step.
Step?	<sp>XXXXXXX<cr><lf>	Returns the control step for the instrument.
Step%	Value in % of current range	Sets the control step in % of current range.
Steppct	Value in % of current range	Sets the control step in % of current range.
Steppct?	<sp>n.nnnnne+nn<cr><lf>	Returns the current step in % of current range.
Units	units code or text in table below	Sets the instrument engineering units.
Units?	<sp>CCCC<cr><lf>	Returns the instrument units in a text string.
Unlock	None	Releases Acquire locks. See Acquire? and Release?
UpperLimit	Value inside primary xducer Range on turndown #1 in current units.	Sets the Upper control limit for the active transducer.
UpperLimit?	<sp>xxxxxxx<cr><lf>	Returns the upper control limit for the active transducer.

11498171.01 08/2009 GB

Command	Data	Response/Function
Vent	None	Instrument placed in Vent Mode.
Vent?	<sp>(Yes or No)<cr><lf>	Returns Yes if instrument is in Vent, No if otherwise.
Window	Value in current units	Sets the exponential filter window for the active sensor.
Window?	<sp>n.nnnnne+nn<cr><lf>	Returns the exponential filter window for the active sensor.
Zero	desired pressure or ?	Sets zero to set pressure or for ?, clears previous value.
Zero?	<sp>xxxxxxx<cr><lf>	Returns zero offset for active transducer.

8.5.2 PCS 400 Commands Emulated

Command	Data	Response/Function
_pcs4 autorange <value>	0 or 1	1 turns autorange on, 0 – off.
_pcs4 autorange?		Returns 1 if in autorange, 0 if in range hold.
_pcs4 cal a/d		Not applicable.
_pcs4 cal atm		Performs pcs400 1 pt cal.
_pcs4 cal span <value>		Sets the span of the active transducer to <value>.
_pcs4 cal zero <value>		Sets the zero of the active transducer to <value>.
_pcs4 cal_disable_off		Enables zero or span calibrations if previously disabled.
_pcs4 cal_disable_on		Prevents zero or span calibrations.
_pcs4 ctrl <value><sp><unitno>		Sets control value – will take effect immediately if instrument is in control mode.
_pcs4 ctrl?		Returns the current control point in current engineering units.
_pcs4 ctrlmax <value>		Sets maximum control value.
_pcs4 ctrlmax?		Returns current maximum control pressure.
_pcs4 ctrlmin <value>		Sets minimum control value.
_pcs4 ctrlmin?		Returns current minimum control pressure.
_pcs4 emul?		Returns ptype emulation mode.
_pcs4 default		Sets default values into instrument.
_pcs4 err?		Returns the error number and description.
_pcs4 exhaustp?		Returns exhaust pressure.

Command	Data	Response/Function
_psc4 filtersetting		Sets the filter %.
_pcs4 filtersetting?		Returns the filter %.
_pcs4 filterwindow		Sets the filter window.
_pcs4 filterwindow?		Returns the filter window.
_pcs4 func ctrl <value> <unitno>		Instrument placed in control mode at <value> pressure in <unitno> units.
_pcs4 func emul		Toggles ptype emulation mode.
_pcs4 func F1		Toggles ptype emulation mode.
_pcs4 func meas		Instrument placed in measure mode.
_pcs4 func stby <unitno>		Instrument placed in standby mode in <unitno> units.
_pcs4 func vent <unitno>		Instrument placed in vent mode in <unitno> units.
_pcs4 id?		Returns instrument ID.
_pcs4 lang PCS2		Sets command set to PCS 200.
_pcs4 list?		Returns range list.
_pcs4 opt?		Returns option list (old PCS 400 format).
_pcs4 option?		Returns option list.
_pcs4 outform <digit>		Sets output format.
_pcs4 outform?		Returns the current output format.
_pcs4 peakreset		Resets peak readings.
_pcs4 peakunit		Selects Peak+ or Peak-.
_pcs4 peakunit?		Returns Peak+ or Peak-.
_pcs4 rangemax?		Returns the maximum pressure of the active transducer.
_pcs4 rangemin?		Returns the minimum pressure of the active transducer.
_pcs4 rate		Sets the control rate.
_pcs4 rate?		Returns the pressure rate.
_pcs4 rateunit		Selects the rate units (SEC or MIN).
_pcs4 rateunit?		Returns the rate units.
_pcs4 reading?		Returns the current pressure.
_pcs4 sourcep?		Returns the supply pressure.
_pcs4 span?		Returns the stored multiplication factor from the active transducer & turndown.
_pcs4 stabledelay <value>	1 to 255	Sets the number of consecutive readings that the pressure must remain within the stable window for a pressure stable indication.

Pneumatic High-Speed Pressure Controller CPC3000

Command	Data	Response/Function
_pcs4 stabledelay?		Returns the number of readings that must be within the stable window before a stable pressure is indicated.
_pcs4 stablewindow <value>		Sets the pressure window that is used to indicate pressure is stable.
_pcs4 stablewindow?		Returns the pressure tolerance allowed for a stable pressure indication as a % of span of the active transducer.
_pcs4 stat?		Returns Mode and stable flag status "mode, stable CR LF".
_pcs4 unit <unitno>		Sets the instrument to specified engineering units.
_pcs4 unit?		Returns the current engineering units and the type of transducer (A, G, D).
_pcs4 xducer?		Returns the number of the currently active transducer.
_pcs4 xducerid?		
_pcs4 zero?		Returns the stored zero offset of the active transducer & turndown in the current pressure units.

8.5.3 PCS 200 Commands Emulated

Command	Data	Response/Function
CX		Control Pressure at last control point and units
C\$nnnnnnnX		Control Pressure at n in units \$
C\$nnnnnnnsX		Control Pressure at n in units \$
D#X		CAL POINT CONTROL MODE NOT SUPPORTED
EX		Clear Error/Clear Service Request
E?X		Return error code and clear error
F\$nnnnnnn1X		Re-initialize; \$, n ignored
F\$nnnnnnn2X		RETURN CAL DATA NOT SUPPORTED
F\$nnnnnnn3X		Return Unit ID string; \$,n ignored
F\$nnnnnnn5X		RETURN QPS TEMPERATURE NOT SUPPORTED
F\$nnnnnnn6X		RETURN NULL METER READING NOT SUPPORTED

11498171.01 08/2009 GB

Pneumatic High-Speed Pressure Controller CPC3000

Command	Data	Response/Function
F\$nnnnnnn1X		RETURN VACUUM GAUGE READING NOT SUPPORTED
F\$nnnnnnn1X		Return Clock Reading (Time); \$, n ignored
F\$nnnnnnn1X		Return Pressure Control Limits; \$, n ignored
MX		Measure Pressure in current pressure units
M\$X		Measure Pressure in units specified by \$
M\$nnnnnnnX		Measure Pressure in units specified by \$; n ignored
M\$nnnnnnnnsX		Measure Pressure in units specified by \$; n, s ignored
Q#X		SEQ FUNCTIONS NOT SUPPORTED
R0X		Return to Standard Output Format
R1X		Re-initialize
R2X		RETURN CAL DATA NOT SUPPORTED
R3X		Return unit ID string
R5X		RETURN QPS TEMPERATURE NOT SUPPORTED
R6X		RETURN NULL METER READING NOT SUPPORTED
R7X		RETURN VACUUM GAUGE READING NOT SUPPORTED
R8X		Return Clock Reading (Time)
R9X		Return Pressure Control Limits (Min and Max)
SX		Standby Mode
S\$X		Standby Mode; \$ ignored
S\$nnnnnnnX		Standby Mode; \$, n ignored
S\$nnnnnnnnsX		Standby Mode; \$, n, s ignored
U\$X		Change Units to units specified by \$
VX		Vent Mode in current units
V\$X		Vent Mode in units specified by \$
V\$nnnnnnnX		Vent Mode in units specified by \$; n ignored
V\$nnnnnnnnsX		Vent Mode in units specified by \$; n, s ignored
ZX		AUTO RE-ZERO NOT SUPPORTED

8.5.4 DPI 510 Commands Emulated

Command	Data	Response/Function
Q		Return data in output format
A		Make the A channel active
B		Make the B channel active
M		Go to local
R		Select active range
S		Select preset units
U		Set units
D		Select output data
F		Select function
N		Set output format
I		Set interrupt conditions
C		Select control mode
P		Set the control setpoint
/		Setpoint ratio NOT EMULATED
*		Setpoint preset NOT EMULATED
W		Set the stable time
@		Error Report
V		Set rate setpoint
J		Rate setpoint preset NOT EMULATED
O		Set zero offset
Q (baro)		Get baro reading (secondary address 9)
A (baro)		Select absolute
G (baro)		Select gauge
DCL		Device clear
GTL		Go to local
IFC		Interface clear

8.5.5 IEEE 488.2 Commands

Command	Data	Response/Function
*IDN?		Return identification string
*RST		Reset to known state (DEFAULT+PSI)
*TST?		Returns OK
*OPC		Operation completed
*WAI		Returns operation completed state
*CLS		Clear status and error queue
*ESE		Enable status event

Command	Data	Response/Function
*ESE?		Returns enable status event value
*ESR		Event status register
*ESR?		Returns event status register value
*SRE		Service request enable
*SRE?		Returns service request enable value
*STB?		Returns status byte

8.5.6 SCPI Commands

Notes:

1. if Wika option is enabled, SCPI units are BAR, otherwise SCPI units are the currently selected unit.

This numeric suffix always defaults to 1 and is designated by [R] (range)

Command	Response/Function
MEASure	
[:PRESsure][R]?	Returns the pressure from sensor R
:TEMPerature[R]?	Returns the temperature from sensor R
:RATE[R]?	Returns the rate/sec from sensor R
:BAROmetric?	Returns the barometric pressure
CALibration	
[:PRESsure][R]	
:MODE?	Returns 1=calibrated or 0=not calibrated
:DATE?	Returns date of cal "DD,MM,YY"
:DATE <i,i,i>	Sets date of cal YYYY,MM,DD
:ZERO?	Returns zero offset
:ZERO <n>	Sets the zero offset
:ZERO:RUN	Same as CAL:ZERO 0
:ZERO:INITiate?	Returns zero status
:ZERO:INITiate	No function
SENSe	
[:PRESsure][R]	
:NAME?	Returns sensor name string
:MODE?	Returns "ABSOLUTE" or "GAUGE"
:MODE ABS GAUGE	Sets pressure type
:ABS?	Returns native sensor type 0=GAUGE 1=ABSOLUTE
:RESolution?	Returns resolution (float)
:RANGe	
[:UPPer]?	Returns maximum range
:LOWer?	Returns minimum range

Pneumatic High-Speed Pressure Controller CPC3000

Command	Response/Function
:UNIT	
[:NAME]?	Returns ASCII units (mixed case)
:VALue?	Returns the units conversion factor
:REFerence	
[:HEIGHt] <n>	Sets the head pressure height
:MODE?	Returns "OFF", "GAS", or "LIQUID"
:MODE OFF GAS LIQUID	Sets the head pressure mode
:MEDium <n>	Sets the medium density
SYSTEM	
:DATE <i,i,i>	Sets sytem date YY,MM,DD
:TIME <i,i,i>	Sets system time HH,MM,SS
:ERRor[:NEXT]?	Returns error code, description
:KLOCK ON OFF 1 0	Sets the keylock state
:PRESet	Load known state values
:SAVe	No function (not needed)
:VERSion?	Returns SCPI version 1994.0
TEST	
:ELECTronic?	Returns "OK"
:RELay <n>?	Returns status of digital output <n> ignored
:RELay <n> ON OFF	Turns the digital output on or off <n> ignored
UNIT	
:NAME <n>?	Returns the units string for units code <n>
:FACTor <n>?	Returns the units conversion for units code <n>
OUTPUT	
:STATe ON OFF 1 0	ON or 1 = Control OFF or 0 = Measure
:STATe?	Returns 0 for measure 1 for control
:MODE MEASure CONTROL VENT	Sets the mode indicated
:MODE?	Returns the mode string
:STABLE?	Returns 1 if stable 0 if not
:AUTOvent ON OFF 1 0	Puts the unit in the Vent mode if true
:AUTOvent?	Returns the state of the Vent mode
[SOURce]	
:PRESsure	
[:LEVel]	
[:IMMEDIATE]	
[:AMPLitude] <n>	Sets the setpoint
[:AMPLitude]?	Returns the setpoint
:SLEW <n>	Sets the rate setpoint
:SLEW?	Returns the rate setpoint
:TOLerance?	Returns the stable window
:TOLerance <n>	Sets the stable window

11498171.01 08/2009 GB

Command	Response/Function
CALCulate	
:LIMit	
:LOWer <n>	Set the minimum control limit
:LOWer?	Set the minimum control limit
:UPPer <n>	Set the maximum control limit
:UPPer?	Set the maximum control limit
:SYSTem	
:DETECT SLOW FAST CANCEL	Control autotune (NOT USED NOW)
:DETECT?	Returns state of control autotune

Output formats

1. <sp> pressure value <cr><lf>
2. <sp> pressure, units number, mode <cr><lf>
3. <sp> pressure, pressure rate <cr><lf>
4. <sp> pressure, minimum peak, maximum peak<cr><lf>
5. <sp> pressure, active sensor (P or S) active turndown (1-4)<cr><lf>
6. <sp> pressure, control point, "stable" or "slewing"<cr><lf>
7. <sp> pressure, "no barometer" or baro reading<cr><lf>

9. Trouble-shooting measures



Warning

If faults cannot be repaired, the system must be taken out of operation immediately and protected against unintentional restarting. This information should be reported to authorized service personnel.

Repairs must only be performed by the manufacturer or authorized service personnel.

Work on electrical or pneumatic/hydraulic equipment must only be performed by qualified and authorized service personnel, observing the corresponding safety regulations.

In case of faults caused by defects of the electrical or pneumatic/hydraulic equipment the operators must inform their superiors immediately and call in the qualified and authorised technical staff for maintenance.

9.1 Table: Fault description and measures

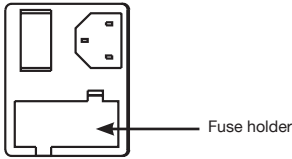
Type of fault	Measures
I. After the system is switched 60 seconds, no measurement(s) appears, and the entire area of the screen is white or dark.	Switch off the system and then switch back on again after 5 seconds.
II. The screen is dark and the measures for faults of type I are without effect.	Check that the mains cable is connected properly and have authorised technical staff check that the supply voltage is correct.
III. The screen is dark and the measures for faults of type II are without effect.	<p>First pull out the mains cable from the mains socket and then from the power supply input socket of the system. Then pull out the fuse holder and check the fuses.</p>  <p>Power supply input socket</p>
IV. Malfunction during operation	Switch off the system and switch on again after 5 seconds.

Type of fault	Measures
V. The set value is not reached.	Check whether the value of the supply pressure at the SUPPLY HIGH port is the value required and leak-test the pipe connections.



Warning

If the fuses of the power supply input socket have to be replaced, use 1.5 A, 230 V AC only.

If you require further help please contact the WIKA department of Testing and Calibration Technology under:

Phone +49 - (0) 93 72 / 132-473 /-9986

Fax. +49 - (0) 93 72 / 132-217

E-mail: testequip@wika.de

10. Re-calibrating and servicing

We recommend having the system re-calibrated by the manufacturer at regular intervals of approximately 12 months. Every re-calibration at the factory also includes a comprehensive and free checking of all system parameters.

The CPC3000 requires almost no maintenance, because all moving parts are extremely robust. There are no parts which have to be serviced by the user.

During each re-calibration the function of the integrated relief valves are checked and the lithium battery in the processor board (which is only essential for the time and date) is changed if necessary.



Warning

Before cleaning the surface of the instrument, make sure the instrument is not pressurized, that the power is off and the power supply has been disconnected.



Caution

To clean the Touch-screen, use only customary plastic or glass cleaning agents in compliance with the guidelines of the manufacturer. Use clothes which are not prone to generate fluffs.

11. Removal of the system



Warning

Work on electrical or pneumatic/hydraulic equipment must only be carried out by qualified and authorized service personnel, observing the corresponding safety regulations.

When dismantling the system proceed as follows:

1. Make sure that there is no positive or negative pressure on the system and that all parts of the instrument are at room temperature.
2. Switch the system off by pressing the power switch located at the rear of the instrument.
3. First pull out the power cable from the power socket and then from the power supply input.
4. Disconnect the pressure connections.



Warning

If a connection to a **SWAGELOK®** - connection is to be disconnected, overturning or loosening the **SWAGELOK®** - connection must be prevented with suitable tools.

5. Remove the system as necessary.
6. Protect connections with the protective caps supplied.

12. Transport of the system



Warning

Before the system is shipped it must be clean and free of dirt and debris. This is particularly important if the medium is a health hazard such as a corrosive, toxic, carcinogenic, radioactive, etc.

The precision measuring system CPC3000 must only be shipped in an appropriate transport box. If necessary, please ask for a proper transport box:

Phone +49 - (0) 93 72 / 132-9986

Fax. +49 - (0) 93 72/132-217

E-mail: testequip@wika.de

Follow the following instructions to prevent damage.

1. Wrap the system in anti-static plastic foil.
2. Place the system in the box assuring the instrument is packed tight with insulating material surrounding the instrument on all sides.
3. If possible add a bag of desiccant to the box
4. Make sure that the shipment is marked as transport of a highly sensitive measuring instrument.

The shipping address is:

WIKA Alexander Wiegand SE & Co. KG
Department CT
Alexander Wiegand Strasse
63911 Klingenberg
Germany

13. Storage of the system



Warning

Before the system is stored it must be clean and free of dirt and debris. This is particularly important if the medium is a health hazard such as a corrosive, toxic, carcinogenic, radioactive, etc.

The storage place must satisfy the following conditions:

- Ambient temperature: 0 to 70 °C
- Humidity: 35 to 85 % relative humidity without condensation

Avoid the following influences:

- Direct sunlight or vicinity to hot objects
- Mechanical vibration
- Soot, steam, dust and corrosive gasses
- Explosion-hazard environment, inflammable atmosphere

The system should be stored in its original transport box, in a place that meets the conditions listed above.

Follow the following instructions to avoid damage.

1. Wrap the system in anti-static plastic foil.
2. Using the insulating material, place the system in the box.
3. If the system is stored for a longer time (more than 30 days) add a bag with desiccant to the box.

14. Placing out of service



Warning

Before the system is shipped it must be clean and free of dirt and debris. This is particularly important if the medium is a health hazard such as a corrosive, toxic, carcinogenic, radioactive, etc.

When placing the system out of service, please dismantle it according to the instructions in the manual in chapter "11. Removal of the system".



Notice

When disposing of the system please observe the legal and local regulations in force.

For the final disposal of the system a special firm qualified for this is to be commissioned.

15. Appendix

Sales and Service International

Table – Measurement Units

Table – Conversion Factors, Pascal

MEASUREMENT UNITS

The Units command selects the measurement units to be output on the bus and the display.

Table – Measurement Units (unit no)

Code	Description	Output Format
1	pounds per square inch	psi
2	inches of mercury @ 0 °C	inHg 0 °C
3	inches of mercury @ 60 °F	inHg 60 °F
4	inches of water @ 4 °C	inH ₂ O 4 °C
5	inches of water @ 20 °C	inH ₂ O 20 °C
6	inches of water @ 60 °F	inH ₂ O 60 °F
7	feet of water @ 4 °C	ftH ₂ O 4 °C
8	feet of water @ 20 °C	ftH ₂ O 20 °C
9	feet of water @ 60 °F	ftH ₂ O 60 °F
10	millitorr	mTorr
11	inches of seawater @ 0 °C 3.5 % salinity	inSW
12	feet of seawater @ 0 °C 3.5 % salinity	ftSW
13	atmospheres	atm
14	bars	bar
15	millibars	mbar
16	millimeters of water @ 4 °C	mmH ₂ O 4 °C
17	centimeters of water @ 4 °C	cmH ₂ O 4 °C
18	meters of water @ 4 °C	mH ₂ O 4 °C
19	millimeters of mercury @ 0 °C	mmHg 0 °C
20	centimeters of mercury @ 0 °C	cmHg 0 °C
21	torr	Torr
22	kilopascals	kPa
23	pascals	PA
24	dyne per square centimeter	dy/cm ²
25	grams per square centimeter	gm/cm ²
26	kilograms per square centimeter	kg/cm ²
27	meters of seawater @ 0 °C 3.5 % salinity	m SW
28	ounce per square inch	OSI
29	pounds per square foot	PSF
30	tons per square foot	TSF
31	percent of full scale	% FS
32	micron HG @ 0 °C	μHg 0 °C
33	ton per square inch	tsi
34	n/a	n/a
35	hectopascals	hPa
36	megapascals	MPa
37	millimeters of water @ 20 °C	mmH ₂ O 20 °C
38	centimeter of water @ 20 °C	cmH ₂ O 20 °C
39	meters of water @ 20 °C	mH ₂ O 20 °C
n/a	User Units 1	User defined
n/a	User Units 2	User defined

CONVERSION FACTORS, PASCAL

The following table lists factors which should be used as multipliers when converting other pressure units to or from Pascal.

Table – Conversion Factors, Pascal

Unit No.	Pressure Unit	To Convert from Pascal	To Convert to Pascal
1	psi	1.450377E-04	6.894757E+03
2	inHG @ 0 °C	2.952997E-04	3.386390E+03
3	inHG @ 60 °F	2.961339E-04	3.376850E+03
4	inH ₂ O @ 4 °C	4.014741E-03	2.490820E+02
5	inH ₂ O @ 20 °C	4.021862E-03	2.486410E+02
6	inH ₂ O @ 60 °F	4.018645E-03	2.488400E+02
7	ftH ₂ O @ 4 °C	3.345622E-04	2.988980E+03
8	ftH ₂ O @ 20 °C	3.351551E-04	2.983692E+03
9	ftH ₂ O @ 60 °F	3.348871E-04	2.986080E+03
10	mTORR	7.500636E+00	1.333220E-01
11	inSW @ 0 °C 3.5% sal	3.904899E-03	2.560885E+02
12	ftSW @ 0 °C 3.5% sal	3.254082E-04	3.073062E+03
13	atm	9.869230E-06	1.013250E+05
14	bar	1.00000E-05	1.00000E+05
15	mbar	1.00000E-02	1.00000E+02
16	mmH ₂ O @ 4 °C	1.019744E-01	9.806378E+00
17	cmH ₂ O @ 4 °C	1.019744E-02	9.806378E+01
18	mH ₂ O @ 4 °C	1.019744E-04	9.806378E+03
19	mmHG @ 0 °C	7.500636E-03	1.333220E+02
20	cmHG @ 0 °C	7.500636E-04	1.333220E+03
21	TORR	7.500636E-03	1.333220E+02
22	KPA	1.00000E-03	1.00000E+03
23	Pa	1.00000E+00	1.00000E+00
24	DYNE/SQ cm	1.00000E+01	1.00000E-01
25	g/sq cm	1.019716E-02	9.806647E+01
26	kg/sq cm	1.019716E-05	9.806647E+04
27	mSW @ 0 °C 3.5% sal	9.918444E-05	1.008222E+04
28	OSI	2.320603E-03	4.309223E+02
29	PSF	2.088543E-02	4.788025E+01
30	TSF	1.044271E-05	9.576052E+04
32	MICRON HG @ 0 °C	7.500636E+00	1.333220E-01
33	TSI	7.251885E-08	1.378951E+07
35	hPA	1.00000E-02	1.00000E+02
36	MPA	1.00000E-06	1.00000E+06
37	mmH ₂ O @ 20 °C	1.021553E-01	9.789017E+00
38	cmH ₂ O @ 20 °C	1.021553E-02	9.789017E+01
39	mH ₂ O @ 20 °C	1.021553E-04	9.789017E+03

FOR YOUR NOTES

FOR YOUR NOTES

WIKA worldwide

Europe

Austria

WIKA Messgerätevertrieb
Ursula Wiegand GmbH & Co. KG
1230 Vienna
Tel. (+43) 1 86916-31
Fax: (+43) 1 86916-34
E-mail: info@wika.at
www.wika.at

Benelux

WIKA Benelux
6101 WX Echt
Tel. (+31) 475 535-500
Fax: (+31) 475 535-446
E-mail: info@wika.nl
www.wika.nl

Bulgaria

WIKA Bulgaria EOOD
Bul. „Al. Stamboliiski“ 205
1309 Sofia
Tel. (+359) 2 82138-10
Fax: (+359) 2 82138-13
E-mail: t.antonov@wika.bg

Croatia

WIKA Croatia d.o.o.
Hrastovicka 19
10250 Zagreb-Lucko
Tel. (+385) 1 6531-034
Fax: (+385) 1 6531-357
E-mail: info@wika.hr

Finland

WIKA Finland Oy
00210 Helsinki
Tel. (+358) 9 68249-20
Fax: (+358) 9 68249-270
E-mail: info@wika.fi
www.wika.fi

France

WIKA Instruments s.a.r.l.
95610 Eragny-sur-Oise
Tel. (+33) 1 343084-84
Fax: (+33) 1 343084-94
E-mail: info@wika.fr
www.wika.fr

Germany

WIKA
Alexander Wiegand SE & Co. KG
63911 Klingenberg
Tel. (+49) 9372 132-0
Fax: (+49) 9372 132-406
E-mail: info@wika.de
www.wika.de

Italy

WIKA Italiana SRL
20020 Arese (Milano)
Tel. (+39) 02 9386-11
Fax: (+39) 02 9386-174
E-mail: info@wika.it
www.wika.it

Poland

WIKA Polska S.A.
87-800 Wloclawek
Tel. (+48) 542 3011-00
Fax: (+48) 542 3011-01
E-mail: info@wipolska.pl
www.wipolska.pl

Romania

WIKA Instruments Romania
S.R.L.
Bucuresti, Sector 5
Calea Rahovei Nr. 266-268
Corp 61, Etaj 1
Tel. (+40) 21 4048327
Fax: (+40) 21 4563137
E-mail: m.anghel@wika.ro

Russia

ZAO WIKA MERA
127015 Moscow
Tel. (+7) 495 64801-80
Fax: (+7) 495 64801-81
E-mail: info@wika.ru
www.wika.ru

Serbia

WIKA Merna Tehnika d.o.o.
Sime Solaje 15
11060 Belgrade
Tel. (+381) 11 2763-722
Fax: (+381) 11 7536-74
E-mail: info@wika.co.yu
www.wika.co.yu

Spain

Instrumentos WIKA, S.A.
C/Josep Carner, 11-17
08205 Sabadell (Barcelona)
Tel. (+34) 902902577
Fax: (+34) 933938666
E-mail: info@wika.es
www.wika.es

Switzerland

Manometer AG
6285 Hitzkirch
Tel. (+41) 41 91972-72
Fax: (+41) 41 91972-73
E-mail: info@manometer.ch
www.manometer.ch

Turkey

WIKA Instruments Istanbul
Basinc ve Sicaklik Ölçme Cihazlari
Ith. Ihr. ve Tic. Ltd. Sti.
Bayraktar Bulvarı No. 21
34775 Yukari Dudullu - Istanbul
Tel. (+90) 216/415 90 66
Fax: (+90) 216/415 90 97
E-mail: info@wika.com.tr
www.wika.com.tr

Ukraine

WIKA Pribor GmbH
83016 Donetsk
Tel. (+38) 062 34534-16
Fax: (+38) 062 34534-17
E-mail: info@wika.ua
www.wika.ua

United Kingdom

WIKA Instruments Ltd
Merstham, Redhill RH13LG
Tel. (+44) (0) 1737644-008
Fax: (+44) (0) 1737644-403
E-mail: info@wika.co.uk
www.wika.co.uk

North America

Canada

WIKA Instruments Ltd.
Head Office
Edmonton, Alberta, T6N 1C8
Tel. (+1) 780 4637035
Fax: (+1) 780 4620017
E-mail: info@wika.ca
www.wika.ca

Mexico

Instrumentos WIKA Mexico
S.A. de C.V.
01210 Mexico D.F.
Tel. (+52) 555 02053-00
Fax: (+52) 555 02053-01
E-mail: ventas@wika.com
www.wika.com.mx

USA

WIKA Instrument Corporation
Lawrenceville, GA 30043
Tel. (+1) 770 5138200
Fax: (+1) 770 3385118
E-mail: info@wika.com
www.wika.com

WIKA Instrument Corporation
Electrical Temperature Division
950 Hall Court
Deer Park, TX 77536
Tel. (+1) 713 47500-22
Fax: (+1) 713 47500-11
E-mail: info@wikaetemp.com
www.wika.com

Mensor Corporation
201 Barnes Drive
San Marcos, TX 78666
Tel. (+1) 512 396420015
Fax: (+1) 512 3961820
E-mail: sales@mensor.com
www.mensor.com

South America

Argentina

WIKA Argentina S.A.
Buenos Aires
Tel. (+54) 11-4730 18 00
Fax: (+54) 11-4761 00 50
E-mail: info@wika.com.ar
www.wika.com.ar

Brazil

WIKA do Brasil Ind. e Com.
Ltda.
CEP 18560-000 Iperó - SP
Tel. (+55) 15-3459 97 00
Fax: (+55) 15-3266 16 50
E-mail: marketing@wika.com.br
www.wika.com.br

Asia

China

WIKA International Trading
(Shanghai) Co., Ltd.
200001 Shanghai
Tel. (+86) 21 538525-72
Fax: (+86) 21 538525-75
E-mail: info@wika.com.cn

India

WIKA Instruments India Pvt.
Ltd.
Village Kesnand, Wagholi
Pune - 412 207
Tel. (+91) 20 66293-200
Fax: (+91) 20 66293-325
E-mail: sales@wika.co.in
www.wika.co.in

Japan

WIKA Japan K. K.
Tokyo 105-0023
Tel. (+81) 3 543966-73
Fax: (+81) 3 543966-74
E-mail: t-shimane@wika.co.jp

Kazakhstan

TOO WIKA Kazakhstan
050050 Almaty
Tel. (+7) 32 72330848
Fax: (+7) 32 72789905
E-mail: info@wika.kz

Korea

WIKA Korea Ltd.
Seoul 153-023
Tel. (+82) 2 86905-05
Fax: (+82) 2 86905-25
E-mail: info@wika.co.kr

Malaysia

WIKA Instrumentation (M)
Sdn. Bhd.
47100 Puchong, Selangor
Tel. (+60) 3 806310-80
Fax: (+60) 3 806310-70
E-mail: info@wika.com.my
www.wika.com.my

Singapore

WIKA Instrumentation Pte. Ltd.
569625 Singapore
Tel. (+65) 68 4455-06
Fax: (+65) 68 4455-07
E-mail: info@wika.com.sg
www.wika.com.sg

Taiwan

WIKA Instrumentation Taiwan Ltd.
Pinjen, Taoyuan
Tel. (+886) 3 4206052
Fax: (+886) 3 4900080
E-mail: info@wika.com.tw
www.wika.com.tw

Africa / Middle East

Egypt

WIKA Near East Ltd.
El-Serag City Towers
-Tower#2 - Office #67-
Nasr City Cairo
Tel. (+20) 2 227 33 140
Fax: (+20) 2 227 03 815
E-mail: wika.repcairo@wika.de
www.wika.com.eg

South Africa

WIKA Instruments (Pty.) Ltd.
Gardenvue, Johannesburg 2047
Tel. (+27) 11-621 00 00
Fax: (+27) 11-621 00 59
E-mail: sales@wika.co.za
www.wika.co.za

United Arab Emirates

WIKA Middle East FZE
Jebel Ali, Dubai
Tel. (+971) 4 8839-090
Fax: (+971) 4 8839-198
E-mail: wikame@emirates.net.ae

Australia

Australia

WIKA Australia Pty. Ltd.
Rydalmere, NSW 2116
Tel. (+61) 2 88455222
Fax: (+61) 2 96844767
E-mail: sales@wika.com.au
www.wika.com.au

New Zealand

Process Instruments Limited
Unit 7 / 49 Sainsbury Road
St Lukes - Auckland 1025
Tel. (+64) 9 8479020
Fax: (+64) 9 8465964
E-mail: info@wika.co.nz
www.wika.co.nz



WIKAL Alexander Wiegand SE & Co. KG

Alexander-Wiegand-Straße 30
63911 Klingenberg • Germany
Phone (+49) 93 72/132-9986
Fax (+49) 93 72/132-217
E-Mail testequip@wika.de
www.wika.de