

J12 Indium Arsenide Detector Operating Notes (1.0 to 3.8 μm)



General

J12 Series detectors are high-quality Indium Arsenide photodiodes for use in the 1 to 3.8 μm wavelength range.

The equivalent circuit is a photon-generated current source I_{ph} with parallel capacitance C_D , shunt resistance R_D , and series resistance R_S (Fig. 12-1).

The output signal current I_S is defined as:

$$I_S = I_{ph} \frac{R_D}{R_D + R_S + R_{LOAD}}$$

R_D varies as a function of detector temperature (Fig. 12-2). R_S depends on the position of the source light spot on the detector surface; it varies with the distance from the spot to the detector contact ring.

When R_S is small compared to R_D it may be disregarded, but with room temperature InAs the effects of R_S are significant.

Figure 12-1
InAs Photodiode Equivalent Circuit

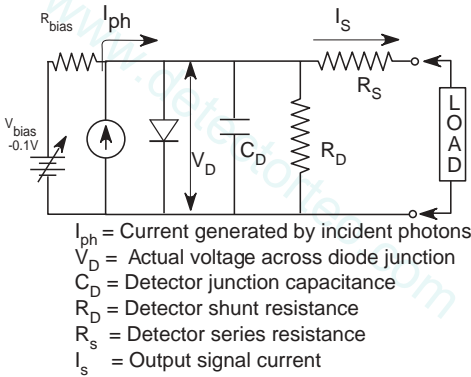
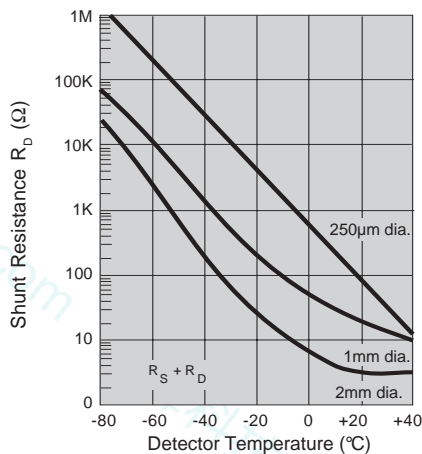

Figure 12-2
Example of InAs Shunt Resistance vs Temperature



Responsivity

The effect of R_S on the apparent response of an InAs detector is illustrated below.

At 22°C, R_S and R_D may have the same order of magnitude (~10Ω). As a result, although incident photons generate carriers uniformly over the detector area, some of the carriers generated near the center of the area may be "shunted away" through R_D and fail to reach the contact ring. This results in a "dip" in response at the center of the detector's active area (Fig. 12-3).

The effect is less pronounced in small-area detectors, which have higher R_D and less surface area. The effect is also reduced or eliminated by cooling the diode, thereby increasing the detector R_D .

Figure 12-3
Example of Response Variation Across 2mm Active Area

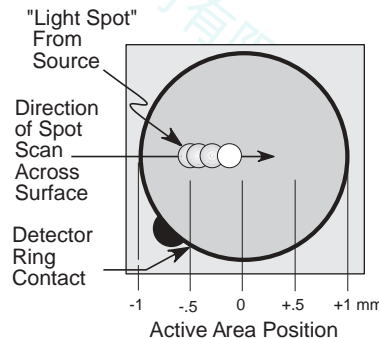
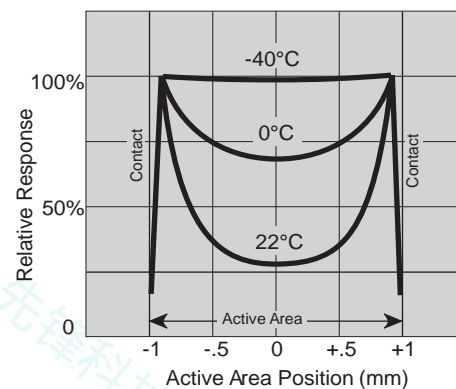

Temperature Effects

Cooling an InAs photodiode reduces noise and improves detectivity (Fig. 12-4).

Cooling also increases shunt resistance R_D as described in the previous section, allowing more of the photocurrent I_{ph} to reach the contact ring. The result is an increase in the diode response (Fig. 12-3).

For high-power applications such as pulsed laser detection, cooling is generally not necessary. For sensitive, low-power applications such as temperature measurements, the InAs detector should be cooled or at least temperature-stabilized.

Stabilizing the temperature near 22°C room temperature will not improve performance, but will prevent changes in detector response due to ambient temperature drift.

Figure 12-4
Detectivity vs Wavelength for J12 Series InAs

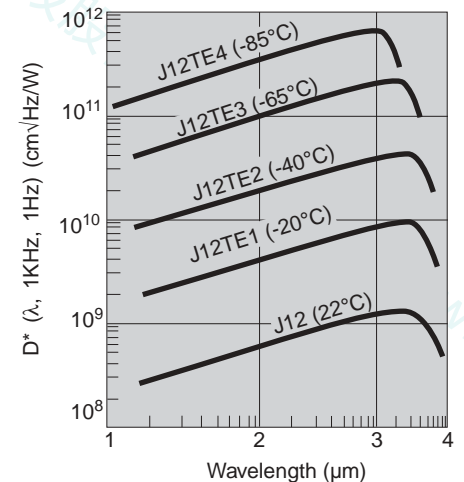
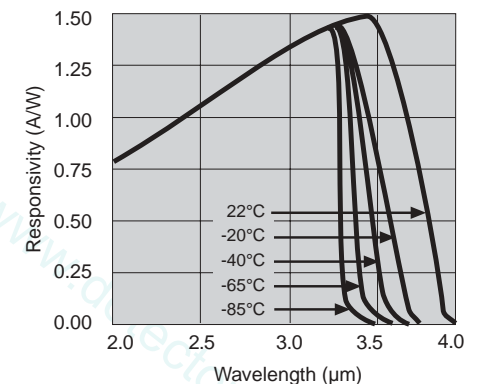

Figure 12-5
J12TE Detector Response vs Wavelength & Temperature



Thermoelectric Cooler Operation

Figure 13-1 shows typical power requirements for the TE1, TE2 and TE3 coolers. The built-in thermistor can be used to monitor or control the temperature. Figure 13-2 shows typical thermistor resistance vs. temperature values. Sensitivity, cutoff wavelength and response uniformity are all functions of temperature. Detector temperature should be optimized for a particular application.

Figure 13-1
Detector Temperature vs Cooler Current
TE1, TE2 and TE3

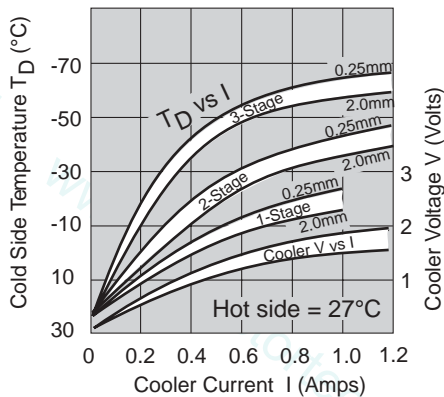
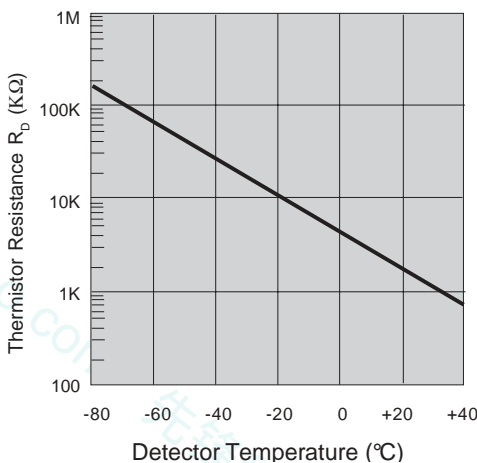

Figure 13-2
Typical Thermistor Curve



Operating Circuit

The recommended operating circuit for most applications is an operational amplifier in a negative-feedback transimpedance configuration (Fig. 13-3). The feedback circuit converts the detector output current to a voltage, while the op-amp maintains the detector near zero-volt bias for lowest noise.

Because R_D varies significantly with temperature, selection of the proper op-amp will depend on the detector operating temperature as well as the desired bandwidth. The feedback resistor R_F should be at least 10x greater than R_D for best signal-to-noise ratio. Judson has preamplifiers for optimum performance with each detector type.

For high frequency applications, the detector may be reverse biased and terminated into a low impedance load (Fig. 13-4). Maximum reverse bias is 1 volt.

Figure 13-3
Typical J12 Series Operating Circuit

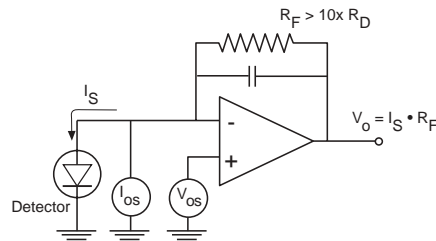

Detector Shunt Impedance	Recommended Cooler Module	Part Number
$\leq 400\Omega$	CMAMP-TO66-PA5	490130
	CMAMP-3CN-PA5	490132
400Ω - 50KΩ	CMAMP-TO66-PA6	490146
	CMAMP-3CN-PA6	490211
$\geq 25K\Omega$	CMAMP-TO66-PA7	490139
	CMAMP-3CN-PA7	490141

CMAMP assembly includes heat sink, temperature controller and transimpedance amplifier for the J12TE packages.

Figure 13-4
High-Speed Operating Circuit
for J12 or J12TE2 Series Detectors

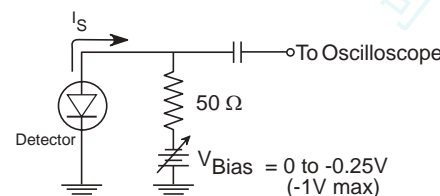

Advantages of InAs

Unlike the photoconductors commonly used in the 1-3.8 μm wavelength region, InAs operates in the photovoltaic mode and does not require a bias current for operation. This makes InAs the better choice for DC and low-frequency applications, as it does not exhibit the low-frequency or "1/f" noise characteristic of the photoconductors PbS, PbSe, and HgCdTe (Fig. 13-5).

InAs also offers superior pulse response for applications in monitoring and detecting high-speed pulsed lasers.

Figure 13-5
Example of NEP vs. Frequency

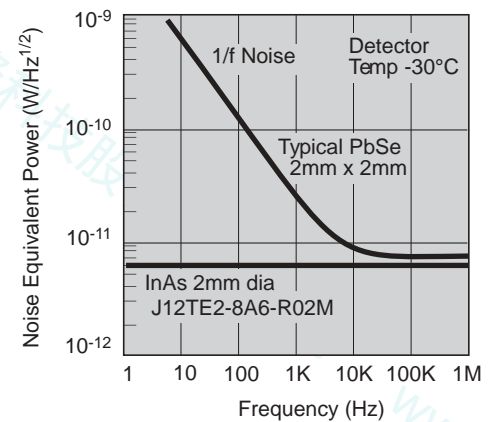

J12 Indium Arsenide Detectors (1.0 to 3.8 μm)



Description

The J12 Series Indium Arsenide (InAs) detectors are photovoltaic infrared photodiodes sensitive in the 1.0 to 3.8 μm wavelength region.

Diode sensitivity, speed of response, impedance and peak wavelength can be optimized by operation at the proper temperature. Judson offers a variety of convenient packages for room temperature and thermoelectrically cooled operation.

Linear arrays, X-Y position sensors and special configurations are also available.

Applications

- Laser Warning Receivers
- Process Control Monitors
- Temperature Sensors
- Pulsed Laser Monitors
- Infrared Spectroscopy
- Power Meters

J12 Series

Room Temperature InAs Detectors

These photodiodes operate at ambient temperatures and are excellent for wide bandwidth (DC to 16MHz) applications such as infrared laser monitors and fast temperature sensors. The devices are available in 0.25 mm, 1 mm or 2 mm diameter active sizes and are mounted in the 18C, 5AP or convenient LD2 BNC connector packages.

For low frequency applications (DC to 50KHz) the Model PA-5 transimpedance gain preamplifier is strongly recommended. The PA-5 has extremely low voltage noise, low offset voltage and adjustable gain for the best possible match to these low shunt resistance detectors.

InAs detectors can be reverse-biased to reduce junction capacitance and improve frequency response.

J12TE1 Series

1-Stage Thermoelectrically Cooled InAs

The J12TE1 Series detectors are high quality temperature stabilized InAs detectors mounted on a one stage thermoelectric cooler. The TE1 series was developed for applications such as temperature monitoring, power meters and infrared spectroscopy where low cost, responsivity, stability and low noise are important issues.

J12TE2 Series

2-Stage Thermoelectrically Cooled InAs

The J12TE2 Series detectors are high quality InAs photodiodes mounted with thermistors on two-stage thermoelectric coolers and hermetically sealed package. The 8B6 package is standard, with the 66S and HS1 packages available as options.

At the standard operating temperature of -40°C , the J12TE2 Series detectors have a much higher shunt resistance than room temperature detectors, resulting in higher responsivity, lower noise and better stability for DC or chopped light applications.

See Figs. 13-1 and 13-2 for thermoelectric cooler operating information. Cooler power supplies and temperature controllers are also available.

J12TE3 Series

3-Stage Thermoelectrically Cooled InAs

The J12TE3 Series detectors are high quality InAs photodiodes mounted in the 66S package which includes a built-in thermistor, three stage thermoelectric cooler and hermetically sealed package.

J12TE3 devices are ideal for critical military, space or industrial applications requiring high detectivity, good uniformity of response and wide bandwidth.



Figure 14-1
Typical Detectivity vs Wavelength
for J12 Series InAs

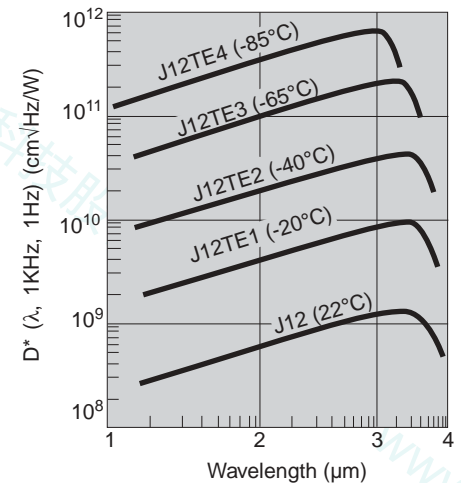

J12TE4 Series

4-Stage Thermoelectrically Cooled InAs

The J12TE4 Series detectors are high quality InAs photodiodes mounted in the 3CN package which includes a built-in thermistor, four stage thermoelectric cooler and hermetically sealed package.

Model Number	Part Number	Active Size (dia.) (mm)	Operating Temperature	Cutoff Wavelength @ λ_{co} (50%) (μm)	Responsivity @ λ_p (A/W)	Shunt Resistance R_D @ $V_R = 10\text{mV}$		Maximum NEP @ λ_{peak} and 1KHz (pW/Hz ^{1/2})	Minimum D* @ λ_{peak} and 1KHz (Jones) (cmHz ^{1/2} W ⁻¹)	Capacitance C_D @ $V_R = 0\text{V}$ (pF)	Optional Packages and Accessories
						Min. (Ω)	Typ. (Ω)				
J12 Series Room Temperature InAs											
J12-18C-R250U	420002	0.25	22°C	3.60	1.5	200	300	6.0	3.7E9	50	LD2
J12-18C-R01M	420003	1.00			1.0	15	25	33	2.7E9	400	
J12-5AP-R02M	420011	2.00			0.8	5	10	71	2.5E9	1600	
J12TE1 Series One-Stage Thermoelectrically Cooled InAs											
J12TE1-37S-R250U	420088	0.25	-20°C	3.50	1.5	2000	3000	1.8	1.3E10	50	HS1, CM21
J12TE1-37S-R01M	420061	1.00			1.5	200	300	5.6	1.6E10	400	
J12TE1-37S-R02M	420065	2.00			1.25	50	90	13	1.3E10	1600	
J12TE2 Series Two-Stage Thermoelectrically Cooled InAs											
J12TE2-66D-R250U	420083	0.25	-40°C	3.45	1.5	12K	24K	.69	3.2E10	50	HS Amp, HS1, CM21, CM Amp
J12TE2-66D-R01M	420041	1.00				1.2K	2.4K	2.2	4.1E10	400	
J12TE2-66D-R02M	420089	2.00				300	500	4.4	4.1E10	1600	
J12TE3 Series Three-Stage Thermoelectrically Cooled InAs											
J12TE3-66D-R250U	420081	0.25	-65°C	3.40	1.5	160K	320K	.18	1.2E11	50	HS Amp, HS1, CM21, CM Amp
J12TE3-66D-R01M	420056	1.00				10K	20K	.71	1.2E11	400	
J12TE3-66D-R1.5M	420063	1.50				5K	10K	1.0	1.3E11	800	
J12TE3-66D-R02M	420098	2.00				2.5K	5K	1.4	1.2E11	1600	
J12TE4 Series Four-Stage Thermoelectrically Cooled InAs											
J12TE4-3CN-R250U		0.25	-85°C	3.30	1.5	400K	800K	.11	2.1E11	50	HS Amp, HS1, CM21, CM Amp
J12TE4-3CN-R01M	420093	1.00				25K	50K	.43	2.1E11	400	
J12TE4-3CN-R02M-B		2.00				6.5K	13K	.84	2.1E11	1600	

18C

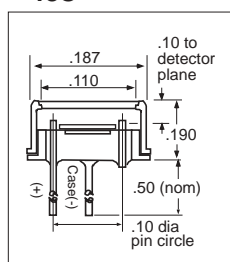

37S

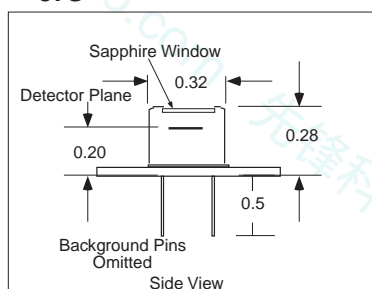

66D

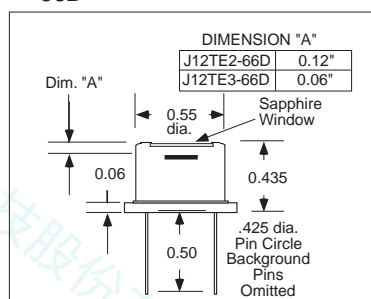

3CN

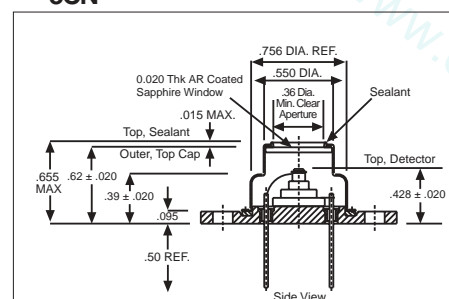

5AP

