

J13 Lead Sulfide Detectors (1.0 to 3.5 μm)



Description

The J13 Series detectors are Lead Sulfide (PbS) photoconductive (PC) detectors designed for operation in the 1-3.5 μm wavelength region. The wavelength of peak response depends on the formulation and operating temperature.

These detectors provide an economical means of obtaining high performance in a rugged and compact package. They are offered in flat plate cells, TO-style packages and thermoelectric coolers provide low temperature operation for increased sensitivity, longer wavelength operation and temperature stability.

Parts listed in this catalog are Judson standard product offering. Custom detectors and specifications offered with built-in electronics, discreet filter, multi-wavelength detectors and arrays are routinely provided in prototype through production quantities.

J13P Series

Room Temperature PbS Plate Cells

These basic detecting elements consist of a sensitized PbS film, electrodes and two electrical leads encapsulated on a quartz substrate. They come standard in a variety of active areas from 1 to 10 mm square.

J13TO Series

Room Temperature TO Packaged PbS Detectors

These detectors are fabricated utilizing a hermetically sealed and inert gas backfilled TO-5, TO-8 or TO-3 style semiconductor package. This package protects the active element and provides the versatility of directly soldering or plugging into a PC board during manufacturing.

J13TE1 Series

1-Stage Thermoelectrically Cooled PbS Detectors

The J13TE1 Series detectors are high quality temperature stabilized PbS detectors mounted on a one-stage thermoelectric cooler with a thermistor for control and stabilization of the detector element. At the standard operating temperature of -20°C, the wavelength peak is 2.5 μm .

J13TE2 Series

2-Stage Thermoelectrically Cooled PbS Detectors

The J13TE2 Series detectors are high quality PbS photodiodes mounted on two-stage thermoelectric coolers with thermistors for control and stabilization of the detector element. At the standard operating temperature of -30°C, the wavelength peak is 2.6 μm .

J13TE3 Series

3-Stage Thermoelectrically Cooled PbS Detectors

The J13TE3 Series detectors are high quality temperature stabilized PbS detectors mounted on a three-stage thermoelectric cooler with a thermistor for control and stabilization of the detector element. At the standard operating temperature of -65°C, the wavelength peak is 2.7 μm . This detector offers exceptional sensitivity in a compact and easy to integrate package.

Applications

- NDIR Spectroscopy
- Optical Pyrometry
- Flame Spectroscopy
- Moisture Analyzers



Figure 18-1
Detectivity vs Wavelength for J13 Series PbS

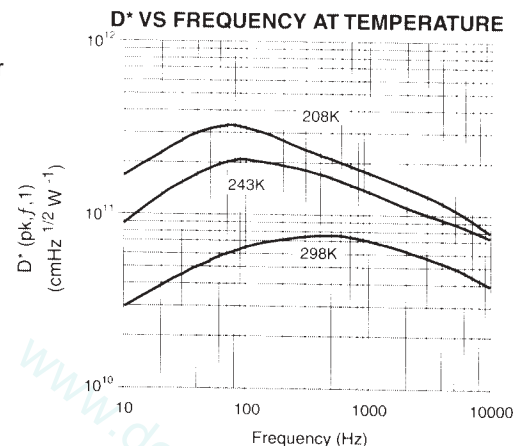
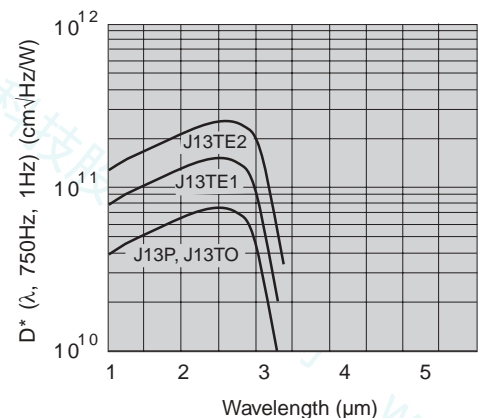

J13 Lead Sulfide Detectors continued



Model Number	Part Number	Active Size (mm)	Wavelength λ_p (μm)	D^* ($\lambda_p, 750, 1$) (min.) ($\text{cmHz}^{1/2}\text{W}^{-1}$)	Blackbody D^* (500K, 750, 1) (min.) ($\text{cmHz}^{1/2}\text{W}^{-1}$)	Responsivity @ λ_p (min.) (V/W)	Resistance ($M\Omega$)	Time Constant (μsec)	Operating Temperature (K)	Standard Package
J13P Series Room Temperature PbS										
PS3-0-01	1100012	1 x 1	2.5	7.7×10^{10}	7.7×10^8	3×10^5	0.5 - 2.5	150 - 350	298	Plate
PS3-0-02	1100020	2 x 2				1.5×10^5				
PS3-0-03	1100025	3 x 3				1×10^5				
PS3-0-06	1100160	6 x 6				5×10^4				
PS3-0-10	1100190	10 x 10				3×10^4				
J13TO Series Room Temperature TO Package PbS										
PS3-0-51	1200045	1 x 1	2.5	7.7×10^{10}	7.7×10^8	3×10^5	0.5 - 2.5	150 - 350	298	TO-5
PS3-0-52	1200075	2 x 2				1.5×10^5				
PS3-0-53	1200090	3 x 3				1×10^5				
PS3-0-86	1200135	6 x 6				5×10^4				TO-8
J13TE Series Thermoelectrically Cooled PbS										
PS3-1-71	1200285	1 x 1	2.5	1.5×10^{11}	1.5×10^9	7×10^5	0.5 - 8	500 - 1000	253	Single Stage TO-37 TO-3
PS3-1-72	1200295	2 x 2				3.5×10^5				
PS3-1-73	1200305	3 x 3				2.3×10^5				
PS3-1-310	1200306	10 x 10				0.7×10^5				
PS3-1-81	1200367	1 x 1	2.5	1.5×10^{11}	1.5×10^9	7×10^5	0.5 - 8	500 - 1000	253	One- Stage TO-8
PS3-1-82	1200368	2 x 2				3.5×10^5				
PS3-1-83	1200369	3 x 3				2.3×10^5				
PS3-2-71	1200325	1 x 1	2.6	2.5×10^{11}	2.3×10^9	9×10^5	1 - 10	700 - 1200	243	Two- Stage TO-37
PS3-2-72	1200345	2 x 2				4.5×10^5				
PS3-2-73	1200365	3 x 3				3×10^5				
PS3-2-81	1200328	1 x 1	2.6	2.5×10^{11}	2.3×10^9	9×10^5	1 - 10	700 - 1200	243	Two- Stage TO-8
PS3-2-82	1200338	2 x 2				4.5×10^5				
PS3-2-83	1200358	3 x 3				3×10^5				
PS3-3-31	1200371	1 x 1	2.7	3×10^{11}	1.8×10^9	1×10^6	2 - 25	2500 - 3500	208	Three- Stage TO-3
PS3-3-32	1200372	2 x 2				5×10^5				
PS3-3-33	1200373	3 x 3				3.5×10^5				

J13 Lead Sulfide Detectors continued



RECOMMENDED MAXIMUM DETECTOR VOLTAGE vs DETECTOR AREA AND RESISTANCE FOR DETECTOR TEMPERATURE OF 298K (25°C)

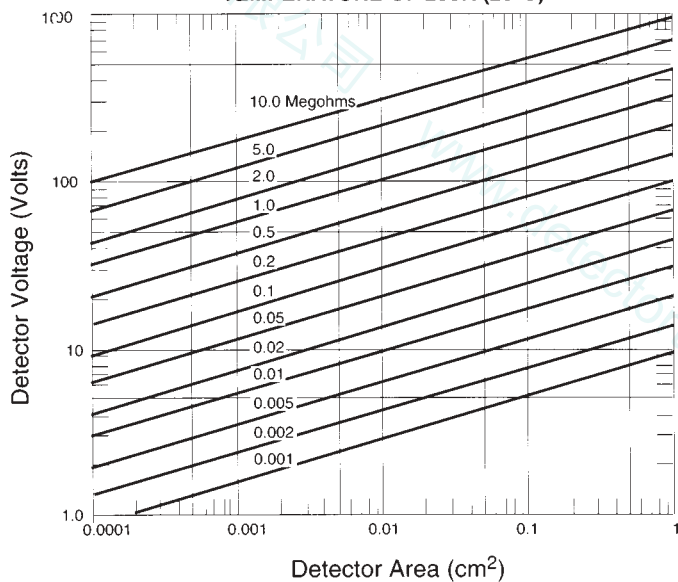

TYPICAL PEAK RESPONSIVITY vs ACTIVE AREA FOR DETECTOR TEMPERATURE OF 298K (25°C)

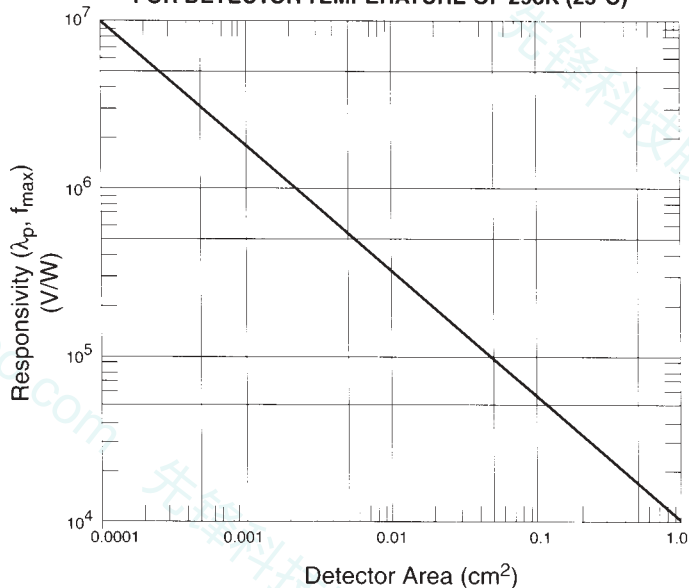

- NOTES: 1. Detector Voltage is bias voltage across detector terminals.
 2. Use factor of 2 less for maintaining optimum D^*
 3. At other temperatures, high and low, the bias voltage depends on methods of heat sinking which affect the power dissipation. At temperatures equal to or lower than 193K (-80°C) and for equivalent resistance values, the bias voltage is normally a factor of two greater than shown here. Refer to the bias voltage data supplied with detectors.

EXAMPLE OF NOISE vs FREQUENCY AS A FUNCTION OF DETECTOR TEMPERATURE

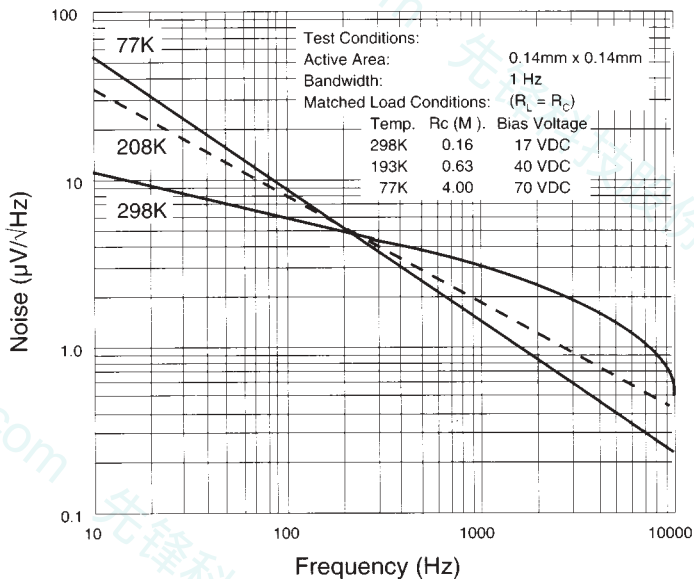

RELATIVE DETECTIVITY vs FREQUENCY FOR VARIOUS TIME CONSTANT DETECTORS WHEN OPERATING AT 298K (25°C)

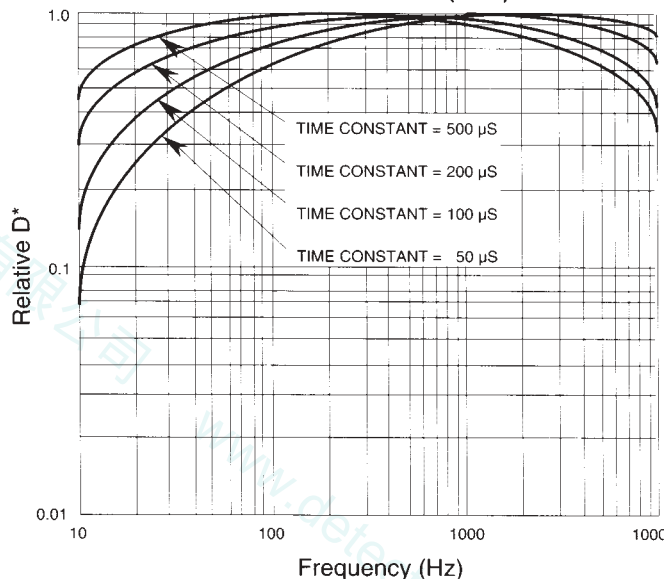

J14 Lead Selenide Detectors (2.0 to 6.0 μm)



Description

The J14 Series detectors are Lead Selenide (PbSe) photoconductive (PC) detectors designed for operation in the 2-6 μm wavelength region. The wavelength of peak response depends on the operating temperature and varies from 4 to 4.7 μm .

These detectors provide an economical means of obtaining high performance in a rugged and compact package. They are offered in flat plate cells, TO-style packages both with and without thermoelectric coolers which provide low temperature operation for increased sensitivity, longer wavelength operation and temperature stability.

Parts listed in this catalog are Judson standard product offering. Custom detectors and specifications are offered with built-in electronics and discreet filters. Multiwavelength detectors and arrays are routinely provided in prototype through production quantities.

Judson room temperature PbSe provides exceptional performance with minimum peak D^* two to three times what other manufacturers offer as standard specifications.

J14P Series

Room Temperature PbSe Plate Cells

These basic detecting elements consist of a sensitized PbSe film, electrodes and two electrical leads encapsulated on a quartz substrate. They come standard in active areas from 1 to 3 mm square. Judson room temperature PbSe provides exceptional performance with minimum peak D^* two to three times what other manufacturers offer as standard specifications.

J14TO Series

Room Temperature TO Packaged PbSe Detectors

These detectors are fabricated utilizing a hermetically sealed and inert gas backfilled TO-5 style semiconductor package. This package protects the active element and provides the versatility of directly soldering or plugging into a PC board during manufacturing.

J14TE1 Series

1-Stage Thermoelectrically Cooled PbSe Detectors

The J14TE1 Series detectors are high quality temperature stabilized PbSe detectors mounted on a one-stage thermoelectric cooler with a thermistor for control and stabilization of the detector element.

J14TE2 Series

2-Stage Thermoelectrically Cooled PbSe Detectors

The J14TE2 Series detectors are high quality temperature stabilized PbSe detectors mounted on a two-stage thermoelectric cooler with a thermistor for control and stabilization of the detector element.

J14TE3 Series

3-Stage Thermoelectrically Cooled PbSe Detectors

The J14TE3 Series detectors are high quality temperature stabilized PbSe detectors mounted on a three-stage thermoelectric cooler with a thermistor for control and stabilization of the detector element. At the standard operating temperature of -65°C , this detector offers exceptional sensitivity in a compact and easy to integrate package. Peak detectivity is greater than 4.7 μm .



Applications

- Environmental Gas Analysis
- Medical Gas Analysis
- Flame Spectroscopy
- Optical Pyrometry
- NDIR Spectroscopy
- Defense Applications

Figure 20-1
Detectivity vs Wavelength for J14 Series PbSe

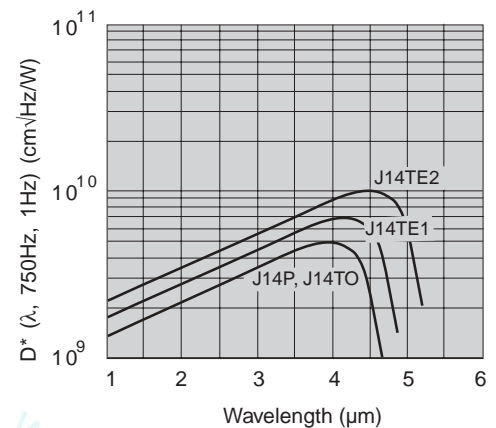

J14 Lead Selenide Detectors continued



Model Number	Part Number	Active Size (mm)	Wavelength λ_p (μm)	D* (λ_p , 750, 1) (min.) ($\text{cmHz}^{1/2}\text{W}^{-1}$)	Blackbody D* (500K, 750, 1) (min.) ($\text{cmHz}^{1/2}\text{W}^{-1}$)	Responsivity @ λ_p (min.) (V/W)	Resistance ($M\Omega$)	Time Constant (μsec)	Operating Temperature (K)	Standard Package	Cooler Power (W)
J14P Series Room Temperature PbSe											
PE-0-01	1500501	1 x 1	3.8 - 4.0	5x10 ⁹	5.5x10 ⁸	1.5x10 ⁴	0.1 - 2.0	0.5 - 1.5	298	Plate Cell	N/A
PE-0-02	1500502	2 x 2				7.5x10 ³					
PE-0-03	1500503	3 x 3				5x10 ³					
J14TO Series Room Temperature TO Package PbSe											
PE-0-51	1500526	1 x 1	3.8 - 4.0	5x10 ⁹	5.5x10 ⁸	1.5x10 ⁴	0.1 - 2.0	0.5 - 1.5	298	TO-5	N/A
PE-0-52	1500527	2 x 2				7.5x10 ³					
PE-0-53	1500528	3 x 3				5x10 ³					
J14TE Series Thermoelectrically Cooled PbSe											
PE-1-71	1500529	1 x 1	4.3 - 4.5	7x10 ⁹	9.3x10 ⁸	2.5x10 ⁴	0.2 - 5.0	3 - 10	253	Single- Stage TO-37	1.3
PE-1-72	1500530	2 x 2				1x10 ⁴					
PE-1-73	1500531	3 x 3				6x10 ³					
PE-1-81	1500532	1 x 1	4.3 - 4.5	7x10 ⁹	9.3x10 ⁸	2.5x10 ⁴	0.2 - 5.0	3 - 10	253	Single Stage TO-8	1.3
PE-1-82	1500533	2 x 2				1x10 ⁴					
PE-1-83	1500534	3 x 3				6x10 ³					
PE-2-71	1500535	1 x 1	4.4 - 4.6	1x10 ¹⁰	1.3x10 ⁹	5x10 ⁴	0.4 - 10	5 - 25	233-243	Two- Stage TO-37	2.5
PE-2-72	1500536	2 x 2				3x10 ⁴					
PE-2-73	1500537	3 x 3				1x10 ⁴					
PE-2-81	1500538	1 x 1	4.4 - 4.6	1x10 ¹⁰	1.3x10 ⁹	5x10 ⁴	0.4 - 10	5 - 25	233-243	Two- Stage TO-8	2.5
PE-2-82	1500539	2 x 2				3x10 ⁴					
PE-2-83	1500540	3 x 3				1x10 ⁴					
PE-3-31	1500544	1 x 1	4.6 - 4.8	2x10 ¹⁰	3.2x10 ⁹	1x10 ⁵	1.0 - 35	10 - 50	208	Three- Stage TO-3	4.0
PE-3-32	1500545	2 x 2				5x10 ⁴					
PE-3-33	1500546	3 x 3				2.5x10 ⁴					

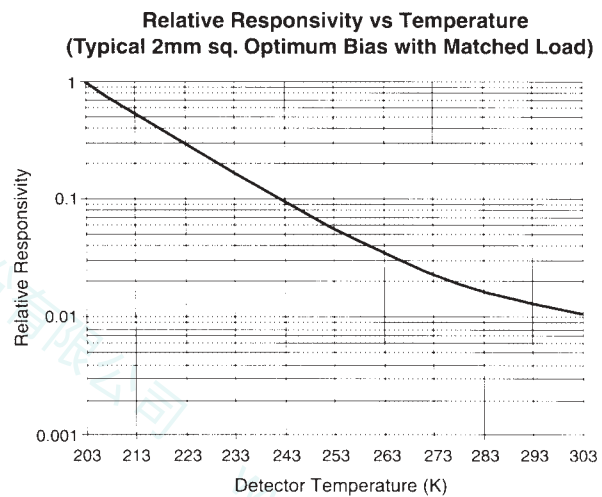
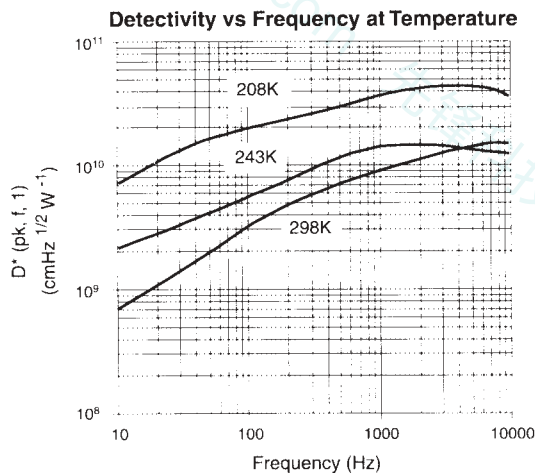

Packages for Judson's Lead Selenide and Lead Sulfide Detectors

TO-3

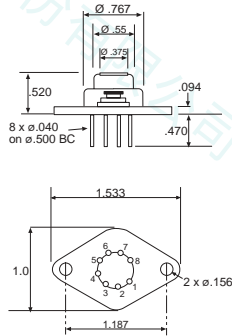

Single Stage TO-37

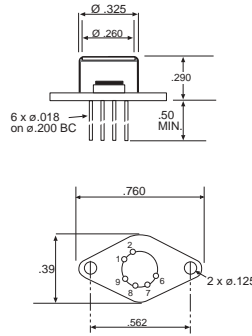

Single Stage TO-8

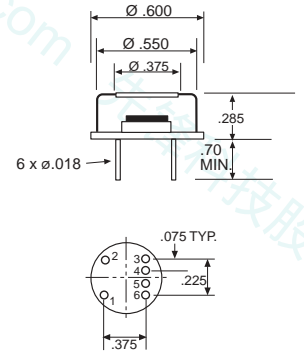

TO-5

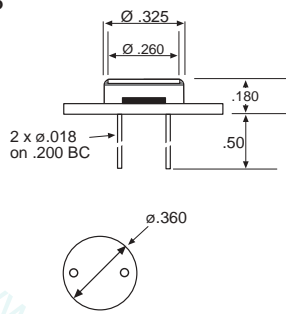

Two Stage TO-37

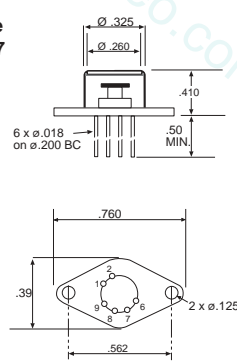

Two Stage TO-8

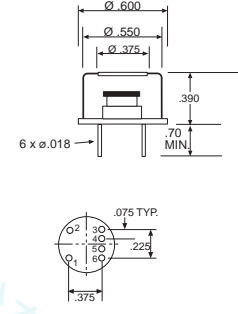

Basic Operating Circuit for Lead Selenide and Lead Sulfide Detectors

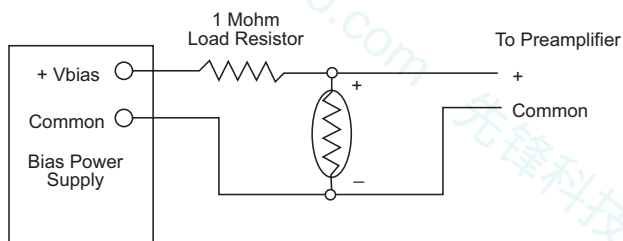

PA-8200 Preamp for use with Judson's Lead Selenide and Lead Sulfide Detectors

The Model PA-8200 low-noise voltage preamplifier is recommended for all J13 and J14 Series detectors. A load resistor is selected to match the detector resistance.

Preamp gain and typical bandwidth specifications are listed in the table opposite. For best results, choose the preamp model with the narrowest suitable bandwidth to keep preamp noise to a minimum.

Typical Preamp Specifications

Model	PA-8200 Preamp
Gain	12 to 300
Bandwidth	10 KHz
Input Noise Voltage	1.5 nVHz ^{-1/2}
Input Impedance	50 KΩ
Max. Output (Load ≥ 1KΩ)	10 Vpp
Detector Bias	External
Power Requirement (VDC)	± 15
Power Requirement (mA)	200
Case Dimensions (excluding connectors)	2" x 3" x 1"