



NAV/COMM Test Set IFR 4000 Operation Manual

Issue-3

EXPORT CONTROL WARNING: This document contains controlled technology or technical data under the jurisdiction of the Export Administration Regulations (EAR), 15 CFR 730-774. It cannot be transferred to any foreign third party without the specific prior approval of the U.S. Department of Commerce, Bureau of Industry and Security (BIS). Violations of these regulations are punishable by fine, imprisonment, or both.

OPERATION MANUAL

NAV/COMM TEST SET

IFR 4000

PUBLISHED BY
Aeroflex

COPYRIGHT © Aeroflex 2011

All rights reserved. No part of this publication may be reproduced, stored in a retrieval system, or transmitted in any form or by any means, electronic, mechanical, photocopying, recording or otherwise without the prior permission of the publisher.

Reissued	Jan 2010
Issue-2	Mar 2010
Issue-3	Sep 2011

10200 West York / Wichita, Kansas 67215 U.S.A. / (316) 522-4981 / FAX (316) 524-2623

Subject to Export Control, see Cover Page for details.



Electromagnetic Compatibility:

For continued EMC compliance, all external cables must be shielded and three meters or less in length.

Nomenclature Statement:

In this manual IFR 4000, 4000, Test Set or Unit refers to the IFR 4000 NAV/COMM Test Set.



THIS PAGE INTENTIONALLY LEFT BLANK.

SAFETY FIRST: TO ALL OPERATIONS PERSONNEL

REFER ALL SERVICING OF UNIT TO QUALIFIED TECHNICAL PERSONNEL. THIS UNIT CONTAINS NO OPERATOR SERVICEABLE PARTS.

WARNING: USING THIS EQUIPMENT IN A MANNER NOT SPECIFIED BY THE ACCOMPANYING DOCUMENTATION MAY IMPAIR THE SAFETY PROTECTION PROVIDED BY THE EQUIPMENT.

CASE, COVER OR PANEL REMOVAL

Opening the Case Assembly exposes the operator to electrical hazards that can result in electrical shock or equipment damage. Do not operate this Test Set with the Case Assembly open.

SAFETY IDENTIFICATION IN TECHNICAL MANUAL

This manual uses the following terms to draw attention to possible safety hazards, that may exist when operating or servicing this equipment.

CAUTION: THIS TERM IDENTIFIES CONDITIONS OR ACTIVITIES THAT, IF IGNORED, CAN RESULT IN EQUIPMENT OR PROPERTY DAMAGE (E.G., FIRE).

WARNING: THIS TERM IDENTIFIES CONDITIONS OR ACTIVITIES THAT, IF IGNORED, CAN RESULT IN PERSONAL INJURY OR DEATH.

SAFETY SYMBOLS IN MANUALS AND ON UNITS

CAUTION: Refer to accompanying documents. (This symbol refers to specific CAUTIONS represented on the unit and clarified in the text.)



AC OR DC TERMINAL: Terminal that may supply or be supplied with AC or DC voltage.



DC TERMINAL: Terminal that may supply or be supplied with DC voltage.



AC TERMINAL: Terminal that may supply or be supplied with AC or alternating voltage.

EQUIPMENT GROUNDING PRECAUTION

Improper grounding of equipment can result in electrical shock.

USE OF PROBES

Check the specifications for the maximum voltage, current and power ratings of any connector on the Test Set before connecting it with a probe from a terminal device. Be sure the terminal device performs within these specifications before using it for measurement, to prevent electrical shock or damage to the equipment.

POWER CORDS

Power cords must not be frayed, broken nor expose bare wiring when operating this equipment.

USE RECOMMENDED FUSES ONLY

Use only fuses specifically recommended for the equipment at the specified current and voltage ratings.

INTERNAL BATTERY

This unit contains a Lithium Ion Battery, serviceable only by a qualified technician.

CAUTION: SIGNAL GENERATORS CAN BE A SOURCE OF ELECTROMAGNETIC INTERFERENCE (EMI) TO COMMUNICATION RECEIVERS. SOME TRANSMITTED SIGNALS CAN CAUSE DISRUPTION AND INTERFERENCE TO COMMUNICATION SERVICES OUT TO A DISTANCE OF SEVERAL MILES. USERS OF THIS EQUIPMENT SHOULD SCRUTINIZE ANY OPERATION THAT RESULTS IN RADIATION OF A SIGNAL (DIRECTLY OR INDIRECTLY) AND SHOULD TAKE NECESSARY PRECAUTIONS TO AVOID POTENTIAL COMMUNICATION INTERFERENCE PROBLEMS.



THIS PAGE INTENTIONALLY LEFT BLANK.



DECLARATION OF CONFORMITY

The Declaration of Conformity Certificate included with the unit should remain with the unit.

Aeroflex recommends the operator reproduce a copy of the Declaration of Conformity Certificate to be stored with the Operation Manual for future reference.



THIS PAGE INTENTIONALLY LEFT BLANK.



TABLE OF CONTENTS

Title	Chapter/Section
Title / Copyright Page	
Statements	
Safety Page	
Declaration of Conformity	
Table of Contents	
Introduction	
Service Upon Receipt of Material	
Chapter 1	
Section 1 - Description	1-1
Section 2 - Operation	1-2
Section 3 - Specifications	1-3
Section 4 - Shipping	1-4
Section 5 - Storage	1-5
Appendix A - Connector Pin-Out Tables	
Appendix B - Metric/British Imperial Conversion Table with Nautical Distance Conversions	
Appendix C - Factory Presets	
Appendix D - Abbreviations	
Appendix E - Serial Interface Cable	
Appendix F - 406 Beacon Applications and Protocols	
Index	
Battery/Voltage Instructions	



THIS PAGE INTENTIONALLY LEFT BLANK.

INTRODUCTION

This manual contains operating instructions for the IFR 4000. It is strongly recommended that personnel be thoroughly familiar with the contents of this manual before attempting to operate this equipment.

Refer all servicing of unit to qualified technical personnel.

ORGANIZATION

This manual is divided into the following Chapters and Sections:

CHAPTER 1 - OPERATION

Section 1 - DESCRIPTION

Section 2 - OPERATION (installation; description of controls, connectors and indicators; performance evaluation; operating procedures)

Section 3 - SPECIFICATIONS

Section 4 - SHIPPING

Section 5 - STORAGE



THIS PAGE INTENTIONALLY LEFT BLANK.



CHAPTER ONE
IFR 4000 NAV/COMM TEST SET
OPERATION MANUAL
TABLE OF CONTENTS

Title	Chapter/Section/Subject	Page
SECTION 1 - DESCRIPTION	1-1	
1. General Description and Capabilities	1-1-1	1
1.1 Description	1-1-1	1
1.2 Functional Capabilities	1-1-1	1
SECTION 2 - OPERATION	1-2	
1. Installation	1-2-1	1
1.1 General	1-2-1	1
1.2 Battery Operation	1-2-1	1
1.3 Battery Charging	1-2-1	1
1.4 Safety Precautions	1-2-1	1
1.4.1 Complying with Instructions	1-2-1	1
1.4.2 Grounding Power Cord	1-2-1	1
1.4.3 Operating Safety	1-2-1	1
1.5 AC Power Requirements	1-2-1	2
1.6 Battery Recharging	1-2-1	2
1.7 External Cleaning	1-2-1	3
2. Controls, Connectors and Indicators	1-2-2	1
3. Performance Evaluation	1-2-3	1
3.1 General	1-2-3	1
3.2 Self Test	1-2-3	1
4. Operating Procedures	1-2-4	1
4.1 General	1-2-4	1
4.2 Screen Descriptions	1-2-4	2
4.2.1 Startup Screen	1-2-4	2
4.2.2 Setup Menu	1-2-4	3
4.2.3 Guided Test Screens	1-2-4	4
4.2.4 Store/Recall Screens	1-2-4	6
4.2.5 Hardware Tools Screen	1-2-4	7
4.2.6 RS-232 Settings Screen	1-2-4	8
4.2.7 Diagnostics Screen	1-2-4	8
4.2.8 Self Test Screen	1-2-4	9
4.2.9 Calibration Screen	1-2-4	10
4.2.10 Info Screen	1-2-4	10
4.2.11 VOR Mode Screen	1-2-4	11
4.2.12 Localizer Mode Screen	1-2-4	13
4.2.13 Glideslope Mode Screen	1-2-4	15
4.2.14 Marker Beacon Mode Screen	1-2-4	17
4.2.15 ILS Mode Screen	1-2-4	18
4.2.16 COMM AM Mode Screen	1-2-4	21
4.2.17 COMM FM Mode Screen	1-2-4	23
4.2.18 COMM SSB Mode Screen	1-2-4	25
4.2.19 PWR MTR ZERO Screen	1-2-4	27
4.2.20 SWR Mode Screen	1-2-4	27
4.2.21 SELCAL Mode Screen	1-2-4	30
4.2.22 Frequency Counter Mode Screen	1-2-4	31
4.2.23 121.5/243 BEACON Mode Screen	1-2-4	32
4.2.24 406 BEACON Mode Screen	1-2-4	33



Title	Chapter/Section/Subject	Page
SECTION 2 - OPERATION (cont)		
4. Operating Procedures (cont)		
4.3 General Operating Information	1-2-4	41
4.2.1 Startup Screen	1-2-4	41
4.2.2 Setup Menu	1-2-4	41
4.2.3 VOR Mode	1-2-4	42
4.2.4 Localizer Mode	1-2-4	44
4.2.5 Glideslope Mode	1-2-4	46
4.2.6 Marker Beacon Mode	1-2-4	48
4.2.7 ILS Mode	1-2-4	49
4.2.8 COMM AM Mode	1-2-4	50
4.2.9 COMM FM Mode	1-2-4	52
4.2.10 COMM SSB Mode	1-2-4	54
4.2.11 SWR Mode	1-2-4	56
4.2.12 SELCAL Mode	1-2-4	57
4.2.13 Frequency Counter Mode	1-2-4	58
4.2.14 121.5/243 BEACON Mode Screen	1-2-4	59
4.2.15 406 BEACON Mode Screen	1-2-4	60
4.4 Guided Test	1-2-4	60
4.4.1 Creating a Sequence	1-2-4	60
4.4.2 Deleting a Sequence	1-2-4	62
4.4.3 Playing a Sequence	1-2-4	63
4.4.4 Download Sequences through a Remote Connection	1-2-4	63
4.4.5 Upload Sequences through a Remote Connection	1-2-4	64
SECTION 3 - SPECIFICATIONS		1-3
SECTION 4 - SHIPPING		1-4
1. Shipping Test Sets	1-4-1	1
1.1 Information	1-4-1	1
1.2 Repacking Procedure	1-4-1	1
SECTION 5 - STORAGE		1-5

LIST OF ILLUSTRATIONS

Title	Chapter/Section/Subject	Page
Battery Recharging	1-2-1	2
IFR 4000 Front Panel	1-2-2	1
Analog CDI with 5 Dot ILS Deviation	1-2-4	45
EFIS with 2 1/2 Dot ILS Deviation	1-2-4	45
Repacking Procedure	1-4-1	1

LIST OF TABLES

Title	Chapter/Section/Subject	Page
Self Test Failures	1-2-3	2
406 BEACON Message Fields	1-2-4	38



THIS PAGE INTENTIONALLY LEFT BLANK.

SERVICE UPON RECEIPT OF MATERIAL

Unpacking

Special-design packing material inside this shipping carton provides maximum protection for the IFR 4000. Avoid damaging the carton and packing material during equipment unpacking. Use the following steps for unpacking the IFR 4000.

- Cut and remove the sealing tape on the carton top and open the carton.
- Grasp the IFR 4000 transit case firmly, while restraining the shipping carton, and lift the equipment and packing material vertically.
- Place the IFR 4000 transit case and end cap packing on a suitable flat, clean and dry surface.
- Remove the protective plastic bag from the IFR 4000 transit case. Place protective plastic bag and end cap packing material inside shipping carton. Store the shipping carton for future use should the IFR 4000 need to be returned.

Checking Unpacked Equipment

- Inspect the equipment for damage incurred during shipment. If the equipment has been damaged, report the damage to Aeroflex.
- Check the equipment against the packing slip to see if the shipment is complete. Report all discrepancies to Aeroflex.

DESCRIPTION	PART NUMBER	STANDARD/OPTIONAL	QTY
IFR 4000		STANDARD	1
AC/DC POWER SUPPLY	67366 (7110-5600-200)	STANDARD	1
VHF/UHF MULTI-BAND ANTENNA	9140 (1201-5601-000)	STANDARD	1
ANTENNA	9137 (1201-0909-900)	STANDARD	1
TNC (MALE - MALE) COAXIAL CABLE	62398 (6041-5680-800)	STANDARD	1
TNC SHORT	24140 (2289-0001-009)	STANDARD	1
50 Ω LOAD	24141 (2289-0001-010)	STANDARD	1
5 A FUSE	56080 (5106-0000-057)	STANDARD	1
TRANSIT CASE	10238 (1412-5653-000)	STANDARD	1
POWER CORD (110 USE) (US ONLY)	62302 (6041-0001-000)	STANDARD	1
ANTENNA INSTRUCTIONS (PAPER)	6085 (1002-5600-8P0)	STANDARD	1
PASSWORD CARD (PAPER)	6086 (1002-5600-9P0)	STANDARD	1
OPERATION MANUAL (CD-ROM)	6081 (1002-5600-2C0)	STANDARD	1

MAINTENANCE MANUAL (CD-ROM)	6083 (1002-5600-4C0)	OPTIONAL	
RS-232 INTERFACE CABLE (15-PIN)	62399 (6041-5680-900)	OPTIONAL	
RS-232 INTERFACE CABLE (25-PIN)	62400 (6041-5681-200)	OPTIONAL	
BENCH STAND	63656 (6500-5681-000)	OPTIONAL	
POWER CORDS (220 USE)	64020 (7001-9903-000)	OPTIONAL	

STANDARD EQUIPMENT



OPTIONAL EQUIPMENT





THIS PAGE INTENTIONALLY LEFT BLANK.

SECTION 1 - DESCRIPTION

1. GENERAL DESCRIPTION AND CAPABILITIES

1.1 DESCRIPTION

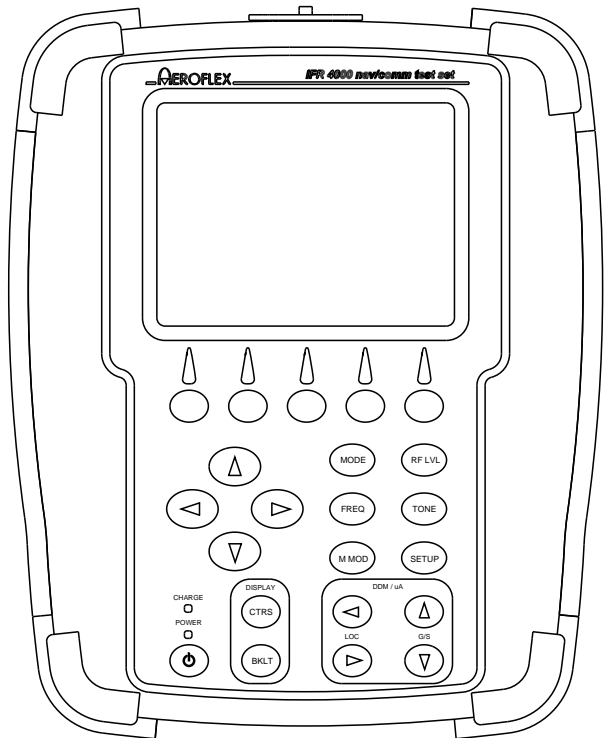

056P-07

The IFR 4000 is a Flight Line or Ramp Test Set for testing ILS, VOR, Marker Beacon, HF/VHF/UHF Communications (NAV/COMM) Systems, and with the ELT Option, 121.5/243 MHz Short Range Emergency Beacons and 406 MHz COSPAS/SARSAT Long Range Emergency Beacons.

The IFR 4000 is designed for ease of use, portability, reliability and long service life. The IFR 4000 may also be used for bench testing in the General Aviation environment.

Power is derived from an internal battery. For DC input, the DC POWER Connector is provided for battery charging, bench operation or servicing use.

The IFR 4000 and supplied accessories are stored in a Ruggedized Plastic Transport Case.

1.2 FUNCTIONAL CAPABILITIES

The IFR 4000 has the following features and capabilities:

- Accurate measurements of VHF/UHF transmitter frequency, output power, modulation (AM and FM) and receiver sensitivity.
- Accurate measurements of HF transmitter frequency, output power, modulation (AM) and SSB USB/LSB receiver sensitivity.
- Generation of ARINC 596 Selective Calling Tones.
- Accurate measurement of VHF/UHF antenna and or feeder SWR (Standing Wave Ratio).
- Simulation of Localizer and Glideslope (CAT I, II and III) Signals with variable DDM settings.
- Swept Localizer DDM for coupled Auto Pilot testing. (Simultaneous Localizer, Glideslope and Marker signals.)
- Simulation of VOR beacon with variable bearing.
- Simulation of Marker Beacon, Selectable Airways (Z), Outer and Middle Marker Tones.
- Guided Test capability allows instrument setup steps to be stored.
- Accurate measurement of 121.5/243 Hz emergency beacon transmitter frequency, output power and modulation (AM). Audio output for headphones to monitor swept tone. (p/o ELT Option)
- Accurate measurement of 406 MHz COSPAS/SARSAT beacon transmitter frequency and output power. Decodes and displays all location and user protocols. (p/o ELT Option)
- Large LCD Display with user adjustable Backlight and Contrast.
- Internal Battery allows eight hours operation before recharge.

1.2 FUNCTIONAL CAPABILITIES (cont)

- Automatic power shutdown after approximately 5 to 20 minutes (selectable) of non-use when AC power is not connected.
- Compact and lightweight enough to allow for one person operation.

SECTION 2 - OPERATION

1. INSTALLATION

1.1 GENERAL

The IFR 4000 is powered by an internal Lithium Ion battery pack. The Test Set is supplied with an external DC Power Supply that enables the operator to recharge the battery when connected to AC power.

NOTE: The IFR 4000 can operate continuously on AC power via the DC Power Supply, for servicing and/or bench tests.

Refer to 1-2-2, Figure 2 for location of controls, connectors or indicators.

1.2 BATTERY OPERATION

The internal battery is equipped to power the IFR 4000 for eight hours of continuous use, after which time, the IFR 4000 battery needs recharging. Battery Operation Time Remaining (in Hours) is displayed on all screens.

The IFR 4000 contains an automatic time-out to conserve power. If a key is not pressed within a 5 to 20 minute time period, the Test Set shuts Off (only when using battery power). The Power Down Time may be set in the Setup Screen.

1.3 BATTERY CHARGING

The battery charger operates whenever DC power (11 to 32 Vdc) is applied to the Test Set with the supplied DC Power Supply or a suitable DC power source. When charging, the battery reaches an 100% charge in approximately four hours. The internal battery charger allows the battery to charge between a temperature range of 5° to 40°C. The IFR 4000 can operate, connected to an external DC source, outside the battery charging temperature range (5° to 40°C).

The battery should be charged every three months (minimum) or disconnected for long term inactive storage periods of more than six months. The Battery must be removed when conditions surrounding the Test Set are <-20°C and >60°C)

1.4 SAFETY PRECAUTIONS

The following safety precautions must be observed during installation and operation. Aeroflex assumes no liability for failure to comply with any safety precaution outlined in this manual.

1.4.1 Complying with Instructions

Installation/operating personnel should not attempt to install or operate the IFR 4000 without reading and complying with instructions contained in this manual. All procedures contained in this manual must be performed in exact sequence and manner described.

1.4.2 Grounding Power Cord

WARNING: DO NOT USE A THREE-PRONG TO TWO-PRONG ADAPTER PLUG. DOING SO CREATES A SHOCK HAZARD BETWEEN THE CHASSIS AND ELECTRICAL GROUND.

For AC operation, the AC Line Cable, connected to the DC Power Supply, is equipped with standard three-prong plug and must be connected to a properly grounded three-prong receptacle that is easily accessible. It is the customer's responsibility to:

- Have a qualified electrician check receptacle(s) for proper grounding.
- Replace any standard two-prong receptacle(s) with properly grounded three-prong receptacle(s).

1.4.3 Operating Safety

Due to potential for electrical shock within the Test Set, the Case Assembly must be closed when the Test Set is connected to an external power source.

Battery replacement, fuse replacement and internal adjustments must only be performed by qualified service technicians.

1.5 AC POWER REQUIREMENTS

The DC Power Supply, supplied with the IFR 4000, operates over a voltage range of 100 to 250 VAC at 47 to 63 Hz.

The battery charger operates whenever DC power (11 to 32 Vdc) is applied to the Test Set with the supplied DC Power Supply or a suitable DC power source. When charging, the battery reaches an 100% charge in approximately four hours. The Battery Charging temperature range is 5° to 40°C, controlled by an internal battery charger.

1.6 BATTERY RECHARGING

Refer to 1-2-1, Figure 1.

STEP	PROCEDURE
1.	Connect AC Line Cable to either: <ul style="list-style-type: none"> ● AC PWR Connector on the DC Power Supply and an appropriate AC power source ● Suitable DC power source
2.	Connect the DC Power Supply to the DC POWER Connector on the IFR 4000.
3.	Verify the CHARGE Indicator illuminates yellow.
4.	Allow four hours for battery charge or until the CHARGE Indicator illuminates green.

NOTE: If the CHARGE Indicator flashes yellow and/or the battery fails to accept a charge and the IFR 4000 does not operate on battery power, the battery, serviceable only by a qualified technician, requires replacement. Refer to Battery/Voltage Instructions.

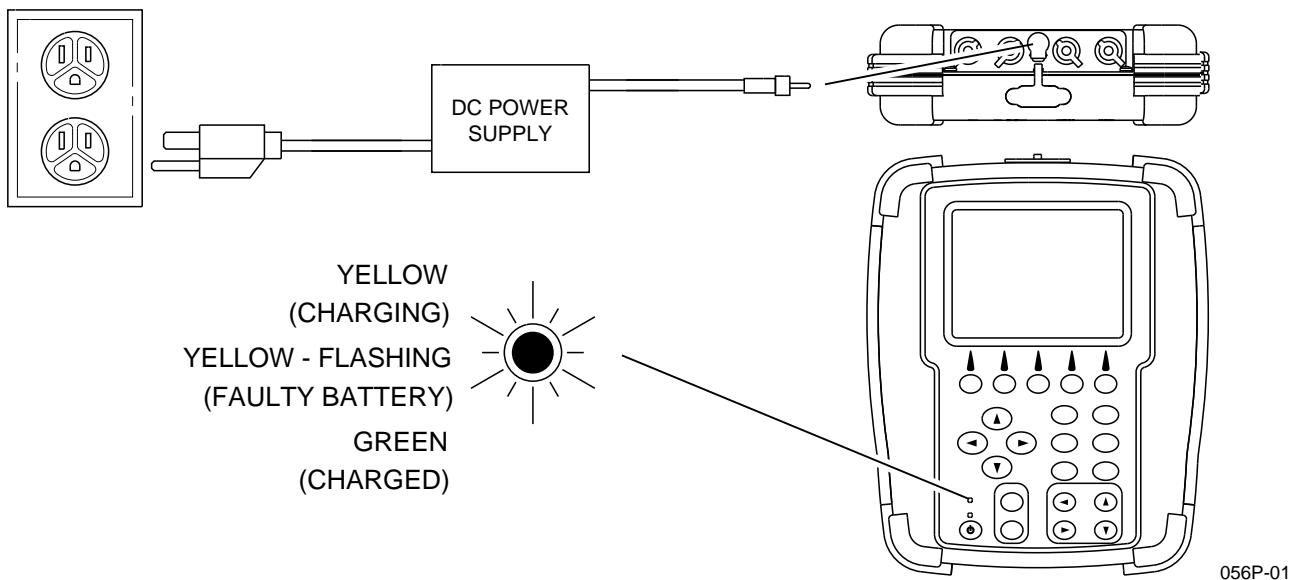

Battery Recharging
Figure 1

1.7 EXTERNAL CLEANING

The following procedure contains routine instructions for cleaning the outside of the Test Set.

CAUTION: DISCONNECT POWER FROM TEST SET TO AVOID POSSIBLE DAMAGE TO ELECTRONIC CIRCUITS.

STEP	PROCEDURE
1.	Clean front panel buttons and display face with soft lint-free cloth. If dirt is difficult to remove, dampen cloth with water and a mild liquid detergent.
2.	Remove grease, fungus and ground-in dirt from surfaces with soft lint-free cloth dampened (not soaked) with isopropyl alcohol.
3.	Remove dust and dirt from connectors with soft-bristled brush.
4.	Cover connectors, not in use, with suitable dust cover to prevent tarnishing of connector contacts.
5.	Clean cables with soft lint-free cloth.
6.	Paint exposed metal surface to avoid corrosion.



THIS PAGE INTENTIONALLY LEFT BLANK.

2. CONTROLS, CONNECTORS AND INDICATORS

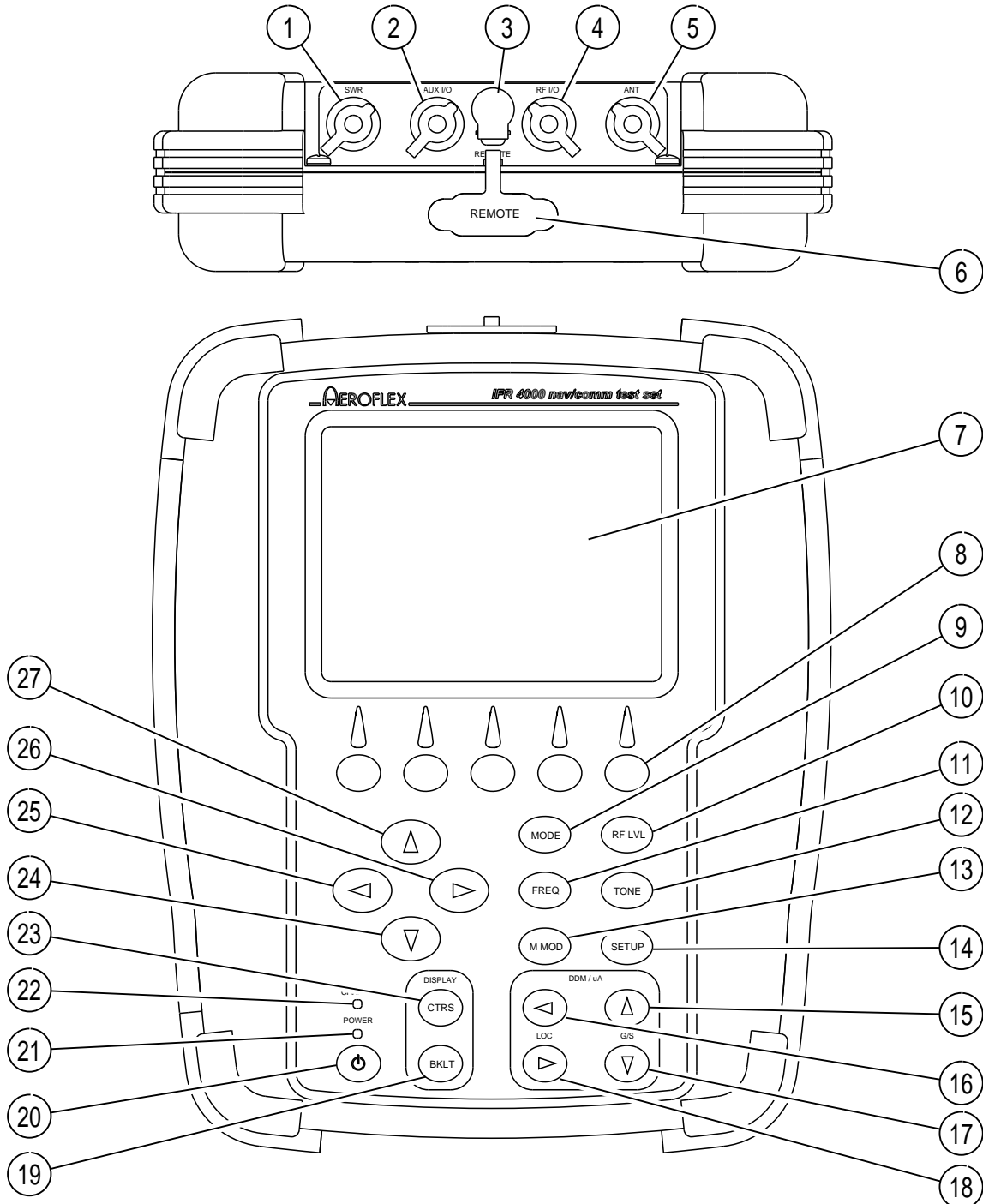

056P-06

IFR 4000 Front Panel
Figure 2



NUMERICAL LOCATION LIST		ALPHABETICAL LOCATION LIST	
1.	SWR Connector	ANT Connector	5
2.	AUX I/O Connector	AUX I/O Connector	2
3.	DC POWER Connector	BACKLIGHT Key	19
4.	RF I/O Connector	CHARGE Indicator	22
5.	ANT Connector	CONTRAST Key	23
6.	REMOTE Connector	DC POWER Connector	3
7.	Display	DECREMENT/SELECT Data Key	24
8.	Multi-Function Soft Keys	Display	7
9.	MODE Select Key	FREQ Field Select Key	11
10.	RF LVL Field Select Key	G/S DDM DOWN Key	17
11.	FREQ Field Select Key	G/S DDM UP Key	15
12.	TONE Field Select Key	INCREMENT/SELECT Data Key	27
13.	M MOD Field Select Key	LOC DDM LEFT Key	16
14.	SETUP Key	LOC DDM RIGHT Key	18
15.	G/S DDM UP Key	M MOD Field Select Key	13
16.	LOC DDM LEFT Key	MODE Select Key	9
17.	G/S DDM DOWN Key	Multi-Function Soft Keys	8
18.	LOC DDM RIGHT Key	POWER Indicator	21
19.	BACKLIGHT Key	POWER Key	20
20.	POWER Key	RF I/O Connector	4
21.	POWER Indicator	REMOTE Connector	6
22.	CHARGE Indicator	RF LVL Field Select Key	10
23.	CONTRAST Key	SELECT DATA UNIT LSB Key	26
24.	DECREMENT/SELECT Data Key	SELECT DATA UNIT MSB Key	25
25.	SELECT DATA UNIT MSB Key	SETUP Key	14
26.	SELECT DATA UNIT LSB Key	SWR Connector	1
27.	INCREMENT/SELECT Data Key	TONE Field Select Key	11



ITEM	DESCRIPTION	ITEM	DESCRIPTION
1.	SWR Connector TNC Type Connector used for VSWR measurements on Antenna and Feeder Systems.	10.	RF LVL Field Select Key This Key moves the edit cursor to the RF LVL (RF Level) Field. The INCREMENT/SELECT Data Key or the DECREMENT/SELECT Data Key may be used to slew the RF Level. The SELECT DATA UNITS MSB Key or the SELECT DATA UNITS LSB Key may be used to select the RF LVL units to be slewed (i.e., 0.1 dB, 1 dB, etc.).
2.	AUX I/O Connector BNC Type Connector for output of baseband modulation and 10 MHz reference and for counter input.	11.	FREQ Field Select Key This Key moves the edit cursor to the FREQ (Frequency) Field. The INCREMENT/SELECT Data Key or the DECREMENT/SELECT Data Key may be used to slew the data. The SELECT DATA UNITS MSB Key or the SELECT DATA UNITS LSB Key may be used to select the FREQ units to be slewed (i.e., 25 kHz, 100 kHz, etc.).
3.	DC POWER Connector Circular Type Connector (2.5 mm center, 5.5 mm outer diameter, center positive) used for battery charging or operation of Test Set.	12.	TONE Field Select Key This Key moves the edit cursor to the MOD TONE Field. The INCREMENT/SELECT Data Key or the DECREMENT/SELECT Data Key may be used to slew the data.
4.	RF I/O Connector TNC Type Connector used for direct connect to the UUT for power and frequency measurements for COMM testing, and for providing RF stimulus for VOR/ILS/GS/MB receivers.	13.	M MOD Field Select Key This Key moves the edit cursor to the M MOD (Master Modulation) Field and turns the modulation OFF (0%) or ON (CAL). The INCREMENT/SELECT Data Key or the DECREMENT/SELECT Data Key may be used to slew the modulation depth.
5.	ANT Connector BNC Type Connector used for over-the-air stimulus for VOR/ILS/GS/MB receivers and for COMM testing.	14.	SETUP Key This Key displays the SETUP Menu.
6.	REMOTE Connector DB15 Type Connector or DB25 Type Connector used for remote operation and software upgrades. Contains RS-232, USB Host and USB Peripheral connections.	15.	G/S DDM UP Key This Key slews the displayed Glideslope DDM Up. Increments are either FIXED or VAR (Variable) depending on the DDM DEV STEP Field setting.
7.	Display (LCD) 38 characters by 16 lines for main screen display with Soft Key boxes at the bottom of the screen.		
8.	Multi-Function Soft Keys Five Soft Keys are provided. The legends are displayed in boxes at the bottom of the Display.		
9.	MODE Select Key This Key enters the MODE Field and selects the operational mode (i.e., VOR, Localizer, etc.).		

ITEM	DESCRIPTION	ITEM	DESCRIPTION
16.	<p>LOC DDM LEFT Key</p> <p>This Key slews the displayed Localizer DDM to the Left.</p> <p>Increments are either FIXED or VAR (Variable) depending on the DDM DEV STEP Field setting.</p>	23.	<p>CONTRAST Key</p> <p>This Key displays/exits the Contrast Adjust Field.</p> <p>The INCREMENT/SELECT Data Key or the DECREMENT/SELECT Data Key may be used to adjust the Contrast.</p>
17.	<p>G/S DDM DOWN Key</p> <p>This Key slews the displayed Glideslope DDM Down.</p> <p>Increments are either FIXED or VAR (Variable) depending on the DDM DEV STEP Field setting.</p>	24.	<p>DECREMENT/SELECT Data Key</p> <p>This Key decrements data in slewable fields, such as FREQ. This Key also selects data in fields that have fixed functions, such as MOD TONE and MODE.</p>
18.	<p>LOC DDM RIGHT Key</p> <p>This Key slews the displayed Localizer DDM to the Right.</p> <p>Increments are either FIXED or VAR (Variable) depending on the DDM DEV STEP Field setting.</p>	25.	<p>SELECT DATA UNIT MSB Key</p> <p>This Key moves the slew cursor toward the MSB (Most Significant Bit) of the data field.</p> <p>Example: When a variable frequency is selected, the slew cursor can be moved from the 1 kHz unit to the 10 kHz unit.</p>
19.	<p>BACKLIGHT Key</p> <p>This Key displays/exits the Backlight Adjust Field.</p> <p>The INCREMENT/SELECT Data Key or the DECREMENT/SELECT Data Key may be used to adjust the Backlight Intensity.</p> <p>The IFR 4000 powers up with the Backlight set to the setting of the previous session.</p>	26.	<p>SELECT DATA UNIT LSB Key</p> <p>This Key moves the slew cursor toward the LSB (Least Significant Bit) of the data field.</p> <p>Example: When a variable frequency is selected, the slew cursor can be moved from the 10 kHz unit to the 1 kHz unit.</p>
20.	<p>POWER Key</p> <p>This Key powers the IFR 4000 up and down.</p>	27.	<p>INCREMENT/SELECT Data Key</p> <p>This Key increments data in slewable fields, such as FREQ. This Key also selects data in fields that have fixed functions, such as MOD TONE and MODE.</p>
21.	<p>POWER Indicator</p> <p>This Indicator is illuminated when the IFR 4000 is powered.</p>		
22.	<p>CHARGE Indicator</p> <p>This Indicator is illuminated when external DC power is applied for Bench Operation or Battery charging.</p> <p>This Indicator is yellow when the battery is charging, flashing yellow when the battery needs replacing and Green when the battery is fully charged.</p>		

3. PERFORMANCE EVALUATION

3.1 GENERAL

The IFR 4000 is equipped with a Self Test for quick performance evaluation. An abbreviated Self Test is run at Power-Up. The full Self Test is initiated manually.

Refer to 1-2-2, Figure 2 for location of controls, connectors and indicators.

3.2 SELF TEST

STEP	PROCEDURE
------	-----------

1. Press the SETUP Key to display the Setup Menu.

SETUP		BAT 1.2 Hr	
PORT: RF I/O	FREQ: PRESET		
AP SWP RATE: 20 sec	VOR BRG: FIXED		
EXT ATTN: 0.0 dB	PWR DWN: 10 mins		
ILS UNITS: DDM	RF LVL UNITS: dBm		
KEY CLICK: OFF	MORSE CODE: IFR		
AUDIO: OFF			
NEXT PARAM	GUIDED TEST	STORE/ RECALL	H/W TOOLS INFO

2. Press the H/W TOOLS Soft Key to display the Hardware Tools Screen.

HARDWARE TOOLS		BAT 1.2 Hr	
S/N 999999999			
MICRO VER 1.2			
MICRO OPT 1			
RS232	DIAGS	CAL	RETURN

STEP	PROCEDURE
------	-----------

3. Press the DIAGS Soft Key to display the Diagnostics Screen.

DIAGNOSTICS		BAT 1.2 Hr	
AMBIENT TEMPERATURE = 84 F 29 C			
RF BLOCK TEMPERATURE = 82 F 28 C			
SELF TEST			RETURN

4. Press the SELFTEST Soft Key to display the Self Test Screen.

SELF TEST		BAT 1.2 Hr	
RAM	----	Lock Det	----
Flash	----	Lvl Det	----
CPLD	----	SWR	----
NVRAM	----	Freq Ctr	----
FPGA	----	Localizer	----
USB	----	Marker	----
Keypad	----	Pwr Det	----
Battery	----	Ant Prot	----
Disconnect cables from ports before running self test			
RUN			RETURN

The Self Test cannot be performed until the IFR 4000 has finished the warm-up cycle. If the user attempts to initiate the Self Test before the IFR 4000 is ready, the following message is displayed:

**Instrument warming up
Please wait xx secs**

The message counts down to zero (0) then the Self Test can be initiated.

3.2 SELF TEST (cont)

STEP	PROCEDURE
------	-----------

5. Press the RUN Soft Key to initiate the Self Test.

SELF TEST		BAT 1.2 Hr	
RAM	PASS	Lock Det	----
Flash	PASS	Lvl Det	----
CPLD	PASS	SWR	----
NVRAM	TEST	Freq Ctr	----
FPGA	----	Localizer	----
USB	----	Marker	----
Keypad	----	Pwr Det	----
Battery	----	Ant Prot	----
Micro	----		
Self test running			
<div style="border: 1px solid black; display: inline-block; padding: 2px 10px;">ABORT</div>			

6. Verify all the modules/assemblies pass the Self Test.

- If the Self Test indicates a failure, refer to 1-2-3, Table 1 for probable sources of failure.

If the battery fails, refer to para 1-2-1.6 to charge the battery.

If any other failure occurs, refer the Test Set to a qualified service technician for maintenance.

TEST		PROBABLE SOURCE OF FAILURE
1	RAM	Processor PCB Assy
2	Flash	
3	CPLD	
4	NVRAM	
5	FPGA	Multi-Function PCB Assy
6	USB	
7	Keypad	
8	Battery	Battery Pack
9	Micro	RF Assy
10	Lock Detect	
11	Level Detect	
12	SWR	
13	Frequency Counter	
14	Localizer	
15	Marker	
16	Power Detector	
17	Antenna Protection	

Self Test Failures
Table 1

4. OPERATING PROCEDURES

4.1 GENERAL

The IFR 4000 verifies the operation and installation of ILS, VOR and Marker Beacon receivers, VHF AM/FM, UHF AM and HF AM/SSB Transceivers and with the ELT Option, 121.5/243 and 406 MHz Emergency Beacons.

This section contains operating instructions for the IFR 4000. Included is a description of the Operational Mode screens with Field definitions followed by general operating instructions. For specific Unit Under Test (UUT) Procedures, refer to the UUT Manual.

Refer to 1-2-2, Figure 2 for the location of the controls, connectors and indicators.

The IFR 4000 uses nine Main Operational Modes and one Optional Mode:

SETUP Mode allows the operator to set various parameters used in testing, configuration and memory storage. The Setup Menu can be entered from any mode by pressing the SETUP Key.

VOR Mode provides signal generation over the VOR band (108.00 to 117.95 MHz) with 30 Hz reference phase and 9960 Hz (sub carrier frequency modulated with 30 Hz variable phase) amplitude modulated at 30% per tone. VOR bearing selection is provided in preset steps of 30° or variable steps of 0.1°.

LOC (Localizer) Mode provides signal generation over the Localizer band of 108.10 to 111.95 MHz, 90 and 150 Hz, amplitude modulated at 20% per tone. Variable and fixed DDM control is provided.

G/S (Glideslope) Mode provides signal generation over the Glideslope band of 329.15 to 335.00 MHz, 90 Hz and 150 Hz, amplitude modulated at 40% per tone. Variable and fixed DDM control is provided.

MARKER BEACON Mode provides 75 MHz signal generation, amplitude modulated at 95% with selectable 400, 1300 and 3000 Hz tones.

ILS Mode provides simultaneous Localizer (with swept DDM), Glideslope and Marker Beacon signals.

COMM AM Mode provides signal generation over the Range of 10.00 to 400.00 MHz in 1 kHz increments and monitoring of transmitter power and modulation depth over the same range. A calibrated 1020 Hz tone, amplitude modulated at 30%, is also provided. Frequency control is provided in 8.33 kHz / 25 kHz channel steps or in 1 kHz variable steps. Audio output is available.

COMM FM Mode provides signal generation over the Range of 10.00 to 400.00 MHz in 1 kHz increments and monitoring of transmitter power and modulation deviation over the same range. A 1000 Hz tone, frequency modulated at 5 kHz, is also provided. Frequency control is provided in 12.5 kHz / 25 kHz channel steps or in 1 kHz variable steps. Audio output is available.

COMM SSB Mode provides signal generation and monitoring of transmitter power and modulation depth over the range of 10.00 to 30.00 MHz. A 1000 Hz tone is also provided. Audio output is available.

SWR Mode provides selected CW frequency SWR measurement or swept SWR measurement over a 10.00 to 400.00 MHz range.

SELCAL Mode provides selectable consecutive amplitude modulated tone pulse pairs, which may be sent continuously or as a burst.

FREQUENCY COUNTER Mode provides external frequency measurement over the RF I/O Connector and ANT Connector from 10 to 400 MHz and over the AUX I/O Connector from 1 to 10 MHz.

121.5/243 BCN Mode (p/o ELT Option) provides monitoring for 121.5/243 MHz swept tone short range Beacons and displays transmitter frequency, power and start/stop tone frequencies. Audio output is available.

4.1 GENERAL (cont)

406 BEACON Mode (p/o ELT Option) provides monitoring for 406 MHz COPAS/SARSAT Emergency Locator Transmitter (ELT), Emergency Position Indicating Radio Beacons (EPIRB and (Personal Locator) PLB Beacons. The Beacon utilizes BPSK data to transmit position information derived from a long range navigation system or GPS receiver. The Protocol management and data field decode is automatically handled by the IFR 4000.

4.2 SCREEN DESCRIPTIONS

4.2.1 Startup Screen



4.2.2 Setup Menu

SETUP	BAT 1.2 Hr			
PORT: RF I/O	FREQ: PRESET			
AP SWP RATE: 20 sec	VOR BRG: FIXED			
EXT ATTN: 0.0 dB	PWR DWN: 10 mins			
ILS UNITS: DDM	RF LVL UNITS: dBm			
KEY CLICK: OFF	MORSE CODE: IFR			
AUDIO: OFF				
NEXT PARAM	GUIDED TEST	STORE/ RECALL	H/W TOOLS	INFO

BAT

This Field displays the amount of run time available before the battery requires charging.

When the Test Set is connected to an external power source and the battery is charging, " --- " is displayed in the BAT Field.

PORT

This parameter selects which connector the Test Set generates and receives signals over:

RF I/O selects the RF I/O Connector.

ANT selects the ANT Connector.

FREQ

This parameter selects the type of generator frequency selection:

PRESET provides fixed selectable channels for each Mode.

CHANNEL allows the selection of any on-channel frequency with the Mode band.

VAR allows the selection of frequency in 1 kHz steps (100 Hz steps in SSB Mode), within the Mode band.

AP SWP RATE

This parameter allows the Localizer DDM sweep rate to be set from 5 to 40 sec in 5 sec increments.

VOR BRG

This parameter selects the VOR Bearing units:

FIXED allows the selection of bearing in 30° increments (from 0°).

VAR allows the selection of bearing in 0.1° steps.

EXT ATTN

This parameter allows for compensation (0.0 to 22.0 dB) of an External Attenuator on the RF I/O Connector. This facility is used for extending the power monitor rating and range.

If the External Attenuator is selected, the value is displayed on all Mode Screens in the EXT ATTN Field under the RF LVL Field.

PWR DWN

This parameter sets the time (5 to 20 minutes or OFF) that the Test Set operates on the battery before powering the Test Set down. The time is effective from the last Key press.

The PWR DWN time set is not applicable when the Test Set is connected to an external power source.

ILS UNITS

This parameter determines the Localizer and Glideslope deviation units: DDM (Difference in Depth of Modulation) or μ A (Microamps).

RF LVL UNITS

This parameter sets the RF Level units to dBm or V (Volts into 50 Ω).

KEY CLICK

This parameter turns the audible Key click OFF or ON.

MORSE CODE

This parameter selects the Morse Code letters (1 to 4) transmitted in the VOR and ILS Localizer Mode.

AUDIO

This parameter selects if Audio Output is available at the AUX I/O Connector in the COMM AM, COMM FM, COMM SSB and 121.5/243 BEACON Modes.

4.2.2 Setup Menu (cont)

SOFT KEYS

The **NEXT PARAM** Soft Key moves the cursor to the next Field (to the right) on the Setup Menu.

The **GUIDED TEST** Soft Key displays the Guided Test Screen (para 1-2-4.2.3).

The **STORE/RECALL** Soft Key displays the Store/Recall Screen (para 1-2-4.2.4).

The **H/W TOOLS** Soft Key displays the Hardware Tools Screen (para 1-2-4.2.5).

The **INFO** Soft Key displays the Info Screen (para 1-2-4.2.10).

4.2.3 GUIDED TEST Screens

The IFR 4000 provides a Guided Test function which allows instrument setups to be stored in the Test Set non-volatile memory as a sequence, under a user specified name. The sequence may be recalled and played backwards or forwards. This feature allows a specific test schedule to be followed with the minimum of user intervention. 12 sequences may be stored, with a maximum of 50 steps per sequence.

4.2.3.1 GUIDED TEST Screen

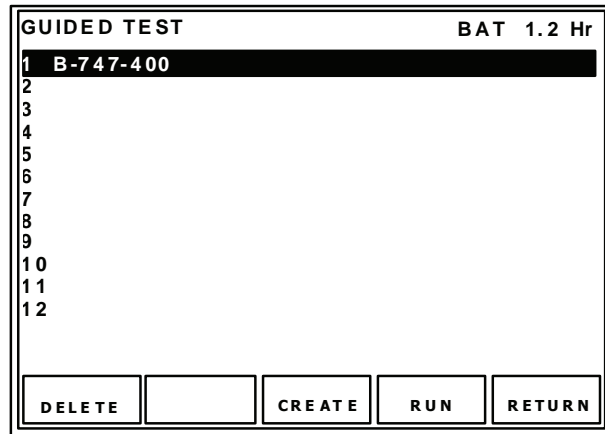

SOFT KEYS

The **DELETE** Soft Key displays the Password Screen and, if the Password is currently entered, the Delete Store Screen.

The **CREATE** Soft Key displays the Password Screen (para 1-2-4.2.3.2) and, if Password is correctly entered, the Store Name Screen (para 1-2-4.2.3.3).

The **RUN** Soft Key initiates the selected test.

The **RETURN** Soft Key displays the Setup Menu (para 1-2-4.2.2).

4.2.3 GUIDED TEST Screens (cont)

4.2.3.2 Password Screen

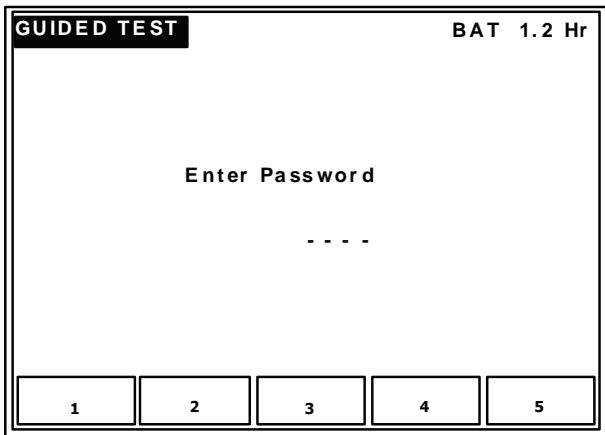

SOFT KEYS

- The **1** Soft Key places a **1** on the Password line.
- The **2** Soft Key places a **2** on the Password line.
- The **3** Soft Key places a **3** on the Password line.
- The **4** Soft Key places a **4** on the Password line.
- The **5** Soft Key places a **5** on the Password line.

4.2.3.3 Delete Store Screen



SOFT KEYS

- The **YES** Soft Key deletes the stored sequence.
- The **NO** Soft Key ignores the sequence deletion and displays the Guided Test Screen.

4.2.3 GUIDED TEST Screens (cont)

4.2.3.4 STORE NAME Screen

STORE NAME		BAT 1.2 Hr	
ABCDEFGHIJKLMNOPQRSTUVWXYZ abcdefghijklmnopqrstuvwxyz 0 1 2 3 4 5 6 7 8 9 ! " () * , - . / : ; ? @ _			
Please enter store name			
SEL LINE	SELECT	DELETE	DONE CANCEL

SOFT KEYS

The **SEL LINE** Soft Key moves the cursor down one line. When the cursor is on the bottom line, pressing the SEL LINE Soft Key moves the cursor to the top line.

The **SELECT** Soft Key places the character highlighted by the cursor on the name line.

The **DELETE** Soft Key deletes the right-most character on the name line.

The **CANCEL** Soft Key cancels the Store Name application.

The **DONE** Soft Key stores the name on the line selected on the Store/Recall Screen.

4.2.4 STORE/RECALL Screens

The Store/Recall Screens allow the factory preset configuration to be restored plus 11 user-definable configurations to be stored and recalled. Appendix C contains the Factory Presets for the "1. Preset Settings" selection on the Store/Recall Screen. All menu/screen fields shown in Appendix C can be utilized in the creation of a user configuration selection.

4.2.4.1 STORE/RECALL Screen

STORE/RECALL		BAT 1.2 Hr	
1	PRESET SETTINGS		
2	ILS TRI-MODE		
3			
4			
5			
6			
7			
8			
9			
10			
11			
12			
PREV	NEXT	STORE	RECALL RETURN

SOFT KEYS

The **PREV** Soft Key moves the cursor up one line.

The **NEXT** Soft Key moves the cursor down one line.

The **STORE** Soft Key displays the Store Name Screen (para 1-2-4.2.4.2).

The **RECALL** Soft Key recalls the settings for the line highlighted by the cursor.

The **RETURN** Soft Key displays the Setup Menu (para 1-2-4.2.2).

4.2.4 STORE/RECALL Screens (cont)

4.2.4.2 STORE NAME Screen

STORE NAME		BAT 1.2 Hr	
ABCDEFGHIJKLMNOPQRSTUVWXYZ abcdefghijklmnopqrstuvwxyz 0123456789!"'()* * , - . / : ; ? @ _			
Please enter store name			
SEL LINE	SELECT	DELETE	CANCEL

SOFT KEYS

The **SEL LINE** Soft Key moves the cursor down one line. When the cursor is on the bottom line, pressing the SEL LINE Soft Key moves the cursor to the top line.

The **SELECT** Soft Key places the character highlighted by the cursor on the name line.

The **DELETE** Soft Key deletes the right-most character on the name line.

The **CANCEL** Soft Key cancels the Store Name application.

The **DONE** Soft Key stores the name on the line selected on the Store/Recall Screen.

4.2.5 Hardware Tools Screen

The Unit Serial Number and the Microprocessor Version Number (only if the ELT Option is installed) are displayed on the Hardware Tools Screen.

HARDWARE TOOLS		BAT 1.2 Hr	
S/N 999999999			
MICRO VER 1.2			
MICRO OPT 1			
RS232	DIAGS	CAL	RETURN

BAT

This Field displays the amount of run time available before the battery requires charging.

When the Test Set is connected to an external power source and the battery is charging, " --- " is displayed in the BAT Field.

SOFT KEYS

The **RS-232** Soft Key displays the RS-232 Settings Screen (para 1-2-4.2.6).

The **DIAGS** Soft Key displays the Diagnostics Screen (para 1-2-4.2.7).

The **CAL** Soft Key displays the Calibration Screen (para 1-2-4.2.9).

The **RETURN** Soft Key displays the Setup Menu (para 1-2-4.2.2).

4.2.6 RS-232 Settings Screen

RS-232 SETTINGS		BAT 1.2 Hr	
BAUD RATE: 115200	DATA BITS=8		
PARITY=NONE	STOP BITS=1		
FLOW CONTROL: XON/XOFF			
NEXT PARAM		RETURN	

BAT

This Field displays the amount of run time available before the battery requires charging.

When the Test Set is connected to an external power source and the battery is charging, " --- " is displayed in the BAT Field.

BAUD RATE

Using the INCREMENT/SELECT Data Key or the DECREMENT/SELECT Data Key, set the Baud Rate to 9600, 19200, 38400, 57600 or 115200.

DATA BITS

This field displayed a fixed value (8) for the Data Bits.

PARITY

This field displayed a fixed value (NONE) for the Parity.

STOP BITS

This field displayed a fixed value (1) for the Stop Bits.

FLOW CONTROL

Using the INCREMENT/SELECT Data Key or the DECREMENT/SELECT Data Key, set the Flow Control to XON/XOFF, HARDWARE (RTS/CTS) or NONE.

SOFT KEYS

The **NEXT PARAM** Soft Key moves the cursor to the next Field (to the right) on the RS-232 Settings Screen.

The **RETURN** Soft Key displays the Hardware Tools Screen (para 1-2-4.2.5).

4.2.7 Diagnostics Screen

DIAGNOSTICS		BAT 1.2 Hr	
AMBIENT TEMPERATURE	=	84 F	29 C
RF BLOCK TEMPERATURE	=	82 F	28 C
SELF TEST		RETURN	

BAT

This Field displays the amount of run time available before the battery requires charging.

When the Test Set is connected to an external power source and the battery is charging, " --- " is displayed in the BAT Field.

AMBIENT TEMPERATURE

This Field displays the internal temperature of the Test Set.

RF BLOCK TEMPERATURE

This Field displays the temperature of the internal RF I/O Attenuator. An Overheat Screen appears if the temperature of the RF I/O Attenuator reaches 71°C.

OVERHEAT		BAT 1.2 Hr	
*** RF HARDWARE TOO HOT ***			
Remove power from input to prevent damage to instrument			
AUDIO OFF			

The Overheat Screen is displayed until the temperature of the RF I/O Attenuator is <70°C.

4.2.7 Diagnostics Screen (cont)

SOFT KEYS

The **SELF TEST** Soft Key displays the Self Test Screen (para 1-2-4.2.8).

The **RETURN** Soft Key displays the Hardware Tools Screen (para 1-2-4.2.5).

The **AUDIO OFF** Soft Key (on the Overheat Screen) switches the Audio Warning OFF.

4.2.8 Self Test Screen

SELF TEST		BAT 1.2 Hr	
RAM	----	Lock Det	----
Flash	----	Lvl Det	----
CPLD	----	SWR	----
NVRAM	----	Freq Ctr	----
FPGA	----	Localizer	----
USB	----	Marker	----
Keypad	----	Pwr Det	----
Battery	----	Ant Prot	----
Micro	----		
Disconnect cables from ports before running self test			
RUN		RETURN	

BAT

This Field displays the amount of run time available before the battery requires charging.

When the Test Set is connected to an external power source and the battery is charging, " --- " is displayed in the BAT Field.

SOFT KEYS

The **RUN** Soft Key starts the Self Test.

The **ABORT** Soft Key stops the Self Test.

The **RETURN** Soft Key displays the Diagnostics Screen (para 1-2-4.2.7).

4.2.9 Calibration Screen

The Calibration Screen is password protected. The Calibration Screen is for Qualified Service Personnel only.

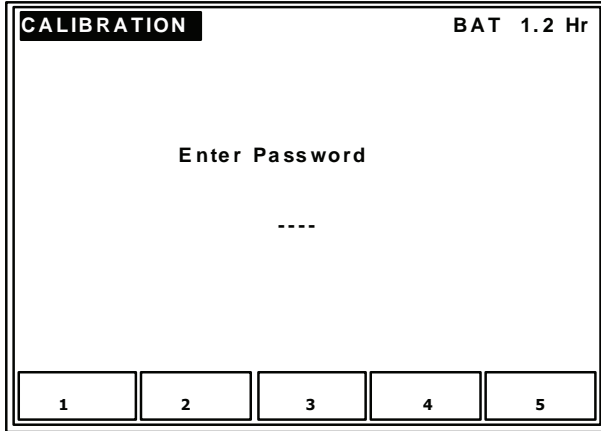

BAT

This Field displays the amount of run time available before the battery requires charging.

When the Test Set is connected to an external power source and the battery is charging, " --- " is displayed in the BAT Field.

SOFT KEYS

The **1** Soft Key places a **1** on the Password line.

The **2** Soft Key places a **2** on the Password line.

The **3** Soft Key places a **3** on the Password line.

The **4** Soft Key places a **4** on the Password line.

The **5** Soft Key places a **5** on the Password line.

4.2.10 Info Screen

The Software/Firmware Version numbers and Options available are displayed on the Info Screen.

This screen is a sample of the screen that appears.

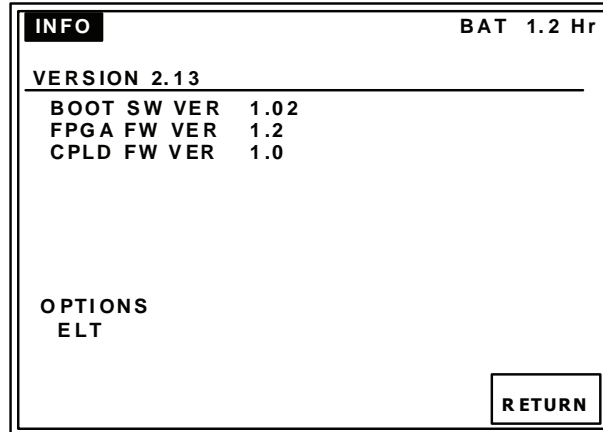

SOFT KEYS

The **RETURN** Soft Key displays the Setup Menu (para 1-2-4-2-2).

4.2.11 VOR Mode Screen

VOR	RF I/O	BAT 1.2 Hr		
FREQ: 108.000 MHz	RF LVL: - 50.0 dBm			
M MOD: CAL (60%)	MOD TONE: OFF			
BRG: 0.0 deg 30 Hz MOD: 30%	TO/FROM: TO 9960 Hz MOD: 30%			
TONE DEL: -				
30 MOD	9960 MOD	TONE DEL	BRG	TO / FROM

PORT

This Field, at the top of the screen, displays the Port (RF I/O or ANT) selected in the Setup Menu.

BAT

This Field displays the amount of run time available before the battery requires charging.

When the Test Set is connected to an external power source and the battery is charging, --- is displayed in the BAT Field.

FREQ

This Field controls the signal generator frequency. Operation of this Field depends upon the settings of the FREQ Field in the Setup Menu.

PRESET provides three fixed selectable channels for each Mode: 108.00 MHz, 108.05 MHz and 117.95 MHz. Preset is used for quick confidence testing.

CHANNEL allows the selection of any on-channel frequency with the Mode band. Channel is used for testing of any 50 kHz spaced channel from 108.00 to 117.95 MHz.

VAR allows the selection of the frequency from 107.00 to 118.00 MHz in 1 kHz increments to perform receiver bandwidth and adjacent channel tests.

The INCREMENT/SELECT Data Key or the DECREMENT/SELECT Data Key may be used to slew the data. The SELECT DATA UNITS MSB Key or the SELECT DATA UNITS LSB Key may be used to select the FREQ units to be slewed (i.e., 50 kHz, 100 kHz, etc.).

RF LVL

This Field controls the signal generator RF output level. Operation of this Field depends upon the settings of the RF LVL UNITS Field in the Setup Menu.

RF Level units are displayed in dBm or $\mu\text{V}/\text{mV}$.

The INCREMENT/SELECT Data Key or the DECREMENT/SELECT Data Key may be used to slew the data. The SELECT DATA UNITS MSB Key or the SELECT DATA UNITS LSB Key may be used to select the RF LVL units to be slewed. The RF LVL is slewed in 0.1, 1.0 or 10 dB increments when the RF LVL Field is set to either dBm or $\mu\text{V}/\text{mV}$.

M MOD

This Field controls the signal generator Master Modulation Depth. The Master Modulation control functions as a multiplier of the individual modulation components. The Master Modulation Depth is the sum of the Depths of Modulation (SDM) of the individual tone components. Using the INCREMENT/ SELECT Data Key or the DECREMENT/ SELECT Data Key, modulation is set from 0% to 165% in increment steps equal to the sum of the individual tone components (i.e., if two tones of equal modulation depth are enabled, the M MOD Field increments in 2% steps). The algebraic sum of the individual components can be >100%. For settings >100%, this produces a distorted waveform. The accuracy in this situation is unspecified. Press the M MOD Key to toggle the modulation setting between 0% and CAL (60%).

4.2.11 VOR Mode Screen (cont)

MOD TONE

This Field controls the selection of a 1020 Hz Station Ident Tone or the Morse Code. Press the TONE Key to toggle the Field between OFF, 1020 Hz or MORSE. The Morse Code is set in the Setup Menu.

BRG

This Field controls the VOR Bearing. The operation of this Field depends upon the settings of the VOR BRG Field in the Setup Menu.

FIXED allows the selection of bearing in 30° steps (from 0°).

VAR allows the selection of bearing in 0.1° steps.

The INCREMENT/SELECT Data Key or the DECREMENT/SELECT Data Key may be used to slew the data. The SELECT DATA UNITS MSB Key or the SELECT DATA UNITS LSB Key may be used to select the FREQ units to be slewed (i.e., 0.1°, 1°, etc.)

TO/FROM

This Field controls the selection of the TO/FROM function:

TO sets the Bearing towards the VOR Beacon.

FROM sets the Bearing away from the VOR Beacon.

Press the TO/FROM Soft Key to toggle between TO and FROM.

30 Hz MOD

This Field controls the selection of the 30 Hz Variable Phase modulation depth.

Using the INCREMENT/SELECT Data Key or the DECREMENT/SELECT Data Key, modulation is set from 0% to 30% in 1% increments.

9960 Hz MOD

This Field controls the selection of the 9960 Hz sub-carrier modulation depth.

Using the INCREMENT/SELECT Data Key or the DECREMENT/SELECT Data Key, modulation is set from 0% to 30% in 1% increments with MMOD in CAL Mode or from 0% to 55% in 1% increments when MMOD is out of CAL.

TONE DEL

This Field allows either the 30 Hz Variable, 30 Hz Reference or both tones to be deleted.

Press the TONE DEL Soft Key to toggle between OFF, REF, REF&VAR or VAR.

SOFT KEYS

The **30 MOD** Soft Key moves the cursor to the 30 Hz MOD Field.

The **9960 MOD** Soft Key moves the cursor to the 9960 Hz MOD Field.

The **TONE DEL** Soft Key moves the cursor to the TONE DEL Field. Additional key presses are used to select between - (OFF), REF, REF&VAR and VAR.

The **BRG** Soft Key moves the cursor to the BRG Field. Each additional key press adds 30° to the Field value.

The **TO/FROM** Soft Key moves the cursor to the TO/FROM Field. Each additional key press toggles the Field between TO and FROM.

4.2.12 LOCALIZER Mode Screen

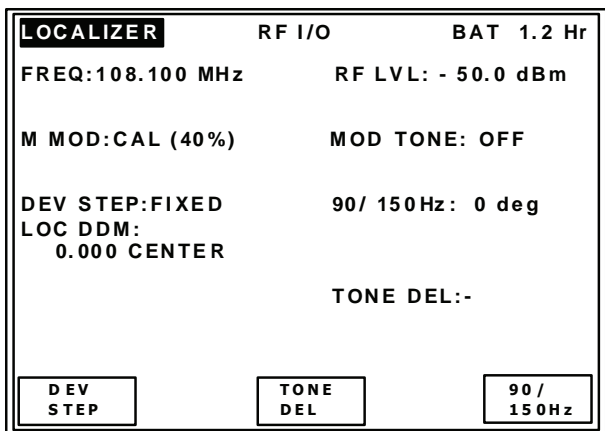

PORT

This Field, at the top of the screen, displays the Port (RF I/O or ANT) selected in the Setup Menu.

BAT

This Field displays the amount of run time available before the battery requires charging.

When the Test Set is connected to an external power source and the battery is charging, " --- " is displayed in the BAT Field.

FREQ

This Field controls the signal generator frequency. Operation of this Field depends upon the settings of the FREQ Field in the Setup Menu.

PRESET provides three fixed selectable channels for each Mode: 108.10 MHz, 108.15 MHz and 110.15 MHz. Preset is used for quick confidence testing.

CHANNEL allows the selection of any on-channel frequency with the Mode band. Channel is used for testing of any 50 kHz spaced channel from 108.10 to 111.95 MHz.

VAR allows the selection of the frequency from 107.00 to 113.00 MHz in 1 kHz increments to perform receiver bandwidth and adjacent channel tests.

The INCREMENT/SELECT Data Key or the DECREMENT/SELECT Data Key may be used to slew the data. The SELECT DATA UNITS MSB Key or the SELECT DATA UNITS LSB Key may be used to select the FREQ units to be slewed (i.e., 50 kHz, 100 kHz, etc.).

RF LVL

This Field controls the signal generator RF output level. Operation of this Field depends upon the settings of the RF LVL UNITS Field in the Setup Menu.

RF Level units are displayed in dBm or $\mu\text{V}/\text{mV}$.

The INCREMENT/SELECT Data Key or the DECREMENT/SELECT Data Key may be used to slew the data. The SELECT DATA UNITS MSB Key or the SELECT DATA UNITS LSB Key may be used to select the RF LVL units to be slewed. The RF LVL is slewed in 0.1, 1.0 or 10 dB increments when the RF LVL Field is set to either dBm or $\mu\text{V}/\text{mV}$.

M MOD

This Field controls the signal generator Master Modulation Depth. The Master Modulation control functions as a multiplier of the individual modulation components. The Master Modulation Depth is the sum of the Depths of Modulation (SDM) of the individual tone components. Using the INCREMENT/ SELECT Data Key or the DECREMENT/ SELECT Data Key, modulation is set from 0% to 98% in increment steps equal to the sum of the individual tone components (i.e., if two tones of equal modulation depth are enabled, the M MOD Field increments in 2% steps). Press the M MOD Key to toggle the modulation setting between 0% and CAL (40%).

MOD TONE

This Field controls the selection of a 1020 Hz Station Ident Tone or the Morse Code. Press the TONE Key to toggle the Field between OFF, 1020 Hz or MORSE. The Morse Code is set in the Setup Menu.

4.2.12 LOCALIZER Mode Screen (cont)

DEV STEP

This Field controls the Deviation Step size. The operation of this Field depends upon the settings of the ILS UNITS Field in the Setup Menu. ILS UNITS may be set to DDM (Double Depth Modulation) or μ A (Microamps).

DDM

FIXED provides CENTER, LEFT and RIGHT deviation selections at 0.00, 0.093, 0.155 and 0.200 DDM.

VAR provides CENTER, LEFT and RIGHT deviation selections from 0 to 0.4 DDM in 0.001 DDM steps. UNCAL is displayed when set to VAR and the LOC DDM Field is in a Non-Zero position or when the M MOD Field is not set to CAL and the LOC DDM Field is in a Non-Zero position.

μ A

FIXED provides CENTER, LEFT and RIGHT deviation selections at 0, 90, 150 and 194 μ A.

VAR provides CENTER, LEFT and RIGHT deviation selections from 0 to 388 μ A in 1 μ A steps. UNCAL is displayed when set to VAR and the LOC DDM Field is in a Non-Zero position or when the M MOD Field is not set to CAL and the LOC DDM Field is in a Non-Zero position.

90/150 Hz

This Field controls the phase shift between the 90 and 150 Hz tones.

Use the 90/150Hz Soft Key, INCREMENT/SELECT DATA Key and DECREMENT/SELECT DATA Key to set the phase shift from 0° to 120° in 5° steps.

Press the 90/150Hz Soft Key to toggle between no phase shift and the selected phase shift.

This feature is used to simulate the phase shift between the 90 and 150 Hz tones that occurs, when an aircraft is turning to capture the Localizer beam.

TONE DEL

This Field allows either the 90 Hz, 150 Hz or both tones to be deleted. Press the TONE DEL Soft Key to toggle between OFF, 90, 150 or 90 & 150.

This feature is used to verify CDI (Course Deviation Indicator) NAV flag operation under invalid signal conditions.

SOFT KEYS

The **DEV STEP** Soft Key moves the cursor to the DEV STEP Field. Each additional key press toggles the Field between FIXED and VAR.

The **TONE DEL** Soft Key moves the cursor to the TONE DEL Field. Additional key presses are used to select between - (OFF), 90, 90 & 150 and 150.

The **90/150 Hz** Soft Key moves the cursor to the 90/150 Hz Field. Each additional key press toggles the Field between - (OFF) and 0 deg.

4.2.13 GLIDESLOPE Mode Screen

GLIDE SLOPE	RF I/O	BAT 1.2 Hr
FREQ: 334.700 MHz	RF LVL: - 50.0 dBm	
LOC FREQ: 108.100 MHz		
M MOD: CAL (80%)		
DEV STEP: FIXED	90 / 150Hz:-	
	G/S DDM:	
	0.091 DOWN	
	TONE DEL:-	
DEV STEP	TONE DEL	90 / 150Hz

PORT

This Field, at the top of the screen, displays the Port (RF I/O or ANT) selected in the Setup Menu.

BAT

This Field displays the amount of run time available before the battery requires charging.

When the Test Set is connected to an external power source and the battery is charging, " --- " is displayed in the BAT Field.

FREQ

This Field controls the signal generator frequency. Operation of this Field depends upon the settings of the FREQ Field in the Setup Menu.

PRESET provides three fixed selectable channels for each Mode: 334.25 MHz, 334.55 MHz and 334.70 MHz. Preset is used for quick confidence testing.

CHANNEL allows the selection of any on-channel frequency with the Mode band. Channel is used for testing of any 50 kHz spaced channel from 329.15 to 335.00 MHz.

VAR allows the selection of the frequency from 327.00 to 337.00 MHz in 1 kHz increments to perform receiver bandwidth and adjacent channel tests.

The INCREMENT/SELECT Data Key or the DECREMENT/SELECT Data Key may be used to slew the data. The SELECT DATA UNITS MSB Key or the SELECT DATA UNITS LSB Key may be used to select the FREQ units to be slewed (i.e., 50 kHz, 100 kHz, etc.).

RF LVL

This Field controls the signal generator RF output level. Operation of this Field depends upon the settings of the RF LVL UNITS Field in the Setup Menu.

RF Level units are displayed in dBm or $\mu\text{V}/\text{mV}$.

The INCREMENT/SELECT Data Key or the DECREMENT/SELECT Data Key may be used to slew the data. The SELECT DATA UNITS MSB Key or the SELECT DATA UNITS LSB Key may be used to select the RF LVL units to be slewed. The RF LVL is slewed in 0.1, 1.0 or 10 dB increments when the RF LVL Field is set to either dBm or $\mu\text{V}/\text{mV}$.

M MOD

This Field controls the signal generator Master Modulation Depth. The Master Modulation control functions as a multiplier of the individual modulation components. The Master Modulation Depth is the sum of the Depths of Modulation (SDM) of the individual tone components. Using the INCREMENT/ SELECT Data Key or the DECREMENT/ SELECT Data Key, modulation is set from 0% to 100% in increment steps equal to the sum of the individual tone components (i.e., if two tones of equal modulation depth are enabled, the M MOD Field increments in 2% steps). Press the M MOD Key to toggle the modulation setting between 0% and CAL (80%).

4.2.13 GLIDESLOPE Mode Screen (cont)

DEV STEP

This Field controls the Deviation Step size. The operation of this Field depends upon the settings of the ILS UNITS Field in the Setup Menu. ILS UNITS may be set to DDM (Double Depth Modulation) or μ A (Microamps).

DDM

FIXED provides CENTER, LEFT and RIGHT deviation selections at 0.00, 0.091, 0.175 and 0.400 DDM.

VAR provides CENTER, LEFT and RIGHT deviation selections from 0 to 0.8 DDM in 0.001 DDM steps. UNCAL is displayed when set to VAR and the LOC DDM Field is in a Non-Zero position or when the M MOD Field is not set to CAL and the LOC DDM Field is in a Non-Zero position.

μ A

FIXED provides CENTER, LEFT and RIGHT deviation selections at 0, 78, 150 and 343 μ A.

VAR provides CENTER, LEFT and RIGHT deviation selections from 0 to 686 μ A in 1 μ A steps. UNCAL is displayed when set to VAR and the LOC DDM Field is in a Non-Zero position or when the M MOD Field is not set to CAL and the LOC DDM Field is in a Non-Zero position.

90/150 Hz

This Field controls the phase shift between the 90 and 150 Hz tones.

Use the 90/150Hz Soft Key, INCREMENT/SELECT DATA Key and DECREMENT/SELECT DATA Key to set the phase shift from 0° to 120° in 5° steps.

Press the 90/150Hz Soft Key to toggle between no phase shift and the selected phase shift.

TONE DEL

This Field allows either the 90 Hz, 150 Hz or both tones to be deleted. Press the TONE DEL Soft Key to toggle between OFF, 90, 150 or 90 & 150.

This feature is used to verify CDI (Course Deviation Indicator) NAV flag operation under invalid signal conditions.

SOFT KEYS

The **DEV STEP** Soft Key moves the cursor to the DEV STEP Field. Each additional key press toggles the Field between FIXED and VAR.

The **TONE DEL** Soft Key moves the cursor to the TONE DEL Field. Additional key presses are used to select between - (OFF), 90, 90 & 150 and 150.

The **90/150 Hz** Soft Key moves the cursor to the 90/150 Hz Field. Each additional key press toggles the Field between - (OFF) and 0 deg.

4.2.14 MARKER BEACON Mode Screen

MARKER BEACON	RF I/O	BAT 1.2 Hr
FREQ: 75.000 MHz	RF LVL: - 50.0 dBm	
M MOD: CAL (0%)	MOD TONE: OFF	

PORT

This Field, at the top of the screen, displays the Port (RF I/O or ANT) selected in the Setup Menu.

BAT

This Field displays the amount of run time available before the battery requires charging.

When the Test Set is connected to an external power source and the battery is charging, " --- " is displayed in the BAT Field.

FREQ

This Field controls the signal generator frequency. Operation of this Field depends upon the settings of the FREQ Field in the Setup Menu.

PRESET provides three fixed selectable channels for each Mode: 74.50 MHz, 75.00 MHz and 75.50 MHz. Preset is used for quick confidence testing.

CHANNEL allows the selection of any on-channel frequency with the Mode band. Channel is used for testing of any 25 kHz spaced channel from 72.00 to 78.00 MHz.

VAR allows the selection of the frequency from 72.00 MHz to 78.00 MHz in 1 kHz increments to perform receiver bandwidth tests.

The INCREMENT/SELECT Data Key or the DECREMENT/SELECT Data Key may be used to slew the data. The SELECT DATA UNITS MSB Key or the SELECT DATA UNITS LSB Key may be used to select the FREQ units to be slewed (i.e., 1 kHz, 10 kHz, etc.).

RF LVL

This Field controls the signal generator RF output level. Operation of this Field depends upon the settings of the RF LVL UNITS Field in the Setup Menu.

RF Level units are displayed in dBm or $\mu\text{V}/\text{mV}$.

The INCREMENT/SELECT Data Key or the DECREMENT/SELECT Data Key may be used to slew the data. The SELECT DATA UNITS MSB Key or the SELECT DATA UNITS LSB Key may be used to select the RF LVL units to be slewed. The RF LVL is slewed in 0.1, 1.0 or 10 dB increments when the RF LVL Field is set to either dBm or $\mu\text{V}/\text{mV}$.

M MOD

This Field controls the signal generator Master Modulation Depth. Using the INCREMENT/SELECT Data Key or the DECREMENT/SELECT Data Key, modulation is set from 0% to 95% in 1% increments. Press the M MOD Key to toggle the modulation setting between 0% to CAL(95%) when MOD TONE is ON or between 0% to CAL(0%) when MOD TONE is OFF.

MOD TONE

This Field controls the selection of the Inner, Middle and Outer Marker Beacon Tones. Press the TONE Key to toggle between OFF, 400 Hz, 1300 Hz and 3000 Hz.

4.2.15 ILS Mode Screen

ILS	RF I/O	BAT 1.2 Hr
FREQ: 108.100 MHz	RF LVL: - 50.0 dBm	
G/S FREQ: 334.700 MHz		
M MOD: CAL (80%)	MOD TONE: OFF	
AP SWP: OFF		
DEV STEP: FIXED	90/150 Hz: 0 deg	
LOC DDM: 0.000 CENTER	G/S DDM: 0.000 CENTER	
	TONE DEL:-	
DEV STEP	AP SWP	TONE DEL
		90 / 150Hz

PORT

This Field, at the top of the screen, displays the Port (RF I/O or ANT) selected in the Setup Menu.

BAT

This Field displays the amount of run time available before the battery requires charging.

When the Test Set is connected to an external power source and the battery is charging, " --- " is displayed in the BAT Field.

FREQ (Localizer)

This Field controls the signal generator frequency. Operation of this Field depends upon the settings of the FREQ Field in the Setup Menu.

The Localizer and Glideslope frequency selections are paired; a change to the FREQ (Localizer) selection selects the paired G/S FREQ.

PRESET provides three fixed selectable channels for each Mode: 108.10 MHz, 108.15 MHz and 110.95 MHz. Preset is used for quick confidence testing.

CHANNEL allows the selection of any on-channel frequency with the Mode band. Channel is used for testing of any 50 kHz spaced channel from 108.10 to 117.95 MHz.

VAR operates the same as CHANNEL due to the pairing of Localizer and Glideslope frequencies.

The INCREMENT/SELECT Data Key or the DECREMENT/SELECT Data Key may be used to slew the data. The SELECT DATA UNITS MSB Key or the SELECT DATA UNITS LSB Key may be used to select the FREQ units to be slewed (i.e., 50 kHz, 100 kHz, etc.).

G/S FREQ

This Field controls the Glideslope signal generator frequency. Operation of this Field depends upon the settings of the FREQ Field in the Setup Menu.

The Localizer and Glideslope frequency selections are paired; a change to the G/S FREQ selection selects the paired FREQ (Localizer).

PRESET provides three fixed selectable channels for each Mode: 334.25 MHz, 334.55 MHz and 334.70 MHz. Preset is used for quick confidence testing.

CHANNEL allows the selection of any on-channel frequency with the Mode band. Channel is used for testing of any 50 kHz spaced channel from 329.15 to 335.00 MHz.

VAR operates the same as CHANNEL due to the pairing of Localizer and Glideslope frequencies.

The INCREMENT/SELECT Data Key or the DECREMENT/SELECT Data Key may be used to slew the data. The SELECT DATA UNITS MSB Key or the SELECT DATA UNITS LSB Key may be used to select the FREQ units to be slewed (i.e., 50 kHz, 100 kHz, etc.).

RF LVL

This Field controls the signal generator RF output level for the Glideslope signal. Operation of this Field depends upon the settings of the RF LVL UNITS Field in the Setup Menu.

RF Level units are displayed in dBm or $\mu\text{V}/\text{mV}$.

The INCREMENT/SELECT Data Key or the DECREMENT/SELECT Data Key may be used to slew the data. The SELECT DATA UNITS MSB Key or the SELECT DATA UNITS LSB Key may be used to select the RF LVL units to be slewed (i.e., 0.1 dBm, 1 dBm, etc.).

4.2.15 ILS Mode Screen (cont)

M MOD

This Field controls the signal generator Master Modulation Depth for the G/S Signal. The Master Modulation control functions as a multiplier of the individual modulation components. The Master Modulation Depth is the sum of the Depths of Modulation (SDM) of the individual tone components. Using the INCREMENT/ SELECT Data Key or the DECREMENT/ SELECT Data Key, modulation is set from 0% to 80% in increment steps equal to the sum of the individual tone components (i.e., if two tones of equal modulation depth are enabled, the M MOD Field increments in 2% steps). The sum of the depths of modulation for the Localizer Signal is fixed at 40 plus any selected tones. Press the M MOD Key to toggle the modulation setting between 0% and CAL(80%).

MOD TONE

This Field controls the selection of a 1020 Hz Station Ident Tone or the Inner, Middle and Outer Marker Beacon Tones.

Press the TONE Key to toggle the Field between OFF, 1020 Hz, MORSE, 400 Hz, 1300 Hz and 3000 Hz.

The 1020 Hz Station Ident Tone is available only on the Localizer signal.

All Tones are available for the ANT Connector. Only 1020 Hz, MORSE and OFF are available for the RF I/O Connector.

The MORSE Code letters are set in the Setup Menu.

When any of the Marker Beacon tones (400 Hz, 1300 Hz and 3000 Hz) are selected, "Marker On" is displayed under the MOD TONE Field.

DEV STEP

This Field controls the Deviation Step size. The operation of this Field depends upon the settings of the ILS UNITS Field in the Setup Menu. ILS UNITS may be set to DDM (Double Depth Modulation) or μ A (Microamps).

Localizer DDM

FIXED provides CENTER, LEFT and RIGHT deviation selections at 0.00, 0.093, 0.155 and 0.200 DDM.

VAR provides CENTER, LEFT and RIGHT deviation selections from 0 to 0.4 DDM in 0.001 DDM steps.

Localizer μ A

FIXED provides CENTER, LEFT and RIGHT deviation selections at 0, 90, 150 and 194 μ A.

VAR provides CENTER, LEFT and RIGHT deviation selections from 0 to 388 μ A in 1 μ A steps. UNCAL is displayed when set to VAR and the LOC DDM Field is in a Non-Zero position or when the M MOD Field is not set to CAL and the LOC DDM Field is in a Non-Zero position.

Glideslope DDM

FIXED provides CENTER, UP & DOWN deviation selections at 0.00, 0.091, 0.175 and 0.400 DDM.

VAR provides CENTER, UP & DOWN deviation selections from 0 to 0.8 DDM in 0.001 DDM steps.

NOTE: Localizer Deviation is automatically set to μ A when Autopilot sweep is selected.

Glideslope μ A

FIXED provides CENTER, UP & DOWN deviation selections at 0, 78, 150 and 343 μ A.

VAR provides CENTER, UP & DOWN deviation selections from 0 to 686 μ A in 1 μ A steps. UNCAL is displayed when set to VAR and the LOC DDM Field is in a Non-Zero position or when the M MOD Field is not set to CAL and the LOC DDM Field is in a Non-Zero position.

4.2.15 ILS Mode Screen (cont)

AP SWP

This Field controls the Localizer DDM sweep.

Press the AP SWP Soft Key to select OFF, START RIGHT or START LEFT.

The Localizer deviation may be set from 0 to 30 μ A using the LOC DDM LEFT Key and the LOC DDM RIGHT Key.

90/150 Hz

This Field controls the phase shift between the 90 and 150 Hz tones.

Use the 90/150Hz Soft Key, INCREMENT/SELECT DATA Key and DECREMENT/SELECT DATA Key to set the phase shift from 0° to 120° in 5° steps.

Press the 90/150Hz Soft Key to toggle between no phase shift and the selected phase shift.

This feature is used to simulate the phase shift between the 90 and 150 Hz tones that occurs, when an aircraft is turning to capture the Localizer beam.

The phase shift is also applied to the Glideslope 90 and 150 Hz tones.

TONE DEL

This Field allows either the 90 Hz, 150 Hz or both tones to be deleted. Press the TONE DEL Soft Key to toggle between OFF, 90, 150 or 90 & 150.

This feature is used to verify CDI (Course Deviation Indicator) NAV flag operation under invalid signal conditions.

SOFT KEYS

The **DEV STEP** Soft Key moves the cursor to the DEV STEP Field. Each additional key press toggles the Field between FIXED and VAR.

The **AP SWP** Soft Key moves the cursor to the AP SWP Field. Additional key presses are used to select between OFF, START RIGHT and START LEFT.

The **TONE DEL** Soft Key moves the cursor to the TONE DEL Field. Additional key presses are used to select between - (OFF), 90, 90 & 150 and 150.

The **90/150 Hz** Soft Key moves the cursor to the 90/150 Hz Field. Each additional key press toggles the Field between - (OFF) and 0 deg.

4.2.16 COMM AM Mode Screen

COMM AM	RF I/O	BAT 1.2 Hr
FREQ: 118.000 MHz	RF LVL: - 50.0 dBm	
M MOD: CAL (30%)	MOD TONE: 1020 Hz	
CHNL SP: 25 kHz		
PWR MTR: PEAK	RECEIVING	

TX FREQ==	TX PWR==	
TX MOD ==		
HOLD TX		
CHNL SP	HOLD CLEAR	SWITCH GEN/RX
	ZERO	POWER METER

PORT

This Field, at the top of the screen, displays the Port (RF I/O or ANT) selected in the Setup Menu.

BAT

This Field displays the amount of run time available before the battery requires charging.

When the Test Set is connected to an external power source and the battery is charging, " --- " is displayed in the BAT Field.

FREQ

This Field controls the signal generator frequency. Operation of this Field depends upon the settings of the FREQ Field in the Setup Menu.

PRESET provides three fixed selectable channels for each band of operation:

VHF

118.00 MHz, 137.00 MHz and 156.00 MHz

UHF

225.00 MHz, 312.00 MHz and 400.00 MHz

Preset is used for quick confidence testing.

CHANNEL allows the selection of any on-channel frequency with the Mode band. Channel is used for testing of any 8.33 kHz spaced channel from 118.00 to 156.00 MHz or any 25 kHz spaced channel from 10.00 to 400.00 MHz.

VAR allows the selection of the frequency from 117.00 to 401.00 MHz in 1 kHz increments to perform receiver bandwidth tests.

If MOD STRIKE 2 on Mod Strike Label is checked and the unit is loaded with Version 2.06 Software, VAR allows the selection of the frequency from 10.00 to 410.00 MHz in 1 kHz increments.

The INCREMENT/SELECT Data Key or the DECREMENT/SELECT Data Key may be used to slew the data. The SELECT DATA UNITS MSB Key or the SELECT DATA UNITS LSB Key may be used to select the FREQ units to be slewed (i.e., 1 kHz, 10 kHz, etc.).

RF LVL

This Field controls the signal generator RF output level. Operation of this Field depends upon the settings of the RF LVL UNITS Field in the Setup Menu.

RF Level units are displayed in dBm or $\mu\text{V}/\text{mV}$.

The INCREMENT/SELECT Data Key or the DECREMENT/SELECT Data Key may be used to slew the data. The SELECT DATA UNITS MSB Key or the SELECT DATA UNITS LSB Key may be used to select the RF LVL units to be slewed. The RF LVL is slewed in 0.1, 1.0 or 10 dB increments when the RF LVL Field is set to either dBm or $\mu\text{V}/\text{mV}$.

M MOD

This Field controls the signal generator Master Modulation Depth. Using the INCREMENT/SELECT Data Key or the DECREMENT/SELECT Data Key, modulation is set from 0% to 95% in 1% increments. Press the M MOD Key to toggle the modulation setting between 0% to CAL (30%).

MOD TONE

This Field controls the selection of a 1020 Hz Tone. Press the TONE Key to toggle the Field between OFF and 1020 Hz.

TX FREQ

This Field displays the transmitter frequency received over the RF I/O Connector or via the ANT Connector.

PWR MTR

This Field indicates that the Power Meter is measuring either Peak or Average Power. Press the POWER METER Soft Key to toggle the Field between PEAK and AVG.

4.2.16 COMM AM Mode Screen (cont)

TX PWR

This Field displays the transmitter power received (0.1 to 1999 W) over the RF I/O Connector. The TX PWR Field is not displayed if the ANT Connector is selected (Setup Menu).

CAUTION: OBSERVE DUTY CYCLE LIMITS:

≤10 W IS CONTINUOUS
OVERTEMP WARNING

>10 W TO ≤20 W IS
3 MIN ON - 2 MIN OFF
OVERTEMP WARNING

>20 W TO ≤30 W IS
1 MIN ON - 2 MIN OFF
OVERTEMP WARNING

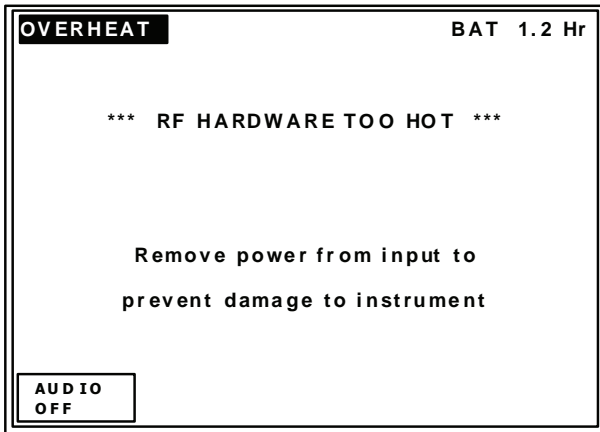

NOTE: The Power Monitor range and duration may be extended by the adding an External Attenuator to the RF I/O Connector.

The value of the External Attenuator should be entered in the EXT ATTN Field of the Setup Menu.

The displayed Power Reading takes into account any external attenuation.

TX MOD

This Field displays the transmitter Modulation Depth received (0% to 99%) over the RF I/O Connector or via the ANT Connector.

CHNL SP

This Field displays the signal generator channel spacing. This Field is only displayed when the FREQ Field in the Setup Menu is set to CHANNEL. Press the CHNL SP Soft Key to toggle the channel spacing from 8.33 to 25 kHz.

GEN/RX

This Field indicates if the Test Set is in Generate or Receive Mode. Press the GEN/RX Soft Key to toggle the channel spacing from GENERATING to RECEIVING.

NOTE: The Test Set does not automatically switch to RECEIVING when transmitter power is present at the RF I/O Connector.

SOFT KEYS

NOTE: Only the HOLD/CLEAR and SWITCH GEN/RX Soft Keys are displayed unless MOD STRIKE 2 on Mod Strike Label is checked and the unit is loaded with Version 2.06 Software.

The **CHNL SP** Soft Key moves the cursor to the CHNL SP Field. Each additional key press toggles the Field between 8.33 and 25 kHz.

The **HOLD/CLEAR** Soft Key toggles the screen between “Holding” the last measured UUT TX FREQ and TX MOD, and “clearing” the last measured TX FREQ, TX MOD and TX PWR. With HOLD selected, the UUT TX parameters are not transmitted upon subsequent transmitter keying and **HOLD TX** is displayed. The **HOLD/CLEAR** Soft Key must be pressed again to allow the display to update.

The **SWITCH GEN/RX** Soft Key toggles the screen between GENERATING and RECEIVING. The screen displays the mode selected.

The **ZERO** Soft Key displays the PWR MTR ZERO Screen (para 1-2-4.2.19).

The **POWER METER** Soft Key moves the cursor to the POWER METER Field. Each additional key press toggles the Field between PEAK and AVG.

4.2.17 COMM FM Mode Screen

COMM FM		RF I/O	BAT 1.2 Hr
FREQ: 156.0000 MHz	RF LVL: - 50.0 dBm		
M DEV: CAL (5 kHz)	MOD TONE: 1000 Hz		
CHNL SP: 12.5 kHz			
PWR MTR: PEAK	RECEIVING		

TX FREQ=-	TX PWR=-		
TX DEV =-			
HOLD TX			
CHNL SP	HOLD / CLEAR	SWITCH GEN/RX	ZERO POWER METER

PORT

This Field, at the top of the screen, displays the Port (RF I/O or ANT) selected in the Setup Menu.

BAT

This Field displays the amount of run time available before the battery requires charging.

When the Test Set is connected to an external power source and the battery is charging, " --- " is displayed in the BAT Field.

FREQ

This Field controls the signal generator frequency. Operation of this Field depends upon the settings of the FREQ Field in the Setup Menu.

PRESET provides four fixed selectable channels for each Mode: 156.00 MHz, 165.00 MHz, 167.50 MHz and 174.00 MHz. Preset is used for quick confidence testing.

CHANNEL allows the selection of any on-channel frequency with the Mode band. Channel is used for testing of any 12.5 or 25 kHz spaced channel from 10.00 to 400.00 MHz.

VAR allows the selection of the frequency from 155.00 to 401.00 MHz in 1 kHz increments to perform receiver bandwidth tests.

If MOD STRIKE 2 on Mod Strike Label is checked and the unit is loaded with Version 2.06 Software, VAR allows the selection of the frequency from 10.00 to 410.00 MHz in 1 kHz increments.

The INCREMENT/SELECT Data Key or the DECREMENT/SELECT Data Key may be used to slew the data. The SELECT DATA UNITS MSB Key or the SELECT DATA UNITS LSB Key may be used to select the FREQ units to be slewed (i.e., 1 kHz, 10 kHz, etc.).

RF LVL

This Field controls the signal generator RF output level. Operation of this Field depends upon the settings of the RF LVL UNITS Field in the Setup Menu.

RF Level units are displayed in dBm or $\mu\text{V}/\text{mV}$.

The INCREMENT/SELECT Data Key or the DECREMENT/SELECT Data Key may be used to slew the data. The SELECT DATA UNITS MSB Key or the SELECT DATA UNITS LSB Key may be used to select the RF LVL units to be slewed. The RF LVL is slewed in 0.1, 1.0 or 10 dB increments when the RF LVL Field is set to either dBm or $\mu\text{V}/\text{mV}$.

M DEV

This Field controls the signal generator Master Deviation. Using the INCREMENT/ SELECT Data Key or the DECREMENT/ SELECT Data Key, deviation is set from 0 to 80 kHz in 1 kHz increments. Press the M MOD Key to toggle the deviation setting between 0 kHz to CAL (5 kHz).

MOD TONE

This Field controls the selection of a 1000 Hz Tone. Press the TONE Key to toggle the Field between OFF and 1000 Hz.

PWR MTR

This Field indicates that the Power Meter is measuring either Peak or Average Power. Press the POWER METER Soft Key to toggle the Field between PEAK and AVG.

TX FREQ

This Field displays the transmitter frequency received over the RF I/O Connector or via the ANT Connector.

4.2.17 COMM FM Mode Screen (cont)

TX PWR

This Field displays the transmitter power received (0.1 to 1999 W) over the RF I/O Connector. The TX PWR Field is not displayed if the ANT Connector is selected (Setup Menu).

CAUTION: OBSERVE DUTY CYCLE LIMITS:

≤10 W IS CONTINUOUS
OVERTEMP WARNING

>10 W TO ≤20 W IS
3 MIN ON - 2 MIN OFF
OVERTEMP WARNING

>20 W TO ≤30 W IS
1 MIN ON - 2 MIN OFF
OVERTEMP WARNING

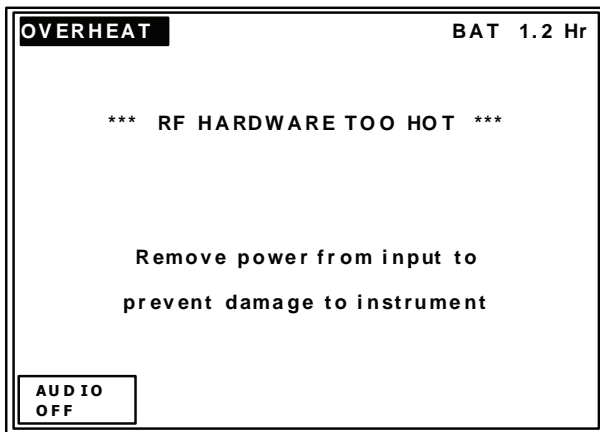

NOTE: The Power Monitor range and duration may be extended by the adding an External Attenuator to the RF I/O Connector.

The value of the External Attenuator should be entered in the EXT ATTN Field of the Setup Menu.

The displayed Power Reading takes into account any external attenuation.

TX DEV

This Field displays the transmitter Deviation, received (0 to 15 kHz) over the RF I/O Connector or via the ANT Connector.

NOTE: The Transmitter frequency must match the frequency set on the COMM VHF FM Mode Screen to perform deviation measurements.

CHNL SP

This Field displays the signal generator/ receive frequency channel spacing. This Field is only displayed when the FREQ Field in the Setup Menu is set to CHANNEL. Press the CHNL SP Soft Key to toggle the channel spacing from 12.5 to 25 kHz.

GEN/RX

This Field indicates if the Test Set is in Generate or Receive Mode. Press the GEN/RX Soft Key to toggle the channel spacing from GENERATING to RECEIVING.

NOTE: The Test Set does not automatically switch to RECEIVING when transmitter power is present at the RF I/O Connector.

SOFT KEYS

NOTE: Only the HOLD/CLEAR Soft Key is displayed unless MOD STRIKE 2 on Mod Strike Label is checked and the unit is loaded with Version 2.06 Software.

The **CHNL SP** Soft Key moves the cursor to the CHNL SP Field. Each additional key press toggles the Field between 12.5 and 25 kHz.

The **HOLD/CLEAR** Soft Key toggles the screen between "Holding" the last measured UUT TX FREQ and TX MOD, and "clearing" the last measured TX FREQ, TX MOD and TX PWR. With HOLD selected, the UUT TX parameters are not transmitted upon subsequent transmitter keying and **HOLD TX** is displayed. The **HOLD/CLEAR** Soft Key must be pressed again to allow the display to update.

The **SWITCH GEN/RX** Soft Key toggles the screen between GENERATING and RECEIVING. The screen displays the mode selected.

The **ZERO** Soft Key displays the PWR MTR ZERO Screen (para 1-2-4.2.19).

The **POWER METER** Soft Key moves the cursor to the POWER METER Field. Each additional key press toggles the Field between PEAK and AVG.

4.2.18 COMM SSB Mode Screen

The COMM SSB Mode Screen is only displayed when MOD STRIKE 2 on Mod Strike Label is checked and the unit is loaded with Version 2.06 Software.

COMM SSB	RF I/O	BAT 1.2 Hr
FREQ: 10.0000 MHz	RF LVL: - 50.0 dBm	
SIDE BAND: UPPER	MOD TONE: 1000 Hz	
RECEIVING		

TX FREQ=-	TX PWR=-	
AUDIO FREQ =-		
HOLD TX		
HOLD/ CLEAR	SWITCH GEN/RX	POWER METER

PORT

This Field, at the top of the screen, displays the Port (RF I/O or ANT) selected in the Setup Menu.

BAT

This Field displays the amount of run time available before the battery requires charging.

When the Test Set is connected to an external power source and the battery is charging, " --- " is displayed in the BAT Field.

FREQ

This Field allows the selection of the frequency from 10.00 to 30.00 MHz in 100 Hz increments to perform receiver bandwidth tests.

The INCREMENT/SELECT Data Key or the DECREMENT/SELECT Data Key may be used to slew the data. The SELECT DATA UNITS MSB Key or the SELECT DATA UNITS LSB Key may be used to select the FREQ units to be slewed (i.e., 1 kHz, 10 kHz, etc.).

RF LVL

This Field controls the signal generator RF output level. Operation of this Field depends upon the settings of the RF LVL UNITS Field in the Setup Menu.

RF Level units are displayed in dBm or $\mu\text{V}/\text{mV}$.

The INCREMENT/SELECT Data Key or the DECREMENT/SELECT Data Key may be used to slew the data. The SELECT DATA UNITS MSB Key or the SELECT DATA UNITS LSB Key may be used to select the RF LVL units to be slewed. The RF LVL is slewed in 0.1, 1.0 or 10 dB increments when the RF LVL Field is set to either dBm or $\mu\text{V}/\text{mV}$.

SIDE BAND

This Field controls the selection of the single side band when the IFR 4000 is in generate mode. Press the SIDE BAND Soft Key to toggle the Field between UPPER and LOWER. The INCREMENT/SELECT Data Key or the DECREMENT/SELECT Data Key may also be used to toggle the Field.

MOD TONE

This Field controls the selection of a preset 1000 Hz tone. Press the TONE Soft Key to toggle the Field between OFF and 1000 Hz. The INCREMENT/SELECT Data Key or the DECREMENT/SELECT Data Key may be used to select a variable tone from 25 to 3000 kHz in 25 Hz steps. Press the TONE Soft Key again to reset the Field to the preset 1000 Hz tone.

PWR MTR

This Field indicates that the Power Meter is measuring either Peak or Average Power. Press the POWER METER Soft Key to toggle the Field between PEAK and AVG.

TX FREQ

This Field displays the transmitter frequency received over the RF I/O Connector or via the ANT Connector.

4.2.18 COMM SSB Mode Screen (cont)

TX PWR

This Field displays the transmitter power received (0.1 to 1999 W) over the RF I/O Connector. The TX PWR Field is not displayed if the ANT Connector is selected (Setup Menu).

CAUTION: OBSERVE DUTY CYCLE LIMITS:

≤10 W IS CONTINUOUS
OVERTEMP WARNING

>10 W TO ≤20 W IS
3 MIN ON - 2 MIN OFF
OVERTEMP WARNING

>20 W TO ≤30 W IS
1 MIN ON - 2 MIN OFF
OVERTEMP WARNING

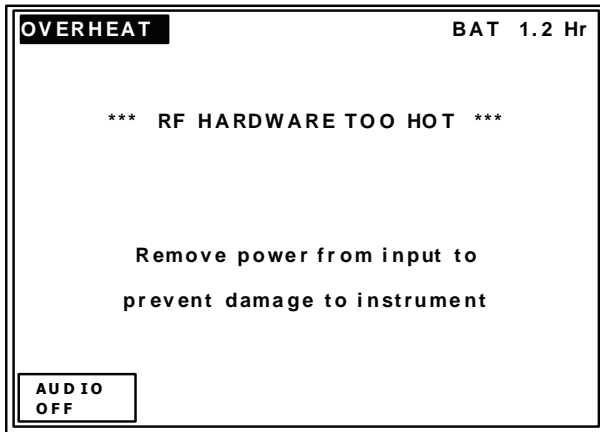

NOTE: The Power Monitor range and duration may be extended by the adding an External Attenuator to the RF I/O Connector.

The value of the External Attenuator should be entered in the EXT ATTN Field of the Setup Menu.

The displayed Power Reading takes into account any external attenuation.

AUDIO FREQ

This Field displays the SSB transmitter USB or LSB Audio Frequency Modulation (1 to 5000 Hz) received over the RF I/O Connector or via the ANT Connector.

GEN/RX

This Field indicates if the Test Set is in Generate or Receive Mode. Press the GEN/RX Soft Key to toggle the channel spacing from GENERATING to RECEIVING.

NOTE: The Test Set does not automatically switch to RECEIVING when transmitter power is present at the RF I/O Connector.

SOFT KEYS

The **HOLD/CLEAR** Soft Key toggles the screen between “Holding” the last measured UUT TX FREQ and TX MOD, and “clearing” the last measured TX FREQ, TX MOD and TX PWR. With HOLD selected, the UUT TX parameters are not transmitted upon subsequent transmitter keying and **HOLD TX** is displayed. The **HOLD/CLEAR** Soft Key must be pressed again to allow the display to update.

The **SWITCH GEN/RX** Soft Key toggles the screen between GENERATING and RECEIVING. The screen displays the mode selected.

The **ZERO** Soft Key displays the PWR MTR ZERO Screen (para 1-2-4.2.19).

The **POWER METER** Soft Key moves the cursor to the POWER METER Field. Each additional key press toggles the Field between PEAK and AVG.

4.2.19 PWR MTR ZERO Screen

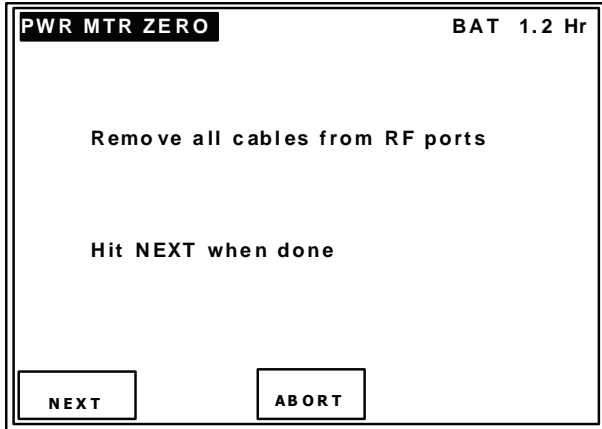

BAT

This Field displays the amount of run time available before the battery requires charging. When the Test Set is connected to an external power source and the battery is charging, “ --- “ is displayed in the BAT Field.

SOFT KEYS

The **NEXT** Soft Key displays the following screen as the Power Meter is set to zero.

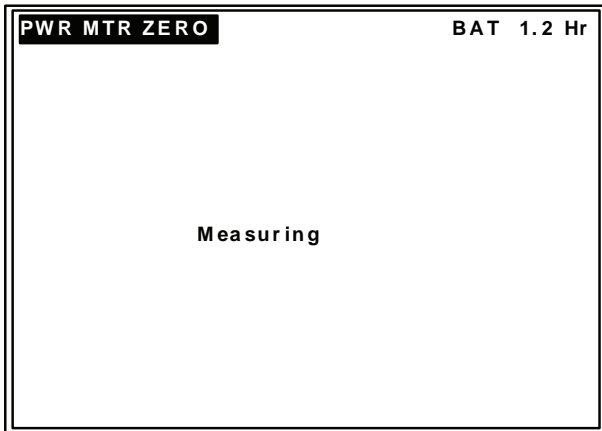

The **ABORT** Soft Key aborts the PWR MTR ZERO application.

4.2.20 SWR Mode Screen

4.2.20.1 CW SWR

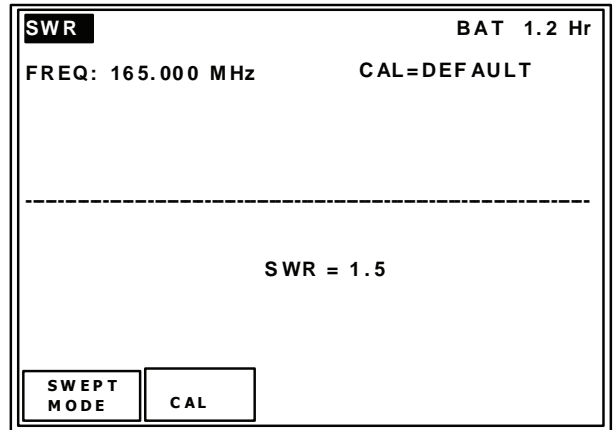

BAT

This Field displays the amount of run time available before the battery requires charging. When the Test Set is connected to an external power source and the battery is charging, “ --- “ is displayed in the BAT Field.

FREQ

This Field controls the CW signal generator frequency used for the static SWR measurement.

PRESET provides six fixed selectable channels: 75.00 MHz, 108.00 MHz, 137.00 MHz, 165.00 MHz, 312.00 MHz and 335.00 MHz. Preset is used for quick confidence testing.

If MOD STRIKE 2 on Mod Strike Label is checked and the unit is loaded with Version 2.06 Software, PRESET provides nine fixed selectable channels: 75.00 MHz, 108.00 MHz, 121.50 MHz, 137.00 MHz, 165.00 MHz, 243.00 MHz, 312.00 MHz, 335.00 MHz and 406.00 MHz.

CHANNEL allows the selection of any on-channel frequency with the Mode band. CHANNEL is used for testing of any 25 kHz spaced channel from 75.00 to 400.00 MHz.

If MOD STRIKE 2 on Mod Strike Label is checked and the unit is loaded with Version 2.06 Software, CHANNEL is used for testing of any 25 kHz spaced channel from 10.00 to 410.00 MHz.

4.2.20 SWR Mode Screen (cont)

4.2.20.1 CW SWR (cont)

VAR allows the selection of the frequency from 72.00 to 401.00 MHz in 1 kHz increments.

If MOD STRIKE 2 on Mod Strike Label is checked and the unit is loaded with Version 2.06 Software, VAR allows the selection of the frequency from 10.00 to 410.00 MHz in 1 kHz increments.

The INCREMENT/SELECT Data Key or the DECREMENT/SELECT Data Key may be used to slew the data. The SELECT DATA UNITS MSB Key or the SELECT DATA UNITS LSB Key may be used to select the FREQ units to be slewed (i.e., 1 kHz, 10 kHz, etc.).

CAL

DEFAULT is the Factory Calibration for the Test Set. The Test Set is calibrated at the SWR Connector (without a cable) over the frequency range of 10.00 to 401.00 MHz. The DEFAULT calibration values are recalled and applied for each new session (at Power-Up), for any Mode changes and for any frequency changes.

USER allows the operator to perform a Field Calibration for a particular Test Setup. The User calibration values are only valid for the current session.

SWR

This Field displays the measured SWR.

SOFT KEYS

The **SWEPT MODE** Soft Key displays the SWEPT SWR Mode Screen (para 1-2-4.2.20.2).

The **CAL** Soft Key displays the SWR CAL Screen (para 1-2-4.2.20.3).

4.2.20.2 SWEPT SWR

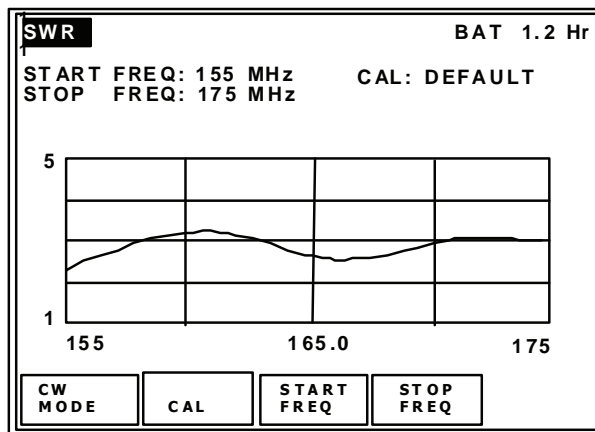

BAT

This Field displays the amount of run time available before the battery requires charging.

When the Test Set is connected to an external power source and the battery is charging, “ --- ” is displayed in the BAT Field.

START/STOP FREQ

This Field controls the CW signal generator frequency used for the static SWR measurement.

PRESET provides six fixed selectable START/STOP channels: 72.00/78.00 MHz, 107.00/118.00 MHz, 117.00/157.00 MHz, 155.00/175.00 MHz, 224.00/401.00 MHz and 327.00/337.00 MHz. Preset is used for quick confidence testing.

If MOD STRIKE 2 on Mod Strike Label is checked and the unit is loaded with Version 2.06 Software, PRESET provides nine fixed selectable START/STOP channels: 72.00/78.00 MHz, 107.00/118.00 MHz, 117.00/157.00 MHz, 118.00/126.00 MHz, 155.00/175.00 MHz, 224.00/401.00 MHz, 239.00/247.00 MHz, 327.00/337.00 MHz and 402.00/410.00 MHz.

CHANNEL allows the selection of the START and STOP frequency in 5 or 10 MHz steps.

4.2.20 SWR Mode Screen (cont)

4.2.20.2 SWEPT SWR (cont)

VAR allows the selection of the frequency from 72.00 to 400.00 MHz (START) and 73.00 to 401.00 MHz (STOP) (always 1 MHz above the START frequency) in 1 MHz increments.

If MOD STRIKE 2 on Mod Strike Label is checked and the unit is loaded with Version 2.06 Software, VAR allows the selection of the frequency from 10.00 to 409.00 MHz (START) and 11.00 to 410.00 MHz (STOP) (always 1 MHz above the START frequency) in 1 MHz increments.

The INCREMENT/SELECT Data Key or the DECREMENT/SELECT Data Key may be used to slew the data. The SELECT DATA UNITS MSB Key or the SELECT DATA UNITS LSB Key may be used to select the FREQ units to be slewed (i.e., 1 kHz, 10 kHz, etc.).

CAL

DEFAULT is the Factory Calibration for the Test Set. The Test Set is calibrated at the SWR Connector (without a cable) over the frequency range of 10.00 to 401.00 MHz. The DEFAULT calibration values are recalled and applied for each new session (at Power-Up), for any Mode changes and for any frequency changes.

USER allows the operator to perform a Field Calibration for a particular Test Setup. The User calibration values are only valid for the current session.

SOFT KEYS

The **CW MODE** Soft Key displays the SWR Mode Screen (para 1-2-4.2.20.1).

The **CAL** Soft Key displays the SWR CAL Screen (para 1-2-4.2.20.3) for user calibration.

The **START FREQ** Soft Key moves the cursor to the START FREQ Field. Each additional key press increases the frequency in the START FREQ Field by 5 MHz (when in CHANNEL) or by 1 MHz (when in VAR).

The **STOP FREQ** Soft Key moves the cursor to the STOP FREQ Field. Each additional key press increases the frequency in the START FREQ Field by 5 MHz (when in CHANNEL) or by 1 MHz (when in VAR).

4.2.20.3 SWR CAL Screen

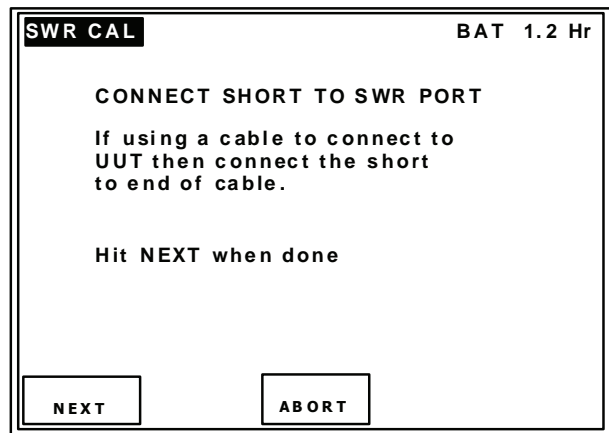

BAT

This Field displays the amount of run time available before the battery requires charging.

When the Test Set is connected to an external power source and the battery is charging, " --- " is displayed in the BAT Field.

SOFT KEYS

The **NEXT** Soft Key continues the SWR Calibration application.

The **ABORT** Soft Key aborts the SWR Calibration application.

The **SAVE & RETURN** Soft Key saves the SWR Calibration results.

4.2.21 SELCAL Mode Screen

SELCAL	RF I/O	BAT 1.2 Hr
FREQ: 118.000 MHz	RF LVL: - 50.0 dBm	
M MOD: CAL (80%)	SELCAL TONE: AB-CD	
TX MODE: SINGLE		
SEL TONE	TX MODE	START

NOTE: The SELCAL Transmission must be stopped to allow editing of any Fields in the SELCAL Mode Screen or for changing modes.

PORT

This Field, at the top of the screen, displays the Port (RF I/O or ANT) selected in the Setup Menu.

BAT

This Field displays the amount of run time available before the battery requires charging.

When the Test Set is connected to an external power source and the battery is charging, " --- " is displayed in the BAT Field.

FREQ

This Field controls the signal generator frequency. Operation of this Field depends upon the settings of the FREQ Field in the Setup Menu.

PRESET provides three fixed selectable channels for each Mode: 118.00 MHz, 137.00 MHz and 156.00 MHz. Preset is used for quick confidence testing.

If MOD STRIKE 2 on Mod Strike Label is checked and the unit is loaded with Version 2.06 Software, PRESET provides six fixed selectable channels for each Mode: 10.045 MHz, 21.000 MHz, 30.000 MHz, 118.000 MHz, 137.000 MHz and 156.000 MHz.

CHANNEL allows the selection of any on-channel frequency with the Mode band. Channel is used for testing of any 8.33 or 25 kHz spaced channel from 118.00 to 156.00 MHz.

If MOD STRIKE 2 on Mod Strike Label is checked and the unit is loaded with Version 2.06 Software, CHANNEL is used for testing of any 8.33 or 25 kHz spaced channel from 10.00 to 156.00 MHz.

VAR allows the selection of the frequency from 117.00 to 157.00 MHz in 1 kHz increments.

If MOD STRIKE 2 on Mod Strike Label is checked and the unit is loaded with Version 2.06 Software, VAR allows the selection of the frequency from 10.00 to 157.00 MHz in 1 kHz increments.

The INCREMENT/SELECT Data Key or the DECREMENT/SELECT Data Key may be used to slew the data. The SELECT DATA UNITS MSB Key or the SELECT DATA UNITS LSB Key may be used to select the FREQ units to be slewed (i.e., 1 kHz, 10 kHz, etc.).

RF LVL

This Field controls the signal generator RF output level. Operation of this Field depends upon the settings of the RF LVL UNITS Field in the Setup Menu.

RF Level units are displayed in dBm or $\mu\text{V}/\text{mV}$.

The INCREMENT/SELECT Data Key or the DECREMENT/SELECT Data Key may be used to slew the data. The SELECT DATA UNITS MSB Key or the SELECT DATA UNITS LSB Key may be used to select the RF LVL units to be slewed (i.e., 0.1 dBm, 1 dBm, etc.).

M MOD

This Field controls the signal generator Master Modulation Depth. The Master Modulation control functions as a multiplier of the individual modulation components. The Master Modulation Depth is the sum of the Depths of Modulation (SDM) of the individual tone components. Using the INCREMENT/ SELECT Data Key or the DECREMENT/ SELECT Data Key, modulation is set from 0% to 110% in increment steps equal to the sum of the individual tone components (i.e., if two tones of equal modulation depth are enabled, the M MOD Field increments in 2% steps). Press the M MOD Key to toggle the modulation setting between 0% and CAL (80%).

4.2.21 SELCAL Mode Screen (cont)

SELCAL TONE

This Field allows the tone pulse pairs to be selected.

Press SEL TONE Soft Key to access the SELCAL Tone Field. Use the INCREMENT/SELECT Data Key or the DECREMENT/SELECT Data Key to select the required tone letter. Repeat for additional pulse pairs.

TX MODE

This Field allows the selection of either SINGLE or CONTINUOUS Mode.

The INCREMENT/SELECT Data Key or the DECREMENT/SELECT Data Key may be used to toggle the field between SINGLE and CONTINUOUS.

SOFT KEYS

The **SEL TONE** Soft Key moves the cursor to the SELCAL TONE Field. Each additional key press moves the cursor to the next digit (to the right).

The **TX MODE** Soft Key moves the cursor to the TX MODE Field. Each additional key press toggles the Field between SINGLE and CONTINUOUS.

The **START** Soft Key starts the SELCAL transmission.

The **STOP CONT** Soft Key stops the SELCAL transmission.

4.2.22 FREQUENCY COUNTER Mode Screen

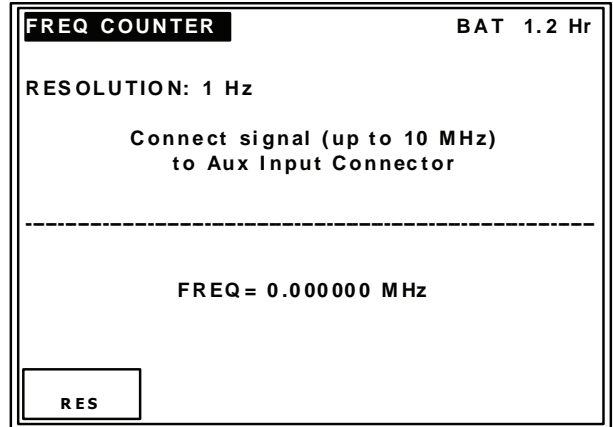

BAT

This Field displays the amount of run time available before the battery requires charging.

When the Test Set is connected to an external power source and the battery is charging, " --- " is displayed in the BAT Field.

RESOLUTION

This Field displays the frequency counter resolution. Press the RES Soft Key to toggle between 1 Hz, 10 Hz, 100 Hz or 1 kHz.

FREQ

This Field displays the frequency received over the AUX I/O Connector.

SOFT KEYS

The **RES** Soft Key moves the cursor to the RESOLUTION Field. Additional key presses are used to select between 1 Hz, 10 Hz, 100 Hz or 1 kHz.

4.2.23 121.5/243 BEACON Mode Screen (p/o ELT Option)

The IFR 4000 has a test capability for any 121.5/243 MHz Short Range Swept Tone Emergency Beacon.

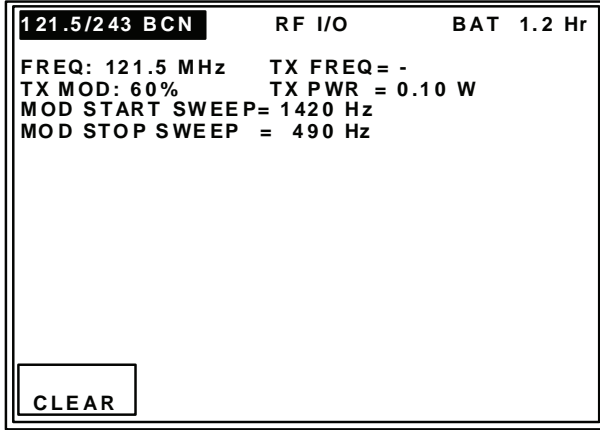

FREQ

This Field displays the Beacon frequency tuned to the IFR 4000. The FREQ Key toggles the field between 121.5 and 243 MHz.

TX FREQ

This Field displays the transmitter frequency received over the RF I/O Connector or via the ANT Connector.

TX PWR

This Field displays the transmitter power received (0.10 to 30 W) over the RF I/O Connector. The TX PWR Field is not displayed if the ANT Connector is selected (Setup Menu).

CAUTION: OBSERVE DUTY CYCLE LIMITS:

≤10 W IS CONTINUOUS
OVERTEMP WARNING

>10 W TO ≤20 W IS
3 MIN ON - 2 MIN OFF
OVERTEMP WARNING

>20 W TO ≤30 W IS
1 MIN ON - 2 MIN OFF
OVERTEMP WARNING

TX MOD

This Field displays the transmitter Modulation Depth received (0% to 99%) over the RF I/O Connector or via the ANT Connector.

MOD START SWEEP

This field displays the swept modulation start frequency.

MOD STOP SWEEP

This field displays the swept modulation stop frequency.

NOTE: Always refer to the Beacon Manufacturer's Test Documentation for specific tests. Aeroflex does not recommend Beacon radiated testing unless testing is conducted in an RF shielded room.

NOTE: The swept tone may be monitored via the headset audio output available via the AUX I/O Connector. A user manufactured cable is required to mate the headset phones connector with the AUX I/O Connector.

CAUTION: ENSURE THE BEACON IS DIRECTLY CONNECTED TO THE RF I/O CONNECTOR BEFORE ACTIVATING.

CAUTION: IF TESTING THE 121.5/243 MHz BEACON RADIATED SIGNAL IN FREE SPACE VIA THE ANT CONNECTOR, ALWAYS PERFORM THE TESTS WITHIN THE FIRST 5 MINUTES OF THE HOUR (UTC).

CAUTION: ENSURE NO MORE THAN THREE SWEEPS ARE TRANSMITTED OR CONDUCT THE TESTING IN AN RF SHIELDED ROOM.

CAUTION: IF PERFORMING A RADIATED TEST WITH A BEACON THAT HAS 406 MHz CAPABILITY, DO NOT ALLOW THE TEST DURATION TO EXCEED 5 SEC.

CAUTION: THE BEACON TRANSMITS A 406 MHz SIGNAL ≈45 SEC AFTER THE BEACON IS ACTIVATED. THE SATELLITE SYSTEM CONSIDERS THIS TRANSMISSION TO BE A VALID DISTRESS SIGNAL.

NOTE: The first release of this software displays a graphical representation of the swept tone. This has been superseded by the audio monitoring via the AUX I/O Connector and, at a subsequent software release, is replaced by fields providing additional information such as sweep, sweep rate and modulation duty cycle.

SOFT KEYS

The **CLEAR** Soft Key clears the TX PWR, TX FREQ, TX MOD, MOD START SWEEP and MOD STOP SWEEP field values.

4.2.24 406 BEACON Mode Screen (p/o ELT Option)

The 406 MHz Beacon transmission contains unique digital coded messages, 0.5 sec in duration, which can be received by polar orbiting satellites that are part of the COSPAS/SARSAT System. The Beacon, once activated, transmits every 50 sec. In emergency situations these satellites, that are part of the COSPAS/SARSAT System, receive and retransmit the coded message. The retransmitted data is received and processed by a ground station. The ground station then alerts the closest Search and Rescue forces to respond to the emergency.

The 406 MHz Beacons conform primarily to COSPAS/SARSAT Specification C/S T.001 and Aeronautical Beacons (ELT's) also conform to the specification defined in RTCA/DO-204 and EUROCAE ED62.

There are three types of 406 MHz Beacons:

ELT (Emergency Locator Transmitters)
For aviation use.

EPIRB (Emergency Position Indicating Radio Beacons)
For maritime use.

PLB (Personal Locator Beacons)
For personal use.

Each message sent by a 406 MHz Beacon includes the unique identification of the Beacon. The complete Beacon identification code includes the protocol flag, protocol code and country code together with identification data which is encoded in the first protected data field (PDF-1) of the 406 MHz message.

Identification data can be provided in various alphanumeric formats, depending on the coding protocol required by the responsible administration. Identification data is encoded together with the country code and other information in the Beacon message in binary format.

As different user groups have different needs, these needs are accommodated by the use of various coding protocols. The coding protocols are divided into:

User Protocols

Location Protocols

Refer to Appendix F for Beacon Application and Protocol Charts.

The IFR 4000 automatically decodes the binary message from the beacon, determines the protocol used and displays the data appropriately.

FREQ

This Field displays the transmitter frequency received over the RF I/O Connector or via the ANT Connector.

TX PWR

This Field displays the transmitter power received (0.10 to 30 W) over the RF I/O Connector. The TX PWR Field is not displayed if the ANT Connector is selected (Setup Menu).

CAUTION: OBSERVE DUTY CYCLE LIMITS:

≤10 W IS CONTINUOUS
OVERTEMP WARNING

>10 W TO ≤20 W IS
3 MIN ON - 2 MIN OFF
OVERTEMP WARNING

>20 W TO ≤30 W IS
1 MIN ON - 2 MIN OFF
OVERTEMP WARNING

NOTE: Always refer to the Beacon Manufacturer's Test Documentation for specific tests. Aeroflex does not recommend Beacon radiated testing, unless testing is conducted in an RF shielded room.

CAUTION: IF TESTING THE 406 MHz BEACON RADIATED SIGNAL IN FREE SPACE VIA THE ANT CONNECTOR, ALWAYS ENSURE THE BEACON ONLY TRANSMITS THE TEST MESSAGE.

CAUTION: THE 406 MHz BEACON TEST MESSAGE MAY BE ACTIVATED BY DIFFERENT MEANS FOR EACH BEACON TYPE.

CAUTION: THE BEACON TRANSMITS A 406 MHz SIGNAL ≈45 SEC AFTER THE BEACON IS ACTIVATED. THE SATELLITE SYSTEM CONSIDERS THIS TRANSMISSION TO BE A VALID DISTRESS SIGNAL.

NOTE: Refer to the following website for more information regarding Beacon testing.

<http://www.sarsat.noaa.gov/faq.html>

SOFT KEYS

The **CLEAR** Soft Key clears all data fields.

The **HOLD** Soft Key holds the currently displayed data.

The **DATA DUMP** Soft Key prints the 406 Beacon data through an RS-232 Connection.

4.2.24 406 BEACON Mode Screen (p/o ELT Option) (cont)

The example screens illustrate the User and Location Protocols (short and long messages).

Refer to 1-2-4, Table 2 for the 406 BEACON Message Field descriptions.

NO MESSAGE SCREEN

406 BCN	RF I/O	BAT 1.20 Hr
FREQ= -		TX PWR= -
MSG= -		
BEACON ID = -		
COUNTRY= -		

CLEAR	HOLD	DATA DUMP
-------	------	-----------

SHORT MESSAGE USER PROTOCOL

406 BCN	RF I/O	BAT 1.20 Hr
FREQ= 406.0250 MHz		TX PWR= 5.00 W
MSG= 53C32497380BA60FD0F526		
BEACON ID = A786492E70174C1		
COUNTRY= 316 CANADA		
USER PROTOCOL= ELT - AVIATION		
REGISTRATION MARKING= C7518		
FIXED BITS= 00		
RADIO-LOCATING= 121.5 MHz		
BCH-1= 1F43D4 VALID		
BEACON ACTIVATION= MANUAL		
EMERGENCY CODE= 0110		

CLEAR	HOLD	DATA DUMP
-------	------	-----------

406 BCN	RF I/O	BAT 1.20 Hr
FREQ= 406.0250 MHz		TX PWR= 5.00 W
MSG= 56E6D5E1E1E0000B5E4A10		
BEACON ID = ADCDABC3C3C0001		
COUNTRY= 366 U.S.A.		
USER PROTOCOL= SERIAL		
BEACON TYPE= AIRCRAFT ADDRESS		
24-BIT ADDRESS= AF0F0F		
ADDL ELT NO= 00		NATL USE= 0000
RADIO-LOCATING= 121.5 MHz		
BCH-1= 0D7928 VALID		
BEACON ACTIVATION= AUTO AND MANUAL		
NATL USE CODE= 0000		

CLEAR	HOLD	DATA DUMP
-------	------	-----------

SHORT MESSAGE USER PROTOCOL (cont)

406 BCN	RF I/O	BAT 1.20 Hr
FREQ= 406.0250 MHz		TX PWR= 5.00 W
MSG= 56E65C714EC0000E123810		
BEACON ID = ADCCB8E29D80001		
COUNTRY= 366 U.S.A.		
USER PROTOCOL= SERIAL		
BEACON TYPE= AIRCRAFT OPERATOR		
OPERATOR DESIGNATOR= AAL		
SERIAL NO= 3456		NATL USE= 0000
RADIO-LOCATING= 121.5 MHz		
BCH-1= 1848E0 VALID		
BEACON ACTIVATION= AUTO AND MANUAL		
NATL USE CODE= 0000		

CLEAR	HOLD	DATA DUMP
-------	------	-----------

406 BCN	RF I/O	BAT 1.20 Hr
FREQ= 406.0250 MHz		TX PWR= 5.00 W
MSG= 6D5FF07C1F07C1E02121C0		
BEACON ID = DABFE0F83E0F83C		
COUNTRY= 725 CHILE		
USER PROTOCOL= TEST		
DATA-1= 11111000001111100000111		
11000001111100000111100		
BCH-1= 008487 VALID		
DATA-2= 000000		

CLEAR	HOLD	DATA DUMP
-------	------	-----------

406 BCN	RF I/O	BAT 1.20 Hr
FREQ= 406.0250 MHz		TX PWR= 5.00 W
MSG= 56E6004002202003928410		
BEACON ID = ADCC00800440400		
COUNTRY= 366 U.S.A.		
USER PROTOCOL= SERIAL		
BEACON TYPE= AVIATION		
MFR ID NO= 002		MFR SEQ NO= 0001
MFR MODEL NO= 01		MFR RUN NO= 001
RADIO-LOCATING= NONE		
BCH-1= 0E4A10 VALID		
BEACON ACTIVATION= AUTO AND MANUAL		
NATL USE CODE= 0000		

CLEAR	HOLD	DATA DUMP
-------	------	-----------

4.2.24 406 BEACON Mode Screen (p/o ELT Option) (cont)

LONG MESSAGE USER LOCATION PROTOCOL

406 BCN	RF I/O	BAT 1.20 Hr
FREQ= 406.0250 MHz TX PWR= 5.00 W MSG= D6EE1F7252111C8777D9A570017151 BEACON ID = ADDC3EE4A422390 COUNTRY= 366 U.S.A. USER PROTOCOL= TEST DATA-1= 00001111101110010010100 10000100010001110010000 BCH-1= 1DDF66 VALID DATA-2= 10010101110000000000010111 BCH-2= 151 VALID		
CLEAR	HOLD	DATA DUMP

LONG MESSAGE STANDARD LOCATION PROTOCOL

406 BCN	RF I/O	BAT 1.20 Hr
FREQ= 406.0250 MHz TX PWR= 5.00 W MSG= 96E47B92922BC0622C8CF504422535 BEACON ID = 2DC8F725245780C COUNTRY= 366 U.S.A. STD LOC PROTOCOL= ELT - SERIAL C/S TAC NO= 0494 SERIAL NO= 04754 LAT= 4343 56 N LONG= 002 57 52 E BCH-1= 08B233 VALID FIXED BITS= 1101 POS SRC= EXT 121.5 MHz HOMING= YES BCH-2= 535 VALID		

406 BCN	RF I/O	BAT 1.20 Hr
FREQ= 406.0250 MHz TX PWR= 5.00 W MSG= D6E61F25211C86D8232570017151 BEACON ID = ADCC3EE4A422390 COUNTRY= 366 U.S.A. USER PROTOCOL= SERIAL BEACON TYPE= AVIATION MFR ID NO= 251 MFR SEQ NO= 2345 MFR MODEL NO= 00 MFR RUN NO= 136 RADIO-LOCATING= NONE BCH-1= 1B608C VALID POS SRC= INT LAT= 43 32 00 N LONG= 001 28 00 E BCH-2= 151 VALID		
CLEAR	HOLD	DATA DUMP

406 BCN	RF I/O	BAT 1.20 Hr
FREQ= 406.0250 MHz TX PWR= 5.00 W MSG= 96EE1F7252000C833E1D2570017151 BEACON ID = 2DDC3EE4A400190 COUNTRY= 366 U.S.A. STD LOC PROTOCOL= TEST DATA-1= 00001111101110010010100 1000000000000110010000 BCH-1= 0CF874 VALID DATA-2= 10010101110000000000010111 BCH-2= 151 VALID		
CLEAR	HOLD	DATA DUMP

SHORT MESSAGE STANDARD LOCATION PROTOCOL

406 BCN	RF I/O	BAT 1.20 Hr
FREQ= 406.0250 MHz TX PWR= 5.00 W MSG= 16E47B92922BC061D42FF5 BEACON ID = 2DC8F725245780C COUNTRY= 366 U.S.A. STD LOC PROTOCOL= ELT - SERIAL C/S TAC NO= 0494 SERIAL NO= 04754 LAT= 43 45 00 N LONG= 003 00 00 W BCH-1= 0750BF VALID FIXED BITS= 1101 POS SRC= EXT 121.5 MHz HOMING= YES		
CLEAR	HOLD	DATA DUMP

SHORT MESSAGE NATIONAL LOCATION PROTOCOL

406 BCN	RF I/O	BAT 1.20 Hr
FREQ= 406.0250 MHz TX PWR= 5.00 W MSG= 16E87B92922BC060AC2835 BEACON ID = 2DD0F725245780C COUNTRY= 366 U.S.A. NATL LOC PROTOCOL= ELT ORG/MFR ID= 0494 SEQUENCE NO= 074 LAT= 37 39 40 N LONG= 97 44 15 W BCH-1= 02B0A0 VALID FIXED BITS= 110 POS SRC= EXT 121.5 MHz HOMING= YES		
CLEAR	HOLD	DATA DUMP

4.2.24 406 BEACON Mode Screen
(p/o ELT Option) (cont)

LONG MESSAGE NATIONAL LOCATION
PROTOCOL

406 BCN	RF I/O	BAT 1.20 Hr
FREQ= 406.0250 MHz TX PWR= 5.00 W MSG= 96E87B92922BC063548B3504422535 BEACON ID = 2DD0F725245780C COUNTRY= 366 U.S.A. NATL LOC PROTOCOL= ELT ORG/MFR ID= 0494 SEQUENCE NO= 074 LAT= 37 39 40 N LONG= 97 44 15 W BCH-1= 0D522C VALID FIXED BITS= 110 POS SRC= EXT 121.5 MHz HOMING= YES NATL USE CODE= 100010 BCH-2= 535 VALID		
CLEAR	HOLD	DATA DUMP

406 BCN	RF I/O	BAT 1.20 Hr
FREQ= 406.0250 MHz TX PWR= 5.00 W MSG= 96E87B92922BC063548B3504422535 BEACON ID = 2DD0F725245780C COUNTRY= 366 U.S.A. NATL LOC PROTOCOL= ELT ORG/MFR ID= 0494 SEQUENCE NO= 074 LAT= 37 39 40 N LONG= 97 44 15 W BCH-1= 0D522C VALID FIXED BITS= 110 POS SRC= EXT 121.5 MHz HOMING= YES NATL USE CODE= 100010 BCH-2= 535 VALID		
CLEAR	HOLD	DATA DUMP

406 BCN	RF I/O	BAT 1.20 Hr
FREQ= 406.0250 MHz TX PWR= 5.00 W MSG= 96EF7B92922BC061B0E9B504422535 BEACON ID = 2DDEF725245780C COUNTRY= 366 U.S.A. NATL LOC PROTOCOL= TEST DATA-1= 10111101110010010100100 10001010111100000001100 BCH-1= 06C3A6 VALID DATA-2= 11010100000100010000100010 BCH-2= 535 VALID		
CLEAR	HOLD	DATA DUMP



FIELD	VALUE	DESCRIPTION	NOTES
MSG	30 hexadecimal characters (long message) or 22 hexadecimal characters (short message)	406 Beacon Message	
BEACON ID	15 hexadecimal characters	Beacon Identification	
COUNTRY	3 numeric code and characters	Country of Beacon Registration	
USER PROTOCOL	ELT - AVIATION SERIAL EPIRB - MMSI/CALL SIGN RADIO CALL SIGN TEST NATIONAL	User Structure of Encoded Data	
STD LOC PROTOCOL	TEST EPIRB - MMSI ELT - ADDRESS ELT - SERIAL EPIRB - SERIAL PLB - SERIAL ELT - DESIGNATOR	Standard Location Structure of Encoded Data	
NATL LOC PROTOCOL	ELT EPIRB PLB TEST	National Location Structure of Encoded Data	
REGISTRATION MARKING	7 alphanumeric characters	Aircraft Nationality and Registration Marking	
BEACON TYPE	AVIATION AIRCRAFT OPERATOR AIRCRAFT ADDRESS MARITIME - FLOAT FREE MARITIME - NON FLOAT FREE PERSONAL	Beacon Type of Serial User Protocol	
BEACON NO	2 numeric	Consecutive Serial Number for Each Beacon on that Vessel	Maritime User Protocol only
MMSI	7 numeric	Maritime Mobile Service Identity	Maritime User Protocol only

406 BEACON Message Fields
Table 2



FIELD	VALUE	DESCRIPTION	NOTES
MMSI/CALL SIGN	6 alphanumeric characters	Maritime Mobile Service Identity or Radio Call Sign	Maritime User Protocol only
RADIO CALL SIGN	7 alphanumeric characters	Radio Call Sign of User Protocol	
OPERATOR DESIGNATOR	3 letters	Identification of Aircraft Operator	
24-BIT ADDRESS	6 hexadecimal characters	24 bit Binary Code Assigned to the Aircraft	
SERIAL NO	4 to 7 numeric	Beacon Serial Number	
MFR ID NO	3 numeric	Manufacturer Identification Number	Serial User Protocol only
MFR SEQ NO	4 numeric	Manufacturer Sequence Number	Serial User Protocol only
MFR MODEL NO	2 numeric	Manufacturer Beacon Model Number	Serial User Protocol only
MFR RUN NO	3 numeric	Manufacturer Production Run Number	Serial User Protocol only
ORG/MFR ID	4 numeric	Organization or Manufacturer Identification	National Location Protocol only
SEQUENCE NO	3 numeric	Sequence Number	National Location Protocol only
FIXED BITS	3 to 5 binary bits	Set Binary Bits	
C/S TAC NO	4 numeric	Cospas-Sarsat Type Approval Certificate Number	Serial User/Location Protocol only
ELT NO	3 numeric	ELT number Assigned by Operator	ELT Designator Location Protocol only
ORG ID	3 numeric	Organization Identification	National Location Protocol only
ORG USE-1	38 or 46 binary bits	Organization Use	National Location Protocol only
ORG USE-2	6 or 26 binary bits	Organization Use	National Location Protocol only

406 BEACON Message Fields (cont)
Table 2



FIELD	VALUE	DESCRIPTION	NOTES
NATL USE	4 numeric	Assigning Serial Numbers on a National Basis	Serial User Protocol only
POS SRC	EXT INT	Position Data Source	
LAT	2, 2 numeric and 1 character	Latitude Data	
LONG	3, 2 numeric and 1 character	Longitude Data	
RADIO-LOCATING	NONE 121.5 MHz 9 GHz SART OTHER	Radio-Locating Transmitter in the Beacon	
BCH-1	5 hexadecimal characters and VALID INVALID	BCH Error-Correcting Code (First Protected Data Field)	
BCH-2	3 hexadecimal characters and VALID INVALID	BCH Error-Correcting Code (Second Protected Data Field)	
BEACON ACTIVATION	AUTO AND MANUAL MANUAL	Beacon Activation for both Auto and Manual or Manual only	
121.5 MHz HOMING	YES NO	121.5 MHz Radio-Locating Device	
EMERGENCY CODE	4 binary bits	Emergency Binary Code	
NATL USE CODE	4, 5 or 19 binary bits	Binary Code used by National Administrations	
ADDL ELT NO	2 numeric	If several ELTs carried in the same aircraft and encoded with the same 24-Bit address. Default to 0's when only 1 ELT is carried.	Serial User Protocol, ELT with 24-Bit Aircraft Address only
DATA-1	46 binary bits	First Binary Bits of Test Data	
DATA-2	25 binary bits (long message) 5 binary bits (short message)	Second Binary Bits of Test Data	

406 BEACON Message Fields (cont)
Table 2

4.3 GENERAL OPERATING INFORMATION

NOTE: The test procedures provided are to be used as guidelines. Users should always verify the test procedures and specifications with the UUT Manufacturer.

4.3.1 Startup Screen

Press the POWER Key on the IFR 4000 to display the Startup Screen.



After several seconds, the VOR Mode Screen is displayed.

4.3.2 Setup Menu

The Setup Menu contains parameters which determine the operational characteristics of the Test Set.

NOTE: Setup Menu information is entered before conducting test operations.

Refer to para 1-2-4.2.2 for a description of the Setup Menu Field Parameters and/or Values.

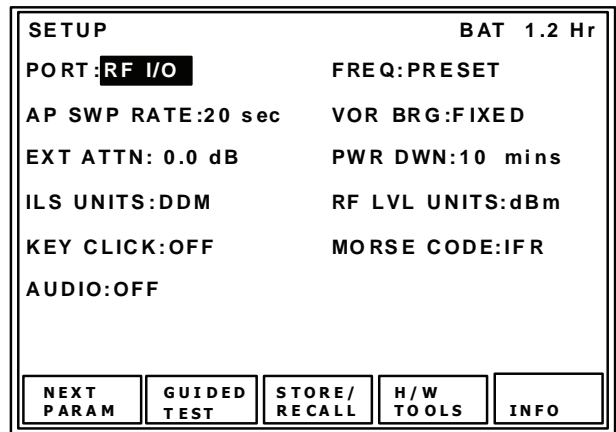

STEP	PROCEDURE
------	-----------

1. Press the SETUP Key to display the Setup Menu.
2. Use the NEXT PARAM Soft Key, INCREMENT/SELECT DATA Key and DECREMENT/SELECT DATA Key to set desired parameters.

4.3.3 VOR Mode

The VOR Mode is used for Ramp and Bench testing of VOR (VHF Omni Range) Receivers, either by direct connect to the RF I/O Connector or via the ANT Connector.

Refer to para 1-2-4.2.11 for a description of the VOR Mode Screen Field Parameters and/or Values.

VOR	RF I/O	BAT 1.2 Hr
FREQ: 108.000 MHz	RF LVL: - 50.0 dBm	
M MOD: CAL (60%)	MOD TONE: OFF	
BRG: 0.0 deg 30 Hz MOD: 30%	TO/FROM: TO 9960 Hz MOD: 30%	
TONE DEL:-		
30 MOD	9960 MOD	TONE DEL
	BRG	TO / FROM

STEP	PROCEDURE
------	-----------

1. Press the MODE Key until the VOR Mode Screen is displayed.
2. Utilize the FREQ (Frequency) Key, RF LVL (RF Level) Key, TONE Key, M MOD (Master Modulation) Key and displayed Soft Keys to set the Fields to the desired levels.

Channel Tests

The FREQ Field may be set to either:

PRESET provides three fixed selectable channels for each Mode: 108.00 MHz, 108.05 MHz and 117.95 MHz. Preset is used for quick confidence testing.

CHANNEL allows the selection of any on-channel frequency with the Mode band. Channel is used for testing of any 50 kHz spaced channel from 108.00 to 117.95 MHz.

Receiver Bandwidth Tests

The FREQ Field may be set to:

VAR allows the selection of the frequency from 107.00 to 118.00 MHz in 1 kHz increments to perform receiver bandwidth and adjacent channel tests.

Sensitivity Tests

Signal + Noise/Noise Ratio is a measure of receiver sensitivity.

When directly connected to a VOR Receiver the RF level is set for nominal 2 μ V (-101 dBm). The MOD TONE Field should be set to 1020 Hz and the receiver audio output adjusted for FSD on an Audio Power Meter. The M MOD Field is then toggled between 90% and 0%. RF Level is then adjusted for a 6 dB difference on the Audio Power Meter. The RF level in μ V should be \leq to the nominal figure of 2 μ V (-101 dBm).

Bearing Tests

VOR Bearing accuracy should be verified at 30° steps typically at an RF level of 100 μ V (-67 dBm) to an accuracy of $\pm 4^\circ$.

Automatic VOR uses an RMI (Radio Magnetic Indicator) to display relative bearing to the ground station. The RMI combines the VOR Bearing information with the magnetic compass heading to provide the relative bearing to the ground station.



RMI (Radio Magnetic Indicator)

4.3.3 VOR Mode (cont)

Bearing Tests (cont)

Manual VOR uses an OBS (Omni Bearing Selector) to set the desired radial and a CDI (Course Deviation Indicator) to display the deviation from the selected radial. This provides steer left or right information to aid the pilot.



**Combined OBS (Omni Bearing Selector) and
CDI (Course Deviation Indicator)**

The BRG Field is used to select each 30° step. For bench testing, the bearings may be selected in 0.1° steps.

When TO is selected in the TO/FROM Field, flying a bearing towards the ground station is simulated and the TO Flag should be in view on the CDI. When FROM is selected in the TO/FROM Field, flying a radial away from the ground station is simulated and the FROM Flag should be in view on the CDI.

Bearing accuracy should also be verified with the 1020 Hz tone selected at 30% over an RF level range of 10 μ V (-87 dBm) to 20 mV (-21 dBm).

Flag Tests

NAV Flag Tests typically should be conducted over an RF level range of 10 μ V (-87 dBm) to 20 mV (-17 dBm). The 30 Hz MOD Field should be set to 0% or use the TONE DEL Field to delete the tone. The Nav Flag should come into view on the CDI and/or RMI. This should be repeated for the 9960 Hz MOD.

4.3.4 LOCALIZER Mode

The LOCALIZER Mode is used for Ramp and Bench testing of Localizer Receivers, either by direct connect to the RF I/O Connector or via the ANT Connector.

Refer to para 1-2-4.2.12 for a description of the LOCALIZER Mode Screen Field Parameters and/or Values.

LOCALIZER	RF I/O	BAT 1.2 Hr
FREQ:108.100 MHz	RF LVL: - 50.0 dBm	
M MOD:CAL (40%)	MOD TONE: OFF	
DEV STEP:FIXED	90/ 150Hz: 0 deg	
LOC DDM: 0.000 CENTER	TONE DEL:-	
DEV STEP	TONE DEL	90 / 150Hz

- | STEP | PROCEDURE |
|------|---|
| 1. | Press the MODE Key until the LOCALIZER Mode Screen is displayed. |
| 2. | Utilize the FREQ (Frequency) Key, RF LVL (RF Level) Key, TONE Key, M MOD (Master Modulation) Key and displayed Soft Keys to set the Fields to the desired levels. |

Channel Tests

The FREQ Field may be set to either:

PRESET provides three fixed selectable channels for each Mode: 108.10 MHz, 108.15 MHz and 110.15 MHz. Preset is used for quick confidence testing.

CHANNEL allows the selection of any on-channel frequency with the Mode band. Channel is used for testing of any 50 kHz spaced channel from 108.10 to 111.95 MHz.

Receiver Bandwidth Tests

The FREQ Field may be set to:

VAR allows the selection of the frequency from 107.00 to 113.00 MHz in 1 kHz increments to perform receiver bandwidth and adjacent channel tests.

Sensitivity Tests

Signal + Noise/Noise Ratio is a measure of receiver sensitivity.

When directly connected to a VOR Receiver the RF level is set for nominal 2 μ V (-101 dBm). The MOD TONE Field should be set to 1020 Hz and the receiver audio output adjusted for FSD on an Audio Power Meter. The M MOD Field is then toggled between 70% and 0%. RF Level is then adjusted for a 6 dB difference on the Audio Power Meter. The RF level in μ V should be \leq to the nominal figure of 2 μ V (-101 dBm).

For Ramp Testing, the NAV Flag should be out of view with 5 μ V (-93 dBm) RF level applied to the Receiver.

Deviation DDM or μ A

For Ramp Testing, the FIXED DDM deviation selection is normally used.

DDM

FIXED provides CENTER, LEFT and RIGHT deviation selections at 0.00, 0.093, 0.155 and 0.200 DDM.

VAR provides CENTER, LEFT and RIGHT deviation selections from 0 to 0.4 DDM in 0.001 DDM steps.

For Bench Testing, the μ A deviation selection may be optionally used. (Example: 90 μ A deviation may be set and read directly on the Test Rig Localizer Deviation Micro-Ammeter.)

μ A

FIXED provides CENTER, LEFT and RIGHT deviation selections at 0, 90, 150 and 194 μ A.

VAR provides CENTER, LEFT and RIGHT deviation selections from 0 to 388 μ A in 1 μ A steps.

4.3.4 LOCALIZER Mode (cont)

Localizer Centering

Select 0 DDM (Center) and verify the CDI Localizer cross pointer is centered over an RF level of 10 μ V (-87 dBm) to 20 mV (-17 dBm).

Set the RF level to 1 mV (-47 dBm) and select the 1020 Hz Tone at 30%. Verify centering is maintained.

Select 10° phase shift in the 90/150 Hz Field. Use repeated presses of the 90/150 Hz Soft Key to switch the 10° phase shift in and out while verifying the centering is maintained.

This test simulates the phase shift between the 90 and 150 Hz Tones that occur when an Aircraft is turning to capture the Localizer beam. Predictable response is required with no sudden changes in Localizer deviation that may cause an Autopilot disconnect.

DDM Tests

Set the RF Level to 1 mV.

Using the LOC DDM Keys, select 0.093 DDM Left (Standard Deviation). Confirm CDI Localizer cross pointer indicates 3 Dots (90 μ A). (1-2-4, Figure 3)

Using the LOC DDM Keys, select 0.093 DDM Right (Standard Deviation). Confirm CDI Localizer cross pointer indicates 3 Dots (90 μ A). (1-2-4, Figure 3)

Using the LOC DDM Keys, select 0.155 DDM Left (Full Scale Deviation). Confirm CDI Localizer cross pointer indicates Full Scale (150 μ A). (1-2-4, Figure 3)

Using the LOC DDM Keys, select 0.155 DDM Right (Full Scale Deviation). Confirm CDI Localizer cross pointer indicates Full Scale (150 μ A). (1-2-4, Figure 3)

NOTE: For EFIS 2 1/2 Dot Deviation Displays, the first dot is 0.093 DDM and the second dot is 0.155 DDM (1-2-4, Figure 4). The EFIS system may also rescale the deviation to display a single dot just before the deviation is <1/2 dot.

Flag Tests

Confirm NAV Flag on the CDI is in view with no RF level applied to the Receiver.

Select 0 DDM (Center) and verify the NAV Flag remains out of view over an RF level of 30 μ V to 10 mV.

Set RF Level to 1 mV.

Delete the 150 Hz Tone, using the TONE DEL Field, and verify the NAV Flag is in view.

Delete the 90 Hz Tone, using the TONE DEL Field, and verify the NAV Flag is in view.



Analog CDI with 5 Dot ILS Deviation
Figure 3



EFIS with 2 1/2 Dot ILS Deviation
Figure 4

4.3.5 GLIDESLOPE Mode

The GLIDESLOPE Mode is used for Ramp and Bench testing of Glideslope Receivers, either by direct connect to the RF I/O Connector or via the ANT Connector.

Refer to para 1-2-4.2.13 for a description of the GLIDESLOPE Mode Screen Field Parameters and/or Values.

GLIDE SLOPE	RF I/O	BAT 1.2 Hr
FREQ:334.700 MHz	RF LVL: - 50.0 dBm	
LOC FREQ:108.100 MHz		
M MOD:CAL (80%)		
DEV STEP: FIXED	90/ 150Hz:-	
	G/S DDM:	
	0.091 DOWN	
	TONE DEL:-	
DEV STEP	TONE DEL	90 / 150Hz

- | STEP | PROCEDURE |
|------|---|
| 1. | Press the MODE Key until the GLIDESLOPE Mode Screen is displayed. |
| 2. | Utilize the FREQ (Frequency) Key, RF LVL (RF Level) Key, TONE Key, M MOD (Master Modulation) Key and displayed Soft Keys to set the Fields to the desired levels. |

Channel Tests

The FREQ Field may be set to either:

PRESET provides three fixed selectable channels for each Mode: 334.25 MHz, 334.55 MHz and 334.70 MHz. Preset is used for quick confidence testing.

CHANNEL allows the selection of any on-channel frequency with the Mode band. Channel is used for testing of any 50 kHz spaced channel from 329.15 to 335.00 MHz.

Receiver Bandwidth Tests

The FREQ Field may be set to:

VAR allows the selection of the frequency from 327.00 to 337.00 MHz in 1 kHz increments to perform receiver bandwidth and adjacent channel tests.

Sensitivity Tests

When directly connected to a Glideslope Receiver, the NAV Flag should be out of view with an RF level of 20 μ V applied.

Deviation DDM or μ A

For Ramp Testing, the FIXED DDM deviation selection is normally used.

DDM

FIXED provides CENTER, LEFT and RIGHT deviation selections at 0.00, 0.091, 0.175 and 0.400 DDM.

VAR provides CENTER, LEFT and RIGHT deviation selections from 0 to 0.8 DDM in 0.001 DDM steps.

For Bench Testing, the μ A deviation selection may be optionally used. (Example: 78 μ A deviation may be set and read directly on the Test Rig Glideslope Deviation Micro-Ammeter.)

μ A

FIXED provides CENTER, LEFT and RIGHT deviation selections at 0, 78, 150 and 343 μ A.

VAR provides CENTER, LEFT and RIGHT deviation selections from 0 to 686 μ A in 1 μ A steps.

Glideslope Centering

Select 0 DDM (Center) and verify the CDI Localizer cross pointer is centered over an RF level of 75 μ V (-69 dBm) to 10 mV (-27 dBm).

Set the RF Level to 700 μ V (-50 dBm) and select 12° phase shift in the 90/150 Hz Field. Use repeated presses of the 90/150 Hz Soft Key to switch the 12° phase shift in and out while verifying the centering is maintained.

This test simulates the phase shift between the 90 and 150 Hz Tones that occur when an Aircraft is turning to capture the Glideslope beam. Predictable response is required with no sudden changes in Glideslope deviation that may cause an Autopilot disconnect.

4.3.5 GLIDESLOPE Mode (cont)

DDM Tests

Set the RF level to 700 μ V (-50 dBm).

Using the G/S DDM Keys, select 0.091 DDM Up (Standard Deviation). Confirm CDI Glideslope cross pointer indicates 3 Dots (78 μ A). (1-2-4, Figure 3)

Using the G/S DDM Keys, select 0.091 DDM Down (Standard Deviation). Confirm CDI Glideslope cross pointer indicates 3 Dots (78 μ A). (1-2-4, Figure 3)

Using the G/S DDM Keys, select 0.175 DDM Up (Full Scale Deviation). Confirm CDI Glideslope cross pointer indicates Full Scale (150 μ A). (1-2-4, Figure 3)

Using the G/S DDM Keys, select 0.175 DDM Down (Full Scale Deviation). Confirm CDI Glideslope cross pointer indicates Full Scale (150 μ A). (1-2-4, Figure 3)

NOTE: For EFIS 2 ½ Dot Deviation Displays, the first dot is 0.091 DDM and the second dot is 0.175 DDM (1-2-4, Figure 4). The EFIS system may also rescale the deviation to display a single dot just before the deviation is <1/2 dot.

Flag Tests

Confirm GS Flag on the CDI is in view with no RF level applied to the Receiver.

Select 0 DDM (Center) and verify the GS Flag remains out of view over an RF level of 75 μ V (-69 dBm) to 10 mV (-27 dBm).

Set the RF level to 700 μ V (-50 dBm).

Delete the 150 Hz Tone, using the TONE DEL Field, and verify the GS Flag is in view.

Delete the 90 Hz Tone, using the TONE DEL Field, and verify the GS Flag is in view.

4.3.6 MARKER BEACON Mode

The MARKER BEACON Mode is used for Ramp and Bench testing of Marker Beacon Receivers, either by direct connect to the RF I/O Connector or via the ANT Connector.

Refer to para 1-2-4.2.14 for a description of the MARKER BEACON Mode Screen Field Parameters and/or Values.

MARKER BEACON	RF I/O	BAT 1.2 Hr
FREQ: 75.000 MHz	RF LVL: - 50.0 dBm	
M MOD: CAL (0%)	MOD TONE: OFF	

Sensitivity Tests

The Marker Beacon Receiver has two sensitivity levels (Low and High).

Typically the Low sensitivity level is 1500 μ V (-43 dBm) for an aural identification of the airways marker or 'Z' marker 3000 Hz tone (white lamp). This sensitivity is normally selected above 10K ft and ensures that the middle and inner marker tones are not heard and the lamps are not illuminated.

The High sensitivity level is used on ILS approaches and is typically 200 μ V (-61 dBm) for an aural identification of the outer marker 400 Hz tone (blue lamp) and the middle marker 1300 Hz tone (amber lamp).

Marker Tones and Lamps Test

When directly connected to the Marker Beacon Receiver, select an RF Level of 1500 μ V (-43 dBm) and select the 3000 Hz MOD TONE. Confirm the white airways marker lamp is illuminated and a 3000 Hz tone is present in the Receiver's audio output.

Select an RF Level of 200 μ V (-61 dBm) and select the 400 Hz MOD TONE. Confirm the blue outer marker lamp is illuminated and a 400 Hz tone is present in the Receiver's audio output.

Select an RF Level of 200 μ V (-61 dBm) and select the 1300 Hz MOD TONE. Confirm the amber middle marker lamp is illuminated and a 1300 Hz tone is present in the Receiver's audio output.

STEP	PROCEDURE
1.	Press the MODE Key until the MARKER BEACON Mode Screen is displayed.
2.	Utilize the FREQ (Frequency) Key, RF LVL (RF Level) Key, TONE Key, M MOD (Master Modulation) Key and displayed Soft Keys to set the Fields to the desired levels.

Channel Tests

The FREQ Field may be set to either:

PRESET provides three fixed selectable channels for each Mode: 74.50 MHz, 75.00 MHz and 75.50 MHz. Preset is used for quick confidence testing.

CHANNEL allows the selection of any on-channel frequency with the Mode band. Channel is used for testing of any 25 kHz spaced channel from 72.00 to 78.00 MHz.

Receiver Bandwidth Tests

The FREQ Field may be set to:

VAR allows the selection of the frequency from 72.00 to 78.00 MHz in 1 kHz increments to perform receiver bandwidth tests.

4.3.7 ILS Mode

The ILS Mode is used for Ramp testing of Localizer/Glideslope Receivers under Autopilot Coupled conditions, either by direct connect to the RF I/O Connector or via the ANT Connector.

Operation is identical to the individual Localizer and Glideslope Modes. The FREQ (Localizer) and G/S FREQ Fields are paired together. The Localizer RF Level is fixed at -22 dBm on the RF I/O Connector and at 0 dBm on the ANT Connector (-7 dBm if Marker Beacon is also activated). If any Marker Beacon Tone is selected in the MOD TONE Field, the Marker Beacon signal source is activated on the ANT Connector at a fixed RF Level of +13 dBm.

Refer to para 1-2-4.2.15 for a description of the ILS Mode Screen Field Parameters and/or Values.

ILS	RF I/O	BAT 1.2 Hr
FREQ: 108.100 MHz	RF LVL: - 50.0 dBm	
G/S FREQ: 334.700 MHz		
M MOD: CAL (80%)	MOD TONE: OFF	
AP SWP: OFF		
DEV STEP: FIXED	90/150 Hz: 0 deg	
LOC DDM: 0.000 CENTER	G/S DDM: 0.000 CENTER	
	TONE DEL:-	
DEV STEP	AP SWP	TONE DEL
		90 / 150Hz

Auto Pilot Coupled Testing

With the AP SWP Field set to START RIGHT or START LEFT, the Localizer deviation can be swept over a maximum 30 μ A range. The deviation is set in the LOC DEV Field. The sweep may start from left or right. The sweep rate default is 20 seconds, but the sweep rate may be changed in the Setup Menu.

When the ILS Receiver deviation outputs are coupled to an Autopilot, the IFR 4000 may be used to simulate an Aircraft drifting off the Localizer beam. The Autopilot corrective responses may be examined (i.e., control surfaces are moving smoothly and servo's are operating correctly).

The Glideslope RF LVL is variable from -22 to -100 dBm on the RF I/O Connector, 0 to -76 dBm on the ANT Connector and -7 to -83 dBm if the Marker Beacon is activated.

STEP	PROCEDURE
------	-----------

1. Press the MODE Key until the ILS Mode Screen is displayed.
2. Utilize the FREQ (Frequency) Key, RF LVL (RF Level) Key, TONE Key, M MOD (Master Modulation) Key and displayed Soft Keys to set the Fields to the desired levels.

4.3.8 COMM AM Mode

The COMM AM Mode is used primarily for Ramp and Bench testing of Aeronautical VHF AM (118.00 to 156.00 MHz) Communication Transceivers and also Military UHF AM (225.00 to 400.00 MHz) Communication Transceivers, either by direct connect to the RF I/O Connector or via the ANT Connector.

Refer to para 1-2-4.2.16 for a description of the COMM AM Mode Screen Field Parameters and/or Values.

COMM AM	RF I/O	BAT 1.2 Hr
FREQ: 118.0000 MHz	RF LVL: - 50.0 dBm	
M MOD: CAL (30%)	MOD TONE: 1020 Hz	
CHNL SP: 25 kHz		
PWR MTR: PEAK	RECEIVING	

TX FREQ==	TX PWR==	
TX MOD ==		
CHNL SP	HOLD CLEAR	SWITCH GEN/RX
	ZERO	POWER METER

STEP	PROCEDURE
1.	Press the MODE Key until the COMM AM Mode Screen is displayed.
2.	Utilize the FREQ (Frequency) Key, RF LVL (RF Level) Key, TONE Key, M MOD (Master Modulation) Key and displayed Soft Keys to set the Fields to the desired levels.

Channel Tests

The FREQ Field may be set to either:

PRESET provides three fixed selectable channels for each band of operation:

VHF

118.00 MHz, 137.00 MHz and 156.00 MHz

UHF

225.00 MHz, 312.00 MHz and 400.00 MHz

Preset is used for quick confidence testing.

CHANNEL allows the selection of any on-channel frequency with the Mode band. Channel is used for testing of any 8.33 kHz spaced channel from 118.00 to 156.00 MHz or any 25 kHz spaced channel from 10.00 to 400.00 MHz.

Receiver Bandwidth Tests

The FREQ Field may be set to:

VAR allows the selection of the frequency from 117.00 to 401.00 MHz in 1 kHz increments to perform receiver bandwidth tests.

If MOD STRIKE 2 on Mod Strike Label is checked and the unit is loaded with Version 2.06 Software, VAR allows the selection of the frequency from 10.00 to 410.00 MHz in 1 kHz increments.

Sensitivity Tests

Signal + Noise/Noise Ratio is a measure of receiver sensitivity.

When directly connected to a COMM (AM) Receiver (ARINC 750), the RF level is set for nominal 2 μ V (-101 dBm). The MOD TONE Field should be set to 1020 Hz and the receiver audio output adjusted for FSD on an Audio Power Meter. The M MOD Field is then toggled between 30% and 0%. RF Level is then adjusted for a 6 dB difference on the Audio Power Meter. The RF level in μ V should be \leq to the nominal figure of 2 μ V (-101 dBm).

Another Sensitivity Test is SINAD (Signal to Noise And Distortion). The receiver requires a 12 dB SINAD modulated signal in order to reduce the noise and distortion by 12 dB. SINAD is preferred because it takes into account distortion, while Signal + Noise/Noise Ratio only deals with noise. A SINAD Meter is an AC Voltmeter that has a notch filter to remove the 1 kHz fundamental audio tone, leaving just the noise and distortion. The SINAD Meter is driven by a differential amplifier such that it displays the difference between the audio *with* the tone, and the audio *without* the tone (i.e. just the noise and distortion).

4.3.8 COMM AM Mode (cont)

Transmitter Tests

The TX PWR Field displays the transmitter power received (0.1 to 30 W) over the RF I/O Connector.

CAUTION: OBSERVE DUTY CYCLE LIMITS:

≤10 W IS CONTINUOUS
OVERTEMP WARNING

>10 W TO ≤20 W IS
3 MIN ON - 2 MIN OFF
OVERTEMP WARNING

>20 W TO ≤30 W IS
1 MIN ON - 2 MIN OFF
OVERTEMP WARNING

The GEN/RX Field indicates if the Test Set is in Generate or Receive Mode. Press the GEN/RX Soft Key to toggle the channel spacing from GENERATING to RECEIVING.

NOTE: The Test Set does not automatically switch to RECEIVING when transmitter power is present at the RF I/O Connector.

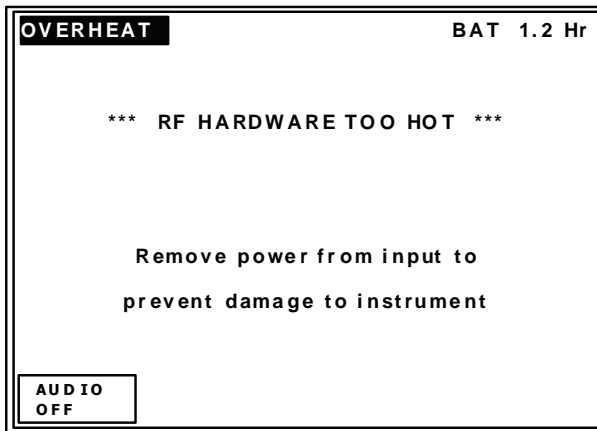

NOTE: The Power Monitor range and duration may be extended by the adding an External Attenuator to the RF I/O Connector.

The value of the External Attenuator should be entered in the EXT ATTN Field of the Setup Menu.

The displayed Power Reading takes into account any external attenuation.

The TX MOD Field displays the Transmitter Modulation Depth received (0% to 99%) over the RF I/O Connector or via the ANT Connector.

The CHNL SP Field displays the signal generator channel spacing. Press the CHNL SP Soft Key to toggle the channel spacing from 8.33 to 25 kHz. VHF Comm Transceivers operating in Europe may have selected 8.33 kHz channels.

4.3.9 COMM FM Mode

The COMM FM Mode is used primarily for Ramp and Bench testing of FM Communication Transceivers (10.00 to 400.00 MHz), either by direct connect to the RF I/O Connector or via the ANT Connector.

Refer to para 1-2-4.2.17 for a description of the COMM FM Mode Screen Field Parameters and/or Values.

COMM FM	RF I/O	BAT 1.2 Hr
FREQ: 156.0000 MHz	RF LVL: - 50.0 dBm	
M DEV: CAL (5 kHz)	MOD TONE: 1000 Hz	
CHNL SP: 12.5 kHz		
PWR MTR: PEAK	RECEIVING	

TX FREQ==	TX PWR==	
TX DEV ==		
HOLD TX		
CHNL SP	HOLD/CLEAR	SWITCH GEN/RX
	ZERO	POWER METER

- | STEP | PROCEDURE |
|------|---|
| 1. | Press the MODE Key until the COMM FM Mode Screen is displayed. |
| 2. | Utilize the FREQ (Frequency) Key, RF LVL (RF Level) Key, TONE Key, M MOD (Master Modulation) Key and displayed Soft Keys to set the Fields to the desired levels. |

Channel Tests

The FREQ Field may be set to either:

PRESET provides four fixed selectable channels for each Mode: 156.00 MHz, 165.00 MHz, 167.50 MHz and 174.00 MHz. Preset is used for quick confidence testing.

CHANNEL allows the selection of any on-channel frequency with the Mode band. Channel is used for testing of any 12.5 or 25 kHz spaced channel from 10.00 to 400.00 MHz.

Receiver Bandwidth Tests

The FREQ Field may be set to:

VAR allows the selection of the frequency from 155.00 to 401.00 MHz in 1 kHz increments to perform receiver bandwidth tests.

If MOD STRIKE 2 on Mod Strike Label is checked and the unit is loaded with Version 2.06 Software, VAR allows the selection of the frequency from 10.00 to 410.00 MHz in 1 kHz increments.

Sensitivity Tests

Two methods of Sensitivity Measurement are available:

FM Quieting

To measure 20 dB quieting, connect an Audio Power Meter to the Receiver audio output. With no signal into the Receiver, open the squelch.

Adjust the Receiver audio level for FSD (or a reference level) on the Audio Power Meter. This is the base noise reading. Press the POWER Key on the IFR 4000 and adjust the RF Level for a reading on the Audio Power Meter that is 20 dB less than FSD or the reference level. The RF Level setting is the 20 dB Quieting Figure.

SINAD:

To measure 12 dB SINAD, connect the SINAD Meter to the Receiver audio output. Adjust the Receiver audio level on the Receiver to a level that is compatible with the SINAD Meter (most SINAD Meters are auto-ranging and auto-nulling, so this usually isn't too critical). Generate a signal on the receive channel, modulated with a 1000 Hz tone at 3 kHz deviation. Adjust the RF output level of the Signal Generator until the SINAD Meter reads 12 dB.

The MOD TONE Field controls the selection of a 1000 Hz Tone. Repeated presses of the TONE Key toggles the MOD TONE Field between OFF and 1000 Hz.

To measure 12 dB SINAD, connect the SINAD Meter to the Receiver audio output. Adjust the Receiver audio level on the Receiver to a level that is compatible with the SINAD Meter (most SINAD Meters are auto-ranging and auto-nulling, so this usually isn't too critical). Generate a signal on the receive channel, modulated with a 1020 Hz tone at 30% Modulation depth. Adjust the RF output level of the IFR 4000 until the SINAD Meter reads 12 dB.

4.3.9 COMM FM Mode (cont)

Transmitter Tests

The TX PWR Field displays the transmitter power received (0.1 to 30 W) over the RF I/O Connector.

CAUTION: OBSERVE DUTY CYCLE LIMITS:

≤10 W IS CONTINUOUS
OVERTEMP WARNING

>10 W TO ≤20 W IS
3 MIN ON - 2 MIN OFF
OVERTEMP WARNING

>20 W TO ≤30 W IS
1 MIN ON - 2 MIN OFF
OVERTEMP WARNING

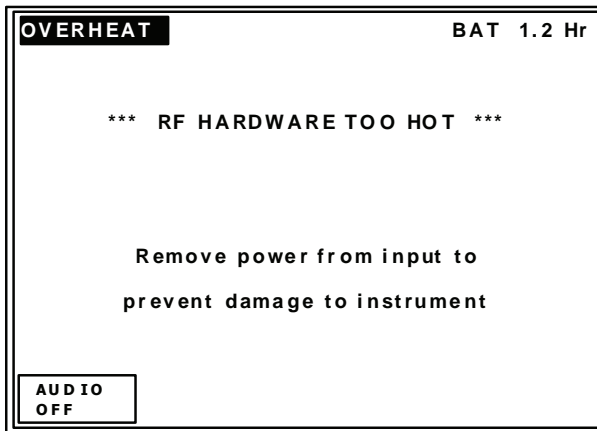

NOTE: The Power Monitor range and duration may be extended by the adding an External Attenuator to the RF I/O Connector.

The value of the External Attenuator should be entered in the EXT ATTN Field of the Setup Menu.

The displayed Power Reading takes into account any external attenuation.

The TX DEV Field displays the transmitter Deviation, received (0 to 15 kHz) over the RF I/O Connector or via the ANT Connector.

NOTE: The Test Set does not automatically switch to RECEIVING when transmitter power is present at the RF I/O Connector.

4.3.10 COMM SSB Mode

The COMM SSB Mode is used for Ramp and Bench testing of SSB HF Communication Transceivers (10.00 to 30.00 MHz), either by direct connect to the RF I/O Connector or via the ANT Connector.

The COMM SSB Mode Screen is only displayed when MOD STRIKE 2 on Mod Strike Label is checked and the unit is loaded with Version 2.06 Software.

Refer to para 1-2-4.2.18 for a description of the COMM SSB Mode Screen Field Parameters and/or Values.

COMM SSB	RF I/O	BAT 1.2 Hr
FREQ: 10.0000 MHz	RF LVL: - 50.0 dBm	
SIDE BAND: UPPER	MOD TONE: 1000 Hz	
RECEIVING		

TX FREQ=-	TX PWR=-	
AUDIO FREQ =-		
HOLD TX		
HOLD/ CLEAR	SWITCH GEN/RX	ZERO
		POWER METER

STEP	PROCEDURE
------	-----------

1. Press the MODE Key until the COMM SSB Mode Screen is displayed.
2. Utilize the FREQ (Frequency) Key, RF LVL (RF Level) Key, TONE Key, M MOD (Master Modulation) Key and displayed Soft Keys to set the Fields to the desired levels.

Receiver Bandwidth Tests

The FREQ Field may be set to:

VAR allows the selection of the frequency from 10.00 to 30.00 MHz in 100 Hz increments to perform receiver bandwidth tests.

Sensitivity Tests

Signal + Noise/Noise Ratio is a measure of receiver sensitivity.

When directly connected to an HF COMM Receiver (ARINC 753), the RF level is set for nominal 1 μ V (-107 dBm) and the AGC function on the Receiver should be turned OFF. The MOD TONE Field should be set to 1000 Hz and the receiver audio output adjusted for FSD on an Audio Power Meter. The IFR 4000 is toggled between Receive and Generate. RF Level is then adjusted for a 10 dB difference on the Audio Power Meter. The RF level in μ V should be \leq to the nominal figure of 1 μ V (-107 dBm).

Another Sensitivity Test is SINAD (Signal to Noise And Distortion). The receiver requires a 12 dB SINAD modulated signal in order to reduce the noise and distortion by 12 dB. SINAD is preferred for yaking into account distortion, while Signal + Noise/Noise Ratio only deals with noise. A SINAD Meter is an AC Voltmeter with a notch filter to remove the 1 kHz fundamental audio tone, leaving just the noise and distortion. The SINAD Meter is driven by a differential amplifier to display the difference between audio *with* the tone, and audio *without* the tone (i.e. just noise and distortion).

To measure 12 dB SINAD, connect the SINAD Meter to the Receiver audio output. Adjust the Receiver audio level on the Receiver to a level that is compatible with the SINAD Meter (most SINAD Meters are auto-ranging and auto-nulling, so this usually isn't too critical). Generate a signal on the receive channel, modulated with a 1000 Hz tone. Adjust the RF output level of the IFR 4000 until the SINAD Meter reads 12 dB.

4.3.10 COMM SSB Mode (cont)

Transmitter Tests

The TX PWR Field displays the transmitter power received (0.1 to 30 W) over the RF I/O Connector.

NOTE: The Test Set does not automatically switch to RECEIVING when transmitter power is present at the RF I/O Connector.

CAUTION: OBSERVE DUTY CYCLE LIMITS:

≤10 W IS CONTINUOUS
OVERTEMP WARNING

>10 W TO ≤20 W IS
3 MIN ON - 2 MIN OFF
OVERTEMP WARNING

>20 W TO ≤30 W IS
1 MIN ON - 2 MIN OFF
OVERTEMP WARNING

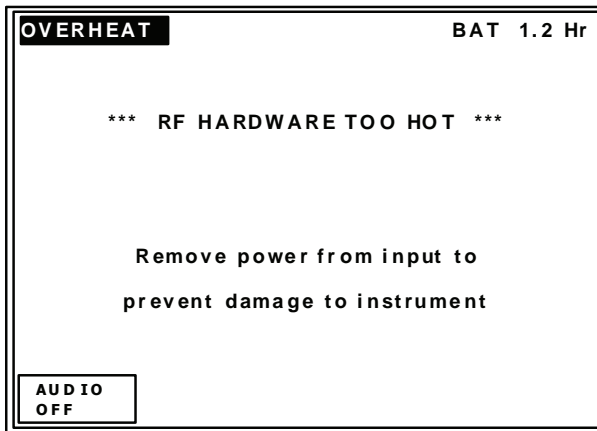

NOTE: The Power Monitor range and duration may be extended by the adding an External Attenuator to the RF I/O Connector.

The value of the External Attenuator should be entered in the EXT ATTN Field of the Setup Menu.

The displayed Power Reading takes into account any external attenuation.

The AUDIO FREQ Field displays the SSB Transmitter USB or LSB Audio Frequency Modulation (1 to 5000 Hz) received over the RF I/O Connector or via the ANT Connector.

The GEN/RX Field indicates if the Test Set is in Generate or Receive Mode. Press the GEN/RX Soft Key to toggle the channel spacing from GENERATING to RECEIVING.

4.3.11 SWR Mode

The SWR Mode is used for testing of installed Antennas and Feeders (10.00 to 400.00 MHz), by direct connect to the SWR Connector.

Refer to para 1-2-4.2.20 for a description of the SWR Mode Screen Field Parameters and/or Values.

Two Modes of SWR measurement are available: CW SWR and SWEPT SWR.

4.3.11.1 CW SWR Mode

Static SWR measurement is made at the selected frequency and displayed numerically.

The FREQ Field controls the CW signal generator frequency used for the static SWR measurement.

The SWR Field displays the measured SWR.

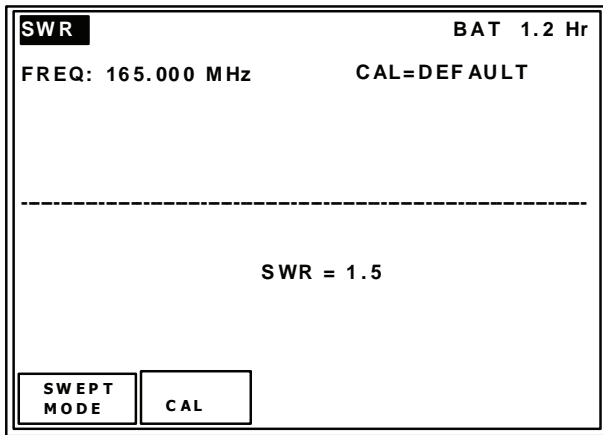

STEP	PROCEDURE
1.	Press the MODE Key until the SWR Mode Screen is displayed.
2.	Press the FREQ Key to access the FREQ Field.

Antenna + Feeder SWR

Following is the typical maximum SWR figures for an installed antenna system. Consult the System Manufacturer for specific limits.

ILS/VOR:	108.00 to 112.00 MHz	<5:1
G/S:	328.60 to 335.40 MHz	<5:1
VHF Comm:	118.00 to 136:00 MHz	<1.5:1
Marker Beacon:	75.00 MHz	<2.5:1
UHF Comm:	225.00 to 400 MHz	<1.5:1

4.3.11.2 SWEPT SWR Mode

SWR measurement made over the selected sweep range and graphically plotted.

The START FREQ Field controls the signal generator start frequency for the swept SWR plot.

The STOP FREQ Field controls the signal generator stop frequency for the swept SWR plot.

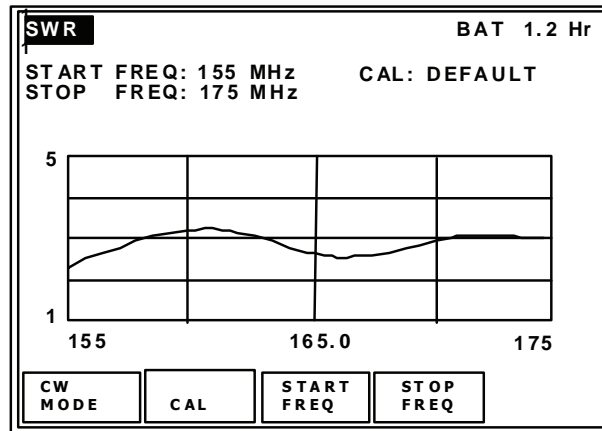

STEP	PROCEDURE
1.	Press the MODE Key until the SWR Mode Screen is displayed.
2.	Press the SWEPT Soft Key to display the SWEPT SWR Screen.
3.	Press the START FREQ Field to access the START FREQ Field. Use the INCREMENT/SELECT Data Key or the DECREMENT/SELECT Data Key to set the signal generator start frequency for the swept SWR plot.
4.	Press the STOP FREQ Field to access the STOP FREQ Field. Use the INCREMENT/SELECT Data Key or the DECREMENT/SELECT Data Key to set the signal generator stop frequency for the swept SWR plot.

NOTE: After setting the start and stop frequencies, the SWR is automatically plotted.

4.3.12 SELCAL Mode

The SELCAL Mode is used for testing of Aeronautical VHF Communication Transceivers with Selective Calling Capability conforming to ARINC 596. Two SELCAL Test Modes are available:

Refer to para 1-2-4.2.21 for a description of the SELCAL Mode Screen Field Parameters and/or Values.

What is SELCAL?

The Selective Calling (SELCAL) System allows a Ground Station to call an Aircraft or group of Aircraft using VHF or HF Comm Transmitters, without the flight crew having to continuously monitor the station frequency.

A coded signal is transmitted from the ground and received by the VHF or HF Receiver tuned to the appropriate frequency. The output code is fed to a SELCAL Decoder which activates aural and visual alerts if and only if the received code corresponds to the code selected in the Aircraft.

Each transmitted code is made up of two RF bursts (pulses), each 1 sec (± 0.25 sec), separated by a period of 0.2 sec (± 0.1 sec). During each pulse the transmitted carrier is 80% modulated with two tones for a total of four tones per call; the frequencies of the tones determine the code.

The tones are designated by the letters A to S omitting I, N and O. (A typical code may be AK-DM.) There are 10920 codes available. Codes or blocks of codes are assigned on request to Air Carrier Organizations. The Air Carrier Organizations assign codes to the Aircraft on a flight number basis or an Aircraft registration basis.

General

The SELCAL TONE Field allows the tone pulse pairs to be selected. Press SEL TONE Soft Key to access the SELCAL TONE Field. Use the INCREMENT/SELECT Data Key or the DECREMENT/SELECT Data Key to select the required tone letter. Repeat for additional pulse pairs.

The TX Mode Field allows the selection of SINGLE or CONTINUOUS tone pulse pair transmission. SINGLE is used for normal operation and CONTINUOUS is used for troubleshooting the decode circuit.

4.3.12.1 SINGLE Mode

SELCAL	RF I/O	BAT 1.2 Hr
FREQ: 118.000 MHz	RF LVL: - 50.0 dBm	
M MOD: CAL (80%)	SELCAL TONE: AB-CD	
TX MODE: SINGLE		
SEL TONE	TX MODE	START

- | STEP | PROCEDURE |
|------|---|
| 1. | Press the MODE Key until the SELCAL Mode Screen is displayed. |
| 2. | Press the TX MODE Soft Key to set the TX MODE to SINGLE. |
| 3. | Utilize the FREQ (Frequency) Key, RF LVL (RF Level) Key, TONE Key, M MOD (Master Modulation) Key and displayed Soft Keys to set the Fields to the desired levels. |
| 4. | Press the START Soft Key to send a SELCAL tone pair burst. |
- NOTE:** The word "TRANSMITTING" is briefly displayed at the bottom of the SELCAL Screen after pressing the START Soft Key.

SELCAL	RF I/O	BAT 1.2 Hr
FREQ: 118.000 MHz	RF LVL: - 50.0 dBm	
M MOD: CAL (80%)	SELCAL TONE: AB-CD	
TX MODE: SINGLE		
TRANSMITTING		

4.3.12.2 CONTINUOUS Mode

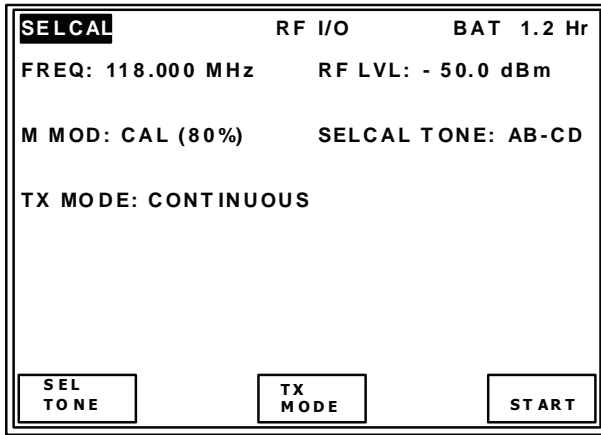

STEP	PROCEDURE
------	-----------

1. Press the MODE Key until the SELCAL Mode Screen is displayed.
2. Press the TX MODE Soft Key to set the TX MODE to CONTINUOUS.
3. Utilize the FREQ (Frequency) Key, RF LVL (RF Level) Key, TONE Key, M MOD (Master Modulation) Key and displayed Soft Keys to set the Fields to the desired levels.
4. Press the START Soft Key to start tone pulse pair transmission.

NOTE: The word "TRANSMITTING" is briefly displayed at the bottom of the SELCAL Screen after pressing the START Soft Key.

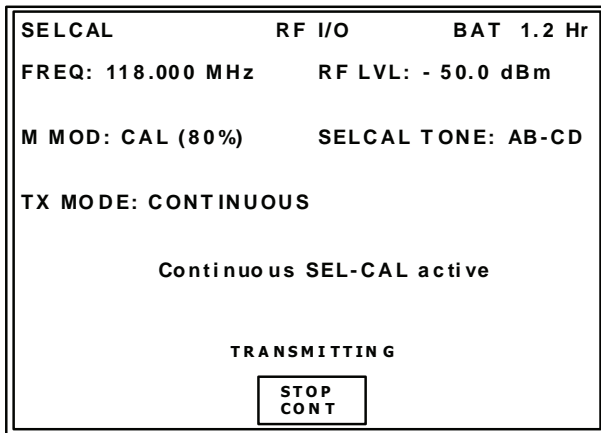

5. Press the STOP CONT Soft Key to stop transmission of tone pulse pairs.

4.3.13 FREQUENCY COUNTER Mode

The FREQUENCY COUNTER Mode provides a general purpose Frequency Counter using the AUX I/O Connector as a signal input. The measurement range is 1 to 10 MHz.

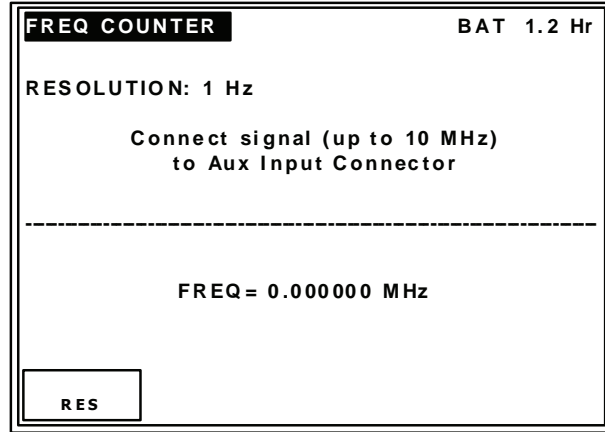

STEP	PROCEDURE
------	-----------

1. Press the MODE Key until the Frequency Counter Screen is displayed.
2. Press the RES Soft Key to access the RES (Resolution) Field. Use the INCREMENT/SELECT Data Key or the DECREMENT/SELECT Data Key to set frequency counter resolution to 1 Hz, 10 Hz, 100 Hz or 1 kHz.

4.3.14 121.5/243 BEACON Mode (p/o ELT Option)

The 121.5/243 BEACON Mode is used for Ramp and Bench testing of Short Range Swept Tone Emergency Beacons, either by direct connect to the RF I/O Connector or via the ANT Connector.

The 4000 is capable of performing the mandatory tests defined in FAR 91.207(d).

NOTE: Always refer to the Beacon Manufacturer's Test Documentation for specific tests.

Refer to para 1-2-4.2.23 for a description of the 121.5/243 BEACON Mode Screen Field Values.

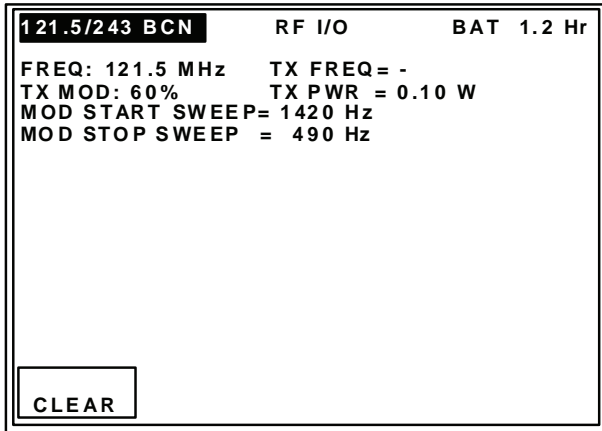

Typical short range beacon specifications are:

PERP

Between 50 and 500 mw (depending on type)

Carrier Frequency

121.5 MHz (± 6.075 kHz) and 243 MHz (± 12.15 kHz)

AM Modulation

>85% (0.85 modulation factor)

Modulation Duty Cycle

Min = 33%, Max = 55%

Swept Tone Range

> 700 Hz

Start/Stop Frequencies

300 to 1600 Hz (typically)

Sweep Repetition Rate

2 to 4 Hz

To aid SAR system detection and homing capabilities, the transmission may also provide a period of unmodulated CW power for a duration of 2.0 sec (± 0.25 sec), repeated every 8.0 sec (± 0.8 sec).

CAUTION: ENSURE THE BEACON IS DIRECTLY CONNECTED TO THE RF I/O CONNECTOR BEFORE ACTIVATING.

CAUTION: IF TESTING THE RADIATED SIGNAL VIA THE ANT CONNECTOR, ALWAYS PERFORM THE TESTS WITHIN THE FIRST 5 MINUTES OF THE HOUR (UTC).

CAUTION: ENSURE NOT MORE THAN THREE SWEEPS ARE TRANSMITTED OR CONDUCT THE TESTING IN AN RF SHIELDED ROOM.

CAUTION: IF PERFORMING AN RADIATED TEST WITH A BEACON THAT HAS 406 MHz CAPABILITY, DO NOT ALLOW THE TEST DURATION TO EXCEED 5 SEC.

CAUTION: THE BEACON TRANSMITS A 406 MHz SIGNAL ≈ 45 SEC AFTER THE BEACON IS ACTIVATED.

CAUTION: THE SATELLITE SYSTEM CONSIDERS THIS TRANSMISSION TO BE A VALID DISTRESS SIGNAL.

4.3.15 406 BEACON Mode (p/o ELT Option)

The 406 BEACON Mode is used for Ramp and Bench testing of 406 MHz long range position reporting beacons, either by direct connect to the RF I/O Connector or via the ANT Connector.

The IFR 4000 is capable of performing the mandatory tests defined in FAR 91.207(d).

NOTE: Always refer to the Beacon Manufacturer's Test Documentation for specific tests.

Refer to 1-2-4, Table 2 for a description of the 406 BEACON Mode Screen Field Values.

406 BCN	RF I/O	BAT 1.20 Hr
FREQ= 406.0250 MHz TX PWR= 5.00 W		
MSG= 16E47B92922BC061D42FF5		
BEACON ID= 2DC8F725245780C		
COUNTRY= 366 U.S.A.		
STD LOC PROTOCOL= ELT - SERIAL		
C/S TAC NO= 0494		
SERIAL NO= 04754		
LAT= 43 45 00 N LONG= 003 00 00 W		
BCH-1= 0750BF VALID		
FIXED BITS= 1101 POS SRC= EXT		
121.5 MHz HOMING= YES		
CLEAR	HOLD	DATA DUMP

The 406 MHz Beacons conform primarily to COSPAS/SARSAT Specification C/S T.001 and Aeronautical Beacons (ELT's) also conform to the specification defined in RTCA/DO-204 and EUROCAE ED62.

PERP

37.0 dBm (5 W) (± 2 dBm)

Carrier Frequency

406.025 MHz (± 2.0 kHz) (Initial)
406.025 MHz (± 5.0 kHz) (5 years)

Modulation

Bi-Phase L

4.4 GUIDED TEST

The IFR 4000 provides a Guided Test function which allows instrument setups to be stored in the Test Set non-volatile memory as a sequence, under a user specified name. The sequence may be recalled and played backwards or forwards. This feature allows a specific test schedule to be followed with the minimum of user intervention. 12 sequences may be stored, with a maximum of 50 steps per sequence.

4.4.1 CREATING A SEQUENCE

STEP	PROCEDURE
------	-----------

1. Press the SETUP Key to display the Setup Menu.

SETUP	BAT 1.2 Hr			
PORT: RF I/O	FREQ: PRESET			
AP SWP RATE: 20 sec	VOR BRG: FIXED			
EXT ATTN: 0.0 dB	PWR DWN: 10 mins			
ILS UNITS: DDM	RF LVL UNITS: dBm			
KEY CLICK: OFF	MORSE CODE: IFR			
AUDIO: OFF				
NEXT PARAM	GUIDED TEST	STORE/RECALL	H/W TOOLS	INFO

2. Press the GUIDED TEST Soft Key to display the Guided Test Screen.

GUIDED TEST	BAT 1.2 Hr			
1 B-747-400				
2				
3				
4				
5				
6				
7				
8				
9				
10				
11				
12				
DELETE		CREATE	RUN	RETURN

3. Use the INCREMENT/SELECT Data Key or the DECREMENT/SELECT Data Key to select an empty store location.

4.4.1 CREATING A SEQUENCE (cont)

STEP	PROCEDURE
------	-----------

- To enter the store name, press the CREATE Soft Key to display the Guided Test Password Screen

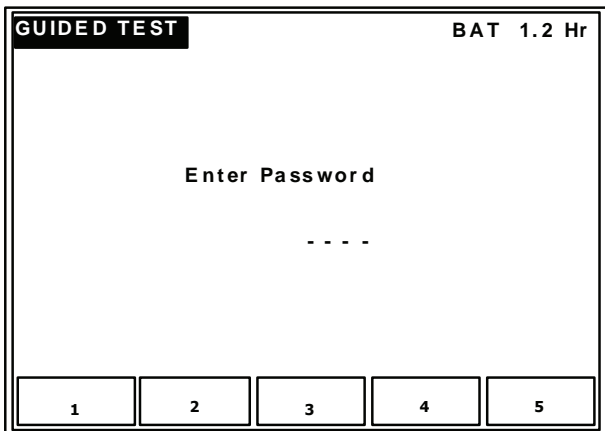

- Enter the Password (provided with the Test Set) by pressing the applicable Soft Keys. The Store Name Screen is displayed.



- Use the SEL LINE Soft Key to select the desired line of characters. Use the SELECT DATA UNITS MSB Key and the SELECT DATA UNITS LSB Key to select the desired character. Press the SELECT Soft Key to enter the character.
- Repeat Step 6 until the store name is completed. Press the DONE Key to confirm the store name. (The last Mode Screen is displayed.) Press the CANCEL Soft Key to abort the store name.

STEP	PROCEDURE
------	-----------

- Select the desired Mode and Field settings and press the SETUP Key to display the Setup Menu.
- Press the GUIDED TEST Soft Key to display the Guided Test Store Step Screen.

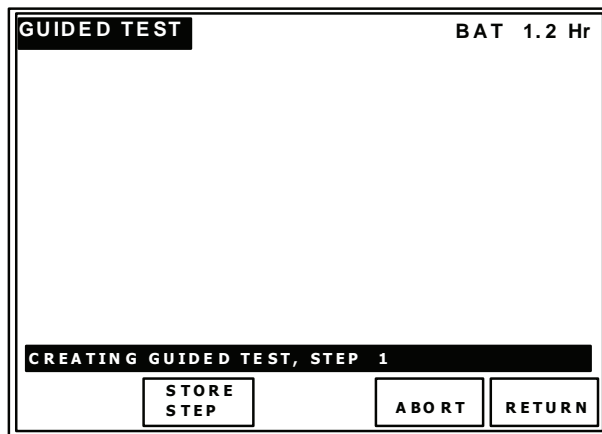

- Press the STORE STEP Soft Key to store the step. The last selected Mode and settings are displayed.
- Repeat Steps 8 to 10 until the test sequence is complete.
- Press the SETUP Key to display the Setup Menu.
- Press the GUIDED TEST Soft Key to display the Guided Test Store Step Screen.
- Press the DONE Soft Key to close the Guided Test Sequence.

4.4.2 DELETING A SEQUENCE

STEP	PROCEDURE
------	-----------

1. Press the SETUP Key to display the Setup Menu.

SETUP		BAT 1.2 Hr		
PORT: RF I/O	FREQ: PRESET			
AP SWP RATE: 20 sec	VOR BRG: FIXED			
EXT ATTN: 0.0 dB	PWR DWN: 10 mins			
ILS UNITS: DDM	RF LVL UNITS: dBm			
KEY CLICK: OFF	MORSE CODE: IFR			
AUDIO: OFF				
NEXT PARAM	GUIDED TEST	STORE/ RECALL	H/W TOOLS	INFO

2. Press the GUIDED TEST Soft Key to display the Guided Test Screen.

GUIDED TEST		BAT 1.2 Hr		
1	B-747-400			
2				
3				
4				
5				
6				
7				
8				
9				
10				
11				
12				
DELETE		CREATE	RUN	RETURN

3. Use the INCREMENT/SELECT Data Key or the DECREMENT/SELECT Data Key to select the stored sequence for deletion.

STEP	PROCEDURE
------	-----------

4. Press the DELETE Soft Key to display the Guided Test Password Screen

GUIDED TEST		BAT 1.2 Hr		
Enter Password				
- - - -				
1	2	3	4	5

5. Enter the Password (provided with the Test Set) by pressing the applicable Soft Keys. The Delete Store Screen is displayed.

DELETE STORE		BAT 1.2 Hr		
Delete existing store?				
YES		NO		

6. Press the YES Soft Key to delete the stored sequence or the NO Soft Key to return to the Guided Test Screen.

4.4.3 PLAYING A SEQUENCE

STEP	PROCEDURE
------	-----------

1. To recall and play a Guided Test Sequence, press the SETUP Key to display the Setup Menu.
2. Press the GUIDED TEST Soft Key to display the Guided Test Screen.

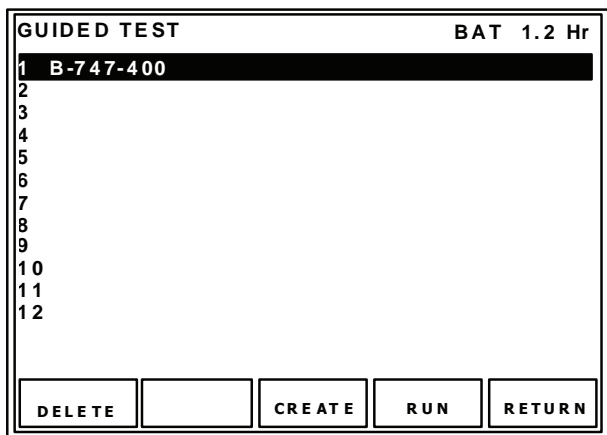

3. Use the INCREMENT/SELECT Data Key or the DECREMENT/SELECT Data Key to select the named store location.
4. Press the RUN Soft Key to run the Guided Test Sequence. Press the NEXT STEP Soft Key to select the next step in the sequence, press the PREV STEP Soft Key to select the previous step in the sequence or press the ABORT Soft Key to end the Guided Test in mid-sequence.

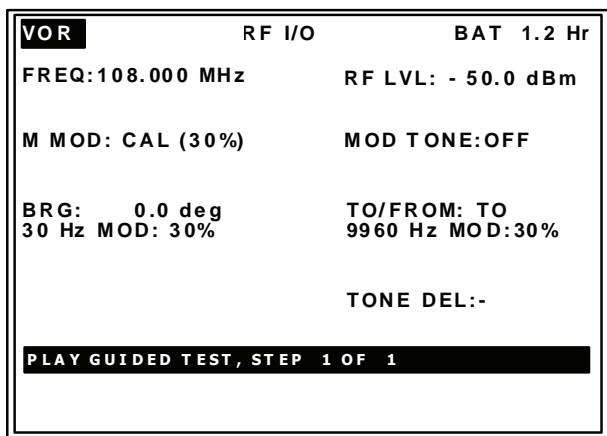

5. When the end of the sequence is reached, press the DONE Soft Key to end the Guided Test operation.

4.4.4 DOWNLOAD SEQUENCES THROUGH A REMOTE CONNECTION

To download a Sequence from the IFR 4000, a PC communications application such as Hyper Terminal (supplied with Windows 95/98), may be used.

STEP	PROCEDURE
------	-----------

1. Power up both the PC and the IFR 4000.
2. Connect the Serial Interface Cable (Aeroflex P/N 6041-5680-900) to the PC (Serial Connector) (9-Pin) and to the IFR 4000 (REMOTE Connector) (15-Pin or 25-Pin).

NOTE: Appendix E contains a diagram on how to build a Serial Interface Cable.

3. Press the SETUP Key to display the Setup Menu.
4. Press the H/W TOOLS Soft Key to display the Hardware Tools Screen.
5. Press the RS-232 Soft Key to display the RS-232 Settings Screen.
6. Ensure the same RS-232 parameters are set in the PC and in the IFR 4000.
7. To test the connection, type in: ***IDN?** on the PC and press the ENTER Key. Verify the following information is displayed on the PC: **IFR,4000,SERIAL NO,MAIN SW VER/BOOT SW VER**
8. Press the RETURN Soft Key to display the Hardware Tools Screen.
9. Press the RETURN Soft Key to display the Setup Menu.
10. Press the GUIDED TEST Soft Key to display the Guided Test Screen.
11. On the PC, type in: **GTST? n** (where n is a number from 1 to 12) and press the ENTER Key.
12. Once the Sequence appears on the PC screen, the Sequence can be highlighted and saved to the desired storage folder/location as an ASCII Text File (.txt).
13. Repeat Steps 11 and 12 to download additional Sequences.



4.4.5 UPLOAD SEQUENCES THROUGH A REMOTE CONNECTION

To upload a Sequence from the IFR 4000, a PC communications application such as Hyper Terminal (supplied with Windows 95/98), may be used.

NOTE: To prevent accidental overwriting of Sequences during the upload Sequence process, refer to para 1-2-4.4.3 to download all critical Sequences to a safe storage folder/location prior to uploading Sequences.

STEP	PROCEDURE
1.	Power up both the PC and the IFR 4000.
2.	Connect the Serial Interface Cable (Aeroflex P/N 6041-5680-900) to the PC (Serial Connector) (9-Pin) and to the IFR 4000 (REMOTE Connector) (15-Pin or 25-Pin). NOTE: Appendix E contains a diagram on how to build a Serial Interface Cable.
3.	Press the SETUP Key to display the Setup Menu.
4.	Press the H/W TOOLS Soft Key to display the Hardware Tools Screen.
5.	Press the RS-232 Soft Key to display the RS-232 Settings Screen.
6.	Ensure the same RS-232 parameters are set in the PC and in the IFR 4000.
7.	To test the connection, type in: *IDN? on the PC and press the ENTER Key. Verify the following information is displayed on the PC: IFR,4000,SERIAL NO,MAIN SW VER/BOOT SW VER
8.	Press the RETURN Soft Key to display the Hardware Tools Screen.
9.	Press the RETURN Soft Key to display the Setup Menu.
10.	Press the GUIDED TEST Soft Key to display the Guided Test Screen.
11.	On the PC, type in: GTST n (where n is a number from 1 to 12 - the chosen Sequence line number) and press the ENTER Key.
12.	The line DOWNLOAD GUIDED TEST data now is displayed on the PC.

4.4.5 UPLOAD SEQUENCES THROUGH A REMOTE CONNECTION (cont)

STEP	PROCEDURE
13.	Send the Sequence File (*.txt) to the IFR 4000.
14.	The uploaded Sequence is displayed on the Guided Test Screen. NOTE: When specifying a Sequence line number ensure the Sequence line number chosen is correct. The upload process overwrites any existing Sequence information for the Sequence line number chosen.
15.	Repeat Steps 11 through 14 to upload additional Sequences.

SECTION 3 - SPECIFICATIONS

NOTE: A 15 minute warm-up period is required for all specifications.

NOTE: Audio distortion characteristics are measured in a 20 Hz to 15 kHz post detection bandwidth.

NOTE: All DDM measurements are made on an RF output signal.

NOTE: Specifications are subject to change without notice.

RF SIGNAL GENERATOR

Output Frequency:

Marker Beacon Channel:	72.00 to 78.00 MHz in 25 kHz steps
Marker Beacon Preset:	74.50, 75.00 or 75.50 MHz
Marker Beacon Variable:	72.00 to 78.00 MHz in 1 kHz steps
VOR Channel:	108.00 to 117.95 MHz in 50 kHz steps
VOR Preset:	108.00, 108.05 or 117.95 MHz
VOR Variable:	107.00 to 118.00 MHz in 1 kHz steps
LOC Channel:	108.10 to 111.95 MHz in 50 kHz steps
LOC Preset:	108.10, 108.15 or 110.15 MHz
LOC Variable:	107.00 to 113.00 MHz in 1 kHz steps
G/S Channel:	329.15 to 335.00 MHz in 50 kHz steps
G/S Preset:	334.25, 334.55 or 334.70 MHz
G/S Variable:	327.00 to 337.00 MHz in 1 kHz steps
Comm AM Channel:	10.00 to 400.00 MHz in 25 kHz steps 118.00 to 156.00 MHz in 8.33 kHz steps
Comm AM Preset:	118.00, 137.00 or 156.00 MHz 225.00, 312.00 or 400.00 MHz
Comm AM Variable:	10.00 to 400.00 MHz in 1 kHz steps
Comm FM Channel:	10.00 to 400.00 MHz in 12.5 or 25 kHz steps
Comm FM Preset:	156.00, 165.00, 167.50 or 174.00 MHz
Comm FM Variable:	10.00 to 400.00 MHz in 1 kHz steps
Comm SSB Variable:	10.00 to 30.00 MHz in 100 Hz steps
SELCAL Channel:	118.00 to 156.00 MHz in 25 kHz steps
SELCAL Preset:	118.00, 137.00 or 156.00 MHz
SELCAL Variable:	117.00 to 157.00 MHz in 1 kHz steps

Frequency Accuracy: Same as Time Base

RF SIGNAL GENERATOR (cont)

Output Level:

ANT Connector (10 to 75 MHz):

Single Carrier:	-17 to -67 dBm in 0.5 dB steps
Accuracy:	±3 dB

ANT Connector (75 to 400 MHz):

Single Carrier:	+13 to -67 dBm in 0.5 dB steps
Accuracy:	±3 dB

Dual Mode - LOC: 0 dBm Fixed

Accuracy: ±2.5 dB

Dual Mode - G/S: 0 to -76 dBm in 0.5 dB steps

Accuracy: ±3 dB (0 to -67 dBm)

Tri-Mode - Marker: +13 dBm Fixed

Accuracy: ±2 dB

Tri-Mode - LOC: -7 dBm Fixed

Accuracy: ±2 dB

Tri-Mode - G/S: -7 to -83 dBm in 0.5 dB steps

Accuracy: ±3 dB (-7 to -74 dBm)

RF I/O Connector (10 to 75 MHz):

Single Carrier: -40 to -130 dBm in 0.5 dB steps

Accuracy:

-40 to -94.5 dBm: ±2 dB

-95 to -120 dBm: ±3 dB

RF I/O Connector (75 to 400 MHz):

Single Carrier: -12 to -130 dBm in 0.5 dB steps

Accuracy:

-12 to -39.5 dBm: ±2.5 dB

-40 to -94.5 dBm: ±2 dB

-95 to -120 dBm: ±3 dB

Dual Mode - LOC: -22 dBm Fixed

Accuracy: ±2 dB

Dual Mode - G/S: -22 to -101 dBm in 0.5 dB steps

Accuracy: ±2.5 dB

Spectral Purity:

Harmonics: <-20 dBc

Non-Harmonic Spurious: <-32 dBc between 10 and 400 MHz



OPERATIONAL MODES

VOR Mode:

VOR Tone Frequency Accuracy:

30 Hz Reference:	±0.02%
30 Hz Variable:	±0.02%
1020 Hz:	±0.02%
9960 Hz:	±0.02%

AM Modulation:

CAL:

30 and 9960 Hz Tones: 30% AM, Each Tone

Accuracy: ±1% Modulation

1020 Hz Tone: 30% AM

1020 Hz Morse Code: 10% AM

Accuracy: ±2% Modulation

Variable:

Range: 0% to 55% AM (30, 1020 and 9960 Hz Tones)

Distortion: <2.0% in CAL Position

FM Modulation:

30 Hz Reference at ±480 Hz Peak Deviation on 9960 Hz Sub-Carrier

Accuracy: ±25 Hz Peak Deviation

Bearing:

To - From Selectable

Preset Bearing: 0°, 30°, 60°, 90°, 120°, 150°, 180°, 210°, 240°, 270°, 300° and 330°

Variable Bearing: 3600 digitally derived courses in 0.1° increments.

Accuracy: ±0.1°

LOC Mode:

LOC Tone Frequency Accuracy:

90 Hz:	±0.02%
150 Hz:	±0.02%
1020 Hz:	±0.02%



OPERATIONAL MODES (cont)

LOC Mode (cont):

Modulation:

CAL:

90 and 150 Hz Tones:	20% AM, Each Tone
1020 Hz Audio Tone:	30% AM
1020 Hz Morse Code:	10% AM
Accuracy:	±2% Modulation

Variable:

Range:	0% to 28% AM (90 and 150 Hz Tones) 0% to 42% AM (1020 Hz Tone)
--------	---

Distortion: <2.5% in CAL Position

LOC DDM:

Fixed:

Range:	±0, 0.093, 0.155 or 0.200 DDM and Tone Delete
Accuracy:	±0.0015 DDM (±1.5 µA) (±3% of setting) (≤+10 dBm Output Level)

Variable:

Range:	±0.4 DDM in 0.001 DDM steps
Accuracy:	±0.0025 DDM (±2.5 µA) (±3% of setting) (≤+10 dBm Output Level)

Variable Sweep: (Available only in Dual and Tri-Modes)

Range:	0 to ±30 µA
Sweep Rates:	5 to 40 sec
Step Size:	5 sec
Accuracy:	±0.5 sec/sweep

Phase Shift:

Range:	0° to 120° in 5° increments (150 Hz phase relative to 90 Hz)
Accuracy:	±0.5°

OPERATIONAL MODES (cont)**G/S MODE:**

G/S Tone Frequency Accuracy:

90 Hz:	±0.02%
150 Hz:	±0.02%

Modulation:

CAL:

90 and 150 Hz Tones:	40% AM, Each Tone
Accuracy:	±2% Modulation

Variable:

Range:	0% to 50% AM (90 and 150 Hz Tones)
Distortion:	<2.5% in CAL Position

G/S DDM:

Fixed:

Range:	±0, 0.091, 0.175 or 0.400 DDM and Tone Delete
Accuracy:	±0.003 DDM (±2.5 μA) (±3% of setting) (≤+10 dBm Output Level)

Variable:

Range:	±0.8 DDM in 0.001 DDM steps
Accuracy:	±0.0048 DDM (±4.0 μA) (±3% of setting) (≤+10 dBm Output Level)

Phase Shift:

Range:	0° to 120° in 5° increments (150 Hz phase relative to 90 Hz)
Accuracy:	±0.5°

OPERATIONAL MODES (cont)**MARKER MODE:**

MARKER Tone Frequency Accuracy:

400 Hz:	±0.02%
1300 Hz:	±0.02%
3000 Hz:	±0.02%

Modulation:

CAL:

Setting:	95% AM
Accuracy:	±5% Modulation

Variable (Single Carrier Only):

Range:	0% to 95% AM
--------	--------------

Distortion:

Single Carrier:	<2.5% in CAL Position (-67 to +10 dBm)
Tri-Mode:	<5% in CAL Position

COMM Mode (AM):

COM Tone Frequency Accuracy:

1020 Hz:	±0.02%
----------	--------

Modulation:

CAL:

1020 Hz Tone:	30% AM
Accuracy:	±2% Modulation

Variable:

Range:	0% to 95% AM
--------	--------------

Distortion:

<2.5% in CAL Position

OPERATIONAL MODES (cont)**COMM Mode (FM):**

COM Tone Frequency Accuracy:

1000 Hz: $\pm 0.02\%$

Modulation:

CAL:

1000 Hz Tone: 5 kHz Deviation

Accuracy: $\pm 5\%$

Variable:

Deviation Range: 1 to 80 kHz

Accuracy: $\pm(0.3 \text{ kHz} + 4\% \text{ of setting})$ Distortion: $<5\%$ in CAL Position**COMM Mode (SSB):**

COM Tone Frequency Accuracy:

1000 Hz: $\pm 6.25 \text{ Hz}$ referenced to carrier

Modulation:

Variable:

Range:

Upper Sideband: 25 to 3000 Hz in 25 Hz Steps

Lower Sideband: 25 to 3000 Hz in 25 Hz Steps

OPERATIONAL MODES (cont)

SELCAL Mode:	(Provides amplitude modulation with SELCAL [SElective CALLing] tones)
SELCAL Tone Frequency Accuracy:	±0.02%
Transmit Modes:	
Single:	Single Transmission
Continuous:	7.5 sec interval (typical)
Modulation:	
CAL:	
Per SELCAL Tone:	40% AM
Accuracy:	±2% Modulation
Variable:	
Range:	0% to 55% AM
Distortion:	<2.5% in CAL Position



METER FUNCTIONS

External Frequency Counter:

Frequency Range:

ANT and RF I/O Connectors:

Range:	10 to 400 MHz
Resolution:	100 Hz
Accuracy:	Same as Time Base, ± 1 Count

AUX I/O Connector:

Range:	1 to 10 MHz
Resolution:	1 Hz
Accuracy:	Same as Time Base, ± 1 Count

Sensitivity:

ANT Connector:	≥ -35 dBm
RF I/O Connector:	≥ 0 dBm
AUX I/O Connector:	≥ 1 Vp-p (From a 50 Ω source)

Power Meter (RF I/O Connector):

Frequency Range:	10.0 to 400.0 MHz
Power Range:	0.1 to <1 W 1 to <100 W 100 to 1999 W (External Attenuator required for input power >30 W.)
Resolution:	
0.1 to <1 W:	0.01 W
1 to <100 W:	0.1 W
100 to 300 W:	1 W
Accuracy:	
<100 MHz:	$\pm 12\%$ of reading, ± 1 Count, CW Only (without External Attenuator)
100 to 400 MHz:	$\pm 8\%$ of reading, ± 1 Count, CW Only (without External Attenuator)
Duty Cycle:	
≤ 10 W:	Continuous
>10 to ≤ 20 W:	3 min ON, 2 min OFF
>20 to ≤ 30 W:	1 min ON, 2 min OFF

METER FUNCTIONS (cont)

AM METER:

Audio Range:	50 to 3000 Hz
Percent Modulation Range:	10% to 99%
Accuracy:	±10% of reading
Sensitivity:	
ANT Connector:	≥-20 dBm
RF I/O Connector:	≥+15 dBm

FM Meter:

Audio Range:	50 to 3000 Hz
Deviation Range:	1 to 15 kHz
Accuracy:	± (0.4 kHz + 8% of reading)
Minimum input Level:	
ANT Connector:	≥-35 dBm
RF I/O Connector:	≥0 dBm

SWR Meter (SWR Connector):

Frequency Range:	10.0 to 410.0 MHz
Accuracy:	
SWR <3:1:	±0.2, ±20% of reading
SWR >3:1:	±0.3, ±20% of reading

121.5/243 Beacon Monitor:

Swept Audio Tone Range:	100 to 3000 Hz
Accuracy:	±10% of reading)
Sensitivity:	
ANT Connector:	≥-30 dBm
RF I/O Connector:	≥+10 dBm

406 Beacon Monitor:

Sensitivity:	
ANT Connector:	≥-35 dBm
RF I/O Connector:	≥0 dBm

MISCELLANEOUS

Inputs/Outputs:

RF I/O Connector:

Type:	Input/Output
Impedance:	50 Ω Typical
Maximum Input Level:	30 W, 1 min ON, 2 min OFF
VSWR:	
10 to \leq 300 MHz:	<1.3:1
>300 to 400 MHz:	<1.35:1

ANT Connector:

Type:	Input/Output
Impedance:	50 Ω typical
Maximum Input Level:	0.5 W

SWR Connector:

Type:	Output
Impedance:	50 Ω Typical
Maximum Reverse Power:	+25 dBm
VSWR:	
10 to \leq 300 MHz:	<1.3:1
>300 to 400 MHz:	<1.35:1

AUX Connector:

Type:	Input/Output
Impedance:	800 Ω Typical
Maximum Input Level:	5 Vp-p Maximum, 3 Vdc Maximum

Time Base (TCXO):

Temperature Stability:	\pm 1 ppm
Aging:	\pm 1 ppm per year
Accuracy:	\pm 1 ppm when Auto Cal is performed

Battery:

Type:	Li Ion
Duration:	>8 hrs continuous operation

MISCELLANEOUS (cont)**Input Power (Test Set):**

Input Range:	11 to 32 Vdc
Power Consumption:	55 W Maximum 16 W Nominal at 18 Vdc with Charged Battery
Fuse Requirements:	5 A, 32 Vdc, Type F

Input Power (External AC to DC Converter):

Input Range:	100 to 250 VAC, 1.5 A Maximum, 47 to 63 Hz
Main Supply Voltage Fluctuations:	≤10% of the nominal voltage
Transient Overvoltages:	According to Installation Category II

Environmental (Test Set):

Use:	Pollution Degree 2
Altitude:	≤4800 meters
Operating Temperature:	-20° to 55°C (Battery Charging temperature range is 5° to 40°C, controlled by internal charger)
Storage Temperature:	-30° to 70°C (Li Ion Battery must be removed when <-20°C and >60°C)
Relative Humidity:	
5°C to <10°C:	80%
10°C to <31°C:	95%
31°C to <40°C:	75%
40°C to 50°C:	45%

Environmental (External AC to DC Converter):

Use:	Indoors
Altitude:	≤3000 meters
Temperature:	5° to 40°C

Physical Characteristics:

Dimensions:	
Height:	11.2 in (28.5 cm)
Width:	9.1 in (23.1 cm)
Depth:	2.7 in (6.9 cm)
Weight (Test Set only):	<8 lbs. (3.6 kg)

APPENDIX A - CONNECTOR PIN-OUT TABLES

1. I/O CONNECTORS

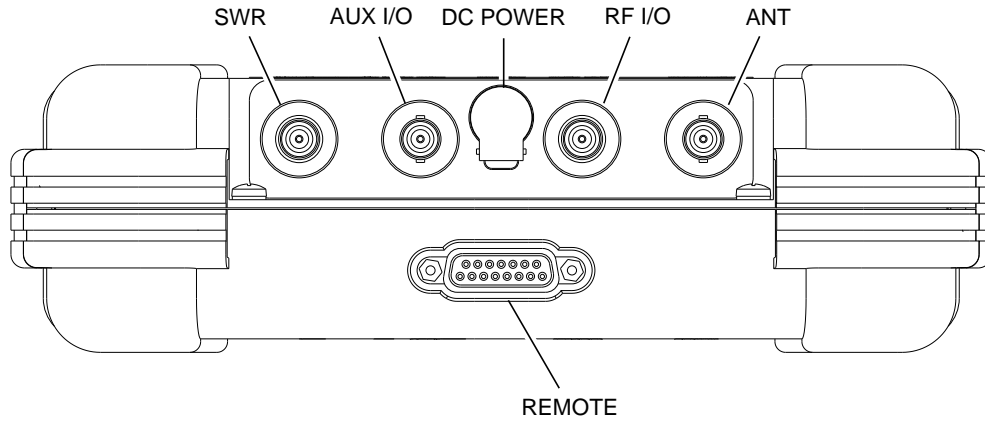

056P-02

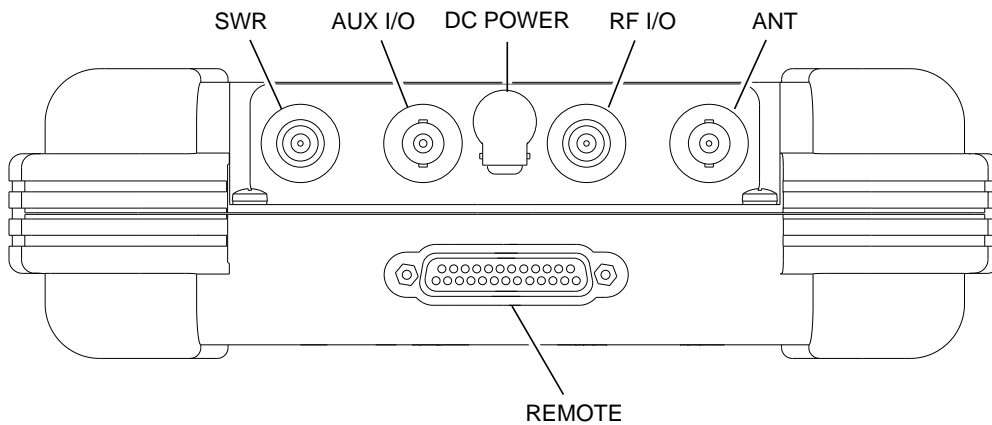

056P-02

CONNECTOR	TYPE	SIGNAL TYPE	INPUT/OUTPUT
SWR	TNC	RF	OUTPUT
AUX I/O	BNC	N/A	INPUT/OUTPUT
DC POWER	2.5 mm CIRCULAR (2.5 mm center, 5.5 mm outer diameter, center positive)	11 to 32 Vdc	INPUT
RF I/O	TNC	RF, 30 W CW MAX	INPUT/OUTPUT
ANT	BNC	RF, 0.5 W CW MAX	INPUT/OUTPUT
REMOTE	15-Pin or 25-Pin Female	MIXED	INPUT/OUTPUT
Refer to Appendix A, Table 2 or Table 3 for REMOTE Connector description			

I/O Connectors
Table 1

2. REMOTE CONNECTOR PIN-OUT TABLE (15-PIN)

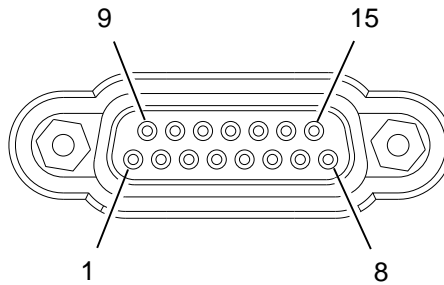

056P-03

PIN NO.	SIGNAL NAME	DESCRIPTION
1	VBUS_DN1	+5 Vdc Supply for Downstream USB Device
2	H_D1+	D+ Data To/From Downstream USB Device
3	VBUS_UP	+5 Vdc Input from Upstream USB Host
4	D_D+	D+ Data To/From Upstream USB Host
5	TX	RS-232 Data Output
6	RX	RS-232 Data Input
7	CTS	RS-232 Clear To Send (Input)
8	RTS	RS-232 Request To Send (Output)
9	GND_DN1	Ground for Downstream USB Device
10	H_D1-	D- Data To/From Downstream USB Device
11	GND_UP	Ground from Upstream USB Host
12	D_D-	D- Data To/From Upstream USB Host
13	GND	System Ground
14	GND	System Ground
15	GND	System Ground

REMOTE Connector Pin-Out Table (15-Pin)
Table 2

3. REMOTE CONNECTOR PIN-OUT TABLE (25-PIN)

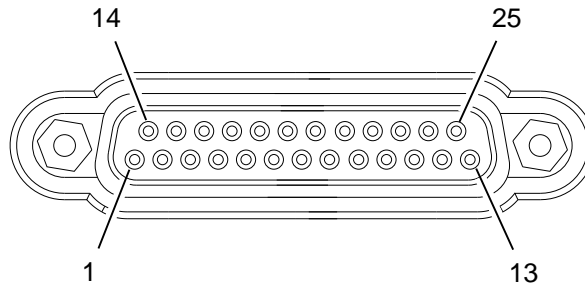

056P-03

PIN NO.	SIGNAL NAME	DESCRIPTION
1	VBUS_DN1	+5 Vdc Supply for Downstream USB Device
2	H_D1+	D+ Data To/From Downstream USB Device
3	VBUS_UP	+5 Vdc Input from Upstream USB Host
4	D_D+	D+ Data To/From Upstream USB Host
5	TX	RS-232 Data Output
6	RX	RS-232 Data Input
7	CTS	RS-232 Clear To Send (Input)
8	RTS	RS-232 Request To Send (Output)
9	OPEN	
10	OPEN	
11	OPEN	
12	OPEN	
13	OPEN	
14	GND_DN1	Ground for Downstream USB Device
15	H_D1-	D- Data To/From Downstream USB Device
16	GND_UP	Ground from Upstream USB Host
17	D_D-	D- Data To/From Upstream USB Host
18	GND	System Ground
19	GND	System Ground
20	GND	System Ground
21	OPEN	
22	OPEN	
23	OPEN	
24	OPEN	
25	OPEN	

REMOTE Connector Pin-Out Table (25-Pin)
Table 3



THIS PAGE INTENTIONALLY LEFT BLANK.



APPENDIX B - METRIC/BRITISH IMPERIAL CONVERSION TABLE WITH NAUTICAL DISTANCE CONVERSIONS

TO CONVERT:	INTO:	MULTIPLY BY:	TO CONVERT:	INTO:	MULTIPLY BY:
cm	feet	0.03281	meters	feet	3.281
cm	inches	0.3937	meters	inches	39.37
feet	cm	30.48	m/sec	ft/sec	3.281
feet	meters	0.3048	m/sec	km/hr	3.6
ft/sec	km/hr	1.097	m/sec	miles/hr	2.237
ft/sec	knots	0.5921	miles	feet	5280
ft/sec	miles/hr	0.6818	miles	km	1.609
ft/sec ²	cm/sec ²	30.48	miles	meters	1609
ft/sec ²	m/sec ²	0.3048	miles	nmi	0.8684
grams	ounces	0.03527	miles/hr	ft/sec	1.467
inches	cm	2.54	miles/hr	km/hr	1.609
kg	pounds	2.205	miles/hr	knots	0.8684
kg/cm ²	psi	0.0703	nmi	feet	6080.27
km	feet	3281	nmi	km	1.8532
km	miles	0.6214	nmi	meters	1853.2
km	nmi	0.5396	nmi	miles	1.1516
km/hr	ft/sec	0.9113	ounces	grams	28.34953
km/hr	knots	0.5396	pounds	kg	0.4536
km/hr	miles/hr	0.6214	psi	kg/cm ²	0.0703
knots	ft/sec	1.689	100 ft	km	3.048
knots	km/hr	1.8532	100 ft	miles	1.894
knots	miles/hr	1.1516	100 ft	nmi	1.645



THIS PAGE INTENTIONALLY LEFT BLANK.

APPENDIX C - FACTORY PRESETS

NOTE: ** indicates the Menu/Screen Field always defaults to RECEIVING.

MISC

CONTROL	SETTING
INSTRUMENT MODE	VOR Screen

Setup Menu

FIELD	SETTING
ILS UNITS	DDM
PWR DWN	10 mins
RF LVL UNITS	dBm
FREQ	PRESET
VOR BRG	FIXED
PORT	ANT
KEY CLICK	OFF
EXT ATTN	0.0 dB
AP SWP RATE	20 sec
MORSE CODE	IFR
AUDIO	OFF

VOR Screen

FIELD	SETTING
FREQ	108.000 MHz
RF LVL	-50.0 dBm
M MOD	CAL (60%)
MOD TONE	OFF
BRG	0.0 deg
TO/FROM	TO
30 Hz MOD	30%
9960 Hz MOD	30%
TONE DEL	OFF

LOC Screen

FIELD	SETTING
FREQ	108.100 MHz
RF LVL	-50.0 dBm
M MOD	CAL (40%)
MOD TONE	OFF
DEV STEP	FIXED
90/150Hz	0 deg (OFF)
LOC DDM	0.000 CENTER
TONE DEL	OFF

G/S Screen

FIELD	SETTING
FREQ	334.250 MHz
LOC FREQ	110.150 MHz
RF LVL	-50.0 dBm
M MOD	CAL (80%)
DEV STEP	FIXED
90/150Hz	0 deg (OFF)
G/S DDM	0.000 CENTER
TONE DEL	OFF

Marker Beacon Screen

FIELD	SETTING
FREQ	75.000 MHz
RF LVL	-50.0 dBm
M MOD	CAL (0%)
MOD TONE	OFF

ILS Screen

FIELD	SETTING
FREQ	108.100 MHz
G/S FREQ	334.700 MHz
RF LVL	-50.0 dBm
M MOD	CAL (80%)
AP SWP	OFF
AP SWP DEV	30 μ A
MOD TONE	OFF
DEV STEP	FIXED
90/150Hz	0 deg (OFF)
LOC DDM	0.000 CENTER
G/S DDM	0.000 CENTER
TONE DEL	OFF

COMM AM Screen

FIELD	SETTING
FREQ	118.000 MHz
RF LVL	-50.0 dBm
M MOD	CAL (30%)
MOD TONE	1020 Hz
PWR MTR	PEAK
TRANSMIT/RECEIVE **	RECEIVING

COMM FM Screen

FIELD	SETTING
FREQ	156.000 MHz
RF LVL	-50.0 dBm
M MOD	CAL (5 kHz)
MOD TONE	1000 Hz
PWR MTR	PEAK
TRANSMIT/RECEIVE **	RECEIVING

COMM SSB Screen

FIELD	SETTING
FREQ	20.0000 MHz
RF LVL	-50.0 dBm
MOD TONE	OFF
PWR MTR	PEAK
SIDE BAND	UPPER
TRANSMIT/RECEIVE **	RECEIVING

SWR Screen

FIELD	SETTING
SWP MODE	CW
FREQ	165.000 MHz
START FREQ (SWEPT)	155.000 MHz
STOP FREQ (SWEPT)	175.000 MHz

SELCAL Screen

FIELD	SETTING
FREQ	118.000 MHz
RF LVL	-50.0 dBm
M MOD	CAL (80%)
SELCAL TONE	AB-CD
TX MODE	SINGLE

Frequency Counter Screen

FIELD	SETTING
RESOLUTION	1 Hz

RS-232 Settings Menu

FIELD	SETTING
BAUD RATE	9600
FLOW CONTROL	XON/XOFF

121.5/243 BEACON Screen

FIELD	SETTING
PORT	ANT
FREQ	121.5 MHz
AUDIO	OFF

406 BEACON Screen

FIELD	SETTING
PORT	ANT



THIS PAGE INTENTIONALLY LEFT BLANK.

APPENDIX D - ABBREVIATIONS

A		H	
A	Amperes	Hr	Hour
AC	Alternating Current	Hrs	Hours
AM	Amplitude Modulation	H/W	Hardware
ANT	Antenna	Hz	Hertz
AP	Address Parity		
ATTN	Attenuation		
AUTO	Automatic		
AUX	Auxiliary	ILS	Instrument Landing System
		I/O	Input/Output
B		I	
BAT	Battery		
bps	Bits per Second		
BRG	Bearing		
C		K	
C	Celsius or Centigrade	kg	Kilogram (10 ³ Grams)
CAL	Calibration	kHz	Kilohertz (10 ³ Hertz)
ccw	Counterclockwise	km	Kilometer (10 ³ meters)
CDI	Course Deviation Indication	kt	Knots (Velocity)
CHNL	Channel		
cm	Centimeter (10 ⁻² Meters)		
COMM	Communication		
Cont	Continued		
cw	Clockwise		
D		L	
dB	Decibel	LCD	Liquid Crystal Display
dBc	Decibels below Carrier	LED	Light Emitting Diode
dBm	Decibels above one Milliwatt	LOC	Localizer
DC	Direct Current	LSB	Least Significant Bit
DDM	Double Depth Modulation	LVL	Level
deg	Degrees		
DEL	Delete		
DEV	Deviation		
DIAGS	Diagnostics		
DWN	Down		
E		M	
EMC	Electromagnetic Compatibility	m	Meters
EXT	External	MAX	Maximum
		MB	Message, COMM-B
		MHz	Megahertz (10 ⁶ Hertz)
		min	Minutes
		MOD	Modulation
		mm	Millimeter (10 ⁻³ Meters)
		M MOD	Master Modulation
		ms	Millisecond (10 ⁻³ Seconds)
		MSB	Most Significant Bit
		mV	Milliwatt
		mW	Millivolt
F		N	
FM	Frequency Modulation	N/A	Not Applicable
FREQ	Frequency	NAV	Navigation
Ft	Foot/Feet	nmi	Nautical Miles
		ns	Nanosecond (10 ⁻⁹ Seconds)
G		O	
GEN	Generator or Generate	OUT	Output
GND	Ground		
G/S	Glideslope		

P

para	Paragraph	μA	Microamps
PARAM	Parameter	μs	Microseconds
ppm	Parts per Million	μW	Microwatts
PREV	Previous	Ω	Ohm
psi	Pounds per Square Inch		
PWR	Power		

R

RAM	Random Access Memory
RES	Resolution
RF	Radio Frequency
RMS	Root Mean Square
ROM	Read Only Memory
RX	Receive

S

Sec	Seconds
SELCAL	Selective Calling
SP	Spacing
SPM	Scans per Minute
SPR	Synchronous Phase Reversal
SQTR	Squitter
Sqtr	Squitter
SRQ	Service Request
SRS	Segment Request Subfield
SSR	Secondary Surveillance Radar
STD	Standard
SWP	Sweep
SWR	Standing Wave Ratio
SYNC	Synchronous

T

TX	Transmit
----	----------

U

UHF	Ultra High Frequency
USB	Upper Sideband
UUT	Unit Under Test

V

V	Volt
VAC	Volts, Alternating Current
VAR	Variable
Vdc	Volts, Direct Current
VHF	Very High Frequency
VOR	Very High Frequency Omni-Directional Radio Range
Vrms	Volts Root Mean Square
VSWR	Voltage Standing Wave Ratio

W

W	Watt
---	------

APPENDIX E - SERIAL INTERFACE CABLE

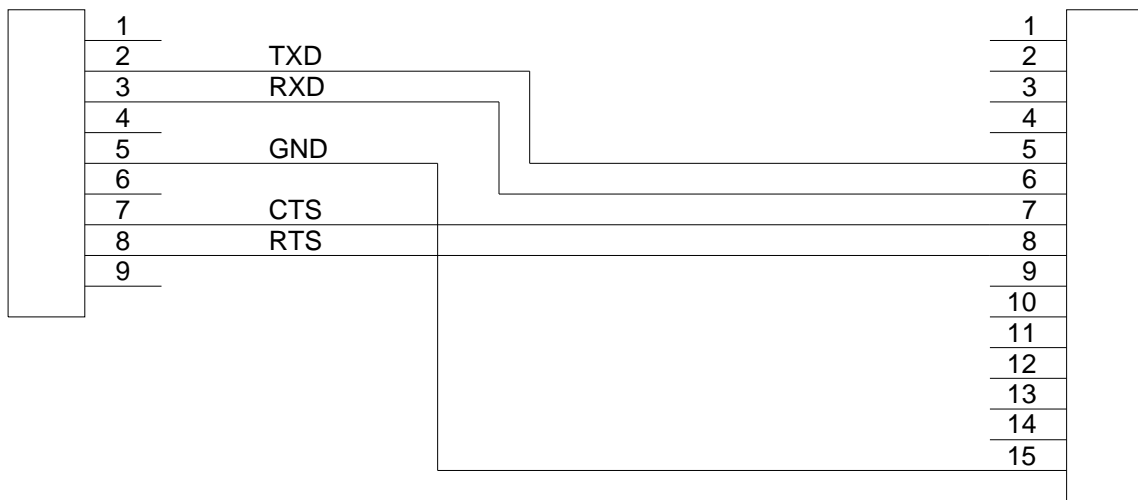
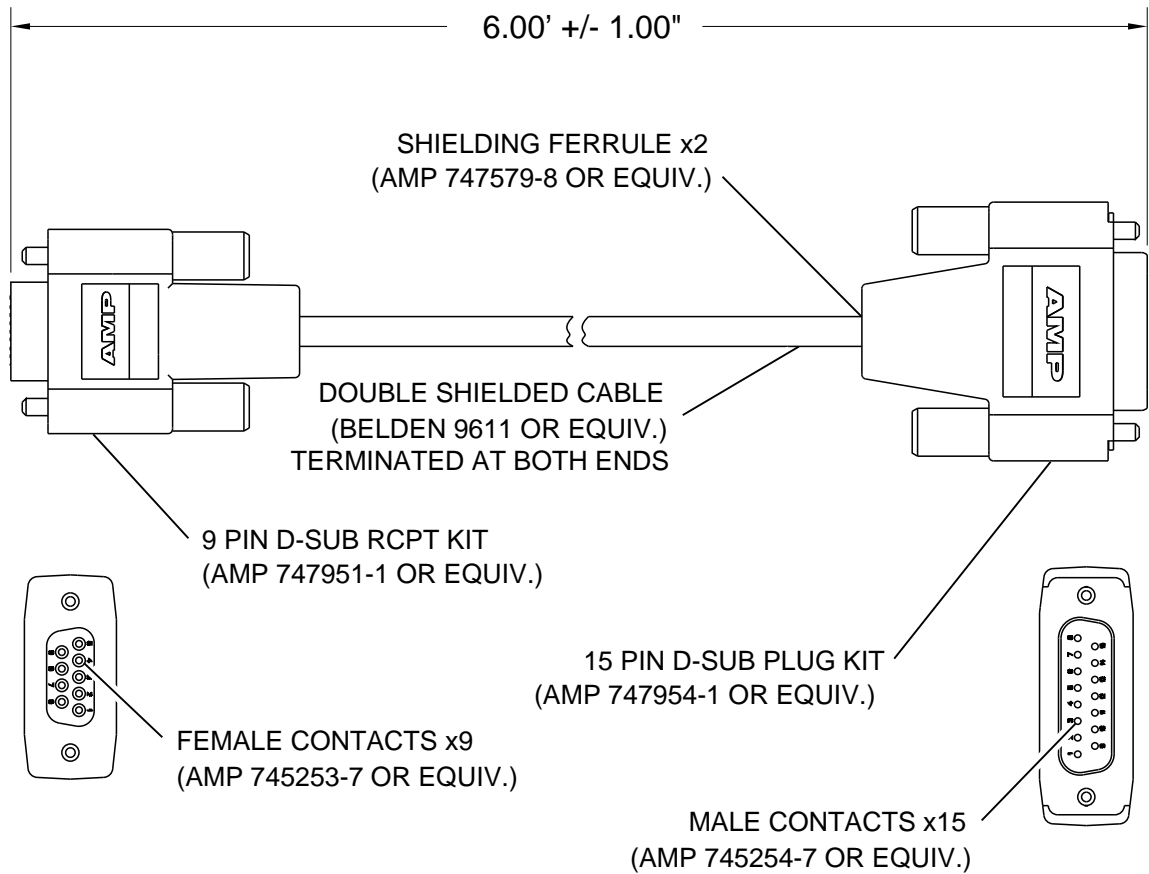

(15-PIN)

056P-008

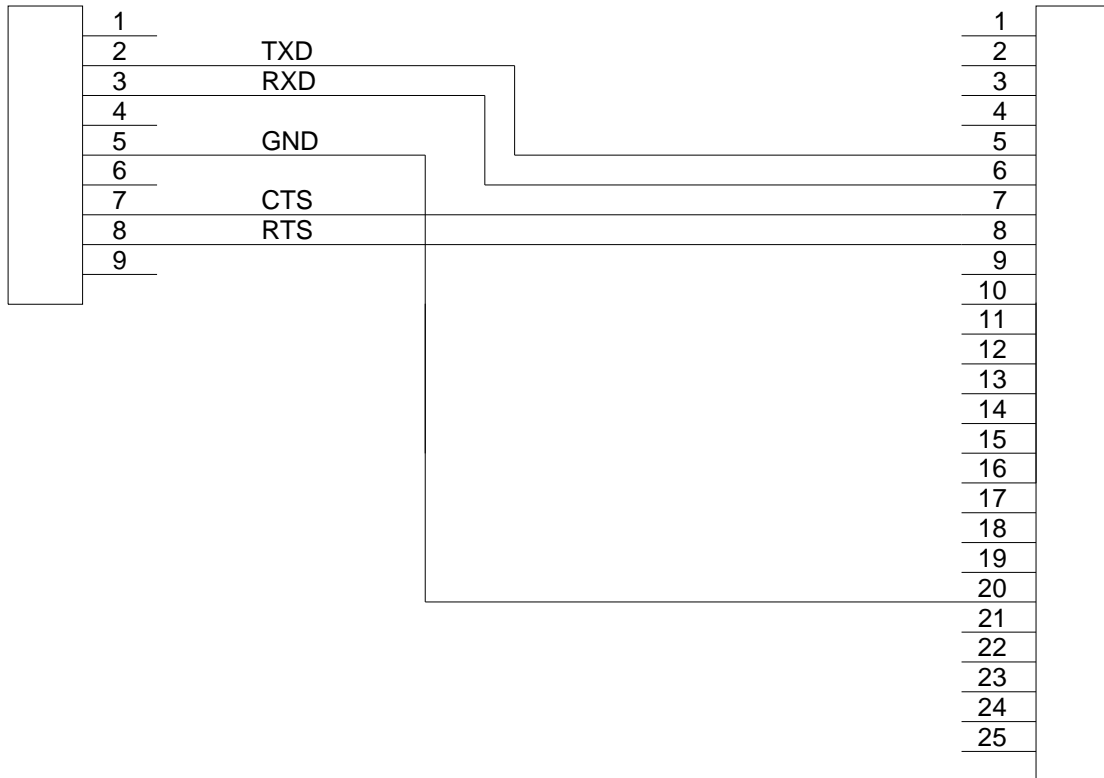
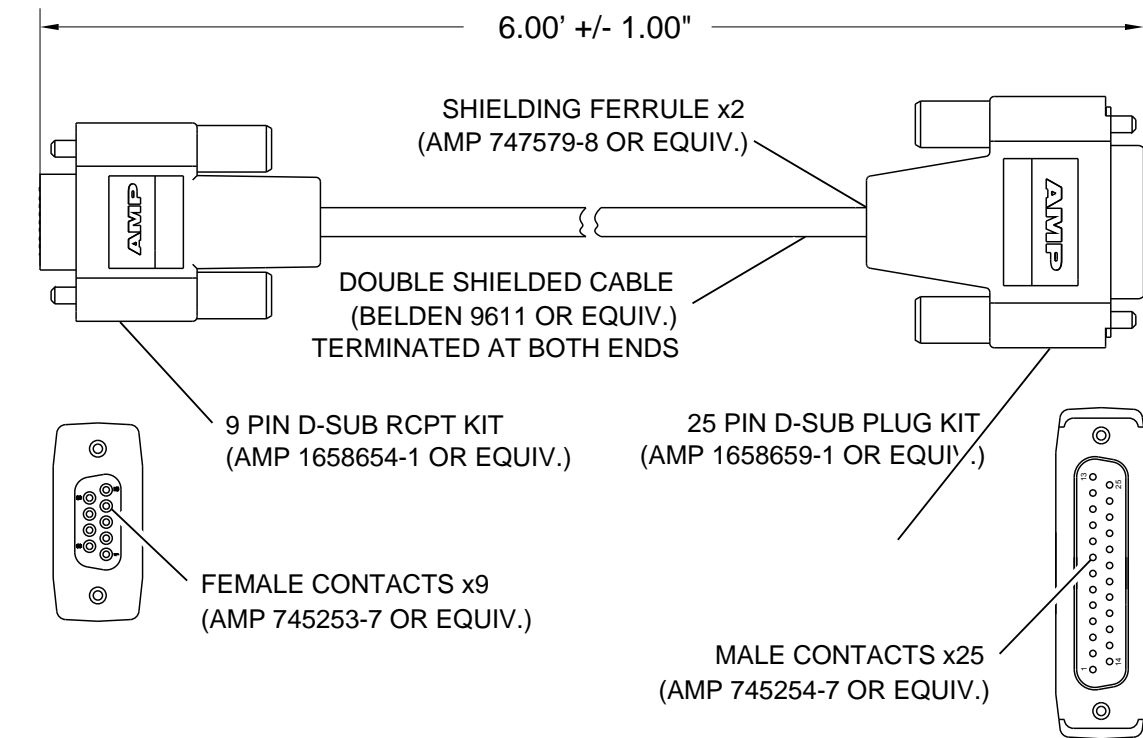

(25-PIN)

056P-008

APPENDIX F - 406 BEACON APPLICATIONS AND PROTOCOLS

1. CODING OPTIONS FOR USER PROTOCOLS

Application	Identification Data	Protocols
EPIRBs (Maritime)	MMSI	Maritime User
	Unique EPIRB Serial Number	Serial User
	Radio Call Sign	(a) Maritime User (b) Radio Call Sign
ELTs (Aviation)	Unique ELT Serial Number	Serial User
	Aircraft Operator Designator and Serial Number	Serial User
	Aircraft 24-bit address	Serial User
	Aircraft Registration Marking	Aviation User
PLBs (Personal)	Unique PLB Serial Number	Serial User
Test	Unique PLB Serial Number	Serial User

2. CODING OPTIONS FOR LOCATION PROTOCOLS

Application	Identification Data	Location Data	Protocols
EPIRBs (Maritime)	MMSI	4 min resolution encoded in PDF-2	User-Location
		Position offset to 4 sec resolution encoded in PDF-2 in addition to 15 min resolution encoded in PDF-1	Standard Location Standard Short Location
	Unique EPIRB Serial Number	4 min resolution encoded in PDF-2	User-Location
		Position offset to 4 sec resolution encoded in PDF-2 in addition to 15 min resolution encoded in PDF-1	Standard Location Standard Short Location
	Radio Call Sign	4 min resolution encoded in PDF-2	User-Location
	Serial Number (Assigned by Administration)	Position offset to 4 sec resolution encoded in PDF-2 in addition to	National Location
		2 min resolution encoded in PDF-1	National Short Location

Application	Identification Data	Location Data	Protocols
ELTs (Aviation)	Unique ELT Serial Number	4 min resolution encoded in PDF-2	User-Location
		Position offset to 4 sec resolution encoded in PDF-2 in addition to 15 min resolution encoded in PDF-1	Standard Location Standard Short Location
	Aircraft Operator Designator and Serial Number	4 minute resolution encoded in PDF-2	User-Location
		Position offset to 4 sec resolution encoded in PDF-2 in addition to 15 min resolution encoded in PDF-1	Standard Location Standard Short Location
	Aircraft 24-bit Address	4 minute resolution encoded in PDF-2	User-Location
		Position offset to 4 sec resolution encoded in PDF-2 in addition to 15 min resolution encoded in PDF-1	Standard Location Standard Short Location
	Aircraft Registration Marking	4 min resolution encoded in PDF-2	User-Location
	Serial Number (Assigned by Administration)	Position offset to 4 sec resolution encoded in PDF-2 in addition to	National Location
		2 min resolution encoded in PDF-1	National Short Location



Application	Identification Data	Location Data	Protocols
PLBs (Personal)	Unique PLB Serial Number	4 min resolution encoded in PDF-2	User-Location
		Position offset to 4 sec resolution encoded in PDF-2 in addition to 15 min resolution encoded in PDF-1	Standard Location Standard Short Location
	Serial Number (Assigned by Administration)	Position offset to 4 sec resolution encoded in PDF-2 in addition to 2 min resolution encoded in PDF-1	National Location National-Short Location
Test	Any Unique Combination		All

INDEX

121.5/243 Beacon Mode Screen		ILS Mode Screen	
Description	1-2-4, p 32	Description	1-2-4, p 18
Operation	1-2-4, p 59	Operation	1-2-4, p 49
406 Beacon Applications and Protocols	App F	Info Screen	1-2-4, p 10
406 Beacon Mode Screen		Installation	1-2-1, p 1
Description	1-2-4, p 34	I/O Connectors	App A, p 1
Operation	1-2-4, p 60		
Abbreviations	App D	Localizer Mode Screen	
AC Power Requirements	1-2-1, p 2	Description	1-2-4, p 13
		Operation	1-2-4, p 44
Battery		Marker Beacon	
Charging	1-2-1, p 1	Description	1-2-4, p 17
Operation	1-2-1, p 1	Operation	1-2-4, p 48
Recharging	1-2-1, p 2	Metric/British Conversion Table	App B
Specifications	1-3-1, p 12		
Calibration Screen	1-2-4, p 10	Operating Information	
COMM AM Mode Screen		121.5/243 Beacon	1-2-4, p 59
Description	1-2-4, p 21	406 Beacon	1-2-4, p 60
Operation	1-2-4, p 50	COMM AM	1-2-4, p 50
COMM FM Mode Screen		COMM FM	1-2-4, p 52
Description	1-2-4, p 23	COMM SSB	1-2-4, p 54
Operation	1-2-4, p 52	Frequency Counter	1-2-4, p 58
COMM SSB Mode Screen		Glideslope	1-2-4, p 46
Description	1-2-4, p 25	Guided Test Screens	
Operation	1-2-4, p 54	Creating a Sequence	1-2-4, p 60
Connector Pin-Out Tables	App A, p 1	Deleting a Sequence	1-2-4, p 62
I/O Connectors	App A, p 1	Download Sequences through a	
Remote Connector	App A, p 2	Remote Connection	1-2-4, p 63
Controls, Connectors and Indicators	1-2-2, p 1	Playing a Sequence	1-2-4, p 62
		Upload Sequences through a	
		Remote Connection	1-2-4, p 64
Description	1-1-1, p 1	ILS	1-2-4, p 49
Diagnostics Screen	1-2-4, p 8	Localizer	1-2-4, p 44
		Marker Beacon	1-2-4, p 48
External Cleaning	1-2-1, p 3	SELCAL	1-2-4, p 57
		Setup Menu	1-2-4, p 41
Factory Presets	App C	Startup Screen	1-2-4, p 41
Frequency Counter Mode Screen		SWR	1-2-4, p 56
Description	1-2-4, p 31	VOR	1-2-4, p 42
Operation	1-2-4, p 58	Operating Procedures	1-2-4, p 41
Functional Capabilities	1-1-1, p 1		
		Performance Evaluation	1-2-3, p 1
General Description and Capabilities	1-1-1, p 1	General	1-2-3, p 1
Glideslope Mode Screen		Self Test	1-2-3, p 1
Description	1-2-4, p 15	Self Test Failures	1-2-3, p 2
Operation	1-2-4, p 46	PWR MTR ZERO Screen	1-2-4, p 27
Guided Test Screens			
Creating a Sequence	1-2-4, p 60	Remote Connector Pin-Out Table	App A, p 2, 3
Deleting a Sequence	1-2-4, p 62	Repacking Procedure	1-4-1, p 1
Description	1-2-4, p 4		
Download Sequences through a		RS-232 Settings Screen	1-2-4, p 8
Remote Connection	1-2-4, p 63		
Playing a Sequence	1-2-4, p 62		
Upload Sequences through a			
Remote Connection	1-2-4, p 64		
Hardware Tools Screen	1-2-4, p 7		



Safety Precautions	1-2-1, p 1
Screen Descriptions	1-2-4, p 2
121.5/243 Beacon Mode Screen	1-2-4, p 32
406 Beacon Mode Screen	1-2-4, p 34
Calibration Screen	1-2-4, p 10
COMM AM Mode Screen	1-2-4, p 21
COMM FM Mode Screen	1-2-4, p 23
COMM SSB Mode Screen	1-2-4, p 25
Diagnostics Screen	1-2-4, p 8
Frequency Counter Mode Screen	1-2-4, p 31
Glideslope Mode Screen	1-2-4, p 15
Guided Test Screens	1-2-4, p 4
Hardware Tools Screen	1-2-4, p 7
ILS Mode Screen	1-2-4, p 18
Info Screen	1-2-4, p 10
Localizer Mode Screen	1-2-4, p 13
Marker Beacon Mode Screen	1-2-4, p 17
PWR MTR ZERO Screen	1-2-4, p 27
RS-232 Settings Screen	1-2-4, p 8
Self Test Screen	1-2-4, p 9
SELCAL Mode Screen	1-2-4, p 30
Setup Menu	1-2-4, p 3
Startup Screen	1-2-4, p 2
Store/Recall Screens	1-2-4, p 6
SWR Mode Screen	1-2-4, p 27
VOR Mode Screen	1-2-4, p 11
SELCAL Mode Screen	
Description	1-2-4, p 30
Operation	1-2-4, p 57
Self Test	1-2-3, p 1
Failures	1-2-3, p 2
Screen Description	1-2-4, p 9
Serial Interface Cable	App E
Setup Menu	
Description	1-2-4, p 2
Operation	1-2-4, p 41
Shipping	1-4-1, p 1
Specifications	
Meter Functions	1-3-1, p 10
Miscellaneous	1-3-1, p 12
Operational Modes	1-3-1, p 4
RF Signal Generator	1-3-1, p 1
Start-Up Screen	
Description	1-2-4, p 2
Operation	1-2-4, p 41
Storage	1-5-1, p 1
Store/Recall Screens	1-2-4, p 6
SWR Mode Screen	
Description	1-2-4, p 27
Operation	1-2-4, p 56
VOR Mode Screen	
Description	1-2-4, p 11
Operation	1-2-4, p 42



OPERATION MANUAL
IFR 4000

FOR QUALIFIED SERVICE PERSONNEL ONLY

BATTERY/VOLTAGE INSTRUCTIONS



THIS PAGE INTENTIONALLY LEFT BLANK.

SAFETY FIRST: TO ALL SERVICE PERSONNEL

REFER ALL SERVICING OF UNIT TO QUALIFIED TECHNICAL PERSONNEL.

WARNING: USING THIS EQUIPMENT IN A MANNER NOT SPECIFIED BY THE ACCOMPANYING DOCUMENTATION MAY IMPAIR THE SAFETY PROTECTION PROVIDED BY THE EQUIPMENT.

CASE, COVER OR PANEL REMOVAL

Opening the Case Assembly exposes the technician to electrical hazards that can result in electrical shock or equipment damage.

SAFETY IDENTIFICATION IN TECHNICAL MANUAL

This manual uses the following terms to draw attention to possible safety hazards, that may exist when operating or servicing this equipment.

CAUTION: THIS TERM IDENTIFIES CONDITIONS OR ACTIVITIES THAT, IF IGNORED, CAN RESULT IN EQUIPMENT OR PROPERTY DAMAGE (E.G., FIRE).

WARNING: THIS TERM IDENTIFIES CONDITIONS OR ACTIVITIES THAT, IF IGNORED, CAN RESULT IN PERSONAL INJURY OR DEATH.

SAFETY SYMBOLS IN MANUALS AND ON UNITS



CAUTION: Refer to accompanying documents. (This symbol refers to specific CAUTIONS represented on the unit and clarified in the text.)



AC OR DC TERMINAL: Terminal that may supply or be supplied with ac or dc voltage.



DC TERMINAL: Terminal that may supply or be supplied with dc voltage.



AC TERMINAL: Terminal that may supply or be supplied with ac or alternating voltage.

EQUIPMENT GROUNDING PRECAUTION

Improper grounding of equipment can result in electrical shock.

USE OF PROBES

Check specifications for the maximum voltage, current and power ratings of any connector on the Test Set before connecting it with a probe from a terminal device. Be sure the terminal device performs within these specifications before using it for measurement, to prevent electrical shock or damage to the equipment.

POWER CORDS

Power cords must not be frayed, broken nor expose bare wiring when operating this equipment.

USE RECOMMENDED FUSES ONLY

Use only fuses specifically recommended for the equipment at the specified current and voltage ratings.

WARNING: THE IFR 4000 USES A LITHIUM ION BATTERY PACK. THE FOLLOWING WARNINGS CONCERNING LITHIUM ION BATTERIES MUST BE HEEDED:

- DO NOT RECHARGE OUTSIDE THE IFR 4000.
- DO NOT CRUSH, INCINERATE OR DISPOSE OF IN NORMAL WASTE.
- DO NOT SHORT CIRCUIT OR FORCE DISCHARGE AS THIS MIGHT CAUSE THE BATTERY TO VENT, OVERHEAT OR EXPLODE.

CAUTION: INTEGRATED CIRCUITS AND SOLID STATE DEVICES SUCH AS MOS FETS, ESPECIALLY CMOS TYPES, ARE SUSCEPTIBLE TO DAMAGE BY ELECTROSTATIC DISCHARGES RECEIVED FROM IMPROPER HANDLING, THE USE OF UNGROUNDED TOOLS AND IMPROPER STORAGE AND PACKAGING. ANY MAINTENANCE TO THIS UNIT MUST BE PERFORMED WITH THE FOLLOWING PRECAUTIONS:

- BEFORE USE IN A CIRCUIT, KEEP ALL LEADS SHORTED TOGETHER EITHER BY THE USE OF VENDOR-SUPPLIED SHORTING SPRINGS OR BY INSERTING LEADS INTO A CONDUCTIVE MATERIAL.
- WHEN REMOVING DEVICES FROM THEIR CONTAINERS, GROUND THE HAND BEING USED WITH A CONDUCTIVE WRISTBAND.
- TIPS OF SOLDERING IRONS AND/OR ANY TOOLS USED MUST BE GROUNDED.
- DEVICES MUST NEVER BE INSERTED INTO NOR REMOVED FROM CIRCUITS WITH POWER ON.
- PC BOARDS, WHEN TAKEN OUT OF THE SET, MUST BE LAID ON A GROUNDED CONDUCTIVE MAT OR STORED IN A CONDUCTIVE STORAGE BAG. REMOVE ANY BUILT-IN POWER SOURCE, SUCH AS A BATTERY, BEFORE LAYING PC BOARDS ON A CONDUCTIVE MAT OR STORING IN A CONDUCTIVE BAG.
- PC BOARDS, IF BEING SHIPPED TO THE FACTORY FOR REPAIR, MUST BE PACKAGED IN A CONDUCTIVE BAG AND PLACED IN A WELL-CUSHIONED SHIPPING CONTAINER.



CAUTION: SIGNAL GENERATORS CAN BE A SOURCE OF ELECTROMAGNETIC INTERFERENCE (EMI) TO COMMUNICATION RECEIVERS. SOME TRANSMITTED SIGNALS CAN CAUSE DISRUPTION AND INTERFERENCE TO COMMUNICATION SERVICES OUT TO A DISTANCE OF SEVERAL MILES. USERS OF THIS EQUIPMENT SHOULD SCRUTINIZE ANY OPERATION THAT RESULTS IN RADIATION OF A SIGNAL (DIRECTLY OR INDIRECTLY) AND ENSURE COMPLIANCE WITH INSTRUCTIONS IN FAA CIRCULAR AC 170-6C, DATED FEBRUARY 19, 1981.

FOR QUALIFIED SERVICE PERSONNEL ONLY

FUSE REPLACEMENT

Refer to Figure 1.

STEP	PROCEDURE
1.	Verify the IFR 4000 is OFF and not connected to AC power.
2.	Fully loosen two captive screws in the two lower bumpers and remove the bumpers.
3.	Fully loosen five captive screws and lift the Battery Cover from the Case Assembly.
4.	Replace fuse: 5 A, 32 Vdc, Type F (Mini Blade Fuse) (Aeroflex PN: 5106-0000-057)
	CAUTION: FOR CONTINUOUS PROTECTION AGAINST FIRE, REPLACE ONLY WITH FUSES OF THE SPECIFIED VOLTAGE AND CURRENT RATINGS.
5.	Install the Battery Cover on the Case Assembly and tighten the five captive screws (8 in/lbs.).
6.	Install the two lower bumpers and tighten the two captive screws in each bumper (8 in/lbs.).

BATTERY REPLACEMENT

Refer to Figure 1.

STEP	PROCEDURE
1.	Verify the IFR 4000 is OFF and not connected to AC power.
2.	Fully loosen two captive screws in the two lower bumpers and remove the bumpers.
3.	Fully loosen five captive screws and lift the Battery Cover from the Case Assembly.
4.	Disconnect the wire harness connecting the battery to the Test Set and remove the battery.
5.	Install new battery and reconnect the wire harness.
6.	Install the Battery Cover on the Case Assembly and tighten the five captive screws (8 in/lbs.).
7.	Install the two lower bumpers and tighten the two captive screws in each bumper (8 in/lbs.).
	WARNING: DISPOSE OF OLD BATTERY ACCORDING TO LOCAL STANDARD SAFETY PROCEDURES.
	 CAUTION: REPLACE ONLY WITH THE BATTERY SPECIFIED BY AEROFLEX. DO NOT ATTEMPT TO INSTALL A NON-RECHARGEABLE BATTERY.

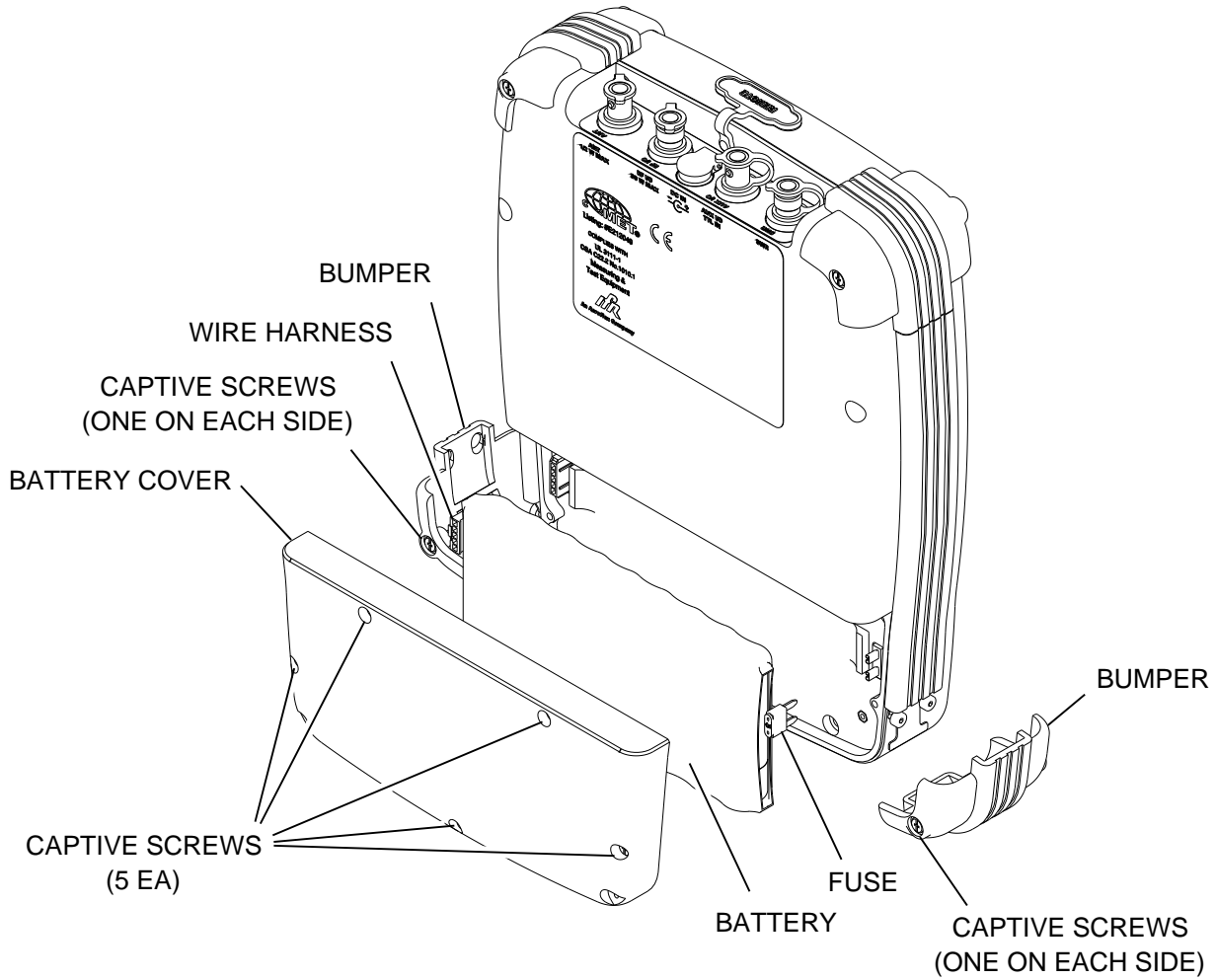

056P-04

Battery and Fuse Replacement
Figure 1

As we are always seeking to improve our products, the information in this document gives only a general indication of the product capacity, performance and suitability, none of which shall form part of any contract. We reserve the right to make design changes without notice.

CHINA / Beijing	Tel: [+86] (10) 6539 1166	Fax: [+86] (10) 6539 1778
CHINA / Shanghai	Tel: [+86] (21) 5109 5128	Fax: [+86] (21) 6457 7668
FINLAND	Tel: [+358] (9) 2709 5541	Fax: [+358] (9) 804 2441
FRANCE	Tel: [+33] 1 60 79 96 00	Fax: [+33] 1 60 77 69 22
GERMANY	Tel: [+49] 8131 2926-0	Fax: [+49] 8131 2926-130
HONG KONG	Tel: [+852] 2832 7988	Fax: [+852] 2834 5364
INDIA	Tel: [+91] (0) 80 4115 4501	Fax: [+91] (0) 80 4115 4502
JAPAN	Tel: [+81] 3 3500 5591	Fax: [+81] 3 3500 5592
KOREA	Tel: [+82] (2) 3424 2719	Fax: [+82] (2) 3424 8620
SCANDINAVIA	Tel: [+45] 9614 0045	Fax: [+45] 9614 0047
*SINGAPORE	Tel: [+65] 6873 0991	Fax: [+65] 6873 0992
SPAIN	Tel: [+34] (91) 640 11 34	Fax: [+34] (91) 640 06 40
UK / Cambridge	Tel: [+44] (0) 1763 262277	Fax: [+44] (0) 1763 285353
*UK / Stevenage	Tel: [+44] (0) 1438 742200	Fax: [+44] (0) 1438 727601
	Freephone: 0800 282388	
*USA	Tel: [+1] (316) 522 4981	Fax: [+1] (316) 522 1360
	Toll Free: 800 835 2352	

* Indicates Regional Service Center



EXPORT CONTROL WARNING: This document contains controlled technology or technical data under the jurisdiction of the Export Administration Regulations (EAR), 15 CFR 730-774. It cannot be transferred to any foreign third party without the specific prior approval of the U.S. Department of Commerce, Bureau of Industry and Security (BIS). Violations of these regulations are punishable by fine, imprisonment, or both.



Our passion for performance is defined by three attributes represented by these three icons: solution-minded, performance-driven, customer-focused.