

<典型性能参数>

输入电压与PF值

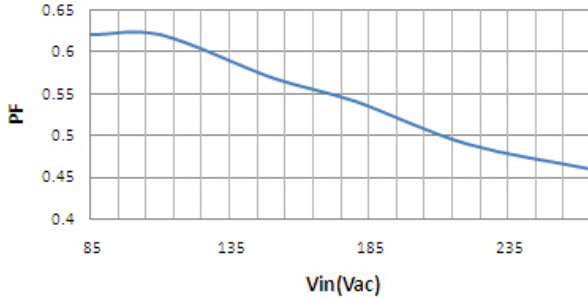

输入电压和输出电流

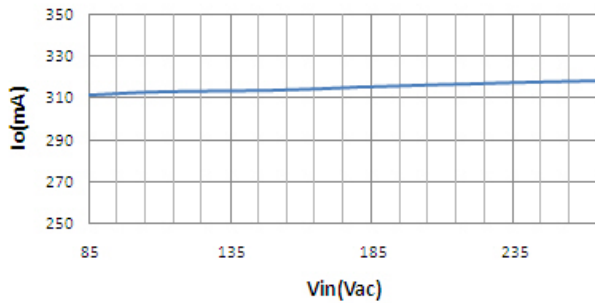

输入电压和效率

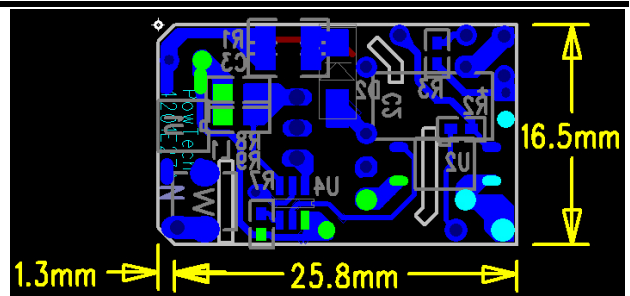
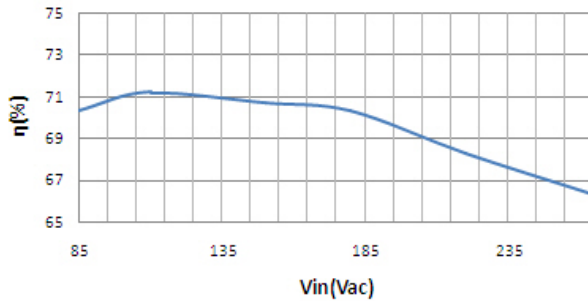

<变压器>

PC40EI12.5

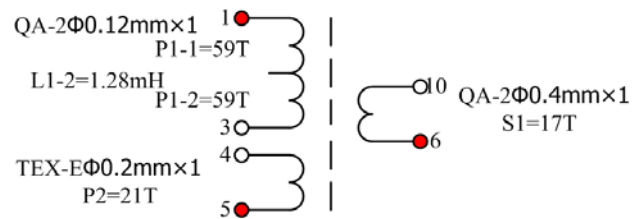
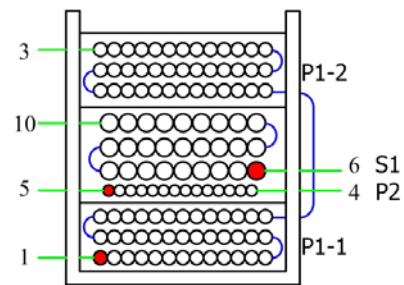

<BOM>

<PCB 布局>

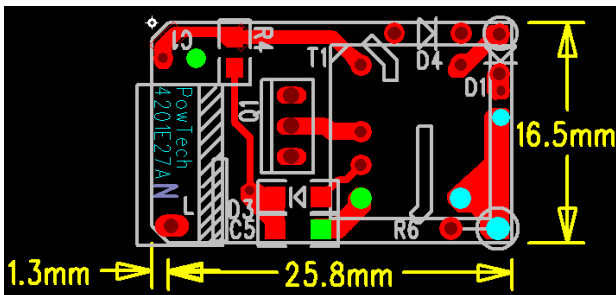

标号	描述	供应商
C1	电解电容,4.7uF/400V,8×12.5mm	Sawha
C2	电解电容,100uF/16V,5×8mm	Sawha
C3	陶瓷电容,2200pF/1kV,1206	KYOCERA MITA
C5	陶瓷电容,4.7uF/50V,1206	KYOCERA MITA
D1	肖特基二极管,SR1100,DIP	On semi
D2	快速恢复二极管,S1J,SMD	MCC semi
D3	快速恢复二极管,FR102,SMD	Vishay
D4	稳压管,12V/0.5W,DIP	Microsemi Corp
L1	功率电感,220uH/0.1A,SMD	Coilcraft
R1	贴片电阻,200KΩ,5%,1206	TA-I
R2,R3	贴片电阻,100Ω,5%,0603	TA-I
R4	贴片电阻,1.5MΩ,5%,0805	TA-I
R6	金属膜电阻,3.3Ω/0.5W,1%,DIP	TA-I
R7	贴片电阻,100KΩ,1%,0603	TA-I
R8,R9	贴片电阻,5.1Ω,1%,0805	TA-I
U1	整流桥,MB6S,SMD	Diodes Inc
U2	光耦,TLP181,SMD	Toshiba
U4	PWM控制器,PT4201,SOT23-6	PowTech
Q1	MOSFET,N-Channel,1N60	UTC
T1	变压器,PC40EI12.5	海宁联丰东进

E27 5W

芯片	拓扑结构	输入电压范围	输出电压	输出功率	LED 数量
PT4201	反激式	85V~265VAC	22V	5W	5

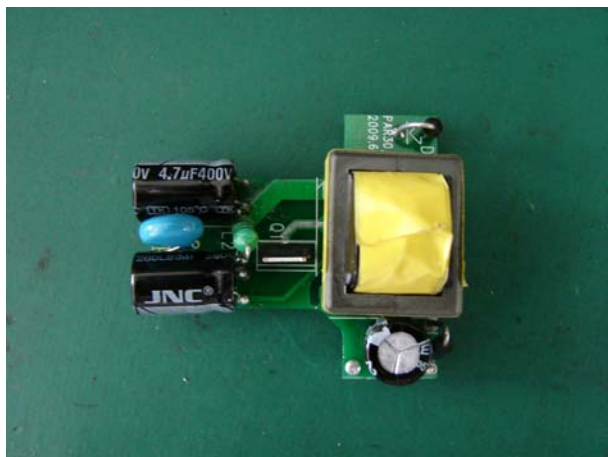

<参考应用线路>

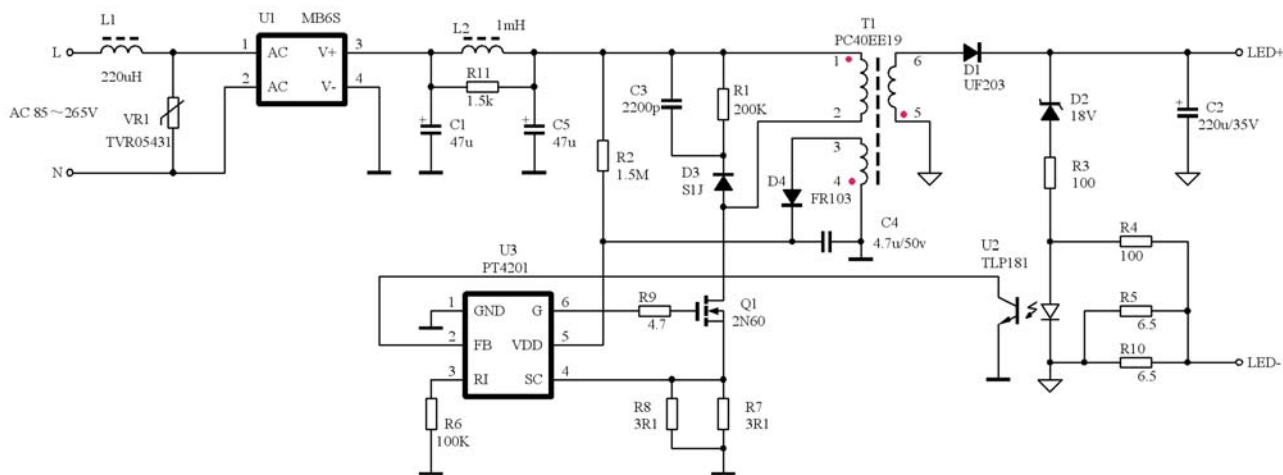

<典型性能参数>

输入电压与PF值

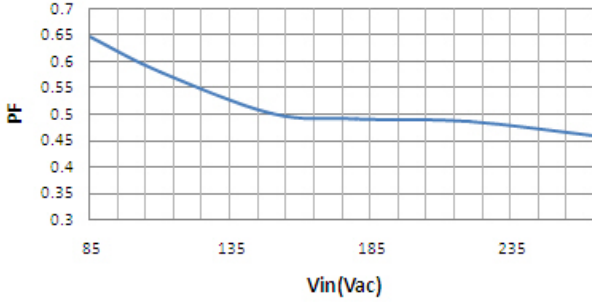

输入电压和输出电流

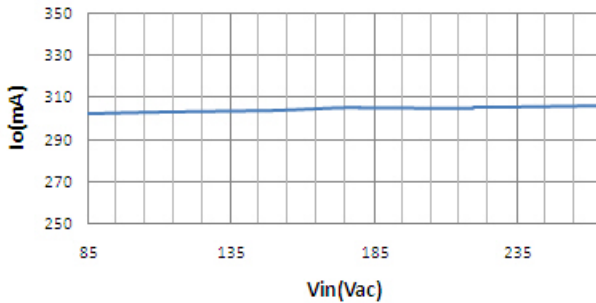

输入电压和效率

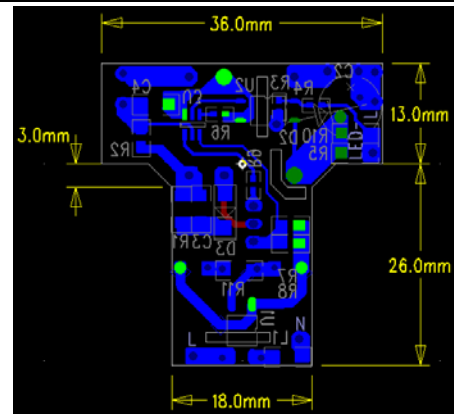
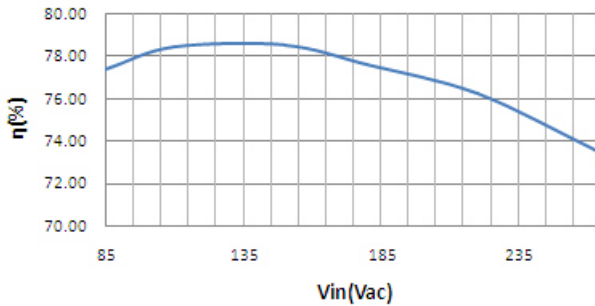

<变压器>

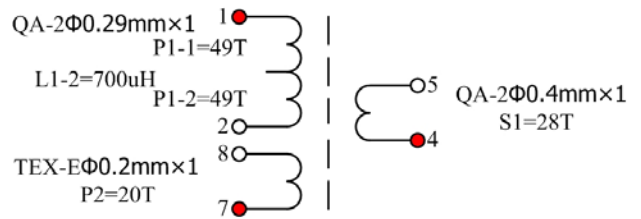
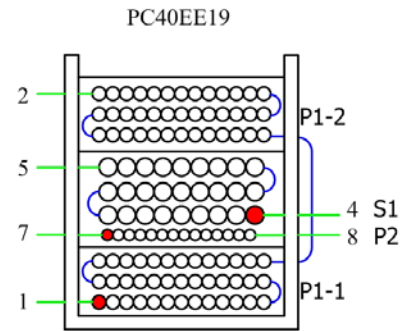

<BOM>

<PCB 布局>

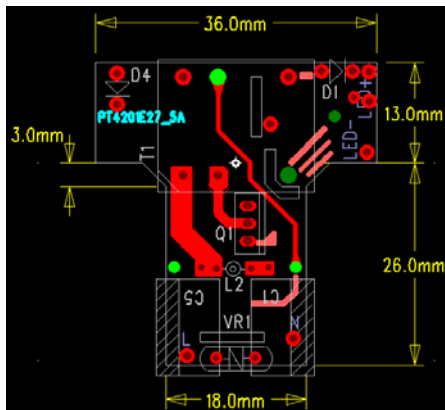

标号	描述	供应商
C1,C5	电解电容,4.7uF/400V,8×12.5mm	Sawha
C2	电解电容,220uF/35V,8×11.5mm	Sawha
C3	陶瓷电容,2200pF/1kV,1206	KYOCERA MITA
C4	陶瓷电容,4.7uF/50V,1206	KYOCERA MITA
D1	快速恢复二极管,UF203,DIP	PANJIT
D2	稳压管,18V/0.5W,DIP	Microsemi Corp
D3	快速恢复二极管,S1J	MCC semi
D4	快速恢复二极管,FR103,DIP	Vishay
L1	功率电感,220uH/0.1A,SMD	Coilcraft
L2	色环电感,1mH,0410,DIP	Amode Tech
R1	贴片电阻,200KΩ,5%,1206	TA-I
R2	贴片电阻,1.5MΩ,5%,0805	TA-I
R3,R4	贴片电阻,100Ω,5%,0603	TA-I
R5,R10	贴片电阻,6.5Ω,1%,1206	TA-I
R6	贴片电阻,100KΩ,1%,0603	TA-I
R7,R8	贴片电阻,3Ω,1%,0805	TA-I
R11	贴片电阻,1.5KΩ,5%,1206	TA-I
U1	整流桥,MB6S,SMD	Diodes Inc
U2	光耦,TLP181,SMD	Toshiba
U3	PWM控制器,PT4201,SOT23-6	PowTech
Q1	MOSFET,N-Channel,2N60	UTC
T1	变压器,PC40EE19	PowTech
VR1	压敏电阻,TVR05431,DIP	Thinking

PAR30 7W

芯片	拓扑结构	输入电压范围	输出电压	输出功率	LED 数量
PT4201	反激式	85V~265VAC	27V	7W	7

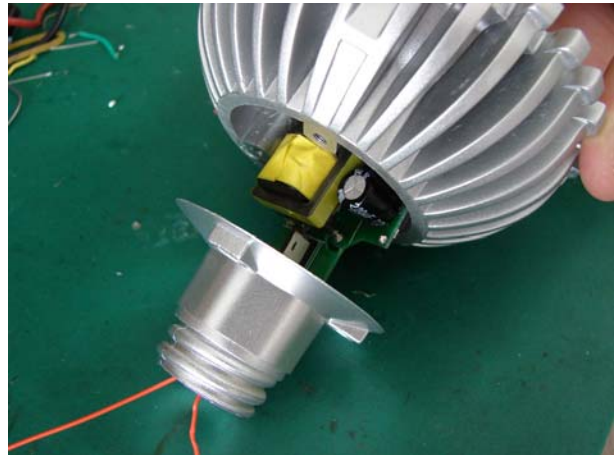
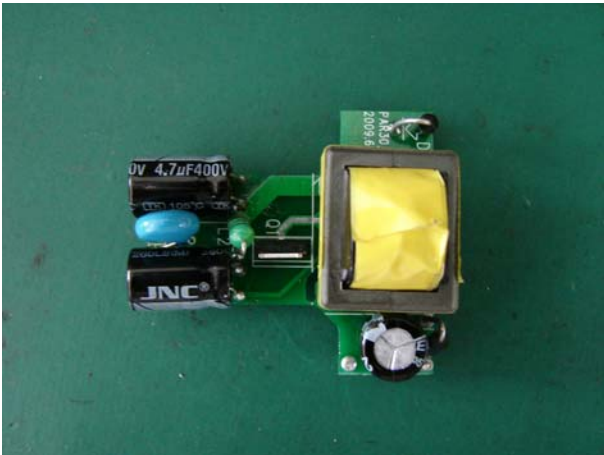

<参考应用线路>

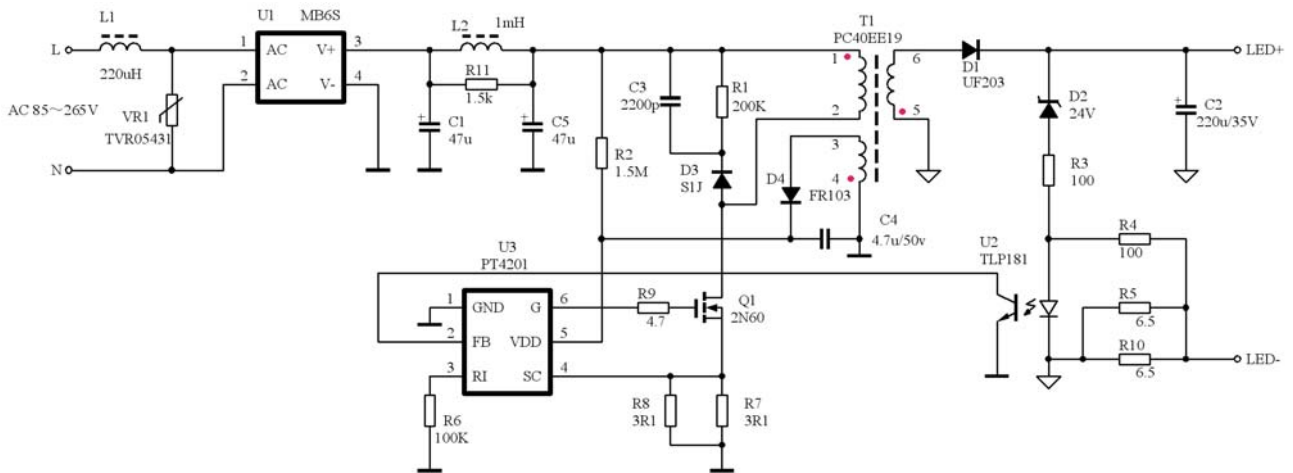

<典型性能参数>

输入电压与PF值

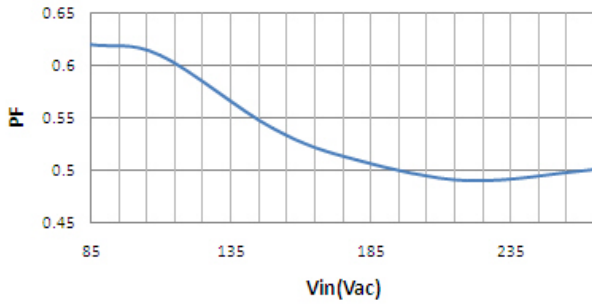

输出电流和输入电压

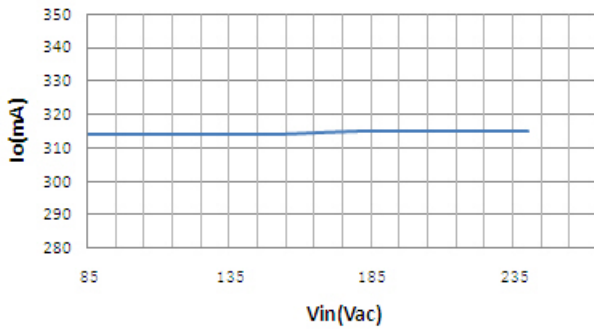

效率和输入电压

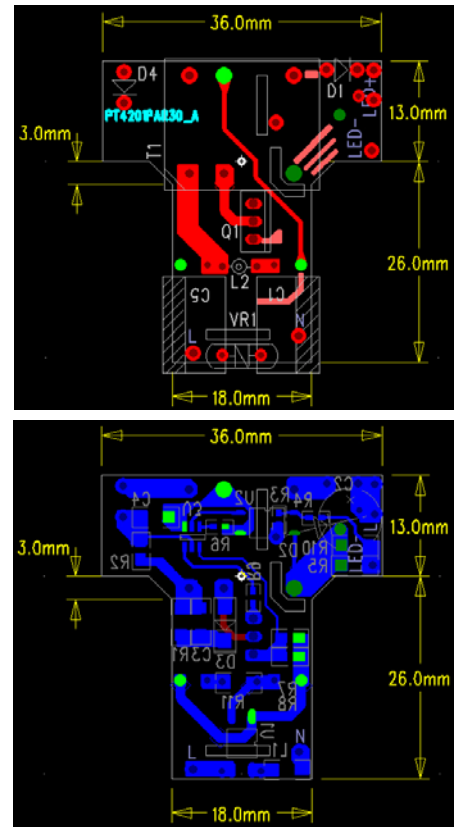
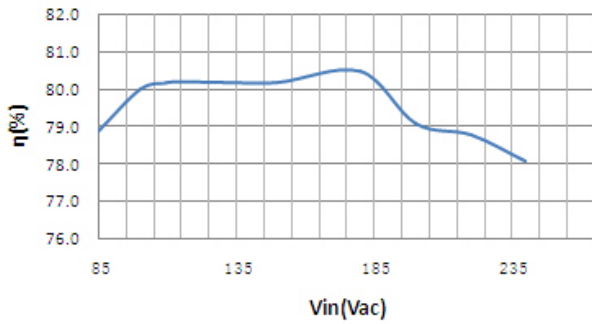

<变压器>

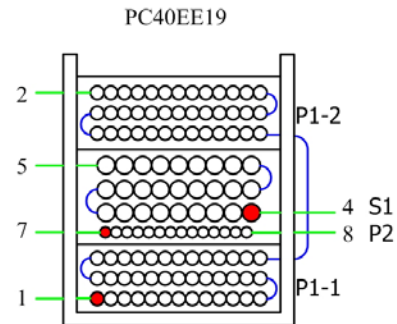

<PCB 布局>

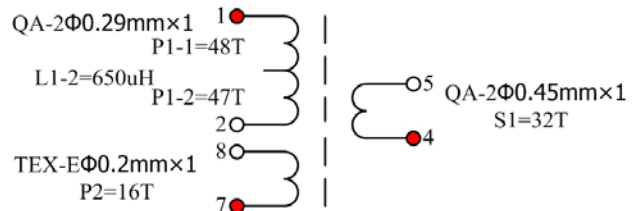

<BOM>

标号	描述	供应商
C1,C5	电解电容,4.7uF/400V,8×12.5mm	Sawha
C2	电解电容,220uF/35V,8×11.5mm	Sawha
C3	陶瓷电容,2200pF/1kV,1206	KYOCERA MITA
C4	陶瓷电容,4.7uF/50V,1206	KYOCERA MITA
D1	快速恢复二极管,UF203,DIP	PANJIT
D2	稳压管,24V/0.5W,DIP	Microsemi Corp
D3	快速恢复二极管,S1J	MCC semi
D4	快速恢复二极管,FR103,DIP	Vishay
L1	功率电感,220uH/0.1A,SMD	Coilcraft
L2	色环电感,1mH,0410,DIP	Amode Tech
Q1	MOSFET,N-Channel,2N60	UTC
R1	贴片电阻,200KΩ,5%,1206	TA-I
R2	贴片电阻,1.5MΩ,5%,0805	TA-I
R3,R4	贴片电阻,100Ω,5%,0603	TA-I
R5,R10	贴片电阻,6.5Ω,1%,1206	TA-I
R6	贴片电阻,100KΩ,1%,0603	TA-I
R7,R8	贴片电阻,3Ω,1%,0805	TA-I
R9	贴片电阻,4.7Ω,5%,0603	TA-I
R11	贴片电阻,1.5KΩ,5%,1206	TA-I
U1	整流桥,MB6S,SMD	Diodes Inc
U2	光耦,TLP181,SMD	Toshiba
U3	PWM控制器,PT4201,SOT23-6	PowTech
T1	变压器,PC40EE19	PowTech
VR1	压敏电阻,TVR05431,DIP	Thinking

PAR38 12W

芯片	拓扑结构	输入电压范围	输出电压	输出功率	LED 数量
PT4201	反激式	85V~265VAC	45V	12W	12

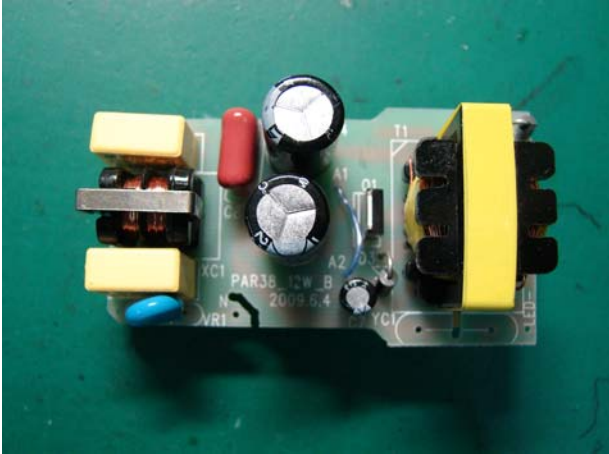

<参考应用线路>

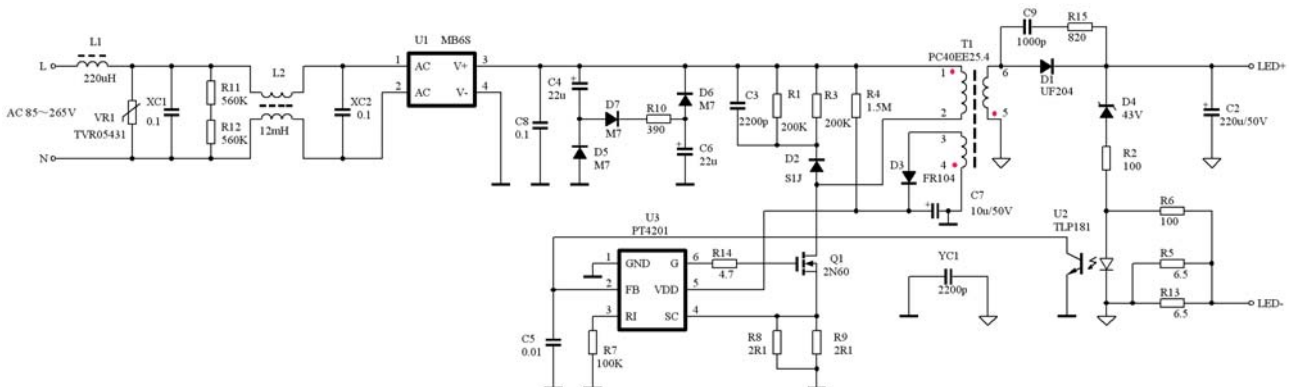

<典型性能参数>

输入电压与PF值

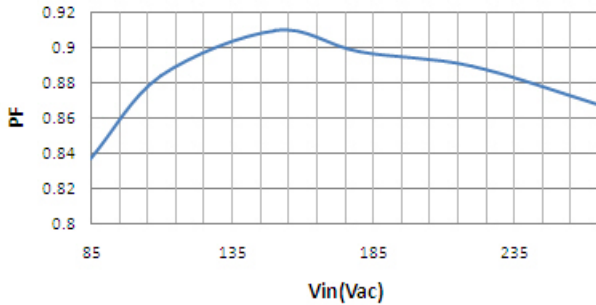

输入电压和输出电流

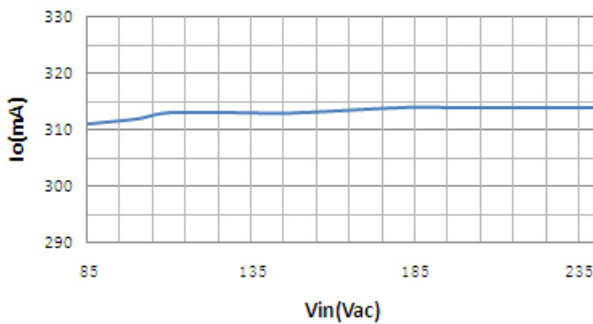

输入电压和效率

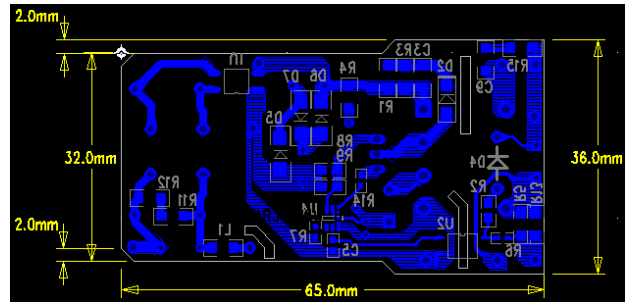
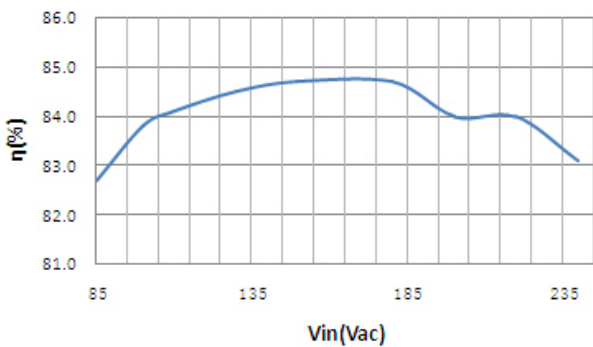

<变压器>

PC40EE25.4-Z

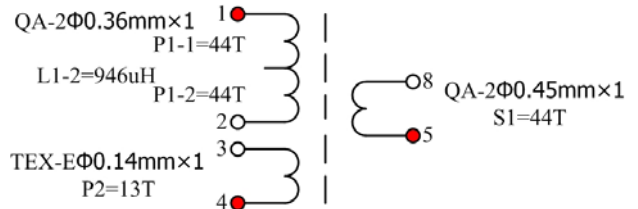
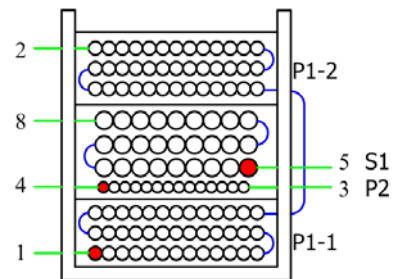

<BOM>

<PCB 布局>

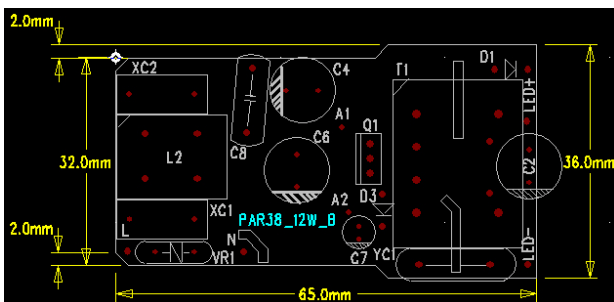

标号	描述	供应商
C2	电解电容,220uF/50V,10×12.5mm	Sawha
C3	陶瓷电容,2200pF/1kV,1206	KYOCERA MITA
C4,C6	电解电容,22uF/250V,10×16mm	Sawha
C5	陶瓷电容,0.01uF/10V,0603	KYOCERA MITA
C7	电解电容,10uF/50V,5×11mm	Sawha
C8	CBB电容,0.1uF/400V,DIP	GRP
C9	陶瓷电容,1000pF/50V,1206	Murata
D1	快速恢复二极管,UF204,DIP	PANJIT
D2	快速恢复二极管,S1J	MCC semi
D3	快速恢复二极管,FR104,DIP	Vishay
D4	稳压管,43V/0.5W,DIP	Microsemi Corp
D5,D6,D7	整流二极管,M7,SMD	JRT
L1	功率电感,220uH/0.2A,SMD	Coilcraft
L2	共模电感,12mH/1A,UU 10.5 Bobbin	PowTech
Q1	MOSFET,N-Channel,2N60	UTC
R1,R3	贴片电阻,200KΩ,5%,1206	TA-I
R2,R6	贴片电阻,100Ω,5%,0603	TA-I
R4	贴片电阻,1.5MΩ,5%,0805	TA-I
R5,R13	贴片电阻,6.5Ω,1%,1206	TA-I
R7	贴片电阻,100KΩ,1%,0603	TA-I
R8,R9	贴片电阻,2Ω,1%,0805	TA-I
R10	金属膜电阻,390Ω/1W,5%,DIP	SAMSUNG
R11,R12	贴片电阻,560KΩ,5%,1206	TA-I
R14	贴片电阻,4.7Ω,5%,0603	TA-I
R15	贴片电阻,820Ω,5%,1206	TA-I
U1	整流桥,MB6S,SMD	Diodes Inc
U2	光耦,TLP181,SMD	Toshiba
U3	PWM控制器,PT4201,SOT23-6	PowTech
T1	变压器,PC40EE25.4	PowTech
VR1	压敏电阻,TVR05431,DIP	Thinking
XC1,XC2	安规电容,0.1uF/250Vac,DIP	Vishay
YC1	Y电容,2200pF/275Vac,DIP	Vishay