

Monitoring Relays

3-Phase Active power

Types DWB02, PWB02

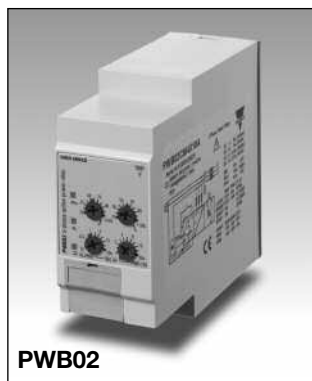

- TRMS active power relays for three phase balanced applications
- Measuring if active power is within set limits
- Measuring voltage on own power supply
- Measuring ranges: 5A, 10A, MI current transformers
- Power ON delay 1 to 30 s knob selectable
- Separately adjustable upper/lower level on relative scale
- Programmable latching or inhibit at set level
- Automatic and manual start and stop of the system
- Output: 8 A SPDT relay N.D. or N.E. selectable
- For mounting on DIN-rail in accordance with DIN/EN 50 022 (DWB02) or plug-in module (PWB02)
- 45 mm Euronorm housing (DWB02) or 36 mm plug-in module (PWB02)
- LED indication for relay, alarm and power supply ON

Product Description

DWB02 and PWB02 are precise TRMS active power monitoring relays for 3-phase balanced systems. They can be used for monitoring the actual load of asynchronous motors and other symmetrical loads, as well as the power consumption by of system.

Start/stop input allows to use a manual switch to start and

stop the system, without the need of an auxiliary device.

The advantage of using the latch function is that the alarm status can be kept even after the end of the alarm condition. Inhibit function can be used to avoid relay operation when not desired (maintenance, transitions).

The LED's indicate the state of the alarm and the output relay.

Ordering key **DWB 02 C M48 10A**

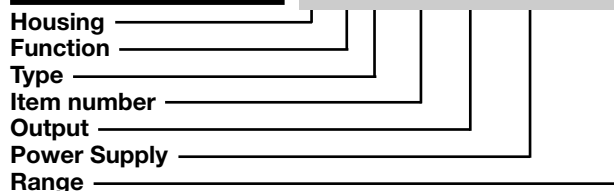

Type Selection

Mounting	Output	Supply: 208 to 240 VAC	Supply: 380 to 415 VAC	Supply: 380 to 480 VAC	Supply: 600 to 690 VAC
DIN-rail	SPDT	DWB 02 C M23 10A		DWB 02 C M48 10A	DWB02 C M69 10A
Plug-in	SPDT	PWB 02 C M23 10A	PWB 02 C M48 10A		

Input Specifications

Input	Supply	Standard CT (examples)	5 to 50 A	60 A
Voltage (Own power supply): 3 - phase	DWB02: PWB02: M23: DWB02CM48: PWB02CM48: DWB02CM69: DWB02CM23: PWB02CM23:	L1, L2, L3 5, 6, 7 208 to 240 VAC ± 15% 380 to 480 VAC ± 15% 380 to 415 VAC ± 15% 600 to 690 VAC ± 15% L1, L2 5, 6 208 to 240 VAC ± 15%	TADK2 50 A/5 A TAD2 150 A/5 A TAD6 400 A/5 A TAD12 1000 A/5 A TACO200 6000 A/5 A	15 to 150 A 40 to 400 A 100 to 1000 A 600 to 6000 A
1- phase	DWB02CM23: PWB02CM23:	L1, L2 5, 6 208 to 240 VAC ± 15%	MI CT ranges MI 100 MI 500	1200 A 7200 A 10 to 100 A 250 AAC 50 to 500 A 750 AAC
Current:	DWB02: PWB02:	5A, 10A: I1, I2 MI...:U1, U2 5A, 10A: 11, 10 MI...: 9, 8	Note: The input voltage cannot raise over 300 VAC with respect to ground (PWB02 only)	
Measuring ranges Active power		Upper level 10 to 110 % AACrms	Lower level 10 to 110 % Max. curr. (30s)	Terminals Z1, U2 Terminals 2, 9 > 10 kΩ < 500 Ω > 500 ms
Direct input:		0.5 to 5A 1 to 10A	30A 50A	
			Contact input DWB02 PWB02 Disabled Enabled Pulse width	
			Hysteresis	~ 2% of set value - fixed

Output Specifications

Output	SPDT relay
Rated insulation voltage	250 VAC
Contact ratings (AgSnO₂)	μ
Resistive loads AC 1	8 A @ 250 VAC
DC 12	5 A @ 24 VDC
Small inductive loads AC 15	2.5 A @ 250 VAC
DC 13	2.5 A @ 24 VDC
Mechanical life	≥ 30 x 10 ⁶ operations
Electrical life	≥ 10 ⁵ operations (at 8 A, 250 V, cos φ = 1)
Operating frequency	≤ 7200 operations/h
Dielectric strength	
Dielectric voltage	≥ 2 kVAC (rms)
Rated impulse withstand volt.	4 kV (1.2/50 μs)

Supply Specifications

Power supply	Overvoltage cat. III (IEC 60664, IEC 60038)
Rated operational voltage	
Through terminals:	
DWB02:	L1, L2, L3
PWB02:	5, 6, 7
M23	177 to 276 VAC 45 to 65 Hz
DWB02CM48	323 to 552 VAC 45 to 65 Hz
PWB02CM48	323 to 477 VAC 45 to 65 Hz
DWB02CM69	510 to 793 VAC 45 to 65 Hz
Dielectric voltage supply to output	4 kV
Rated operational power	
M23	9 VA @ 230 V, 50 Hz
M48	13 VA @ 400 V, 50 Hz
M69	21 VA @ 600 V, 50 Hz
Supplied by	L1 and L2

General Specifications

Power ON delay	1 to 30 s ± 0.5 s
Reaction time	(input signal variation from -20% to +20% or from +20% to -20% of set value)
Alarm ON delay	< 250 ms
Alarm OFF delay	< 250 ms
Accuracy	(15 min warm-up time)
Temperature drift	± 1000 ppm/°C
Delay ON alarm	± 10% on set value ± 50 ms
Repeatability	± 0.5% on full-scale
Indication for	
Power supply ON	LED, green
Alarm ON	LED, red (flashing 2 Hz during delay time)
Output relay ON	LED, yellow
Environment	
Degree of protection	IP 20
Pollution degree	3 (DWB02), 2 (PWB02)
Operating temperature	
@ Max. voltage, 50 Hz	-20 to +60°C, R.H. < 95%
@ Max. voltage, 60 Hz	-20 to +50°C, R.H. < 95%
Storage temperature	-30 to +80°C, R.H. < 95%
Housing dimensions	
DIN-rail version	45 x 80 x 99.5 mm
Plug-in version	36 x 80 x 94 mm
Weight	Approx. 250 g
Screw terminals	
Tightening torque	Max. 0.5 Nm acc. to IEC 60947
Approvals	UL, CSA
CE-Marking	Yes
EMC	Electromagnetic Compatibility
Immunity	According to EN 61000-6-2
Emission	According to EN 61000-6-3

Mode of Operation

DWB02 and PWB02 measure the active power of a 3-phase balanced system. The relay has an adjustable power ON delay in order to avoid undesired overload detection during motor start.

Example 1

Latching mode, relay NE
In this application DWB02 or PWB02 is connected to an external current metering transformer, type MI..., (connected between U1 & U2) as well as to a 3-phase asynchronous motor. The relay is energized as soon as the power supply is applied. After the power ON delay, the unit starts to measure power. If it is within the setpoints, the relay is ener-

gized, and the yellow LED is ON. As soon as the power drops below the lower setpoint or raises above the upper setpoint the output relay releases after the set time has expired. To restart the measurement, connect Z1 and U1 (2 and 9) or interrupt the power supply for at least 1 s.

Example 2

Non-latching mode, relay NE.
DWB02 and PWB02 react as described in the previous example 1 except that the relay reactivates automatically as soon as active power is back within the two setpoints again. When the measured power rises

above the adjusted upper level, the red LED starts flashing, and the output relay releases after the set time period. When the measured power drops below the adjusted lower level, the red LED starts flashing, and the output relay releases after the set time period.

Example 3:

DWB02CM2310A and PWB02CM2310A can be used for monitoring the power of a 1-Phase load with 208 to 240 V AC mains voltage. In this case the power supply has to be connected between L1, L2 (or 5, 6); L2 and L3 (or 6 and 7) have to be interconnected.

Example 4

Start/stop mode, relay NE.
In this application DWB02 or PWB02 are directly connected to a 3-phase asynchronous motor. The relay is energized as soon as the power supply is applied and the start/stop contact is closed. After the power ON delay, the unit starts to measure the active power. If it is within the setpoints the relay is energized. As soon as the power drops below the lower setpoint or raises above the upper setpoint the output relay releases and the red LED turns on after the set time has expired. When the start/stop contact is opened the relay is immediately de-energized. To

Mode of Operation (cont)

restart the system just connect the start/stop contact.

Note 1: to use the start/stop function the output relay has to command a contactor in series to the load (see last two wiring diagrams).

Note 2 (3-phase voltage): connect the 3-phase power supply to the terminals L1, L2 and L3 (DWB02) - 5, 6 and 7 (PWB02) taking care of the sequence.

Function/Range/Level/Time Setting

Select the desired function setting the DIP-switches 1 to 4 as shown on the right. Adjust the input range setting the DIP-switches 5 and 6. To access the DIP-switches open the plastic cover using a screwdriver as shown below. If DIP switch 3 is set to ON (start/stop) the position of DIP switch 4 does not affect the products' working mode.

Center knobs: Setting of upper and lower-level from 10 to 110% of nominal power.
 Lower left knob: Setting of delay on absolute scale: 0.1 to 30 s.
 Lower right knob: Setting of power ON delay on absolute scale: 1 to 30 s.

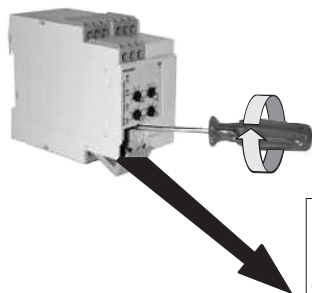

Input current range (terminals I1, I2 or 10, 11)
 ON: 10A
 OFF: 5A/MI

Relay status
 ON: Relay de-energized in normal condition
 OFF: Relay energized in normal condition

Working mode
 ON: Contact input for start/stop functions
 OFF: Contact input for latch/inhibit functions

Contact input (SW3 OFF)
 ON: Latch function enable
 OFF: Inhibit function enable

Measuring range

SW5	ON	ON	OFF	OFF
SW6	ON	OFF	ON	OFF
M23	208 VAC	220 VAC	230 VAC	240 VAC
M48	380 VAC	400 VAC	415 VAC	480 VAC DWB02 only
M69	600 VAC	690 VAC	600 VAC	690 VAC

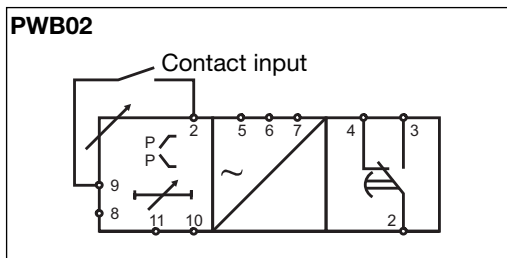
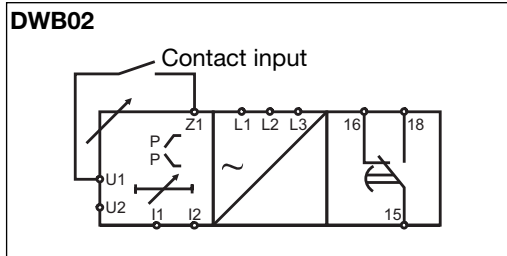

Notes
 1. DIP-switch 3 set ON enables the start/stop function that is managed by the closing-opening of the contact input.
 2. DIP-switch 3 set OFF enables the input contact for the latch/inhibit functions: the selection between these is allows by the DIP switch 4.

The following table shown as the input contact manages the mode of operation:

Contact input working mode

	CLOSED	OPEN
LATCH	NOT ACTIVE	ACTIVE
INHIBIT	ACTIVE	NOT ACTIVE
START/STOP	START	STOP

Wiring Diagrams

DWB02 - Direct connection

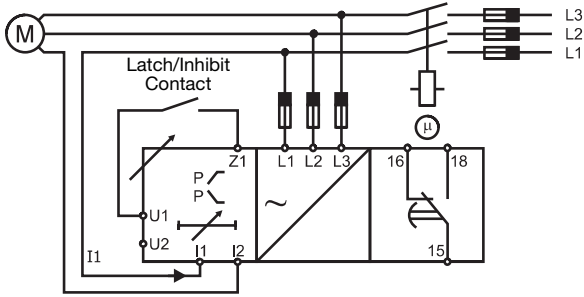

PWB02 - Direct connection

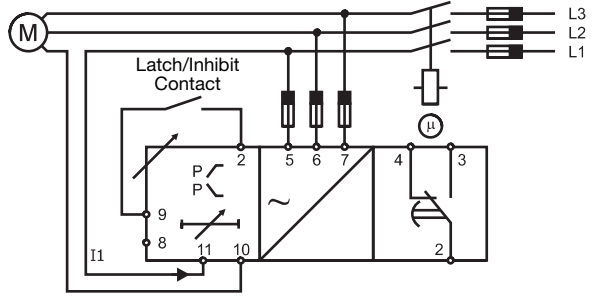

DWB02 - Standard CT

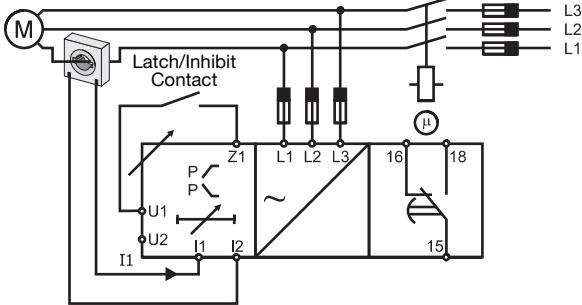

PWB02 - Standard CT

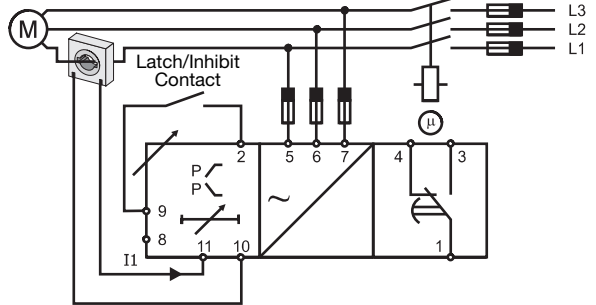

DWB02 - MI CT

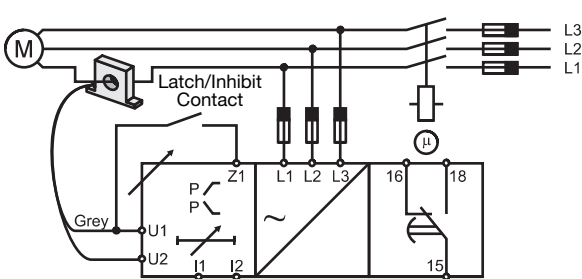

PWB02 - MI CT

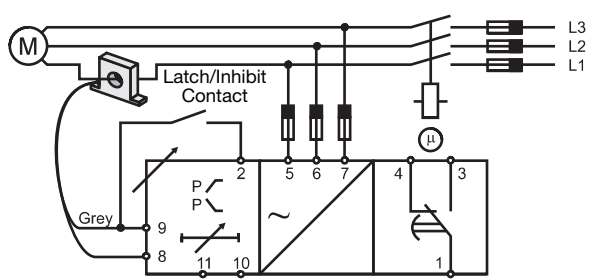

DWB02CM2310A - Direct connection - 1-Phase Load

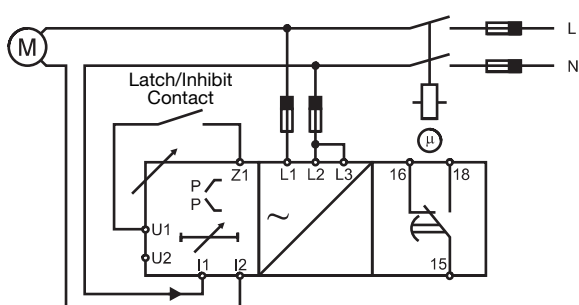

PWB02CM2310A - Direct connection - 1-Phase Load

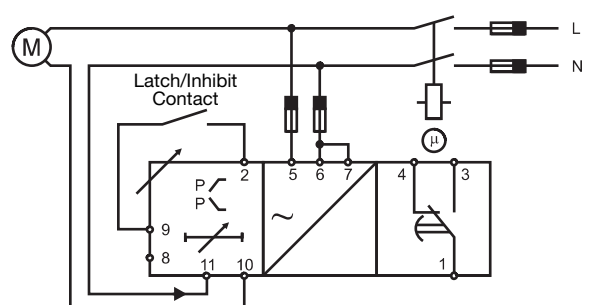

Wiring Diagrams (cont.)

With the start/stop function enabled, it's necessary to use the following wiring diagrams (which are two examples among many others). It is possible for both 3-phases loads and of 1-phase loads, either through direct connection or external current metering transformer.

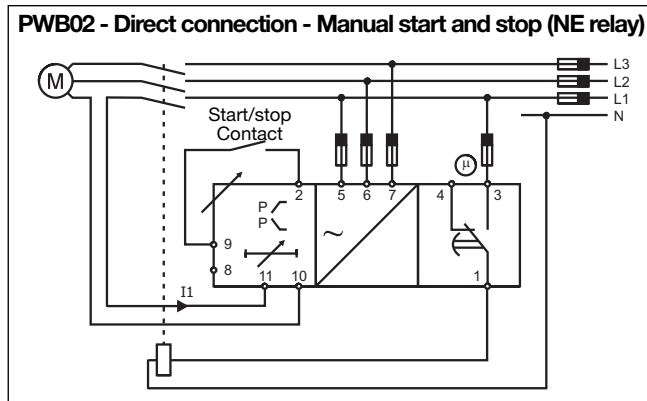
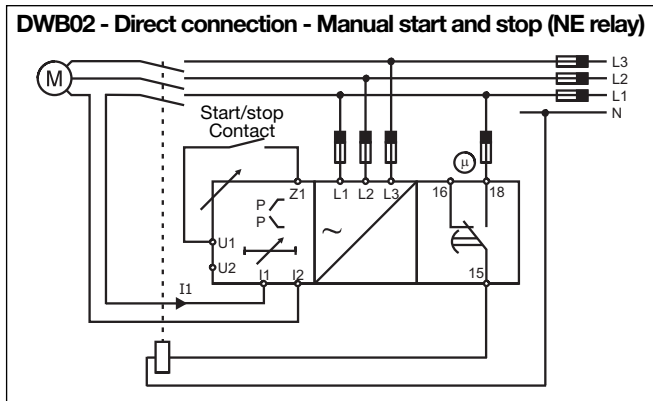

Operation Diagrams

Latch function - NE relay

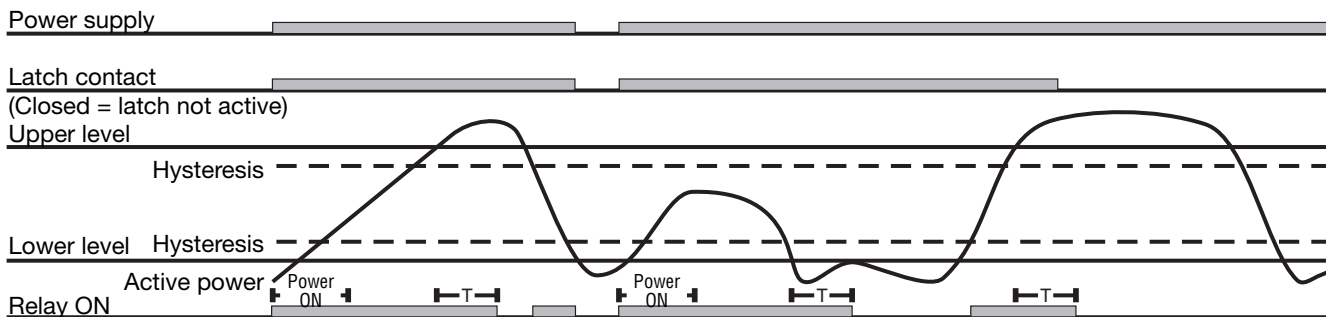

Inhibit function - ND relay

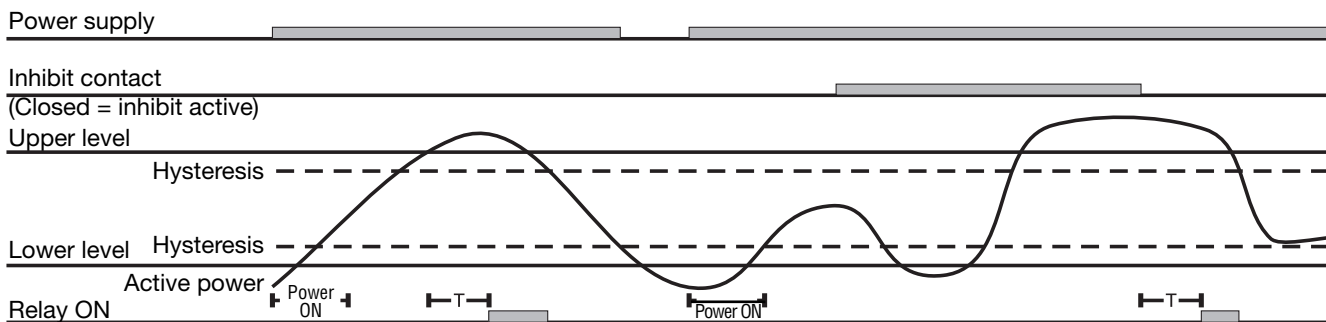

Start and stop function - NE relay

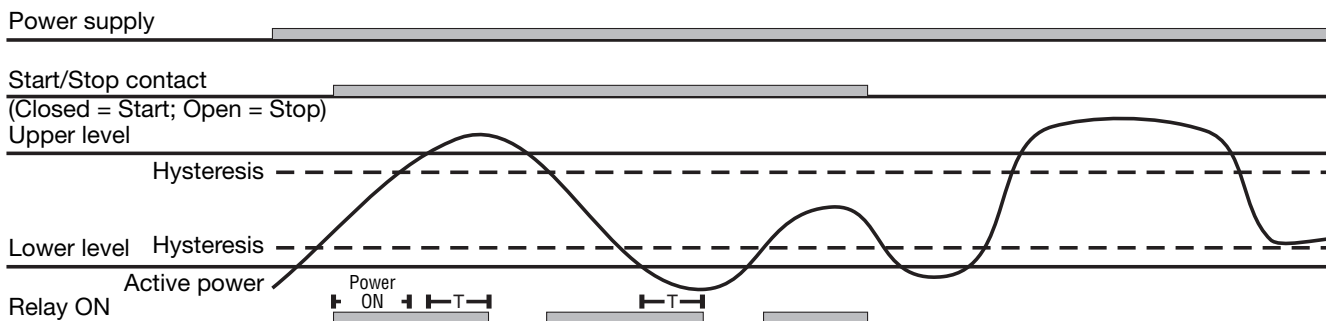

Dimensions

