

## Type HS Series

### Key Features

- Established product with proven reliability
  - Leading the way with over 50 years of design and manufacturing experience
- 5 Watts to 300 Watts (500 Watt and 1000 Watt versions available)
  - Largest range on the market
- Versatile product
  - Bench mark in every industry
- Custom designs
  - Windings, terminations, mountings - We have a solution for your application
- Low resistance, low inductance and higher voltage versions available
  - Specialising the standard



TE Connectivity are the leading European supplier of standard and custom designed aluminium housed resistors for general-purpose use, power supplies, power generation and the traction industry. The HS is a range of extremely stable, high quality wire wound resistors capable of dissipating high power in a limited space with relatively low surface temperature. The power is rapidly dissipated as heat through the aluminium housing to a specified heatsink.

The resistors are made from quality materials for optimum reliability and stability. TE can test resistors to conform to relevant international, MIL or customer specifications.

TE are happy to advise on the use of resistors for pulse applications and to supply information for high voltage use and low-ohmic value, alternative mountings and termination type.

### Applications

- Braking Resistor
- Balancing Resistor
- Capacitor Charging & Discharging
- Crowbar
- Filter
- Electrical Machinery general use
- Available through Distribution

### Characteristics - Electrical HSA & HSC - 5 Watts to 75 Watts

	HSA5	HSA10	HSA25	HSA50	HSC75
Dissipation @ 25°C with Heatsink (Watts):	10	16	25	50	75
Without Heatsink:	5.5	8	12.5	20	45
Ohmic Value Min (Ohms):	R01	R01	R01	R01	R05
Max:	10K	15K	36K	100K	50K
Max. Working Voltage (DC or ACrms) Volts:	160	265	550	1250	1400
Dielectric Strength (AC Peak) Volts:	1400	1400	2500	2500	5000
Stability (% resistance change, 1000 hours) (%):	1	1	1	1	2
Standard Heatsink - Area (mm <sup>2</sup> ):	41500	41500	53500	53500	99500
Thickness (mm):	1	1	1	1	3
Number of Mounting Holes:	2 hole	2 hole	2 hole	2 hole	4 hole

### Characteristics - Electrical HSC - 100 Watts to 300 Watts

	HSC100	HSC150	HSC200	HSC250	HSC300
Dissipation @ 25°C with Heatsink (Watts):	100	150	200	250	300
Without Heatsink:	50	55	50	60	75
Ohmic Value Min (Ohms):	R05	R10	R10	R10	R10
Max:	100K	100K	50K	68K	82K
Max. Working Voltage (DC or ACrms) Volts:	1900	2500	1900	2200	2500
Dielectric Strength (AC Peak) Volts:	5000	5000	5600	5600	5600
Stability (% resistance change, 1000 hours) (%):	2	2	3	3	3
Standard Heatsink - Area (mm <sup>2</sup> ):	99500	99500	375000	476500	578000
Thickness (mm):	3	3	3	3	3
Number of Mounting Holes:	4 hole	4 hole	6 hole	6 hole	6 hole

## Type HS Series

### Characteristics - Electrical

<b>Long Term Stability:</b>	For improvements in long-term stability, resistors must be derated as follows; for 50% of stated $\Delta R$ maximum dissipation must not exceed 70% of rating; for 25% of stated $\Delta R$ maximum, dissipation must not exceed 50% of rating
<b>Insulation Resistance:</b>	Dry: 10,000M $\Omega$ minimum. After moisture test: 1000M $\Omega$ minimum.
<b>Heat Dissipation:</b>	Although the use of proprietary heat sinks with lower thermal resistance is acceptable, up rating is not recommended. The use of proprietary heat sink compound to improve thermal conductivity is recommended for optimum performance of all sizes but essential for HSC200, HSC250 & HSC300
<b>Specification:</b>	Temperature coefficient below 100R, 50ppm/ $^{\circ}$ C Temperature coefficient above 100R, 30ppm/ $^{\circ}$ C Tolerance, 5% standard: 10%, 3%, 2%, 0.5% & 0.25% available Tolerance for values below R10, 10% standard

### Derating Curve HSA5 to HSA50

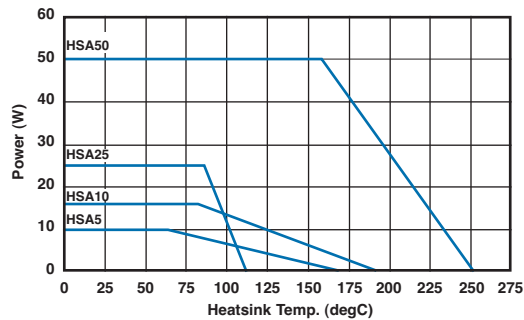

### Derating Curve HSC75 to HSC300

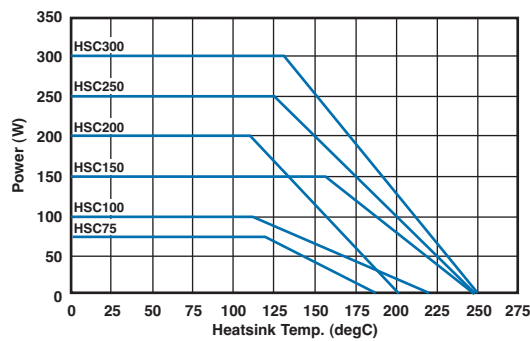

### Pulse Energy HSA5 to HSC75

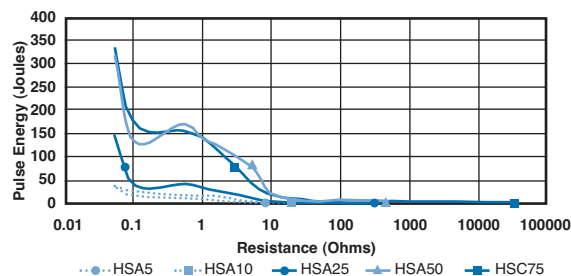

## Type HS Series

### Pulse Energy HSC100 to HSC300

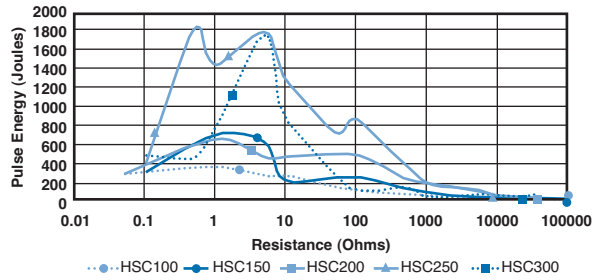

### Power Overload

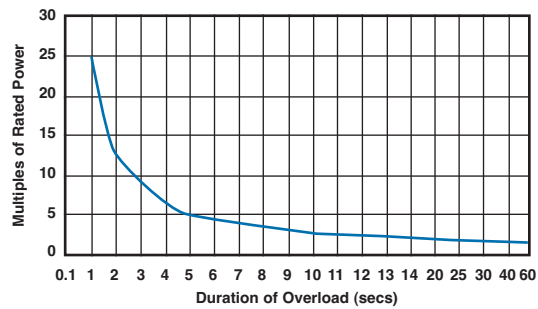

This graph indicates the amount that the rated power (at 20°C) of the standard HS Series resistor may be increased for overloads of 100mS to 60S

### Surface Temperature Rise

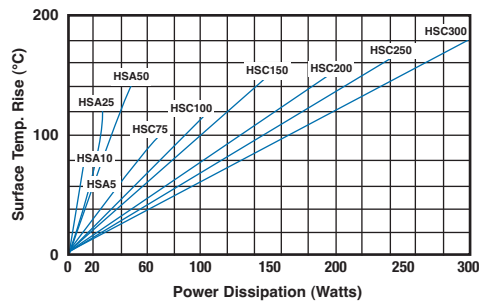

For resistor mounted on standard heatsink, related to power dissipation

### Product Specifications - HSA5 - HSC150

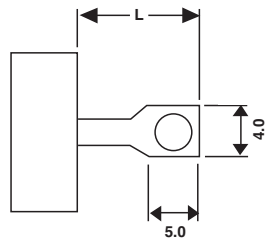

Type	L
HSA5, 10	7
HSA25, 50	10
HSC75, 100, 150	8

### HSC200 - HSC300

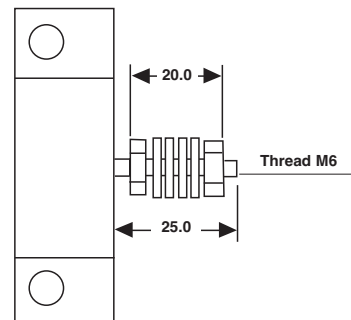

## Type HS Series

### Dimensions - HSA5 - HSA50

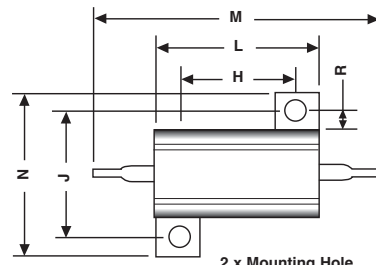

2 x Mounting Hole

HSA5 - 2.4mm  
 HSA10 - 2.4mm  
 HSA25 - 3.3mm  
 HSA50 - 3.3mm

### HSC75 - HSC150

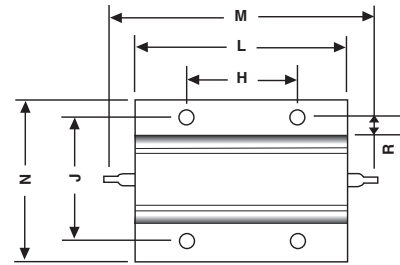

4 x Mounting Hole

HSC75 - 4.4mm  
 HSC100 - 4.4mm  
 HSC150 - 4.4mm

### HSC200+

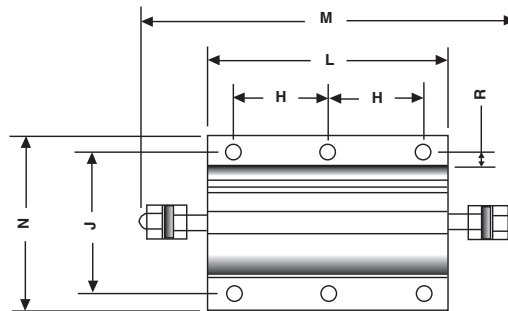

6 x Mounting Hole

HSC200 - 5.3mm  
 HSC250 - 5.3mm  
 HSC300 - 6.5mm

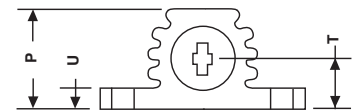

Type	H±0.3	J±0.3	K±0.2	L Max	M Max	N Max	P Max	R Min	T±0.5	U Max
HSA5	11.3	12.4	2.4	17.0	30.0	17.0	9.0	1.9	4.3	2.5
HSA10	14.3	15.9	2.4	21.0	36.5	21.0	11.0	1.9	5.2	3.2
HSA25	18.3	19.8	3.3	29.0	51.0	28.0	15.0	2.8	7.2	3.2
HSA50	39.7	21.4	3.3	51.0	72.5	30.0	17.0	2.8	8.2	3.2
HSC75	29.0	37.0	4.4	49.0	71.0	47.5	26.0	5.0	11.5	3.5
HSC100	35.0	37.0	4.4	65.5	87.5	47.5	26.0	5.0	11.5	3.5
HSC150	58.0	37.0	4.4	98.0	122.0	47.5	26.0	5.0	11.5	3.5
HSC200	35.0	57.2	5.3	90.0	143.0	73.0	42.0	5.6	20.25	5.3
HSC250	44.5	57.2	5.3	109.0	163.0	73.0	42.0	5.6	20.25	5.3
HSC300	52.0	59.0	6.5	128.0	180.0	73.0	42.0	5.6	20.25	5.3

### How to Order

HS	A	50	680R	J
<b>Common Part</b>	<b>Mounting Style</b>	<b>Power Rating</b>	<b>Resistance Value</b>	<b>Tolerance</b>
HS - Standard NHS - Low Inductance	A - Single Opposing mounting Feet B - Flange One Side C - Flange Two Sides	10 Watt = HSA5 16 Watt = HSA10 25 Watt = HSA25 50 Watt = HSA50 75 Watt = HSA75 etc	0.1ohm (100 mille ohms) R10 1ohm (1000 mille ohms) 1R0 1K (1000 ohms) 1KO	F - 1% G - 2% E - 3% J - 5% K - 10%

TE Connectivity, TE connectivity (logo) and TE (logo) are trademarks.  
 Other logos, product and Company names mentioned herein may be trademarks of their respective owners.

While TE has made every reasonable effort to ensure the accuracy of the information in this datasheet, TE does not guarantee that it is error-free, nor does TE make any other representation, warranty or guarantee that the information is accurate, correct, reliable or current. TE reserves the right to make any adjustments to the information contained herein at any time without notice. TE expressly disclaims all implied warranties regarding the information contained herein, including, but not limited to, any implied warranties of merchantability or fitness for a particular purpose. The dimensions in this datasheet are for reference purposes only and are subject to change without notice. Specifications are subject to change without notice. Consult TE for the latest dimensions and design specifications.

Part Number	Description	Part Number	Description
HSC100100RJ	100 OHM 5% 100W	HSC200127RJ	127 OHM 5% 200W
HSC10010KJ	10K OHM 5% 100W	HSC20012KJ	12K OHM 5% 200W
HSC10010RJ	10 OHM 5% 100W	HSC20012RJ	12 OHM 5% 200W
HSC100120RJ	120 OHM 5% 100W	HSC20012RK	12 OHM 10% 200W
HSC10012R4J	12.4 OHM 5% 100W	HSC200150RJ	150 OHM 5% 200W
HSC10012RJ	12 OHM 5% 100W	HSC20015KJ	15K OHM 5% 200W
HSC100150RJ	150 OHM 5% 100W	HSC20015RJ	15 OHM 5% 200W
HSC10015RJ	15 OHM 5% 100W	HSC200180RJ	180 OHM 5% 200W
HSC10016R6J	16.6 OHM 5% 100W	HSC2001K0J	1K OHM 5% 200W
HSC100180RJ	180 OHM 5% 100W	HSC2001K2J	1.2K OHM 5% 200W
HSC10018RJ	18 OHM 5% 100W	HSC2001K5J	1.5K OHM 5% 200W
HSC1001K0J	1K OHM 5% 100W	HSC2001K8J	1.8K OHM 5% 200W
HSC1001K2J	1.2K OHM 5% 100W	HSC2001R0J	1 OHM 5% 200W
HSC1001K5J	1.5K OHM 5% 100W	HSC20020KJ	20K OHM 5% 200W
HSC1001R0F	1 OHM 1% 100W	HSC20020RJ	20 OHM 5% 200W
HSC1001R0J	1 OHM 5% 100W	HSC200220RJ	220 OHM 5% 200W
HSC1001R5J	1.5 OHM 5% 100W	HSC20022KJ	22K OHM 5% 200W
HSC100200RJ	200 OHM 5% 100W	HSC20022RJ	22 OHM 5% 200W
HSC100204RJ	204 OHM 5% 100W	HSC20024RJ	24 OHM 5% 200W
HSC10020RF	20 OHM 1% 100W	HSC200250RJ	250 OHM 5% 200W
HSC10020RJ	20 OHM 5% 100W	HSC2002K4J	2.4K OHM 5% 200W
HSC100220RJ	220 OHM 5% 100W	HSC2002R0J	2 OHM 5% 200W
HSC10022KJ	22K OHM 5% 100W	HSC2002R2J	2.2 OHM 5% 200W
HSC10022RF	22 OHM 1% 100W	HSC2002R7J	2.7 OHM 5% 200W
HSC10022RJ	22 OHM 5% 100W	HSC200330RJ	330 OHM 5% 200W
HSC10025RJ	25 OHM 5% 100W	HSC200390RJ	390 OHM 5% 200W
HSC100270RJ	270 OHM 5% 100W	HSC2003K3J	3.3K OHM 5% 200W
HSC10027RJ	27 OHM 5% 100W	HSC2003R3J	3.3 OHM 5% 200W
HSC1002K0J	2K OHM 5% 100W	HSC20040RJ	40 OHM 5% 200W
HSC1002K2J	2.2K OHM 5% 100W	HSC200470RJ	470 OHM 5% 200W
HSC1002K5J	2.5K OHM 5% 100W	HSC20047RJ	47 OHM 5% 200W
HSC1002K7J	2.7K OHM 5% 100W	HSC2004R7J	4.7 OHM 5% 200W
HSC1002R2J	2.2 OHM 5% 100W	HSC20050KJ	50K OHM 5% 200W
HSC1002R7J	2.7 OHM 5% 100W	HSC20050RJ	HSC200 50R 5%
HSC100330RJ	330 OHM 5% 100W	HSC200560RJ	560 OHM 5% 200W
HSC10033KJ	33K OHM 5% 100W	HSC20056RJ	56 OHM 5% 200W
HSC10033RJ	33 OHM 5% 100W	HSC2005R1J	5.1 OHM 5% 200W
HSC100360RJ	360 OHM 5% 100W	HSC20064RJ	64 OHM 5% 200W
HSC10036RJ	36 OHM 5% 100W	HSC2006R0J	6 OHM 5% 200W
HSC100390RJ	390 OHM 5% 100W	HSC2006R8J	6.8 OHM 5% 200W
HSC10039RJ	39 OHM 5% 100W	HSC20080RJ	80 OHM 5% 200W
HSC1003K3J	3.3K OHM 5% 100W	HSC20082RJ	82 OHM 5% 200W
HSC1003K9J	3.9K OHM 5% 100W	HSC200R10J	0.1 OHM 5% 200W
HSC1003R0J	3 OHM 5% 100W	HSC200R13J	0.13 OHM 5% 200W
HSC1003R3J	3.3 OHM 5% 100W	HSC200R14J	0.14 OHM 5% 200W
HSC1003R9J	3.9 OHM 5% 100W	HSC200R261J	0.261 OHM 5% 200W
HSC100470RJ	470 OHM 5% 100W	HSC200R47J	0.47 OHM 5% 200W
HSC10047KJ	47K OHM 5% 100W	HSC200R75J	0.75 OHM 5% 200W

HSC10047RJ	47 OHM 5% 100W	HSC300100RJ	100 OHM 5% 300W
HSC1004K7J	4.7K OHM 5% 100W	HSC30010KJ	10K OHM 5% 300W
HSC1004R0J	4 OHM 5% 100W	HSC30010RJ	10 OHM 5% 300W
HSC1004R3J	4.3 OHM 5% 100W	HSC300120RJ	HSC300 120R 5%
HSC1004R7J	4.7 OHM 5% 100W	HSC30012R8J	12.8 OHM 5% 300W
HSC10050KJ	50K OHM 5% 100W	HSC30014R4J	14.4 OHM 5% 300W
HSC10050RJ	50 OHM 5% 100W	HSC30015RJ	15 OHM 5% 300W
HSC100560RJ	560 OHM 5% 100W	HSC30018KJ	18K OHM 5% 300W
HSC10056RJ	56 OHM 5% 100W	HSC3001K0J	1K OHM 5% 300W
HSC1005R6J	5.6 OHM 5% 100W	HSC3001R0J	1 OHM 5% 300W
HSC100600RJ	600 OHM 5% 100W	HSC300200RJ	200 OHM 5% 300W
HSC10060RJ	60 OHM 5% 100W	HSC300220RJ	220 OHM 5% 300W
HSC100680RJ	680 OHM 5% 100W	HSC30022KJ	22K OHM 5% 300W
HSC10068KJ	68K OHM 5% 100W	HSC30022RJ	22 OHM 5% 300W
HSC10068RJ	68 OHM 5% 100W	HSC30025RJ	25 OHM 5% 300W
HSC1006K0J	6K OHM 5% 100W	HSC3002R4J	2.4 OHM 5% 300W
HSC1006K8J	6.8K OHM 5% 100W	HSC300330RJ	330 OHM 5% 300W
HSC1006R4J	6.4 OHM 5% 100W	HSC30033RJ	33 OHM 5% 300W
HSC1006R8J	6.8 OHM 5% 100W	HSC30039RJ	39 OHM 5% 300W
HSC10075RJ	75 OHM 5% 100W	HSC3003K0J	3K OHM 5% 300W
HSC100800RJ	800 OHM 5% 100W	HSC3003R2J	3.2 OHM 5% 300W
HSC100820RJ	820 OHM 5% 100W	HSC3003R6J	3.6 OHM 5% 300W
HSC10082RJ	82 OHM 5% 100W	HSC3003R9J	3.9 OHM 5% 300W
HSC1008R0J	8 OHM 5% 100W	HSC30047RJ	47 OHM 5% 300W
HSC1008R2J	8.2 OHM 5% 100W	HSC3004K7J	4.7K OHM 5% 300W
HSC100R044J	0.044 OHM 5% 100W	HSC3004R0J	4 OHM 5% 300W
HSC100R10J	0.1 OHM 5% 100W	HSC3004R7J	4.7 OHM 5% 300W
HSC100R18J	0.18 OHM 5% 100W	HSC300680RJ	680 OHM 5% 300W
HSC100R22J	0.22 OHM 5% 100W	HSC3006R0J	6 OHM 5% 300W
HSC100R27J	0.27 OHM 5% 100W	HSC3006R8J	6.8 OHM 5% 300W
HSC100R39J	0.39 OHM 5% 100W	HSC30075RJ	75 OHM 5% 300W
HSC100R47J	0.47 OHM 5% 100W	HSC30082RJ	82 OHM 5% 300W
HSC100R50J	0.5 OHM 5% 100W	HSC3008R0J	8 OHM 5% 300W
HSC100R56J	0.56 OHM 5% 100W	HSC300R10J	0.1 OHM 5% 300W
HSC100R68J	0.68 OHM 5% 100W	HSC300R15J	HSC300 R15 5%
HSC100R82J	0.82 OHM 5% 100W	HSC300R22J	0.22 OHM 5% 300W
HSC200100RJ	100 OHM 5% 200W	HSC300R32J	0.32 OHM 5% 300W
HSC20010KJ	10K OHM 5% 200W	HSC300R47J	0.47 OHM 5% 300W
HSC20010RJ	10 OHM 5% 200W	HSC300R56J	0.56 OHM 5% 300W