

EDDY CURRENT PROBES

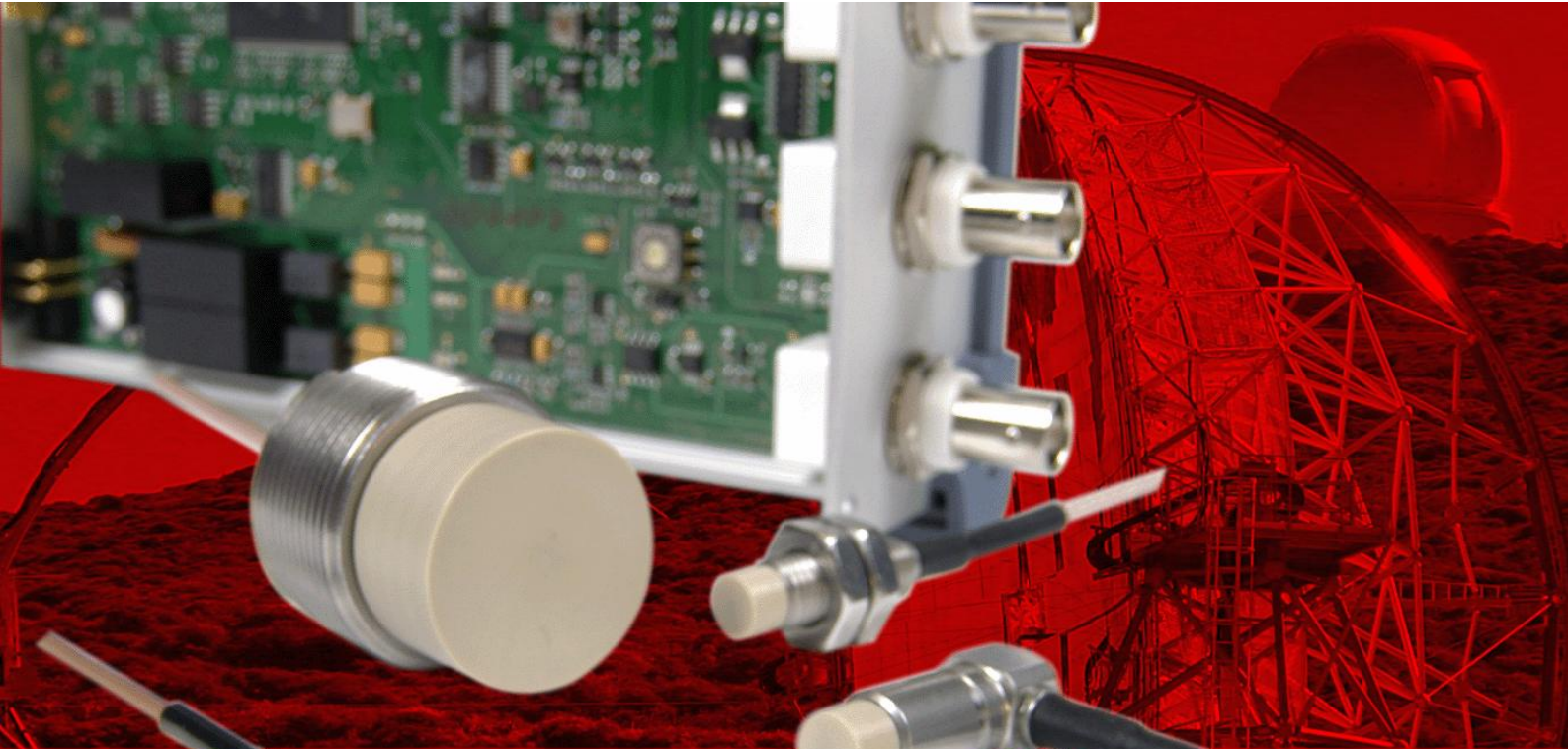

TX Series

Key Features:

- High resolution (submicrometer)
- High dynamics (124 kS/s)
- Minimal temperature coefficient
- Configurable analogue output
- CAN Interface
- USB Interface
- eddyLAB, Windows software
oscilloscope + FFT + data logger
- Protection class IP68
- High noise immunity
- Custom-made probes

Contents:

Introduction & Applications2
Description3
eddyLAB Software4
Technical Data5
Resolution & Temperature7
Properties & Calibration8
USB / CAN / Connection9
Technical Drawings	..10
Accessories	..12
Installation	..13
Precautions & Order Code	..15

11/01/13

WayCon
Positionsmesstechnik

INTRODUCTION

For more than ten years we have been occupied with the development and production of high-quality eddy current probes for industry and research. With the new TX Series, WayCon is introducing a fully digital device - incorporating USB, CAN and a high-speed analogue interface. Eddy current probes are particularly suitable devices for non-contact measurements on metallic targets. Typical applications are measurements on rotating shafts for the detection of imbalance, vibration, out-of-roundness, air gap, radial/axial runout, and much more besides. The extremely high resolution up to level of 20nm enables the smallest of amplitudes to be detected. WayCon probes are designed for temperatures up to 185 °C, and are optimised for the entire temperature range with regard to temperature drift.

The basic principle

The principle of measurement bases on a DSP-driven oscillating circuit made up of the probe (inductivity) and a interconnect capacitance. This circuitry is attenuated in the presence of metallic objects. The oscillating circuit generates magnetic field lines - these induce eddy currents on the surface of conductive objects. The eddy currents counteract their cause and attenuate the amplitude of the oscillating circuit.

This effect is decoupled from the oscillating circuit a fed towards further signal processing.

Outstanding temperature coefficient - Zero TC

A remarkable feature is the TX-Serie's temperature coefficient (TC). The temperature coefficient is optimized in a range between -60°C..185 °C. For certain boundary conditions the position will be constant at ambient temperature and 150°C. This matter of fact can interpreted as Zero TC. Particularly when it comes to high-resolution measurements this effect is of seminal importance.

Minimal probe drift

Every probe produced in WayCon's facility line is treated with a thermal finishing procedure of a 12-hour duration (burn-in). This procedure minimises aging and drift. The probe is then finally calibrated in our laboratory before delivery.

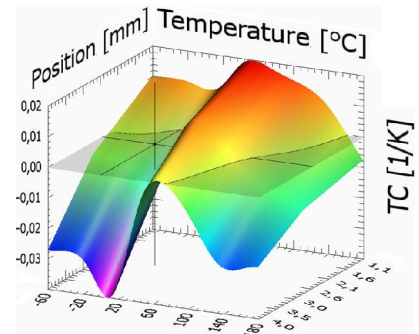
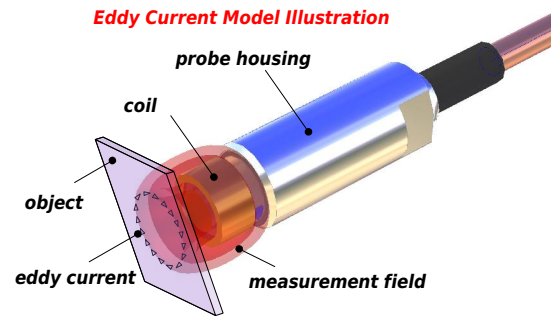

APPLICATIONS

High-resolution distance measurements on metallic objects regardless of non-conductive mediums in the measurement area. Examples are polymers, glass, oil, water, dirt. Measurement of thermal expansion with a maximum resolution of 20 nm.

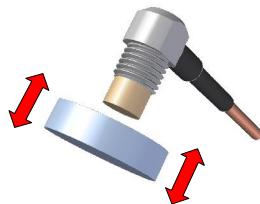

Thickness measurement of sheet material and foils. Two-sided measurement for thickness measurement. Controlling of machinery (feed-back, closed-loop).

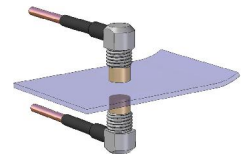

Measurement of vibration and oscillation on rotating shafts. Measurement of out-of-roundness and radial displacement. Surveillance and monitoring of rotating mechanical components. Bearing wear and lubrication gap.

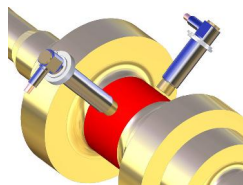

Weld seam positioning via edge detection. Welding torch tracking. Surveillance of weld seams. Out-of-roundness measurement on welded drums and tubes.

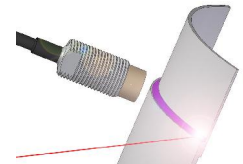

Deformation and oscillation of gearwheels in operation. Axial thrust measurement of helical cut gears under load. Detection of tooth loss on gearwheels.

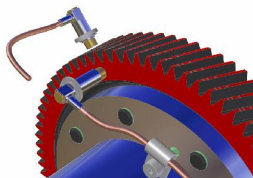

Housing deformation of machines under load such as gearboxes, engines, turbo generators. Measurement of torsion on shafts and housing. Measurement of thermal expansion.

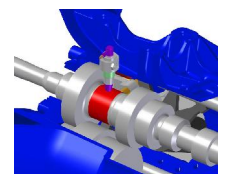

Inspection and part quality analysis during production in the presence of cooling lubricant. Detection of gearing. Groove detection. Detection of flat portions on shafts.

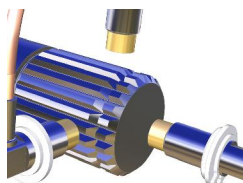

Distance-time diagram for measurement probes covered on the side. The measured object passes by the probe laterally. Measurement of object acceleration and deceleration.

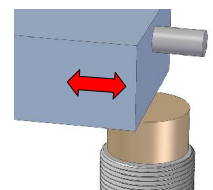

Layer thickness of non-conductive material such as powder coatings and paint. Inspection of plastic injection-moulded parts at insert molded metal parts.

.....and many more

EDDY CURRENT BASIC MODULE TX

The processor based design admits lowest temperature coefficients - which are an exceptional feature for this sensor technology. Remarkable performance allows highly dynamic measurements with 124 kS/s and linearities of less than 0.1 %.

The eddy current basic module is available as single- or dual-channel device. As standard, the device provides a USB and a CAN-bus Interface. The power supply is a galvanically isolated wide input from 10.5...36 VDC.

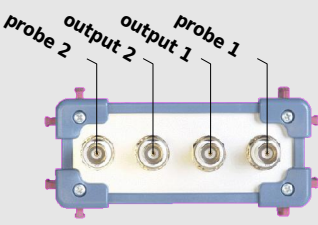

Probe and analogue output:
isolated output and high-speed signals via BNC connector. Selectable output signals 10V, 5V, ±5V, 0...20mA, 4...20mA.

Benefit 2-channel unit:
2 different probes can be connected to one basic module.

Benefit 1-channel unit:
highest dynamic performance. The output sampling rate is 124 kS/s.

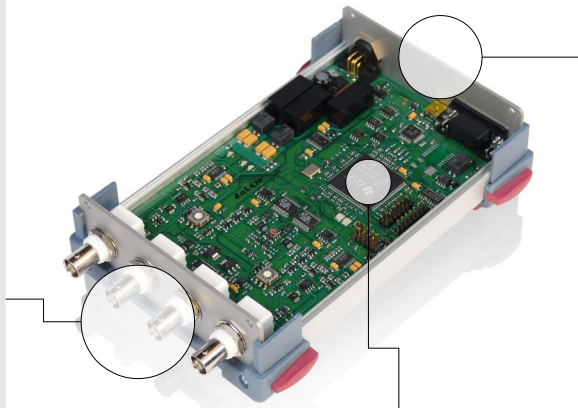
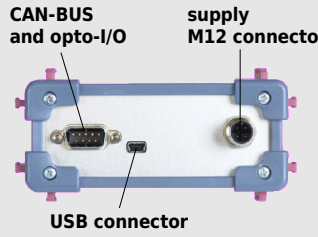

Illustration shows the 2-channel unit

Processor linearised signal conditioning

- linearisation and calibration with 50 points
- high dynamic performance with selectable digital filter
- high resolution and precision



CAN-BUS and opto-I/O

supply M12 connector

USB connector

Supply:
Wide-Input-supply 10,5...36 VDC, screwable M12 connector for shielded cables; galvanically isolated.

CAN bus:
Data transfer via CAN bus for diverse systems with multi channel measurement.

USB connection:
Interface to PC and data transfer. Usage of eddyLAB software. Direct communication via USB protocol.

CUSTOM MADE

Extended measurement ranges

The powerful TX eddy current basic module admits customisation of our probes to your needs. The measurement range can be extended up to 50 % - depending on the probe.

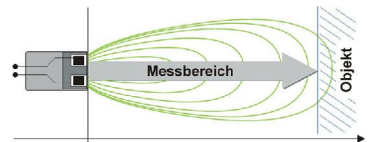

X-Z system

Axial thrust measurements on shafts without face access can be performed with the X-Z system. The radial and the axial displacement can be measured on the lateral side.

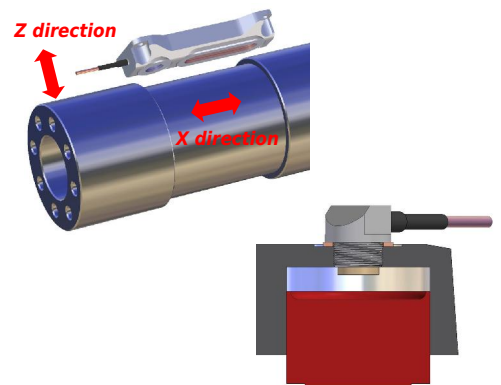

Pressure-resistant probes

In accordance with your needs we also produce pressure-resistant probes in stainless steel and ceramics. These probes can be applied in absolute and differential-pressure systems.

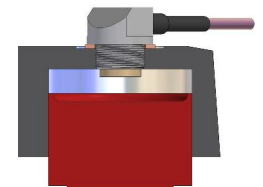

Water cooled

When it comes to ultra-hot conditions we offer probes with integrated cooling channels for connection to a cooling system.

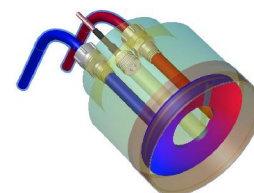

Custom-made

If your application requires non-standard dimensions we also produce shortened and extended housing as shielded and non-shielded probes.

eddyLAB - Windows Analysis Software via USB

eddyLAB is a powerful Windows software incorporating three major functions: **Oscilloscope - FFT - Data logger**. The TX Series' USB connectivity facilitates data exchange with a PC or notebook. The sampling rates are 8444 S/s for a single-channel device and 5625 S/s for a dual-channel device. Furthermore, eddyLAB can be used to define the corner frequency of a lowpass filter and to scale the analogue interface.

Oscilloscope

Measured data display with important features in the style of a classic one or two-channel oscilloscope.

- AC/DC-coupling
- variable time base 14ms...5sec
- scaleable Y-axis & autoscale function
- user-defined trigger level, hysteresis and pre-trigger, trigger source, falling and rising edge
- essential measurements on dynamic data can be taken: amplitude, frequency, max & min values
- data export as image (bmp) and text file

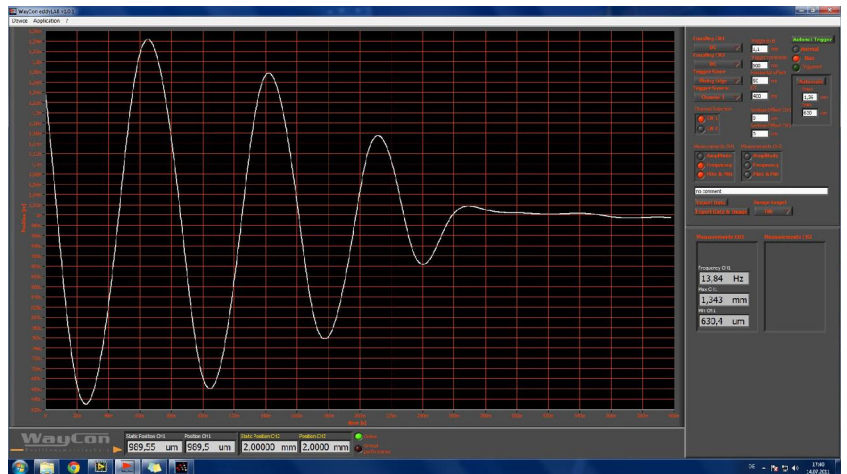

FFT analyser

Fast-Fourier transformation. Spectral analysis of mechanical motion. Analysis of fundamental oscillation and harmonics.

- illustration of the frequency spectrum
- boundary value for frequency recognition can be selected (threshold)
- calculation and listing of identified frequencies with the respective amplitudes
- data export as image (bmp) and text file

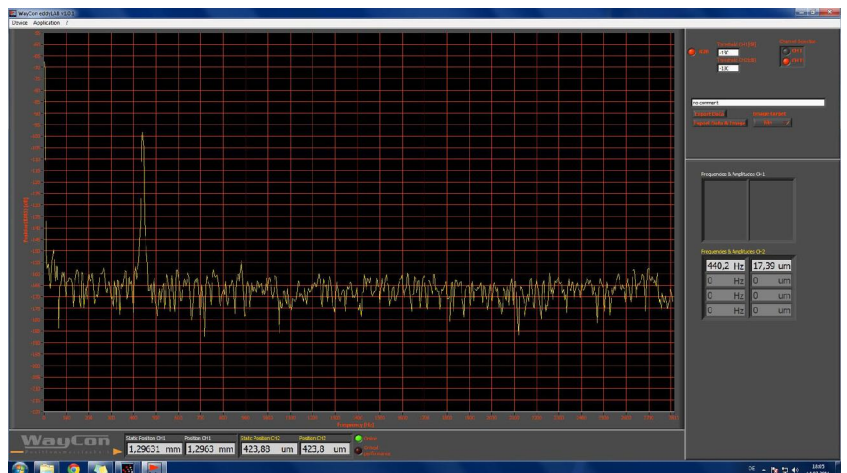

Data logger

Record of measured data and writing the data to the hard drive.

- user-defined sampling rate: 100ms...10s
- time base 1min...60min
- runs in parallel with FFT and oscilloscope
- data export as image (bmp) and text file

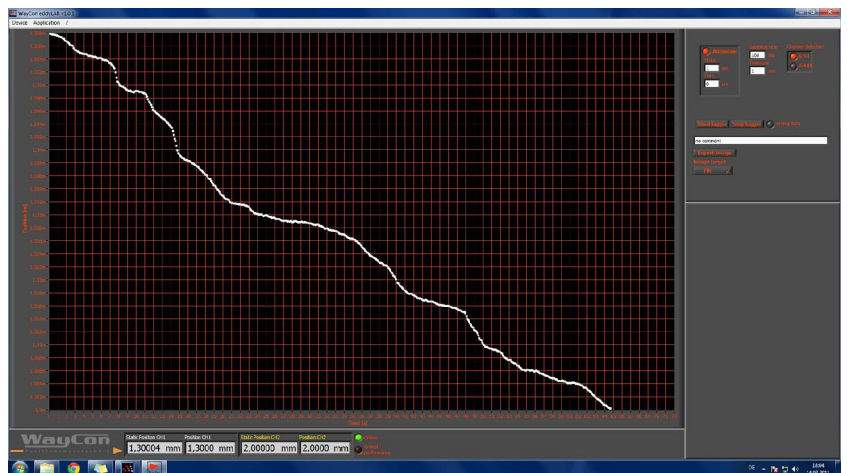

TECHNICAL DATA - PROBES



Probe	T05	T2	T3	T4	T5	T10
ranges [mm]	0...0,5	0...2	0...3	0...4	0...5	0...10
ranges extended [mm] *	1	2,5	4	5	7	12
housing size	ø5	ø8	ø12	ø14	ø18	ø30
offset gap	< 0,1 mm					
linearity	±0,15% of range					
resolution reg. corner frequency [% v. MB]**	dependent on the distance (see resolution diagramm on page 7), valid for middle of range					
10 Hz	0,006	0,01	0,006	0,007	0,007	0,006
100 Hz	0,008	0,015	0,008	0,008	0,007	0,007
1 kHz	0,021	0,035	0,021	0,014	0,014	0,015
10 kHz	0,075	0,061	0,040	0,033	0,047	0,045
35 kHz	0,101	0,088	0,078	0,064	0,075	0,078
temperatur range sensor	-60...185°C					
temperature coefficient sensor	dependent on distance (see temperature coefficient diagramm on page 7)					
sensor cable PTFE-COAX	ø1,8 mm	ø2,5 mm (max. 2,7 mm)				
cable lenght	standard length 3 m / 6 m, customised length up to 20 m					
min bend radius static/dynamic	10/25 mm	15/37 mm				
temperature range cable	-55...+200°C					
connection	BNC connector / optional SMB connector					
protection class	IP68					
vibration	20 g, DIN EN 60068-2-6					
shock	100 g / 6 ms, DIN EN 60068-2-27					
check resistance [Ω]	6	8	9	12	12	9
housing material	stainless steel 1.4305, sensor head PEEK (polyetheretherketon), FPM bend protection					

* linearity and resolution are not valid for extended measurement ranges

** 98,5% confidence interval (confidence limit), middle of range as % of range. Resolution dependent on the distance (see „Resolution and Temperature“ on page 7)

Cable configuration

By default the probes have a BNC plug for the connection at the eddy current basic module. Optionally the probes are equipped with a SMB connector. The SMB connection is either performed as BNC-SMB adapter (option 1) or as a TX-SMB-COAX cable extension (option 2).

Please note:

The SMB connectors have beryllium copper contacts. The connector housing is gold plated and has an outer diameter of 6.5mm. This facilitates the installation in particular with narrow conditions (option 1). If the cable is durably affixed it might be desirable only to remove the probe from the entire cable (option 2).

It is recommended to avoid unnecessary connections within the cable as it increases the probability of failure due to environmental influences such as wetness, dirt, aggressive media, massive vibration or shock.

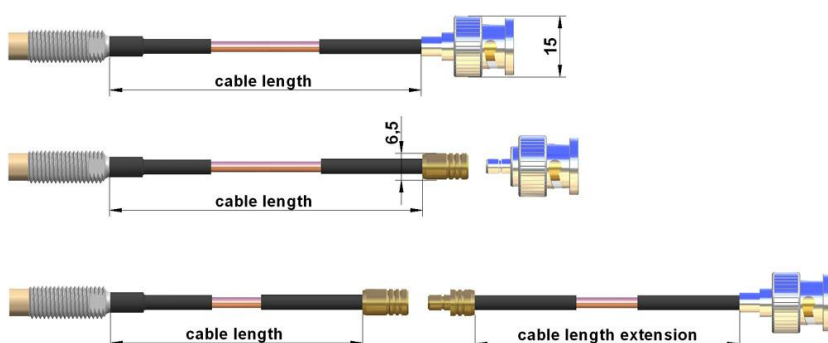

Standard version

- probe with BNC connector
- cable length 3 or 6 m*

Option 1

- probe with SMB connector
- cable length 3 or 6 m*
- incl. BNC-SMB adapter for eddy current basic module

Option 2

- probe with SMB connector
- cable length 3 or 6 m
- additional extension (accessory) TX-SMB-KOAX with cable length 3 or 6 m*. SMB connector to BNC connector.

*customised cable length up to overall 20 m

TECHNICAL DATA - EDDY CURRENT BASIC MODULE



EddyCurrent-Basic Module	TX1	TX2
channels	1 channel	2 channel
operating temperature range	-40...+50°C	
storage temperature range	-40...+85°C	
humidity	95% (no condensation)	
vibration	5 g, DIN EN 60068-2-6	
shock	15 g / 11 ms, DIN EN 60068-2-27	
protection class	IP40	
housing	anodised aluminium with plastic frame and rubber feet, stackable	
housing size L x W x H	197 x 115 x 49 mm	
weight	668 g	685 g

Supply		
Supply Voltage	10,5...36 V DC Wide Input	
current consumption	145 mA (24V), 260 mA (12V), 300 mA (10,5V)	180 mA (24V), 300 mA (12V), 380 mA (10,5V)
power on peek current	350 mA (24V), 470 mA (10,5V), < 30 ms	
reverse polarity protection	yes	
protection circuit	bipolar supressor diode 36V / polyfuse 0,5A	
isolation voltage	min. 1 kV	

Analog output		
output signals	0...10 V / 0...5 V / ± 5 V / 0...20 mA / 4...20 mA	
dynamic / sampling rate	124 kS/s	70 kS/s
dyn. / samp. with simultaneous USB usage	76 kS/s	45 kS/s
filter comer frequency	10 Hz / 100 Hz / 1 kHz / 10 kHz / 35 kHz (-3 dB)	
max working resistance (current output)	< 400 Ohm	
scalability of output signal	scalability 100...8% of range (eddyLAB software)	
temperature coefficient electronic	-0,025 %/K	
switching-on delay (boot-time)	3,1 s	
switching-on drift	< 1% (see diagramm)	
connection	1 x BNC female connector	2 x BNC female connector
output protection circuit	polyfuse 50mA	

General data and industrial standards	
electromagnetic compatibility	EN 61326-1 / EN 55011
RoHS	appropriate standard 2002/95/EG
MTBF	EN 61709, > 360.000 h
customs declaration number	90318034 country of origin germany

RESOLUTION and TEMPERATURE

Resolution nm... μm

The probe's resolution depends on the selected corner frequency and the actual position. The best resolution is achieved within the first 50 % of the measurement range.

The following charts illustrate the resolution as a function of the position (normalised) and the corner frequency. Low corner frequencies and positions close to the target result in high resolutions.

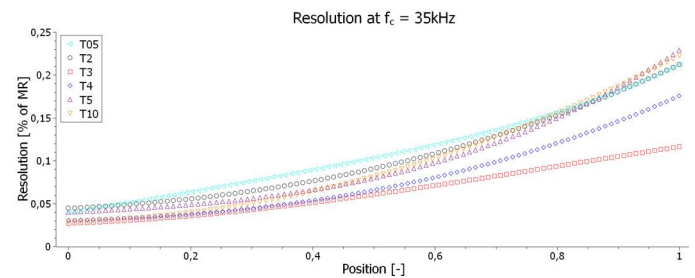
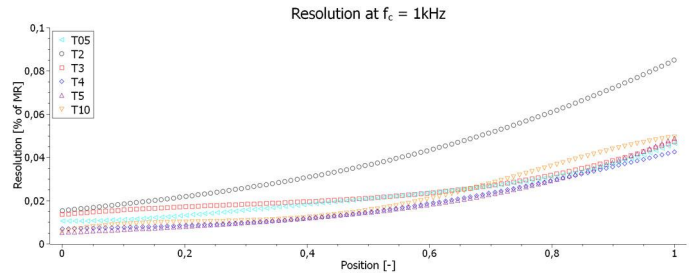
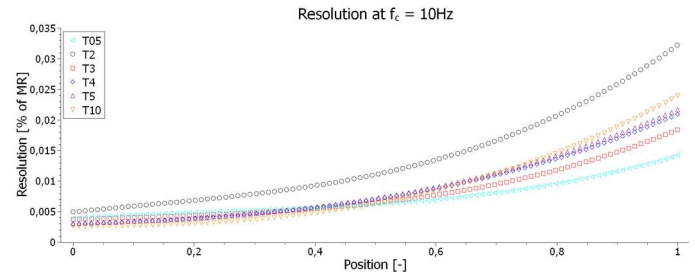
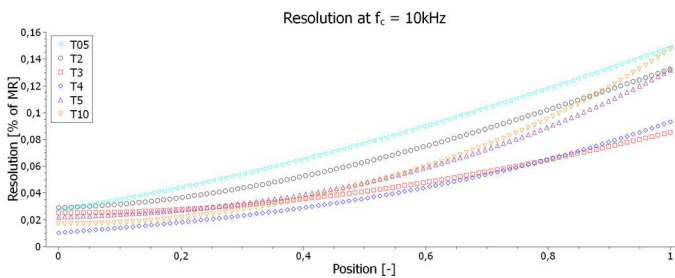
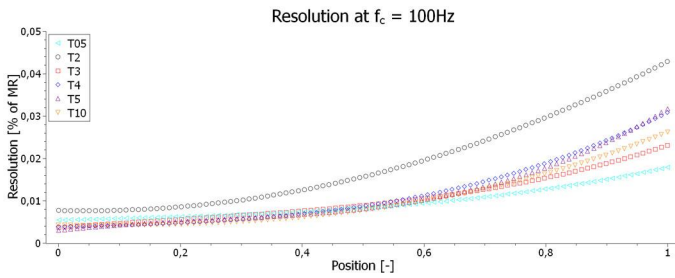

Temperature coefficient TC

The temperature coefficient has a severe impact on the precision and in particular the repeatability of measurements when exposed to temperature variation. WayCon probes have a remarkable temperature characteristic - the temperature coefficient is almost zero over wide ranges of temperature. The following charts document the temperature coefficient as a function of the actual temperature and the position. The best temperature behaviour is achieved at 50 % of the measurement range. The temperature coefficient is evaluated within the extreme temperature range of $-60\dots+180\text{ }^\circ\text{C}$.

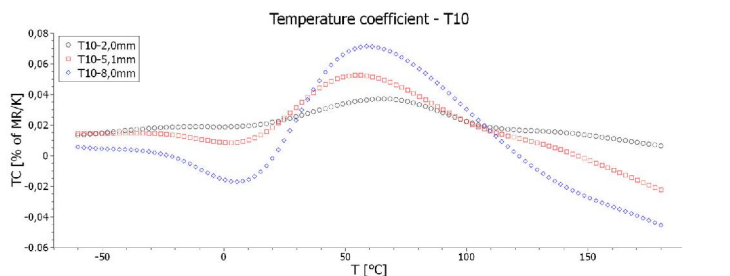
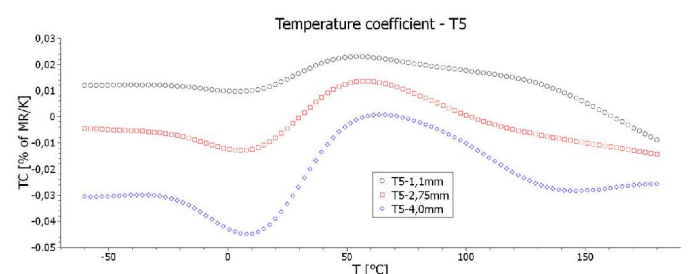
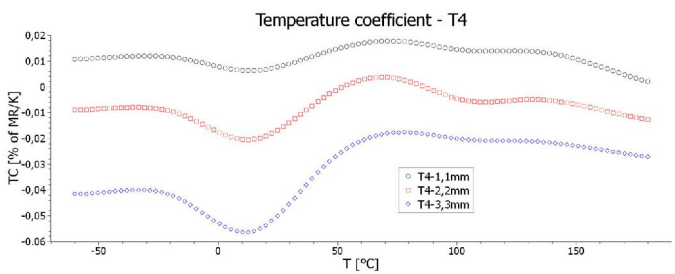
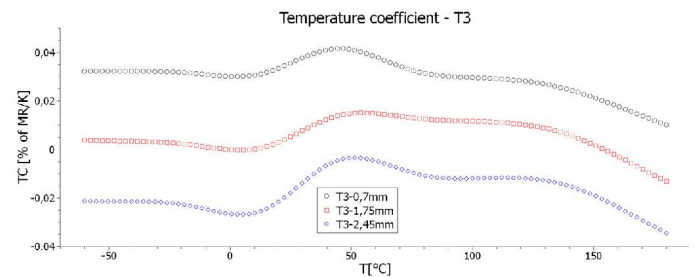
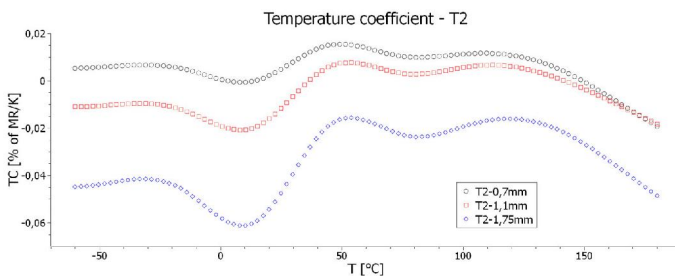

PROPERTIES

Device drift after power-on

For highly precise measurements the device drift after power-on has to be considered. The entire device drift is <1 % of measurement range.

- ~ 0,1 % of MR at 30 min. warm up
- ~ 0,2 % of MR at 20 min. warm up
- ~ 0,4 % of MR at 10 min. warm up
- ~ 0,8 % of MR without warm up

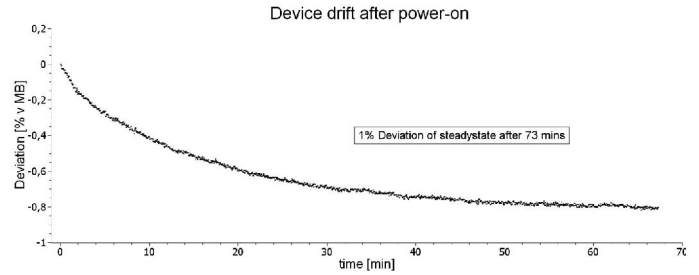

Frequency response

The TX Series contains a hardware filter with a corner frequency of 50 kHz in its signal path. Additionally five user selectable software filters can be set. The chart illustrates the respective characteristic. Lowering the corner frequency increases the resolution. Note that higher frequencies will appear attenuated.

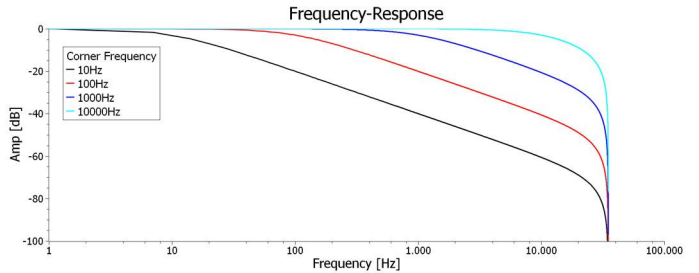

Zero TC measurements - Procedure:

The exceptional temperature behaviour of our probes allows zero TC measurements. That means the position won't be affected by temperature effects. Consider the following five aspects:

- 1) Only the probe is exposed to temperature.
- 2) The probe cable must be located predominantly outside of the temperature-influenced measurement point and must not be laid on parts of machines, etc., subject to temperature fluctuations. Consider this for installation.
- 3) The eddy current basic module must be placed outside any temperature influence or variation. The device must be powered 60 min before measurements commences.
- 4) The measurement has to be taken in middle of the entire measurement range.
- 5) The zero TC effect is only valid for temperatures on the zero TC line with same positive and negative area (see chart).

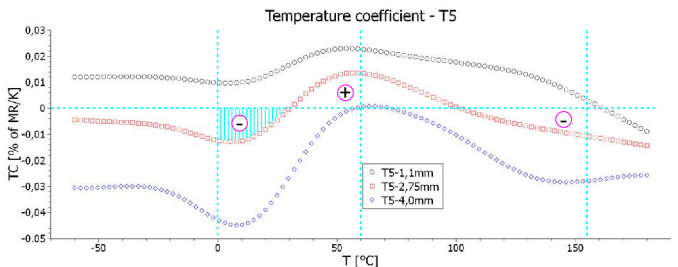

CALIBRATION

All of our probes are tested and calibrated before shipping. The calibration is based on 50 positions. Every probe has a unique setup - therefore the probes may not be interchangeable among different drivers.

The certificate of calibration contains the measured and reference data, the sensitivity, the target material and the linearity as a chart.

The certificate of calibration is provided as standard - but it is also available subsequently.

Target - material

Eddy current measurements depend on the target's conductivity and permittivity. The default material for factory calibration is steel of type 16MnCr5. Calibration is also possible with other conductive material such as aluminium, titanium, carbon fibre etc.

The following list shows available material for calibration. If you desire to use a different material we recommend to provide a probe (50x50mm) for calibration.

materials to choose from for calibration

16MnCr5	1.2379	AlMgSi0,5
42CrMo4	1.2738	AlMg4,5Mn
St52	1.4301	AlMgCuPb
C45E	1.4305	9SMn28k

also zink sheets, titanium, carbon fiber and others

Pos. Ref. System [mm]	Messwert	Abweichung [% v. MB]	Pos. Ref. System [mm]	Messwert	Abweichung [% v. MB]
0.001	0.001	-0.003	1.033	0.108	0.006
0.010	0.009	-0.009	1.038	0.209	0.012
0.040	0.199	0.003	1.058	0.501	0.003
0.050	0.299	0.005	1.079	0.801	0.003
0.070	0.399	0.003	1.108	1.101	0.004
0.090	0.498	0.001	1.138	1.401	-0.006
0.110	0.599	-0.002	1.189	1.704	0.012
0.130	0.700	0.016	1.189	2.008	0.006
0.150	0.799	0.001	1.179	2.302	0.004
0.170	0.900	0.007	1.189	2.600	0.011
0.190	0.999	-0.001	1.219	2.902	0.001
0.210	1.099	-0.001	1.239	3.199	-0.004
0.230	1.199	-0.001	1.239	3.499	-0.001
0.250	1.299	-0.004	1.279	3.798	-0.001
0.270	1.400	0.005	1.299	4.095	-0.011
0.290	1.500	0.000	1.319	4.392	-0.007
0.310	1.600	-0.002	1.339	4.709	-0.007
0.330	1.700	0.017	1.339	5.002	-0.009
0.350	1.800	0.008	1.379	5.302	0.006
0.370	1.900	-0.002	1.399	5.600	-0.008
0.390	2.000	0.000	1.419	5.901	-0.011
0.410	2.099	-0.017	1.439	6.202	-0.001
0.430	2.200	0.004	1.459	6.504	0.010
0.450	2.300	-0.004	1.479	6.801	0.011
0.470	2.400	-0.002	1.499	7.102	0.003
0.490	2.500	0.010	1.519	7.401	0.004
0.510	2.600	0.002	1.539	7.701	0.044
0.530	2.700	-0.000	1.559	8.001	0.011
0.550	2.800	-0.001	1.579	8.302	0.006
0.570	2.900	0.002	1.599	8.601	0.006
0.590	2.999	-0.011	1.619	8.902	0.009
0.610	3.100	0.004	1.639	9.201	0.009
0.630	3.199	-0.012	1.659	9.502	0.020
0.650	3.297	0.017	1.679	9.801	-0.004
0.670	3.399	-0.012	1.699	10.101	0.001
0.690	3.499	-0.009	1.719	10.401	0.001
0.710	3.600	0.004	1.739	10.702	0.012
0.730	3.699	-0.001	1.759	11.001	-0.001
0.750	3.800	-0.004	1.779	11.301	0.012
0.770	3.900	0.000	1.799	11.601	0.011
0.790	3.999	-0.007	1.819	11.902	0.001
0.810	4.100	0.000	1.839	12.201	0.001
0.830	4.202	0.015	1.859	12.501	0.014
0.850	4.301	0.006	1.879	12.801	0.001
0.870	4.402	0.017	1.899	13.101	0.001
0.890	4.500	0.004	1.919	13.401	0.011
0.910	4.602	0.017	1.939	13.701	0.011
0.930	4.704	0.012	1.959	14.001	-0.001
0.950	4.802	0.008	1.979	14.301	0.011
0.970	4.901	0.010	1.999	14.602	0.010
0.990	5.002	0.004			

WayCon Positionsmesstechnik GmbH
Mehilbeerstr. 4
82024 Taufkirchen
www.waycon.de

KALIBRIERZERTIFIKAT
Referenz-System: Maßstab TYP Sony DL 55 (Auflösung 0,05 µm DKD-K-01101)

Sensor: Empfindlichkeit: V/mm

Ser.Nr.: Max Abweichung [% v. MB]:

El.Ser.Nr.: Min Abweichung [% v. MB]:

Datum: Temp [°C] +/-:

Bearbeiter:

Bemerkung: Target: 16MnCr5

Front of unit

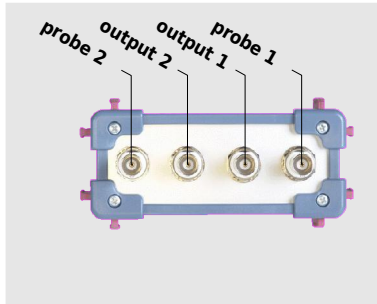

Rear of unit

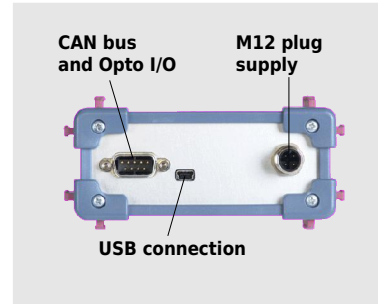

USB

The eddy current basic module provides a USB port (USB 2.0 Full Speed).

- data transfer rate 1 MBit
- sampling rate 8444 S/s (single channel), 5625 S/s (dual channel)
- device configuration (filter, scale, CAN bus)
- data exchange with a PC or notebook via eddyLAB Windows software or via protocol

Sampling rates	TX1	TX2
Analogue without US	124 kS/s	70 kS/s
Analogue with USB	76 kS/s	45 kS/s
USB	38 kS/s	22.5 kS/s



CAN bus (will be available soon)

The eddy current basic module also provides a CAN-bus interface (controller area network).

- data transfer rate 1 MBit, standard and extended-identifier
- networking of many devices with minimal wiring effort
- highly reliable data transfer over wide ranges - ideal for applications with many devices (consider dynamics)
- economisation of analogue measuring equipment (analog-to-digital converter)

Wiring is achieved with a CAN-bus cable. The first and the last device on a CAN bus must be terminated.

When communicating via CAN bus, the position can be read and filters can be set.



Digital IN OUT/CAN (D-SUB 9-pole MALE)

PIN	Name	Description
1	EXT OPTO OUT 1	digital output I/O 1
2	CAN L	CAN low signal
3	CAN GND	CAN ground
4	EXT IN 1	digital input I/O 1
5	EXT IN 2	digital input I/O 2
6	IN GND	ground I/O
7	CAN H	CAN high signal
8	EXT OPTO OUT 2	digital output I/O 2
9	CAN GND	CAN ground

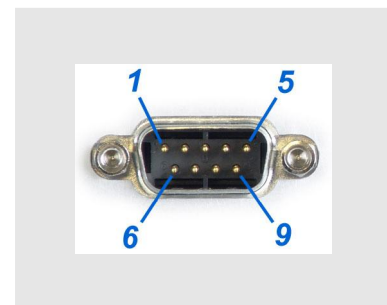

Supply via a 4-pole M12 plug connector (socket)

View of the unit and the soldering side of the mating connector.

- Pin 1 (brown) = +V (supply 10,5...36 VDC)
- Pin 3 (blue) = GND

For connecting the power, shielded cables in various lengths are available (see accessories).

Please use only shielded supply cables and set the screen on one side (to avoid earth loops)!

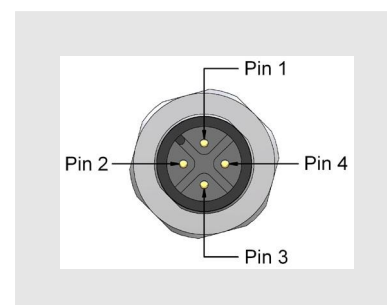

TECHNICAL DRAWINGS

Type T05

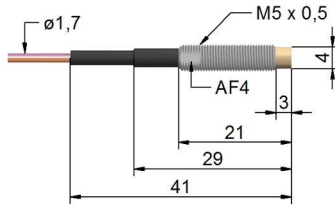

Type T2

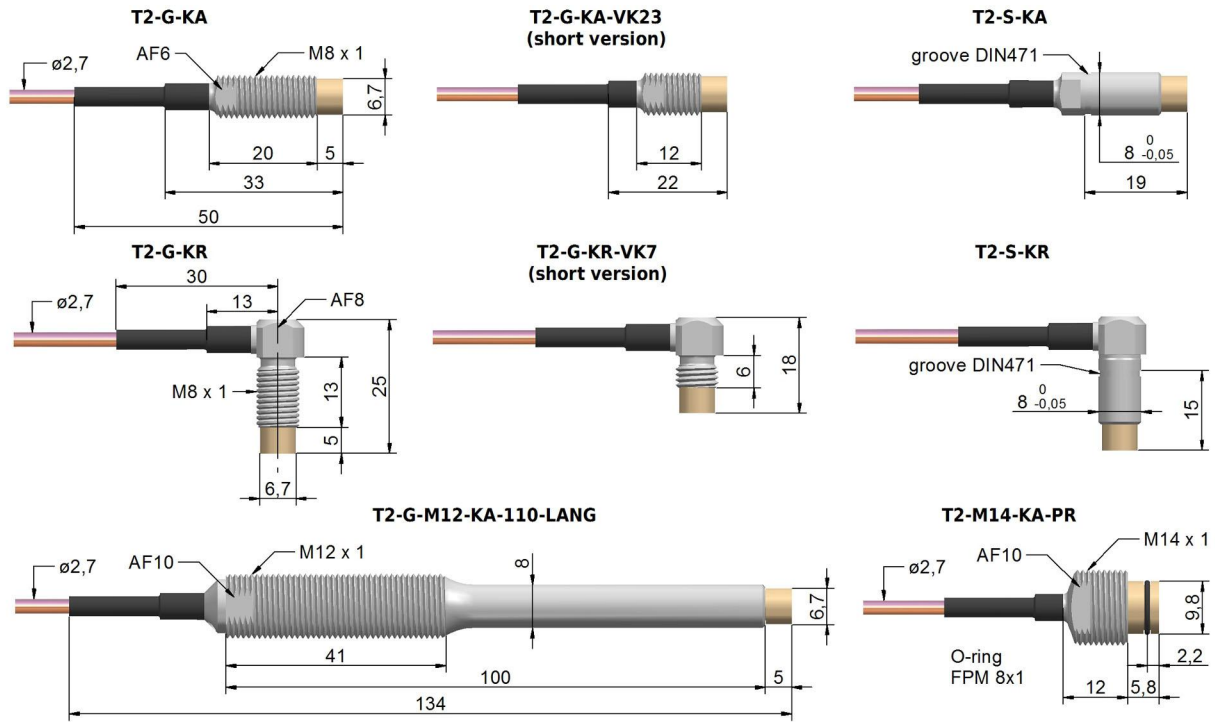

Type T3

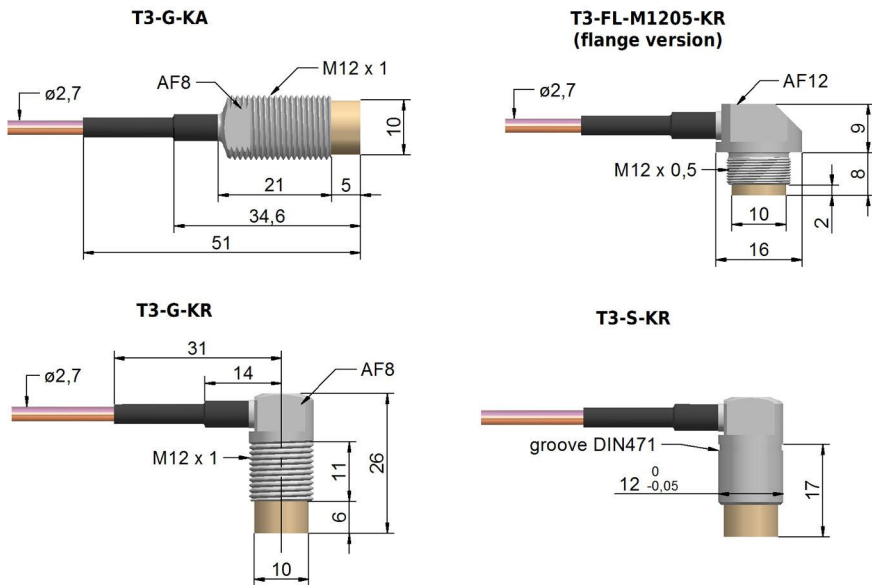

TECHNICAL DRAWINGS

Type T4

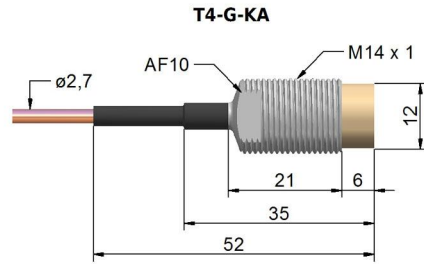

Type T5

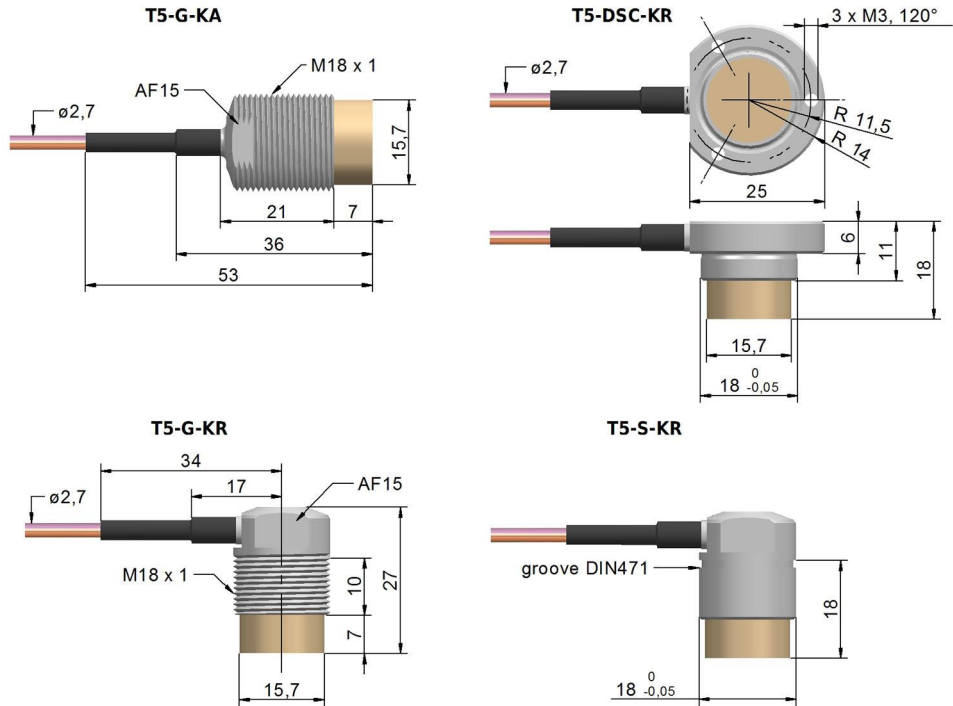

Type T10

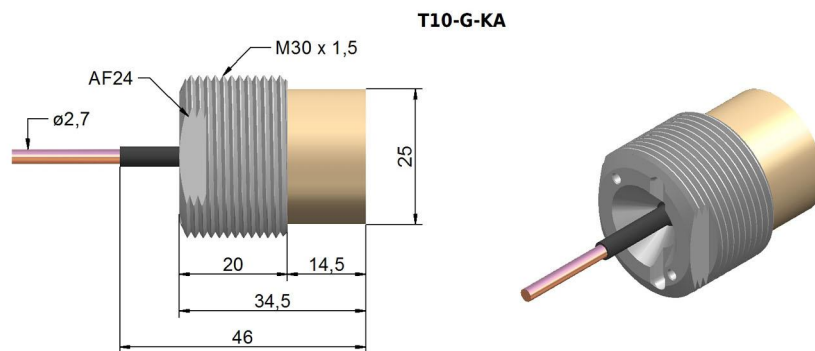

ACCESSORIES

Cable for power supply with mating connector M12 straight and angled - K4P

Cable with straight connector:

K4P2M-S-M12	2 m
K4P5M-S-M12	5 m
K4P10M-S-M12	10 m

Cable with angled connector:

K4P2M-SW-M12	2 m
K4P5M-SW-M12	5 m
K4P10M-SW-M12	10 m



BNC measurement line for the analogue output (Multi-Contact)

XLSS-58

Touch-safe coaxial measurement line. BNC connectors on both ends. Connectors have nickel plated shields and gold plated pins.

length 2 m, temperature range -10...+70 °C
capacity 219 pF, inductivity 680 nH, wave impedance 50 Ω



XLAM-446/SC

Highly flexible, entirely shielded measurement line. Touch-safe BNC connector on one end and two stackable Ø 4 mm connectors on the other end.

length 1,6 m, temperature range -10...+70 °C
capacity 240 pF, inductivity 1000 nH

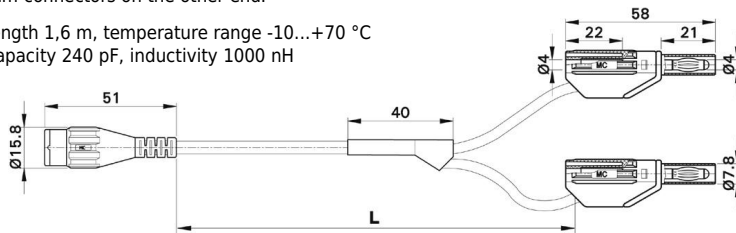

Cable extension TX-SMB-KOAX

Additional extension accordingly to option 2 (see page 5 below). SMB connector to BNC connector.

3 m length: TX-SMB-KOAX-3M
6 m length: TX-SMB-KOAX-6M

Note: for probes with SMB connectors only. The probe is calibrated with an extension that can be additionally ordered. Optional operation without extension is then no longer possible.



eddyLAB

Powerful Windows software incorporating three major functions:
Oscilloscope - FFT - Data logger (page 3).

Delivery contents: software-CD, gold-plated USB cable, dual shields
incl. 2 ferrites, length 1,8 m



Rail-power supply 24 VDC

PS-100-240AC/24DC/1.3

Extra narrow power supply - only 22.5 mm wide. Reliable start-up of several eddy current basic devices is guaranteed by a 100 % power boost.

Reliability is also achieved on difficult global networks. The supply will remain stable even if transient or static voltage failure occurs. Well dimensioned capacitors bypass power failures of more than 20 ms.

nominal input voltage	100-240 VAC, 45-65 Hz
output voltage	24 VDC
output current	1,3 A (max. 1,6 A)
temperature range	-25...+60 °C
power failure bypassing	> 110 ms (230 VAC)
efficiency	> 85 %
protection class	IP20

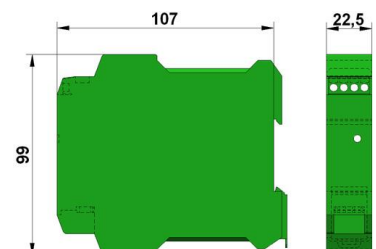

INSTALLATION

Electrical installation

Choose a dry location, preferably with a stable temperature for the electrical installation (eddy current basic module) such as electrical cabinets, terminal boxes, housing, etc.

Connect the supply line, probe lines and output lines. Please ensure that all supply and signal lines are laid separately from energy-carrying lines such as supply and discharge lines from convertors and drives, lines from ovens and synchronised appliances or generator lines, etc., in order to avoid malfunctions in the signal behaviour.

Please use shielded supply lines only and apply the shield to one side to avoid earth loops.

Please observe the correct assignment of the probes to the respective basic modules and channels. Each individual channel is aligned by the probe as a pair.

Probe installation

Firstly, install the probe at the relevant installation location and affix the probe using jam nuts or clamp mechanisms. After you have installed the probe, lay the cable. Ensure that the cable is laid without dents and it is not placed under stress. After you have laid the cable into place, do not turn the probe out of the thread, so as to prevent cable damage arising from stress. Secure excess probe cable as far away from temperature influences as possible, i.e. away from electronics. Never shorten the probe cable!

Please note that the probe head must be kept free from neighbouring metallic objects. In order to avoid attenuation of the measuring system, the following locations must not be impaired. In the case of installation into non-metallic and non-conductive materials, this is not necessary.

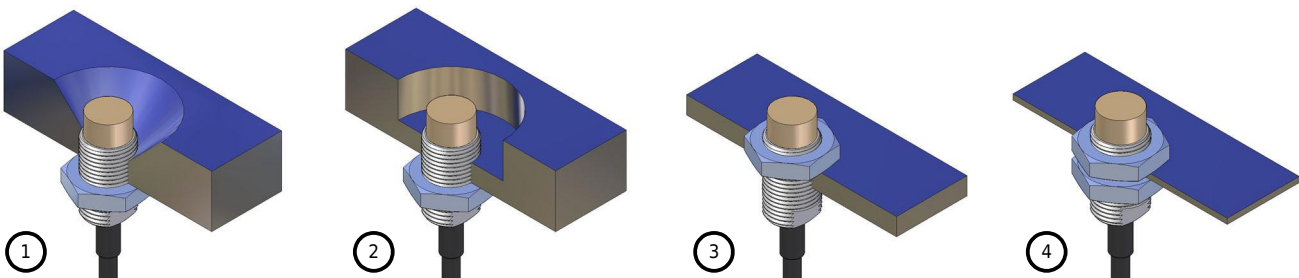

1) Installation with 45° countersinking. The diameter of the countersinking must be at least three times greater than the probe head diameter.

2) Installation with cylindrical countersinking. The diameter of the cylindrical countersinking must be at least 2-3 times greater than the probe head diameter. The projection of the probe cylindrical bottom: approx. three times the size of the measurement area; however, of at least the length of the PEEK head.

3) + 4) Installation into boards or metal with front or rear jam nut. Ideally, ensure there is an additional thread projection of approx. 3 mm to the board or the jam nut. Please note that thin-walled holders can oscillate or vibrate, and the holder's own frequency can interfere with the measurement result.

If these locations cannot be kept free of impairment as recommended, it is recommended that a ferrite-shielded probe or a customer-specific linearisation is used. Ferrite-shielded probes are available upon request.

Recommended pressure-tight installation

Some standard units can be installed in a pressure-tight manner to withstand system pressure of up to 50 bar by using a PEEK connector with O rings (see the image on the right). In the case of greater pressure areas, we can produce pressure-tight units as required.

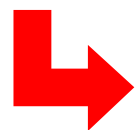
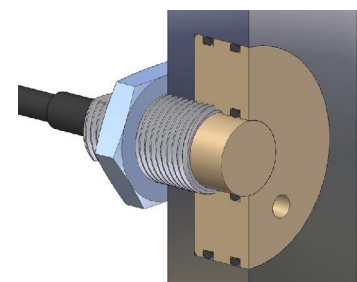

Please turn over

INSTALLATION

Object size and the eddy current measurement field

The eddy current measurement field (illustrated in red) is emitted elliptically from the probe level, and is greater than the probe head in terms of its spatial expansion. Therefore, for standard-calibrated probes a two-dimensional object surface with a probe head diameter 2-3 times greater than this is necessary for measurement. If the object is too small, only a part of the measurement field enters the material, and the output signal becomes larger. If the diameter is too small, the object appears to be further away from the sensor. A similar effect takes place in the case of round objects.

However, if other metallic objects force their way into the measurement field (e.g. laterally), the output signal is reduced due to the additional object. The actual object appears to be closer to the probe. If this signal alteration is not desired, we can provide customer-specific linearisation for such applications. In this case, the probe is calibrated directly with the object provided. The measurement area and the linearity are thus re-introduced into the specified area. The object (shape, material) is documented in the calibration document.

The following provides an overview of various geometric object properties:

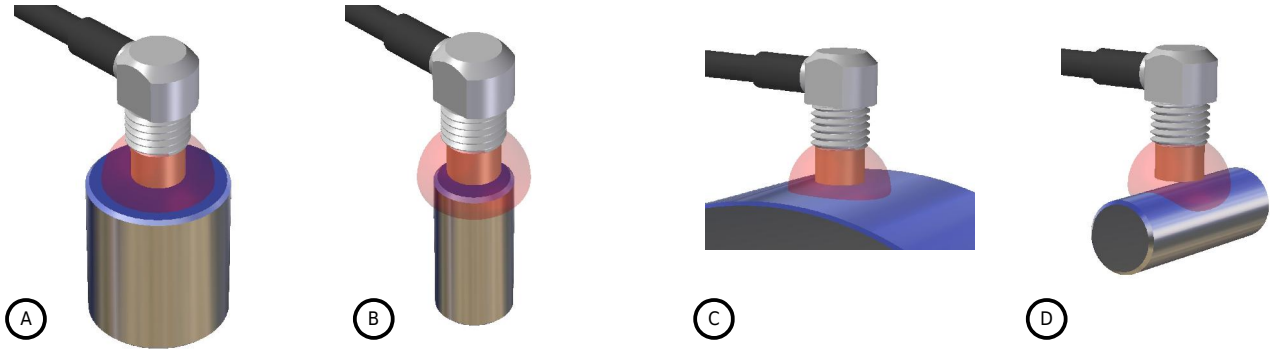

A) Optimum object surface, preferably 2-3 times greater than the probe head diameter. The measurement field is captured by the object entirely.

B) Reduced object surface, a part of the measurement field remains untouched by the object. The probe displays a greater distance signal than the actual distance. The measurement area is reduced in size. Lateral object movements can influence the distance signal. We can perform a customer-specific calibration in order to correct the measurement area and linearity.

C) Large round objects (diameter $> 8 \times$ probe head diameter) such as cranks or shafts can be captured without significant signal alterations. The probe outputs the medium distance via the captured surface. The measurement area reduces in size by $< 10\%$. To correct this, an optional customer-specific calibration can be performed. For example: shaft diameter $> 8 \times$ probe head diameter \leftrightarrow measured area reduction $< 10\%$, linearity $< 0.5\%$ of the measured area.

D) Small round objects such as shafts or wire (diameter $< 2 \times$ probe head diameter) can only be captured with a significantly smaller measurement area, insofar as customer-specific calibration has not taken place. For example: shaft diameter $< 2 \times$ probe head diameter \leftrightarrow reduction in the measurement area of $\sim 25\%$, linearity $\sim 1\%$. In this case, we recommend that we perform customer-specific calibration.

Metallic objects in the measurement field

Please note that metallic objects such as screw heads, bolts, etc., located in the measurement field in both a radial and axial direction (or which cross the measurement field during rotation) can become disturbance variables in the signal.

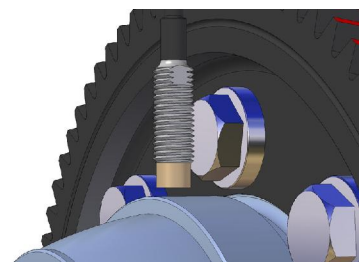

PRECAUTIONS

- Never shorten the probe's coaxial cable. The probe, cable and electronic system form a coordinated oscillating circuit.
- Lay the cable so that it is protected and avoid running it along objects with sharp edges. A cable that has been squashed or damaged in another manner can tamper with the signal or render the probe unusable.
- Please note that the sensors have been aligned with the electronic system. The alignment can be found in the calibration record or on the label on the unit, identified by the serial number. Do not switch the channels.
- Avoid placing the cable under tensile or torsional stress. Never turn the probes in the holders inwards or outwards without first loosening the fastenings.
- Observe the minimum bend radius for dynamic and static installation stated in the data sheet. Avoid kinks in the line.
- Protect the plug connections in the coaxial line against humidity and wetness.



PROBE ORDER CODE

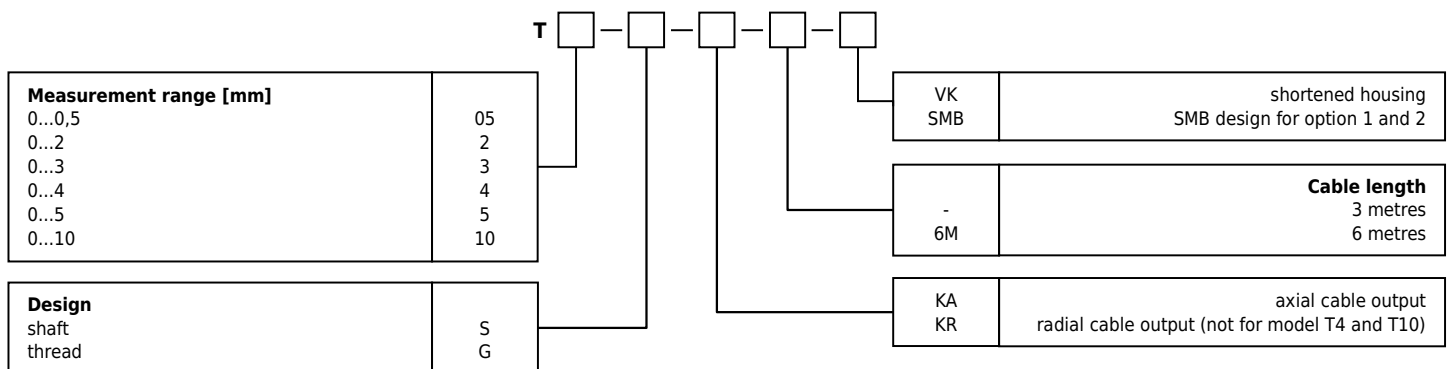

BASIC MODULE ORDER CODE

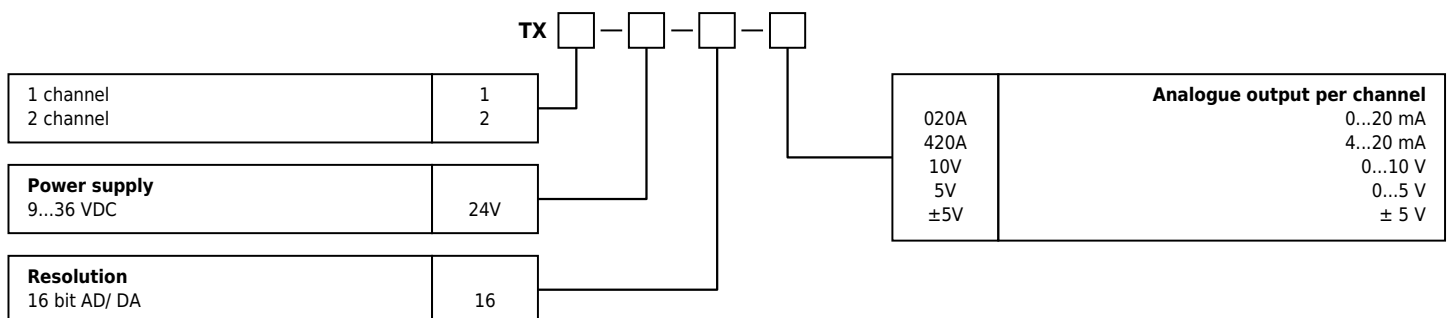

OPTIONS

TX-6M	cable length 6 m
TX-9M	cable length 9 m
TX-15M	cable length 15 m
TX-SMB	probe with SMB-connector + SMB/BNC-adapter (Option 1, see page 5)

ACCESSORIES

Extension cable for SMB connector (option 2)*

TX-SMB-KOAX-3M

TX-SMB-KOAX-6M

Supply cable with M12 mating connector

K4P2M-S-M12	2 m, straight connector	K4P2M-SW-M12	2 m, angular connector
K4P5M-S-M12	5 m, straight connector	K4P5M-SW-M12	5 m, angular connector
K4P10M-S-M12	10 m, straight connector	K4P10M-SW-M12	10 m, angular connector

BNC measurement cables for the analogue output

XLSS-58	BNC into BNC, 2 m
XLAM-446/SC	BNC into \varnothing 4 mm curved, 1,6 m

Windows software for USB

eddyLAB software CD, USB cable 1,8 m

Power supply

PS-100-240AC/24DC/1.3	24 VDC, 1,3 A / max. 1,6 A
PS-100-240AC/24DC/4	24 VDC, 4 A / max. 5 A
FW7662/12	12 VDC \pm 5 %, 500 mA (wall power supply)

* SMB/BNC adapter obsolete

Subject to change without prior notice.