

Position Markers for touchless Rotary Sensors

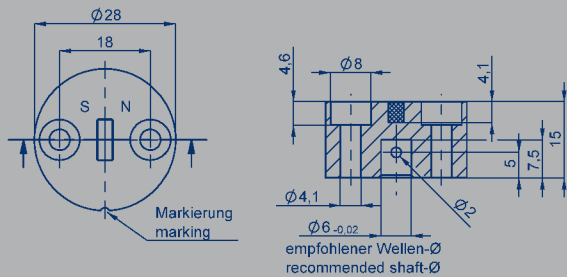

Z-RFC-P01

Position marker for frontal fixation with 2 screws or with locking pin

- magnet constant $1.85^\circ/\text{mm}^2$
- max. permitted radial offset ± 1.5 mm
- packaging unit 1 pcs. P/N 005660
- packaging unit 25 pcs. P/N 056079

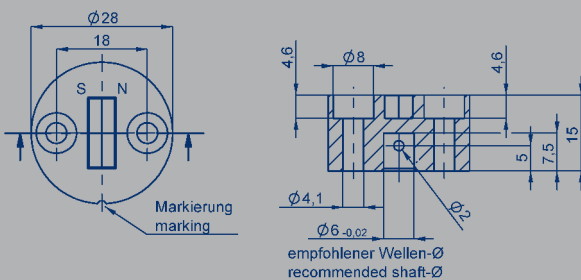

Z-RFC-P02

Position marker for frontal fixation with 2 screws or with locking pin

- magnet constant $0.8^\circ/\text{mm}^2$
- max. permitted radial offset ± 3 mm
- packaging unit 1 pcs. P/N 005661
- packaging unit 25 pcs. P/N 056080

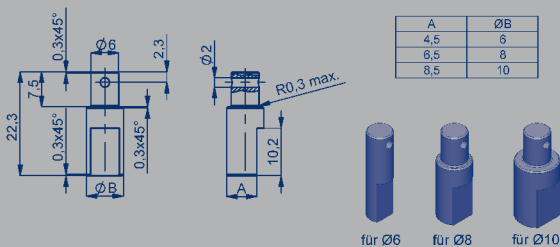

Z-RFC-S01 / Z-RFC-S02 / Z-RFC-S03

Shaft coupling for Z-RFC-P01 and Z-RFC-P02.
Fixation at position marker with locking pin

- Z-RFC-S01: Ø 6 mm, P/N 056206
- Z-RFC-S02: Ø 8 mm, P/N 056207
- Z-RFC-S03: Ø 10 mm, P/N 056208

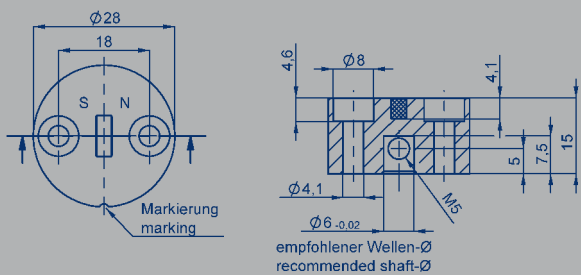

Z-RFC-P07

Position marker for frontal fixation with 2 screws or with threaded pin M5

- magnet constant $1.85^\circ/\text{mm}^2$
- max. permitted radial offset ± 1.5 mm
- packaging unit 1 pcs. P/N 056069
- packaging unit 25 pcs. P/N 056083

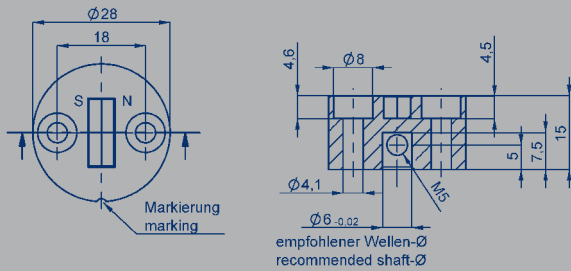

Z-RFC-P08

Position marker for frontal fixation with 2 screws or with threaded pin M5

- magnet constant $0.8^\circ/\text{mm}^2$
- max. permitted radial offset ± 3 mm
- packaging unit 1 pcs. P/N 056070
- packaging unit 25 pcs. P/N 056084

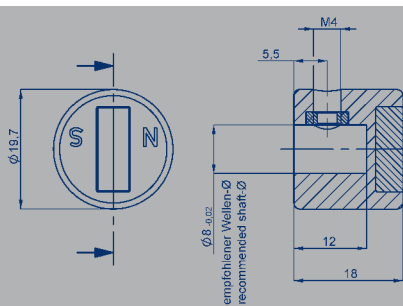

Z-RFC-P23

Position marker for fixation with threaded pin M4

- magnet constant $0.8^\circ/\text{mm}^2$
- max. permitted radial offset ± 3 mm
- packaging unit 1 pcs. P/N 056074
- packaging unit 25 pcs. P/N 056085

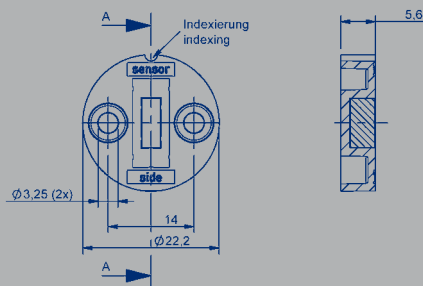

Z-RFC-P30

Position marker for frontal fixation with 2 screws

- magnet constant $1.85^\circ/\text{mm}^2$
- max. permitted radial offset ± 1.5 mm
- packaging unit 1 pcs. P/N 056086
- packaging unit 25 pcs. P/N 056087

Working distances (in mm)

Sensor Series	Z-RFC-...							
	P01	P02	P03	P04	P07	P08	P23	P30
RFC analog / digital SPI	0...1,5	0...4	0...1,5	0...4	0...1,5	0...4	0...4	-
RFC digital SSI, Incremental	0...1	0...1,5	0...1	0...1,5	0...1	0...1,5	0...1,5	-
RFA one channel	-	-	2 \pm 1	4,5 \pm 1,7	-	-	4,5 \pm 1,7	-
RFA redundant	-	-	1,6 \pm 1	4,1 \pm 1,7	-	-	4,1 \pm 1,7	-
RFD one channel	-	-	2 \pm 1	4,5 \pm 1,7	-	-	4,5 \pm 1,7	1,95 \pm 0,75
RFD redundant	-	-	1,6 \pm 1	4,1 \pm 1,7	-	-	4,1 \pm 1,7	1,5 \pm 0,75

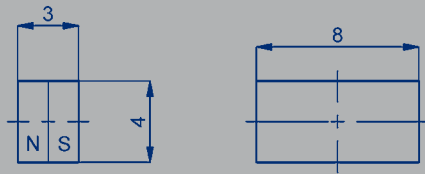

Z-RFC-P03

Magnet for direct application onto customer's shaft

- magnet constant 1.85°/mm²
- max. permitted radial offset ±1,5 mm
- packaging unit 1 pcs. P/N 005658
- packaging unit 50 pcs. P/N 056081

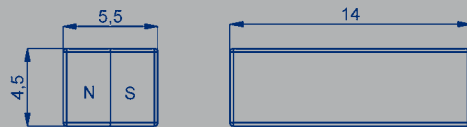

Z-RFC-P04

Magnet for direct application onto customer's shaft

- magnet constant 0.8°/mm²
- max. permitted radial offset ±3 mm
- packaging unit 1 pcs. P/N 005659
- packaging unit 50 pcs. P/N 056082

Lateral magnet offset (will cause additional linearity error):

The maximum error which is caused by lateral offset between sensor and position marker can be approximated as follows:

$$\text{Error [}^\circ\text{]} = \text{magnet constant} \times (\text{offset [mm]})^2$$

The magnet constant depends on the position marker.

Example: Z-RFC-P02:

magnet constant = 0.8° /mm²;

offset = 0.5 mm

$$\text{Error [}^\circ\text{]} = 0.8^\circ/\text{mm}^2 \times (0.5 \text{ mm})^2 = 0,2^\circ$$

Mounting instructions Z-RFC-P03 / Z-RFC-P04

- If the shaft is magnetizable please keep sufficient distance
- When the magnet is mounted in the shaft, the shaft may not be magnetizable
- If the magnet is axially fixed on a magnetizable shaft the working distances reduces by approximately 20 %
- In general, we recommend mounting on not magnetizable materials, otherwise the stated working distances can change.

