

## Excel 800 SYSTEM

### HONEYWELL EXCEL 5000 OPEN SYSTEM

#### SPECIFICATION DATA



## GENERAL

The Excel 800 (consisting of the XCL8010A Controller Module and connected Excel 800 Panel Bus or LONWORKS Bus Input/Output Modules) provides highly cost-effective freely programmable control for heating, ventilation, and air conditioning (HVAC) systems. It performs a wide range of energy management functions, including optimum start/stop, night purge, and max. load demand. The Excel 800 provides excellent value during installation and long-term operation. The modular design enables the system to be expanded to meet growing needs.

The Excel 800 operates via "plug & play" Panel Bus I/O Modules, yielding huge installation and commissioning cost-savings due to new, patented technologies, while also operating with LONWORKS Bus I/O modules utilizing the LONWORKS communication standard. The I/O modules consist of a terminal socket and a removable electronic module, allowing the socket to be mounted and wired before the electronic module is installed. All electronic modules can be changed without disrupting the power and bus connections: Software updates, configuration, and commissioning are all done automatically for the Panel Bus I/O Modules.

The open LONWORKS standard enables easy integration of 3<sup>rd</sup>-party controllers and communication with other Honeywell devices (e.g. Excel 10 and Excel 12 room controllers).

Remote service can be done via a modem / ISDN terminal adapter in connection with a building supervisor.

Direct Web is supported via Honeywell's OpenViewNet, which may be connected via C-Bus to the Excel 800.

## FEATURES

- Plug-and-play Panel Bus I/O Modules for easy maintenance
- LONWORKS Bus I/O Modules (FTT10-A, link power compatible) for easy integration into any system
- I/O module exchange without disrupting the power and bus connections
- Reuseability of existing applications (Excel 500, etc.)
- Fast wiring due to state-of-the-art push-in terminals and bridge connectors
- Wide range of sensors supported (PT3000, Balco500, NTC20k, PT1000-1/-2..., 0/2...10 V, 0/4...20 mA)
- Binary input LEDs can be configured for status display (off/yellow) or alarm display (green / red) per channel
- Configurable safety position for outputs
- Realtime clock
- Max. wiring flexibility due to optional accessories like aux. terminals, manual disconnectors, and Cross-Connectors
- Can be mounted in small installation housings
- Flexible I/O module mix covering all your application requirements
- Utmost flexibility to design and control your most complex applications through increased memory size
- State-of-the-art control of critical applications thanks to short cycle times (30% faster than Excel 500)
- Fast firmware download (~90 sec) via serial connection
- C-Bus to upgrade from and operate with existing Honeywell installations, thereby protecting your investment
- Web access via optional OpenViewNet
- Dedicated modem interface for remote operation
- Human-Machine-Interface, Laptop connection
- Separate installation of terminal sockets and electronic modules, thus lower risk of damage and theft in the construction phase

## SYSTEM OVERVIEW

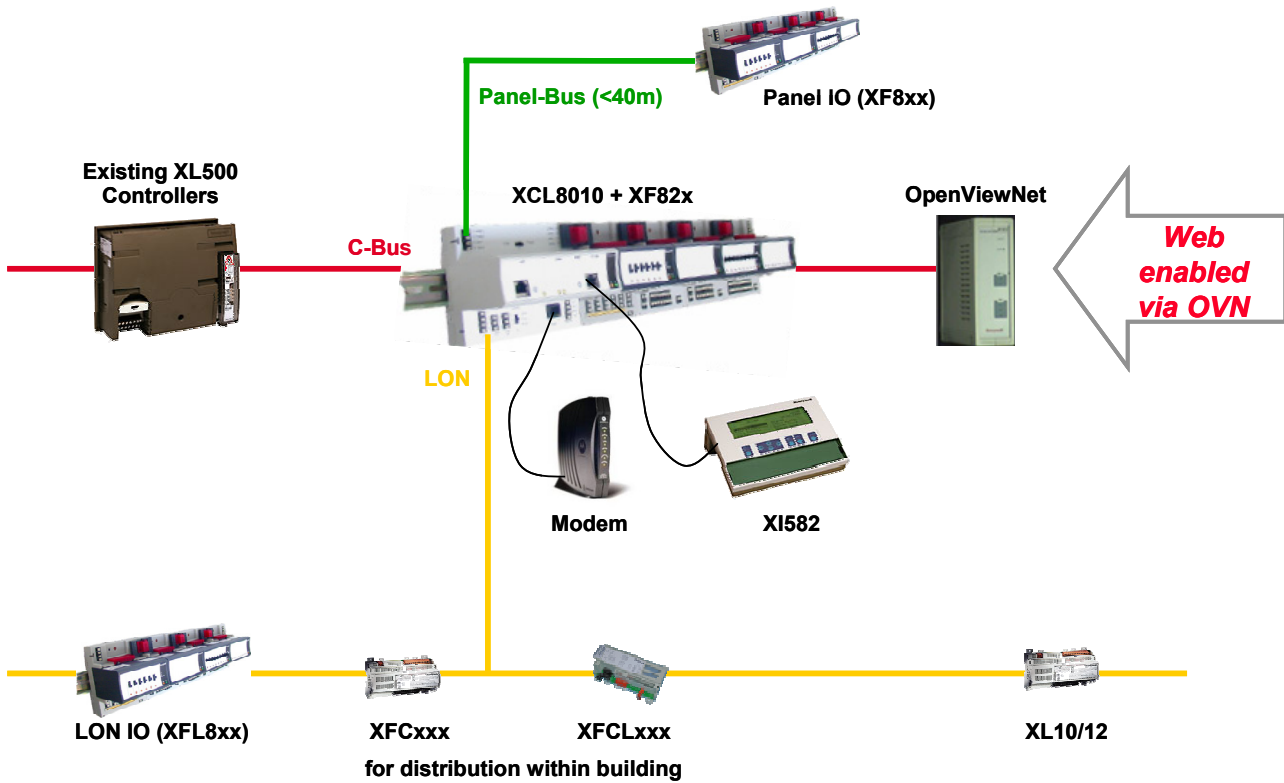

Fig. 1. Excel 5000 architecture (overview)

### General

The Excel 800 Controller Module (XCL8010A) can communicate with a variety of other devices (see Fig. 4), including any combination of up to sixteen Panel I/O Modules and LONWORKS devices (e.g. room controllers). The Excel 800 Panel Bus I/O Modules communicate via the Panel Bus, while the Excel 800 LONWORKS Bus I/O modules utilize the LONWORKS communication standard and can thus also communicate with other LONWORKS controllers.

Both kinds of I/O modules consist of a terminal socket and a removable electronic module, allowing the socket to be

mounted and wired before the electronic module is installed. All of the electronic modules can be swapped out without disrupting the power and bus connections: Simply unplug the “old” and insert the “new” module. Software updates, configuration, and commissioning are all done automatically by the Excel 800 Controller Module for the Panel Bus I/O Modules. The Excel 800 Panel Bus I/O Modules are addressed manually by adjusting their HEX switches. The Excel 800 LONWORKS I/O Modules are configured using CARE.

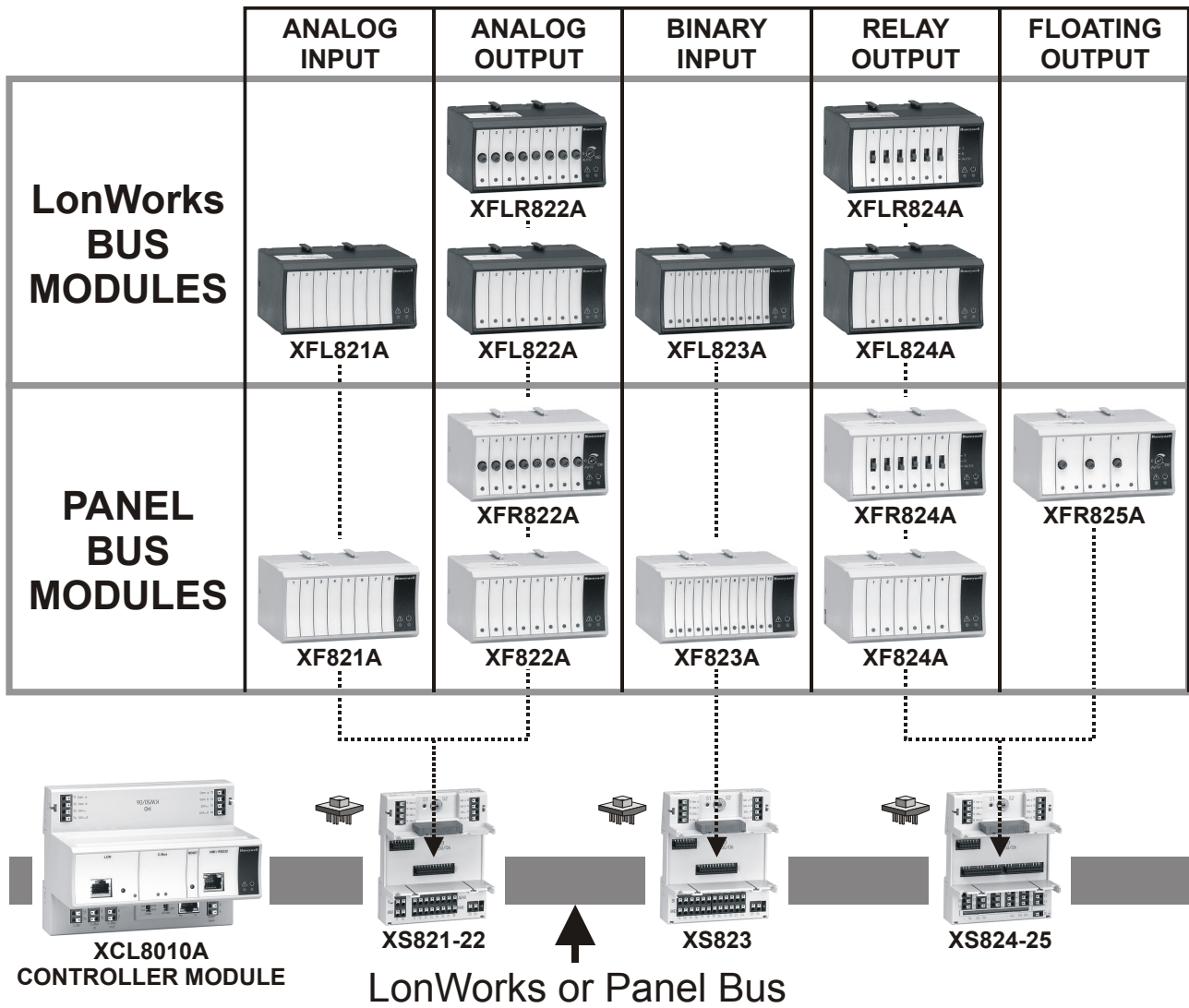





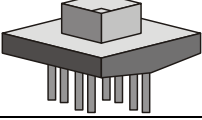



Fig. 2. Overview of Excel 800 Modules  
Table 1. Overview of Excel 800 Modules

order number	description
XCL8010A	Excel 800 Controller Module
<b>Panel Bus I/O Modules</b>	
XF821A	Panel Bus Analog Input Module (with 8 analog inputs)
XF822A	Panel Bus Analog Output Module (with 8 analog outputs)
XFR822A	Panel Bus Analog Output Module (with 8 analog outputs and manual overrides)
XF823A	Panel Bus Binary Input Module (with 12 binary inputs)
XF824A	Panel Bus Relay Output Module (with 6 relay outputs)
XFR824A	Panel Bus Relay Output Module (with 6 relay outputs and manual overrides)
XFR825A	Panel Bus Floating Output Module (with 3 floating outputs and manual overrides)
<b>LONWORKS Bus I/O Modules</b>	
XFL821A	LONWORKS Bus Analog input module (with 8 analog inputs)
XFL822A	LONWORKS Bus Analog Output Module (with 8 analog outputs)
XFLR822A	LONWORKS Bus Analog Output Module (with 8 analog outputs and manual overrides)
XFL823A	LONWORKS Bus Binary Input Module (with 12 binary inputs)
XFL824A	LONWORKS Bus Relay Output Module (with 6 relay outputs)
XFLR824A	LONWORKS Bus Relay Output Module (with 6 relay outputs and manual overrides)
<b>Terminal Sockets</b>	
XS821-22	Terminal Socket for Analog Input / Output Modules (incl. terminal socket, connector bridge, and swivel label)
XS823	Terminal Socket for Binary Input Modules (incl. terminal socket, connector bridge, and swivel label)
XS824-25	Terminal Socket for Relay / Floating Output Modules (incl. terminal socket, connector bridge, cross connector, and swivel label)

**Table 2. Overview of auxiliary parts and spare parts**

order number	description
 <b>XS812</b>	Manual Disconnecter Module for AI/AO/BI Modules (for manual disconnection of individual signals; useful during start-up). Plugged between Terminal Socket and Electronic Module.
 <b>XS812RO</b>	Manual Disconnecter Module for Relay Output Modules (for manual disconnection of individual signals; useful during start-up). Plugged between Terminal Socket and Electronic Module. Not suitable for line voltage.
 <b>XS814</b>	10 Auxiliary Terminal Blocks (for distribution of signals). Each terminal block includes two groups with seven internally-connected terminals.
 <b>XS815</b>	20 Cross-Connectors for connection of six relay commons. One Cross-Connector is included in the Terminal Socket package.
 <b>XS817</b>	40 Cross-Connectors for connection of three relay commons (if voltage in relay block 1 is different from voltage in relay block 2).
 <b>XS816</b>	10 Bridge Connectors. One Bridge Connector is included in the Terminal Socket package.
 <b>XAL10</b>	10 Swivel Labels (for attaching the application-specific label printed with CARE). One Swivel Label is included in the Terminal Socket package.
<b>XW586</b>	Modem cable for Excel 800.
<b>XW882</b>	Adapter cable for XI582AH Operator Interface (alternatively, XW586 + XW582 can be used).
<b>XW885</b>	Download cable (alternatively, XW586 + XW585 can be used).

**NOTE: All Excel 800 I/O Modules are protected against short circuit, 24 V~ +20% and 30 Vdc**

**Table 3. Excel 800 I/O Module specifications**

Module	Analog Input	Analog Output	Binary Input	Relay Output	Floating Output
Panel	XF821A	XF822A, XFR822A	XF823A	XF824A, XFR824A	XFR825A
LONWORKS	XFL821A	XFL822A, XFLR822A	XFL823A	XFL824A, XFLR824A	
no. of I/Os	8 analog inputs	8 analog outputs	12 binary inputs	6 relay outputs	3 floating outputs
characteristic	<p>Linear Graph 0..10 Vdc with pull-up, 0(2)...10 Vdc without pull-up  <b>NTC20k (default)</b>                      PT<sub>1000-1</sub> (-50...150°C)                      PT<sub>1000-2</sub> (0...400°C)                      PT<sub>3000</sub> (-50...150°C)                      BALCO<sub>500</sub> (-30...120°C)</p> <p>Also configurable as: binary inputs</p> <ul style="list-style-type: none"> <li>Linear graph (0...10 V with pull-up)</li> </ul> <p><b>Features:</b></p> <ul style="list-style-type: none"> <li>16-bit resolution</li> <li>configurable offset per input</li> <li>auxiliary voltage: 10 Vdc, I<sub>max</sub> = 5 mA</li> </ul>	<p>0...11 Vdc / ± 1 mA, 8-bit resolution (default)                      Also configurable as: floating outputs or binary outputs (0 V / 10 V)</p> <p><b>Features:</b></p> <ul style="list-style-type: none"> <li>8-bit resolution</li> <li>Safety position (remain, 0%, 50%, 100%)</li> <li>red LED per output</li> <li>light intensity follows output level in auto</li> </ul> <p><b>Version with manual override (R):</b></p> <ul style="list-style-type: none"> <li>1 potentiometer per output</li> <li>auto feedback signal (mode + value)</li> <li>blinking in manual override position</li> </ul>	<p>static binary input (default: dry contact)                      Also configurable as: totalizers (20 Hz)</p> <p><b>Features:</b></p> <ul style="list-style-type: none"> <li>1 LED per input</li> <li>Color mode can be set per input to OFF/yellow or green/red using CARE</li> </ul>	<p>relay outputs (default)                      Also configurable as floating outputs</p> <p><b>Features:</b></p> <ul style="list-style-type: none"> <li>Changeover relays</li> <li>Voltage: 19...250 V~, 1...29 Vdc, P&gt;50 mW</li> <li>max. total current: 12 A</li> <li>current per relay: N.O.: 4(4) A~ or 4(1) A=, N.C.: 2(1) A~ or 4(1) A=</li> <li>Safety position (remain, 0%, 100%)</li> <li>yellow LED per output</li> </ul> <p><b>Version with manual override (R):</b></p> <ul style="list-style-type: none"> <li>1 switch per output</li> <li>auto feedback signal (mode + value)</li> <li>blinking in manual override position</li> </ul>	<p>floating outputs</p> <p><b>Features:</b></p> <ul style="list-style-type: none"> <li>2 relays per floating output</li> <li>Voltage: 19...250 V~, 1...29 Vdc, P&gt;50 mW</li> <li>max. total current: 12 A</li> <li>current per relay: N.O.: 4(4) A~ or 4(1) A=, N.C.: 2(1) A~ or 4(1) A=</li> <li>1 potentiometer per floating output</li> <li>2 LEDs per output: green: relay 1 closed, red: relay 2 closed</li> <li>blinking in manual override position</li> <li>auto feedback signal (mode + value)</li> </ul>

# XCL8010A CONTROLLER MODULE

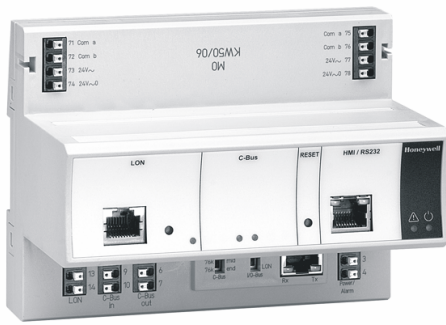
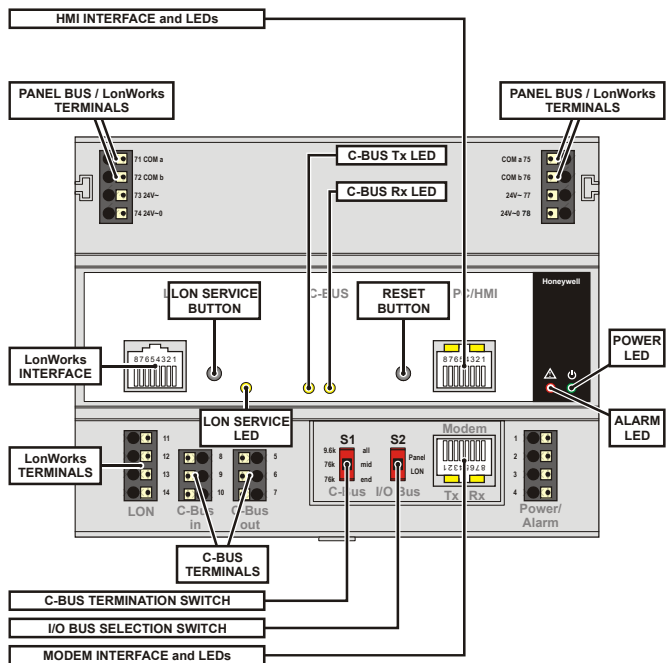

**Fig. 3. XCL8010A Controller Module**

The XCL8010A Controller Module can communicate with a variety of other devices (see Fig. 4), including any combination of up to sixteen Panel I/O Modules and/or LONWORKS devices (e.g. room controllers).

A total of 381 data-points (of all types, e.g. internal virtual data-points and hardware data-points) are permitted. Typically, HVAC applications require an equal number of internal virtual data-points and hardware data-points.

Up to 40 m distance between the XCL8010A and the Panel I/O Modules.



**Fig. 4. XCL8010 Controller Module features**

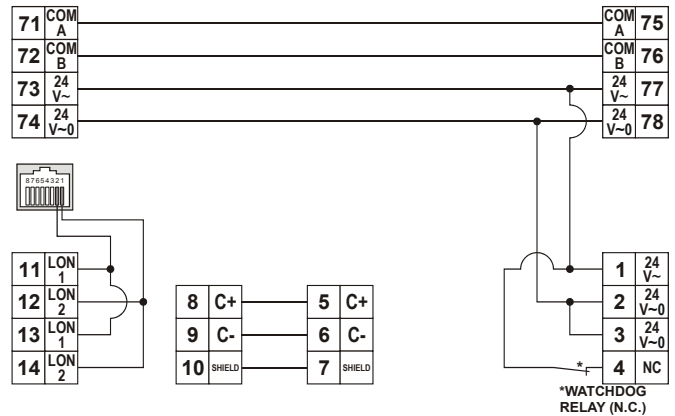

**Fig. 5. XCL8010A Controller Module, terminal assignment**

## Electrical Specifications

### Operating Voltage

24 Vac, ± 20%, 21...30 Vdc

The Excel 800 System (XCL8010 Controller Module and connected Excel 800 I/O Modules together with field devices) can be powered by one or more external transformers.

### Memory

- 128 kB EPROM
- 512 kB RAM
- 2 MB Flash EPROM (firmware and application)

### Watchdog

The watchdog output is active if the Excel 800 Controller Module is not operating properly.

### Microprocessor

16-bit processor (TMP 91 CY22). 22 MHz

### Memory and Realtime Clock Backup

In case of power failure, the super capacitor saves RAM content and real-time clock for 72 hours (environmentally friendly; no problems disposing of dead batteries).

## XI582AH OPERATOR INTERFACE

The XCL8010A can be connected with an XI582AH Operator Interface or PC-based XL-Online operator and service software.



**Fig. 6. The XI582AH Operator Interface**

The XI582AH Operator Interface is the command and information center of the Excel 800 System. With it, data can be entered and displayed. Information such as current temperature values, control status, etc. can also be displayed. The menu-driven, 6-line, backlit LCD graphic display with 34 characters per line, together with eight clearly marked keys, makes the device easy to use.

The XI582AH is connected to the HMI Interface on the front of the Excel 800 Controller Module. The XI582AH can be mounted up to 15 m (48 ft.) away from the Controller Module. This can be extended to 100 m (328 ft.) using line drivers.

## XL-ONLINE

The PC-based XL-Online is the local intelligent operating and service software. It performs all the operating functions of the XI582AH as well as having the advantages of a PC. Not only can the XL-Online make major modifications such as changing setpoint values and time program switching points, it also offers all service and commissioning functions.

XL-Online can be operated at five different access levels, three of which are password-protected. A printer can be connected to the parallel interface of the PC to log alarms and error messages. As with the XI582AH, the PC with the XL-Online operator and service software can be placed up to 15 meters from the computer module. Line drivers allow distances of up to 100 m (328 ft.).

## Communication

### Human-Machine Interface

The XCL8010A Controller Module is equipped with an HMI Interface (RJ45 socket serving as a serial port) for the connection of HMIs, e.g.:

- the XI582AH Operator Interface or
- a laptop (with XL-Online / CARE).

### C-Bus Interface

Up to 30 C-bus devices (e.g. controllers, etc.) can communicate with one another and a PC central via the C-bus interface. The C-bus must be connected through the individual controllers (open ring topology).

### Web Interface

The optional OpenViewNet™ (OVN, see also Fig. 1 on page 2) is an intelligent BMS (Building Management System) that interfaces Excel 800 Controller Modules on one end and provides TCP/IP interface on the other. The device is then IP-enabled and accessible from anywhere in the world. The OpenViewNet's processor and in-house memory hosts and runs both the operating system and the application that enables a user to monitor and supervise buildings remotely. Notification of alarms and events are provided so that actions can be taken accordingly. You can also generate reports, schedule them to run periodically, use customized graphics for monitoring, and trend important data off-line or online. The processing of data between the device and the clients is distributed to utilize the resources effectively and efficiently.

### LONWORKS Interface

The LONWORKS bus is a 78-kilobit serial link that uses transformer isolation so that the bus wiring does not have a polarity; that is, it is not important which of the two LONWORKS bus terminals are connected to each wire of the twisted pair. The LONWORKS bus can be wired in daisy chain, star, loop or any combination thereof as long as the max. wire length requirements are met. The recommended configuration is a daisy chain with two bus terminations. This layout allows for max. LONWORKS bus length, and its simple structure presents the least number of possible problems, particularly when adding on to an existing bus.

### Modem Interface

The XCL8010A Controller Module is equipped with a Modem Interface (RJ45 socket serving as a serial port) for the connection of a modem or an ISDN terminal adapter.

### Panel Bus Interface

The XCL8010A Controller Module features a panel bus interface (max. 40 m), polarity-insensitive for easy wiring. Deterministic bus (cycle time: 250 ms to scan all connected Panel I/O Bus Modules).

## PROGRAMMING

The Excel 800 System includes a comprehensive software package specially designed to meet the requirements of application engineers. The easy-to-use, menu-driven software features the following functions:

- data point description,
- time program,
- alarm handling,
- application program (DDC program),
- password protection.

### Data Point Description

Data points are the basis of the Excel 800 System. They contain system-specific information such as values, status, limit values, and default settings. The user has easy access to data points and the information that they contain. The user can recall and modify information in the data points.

## Time Program

The time program can be used to enter the setpoint or status at any time for any data point. The following time programs are available:

- daily program,
- weekly program,
- annual program,
- TODAY function,
- special day list.

Daily programs are used to create a weekly program. The annual program is created automatically by multiplying the weekly program and then incorporating daily programs. The TODAY function allows direct changes to the switching program. It allows you to allocate a setpoint or status to the selected data point for a defined period of time.

## Alarm Handling

The alarm handling facility offers system security. Alarm signals can, for example, alert the operator to scheduled maintenance work. All alarms that occur are stored in data files and reported immediately. If your system configuration allows, you can also list alarms on a printer or transmit alarms to higher-level devices via the local bus or a modem.

There are two types of alarms, critical and non-critical. Critical alarms (e.g. system alarms caused by communication failures) have priority over non-critical alarms. To distinguish between alarm types, you can generate your own alarm messages or use pre-programmed system messages. The following events all generate alarm messages:

- exceeding limit values,
- overdue maintenance work,
- totalizer readings,
- digital data point changes of state.

The alarm buffer can contain up to 99 alarms.

## Application Program (DDC program)

You can use the Honeywell CARE programming tool to create application programs for your system. A set of predefined applications (MODAL) is available in order to provide state-of-the-art applications without the need of programming.

## Password Protection

The Excel 800 System is also protected by passwords. This ensures that only authorized persons have access to system data. There are four operator levels, each protected by its own password.

**Operator level 1:** Read only. The operator can display information about setpoints, switching points, and operating hours.

**Operator level 2:** Read and make limited changes. The operator can display system information and modify certain pre-set values.

**Operator level 3:** Read and make changes. System information can be displayed and modified.

**Operator level 4:** Access level for tools (e.g. CARE, XL-Online).

## Trending

The Excel 800 System provides controller-based trending. This feature allows historical values to be stored in the Controller Module. Both time-based or value-hysteresis-based trending are possible.

## EXCEL 800 I/O MODULES

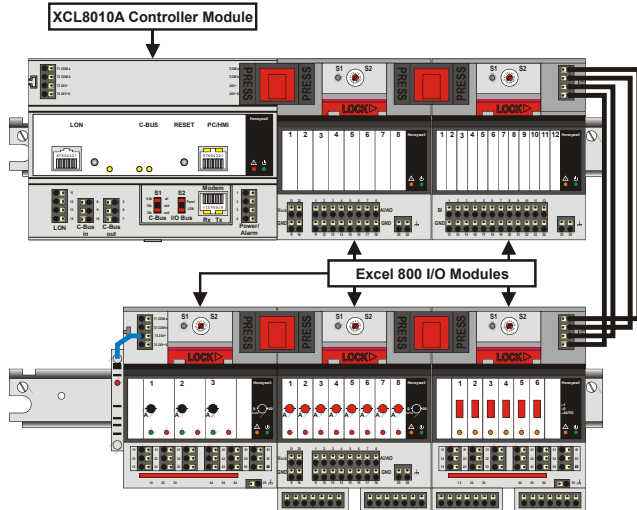

Fig. 7. Excel 800 Controller and I/O Modules on DIN rails

### General

Each Excel 800 I/O Module is equipped with:

- one green power LED
- one yellow status LED

### Overvoltage Protection

All inputs and outputs are protected against 24 Vac and 40 Vdc overvoltage as well as against short-circuiting.

### Service LED

Each I/O Module is equipped with a yellow service LED for easy diagnosis of failures.

### Microprocessor

Each I/O Module is equipped with its own microprocessor.

### Panel Bus I/O Modules

Up to 16 I/O modules in any I/O mixture may be connected. Addressing is performed using the HEX switch located on each terminal socket.

The Excel 800 Controller Module and Panel I/O Modules can be separated by up to 40 m. Firmware maintenance is automatically handled by the XCL8010A.

### LonWorks Bus I/O Modules

The LONWORKS Bus I/O Modules can be used with any LONWORKS controller.

In addition to the main microprocessor, the LONWORKS Bus I/O Modules also have their own Neuron chip (3120). Each LonWorks I/O Module is equipped with an FTT-10A transceiver (linki power compatible).

A LONWORKS service button is located on each terminal socket.



## Analog Input Modules

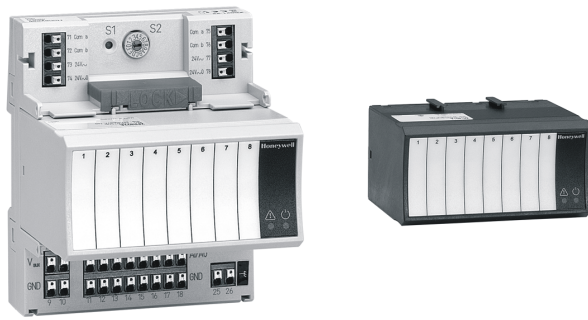

**Fig. 8. XF821A Panel Bus AI Module (shown with socket) and XFL821A LonWorks Bus AI Module (shown without socket)**

The Excel 800 Analog Input Modules, with 8 analog inputs, are available in the following versions:

- XF821A Panel Bus Analog Input Module
  - XFL821A LONWORKS Bus Analog Input Module
- They are installed with the XS821-22 Terminal Socket (incl. one connector bridge and one swivel label).

Accessory disconnecter module: XS812 (see also Table 2 on page 4).

### Features

- 0...10 Vdc, 2...10 Vdc without pull-up
- 0...10 Vdc with pull-up (linear graph, e.g. used for wall module connection)
- 0/4...20 mA, needs 499 Ω resistor in parallel
- NTC20k (default)
- PT1000-1 (-50...+150 °C)
- PT1000-2 (0...+400 °C)
- PT3000 (-50...+150 °C)
- BALCO500 (-30...+120 °C)
- Binary input
- 16-bit resolution
- Configurable offset per input
- Auxiliary voltage: 10 Vdc, I<sub>MAX</sub> = 5 mA
- Sensor failure detection

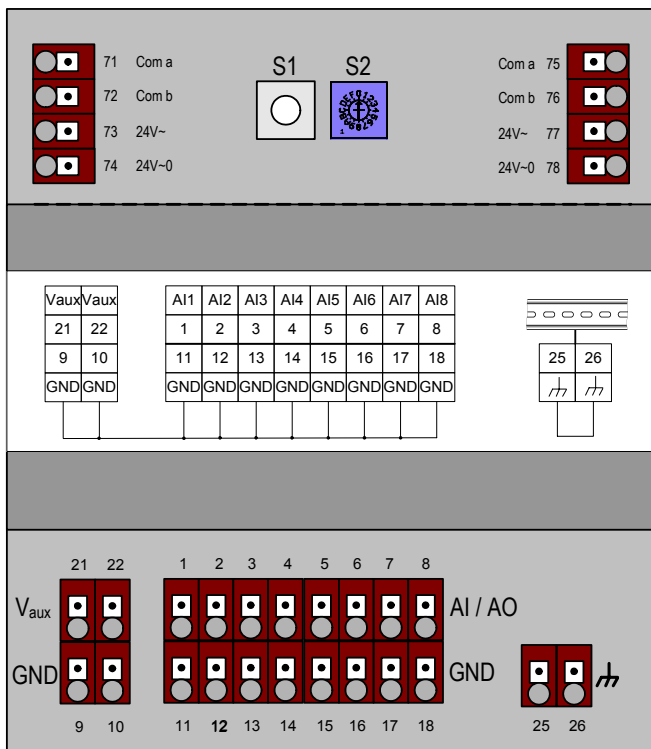

**Fig. 9. Excel 800 Analog Input Modules (top view)**

## Analog Output Modules

### XF822A



### XFL822A



Fig. 10. XF822A Panel Bus AO Module and XFL822A LonWorks Bus AO Module (both shown without socket)



Fig. 11. XFR822A Panel Bus AO Module (shown with socket) and XFL822A LonWorks Bus AO Module (shown without socket)

The Excel 800 Analog Output Modules, with 8 analog outputs, are available in the following versions:

- XF822A Panel Bus Analog Output Module (without manual overrides)
- XFR822A Panel Bus Analog Output Module (with manual overrides)
- XFL822A LONWORKS Bus Analog Output Module (without manual overrides)
- XFLR822A LONWORKS Bus Analog Output Module (with manual overrides)

They are installed with the XS821-22 Terminal Socket (incl. one connector bridge and one swivel label).

Accessory disconnecter module: XS812 (see also Table 2 on page 4).

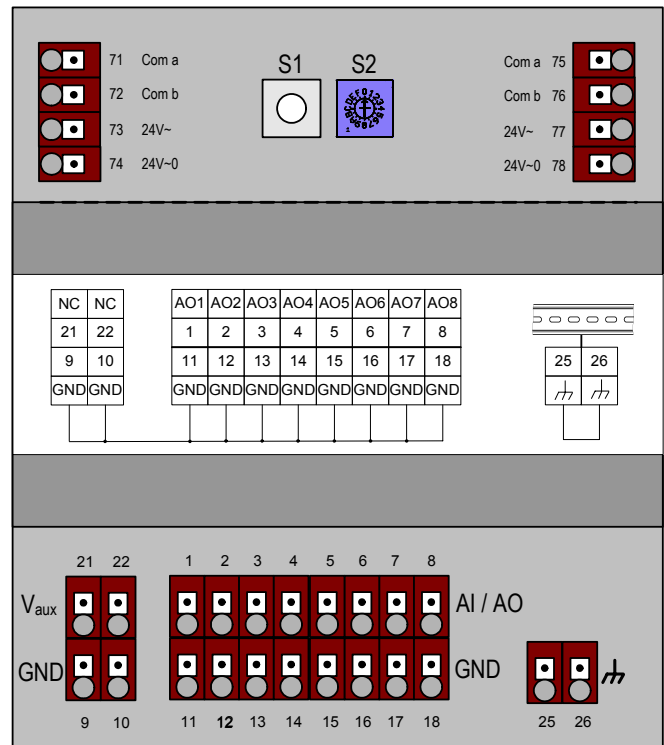
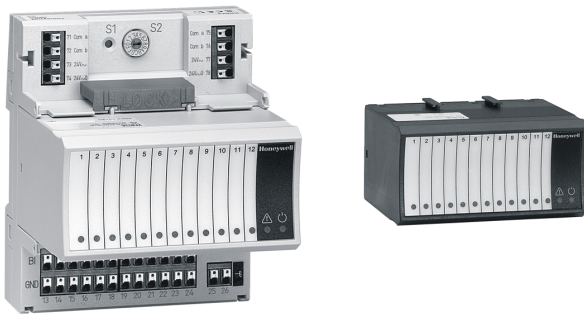

Fig. 12. Excel 800 Analog Output Modules (top view)

### Features

- 0...11 Vdc, +/-1 mA
- Floating actuator (requires MCD3)
- Binary output (0 V / 10 V)
- red LED per output (brightness according to signal level)
- Optional versions with manual override potentiometers (Auto, 0...100%; LED flashes in override mode)
- Feedback on manual override signal
- 8-bit resolution
- Configurable safety position for outputs in case of communication problems (remain, 0%, 50%, 100%)

## Binary Input Modules



### Features

- Static binary input (dry contact)
- Totalizer for up to 20 Hz
- LEDs per binary input supporting alarm display mode (red/green) or status mode (off/yellow).
- Color mode of each LED can be set to OFF/yellow or green/red in CARE.

**Fig. 13. XF823A Panel Bus BI Module (shown with XS823) and XFL823A LonWorks Bus BI Module (shown without socket)**

The Excel 800 Binary Input Modules, with 12 binary inputs, are available in the following versions:

- XF823A Panel Bus Binary Input Module
- XFL823A LONWORKS Bus Binary Input Module

They are installed with the XS823 Terminal Socket (incl. one connector bridge and one swivel label).

Accessory disconnector module: XS812 (see also Table 2 on page 4).

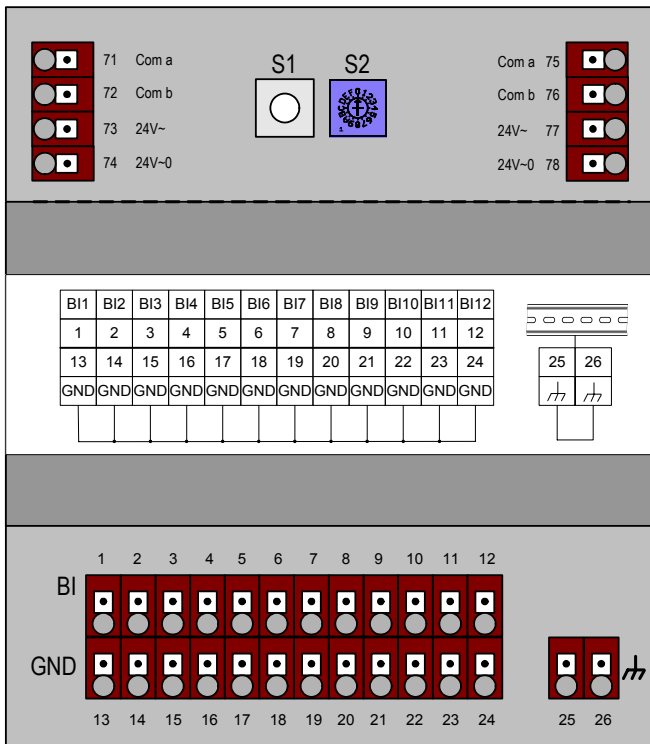

**Fig. 14. Excel 800 Binary Input Modules (top view)**

## Relay Output Modules

### XF824A



### XFL824A



Fig. 15. XF824A Panel Bus Relay Output Module and XFL824A LonWorks Bus Relay Output Module (both shown without socket)



Fig. 16. XFR824A Panel Bus Relay Output Module (shown with socket) and XFLR824A LonWorks Bus Relay Output Module (shown without socket)

The Excel 800 Relay Output Modules, with 6 relay outputs, are available in the following versions:

- XF824A Panel Bus Relay Output Module (without manual overrides)
- XFR824A Panel Bus Relay Output Module (with manual overrides)
- XFL824A LONWORKS Bus Relay Output Module (without manual overrides)
- XFLR824A LONWORKS Bus Relay Output Module (with manual overrides)

They are installed with the XS824-25 Terminal Socket (incl. one connector bridge, one cross connector, and one swivel label).

Accessory disconnecter module: XS812-RO (see also Table 2 on page 4).

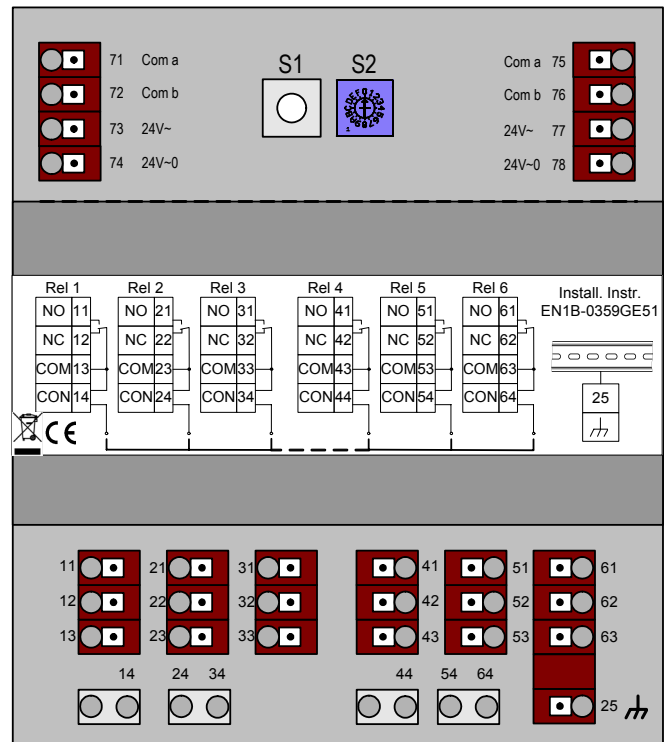

Fig. 17. Excel 800 Relay Output Modules (top view)

### Features

- Cross-Connector
- 1 yellow LED per output
- Optional versions with manual override switches (Auto, 0, 1; LED flashes in override mode)
- Feedback on manual override signal
- Configurable safety position for outputs in case of communications problems (remain, OFF, ON)
- Permissible Load per Relay Output Module (Total)
  - *Max. load:*
    - 19...250 Vac: 12 A
    - 1...24 Vdc: 12 A resistive, 3 A inductive
- Permissible Load per Normally-Open Contact:
  - *Max. load:*
    - 19...250 Vac: 4 A resistive or inductive
    - 1...24 Vdc: 4 A resistive, 1 A inductive
  - *Min. load:* P > 50 mW
- Permissible Load per Normally-Closed Contact:
  - *Max. load:*
    - 19...250 Vac: 2 A resistive, 1 A inductive
    - 1...24 Vdc: 2 A resistive, 1 A inductive
  - *Min. load:* P > 50 mW

## Floating Output Module

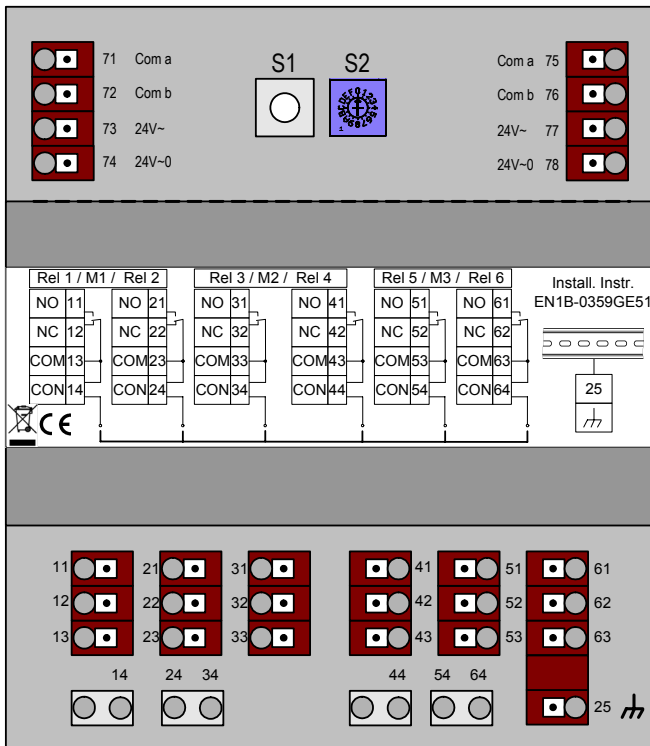

**Fig. 18. XFR825A Panel Bus Floating Output Module (shown with socket)**

The XFR825A Panel Bus Floating Output Module (with manual overrides), with 3 floating outputs, is installed with the XS824-25 Terminal Socket (incl. one connector bridge, one cross connector, and one swivel label).  
Accessory disconnecter module: XS812-RO (see also Table 2 on page 4).

### Features

- Cross-Connector
- 1 red LED (opening) and 1 green LED (closing) per floating output
- Manual override potentiometers (Auto, 0%...100%; LED flashes in override mode)
- Feedback on manual override signal
- Configurable safety position for outputs in case of communication problems (remain, 0%, 50%, 100%)
- Permissible Load per Floating Output Module (Total)
  - *Max. load:*
    - 19...250 Vac: 12 A
    - 1...24 Vdc: 12 A resistive, 3 A inductive
- Permissible Load per Normally-Open Contact:
  - *Max. load:*
    - 19...250 Vac: 4 A resistive or inductive
    - 1...24 Vdc: 4 A resistive, 1 A inductive
  - *Min. load:* P > 50 mW
- Permissible Load per Normally-Closed Contact:
  - *Max. load:*
    - 19...250 Vac: 2 A resistive, 1 A inductive
    - 1...24 Vdc: 2 A resistive, 1 A inductive
  - *Min. load:* P > 50 mW



**Fig. 19. XFR825A Panel Bus Floating Output Module (top view)**

## Environmental Specifications

### Ambient Temperature

Operation: 0...50 °C (32...122 °F)

Storage: -20...+70 °C (-4...+158 °F)

### Ambient Humidity (Operation and Storage)

5 to 93% r.h. non-condensing

**Table 4. Power consumption of XCL8010A**

devices powered	supply voltage	
	24 Vac	24 Vdc
XCL8010A*	190 mA	140 mA
watchdog load (terminal 4)	< 500 mA	< 500 mA
XF821A, XFL821A	130 mA	80 mA
XF822A, XFR822A	150 mA	90 mA
XFL822A, XFLR822A	160 mA	90 mA
XF823A, XFL823A	180 mA	130 mA
XF824A, XFR824A, XFR825A	140 mA	80 mA
XFL824A, XFLR824A	140 mA	90 mA

## Mechanical

### Housing dimensions (H x W x D)

The XCL8010A Controller Module has the dimensions:

110 X 144 X 93 mm (see also Fig. 20 on page 15).

The Excel 800 I/O Modules (mounted on Terminal Sockets) all have the dimensions: 110 X 90 X 93 mm (see also Fig. 21 on page 15).

### Housing Material

Plastic, flame-retardant

### Mounting Methods

DIN-rail mounting (e.g. in control cabinet).

### Calculated Lifetime of Weakest Components

MTBF  $\geq$  13.7 years

### Protection Class

IP 20

### Available Literature

- Mounting Instructions (EN1B-0359GE51);
- Installation Instructions (EN1B-0375GE51).

### Norms, Standards

The Excel 800 System conforms to EN 60730-1:2005-12 and EN 60730-2-9:2005-10.

Dimensions

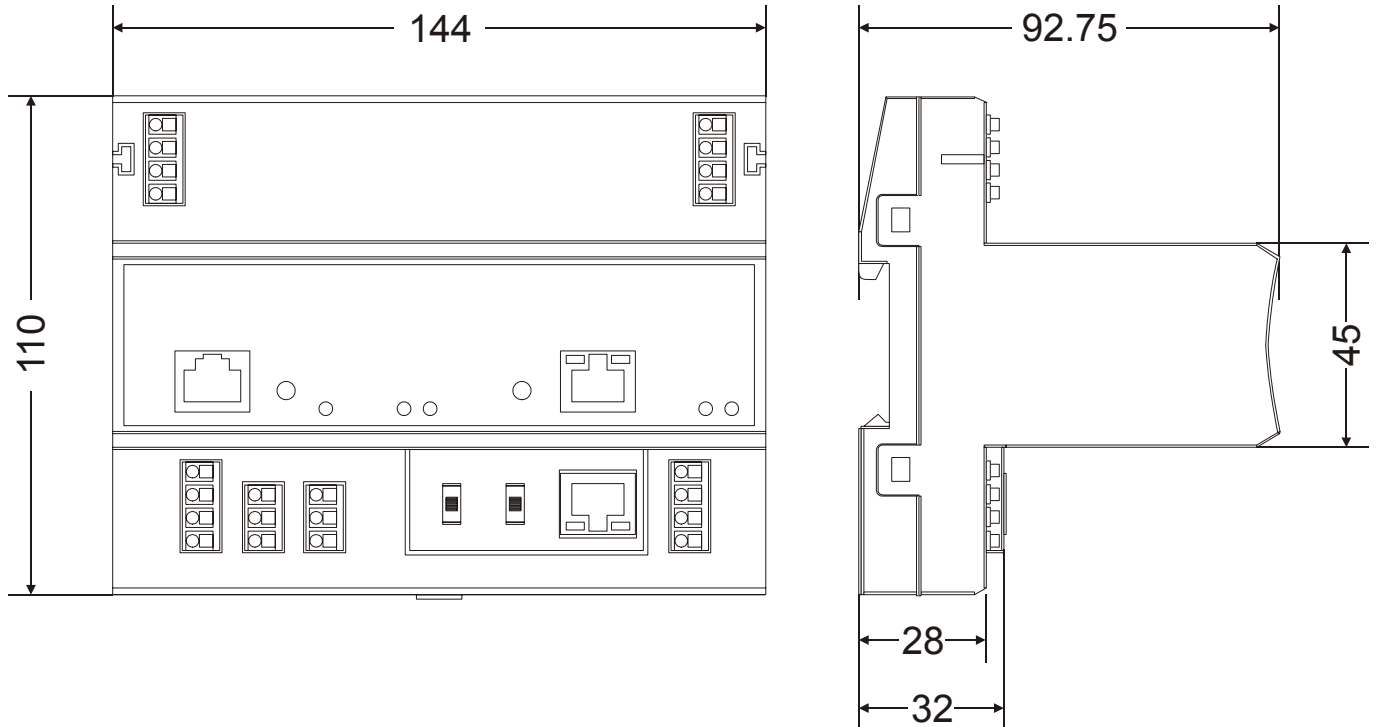

Fig. 20. XCL8010A Controller Module, outside dimensions (in mm)

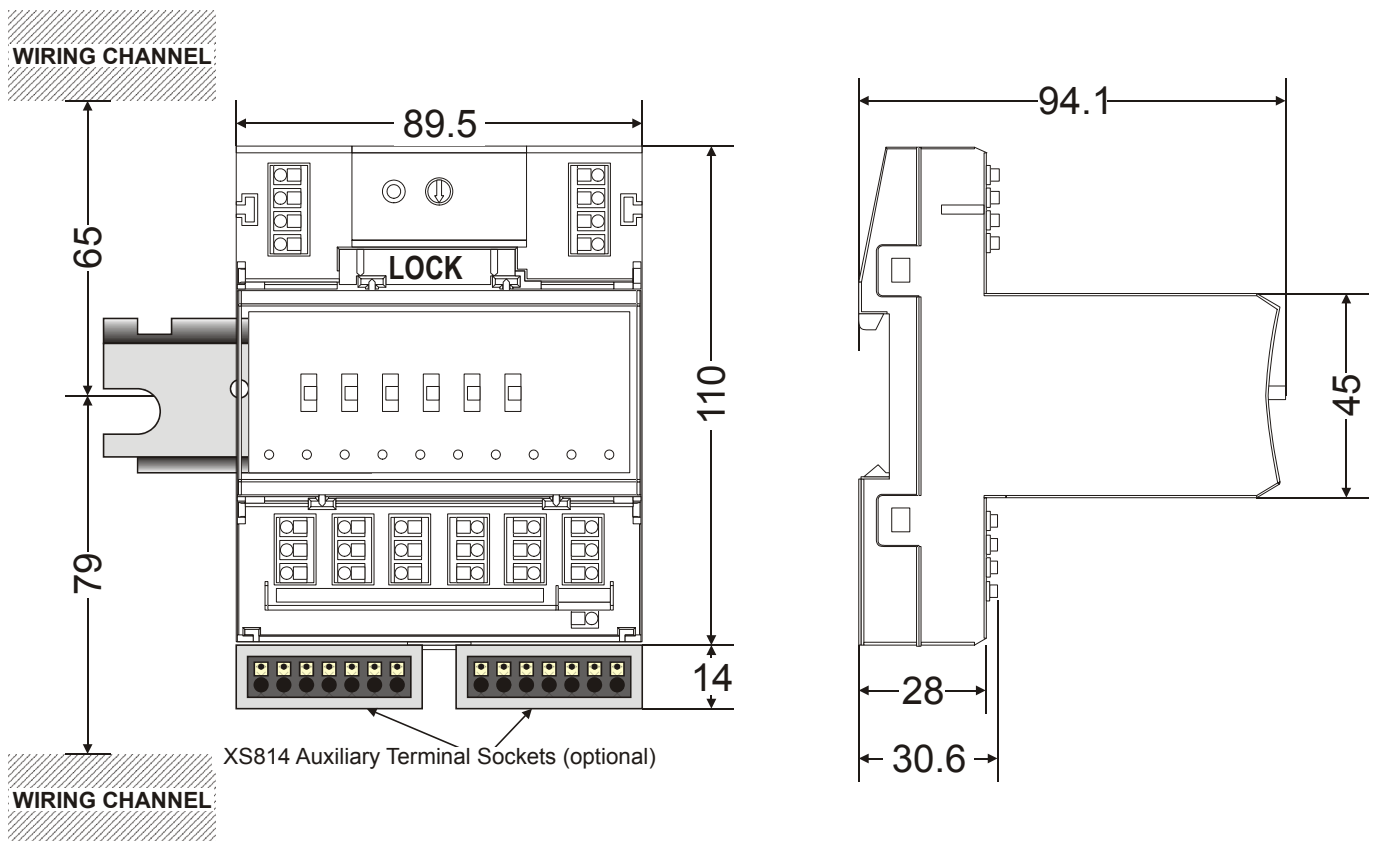

Fig. 21. Excel 800 I/O Modules (example shows Manual Overrides), incl. Terminal Socket, outside dimensions (in mm)

**Honeywell**

Manufactured for and on behalf of the Environmental and Combustion Controls Division of Honeywell Technologies Sàrl, Ecublens, Route du Bois 37, Switzerland by its Authorized Representative:

**Automation and Control Solutions**

Honeywell GmbH  
Böblinger Straße 17  
D-71101 Schönaich  
Germany

DIN EN ISO  
9001/14001

<http://www.honeywell.com>

ENOB-0564GE51 R0307

printed in Germany

Subject to change without notice