



# Transfer Printer BP-PR PLUS series

## Configuration Instructions

Edition 3/07

Information on the scope of delivery, appearance, performance, dimensions and weight reflect our knowledge at the time of printing. We reserve the right to make modifications.

All rights, including those regarding the translation, are reserved.

### Trademarks

**Centronics®** is a registered trademark of the Centronics Data Computer Corporation.

**Microsoft®** is a registered trademark of the Microsoft Corporation.

**Windows®, Windows 95®, Windows 98®, Windows 2000®, Windows NT®** and **Windows XP®** are registered trademarks of the Microsoft Corporation.

**True Type™** is a registered trademark of Apple Computer, Inc.

### Approval

The transfer printers comply with the following safety guidelines:

- CE** EC Low-Voltage Directive (73/23/EEC)
- EC Machine Directive (98/37/EC)
- EC Electromagnetic Compatibility Directive (89/336/EEC)

### United States

**Note:** This equipment has been tested and found to comply with the limits for a Class A digital device, pursuant to part 15 of the FCC Rules. These limits are designed to provide reasonable protection against harmful interference when the equipment is operated in a commercial environment. This equipment generates, uses, and can radiate radio frequency energy and, if not installed and used in accordance with the instruction manual, may cause harmful interference to radio communications. Operation of this equipment in a residential area is likely to cause harmful interference in which case the user will be required to correct the interference at his/her own expense. The user is cautioned that any changes or modifications not expressly approved by Brady could void the user's authority to use the equipment.

### Canada

This Class A digital apparatus meets all requirements of the Canadian Interference-Causing Equipment Regulations.

Cet appareil numérique de la classe A respecte toutes les exigences du Règlement sur le matériel brouilleur du Canada

### Europe

This is a Class A product. In a domestic environment this product may cause radio interference, in which case the user may be required to take adequate measures.



**W.H. Brady**  
Lindestraat 21  
Industriepark C3  
9240 Zele Belgium  
Tel.: +32 52 457 811  
e-mail: support@brady.be



**Identification Solutions Division**  
6555 W. Good Hope Road  
PO Box 2131  
Milwaukee, WI 53201 U.S.A.  
Phone: 1-800-537-8791 Fax: 1-800-292-2289

## Table of contents

<b>1</b>	<b>Product description</b> .....	<b>5</b>
1.1	Overview .....	5
1.2	Device types .....	5
1.3	Technical data .....	7
1.4	Parts of the printer .....	9
1.5	Accessories .....	10
1.6	Print media .....	11
1.7	Software .....	13
<b>2</b>	<b>Connecting printer to computer</b> .....	<b>14</b>
2.1	Connecting printer via serial RS-232 interface .....	14
2.2	Connecting printer via Ethernet interface .....	15
2.3	Connecting printer via USB interface .....	17
<b>3</b>	<b>Offline menu</b> .....	<b>18</b>
3.1	Structure of the offline menu .....	18
3.2	Navigating the offline menu .....	19
3.3	Service key .....	20
<b>4</b>	<b>Configuration</b> .....	<b>21</b>
4.1	Configuration via the operating panel .....	21
4.2	Configuration via the printer website .....	28
<b>5</b>	<b>Test functions</b> .....	<b>37</b>
5.1	Overview .....	37
5.2	Short status .....	38
5.3	Status print .....	38
5.4	Font list .....	41
5.5	Device list .....	42
5.6	ASCII Dump Mode .....	43
5.7	Test grid .....	44
5.8	Label profile .....	45
5.9	Event log .....	47
5.10	Print IFFS contents .....	48
<b>6</b>	<b>Service functions</b> .....	<b>49</b>
6.1	Performing firmware update .....	49
6.2	Clearing service counter .....	50
6.3	Adjusting label sensor .....	51
6.4	Save settings .....	52
6.5	Load settings .....	52
6.6	Changing OEM name .....	53
6.7	Cleaning interval .....	53
<b>7</b>	<b>FTP printer management</b> .....	<b>54</b>
7.1	FTP logon .....	54
7.2	Directory structure of the FTP server .....	55
7.3	FTP firmware update .....	55
<b>8</b>	<b>Memory cards</b> .....	<b>56</b>
8.1	Insertion and removal .....	56
8.2	Formatting .....	57
8.3	Writing .....	57
8.4	Memory card functions in the offline menu .....	58

<b>9</b>	<b>External keyboard</b> .....	<b>61</b>
9.1	Connecting external keyboard. ....	61
9.2	Special key functions. ....	61
9.3	Key assignment and special characters .....	61
	<b>Index</b> .....	<b>64</b>

# 1 Product description

## 1.1 Overview

The **BP-PR PLUS series** transfer printers can be operated in thermal direct or transfer print mode. With thermal printing, heat from the printhead results in printing to a heat-sensitive print medium. With thermal transfer printing, heat from the printhead causes the color layer of a transfer ribbon to be transferred to the print medium.

The printers are equipped with every common interface to ensure trouble-free connection to computers and networks.

When using a memory card, the printers can also operate in standalone mode. By connecting a keyboard, variable data can also be entered conveniently in standalone mode.

The printers can be connected to AC mains networks from 100 V to 240 V without any kind of adapter.

The large graphic LCD display and the context-controlled navigator pad allow the printers to be monitored and operated efficiently.

A variety of accessories allows the printers to be adapted to different product requirements.

## 1.2 Device types

The printers are available in a variety of models with different features.

### 1.2.1 Standard version

The standard version is used for printing labels or endless media on rolls or fanfolds.

In **Tear-off mode**, labels are removed by hand. Because there is no internal rewinder, automatic peeling off of the labels from the liner (peel-off mode) and internal rewinding are not possible.

The labels can be cut off automatically with the 'cutter' accessory. For details, see documentation of the cutter.

The labels can be wound up with the 'external rewinder' accessory. For details, see documentation of the external rewinder.

### 1.2.2 Peel-off version

The peel-off version is prepared for peel-off mode and thus has an internal rewinder and a pulling system comprised of a rewind assist roller and a locking system. Printing on labels or endless media from rolls or fanfolds is possible.

Operation in **Tear-off mode** and with the 'cutter' or 'external rewinder' accessory is possible by installing the tear-off plate (see "*Operating Instructions*"), as it is with the standard version.

In **peel-off mode**, the label is peeled off the liner after printing. The label can be removed by hand with the peel-off sensor (accessory). The liner is rolled up via the internal rewinder.

For use in **Internal Rewind mode**, remove the locking system and replace the dispense plate with a rewind guide plate. See "*Operating Instructions*".

### 1.2.3 Overview of types

Characteristics	BP-PR PLUS series		
Max. medium width in [mm]		120	
Print resolution [dpi]	203	300	600
Printing width in [mm]	104	105.6	105.6
Max. print speed in [mm/s]	250	250	100
Standard version transfer printer	BP-PR 200 PLUS	BP-PR 300 PLUS	BP-PR 600 PLUS
Peel-off version transfer printer	BP-PR 200 PLUS-P	BP-PR 300 PLUS-P	BP-PR 600 PLUS-P

**Tab. 1:** Overview of **BP-PR PLUS series** printer types

## 1.3 Technical data



These technical data specifications reflect the knowledge available at the time of printing. We reserve the right to make modifications.

■ Standard □ Option

		BP-PR 200 PLUS	BP-PR 300 PLUS	BP-PR 600 PLUS
<b>Printhead</b>				
Printing Method		Thermal direct / Thermal transfer		
Print Resolution		203 dpi	300 dpi	600 dpi
Print Speed max		250 mm/s	250 mm/s	100 mm/s
Print Width max.		104 mm	105,6 mm	105,6 mm
<b>Labels</b>				
Material - labels, continuous material		Thermal and standard paper, textiles <sup>1</sup> , plastic foil : PE, PP, PVC, PA, PI		
Material Thickness / Weight		0,07 - 0,35 mm / 60 - 250 g/m <sup>2</sup> (thicker material available on request)		
Materials		Polyimide : B-457, B-426, B-479 Polyester - white : B-422, B-423, B-488, B-489 Polyester - metallised : B-435, B-428 PermaSleeves : PS-250-2W Self-Laminating and DuraSleeves		
Media Roll	Total Diameter max	210 mm		
	Core Diameter	25.4 - 76 mm		
	Winding Direction	Inside or outside		
Width of the Liner with a Thickness 0,07-0,35 mm		25 - 120 mm		
with a Thickness 0,25-0,35 mm		10 - 120 mm		
Label Width		4 - 116 mm		
Label Width when dispensing <sup>1</sup> min.		25 mm		
Label Height		5 - 2000 mm	5 - 2000 mm	5 - 1000 mm
Label Height when dispensing <sup>1</sup> min.		12 mm		
<b>Ribbon</b>				
Ink		Inside or outside		
Roll Diameter max		80 mm		
Core Diameter		25 mm		
Ribbon Length max		500 m		
Width max		114 mm		
<b>Internal Rewind Unit</b>				
Total Diameter max		145 mm		
Core Diameter		38,1 mm		
Winding Direction		Outside only		
<b>Dimensions Printer</b>				
Height x Depth x Width		274 mm x 446 mm x 242 mm		
Weight		9 kg		
<b>Label sensor</b>				
Method		See through / Bottom-reflect		
Distance to the Paper Edge		5 - 53 mm		
<b>Electronics</b>				
Processor		High speed 32 Bit ColdFire 266 MHz		
RAM		64 MB		
ROM Flash		8 MB		
Slot for CompactFlash-Card Type I up to 1 GB		■		
Slot for PC-Card Type II		■		
Real Time Date / Clock		■		
<b>Operating Panel</b>				
Buttons illuminated, depending on mode of operation		Pause, Feed, Cancel, Menu, Enter, 4 x Cursor		
LCD Graphic Display		60 mm x 40 mm		
Text Lines / Characters		4 / ca. 20		
<b>Interfaces</b>				
Serial RS-232C, 1.200 up to 230.400 Baud/8 Bit		■		
USB 2.0 High Speed Slave for PC Connection		■		
Ethernet 10/100 Base T, LPD, RAW-IP, DHCP, HTTP, FTP, SMTP, SNMP, NTP		■		
Peripheral Connection		■		
USB Master for Keyboard and Scanner		2x ■		
<b>Accessories</b>				
Cutter		□		
Present Sensor PS8 - Manual Operation		□		
Present Sensor PS6 - Automatic Operation		□		
External Unwinder		□		
External Rewinder		□		
CompactFlash-Card Type I		□		
PC-Card Type II		□		

<sup>1)</sup> Depending on label size, material and adhesive limitations are possible. Critical material or applications have to be tested and cleared.

Tab. 2: Technical data

## Product description

BP-PR PLUS series	
<b>Settings</b>	
	Local setting (Arabic, CZ, D, DK, E, F, GB/USA, H, I, IL, N, NL, P, PL, RUS, S, SF, TR), Machine parameter, Print parameter, Interfaces, Security
<b>Monitoring</b>	
Stop printing if	Out of ribbon, Out of paper, Head open
<b>Test Routines</b>	
	System diagnosis of memory and print-head when switched on, short status, status print, font list, device list, label profile, test grid, monitor mode.
Status Reports	Extensive status print with information about instrument setting, for example print length counter, runtime counter. Request of the machine status via software command. Detailed status messages on the display, for example network error-no link, barcode error etc.
<b>Fonts</b>	
Font Types	5 Bitmap fonts incl. OCR-A, OCR-B and 3 Vector fonts Swiss 721, Swiss 721 Bold and Monospace 821 available internally, loadable TrueType fonts.
Character Sets	Windows 1250 up to 1257, DOS 437, 737, 775, 850, 852, 857, 862, 864, 866, 869, EBCDIC 500, ISO 8859-1 up to -10 and -13 up to -16, WinOEM 720, UTF-8, Macintosh Roman, DEC MCS, K018-R. All West and East European Latin, Cyrillic, Greek, Hebrew and Arabic characters are supported. Optional Chinese (simplified Chinese)
Bitmap Fonts	Size of width and height 1 - 3 mm zoom 2-10 Orientation 0°, 90°, 180°, 270°
Vector-/ TrueType Fonts	Size of width and height 0.9 - 128 mm variable zoom, Orientation 360° in steps of 1°
Font Formats	Bold, italic, underlined, outline, negative, grey, vertical, depending on character fonts
Font Width	Variable
<b>Graphics</b>	
Graphic Elements	Line, arrow, box, circle, ellipse, filled and filled with fading
Graphic Formats	PCX, IMG, BMP, TIF, MAC, GIF, PNG
<b>Codes</b>	
Linear Barcodes	Code 39, Code 93, Code 39 Full ASCII, Codabar, EAN 8, EAN 13, EAN/UCC 128, EAN/UPC App. 2, EAN/UPC App. 5, FIM, HIBC, Interleaved 2/5, Ident- und lead code of German Post AG, JAN 8, JAN 13, MSI, Plessey, Postnet, RSS 14, UPC A, UPC E, UPC E0
2D-Codes	Aztec, Codablock F, Data Matrix, PDF 417, Micro PDF 417, UPS Maxicode, QR-Code, RSS 14
	All codes variable in height, module width and ratio. Orientation 0°, 90°, 180°, 270°. Optionally with check digit, printed characters and Start/Stop code, depending on code type.

BP-PR PLUS series	
<b>Software</b>	
Windows Driver	98, ME, 2000, 2003, XP, NT from 4.0
abc Compiler	Basic compiler to run individual programs
Label Software	BradySoft, CodeSoft
<b>Operation Data</b>	
Power Supply	100 - 240 V~, 50 - 60 Hz, PFC
Energy Consumption	max. 250 W
Operation Temperature	10 - 35 °C
Humidity	30 - 85 % not condensing
Safety Regulations	CE, FCC Class A, CB, CCC

Accessories	
<b>Cutter CU4</b>	
Material Weight max	500 g/m <sup>2</sup>
Material Width max	120 mm
Material Height min	2 mm depending on material
<b>External Rewinder ER1 / ER4</b>	
Total Diameter	ER1 210 mm ER4 300 mm
Core Diameter	40 mm (with/without cardboard core) 76 mm (with cardboard core)
Material Width max	120 mm
Winding Speed max	300 mm/s
Winding Direction	Inside or outside
Power Supply	ER1 From printer ER4 With internal power supply
<b>External Unwinder EU4</b>	
Total Diameter	300 mm
Core Diameter	40 mm (with/without cardboard core) 76 mm (with cardboard core)
Material Width max	120 mm
Winding Direction	Inside or outside

Tab. 3: Technical data (continuation)



## 1.4 Parts of the printer

**i** The following illustrations show the important parts for the example using the printer with internal rewinder (peel-off version). The details of other printer versions may vary. Major differences are indicated in the following.

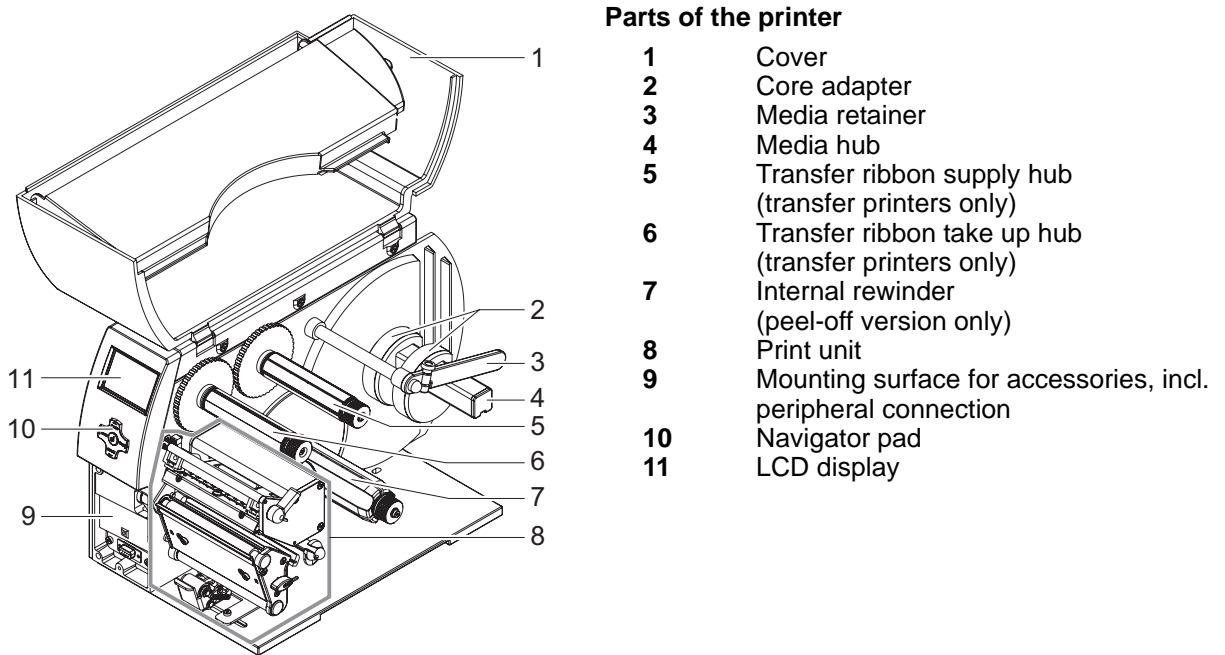

**Fig. 1:** General overview

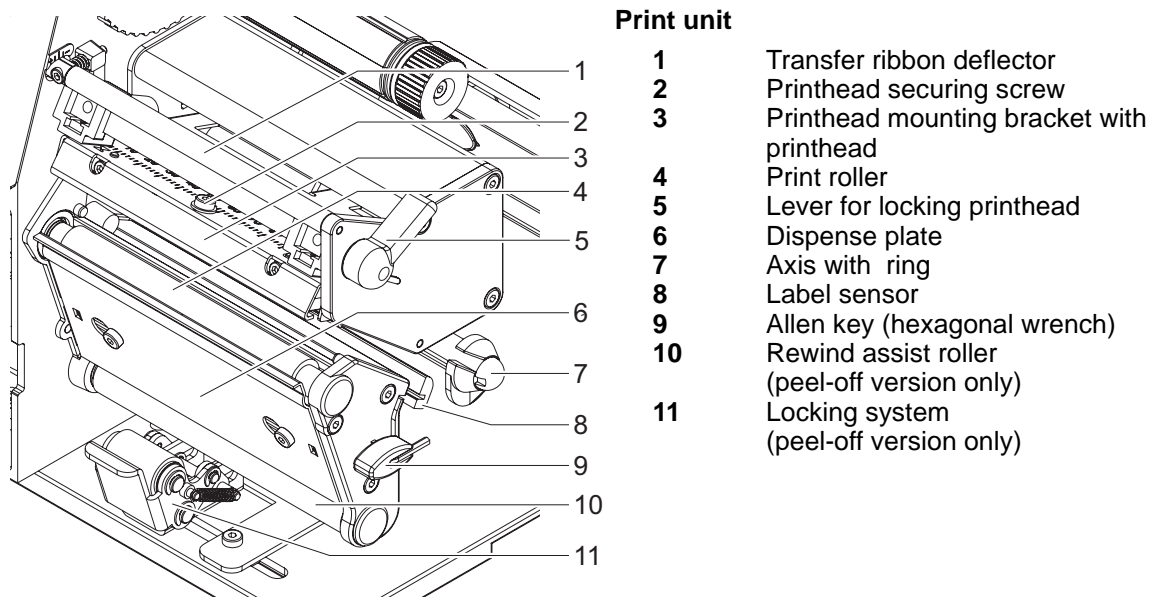

**Fig. 2:** Print unit for Tear-off mode

## **1.5 Accessories**

### **1.5.1 External unwinders and rewinders**

A variety of external unwinders and rewinders are available for large print jobs.

### **1.5.2 Cutter**

The cutter accessory cuts labels or endless media right after printing, after a certain number of labels or after the print job. The peripheral connection of the printer is used for power supply and printer control.

### **1.5.3 Peel-off modules**

#### **Peel-off sensor PS 8 for manual removal**

The sensor detects the label in peel-off position and interrupts the print job. Once the label is removed manually, the next label is printed immediately.

#### **Peel-off sensor PS 6 for manual removal and automatic mode**

Two operating modes are possible:

- Manual mode: dispensing after removal of the label without connecting the peripherals
- Semi-automatic mode: dispensing upon request from button, footswitch or external control

### **1.5.4 Memory cards**

With the following memory cards, the printer can be operated in standalone mode without being coupled with a computer:

- CompactFlash type 1 memory card (1 GB max.)
- Type II PC card

Label formats, fonts, texts and graphics on the computer or printer are loaded for this purpose.

### **1.5.5 External keyboards**

A compact keyboard or numerical keypad for entering alphanumerical or numerical data in standalone mode can be connected to the printer via a USB master interface (see "9.1" on Page 61).

## **1.6 Print media**

### **1.6.1 Printing methods and print media**

The printers of the **BP-PR PLUS series** can be operated both in thermal direct and in transfer mode.

#### **Thermal direct printing**

The label medium is coated with a thermoreactive material which responds by changing color when heated (e.g. from white to black). The thermal printhead generates the print image via pointwise heating of the label medium.

#### **Thermal transfer printing**

Pointwise heating by the printhead causes color particles from the color coating of a ribbon to be transferred to an uncoated label medium. The ribbon can only be used once for printing. A great variety of media, e.g. normal paper, cardboard and polyester film, are suitable for thermal transfer printing.

**!** The print quality essentially depends on how well the coloring from the transfer ribbon adheres to the label medium. Ask your dealer for advice when selecting labels and transfer ribbons. Run tests if necessary.

### 1.6.2 Label formats

Before ordering label media, note the following permissible dimensions:

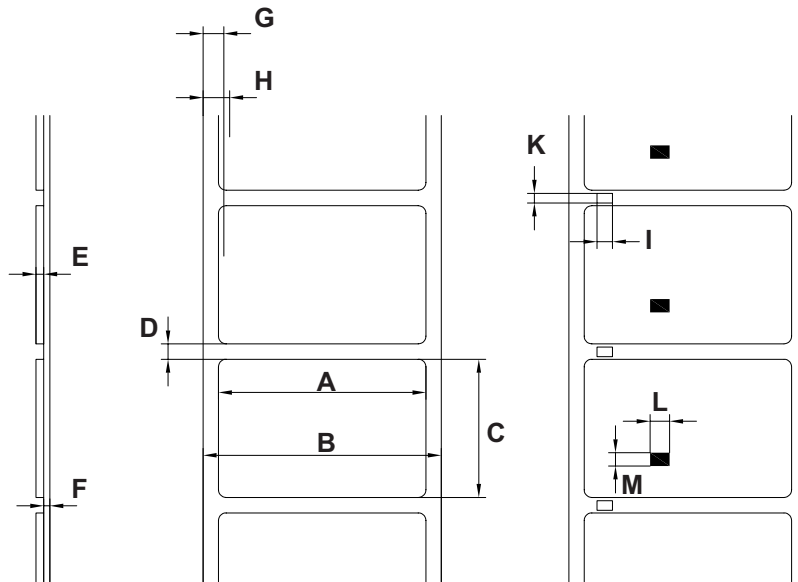

**Fig. 3:** Label dimensions

Dim.	Designation	Dimensions in [mm]
A	Label width	4–116
	Label width in peel-off mode	25–116
B	Width of liner or endless medium	
	With a medium thickness of E = 0.07 – 0.25	25–120
	With a medium thickness of E = 0.25 – 0.35	10–120
C	Label height	
	Minimum label height	5
	Minimum label height in peel-off mode	12
	Maximum label height with printhead 203 dpi	2000
	Maximum label height with printhead 300 dpi	2000
	Maximum label height with printhead 600 dpi	1000
D	Label gap	2–1000
E	Label thickness	0.07–0.35
F	Liner thickness	0.07–0.35
G	Distance from 1st heating point to edge of liner	2
H	Distance from label sensor to edge of liner	5–53
I	Width of perforation mark	>5
K	Height of perforation mark	2–10
L	Width of reflex mark	>5
M	Height of reflex mark	2–10

**Tab. 4:** Permissible label dimensions

### **1.6.3 Transfer ribbons**

Select transfer ribbons which are only a little wider than the labels:

- If a ribbon is too narrow, the printhead comes into contact with the labels → wear
- If a ribbon is too wide, there is a risk of wrinkling → print image errors

Detection of the transfer ribbon occurs via checking the rotation of the transfer ribbon supply hub. To print all labels up to the end of the transfer ribbon cleanly, the trailer tape may not be longer than 60 mm. It must be possible to easily remove the end of the transfer ribbon from the cardboard core.

## **1.7 Software**

You can use several methods to control the printer and create label layouts.

### **1.7.1 Direct programming**

The printer has an extensive command set for creating label layouts. With a text editor, the printer commands can be combined in a file. This label programming can then be sent to the printer via a data interface (e.g. via the DOS command COPY). The description of direct programming is found in the *“Programming Manual“*.

### **1.7.2 Windows printer driver**

You can obtain printer drives for various versions of Windows from your dealer or the internet. Using the printer driver, you can control the printer from almost any Windows application.

Functionality depends on the selected application. Use of the printer driver is explained in the online help.

### **1.7.3 Label software**

A variety of label programs which are adapted to the specific requirements of label printing are offered for convenient label layout designs. Many programs use the printer driver. Some programs already have their own driver for printers of the **BP-PR PLUS series**. These programs offer the greatest possible convenience when creating and printing labels.

## 2 Connecting printer to computer

You can choose from the following options for connecting a computer to the printer:

- Direct connection to the serial RS-232 interface (8) (see "2.1" on Page 14).
- Direct connection to the Ethernet interface (5) (see "2.2" on Page 15).
- Connection via a computer network to the Ethernet interface (5) (see "2.2" on Page 15).
- Direct connection to a high-speed USB slave interface (7) (see "2.3" on Page 17).

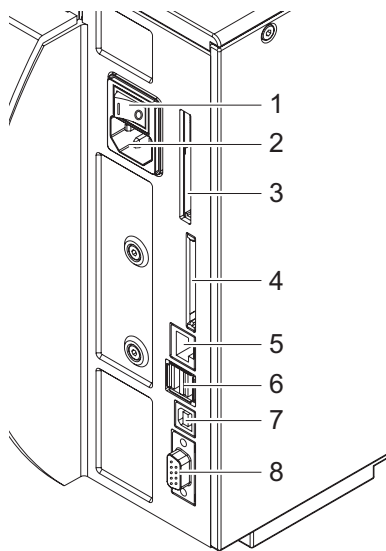

- |   |  |
|---|--|
| 1 | Power switch   |
| 2 | Power connection jack  |
| 3 | Slot for type II PC card                                       |
| 4 | Slot for a CompactFlash memory card                            |
| 5 | Ethernet 10/100 Base-T   |
| 6 | Two USB master interfaces for keyboard, scanner or service key |
| 7 | High-speed USB slave interface                                 |
| 8 | Serial RS-232 C interface                                      |

**Fig. 4:** Power and computer connections

**!** Insufficient or missing grounding can cause faults during operation. Ensure that all computers and connection cables connected to the printer are grounded.

### 2.1 Connecting printer via serial RS-232 interface

#### 2.1.1 Connecting printer

The RS-232 interface is operated via an RS-232 cable.

1. Connect computer and printer with a suitable cable.
2. Secure cable connections with the screws found at the plugs.
3. Configure the RS-232 interface of the printer to match the settings of the connected computer (see "4.1.4" on Page 25).

If problems occur, contact the computer manufacturer for interface assignments and note the pin assignment of the SUB-D jack described in Table 5 on Page 15.

## Connecting printer to computer

### 2.1.2 Pin assignment of connection jack of the RS-232 interface

On the back of the printer there is a 9-pin SUB-D jack for the serial RS-232 interface.

	Pin	Designation	Function
	1	CD	Carrier Detect
	2	TxD	Transmit Data
	3	RxD	Receive Data
	4	DTR	Data Terminal Ready (not connected)
	5	GND	Ground
	6	DSR	Data Set Ready (not connected)
	7	RTS	Request To Send
	8	CTS	Clear To Send
	9	RI	Ring Indication (not connected)

**Tab. 5:** Pin assignment of the 9-pin SUB-D jack

## 2.2 Connecting printer via Ethernet interface

To connect the printer to a network jack, you will require a patch cable with an RJ45 plug for 10 Base T or 100 Base T. For direct connection of the printer to the Ethernet card of a local computer, you will need an appropriate crossover cable.

**!** A shielded cable must be used to connect the printer to the network.

1. Connect computer and printer with a suitable cable.
2. Make basic settings for operation of the Ethernet interface (see "4.1.4" on Page 25).
3. Call up the printer website (see "4.2.1" on Page 28).
4. Open the "Setup" tab on the printer website.
5. Set the parameters described in Table 14 on Page 32 in the path **Setup > Interfaces > Ethernet**.
6. Click **Set** on the "Setup" tab.
7. Enter PIN and click **Confirm** (see "4.1.6" on Page 27).
8. Set up print service if necessary (see "2.2.1" on Page 16).
9. Adjust Windows printer setting (see "2.2.2" on Page 16).

**i** Do **not** change the settings of the "IP" and "Gateway" on the printer website, as otherwise the connection to the printer may be lost.

**Connecting printer to computer****2.2.1 Print services Raw-IP and LPD in MS Windows**

The print services Raw-IP and LPD are not available in all operating systems. In general, special tools are required to set up print services. Information on this can be obtained from your dealer.

Print service	Windows 98/ME	Windows 2000	Windows NT 4.0	Windows XP
Raw-IP	Not available	Not available	Not available	Available
LPD	Not available	Available, but not installed	Available, but not installed	Available

**Tab. 6:** Availability of print services Raw-IP and LPD in Windows

Windows 2000 offers the port monitor SPM (Standard Port Monitor) which is installed automatically when setting up the TCP/IP protocol. The SPM can be configured for Raw-IP or LPD.

Information on installation can be obtained from the Windows documentation.

During the installation of both print services, additional connections for print output are set up:

⇒ Raw-IP: Enter the same port address in the printer which you have selected during installation.

⇒ LPD: "lp" (line printer) must be entered as the name of the printer on the computer (queue name).

**2.2.2 Adjusting Windows printer setting**

If the printer driver valid for your Windows version is installed on your computer, you can use the Windows standard applications to edit the label contents and to start the print jobs. To use the Raw-IP or LPD print services, you must adjust the Windows printersettings:

1. Open the folder containing the printers via Start > Settings > Printers.
2. Right-click the icon of the printer.  
A pop-up menu appears.
3. Select "Properties" in the pop-up menu.
4. Open the "Details" or "Connections" tab.  
This tab contains, among other things, the connections which were also set up when the print services were installed. The names of these connections depend on the installation tool used.
5. Select the Raw-IP or LPD connection.
6. Click **OK**.



## Connecting printer to computer

### 2.3 Connecting printer via USB interface

The high-speed USB interface allows the printer to be operated via a USB interface of a computer running the operating system Windows 98, Windows ME, Windows 2000 or Windows XP.



Windows 95 and Windows NT 4.0 do not support USB interfaces.























A printer driver must be installed if a USB interface will be used for connection. .









1. Switch printer off.
2. Connect computer and printer with an A-B cable.
3. Switch computer on.
4. Place the CD-ROM with the Windows driver in the CD-ROM drive.
5. Exit all programs currently running.
6. Switch printer on.  
The Windows Installation Wizard is started automatically.
7. Follow the on-screen instructions. The source of the installation file is "D:\WINDRV\9X2000XP", where D is the letter of the CD-ROM drive used.
8. If the "Has Not Passed Windows Logo Testing" error message appears during installation, continue with the installation anyway.  
After successful installation, an icon for the printer appears in the Windows "Printer" system folder.
9. Click icon in "Printer" system folder and make printer settings if necessary.

## 3 Offline menu

### 3.1 Structure of the offline menu

The offline menu contains setting options on several levels for configuring the printer to meet your needs. In addition, the offline menu features test functions for supporting the configuration or checking the function of the printer. Using status functions, the set parameters can be displayed or printed.

1st menu level	2nd menu level	Access
 <b>Memory card</b>	 <b>Label from card</b>	Only with memory card inserted
	 <b>Print directory</b>	Only with memory card inserted
	 <b>Copy memory card</b>	Only with memory card inserted, PIN protection possible
	 <b>Format card</b>	Only with memory card inserted, PIN protection possible
	 <b>ASCII dump (Card)</b>	Only with memory card inserted
 <b>Short status</b>		
 <b>Test</b>	 <b>Status print</b>	
	 <b>Font list</b>	
	 <b>Device list</b>	
	 <b>ASCII Dump Mode</b>	
	 <b>Test grid</b>	
	 <b>Label profile</b>	
	 <b>Event log</b>	Only with service key inserted
	 <b>Setup</b>	 <b>Local settings</b>
 <b>Machine param.</b>		
 <b>Print param.</b>		
 <b>Interfaces</b>		
 <b>Status line</b>		
 <b>Security</b>		

1st menu level	2nd menu level	Access
 <b>Service</b>	 <b>Firmware upd.</b>	PIN protection possible
	 <b>Firmw. fr. card</b>	PIN protection possible
	 <b>Clr. service ctr.</b>	Only with service key inserted
	 <b>Adj. gap sensor</b>	Only with service key inserted
	 <b>Save settings</b>	Only with memory card inserted, PIN protection possible
	 <b>Load settings</b>	Only with memory card inserted, PIN protection possible
	 <b>OEM Name</b>	Only with service key inserted
	 <b>Cleaning interval</b>	Only with service key inserted

Tab. 7: Menu structure

## 3.2 Navigating the offline menu

You can control all settings and functions in the offline menu with the navigator pad.

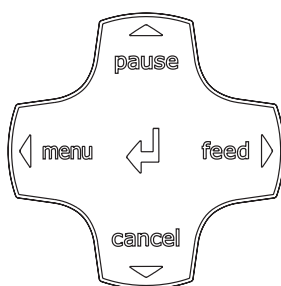

Fig. 5: Navigator pad

- ⇒ Press the **menu** button to switch from **Ready** mode to the offline menu.
- ⇒ Press the ► or ◀ button to select menu items on a menu level or to select values on the parameter level.
- ⇒ Press the ◀ button on the top menu level several times, if necessary, to switch from the offline menu to **Ready** mode.
- ⇒ Press the ▲ or ▼ button to reach a higher or lower menu level or to set values on the parameter level.
- ⇒ Press the ↵ button briefly to enable value selection on the parameter level, accept a selected value or start a function.
- ⇒ Press and hold (> 2 sec.) the ↵ button to exit the parameter level without accepting the parameter setting.



You can also make all settings in the offline menu via the Ethernet interface (see "4.2" on Page 28) or via direct control commands (see "Programming Manual").

### 3.3 Service key

A service key is required for accessing special service functions not accessible to the operator. This key switches the printer to service mode and enables:

- Access to additional configuration parameters
- Adjustment of the label sensor
- Resetting of the service counter
- Additional information in the status print and in the device list
- Printout of an event list
- Changing of the device name
- Saving and loading of configuration settings
- Access to PIN-protected configuration parameters and functions without entering the PIN
- Access to configuration parameters for optional assemblies, even if they are not currently installed

#### Using the service key



#### CAUTION!

**Incorrect settings and data loss via unauthorized access.**

**Access protection is deactivated when the service key is inserted. Operation of the printer by unauthorized persons can lead to incorrect settings and data loss in this case.**

⇒ **Provide the service key to authorized persons only.**

⇒ **Remove service key after service work and store it in a secure location.**

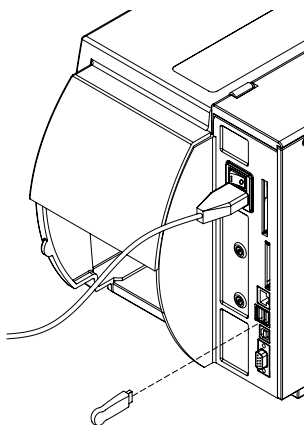

⇒ Insert service key into a USB master interface on the back of the printer.

You can also insert the service key while the device is switched on.

**Fig. 6:** Inserting the service key



Contact your dealer for information on how to obtain the service key.

#### Indication in this document

In this document, parameters and functions which are only accessible when the service key is inserted are indicated using the following note:

 Access only when service key is inserted!

## 4 Configuration





### 4.1 Configuration via the operating panel

A host of parameters for configuring the printer are found in the **Setup** menu of the offline menu. Your printer is mainly configured via the operating panel during initial commissioning and when making major changes to the operational conditions. Changes required for processing different print jobs can be implemented via software settings.

You can protect the **Setup** menu from unauthorized access via a code number (PIN).

#### 4.1.1 Local settings

1. Press the **menu** button.
2. Select **Setup > Local settings**.













Parameter	Meaning	Default
<b>Country</b> 	Setting the display language and the country-specific date and time formats. You can also overwrite the time formats via software. The changes are not saved permanently, however.	<b>USA</b>
<b>Timezone</b> 	Adaptation of the time display of the printer to the time zone in relation to UTC (Universal Time Coordinated).	<b>UTC + 1</b>
<b>Daylight saving</b> 	Selection of the daylight saving regulation applicable for the region. The time is then changed automatically.	<b>EU</b>
<b>Set date</b> 	Setting of the system date in the format DD.MM.YYYY (DD: day, MM: month, YYYY: year). The print output of the date occurs in the format set via the "Country" parameter. You can also change the date via software. The change is not saved permanently, however.	–
<b>Set time</b> 	Setting the system time in the HH:MM:SS format. When changing the time, ensure that the <b>Timezone</b> , <b>Daylight saving</b> and <b>Set date</b> parameters are set correctly. The time can also be synchronized automatically via the internet using the Ethernet interface. The print output of the time occurs in the format set via the "Country" parameter. You can also change the time via software. The change is not saved permanently, however.	–

**Tab. 8:** Parameters of the menu **Setup > Local settings**

## Configuration

### 4.1.2 Device settings

1. Press the **menu** button.
2. Select **Setup > Machine param..**







Parameter	Meaning	Default
<b>Printhead pos. X</b> 	Shifting of the entire print image perpendicular to the direction of paper flow. The absolute shifting of the print image perpendicular to the direction of paper flow is limited to the difference between the label width and the printhead width set in the software. You can also set the <b>Printhead pos. X</b> via software. The offset values from the <b>Machine param.</b> menu and the software are added together.	<b>0.0 mm</b>
<b>Printhead pos. Y</b> 	Shifting of the entire print image in the direction of paper flow. With positive values, printing begins later in the direction of paper flow. Shifting of the print image in the direction of paper flow also influences the peel and cutting positions. ⇒ Correct the <b>Peel position</b> and <b>Cut position</b> parameters by the same value in the opposite direction. You can also set the <b>Printhead pos. Y</b> via software. The offset values from the <b>Machine param.</b> menu and the software are added together.	<b>0.0 mm</b>
<b>Tear-off pos.</b> 	Shifting of the tear-off position in the direction of paper flow. With positive values, the label strip is transported farther out of the printer.	<b>0.0 mm</b>
<b>Demand sensor</b> 	Configuration of the optional peel-off module. See documentation of the peel-off module.  If peel-off module is not connected, access only granted with service key inserted!	
<b>Cutter</b> 	Configuration of the optional cutter. See documentation of the cutter.  If cutter is not connected, access only granted with service key inserted!	
<b>Applicator</b> 	Configuration of the optional applicator. See documentation of the applicator.  If applicator is not connected, access only granted with service key inserted!	
<b>Brightn. LCD</b> 	Brightness of the LCD display from 1 to 10	<b>10</b>
<b>Contrast LCD</b> 	Contrast of the LCD display from 4 to 8.	<b>6</b>
<b>Time Powersave.</b> 	Time between the last operation and the activation of Powersave mode.	<b>5 min.</b>
<b>Debug mode</b> 	Operating mode which supports the firmware programmer when localizing errors.	<b>Off</b>

**Tab. 9:** Parameters of the menu **Setup > Machine param.**







## Configuration

### 4.1.3 Printing parameters

1. Press the **menu** button.
2. Select **Setup > Print param..**

Parameter	Meaning	Default
<b>Heat level</b> 	<p>Heating value for compensating for the differing thermal behavior of print-heads. Changing this value is then especially necessary if the printing intensity has changed after replacing the printhead.</p> <p>To adapt the printing intensity when using different media, print speeds or printing contents, you should change the heat level in the software. The settings from the <b>Print param.</b> menu and the software are added together. The heat level setting also affects the test printouts.</p>	0
<b>Print speed</b> 	<p>Basic print speed setting.</p> <p>You can re-specify the print speed for each print job via software. The basic setting is not changed by this.</p> <p>The print speed setting also affects the test printouts.</p>	100 mm/s
<b>Transfer print</b> 	<p><b>On</b> for thermal transfer printing: Sensor for monitoring the transfer ribbon is activated.</p> <p><b>Off</b> for thermal direct printing: Sensor for monitoring the transfer ribbon is not activated.</p> <p>You can overwrite the setting for each print job via software.</p>	On
<b>Warn level ribbon</b> 	<p>Warning via the Ethernet interface by way of an SNMP message or e-mail sent when the remaining diameter of the ribbon supply roll undershoots the set value (32–74 mm).</p>	Off
<b>Label sensor</b> 	<p>Method for detecting the starting end of the label.</p> <p><b>Gap sensor:</b> Detection using changes in the transparency between the label and label gap.</p> <p><b>Bottom-Reflect:</b> Detection using reflex marks on the bottom of the medium.</p> <p><b>Continuous media:</b> Synchronization of the paper flow when using endless media in cutting mode. More detailed information is found in the documentation of the cutter.</p>	Gap Sensor
<b>Tear-off mode</b> 	<p>Positioning the label medium for tearing off at the tear-off plate.</p> <p><b>On:</b> Additional advancement of the label medium which positions the label gap after the last printed label at the dispense plate.</p> <p><b>Off:</b> Label advance stops once the last label has fully passed the print line.</p>	Off
<b>Backfeed</b> 	<p>Method for backfeeding the label medium.</p> <p>Backfeeding is necessary in the cutting and peel-off modes since a label is pushed out passed the front edge of the next label above the print line when peeling off/cutting.</p> <p><b>always:</b> Backfeeding occurs independently of label contents.</p> <p><b>smart:</b> Backfeeding only occurs when the next label is not yet fully prepared when peeling off/cutting the current label. Otherwise, the second label is pushed on and completed after removal of the first label without backfeeding.</p>	smart

## Configuration

Parameter	Meaning	Default
<b>Error-Reprint</b> 	<b>On:</b> With a correctable error and corresponding troubleshooting, the label being printed when the error occurs is repeated. <b>Off:</b> Print job is continued with the next label.	<b>On</b>
<b>Pause reprint</b> 	Printing of another label with the information of the previous print job by pressing the <b>pause</b> button. This function can be executed until the print buffer is cleared with the <b>cancel</b> button.	<b>Off</b>
<b>Protocol error</b> 	<b>On:</b> Printer switches to Error mode when unknown or faulty data is received. <b>Off:</b> When working with older computer operating systems, it is possible that the print spooler of the operating system will reply to the printer with normal status messages of the printer (e.g. end of paper) in the form of ASCII text. The printer cannot interpret this data and outputs a large number of protocol errors. In this case, it is advantageous if you set the <b>Protocol error</b> parameter to <b>off</b> . <b>Caution:</b> If the <b>Protocol error</b> parameter is set to <b>Off</b> , protocol errors which can be traced back to faulty programming are also ignored. There is a risk of data loss.  Access only when service key is inserted!	<b>On</b>
<b>Barcode error</b> 	<b>On:</b> With faulty barcode contents or size specifications, printing is interrupted. <b>Off:</b> Printing is not interrupted if an error occurs. If barcode contents are faulty, the printer attempts to replace the incorrect data with valid characters (e.g. zeros). If barcode size specifications are faulty, a gray area is printed instead of the barcode.	<b>On</b>
<b>Width ASCII dump</b> 	Width of the printing area in the "Monitor mode" test function (see "5.6" on Page 43). With the <b>Automatic</b> setting, the printout of the control sequences arriving at the printer occurs over the maximum printing width. You can reduce the printing area width down to 50 mm.	<b>Automatic</b>













Tab. 10: Parameters of the menu **Setup > Print param.**









## Configuration

### 4.1.4 Interfaces

1. Press the **menu** button.
2. Select **Setup > Interfaces**.

Parameter	Meaning	Default
<b>Default card slot</b> 	Definition of the primary card slot. Select one of the card slots on the back of the printer with <b>CompactFlash</b> or <b>PC-Card</b> or the card slot in the external operating panel with <b>Ext. CompactFlash</b> .	<b>Compact-Flash</b>
<b>Character set</b> 65 	<p>Selection of the character set table for adaptation to the computer system used.</p> <p>Switching the character set via software is not possible. You can access characters not available in the selected character set, however, using the Unicode table.</p>	<b>Windows 1252</b>
<b>RS232</b> 	Interface parameters <b>Baud rate</b> and <b>Handshake</b> for data transfer via the serial RS-232 interface.	<b>57600 RTS/CTS</b>
<b>RS-422/485</b> 	<p>Configuration of the optional serial RS-422 or RS-485 interface. See documentation of the serial interface.</p> <p> If interface is not installed, access only granted with service key inserted!</p>	
<b>IEEE 1284</b> 	<p>Configuration of the optional parallel interface. See the documentation of the parallel interface.</p> <p> If interface is not installed, access only granted with service key inserted!</p>	
<b>Ethernet</b> 	<p>Configuration parameters of the Ethernet interface card.</p> <p>You can access additional configuration parameters for the Ethernet interface card via the printer website (see "Setup tab" on Page 31).</p>	
<b>&gt; DHCP</b> 	<p>Method of issuing IP address</p> <p><b>On</b>: Dynamic issuing of IP address by the DHCP server</p> <p><b>Off</b>: Direct issuing of the IP address by the operator</p>	<b>On</b>
<b>&gt; IP</b> 	IP address of the printer. Only valid with <b>DHCP = Off</b> .	
<b>&gt; Mask</b> 	Subnet mask (classification and address range) of the local network. Only valid with <b>DHCP = Off</b> .	
<b>&gt; Gateway</b> 	Connection address between the local network and other networks. The IP address of the computer (router) on the network through which the connection can be established is used for this. The address of the router can also be issued via DHCP.	<b>Off</b>
<b>&gt; Network error</b> 	Printer switches to Error mode when problems with the network connection occur.	<b>Off</b>

## Configuration









Parameter	Meaning	Default
<b>Keyboard</b> 	Setting of the keyboard layout when using an external keyboard.  If keyboard is not connected, access only granted with service key inserted!	
> <b>Layout</b> 	Country setting of the keyboard layout. With the <b>Automatic</b> setting, the setting from the menu <b>Local settings &gt; Country</b> is used.  If keyboard is not connected, access only granted with service key inserted!	<b>Automatic</b>
> <b>NumLock</b> 	Activation or deactivation of the numerical keypad on the keyboard.  If keyboard is not connected, access only granted with service key inserted!	<b>On</b>

Tab. 11: Parameters of the menu **Setup > Interfaces**



### 4.1.5 Status line

Select the parameters to be displayed in **Ready** mode.

1. Press the **menu** button.
2. Select **Setup > Status line** menu.

Parameter	Meaning	Default
<b>Clock</b> 	Displays the current time.	<b>On</b>
<b>Date sheet</b> 	Displays the current calendar day.	<b>On</b>
<b>Ribbon supply</b> 	Displays the current ribbon supply in the form of a horizontal bar.	<b>Off</b>
<b>Wi-Fi signal strength</b> 	Displays the current strength of the electromagnetic field with a WLAN connection.	<b>Off</b>
<b>Ethernet link status</b> 	Displays the Ethernet status.	<b>Off</b>
<b>Temperature</b> 	Displays the current printhead temperature.	<b>Off</b>
<b>PPP funds</b> 	Displays the current "Pay Per Print" funds in the form of a horizontal bar. "Pay Per Print" is a method of paying for printer leasing by buying consumables.	<b>Off</b>
<b>Used memory</b> 	Displays the current memory used in the form of a vertical bar.	<b>Off</b>

**Configuration**

Parameter	Meaning	Default
<b>Input buffer</b> 	Displays the current input buffer used in the form of a vertical bar.	<b>Off</b>
<b>Card access</b> 	Icon displayed while an installed memory card is being accessed.	<b>On</b>
<b>Data transfer</b> 	Displays the current data transfer in the form of a falling drop.	<b>On</b>

**Tab. 12:** Parameters of the menu **Setup > Status line**

#### 4.1.6 Security

##### Activating a PIN

By activating a PIN, you can protect the **Setup** menu, certain memory card functions and the firmware update from unauthorized access.

The protected menu items are then marked with the  symbol and are only accessible after the PIN is entered.

1. Press the **menu** button.
2. Select **Setup > Security > Security** menu.
3. Select the value **on** with the **▶** and **◀** buttons
4. Accept the setting with the **↵** button.

##### Defining a PIN

1. Press the **menu** button.
2. Select **Setup > Security > PIN** menu.
3. Select the digit of the PIN to be changed with the **▶** and **◀** buttons.
4. Assign the selected digit a number with the **▲** and **▼** buttons.
5. Repeat these two steps for the remaining digits of the PIN.
6. Accept the setting with the **↵** button.

## 4.2 Configuration via the printer website

The parameters accessible via the operating panel can also be set via the website contained in the firmware of the printer. In addition, other parameters for the Ethernet interface are accessible there.

You can access the printer website with a Java-capable browser (e.g. Microsoft Internet Explorer, Netscape Navigator) via the Ethernet interface. Use of the Java applets requires at least version 1.4.2 of Java.

### 4.2.1 Calling up the printer website

! It is absolutely necessary to define a PIN in order to make settings via the printer website. You are requested to enter this PIN whenever settings are changed via the website. The initial setting of the PIN can be made via the operating panel of the printer (see "4.1.6" on Page 27) or via the printer website (see "Setup tab" on Page 31).

1. Start the browser.
2. Call up printer website by entering the IP address via HTTP (e.g. <http://192.168.100.208>).  
The "Status" tab is open on the home screen.
3. Check to see if the status "Ready" is displayed.

### 4.2.2 Description of the printer website

The printer website contains the following tabs:

- Status: general status description. See "Status tab" on Page 29.
- Setup: configuration parameter settings. See "Setup tab" on Page 31.
- System messages: automatic sending of messages via e-mail. See "System messages tab" on Page 33.
- Printer status line: printer status line layout. See "Printer status line tab" on Page 34.
- Fonts: overview of the available fonts. See "Fonts tab" on Page 35.
- Devices: list of the hardware and optional components. See "Devices tab" on Page 36.
- Help: online help. See "Help tab" on Page 36.

## Configuration

### Status tab

**BP-PR 200 PLUS ()**  
 Firmware V3.04 (Jul 27 2006)  
 Bootloader V1.14 (Jul 24 2006)

Temperature 83 °F (CPU 112 °F)      Heat voltage 23.7 V  
 Operative time 457h 30min      Number of labels 615  
 Thermal transfer 15.914m      Thermal direct 15.492m

**Printer info** Error

Date/Time	Description
08-09-2006/02:43:26 pm	Out of paper
08-09-2006/02:43:04 pm	Head open
08-09-2006/02:41:09 pm	+Memory card PC Card 0 KByte
08-09-2006/02:41:09 pm	+Memory card CompactFlash 31168 KByte
08-09-2006/02:41:06 pm	Ready

Buttons: Display, Reset, Print, Update

**Fig. 7:** "Status" tab on the printer website

The following information is contained in the top section of the "Status" tab:

- Printer type
- Firmware version
- Bootloader version
- Printhead temperature and temperature of CPU
- Heat voltage for the printhead.  
The heat voltage is only active during printing. Otherwise, 0.0 V is displayed.
- Operative time of the printer
- Number of labels printed since commissioning
- Previously printed paper length with thermal transfer printing
- Previously printed paper length with thermal direct printing
- Printer status: "Ready", "Printing label", "Settings" or "Error"

**i** Information is not updated automatically while the "Status" tab is open. Updating occurs when the tab is changed or by clicking the **Update** button.

A list of the events which have occurred since the printer was switched on are found in the bottom section of the tab. No more than the last eight events are displayed.

The "Ready" event provides information on when the printer was switched on.

The buttons on the bottom line of the "Status" tab have the following functions:

**Configuration**

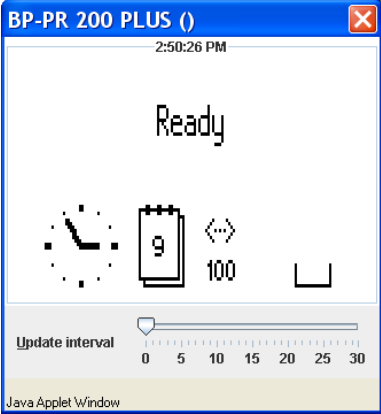
Button	Function
Display	<p>Opens a window which shows the current printer display.</p>  <p>You can set the update interval on the scale below the display. The display is not updated automatically with the "0" setting.</p>
Reset	Sends a soft reset signal to the printer.
Print	Opens the window for the settings of a local printer or network printer to be used to print the contents of the "Status" tab.
Update	Updates the display on the "Status" tab.

**Tab. 13:** Buttons on the "Status" tab

## Configuration

### Setup tab

On the "Setup" tab, you can set all the configuration parameters which are also accessible via the operating panel in the **Setup** menu. In addition, other parameters for the Ethernet interface can be set (see below).

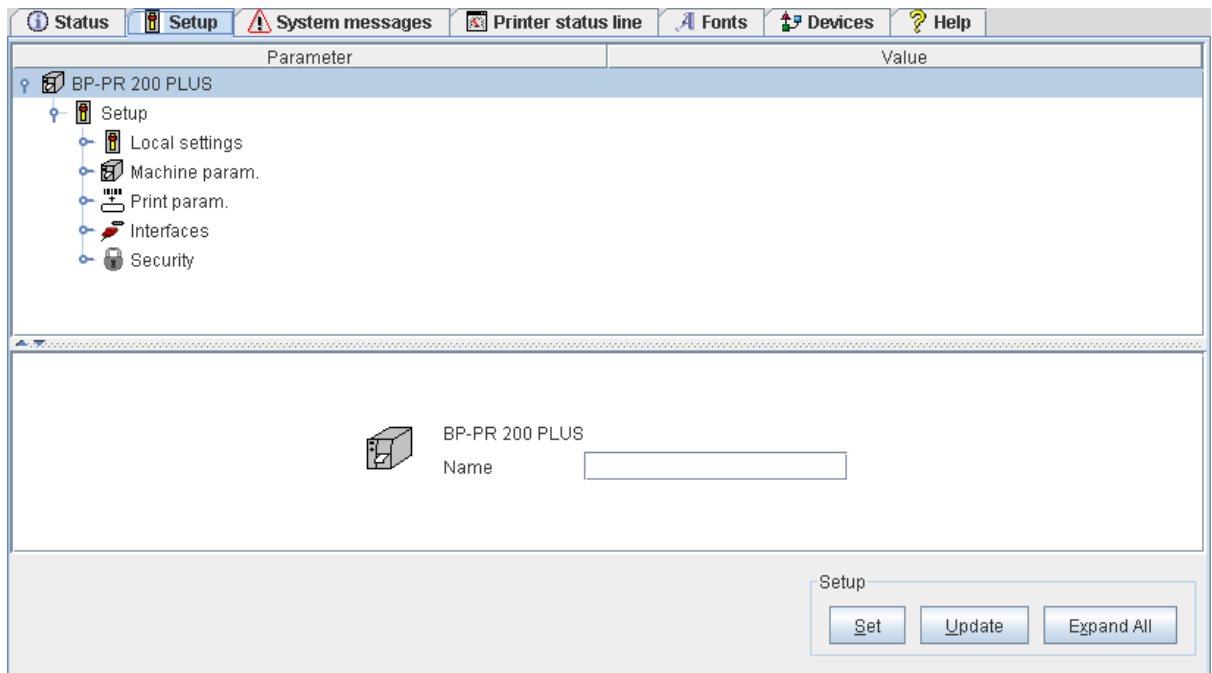

**Fig. 8:** "Setup" tab on the printer website.

The menus and parameters are arranged in a tree structure in the top section of the tab. The tree structure can be expanded in different ways:

- ⇒ Click circular symbol in front of the menu symbol once.  
The corresponding menu is expanded.
- ⇒ Double-click menu symbol or menu name.  
The corresponding menu is expanded
- ⇒ Click the **Expand All** button.  
The tree structure is fully expanded.

To change a parameter:

1. Locate parameter in the tree structure.
2. Click parameter name or the symbol next to it.
3. Enter value of the parameter in the input field in the bottom section of the tab.
4. Click **Set**.
5. Enter PIN and click **OK**.

The printer can be given a name on the top line of the tree structure. This name does not have a functional meaning. Its sole purpose is to allow the operator to more easily differentiate between the printers on a network.

**i** Information is not updated automatically while the "Setup" tab is open. Updating occurs when the tab is changed or by clicking the **Update** button.

**Configuration**

The following parameters for the Ethernet interface can only be accessed via the printer website:

<b>Parameter</b>	<b>Meaning</b>	<b>Default</b>
SMTP server	E-mails can be sent to selected addresses when certain status and error messages are generated. To activate: ⇒ Set parameter to "On". ⇒ Enter IP address of the SMTP server. ⇒ Enter a valid e-mail address for the printer in the "From address" field. More detailed information on sending e-mails is found in "System messages tab" on Page 33.	Off
Raw-IP port	Service for printing on the network (see "2.2.1" on Page 16). ⇒ Select a predefined port address.	9100
LPD	Activation of the network printing service LPD (see "2.2.1" on Page 16): ⇒ Set parameter to "On". ⇒ Enter "lp" as the queue name.	Off
SNMP	Data exchange between printer and management station via SNMP (Simple Network Management Protocol). To activate: ⇒ Set parameter to "On". ⇒ Enter IP address of the management station(s) (receiver 1 or receiver 2). ⇒ Assign the "Community" parameter the value "public".	Off
Time server	Synchronization of the date and time of the printer. To activate: ⇒ Set parameter to "On". ⇒ Enter IP address of the time server. Synchronization occurs hourly. The accepted time is not automatically saved in the printer, however. To save the accepted time: ⇒ Call up the parameter time and save the displayed setting with OK.	Off

**Tab. 14:** Additional parameters for Ethernet interface



**Configuration**

**System messages tab**

Status and error messages can be sent automatically to the SNMP manager or via e-mail to the selected addresses immediately after they occur via the Ethernet interface. You can select the messages to be sent and the destination addresses on the "System messages" tab.

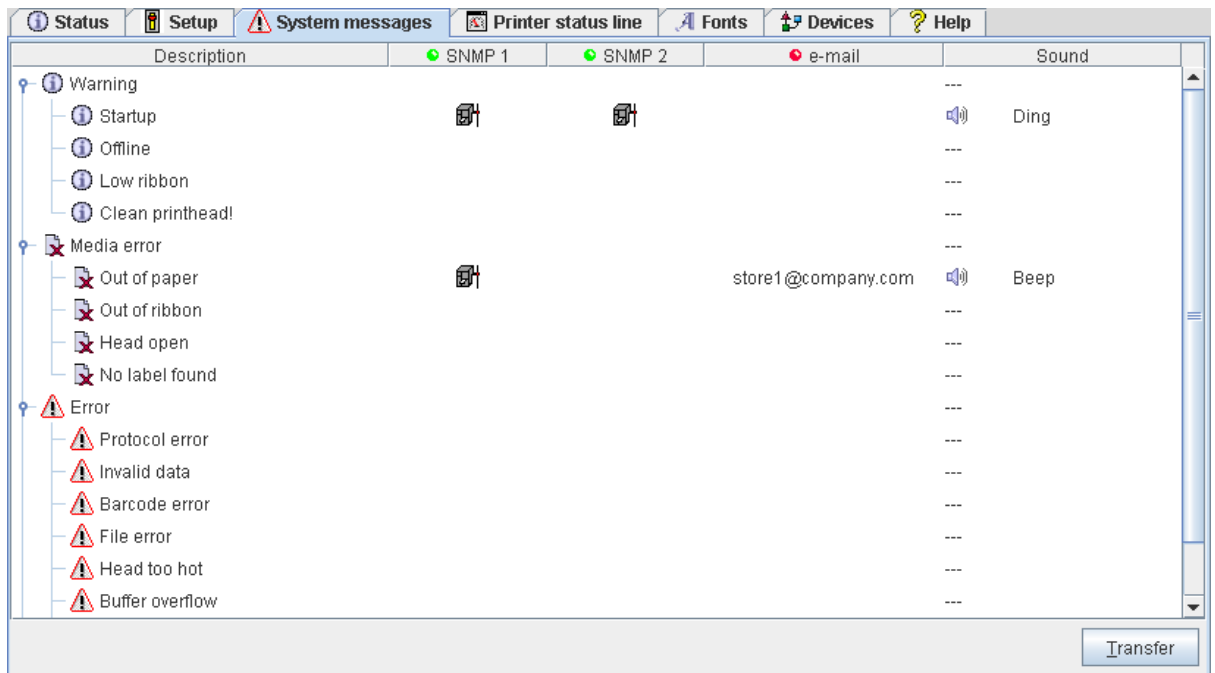

**Fig. 9:** "System messages" tab on the printer website

Column	Meaning
Description	Status and error messages that can be sent. ⇒ Expand tree structure by clicking the circular symbol once or double-clicking the description. An entry for a higher-order description (e.g. note) is automatically accepted for all subordinate descriptions (e.g. "Start", "Not ready", "Ribbon running out").
SNMP 1 SNMP 2	Management stations on local network which communicate with the printer via SNMP. To make use of SNMP functionality, the SNMP agent must be activated (see "2.2" on Page 15). ⇒ Select management station by clicking the corresponding cell. The selection is indicated via a symbol. You can undo the selection by clicking it again.
E-mail	Valid e-mail address for the SMTP server to which the message is to be sent. ⇒ Click cell and enter e-mail address or select from pull-down menu.
Sound	Audible signal which indicates receipt of the message. ⇒ Click cell and select signal type in pull-down menu.

**Tab. 15:** Parameters on "System messages" tab

**!** The settings are not accepted until the **Transfer** button is clicked. If you switch to another tab beforehand, the settings are lost.

## Configuration

### Printer status line tab

On the "Printer status line" tab, you can select the status parameters which are to be displayed on the printer status line.

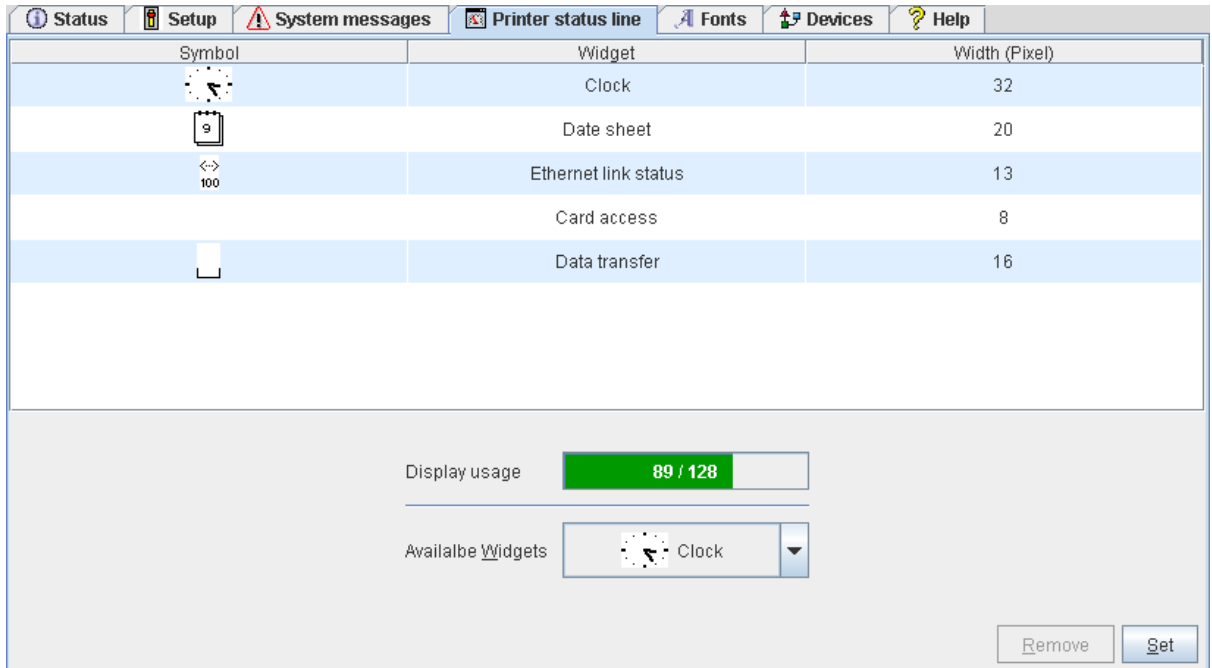

**Fig. 10:** "Printer status line" tab on the printer website

Adding a status parameter:

1. Select widget in pull-down menu.
2. Click **Set**.

The symbol, the parameter designation and the width of the symbol in the display (in pixels) are displayed in the top section of the tab. The entire width of all symbols in the display (e.g. 92 pixels) and the maximum width of the display (e.g. 128 pixels) are displayed in the "Display usage" field.

Removing a status parameter:

1. Select parameter in the list.
2. Click **Remove**.

**Configuration****Fonts tab**

The most important parameters of the fonts available in the printer are listed on the "Fonts" tab. The table contains both the original fonts in the printer and other fonts loaded into the printer.

No.	Name	Type	Description
-1	_DEF1	Bitmap	Default Font 8x8 dots
-2	_DEF2	Bitmap	Default Font 11x12 dots
-3	_DEF3	Bitmap	Default Font 11x22 dots
-4	OCR_A_I	Bitmap	OCR-A Size I
-5	OCR_B	Bitmap	OCR-B
3	BX000003	TrueType	Swiss 721
5	BX000005	TrueType	Swiss 721 Bold
596	BX000596	TrueType	Monospace 821

Print    Update

**Fig. 11:** "Fonts" tab on the printer website

The parameters correspond to those in the **Font list** menu and are described in Table 18 on Page 41.

**Configuration****Devices tab**

The "Devices" tab provides an overview of the most important hardware components installed in the printer and the optional devices connected.

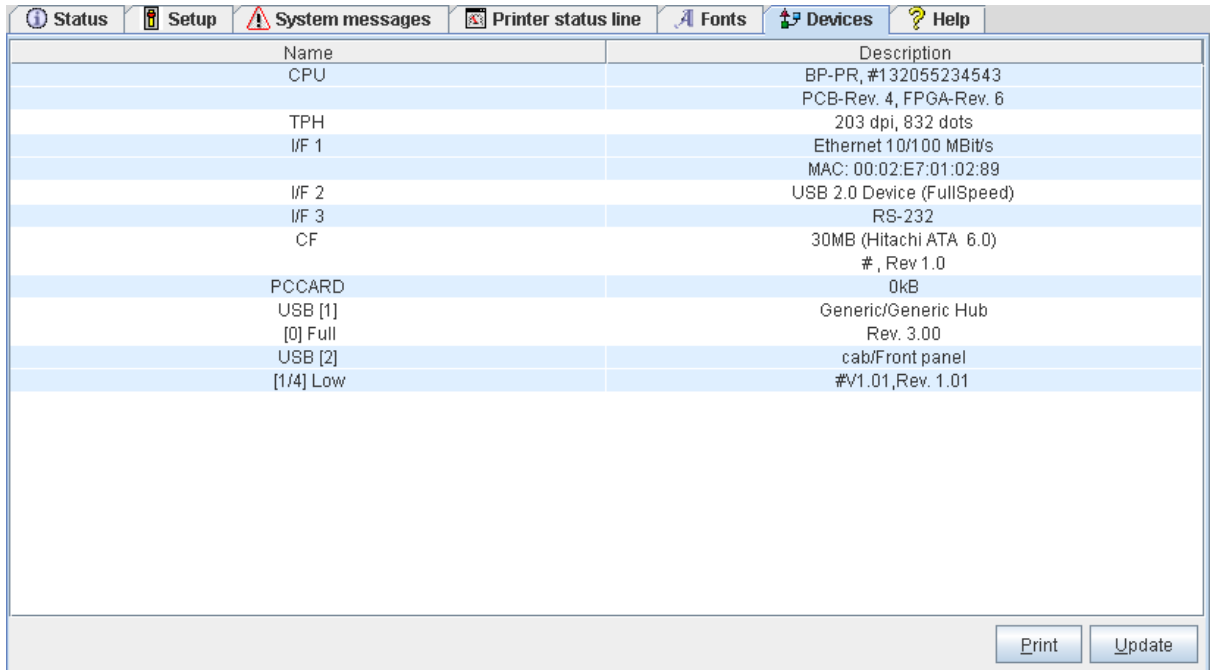

The screenshot shows the 'Devices' tab selected in a web interface. The interface includes a navigation bar with tabs for Status, Setup, System messages, Printer status line, Fonts, Devices, and Help. Below the navigation bar is a table with two columns: 'Name' and 'Description'. The table lists various hardware components and their specifications. At the bottom right of the table area, there are 'Print' and 'Update' buttons.

Name	Description
CPU	BP-PR, #132055234543
	PCB-Rev. 4, FPGA-Rev. 6
TPH	203 dpi, 832 dots
I/F 1	Ethernet 10/100 MBit/s
	MAC: 00:02:E7:01:02:89
I/F 2	USB 2.0 Device (FullSpeed)
I/F 3	RS-232
CF	30MB (Hitachi ATA 6.0)
	#, Rev 1.0
PCCARD	0kB
USB [1]	Generic/Generic Hub
[0] Full	Rev. 3.00
USB [2]	cab/Front panel
[1/4] Low	#V1.01, Rev. 1.01

**Fig. 12:** "Devices" tab on the printer website

The contents of the display correspond with those of the **Device list** and are described in Table 19 on Page 42.

**Help tab**

When the "Help" tab is selected, an internet connection to the support page of the cab website is opened.

## **5 Test functions**

### **5.1 Overview**

The printer is equipped with different test functions providing information on:

- the most important configuration parameters
- the fonts available in the printer
- important hardware components and connected peripheral devices
- the print image quality and state of the thermal printhead
- the function of label detection in conjunction with the optical properties of the label medium
- the label data sent from the computer or read out from the memory card

The test functions are found in the **Test** menu:

1. Press the **menu** button.
2. Select **Test** menu.
3. Switch to the test function level with the ▼ button.
4. Select the desired test function with the ► and ◀ buttons.
5. Start the selected test function with the ↵ button.

## 5.2 Short status

The **short status** menu provides an overview of important status information in the display of the printer.

1. Press the **menu** button.
2. Select **short status** menu.
3. Scroll through the individual lines with the **▲** and **▼** buttons.

You can exit the **short status** menu with the **↵** button.

The following configuration parameters are displayed in the **short status** menu:

Line	Meaning	Example
1	Printer type	BP-PR 200 PLUS
2	Version number of the printer operating system (firmware)	Firmware V3.04
3	Creation date of firmware	(Jul 27 2006)
4	Version number of the system loader (bootloader)	Bootloader V1.14
5	Creation date of the bootloader	(Jul 24 2006)
6	Revision of the CPU PCB	PCB Rev. 04
7	Revision of the FPGA (Field Programmable Gate Array)	FPGA Rev. 2
8	Resolution of the installed thermal printhead	TPH 203dpi,832dots
9	Previously printed paper lengths with thermal transfer printing	Transfer 181.44 m
10	Previously printed paper length with thermal direct printing	Thermal 13.17 m
11	IP address of the printer when connected to a network	192.168.9.13

Tab. 16: Display in **short status** menu

## 5.3 Status print

The **status print** function prints a test image containing information on the configuration and status of the printer. The printout occurs using the heat level and print speed specified in the **Setup > Print param.** menu.

**i** The printout occurs without taking the label gaps into consideration. This is why endless media are most suitable for this purpose.

1. Insert printable medium (labels, endless paper) which extends across the entire printing width.
2. If the printout is to occur using thermal transfer printing, insert transfer ribbon with the maximum width.
3. Press the **menu** button.
4. Select **Test > status print** menu.
5. Start printout with the **↵** button.

You can cancel the printout with the **cancel** button.

Test functions

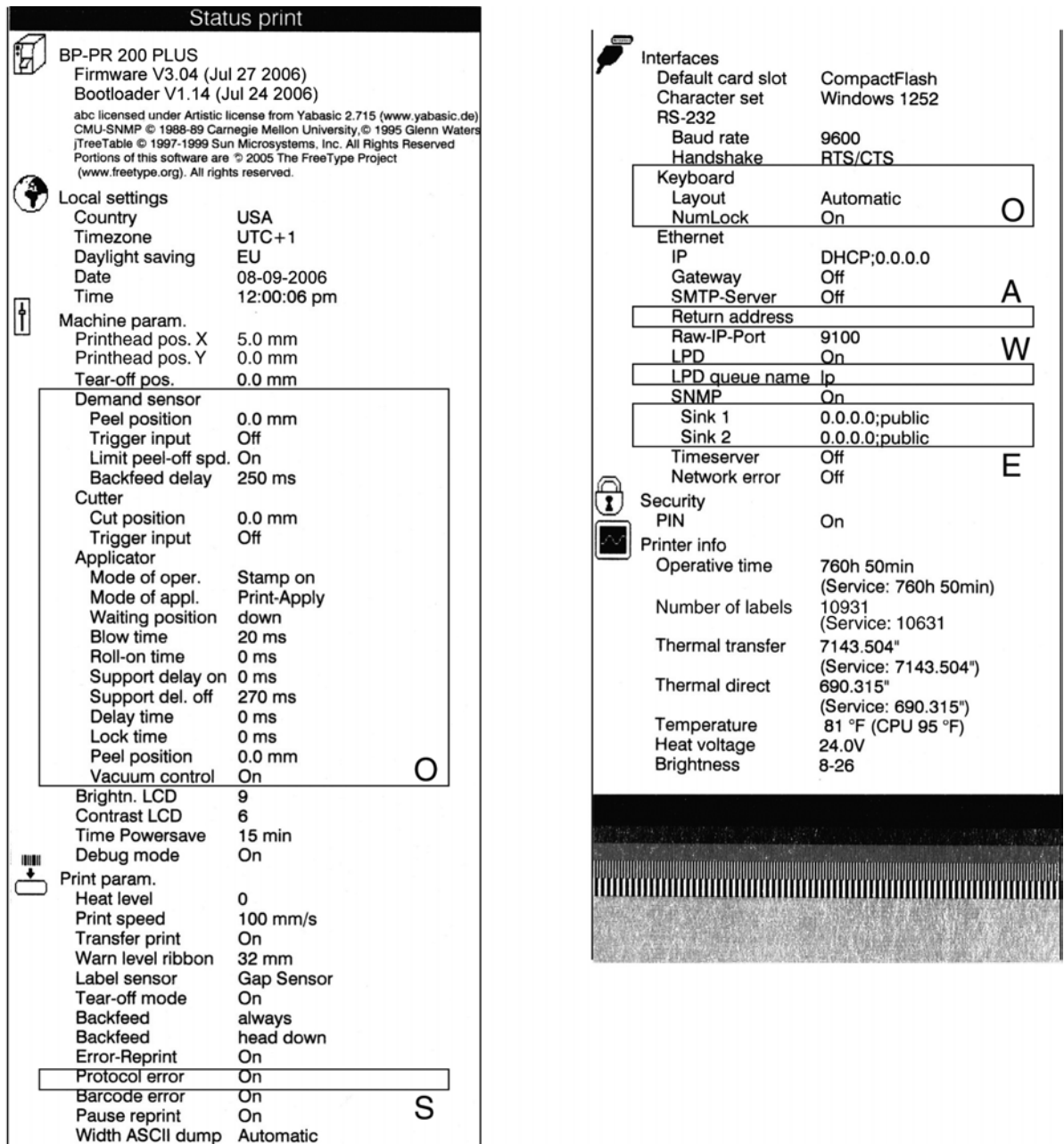









Fig. 13: Status print

- A** From address is displayed if the SMTP server is "On" or the service key is inserted
- E** Recipients are displayed if SNMP is "On" or the service key is inserted
- O** Optional assemblies which are displayed with the service key inserted even if they are not installed
- S** Service data only displayed when the service key is inserted
- W** Queue name is displayed when LPD is "On" or the service key is inserted

**Test functions**

The **status print** contains the following information:

Symbol	Information
	<ul style="list-style-type: none"> <li>• Device type</li> <li>• Version and creation date of the firmware</li> <li>• Version and creation date of the system loader (bootloader)</li> </ul>
	Current values of selected local settings (see "4.1.1" on Page 21).
	Current values of selected device settings (see "4.1.2" on Page 22).
	Current values of selected print parameters (see "4.1.3" on Page 23).
	Current values of selected interface parameters (see "4.1.4" on Page 25).
	Status of PIN activation (see "4.1.6" on Page 27).
	<ul style="list-style-type: none"> <li>• Operative time</li> <li>• Number of labels printed</li> <li>• Printed length with thermal transfer printing and thermal direct printing</li> <li>• Current measured values of the printhead temperature and heat voltage</li> <li>• Information on the working points of the label sensor</li> </ul>
Line pattern	The <b>status print</b> presents lines differing in thickness at various distances at the end. They are used to evaluate the print quality.

**Tab. 17:** Information in **status print**



**Test functions**

**5.4 Font list** 

The **Font list** function prints the most important parameters of the fonts available in the printer in tabular form. The table contains both the original fonts in the printer and other fonts loaded into the printer. The printout occurs using the heat level and print speed specified in the **Setup > Print param.** menu.

**i** The printout occurs without taking the label gaps into consideration. This is why endless media are most suitable for this purpose.

1. Insert printable medium (labels, endless paper) which extends across the entire printing width.
2. If the printout is to occur using thermal transfer printing, insert transfer ribbon with the maximum width.
3. Press the **menu** button.
4. Select **Test > Font list** menu.
5. Start printout with the **↓** button.

You can cancel the printout with the **cancel** button.

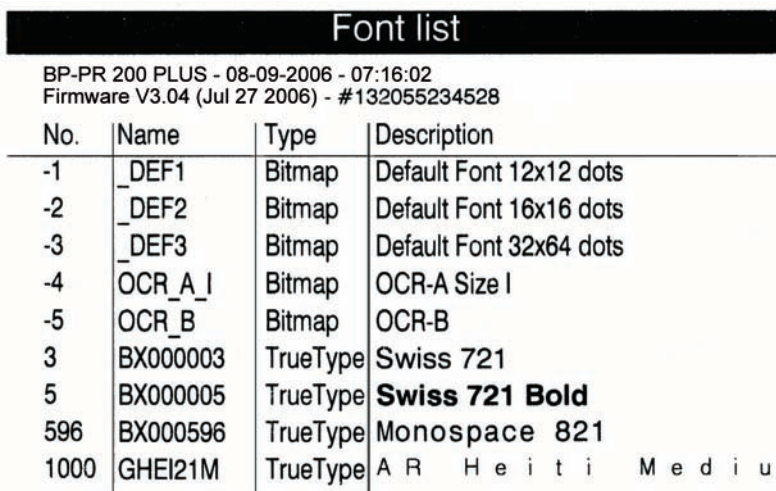

No.	Name	Type	Description
-1	_DEF1	Bitmap	Default Font 12x12 dots
-2	_DEF2	Bitmap	Default Font 16x16 dots
-3	_DEF3	Bitmap	Default Font 32x64 dots
-4	OCR_A_I	Bitmap	OCR-A Size I
-5	OCR_B	Bitmap	OCR-B
3	BX000003	TrueType	Swiss 721
5	BX000005	TrueType	<b>Swiss 721 Bold</b>
596	BX000596	TrueType	Monospace 821
1000	GHEI21M	TrueType	A R H e i t i M e d i u

**Fig. 14:** Font list

The parameters have the following meaning:

Column	Meaning
No.	ID number of the font required for programming (command T).
Name	Name with which the font is saved internally.
Type	Type of font generation. It provides information on the variability of the font and is important when programming (command T).
Description	Explanations of the font: size, font family. The printout occurs in the appropriate font.

**Tab. 18:** Parameters of the **Font list**

## 5.5 Device list

The **Device list** function prints out the most important information on hardware components of the printer and connected devices. The printout occurs using the heat level and print speed specified in the **Setup > Print param.** menu.

**i** The printout occurs without taking the label gaps into consideration. This is why endless media are most suitable for this purpose.

1. Insert printable medium (labels, endless paper) which extends across the entire printing width.
2. If the printout is to occur using thermal transfer printing, insert transfer ribbon with the maximum width.
3. Press the **menu** button.
4. Select **Test > Device list** menu.
5. Start printout with the **↵** button.

You can cancel the printout with the **cancel** button.

```

Device list
PB-PR 200 PLUS - 08-09-2006 - 07:16:34
Firmware V3.04 (Jul 27 2006) - #1320552345428
Name | Description
-----|-----
CPU | BP-PR #132055234528
    | PCB-Rev. 4, FPGA-Rev. 4
TPH | 203 dpi, 832 dots
I/F 1 | Ethernet 10/100 MBit/s
    | MAC: 00:02:E7:00:26:05
I/F 2 | USB 2.0 Device
I/F 3 | RS-232
CF | 15MB (SanDisk SDCCFB-16)
    | # 243339B0908, vde 1.10
USB [1] | Generic/Generic Hub
[0] Full | Rev. 3.00
    | Mfr: 03EB,Class: 09/00,Protocol: 00, Phase: 20/0
USB [3] | cab/Frontpanel
[1/4] Full | Rev. 1.02
    | Mfr: 0985,Class: FF/1C,Protocol: 00, Phase: 20/1
    
```

**Fig. 15:** Device list

Name	Information
CPU	<ul style="list-style-type: none"> <li>• Type and serial number of the CPU PCB</li> <li>• Revision of CPU PCB and FPGA</li> </ul>
TPH	Resolution and heating point number of the installed thermal printhead.
I/F [x]	Type of interfaces installed <b>x</b> : Number of interface
USB [a] [b/c] Speed	Type and revision of installed USB devices <b>a</b> : number of USB device <b>b</b> : number of USB device to which device a is connected <b>c</b> : number of interface of device b to which device a is connected <b>Speed</b> : data transfer speed (low, full, high)  The following properties are only displayed when the service key is inserted: <b>Mfr.:</b> Manufacturer ID. This identifies the manufacturer of the USB device <b>Class:</b> Code for the USB device class <b>Protocol:</b> Code for the type of communication with the USB device <b>Phase:</b> Internal value for troubleshooting

**Tab. 19:** Parameters of the **Device list**

## 5.6 ASCII Dump Mode

**ASCII Dump Mode** offers the option of checking incoming control sequences at the interface when working with direct programming. The incoming commands at the printer are printed out as text. In addition, a corresponding error message is printed out immediately after an error occurs.

The printout occurs using the heat level and print speed specified in the **Setup > Print param.** menu and is started after four lines are have been received.

- i**
  - The printout occurs without taking the label gaps into consideration and without transfer ribbon checking. This is why endless media are most suitable for this purpose.
  - If you only have media (labels, endless paper) which do not cover the entire printing width, you can reduce the width of the printout continuously down to 50 mm with the **width ASCII dump** parameter (see "4.1.3" on Page 23).

- i** If you have questions about programming, keep a printout of your label file which was created in **ASCII Dump Mode** handy. The printout can be transmitted clearly via fax.

1. Load printable medium (labels, endless paper).
2. If the printout is to occur using thermal transfer printing, insert transfer ribbon.
3. If the printable medium and/or the transfer ribbon does not cover the entire printing width, reduce the width of the printout accordingly with the **width ASCII dump** parameter (see "4.1.3" on Page 23).
4. Press the **menu** button.
5. Select **Test > ASCII Dump Mode** menu.
6. Switch to Monitor mode with the **↓** button.
7. Send print jobs.
8. Call up the last few lines of a label description with the **feed** button.

Press the **cancel** button if you would like to cancel the printout or switch to the **Ready** mode.

The control characters (ASCII code 00 to 31) are presented in the following form:

Code DEC   HEX	Print- out	Code DEC   HEX	Print- out	Code DEC   HEX	Print- out	Code DEC   HEX	Print- out
00   00	NUL	08   08	BS	16   10	DL <sub>E</sub>	24   18	CA <sub>N</sub>
01   01	SO <sub>H</sub>	09   09	HT	17   11	DC <sub>1</sub>	25   19	EM
02   02	ST <sub>X</sub>	10   0A	LF	18   12	DC <sub>2</sub>	26   1A	SUB
03   03	ET <sub>X</sub>	11   0B	VT	19   13	DC <sub>3</sub>	27   1B	ESC
04   04	EO <sub>T</sub>	12   0C	FF	20   14	DC <sub>4</sub>	28   1C	FS
05   05	ENQ	13   0D	CR	21   15	NA <sub>K</sub>	29   1D	GS
06   06	ACK	14   0E	SO	22   16	SY <sub>N</sub>	30   1E	RS
07   07	BE <sub>L</sub>	15   0F	SI	23   17	ET <sub>B</sub>	31   1F	US

**Fig. 16:** Presentation of the control characters in **ASCII Dump Mode**

## Test functions

**Example:**

In the following two figures, the printout in Monitor mode is contrasted with the "normal" printout of a label.

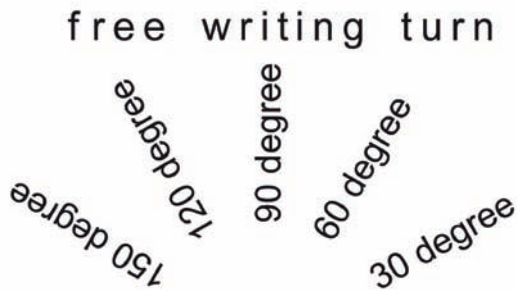

Fig. 17: Example label

```
JCLRF
H 100,4,DCLRF
S 11;0,0,68,71,106;CLRF
T 20,10,0,596,pt18;free writing tur
nCLRF
T 72,54,30,596,pt18;30 degreeCLRF
T 65,46,60,596,pt18;60 degreeCLRF
T 56,42,90,596,pt18;90 degreeCLRF
T 46,44.5,120,596,pt18;120 degreeCLRF
T 38,50.5,150,596,pt18;150 degreeCLRF
A 1CLRF
```

Fig. 18: Printout of the example label in ASCII Dump Mode

## 5.7 Test grid

The **Test grid** function prints out the geometric pattern on a background grid. This allows you to assess the evenness of the print quality.

The printout occurs using the heat level and print speed specified in the **Setup > Print param.** menu.

**i** The printout occurs without taking the label gaps into consideration. This is why endless media are most suitable for this purpose.

1. Insert printable medium (labels, endless paper) which extends across the entire printing width.
2. If the printout is to occur using thermal transfer printing, insert transfer ribbon with the maximum width.
3. Press the **menu** button.
4. Select **Test > Test grid** menu.
5. Start printout with the **↓** button.

The geometric pattern is printed every 5 seconds once the **Test grid** function is started. You can adjust the printer during the pauses between the printouts.

You can end the printout of the test grid with the **cancel** button.

## Test functions

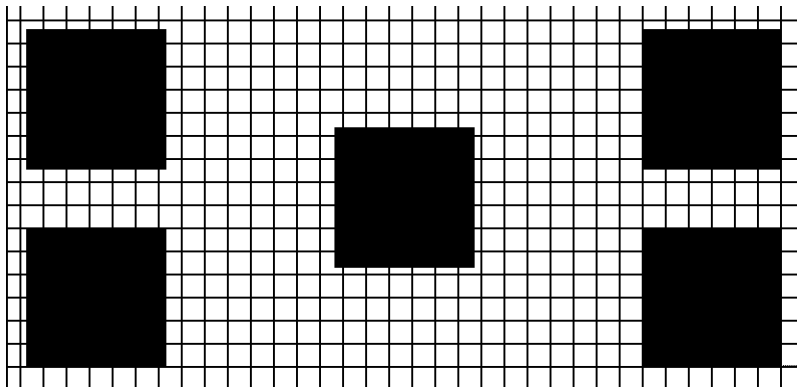

Fig. 19: Example test grid

## 5.8 Label profile

The **Label profile** function carries out a longer label advance. It saves the values measured by the label sensor here and then prints them out in two diagrams. The printout is used to check label detection in conjunction with the optical properties of the label medium.

The printout occurs using the heat level and print speed specified in the **Setup > Print param.** menu.

**i** The printout of the diagram occurs without taking the label gaps into consideration. This is why endless media are most suitable for the printout.

1. Select the label sensor to be tested in the menu **Setup > Print param.** (see "4.1.3" on Page 23).
2. Load the label medium to be tested into the printer.
3. Press the **menu** button.
4. Select **Test > Label profile** menu.
5. Start the function with the **↓** button.

The printer performs a longer label advance. The label sensor measures the transparency/reflection capacity of the label material here. The message **Test print OK** appears in the display once the advance is complete.

6. Insert printable medium (labels, endless paper) which extends across the entire printing width.
7. If the printout is to occur using thermal transfer printing, insert transfer ribbon with the maximum width.
8. Start the diagram printout with the **↓** button.

The following figure shows an example label profile. The top diagram shows the gradient determined for label detection. The rise (first derivative) of the gradient is represented in the bottom diagram. The starting end of the label is located at the point where the rise of the gradient exhibits a minimum (see vertical dotted line).

Test functions

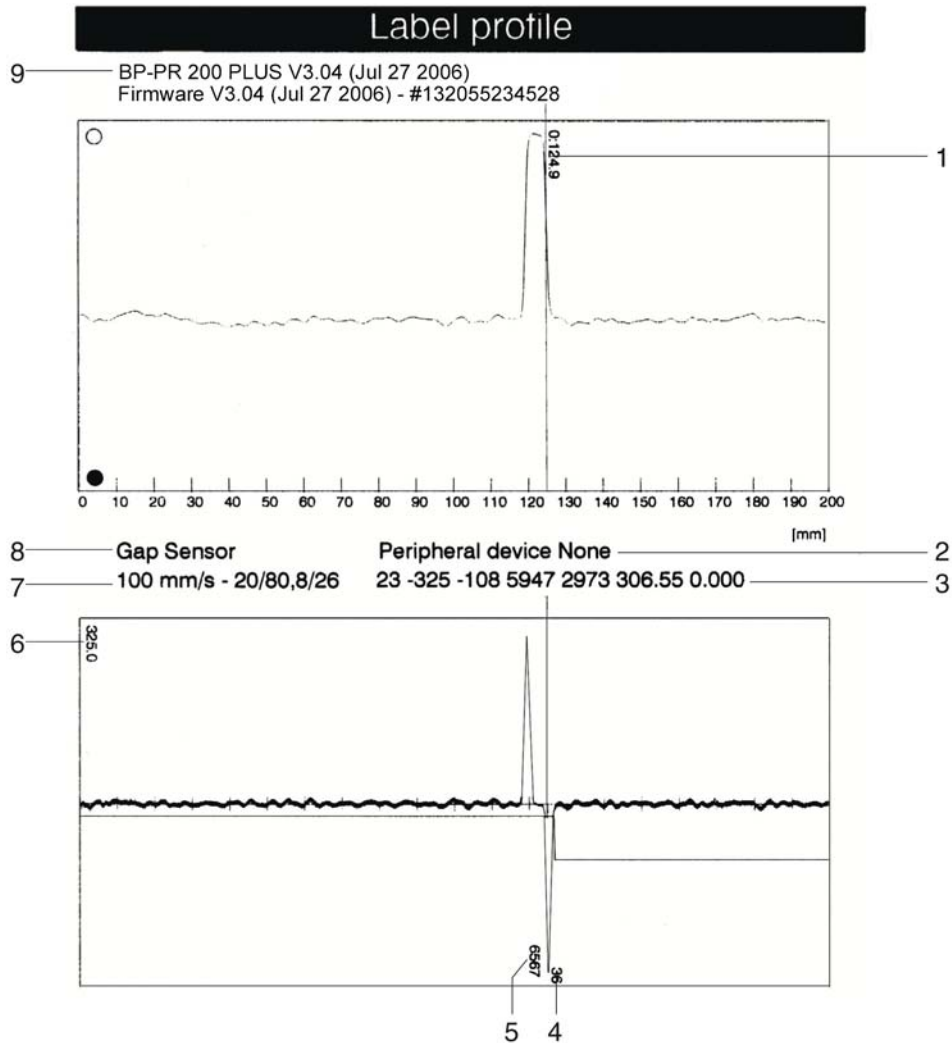

Fig. 20: Label profile

- 1 Coordinate in the direction of paper flow at which the label start was detected
- 2 Type of peripheral device connected
- 3 Information for the firmware developer
- 4 Width of the negative derivative in motor increments
- 5 Stroke between start and end of the negative derivative
- 6 Scale factor for the derivative diagram
- 7 Service information for adjusting the label sensor
- 8 Method of label detection (transmitted light/reflex bottom)
- 9 Device name and current firmware version

**Test functions**

## 5.9 Event log



Access only when service key is inserted!

The printer saves the following events in the **Event log**:

- Hardware fault
- Printhead replacement with a change in resolution
- Adjustment of the label sensor
- Firmware updates
- Resetting of the service counters

The printout of the **Event log** occurs using the heat level and print speed specified in the menu **Setup > Print param.**



The printout occurs without taking the label gaps into consideration. This is why endless media are most suitable for this purpose.

1. Insert service key into a USB master interface.
2. Insert printable medium (labels, endless paper) which extends across the entire printing width.
3. If the printout is to occur using thermal transfer printing, insert transfer ribbon with the maximum width.
4. Press the **menu** button.
5. Select **Test > Event log** menu.
6. Start printout with the **↵** button.

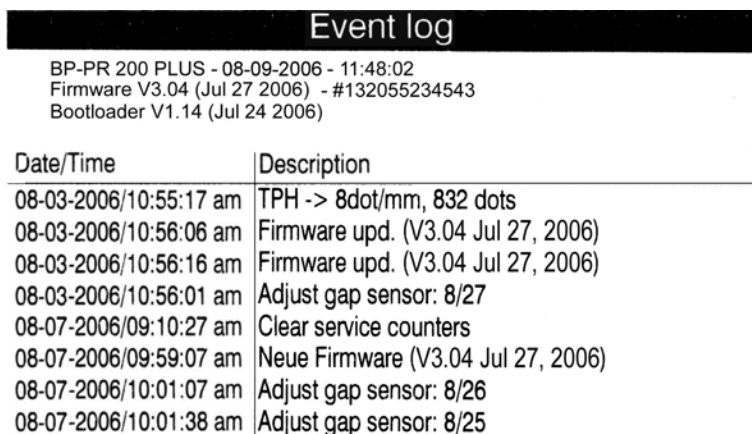

**Fig. 21:** Event log

The **Event log** contains the following information:

Location	Description
First line	Version number and creation date of the firmware
Second line	Version number and creation date of the bootloader
Left column	Date and time the event occurred
Right column	Brief description of the event

**Tab. 20:** Information in the **Event log**

## 5.10 Print IFFS contents



Access only when service key is inserted!

The IFFS (Internal Flash File System) is found on a Flash EPROM in the printer. The memory is used for long-term storage of programs and is conceived for "read-only" access. You can print an overview of the IFFS contents with the **Print directory** function.



The **Print directory** function is not displayed if data has not been saved in the IFFS.

1. Insert service key into a USB master interface.
2. Press the **menu** button.
3. Select **Test > Print directory** menu.
4. Start printout with the **↵** button.

You can cancel the printout of the IFFS contents with the **cancel** button.

The following information is available in the printout:

- First line: title
- There is a line for each file in the IFFS with information on: file name, file extension, file size in bytes, time stamp for the last file modification.
- Last line: available memory in the IFFS



## 6 Service functions

### 6.1 Performing firmware update

The firmware of the printer is saved in a Flash EPROM. You can update the firmware using the following functions:

- **Firmware upd.:** Copy a firmware file from a computer connected to one of the interfaces of a printer (see "6.1.1" on Page 49).
- **Firmw. fr. card:** Copy a firmware file from a memory card (see "6.1.2" on Page 49).
- FTP firmware update via printer management (see "7.3" on Page 55).

The firmware file can be obtained on a diskette or from the internet.

#### 6.1.1 Copying new firmware via interface

1. Press the **menu** button.
2. Select **service > Firmware upd.** menu.
3. Press the  $\downarrow$  button.  
The **Firmware-Upd** message appears in the display.
4. Press the  $\downarrow$  button.
5. If the function **Firmware upd.** is protected via a PIN, use the buttons  $\blacktriangle$ ,  $\blacktriangledown$ ,  $\blacktriangleright$  and  $\blacktriangleleft$  to enter the code number and confirm with the  $\downarrow$  button.
6. Open the DOS input window on the PC.
7. Configure the serial interface of the PC with the mode command. Enter the command **mode com1: baud=115200 parity=n data=8 stop=1**, for example
8. Send the firmware file (e.g. 303\_6518.x2) to the printer. Enter the command **copy /b 304\_6727.x2 com1: ,** for example.  
A progress indicator is displayed while the firmware is being copied. **OK** appears in the display once copying is successfully completed.
9. Press the  $\downarrow$  button.

#### 6.1.2 Copying new firmware from memory card

1. Format CompactFlash memory card in printer (see "8.2" on Page 57).  
The directories "fonts", "images", "labels" and "misc" are created on the memory card here.
2. Copy the firmware file to the "misc" directory in a CompactFlash drive.
3. Insert the prepared memory card into the printer.
4. Press the **menu** button.
5. Select **service > Firmw. fr. card** menu.
6. Press the  $\downarrow$  button.
7. If the function **Firmw. fr. card** is protected via a PIN, use the buttons  $\blacktriangle$ ,  $\blacktriangledown$ ,  $\blacktriangleright$  and  $\blacktriangleleft$  to enter the code number and confirm with the  $\downarrow$  button.  
The names of the firmware files found on the memory card are shown in the display.
8. If several firmware files are found on the memory card, select the desired file with the  $\blacktriangle$  and  $\blacktriangledown$  buttons.

**Service functions**

9. Press the  $\downarrow$  button.

The selected firmware file is copied. A progress indicator is displayed while the firmware is being copied.  $\text{OK}$  appears in the display once copying is successfully completed.

10. Press the  $\downarrow$  button.

**6.1.3 Error messages during the firmware update**

If an error occurs during the update, one of the following error codes is shown in the display:

Error code	Meaning
C	Checksum error. /b may have been forgotten in the COPY command or the file is defective.
H	Header error. /b may have been forgotten in the COPY command or the file is defective.
E	EPROM could not be cleared.
V	Programming voltage is too low.
P	Programming error.

**Tab. 21:** Possible error codes with a firmware update



If an error occurs with a firmware update, the old firmware version is no longer usable. Restart programming in this case.

**6.2 Clearing service counter**

Access only when service key is inserted!

The printer has total and service counters.

- Total counter: The total counter contains the values for the entire service life of the printer up to now. The values of the total counter are displayed in the **short status** and in the **status print**.
- Service counter: The service counter can be reset after more substantial maintenance or repair work with the service key inserted. Here, it provides information on the printing output since the last reset. The values of the service counter are displayed in the **status print**.

The following data is recorded in both counters:

Data	Description
Operative time	Printer switch-on time
Number of labels	Number of labels printed
Transfer printing	Length of medium printed with transfer printing
Thermal printing	Length of medium printed with thermal direct printing

**Tab. 22:** Total and service counter data

1. Insert service key into a USB master interface.
2. Press the **menu** button.
3. Select **service > clr. service ctr.** menu.
4. Press the  $\downarrow$  button.  
**no** appears in the display.

**Service functions**

5. Use the ▲ and ▼ buttons to select **Yes**.
6. Press the ↵ button.

The data recorded by the service counter is set to the value 0.

You can use the status print to check whether the values were reset. The service counter values are listed in parentheses under the total counter values there.

### 6.3 Adjusting label sensor

 Access only when service key is inserted!

You can adjust the label sensor with the **Adj. gap sensor** function. This is necessary if the sensor or CPU PCB has been changed.

**i** Carry out adjustment of the sensor with the cover closed and housing mounted to keep out external light sources.

1. Insert service key into a USB master interface.
2. Press the **menu** button.
3. Select **service > Adj. gap sensor** menu.
4. Press the ↵ button.
5. Open printhead.  
In the display you are instructed remove the label medium from the sensor via the **Remove labels** message.
6. Remove label medium from the sensor.
7. Press the ↵ button.  
In the display you are instructed to load the liner into the label sensor via the **Insert liner** message.
8. Load liner (without labels) into the sensor.
9. Ensure that no labels are found on the liner near the sensor. Otherwise, the result will be faulty adjustment and device malfunction.
10. Start adjustment of the label sensor with the ↵ button.  
OK appears in the display after a successful adjustment.
11. Confirm completion of the adjustment with the ↵ button.

**Error during adjustment:**

If an error occurs while adjusting the label sensor, **Error** appears in the display. If an error occurs again when repeating the adjustment, one of the following assemblies may be defective:

- Label sensor
- Connection cable of the label sensor
- CPU PCB

## 6.4 Save settings

**i** Access only possible with CF memory card inserted.

You can save the printer configuration to a CompactFlash memory card with the **save settings** function. The configuration will be saved as XML file in the folder \MISC of the CF card. The current date is used as file name YYYYMMDD.XML (e.g. 20060802.XML for a file saved on 08-02-2006).

1. Insert CompactFlash card.
2. Press the **menu** button.
3. Select **service > save settings** menu.
4. If the function **save settings** is protected via a PIN, use the buttons ▲, ▼, ► and ◀ to enter the code number and confirm with the ↵ button.

Saving of the configuration data starts. OK is shown in the display when the entire saving procedure is complete.

5. Press the ↵ button.
6. Do not remove the memory card until the saving procedure is complete.

An error message appearing during the saving procedure may be caused by an unreadable CF card (e.g. unknown card type, unformatted card). Information on formatting the CF card is found in "Formatting" on Page 57.

## 6.5 Load settings

**i** Access only possible with CF memory card inserted.

You can load a printer configuration previously saved to a CF card into the printer with the **Load settings** function.

1. Insert CompactFlash card.
2. Press the **menu** button.
3. Select **Service > Load settings** menu.
4. If the function **Load settings** is protected via a PIN, use the buttons ▲, ▼, ► and ◀ to enter the code number and confirm with the ↵ button.
5. If several configuration files are found on the memory card, select the desired file with the ▲ and ▼ buttons.
6. Press the ↵ button.

Loading of the configuration data starts. OK is shown in the display when the entire loading procedure is complete.

7. Press the ↵ button.
8. Do not remove the memory card until the loading procedure is complete.

If an error occurs during the loading procedure, an error message appears in the display. Restart the loading procedure in this case. If an error occurs again, you must enter the configuration parameters via the operating panel.

## 6.6 Changing OEM name

 Access only when service key is inserted!

You can change the device designation with the **OEM Name** function.

1. Insert service key into a USB master interface.
2. Press the **menu** button.
3. Select **service > OEM Name** menu.
4. Press the **↓** button.  
A list of available names is shown in the display.
5. Use the **▲** and **▼** buttons to select the desired **OEM name**.
6. Press the **↓** button.

## 6.7 Cleaning interval

 Access only when service key is inserted!

The **Cleaning interval** function is used for additional printhead maintenance control. You can select the length of medium which passes the printhead in increments of 500 m after which the printhead is to be cleaned.

1. Insert service key into a USB master interface.
2. Press the **menu** button.
3. Select **service > Cleaning interval** menu.
4. Press the **↓** button.
5. Select the desired value with the **▶** and **◀** buttons.
6. Press the **↓** button.

If the set length of the medium (label strip, transfer ribbon) has passed the printhead and an error occurs in the flow of the medium (e.g. label end, transfer ribbon end), the **Clean printhead!** message appears in the display. The error message for the error which occurred is not displayed until you acknowledge this message. As long as no errors occur in the medium flow, no messages are displayed and the print job is continued even if the cleaning interval has passed.

You can deactivate the **Cleaning interval** function by setting the value **Off**.

## 7 FTP printer management

Using the File Transfer Protocol (FTP), you can manage and transfer files on the network via the Ethernet interface. You will require an FTP program (FTP client) which supports the "binary" transfer mode to manage the printer. The printer functions as an FTP server.

FTP printer management is comprised of four functions:

- management of the memory card installed in the printer (see "8" on Page 56)
- printer firmware update (see "6.1.1" on Page 49)
- IFFS management (see "7.2" on Page 55)
- direct printing via copying .LBL files (see "7.2" on Page 55)

### 7.1 FTP logon

To establish an FTP connection, the client must be logged on to the server. The logon type depends on the client. The following information must be specified in any case, however:

- IP address of the printer
- User name and password

Access to the printer management functions depends on the user name:

User name	Password	Executable functions
anonymous	any	Display and download of the files stored on the memory card. Display of the IFFS contents.
root	printer PIN	Display, upload and download of memory card data, the IFFS contents and FTP firmware update. Label files loaded on the memory card must be of the <b>.LBL</b> type.

**Tab. 23:** Data for establishing an FTP connection

After logging on, you can access the FTP server in a manner similar to a Windows folder.

**!** It is absolutely necessary to define a PIN for FTP access with the username "root". The initial setting of the PIN can be made via the operating panel of the printer or via the printer website.

## 7.2 Directory structure of the FTP server

The files accessible via FTP are found in several folders:

Folder name	Contents
<b>iffs</b>	Contents of the IFFS (Internal Flash File System). When logging on with the username "root", the contents of the IFFS can be managed.
<b>system</b>	Firmware file of the printer
<b>execute</b>	Printing of label files stored in this folder is started immediately. The files must be of the type <b>.LBL</b> . The corresponding file is deleted once the print job is complete.
Display of the following folders depends on the installed memory card and the card slot defined as the primary slot:	
<b>card</b>	Data of the memory card in the primary card slot. The files are separated into several subfolders based on their type. The structure of the subfolders depends on which card type is primary.
<b>cf</b>	Data of the CompactFlash memory card in the printer if the CF card slot is not primary. The files are separated into several subfolders accordingly based on their type. When copying the files to the "cf" folder, type-based sorting occurs automatically in the subfolders.
<b>pccard</b>	Data of the PC card if the card slot is not primary. This folder does not have a substructure.

Tab. 24: Directory structure of the FTP server

## 7.3 FTP firmware update

To carry out a firmware update, you must be logged on with the username "root" (see "7.1" on Page 54).

1. Ensure that the printer is in "Ready" mode. See "Status tab" on Page 29.
2. Set the "binary" transfer mode in the FTP client.
3. Open the "system" folder.
4. Copy a valid firmware file (e.g. 304\_6727.x2) to the "system" folder.

**FTP-Firmware-UPd** appears in the display of the printer. The status of the saving procedure is shown by a progress indicator in the display. The printer resets automatically after the update is carried out successfully.

You can check whether the firmware update was carried out successfully on the "Status" tab of the printer website.

## 8 Memory cards

You can save graphics, fonts, label descriptions and database information for the long-term on a memory card.

**i** Always create a backup copy of the memory card in case of a malfunction.

You can use the following memory card types:

- Type 1 CompactFlash card up to a maximum size of 1 GB in the corresponding card slot of the printer
- PC card (PCMCIA) in the corresponding card slot of the printer

### 8.1 Insertion and removal

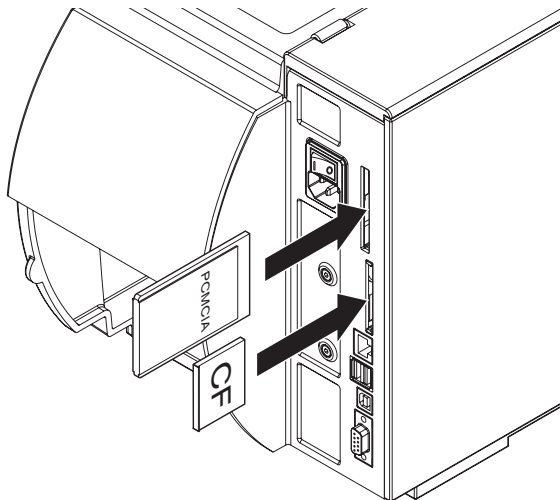

**Fig. 22:** Inserting memory card

**i** When the memory card is slid onto the contact pins, light physical resistance can be felt.

1. Slide memory card contact-side first into the slot as far as it will go.  
The rear section of the inserted memory card still extends from the device housing so that it can be removed by hand.

2. Press the **menu** button.

3. Check whether the **Memory card** menu is shown in the display.

If the **Memory card** menu is not shown in the display, it could be because:

- you have not selected the card slot being used as the primary card slot
- you have not inserted the memory card far enough into the card slot
- you have entered the memory card incorrectly

**!** Do not remove the memory card while it is being accessed. You can configure the printer so that access to a memory card is indicated on the status line (see "4.1.5" on Page 26).



**Memory cards**

## 8.2 Formatting

If the memory card has not been preformatted in a suitable way, you must format it in the following manner:

- Formatting in the printer via the **Format card** (see "8.4.4" on Page 60) menu item.
- Formatting in the printer via the interface with the `Mf;name CR` command. See "*Programming Instructions*".
- Formatting in an appropriate drive of a PC. See documentation of the drive used.

## 8.3 Writing

The memory card can be written to in several ways. The most functionally secure way is writing to the card in the printer via a data interface.

**!** The card in the primary card slot is written to by default. You can write to a card in another slot if you specify the path name of the slot in the file name (see "*Programming Instructions*").

**Example:**

With direct programming, the command sequence for saving a label (file **ABC**) has the following form:

<pre>Ms LBL; ABC J H 100,0,T S  1;0,0,68,71,104 T 10,10,0,3,pt15;memory card A 1[NOPRINT] Ms LBL</pre>	<pre>Command for saving the file <b>ABC</b>     Contents of the file <b>ABC</b>   End of save command</pre>
--	---

- After transfer of the command sequence, the file ABC is saved on the memory card with the commands from J to A.
- Only one label is printed each time the file ABC is called up.
- The [NOPRINT] parameter in command A suppresses the printing of a label when the file is saved.
- If you would like to print the label a variable number of times, you must put command A after the ending Ms command.

## 8.4 Memory card functions in the offline menu

Accessing the **Memory card** menu is only possible if a memory card is installed.

You can still only operate the card slot set in the menu **Interfaces > Default card slot** via the operating panel (see "4.1.4" on Page 25). When operating via an interface, each card slot can be addressed via a path.

### 8.4.1 Loading label

You can print labels whose descriptions are saved on the memory card using the **Label from card** function.

1. Select the **Label from card** function in the **Memory card** menu.

2. Press the  $\downarrow$  button.

The name of the label found at the top of the index of the card is displayed.

3. Select the desired label in the index of the card with the  $\blacktriangle$  and  $\blacktriangledown$  buttons.

4. Press the  $\downarrow$  button.

If you have selected a label which was saved with a fixed label quantity, the print job is started immediately.

For label descriptions with a variable label quantity, you are requested by the display to enter the label quantity .

If additional input on the label description is required, the display requests you to enter the variable data .

5. Enter the label quantity/variable data with the following buttons:

◀ cursor left

▶ cursor right

▲ increase value at cursor position by 1 or select next letter in alphabet

▼ decrease value at cursor position by 1 or select previous letter in alphabet

6. Press the  $\downarrow$  button briefly to confirm the input and start the print job.

#### Canceling input:

You can cancel the selection of the label and the label quantity at any time by pressing and holding the  $\downarrow$  button (at least 2 seconds).

### 8.4.2 Printing card index

You can print out the index of the installed memory card with the **Print directory** function.

1. Insert printable medium (labels, endless paper) which extends across the entire printing width.

2. If the printout is to occur using thermal transfer printing, insert transfer ribbon with the maximum width.

3. Press the **menu** button.

4. Select the **Print directory** function in the **Memory card** menu.

5. Start printout with the  $\downarrow$  button.

The printout contains:

- the name of the memory card
- information on the saved files
- the size of the available memory area

### 8.4.3 Copy memory card

You can copy all the data from one memory card to another with the **Copy memory card** function. Copying between memory cards with different memory capacities is possible. You can also use memory cards which already contain data as a destination medium.



#### CAUTION!

##### Data loss when copying.

**If files with the same name are found on the original and copy cards, the files on the copy card are overwritten without any prior notification. In addition, removal of the memory card during the copying procedure leads to data loss.**

⇒ **Check files for the same name before copying.**

⇒ **Only remove or insert memory cards when so instructed in the display.**

You can prevent unauthorized copying of memory cards by using a PIN. (see "Security" on Page 27)

1. Insert original card. (see "Insertion and removal" on Page 56)
2. Press the **menu** button.
3. Select **Memory card > Copy memory card** with the buttons **▶** and **◀**.
4. Press the **↓** button.  
A selection field with the selection **No** appears in the display.
5. Use the **▲** and **▼** buttons to select **Yes**.
6. Press the **↓** button.
7. If the function **Copy memory card** is protected via a PIN, use the buttons **▲**, **▼**, **▶** and **◀** to enter the code number and confirm with the **↓** button.  
The copying procedure starts. When copying larger amounts of data, the copying procedure is carried out in several copying cycles. An increasing progress indicator is shown in the display during a copy cycle. The **Insert dest.** instruction then appears.
8. Remove original card and insert the card to be written to.  
The data read from the original card is transferred to the copy card. The progress indicator in the display shrinks during this process. If only part of the data from the original card was read out, the **Insert source** instruction appears.
9. Remove copy card and insert original card again.  
The next copy cycle begins.
10. Repeat the previous two steps until all data has been copied.  
**OK** is shown in the display when the entire copying procedure is complete.
11. Press the **↓** button.

If the card to be written to can no longer accept data during the copying procedure, the **Card full** error message appears in the display.

**Memory cards****8.4.4 Format card** 

You can delete all data from a memory card with the **Format card** function. This reformats the memory card. This is why you can also use the **Format card** function if the **Unknown card** or **Structural err.** error message was output when using the card.

You can prevent unauthorized deleting of memory cards by using a PIN (see "4.1.6" on Page 27).

1. Insert a memory card (see "8.1" on Page 56).
2. Press the **menu** button.
3. Select **Memory card** > **Format card** with the buttons **▶** and **◀**.
4. Press the **↓** button.  
A selection field with the selection **No** appears in the display.
5. Use the **▲** and **▼** buttons to select **Yes**.
6. Press the **↓** button.
7. If the function **Format card** is protected via a PIN, use the buttons **▲**, **▼**, **▶** and **◀** to enter the code number and confirm with the **↓** button.  
The deleting procedure starts.
8. Do **not** remove the card from the printer during the deleting procedure.  
The memory volume of the card is shown in the display as soon as the deleting procedure is complete.
9. Press any button.

**8.4.5 Printing file contents** 

The label files found on a memory card consist of a sequence of printer commands. You can print these command sequences in the form of text with the **ASCII dump (Card)** function.

1. Insert printable medium (labels, endless paper) which extends across the entire printing width.
  2. If the printout is to occur using thermal transfer printing, insert transfer ribbon with the maximum width.
  3. Insert a memory card (see "8.1" on Page 56).
  4. Press the **menu** button.
  5. Select the **ASCII dump (Card)** function in the **Memory card** menu.
  6. Press the **↓** button.  
The index of the memory card is shown in the display.
  7. Select the desired label file in the index of the card with the **▲** and **▼** buttons.
  8. Start printout with the **↓** button.  
The data printout is started after four lines are received. For this reason, it is often necessary to call up the last few lines of a label description with the **feed** button.
- You can cancel the printout of the label description with the **cancel** button.

## 9 External keyboard

You can connect an external keyboard or compatible input device (e.g. barcode scanner) directly to the printer. Using an external keyboard facilitates the entry of variable data while processing print jobs and printing from the memory card.

Input prompts and the data received from the keyboard are shown in the display.

### 9.1 Connecting external keyboard

You can connect any MF-2-compatible USB keyboard which supports code set 3 to the printer.

⇒ Insert connection cable of the keyboard into the USB master interface on the back of the printer.

### 9.2 Special key functions

**General:**

[F1]	Executes the <b>Label from card</b> memory card function.
[F2]	Prints an additional label from the last print job. Corresponds to the command <b>A 1 CR</b> .
[F3]	Repeats the last print job with renewed polling of the variable data and polling of the label quantity.
[F8]	Functions in the same manner as <b>feed</b> .
[Enter]	Switches to the offline menu. Functions in the same manner as <b>menu</b> .
[Esc]	Functions in the same manner as <b>cancel</b> .
[Space]	Functions in the same manner as <b>pause</b> Not for continuing after an error.

**Tab. 25:** Special key functions: general

**In the offline menu and for entry of variable data:**

[←]	Moves cursor left. On the top level of the offline menu, switches back to <b>Ready</b> mode.
[→]	Moves cursor right.
[↑]	Increases the value at the cursor position.
[↓]	Decreases the value at the cursor position.
[Enter]	Confirms the input.
[Esc]	Cancels input and returns.

**Tab. 26:** Special key functions: offline menu and data input

### 9.3 Key assignment and special characters

The printer features a specific keyboard assignment table for each setting of the **Country** configuration parameter. These tables generally match the DOS keyboard assignments (see "Interfaces" on Page 25).

The [Alt Gr] key has no function. All special characters obtained using this key (e.g. [ ] { } \) and various other special characters (e.g. " × ÷) can be obtained using the [Alt] key. Additional special characters can be output using a sequence of two characters, whereby you must press the [Alt] key when entering the second character.

External keyboard

Some special characters cannot be shown in the display of the printer. In the case, they are replaced by a character similar to the special character.



When using a scanner ensure that the same character set is set for both the scanner and the printer.

**Country-specific special characters:**

The following country-specific special characters are entered with the [Alt] key pressed.

Character	[Alt] + key...												Character	[Alt]+...
€	E	E	E	E	E	E	E	E	E	E	E	E		č
{	7	'			ä	à	ç	7	8	'	7	B		ž
}	0	=			\$	\$	à	0	9	ç	0	N		á
[	8	(			ü	è	^	8	è	'	8	F		é
]	9	)			¨	¨	\$	9	+	+	9	G		'
\	B	-			<	<	<	+		°	<	Q		÷
	<	-	'		1	1	&	<		1	'	W		x
,										\	0			)
'			,	'	,	,	ù							đ
`		è					μ		'					Đ
^		ç					§							†
˘	^	^	6	6	\$	\$	²	\$	ì	<	½	;		‡
¨	.	é	.	.	^	^	=	¨	ù	4	¨	+		Ł
°			0	0				'	0	0				β
²	2								2					&
³	3								3					&
#		"			3	3	"		à	3		X		&
\$								4			4	Ů		<
¢					8	8								>
£								3			3			*
¤		\$										¨		-
@	q	à			2	2	é	2	ò	2	2	V		CZ
μ	m								m	m	m			
¬					6	6				6				
÷	/	/	/	/	/	/	/	/	/	/	/	/		
×	*	*	*	*	*	*	*	*	*	*	*	*		
	GR	FR	UK	US	SG	SF	BE	SU	IT	SP	DK	CZ		

Tab. 27: Country-specific special characters entered with the [Alt] key pressed.

**External keyboard**

<b>GR:</b> Deutschland	<b>SG:</b> Schweiz	<b>IT:</b> Italia
<b>FR:</b> France	<b>SF:</b> Suisse	<b>SP:</b> España
<b>UK:</b> United Kingdom	<b>BE:</b> Belgie	<b>DK:</b> Danmark
<b>US:</b> USA	<b>SU:</b> Suomi	<b>CZ:</b> Ceska republika

Characters between vertical lines (| / |, | \* |) are entered with the corresponding keys on the numerical keypad of the keyboard.

**Other special characters:**

A special character in the ZZ column can be entered by first entering the corresponding character in the Z1 column and then entering the character in the Z2 column while pressing the [Alt] button.

ZZ	Z1	Z2	ZZ	Z1	Z2	ZZ	Z1	Z2	ZZ	Z1	Z2
À	`	A	Ò	`	O	â	°	a	ò	`	o
Á	´	A	Ó	´	O	æ	a	e	ó	´	o
Â	^	A	Ô	^	O	ä	_	a	ô	^	o
Ã	~	A	Õ	~	O	ç	,	c	õ	~	o
Ä	¨	A	Ö	¨	O	ç		c	ö	¨	o
Å	°	A	Ø	/	O	č	ˇ	c	ø	/	o
Æ	A	E	Œ	O	E	d'	'	d	œ	o	e
Ç	,	C	Ř	ˇ	R	è	`	e	°	_	o
Ĉ	ˇ	C	Š	ˇ	S	é	´	e	í	´	r
D'	'	D	Û	`	U	ê	^	e	ř	ˇ	r
È	`	E	Ú	´	U	ë	¨	e	š	ˇ	s
É	´	E	Û	^	U	ě	ˇ	e	ß	s	s
Ê	^	E	Ü	¨	U	ì	`	i	t'	'	t
Ë	¨	E	Ý	´	Y	í	´	i	ù	`	u
Ì	`	I	Ÿ	-	Y	î	^	i	ú	´	u
Í	´	I	Ž	ˇ	Z	ï	¨	i	û	^	u
Î	^	I	à	`	a	ij	i	j	ü	¨	u
Ï	¨	I	á	´	a	l'	'	l	û	°	u
J		J	â	^	a	í	´	l	ý	´	y
£	-	L	ã	~	a	ñ	~	n	ÿ	¨	y
Ñ	~	N	ä	¨	a	ň	ˇ	n	ž	ˇ	z

**Tab. 28:** Special characters entered via a sequence of two characters

**Example:**

Entering the character: ñ            1st entry: [~]            2. entry: [Alt] + [n]



If necessary, use the information in Table 27 on Page 62 to enter the character Z1.

**Index****Index**

<b>A</b>	
Activating a PIN	27
Advance ribbon warning	23
Applicator	22
<b>B</b>	
Backfeed	23
Bootloader version	29, 38, 40, 47
Brightness	22
<b>C</b>	
Cleaning interval	53
CompactFlash	10, 49, 52, 56
Connecting computer	14
Contrast	22
Control characters	43
Cutter	10
<b>D</b>	
Date	21
Daylight saving	21
Debug mode	22
Device list	36, 42
Device names	53
Device settings	22
Direct programming	13, 43
<b>E</b>	
Ethernet	15, 25
Event list	47
External rewinder	10
<b>F</b>	
Firmware update	49, 55
Firmware version	29, 38, 40, 46, 47
Flash EPROM	48
Fonts	35, 41
FTP	54
FTP logon	54
<b>H</b>	
Heat level	23
<b>I</b>	
IFFS	48
Interfaces	25
<b>K</b>	
Key assignment	61
Key functions	61
Keyboard	10, 26, 61
<b>L</b>	
Label detection	45
Label format	12
Label sensor	23
Label software	13
Load printer configuration	52
Load settings	52
Local settings	21
LPD	16
<b>M</b>	
Memory card	10
Copy	59
Delete	60
Index	58
Print contents	60
Memory cards	
Formatting	57
Inserting	56
Load label	58
Writing	57
<b>N</b>	
Navigation	19
Number of labels	50
<b>O</b>	
OEM name	53
Operative time	50
Overview of types	6
<b>P</b>	
PC card	56
Peel-off module	10
Peel-off version	5
Pin assignment	15
Powersave mode	22
Print media	11
Print quality	44
Print services	16
Print speed	23
Printer driver	13
Printer setting	16
Printer website	28
Printhead cleaning	53
Printing intensity	23
Printing methods	11
Printing parameters	23
Product description	5
<b>R</b>	
Raw-IP	16
RS-232	14, 25
<b>S</b>	
Save printer configuration	52
Save settings	52
Select card slot	25
Select character set table	25
Serial interface	14
Service counter	50



**Index**

Setting label sensor ..... 51  
Shift print image ..... 22  
Short status ..... 38  
SNMP ..... 33  
Special characters ..... 61  
Standard version ..... 5  
Status ..... 29  
Status line ..... 26, 34  
Status print ..... 38  
SUB-D jack ..... 15  
System messages ..... 33

**T**

Tear-off mode ..... 23  
Time zone ..... 21  
Transfer printing ..... 23  
Transfer ribbon ..... 13

**U**

USB interface ..... 14, 17

**W**

Website ..... 28

