

### FEATURES

- RoHS compliant
- Efficiency up to 80%
- Power density up to 0.85W/cm<sup>3</sup>
- Wide temperature performance at full 1 Watt load, -40°C to 85°C
- Dual output from a single input rail
- UL 94V-0 package material
- No heatsink required
- Footprint from 1.17cm<sup>2</sup>
- Industry standard pinout
- Power sharing on output
- 1kVDC isolation
- 5V, 12V, & 15V input
- 5V, 9V, 12V and 15V output
- Internal SMD construction
- Fully encapsulated with toroidal magnetics
- No external components required
- MTTF up to 3.1 million hours
- No electrolytic or tantalum capacitors

### DESCRIPTION

The NMA series of industrial temperature range DC/DC converters are the standard building blocks for on-board distributed power systems. They are ideally suited for providing dual rail supplies on primarily digital boards with the added benefit of galvanic isolation to reduce switching noise. All of the rated power may be drawn from a single pin provided the total load does not exceed 1 watt.

### SELECTION GUIDE

Order Code	Nominal Input Voltage	Output Voltage	Output Current	Input Current at Rated Load	Efficiency	Isolation Capacitance	MTTF <sup>1</sup>	Package Style
	V	V	mA	mA	%	pF	kHrs	
NMA0505DC	5	±5	±100	289	69	28	3103	DIP
NMA0509DC	5	±9	±55	267	75	32	2257	
NMA0512DC	5	±12	±42	260	77	34	1579	
NMA0515DC	5	±15	±33	256	78	36	1065	
NMA0505SC	5	±5	±100	289	69	28	3103	SIP
NMA0509SC	5	±9	±55	267	75	32	2257	
NMA0512SC	5	±12	±42	260	77	34	1579	
NMA0515SC	5	±15	±33	256	78	36	1065	
NMA1205DC	12	±5	±100	120	69	33	2193	DIP
NMA1209DC	12	±9	±55	113	74	46	1734	
NMA1212DC	12	±12	±42	111	75	55	1303	
NMA1215DC	12	±15	±33	110	76	54	932	
NMA1205SC	12	±5	±100	120	69	33	2193	SIP
NMA1209SC	12	±9	±55	113	74	46	1734	
NMA1212SC	12	±12	±42	111	75	55	1303	
NMA1215SC	12	±15	±33	110	76	54	932	
NMA1505DC	15	±5	±100	91	71	39	1941	DIP
NMA1512DC	15	±12	±42	87	78	68	790	
NMA1515DC	15	±15	±33	84	80	84	523	
NMA1505SC	15	±5	±100	91	71	39	1941	SIP
NMA1512SC	15	±12	±42	87	78	68	790	
NMA1515SC	15	±15	±33	84	80	84	523	

When operated with additional external load capacitance the rise time of the input voltage will determine the maximum external capacitance value for guaranteed start up. The slower the rise time of the input voltage the greater the maximum value of the additional external capacitance for reliable start up.

### INPUT CHARACTERISTICS

Parameter	Conditions	Min.	Typ.	Max.	Units
Voltage range	Continuous operation, 5V input types	4.5	5	5.5	V
	Continuous operation, 12V input types	10.8	12	13.2	
	Continuous operation, 15V input types	13.5	15	16.5	
Reflected ripple current			20	40	mA p-p

### ABSOLUTE MAXIMUM RATINGS

Lead temperature 1.5mm from case for 10 seconds	300°C
Internal power dissipation	450mW
Input voltage V <sub>IN</sub> , NMA05 types	7V
Input voltage V <sub>IN</sub> , NMA12 types	15V
Input voltage V <sub>IN</sub> , NMA15 types	18V

1. Calculated using MIL-HDBK-217FN2 calculation model with nominal input voltage at full load.  
All specifications typical at T<sub>a</sub>=25°C, nominal input voltage and rated output current unless otherwise specified.



OUTPUT CHARACTERISTICS					
Parameter	Conditions	Min.	Typ.	Max.	Units
Rated Power <sup>1</sup>	T <sub>A</sub> =-40°C to 120°C			1	W
Voltage Set Point Accuracy	See tolerance envelope				
Line regulation	High V <sub>IN</sub> to low V <sub>IN</sub>		1.0	1.2	%/%
Load Regulation 10% load to rated load	5V & 12V input	5V output types	10	12.5	%
		9V output types	9	10	
		12V output types	6.5	7.5	
		15V output types	6	7.0	
	15V input	5V output types	5.5	10	
		12V output types	2.6	3.0	
Ripple and Noise <sup>2</sup>	BW=DC to 20MHz, 5V output types		10	20	mV p-p
	BW=DC to 20MHz, 9V output types		7	15	
	BW=DC to 20MHz, 12V output types		7.5	15	
	BW=DC to 20MHz, 15V output types		8	15	

ISOLATION CHARACTERISTICS					
Parameter	Conditions	Min.	Typ.	Max.	Units
Isolation test voltage	Flash tested for 1 second	1000			VDC
Resistance	Viso= 1000VDC		10		GΩ

GENERAL CHARACTERISTICS					
Parameter	Conditions	Min.	Typ.	Max.	Units
Switching frequency	5V input types		110		kHz
	12V input types		140		
	15V input types		90		

TEMPERATURE CHARACTERISTICS					
Parameter	Conditions	Min.	Typ.	Max.	Units
Specification	All output types	-40		85	°C
Storage		-50		130	
Case Temperature above ambient	0505, 1205		33		
	0509, 0512, 0515, 1209, 1212, 1215		28		
	1505		26		
	1512, 1515		17		
Cooling	Free air convection				

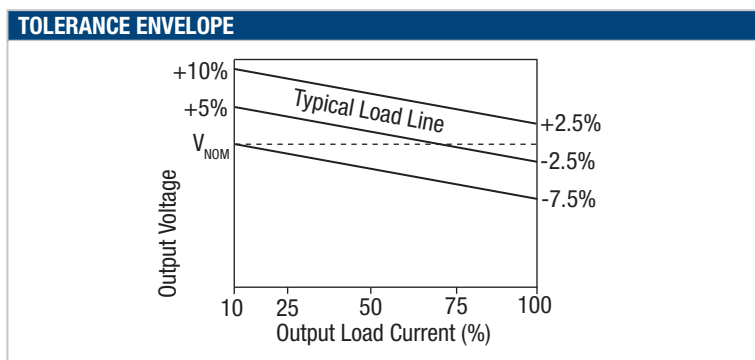
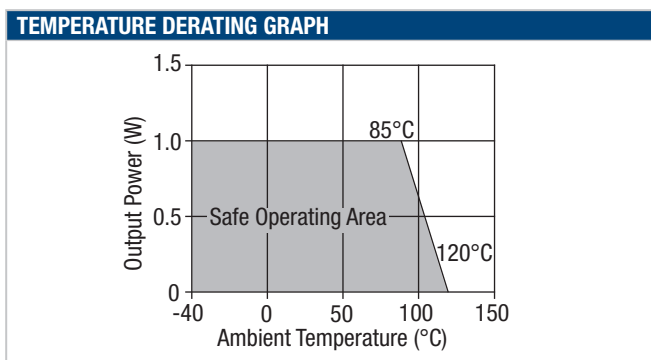

1. See derating graph.
2. See Ripple & Noise characterisation method.

### TECHNICAL NOTES

#### ISOLATION VOLTAGE

'Hi Pot Test', 'Flash Tested', 'Withstand Voltage', 'Proof Voltage', 'Dielectric Withstand Voltage' & 'Isolation Test Voltage' are all terms that relate to the same thing, a test voltage, applied for a specified time, across a component designed to provide electrical isolation, to verify the integrity of that isolation.

Murata Power Solutions NMA series of DC/DC converters are all 100% production tested at their stated isolation voltage. This is 1kVDC for 1 second.

A question commonly asked is, "What is the continuous voltage that can be applied across the part in normal operation?"

For a part holding no specific agency approvals, such as the NMA series, both input and output should normally be maintained within SELV limits i.e. less than 42.4V peak, or 60VDC. The isolation test voltage represents a measure of immunity to transient voltages and the part should never be used as an element of a safety isolation system. The part could be expected to function correctly with several hundred volts offset applied continuously across the isolation barrier; but then the circuitry on both sides of the barrier must be regarded as operating at an unsafe voltage and further isolation/insulation systems must form a barrier between these circuits and any user-accessible circuitry according to safety standard requirements.

#### REPEATED HIGH-VOLTAGE ISOLATION TESTING

It is well known that repeated high-voltage isolation testing of a barrier component can actually degrade isolation capability, to a lesser or greater degree depending on materials, construction and environment. The NMA series has toroidal isolation transformers, with no additional insulation between primary and secondary windings of enameled wire. While parts can be expected to withstand several times the stated test voltage, the isolation capability does depend on the wire insulation. Any material, including this enamel (typically polyurethane) is susceptible to eventual chemical degradation when subject to very high applied voltages thus implying that the number of tests should be strictly limited. We therefore strongly advise against repeated high voltage isolation testing, but if it is absolutely required, that the voltage be reduced by 20% from specified test voltage.

This consideration equally applies to agency recognized parts rated for better than functional isolation where the wire enamel insulation is always supplemented by a further insulation system of physical spacing or barriers.

### OUTPUT RIPPLE REDUCTION

By using the values of inductance and capacitance stated, the output ripple at the rated load is lowered to 5mV p-p max.

#### Component selection

**Capacitor:** Ceramic chip capacitors are recommended. It is required that the ESR (Equivalent Series Resistance) should be as low as possible, X7R types are recommended. The voltage rating should be at least twice (except for 15V output), the rated output voltage of the DC/DC converter.

**Inductor:** The rated current of the inductor should not be less than that of the output of the DC/DC converter. At the rated current, the DC resistance of the inductor should be such that the voltage drop across the inductor is <2% of the rated voltage of the DC/DC converter. The SRF (Self Resonant Frequency) should be >20MHz.

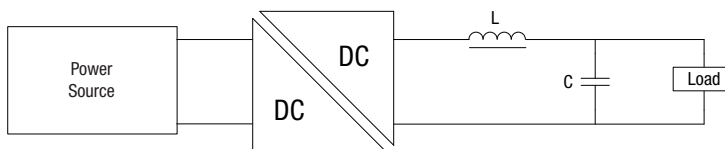

Order Code	L (µH)	Inductor Order Codes		C (µF)
		SMD	Through Hole	
NMA0505XC	22	82223C	22R223C	2.20
NMA0509XC	100	82104C	22R104C	0.47
NMA0512XC	150	82154C	22R154C	0.33
NMA0515XC	470	82474C	22R474C	0.22
NMA1205XC	22	82223C	22R223C	2.20
NMA1209XC	47	82473C	22R473C	1.00
NMA1212XC	150	82154C	22R154C	0.33
NMA1215XC	220	82224C	22R224C	1.00
NMA1505XC				
NMA1512XC				
NMA1515XC	220	82224C	22R224C	2.20

Product specification for MPS inductors can be found at:

2200R Series (Through Hole) [http://www.murata-ps.com/data/magnetics/kmp\\_2200r.pdf](http://www.murata-ps.com/data/magnetics/kmp_2200r.pdf)

8200 Series (SMD) [http://www.murata-ps.com/data/magnetics/kmp\\_8200c.pdf](http://www.murata-ps.com/data/magnetics/kmp_8200c.pdf)

### CHARACTERISATION TEST METHODS

#### Ripple & Noise Characterisation Method

Ripple and noise measurements are performed with the following test configuration.

C1	1 $\mu$ F X7R multilayer ceramic capacitor, voltage rating to be a minimum of 3 times the output voltage of the DC/DC converter
C2	10 $\mu$ F tantalum capacitor, voltage rating to be a minimum of 1.5 times the output voltage of the DC/DC converter with an ESR of less than 100m $\Omega$ at 100 kHz
C3	100nF multilayer ceramic capacitor, general purpose
R1	450 $\Omega$ resistor, carbon film, +/-1% tolerance
R2	50 $\Omega$ BNC termination
T1	3T of the coax cable through a ferrite toroid
RLOAD	Resistive load to the maximum power rating of the DC/DC converter. Connections should be made via twisted wires
R3	50 $\Omega$ resistor, carbon film, +/-1%

Measured values are multiplied by 10 to obtain the specified values.

#### Differential Mode Noise Test Schematic

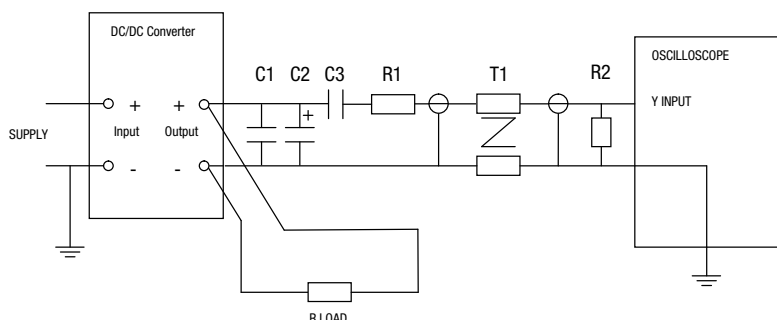

### PACKAGE SPECIFICATIONS

#### MECHANICAL DIMENSIONS

##### DIP package

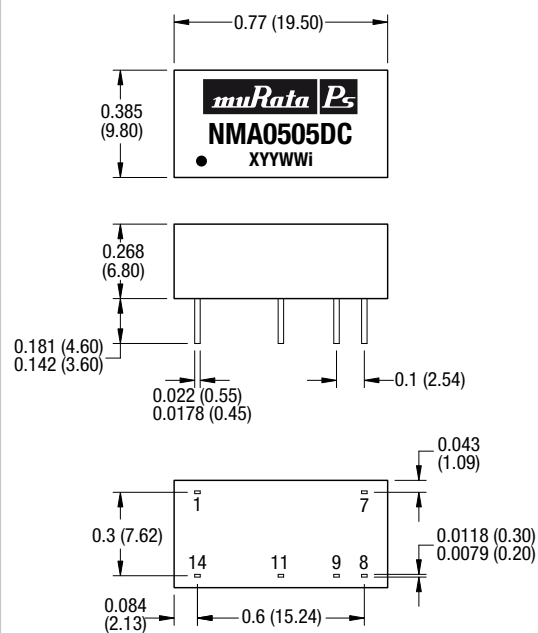

##### SIP package

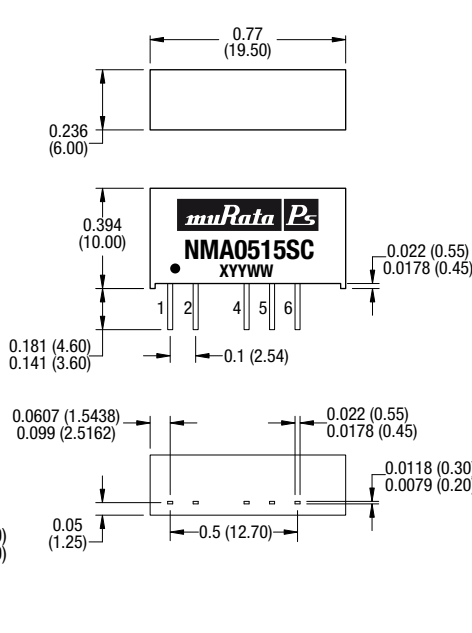

All dimensions in inches  $\pm 0.01$  (mm  $\pm 0.25$ mm). All pins on a 0.1 (2.54) pitch and within  $\pm 0.01$  (0.25) of true position.

Weight: 2.4g (DIP) 2.1g (SIP)

#### PIN CONNECTIONS - 14 PIN DIP

Pin	Function
1	-VIN
7	NC
8	OV
9	+VOUT
11	-VOUT
14	+VIN

#### PIN CONNECTIONS - 7 PIN SIP

Pin	Function
1	+VIN
2	-VIN
4	-VOUT
5	OV
6	+VOUT

### PACKAGE SPECIFICATIONS (continued)

#### RECOMMENDED FOOTPRINT DETAILS

14 Pin DIP Package

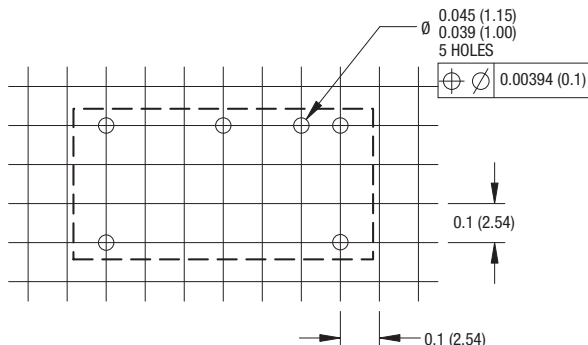

7 Pin SIP Package

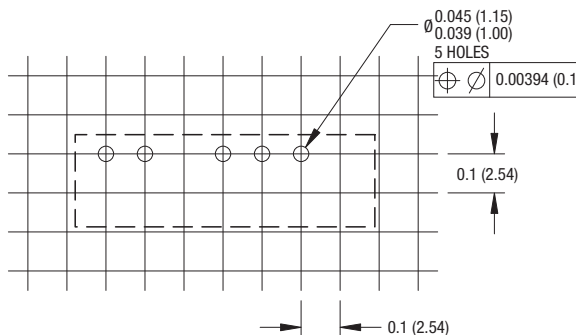

#### TUBE OUTLINE DIMENSIONS

14 Pin DIP Tube

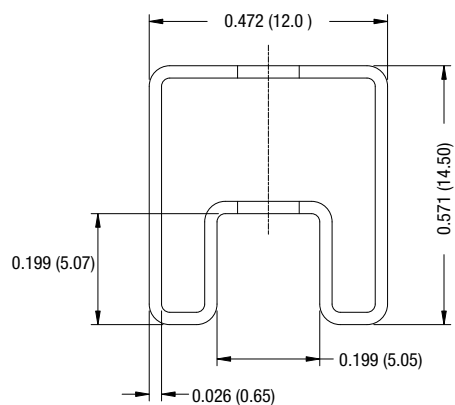

7 Pin SIP Tube

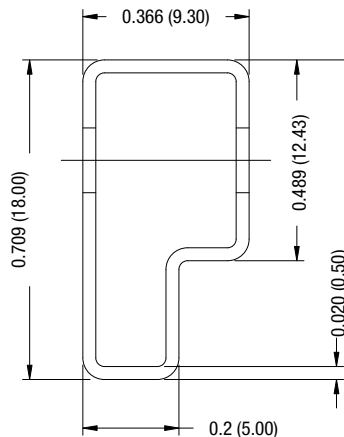

Unless otherwise stated all dimensions in inches (mm)  $\pm 0.5$ mm.  
Tube length (14 Pin DIP) : 20.47 (520mm  $\pm 2$ mm).  
Tube length (7 Pin SIP) : 20.47 (520mm  $\pm 2$ mm).

Tube Quantity : 25

### RoHS COMPLIANT INFORMATION



This series is compatible with RoHS soldering systems with a peak wave solder temperature of 300°C for 10 seconds. The pin termination finish on the SIP package type is Tin Plate, Hot Dipped over Matte Tin with Nickel Preplate. The DIP types are Matte Tin over Nickel Preplate. Both types in this series are backward compatible with Sn/Pb soldering systems.

For further information, please visit [www.murata-ps.com/rohs](http://www.murata-ps.com/rohs)