

Features

- Step-down buck regulators for new distributed 12V power architectures
- 12V input (10.8-13.2V range)
- 1 to 5V_{OUT} @ 10A
- Non-isolated, fixed-frequency, synchronous-rectifier topology
- Outstanding performance:
 - ±1.25% setpoint accuracy
 - Efficiencies to 96% @ 10 Amps
 - Noise as low as 30mVp-p
 - Stable no-load operation
 - Trimmable output voltage
- Remote on/off control
- Sense pin on standard models
- Thermal shutdown
- No derating to +68°C with 100 lfm
- UL/IEC/EN60950 certified
- EMC compliant

LSN Series D12 SIP's (single-in-line packages) are ideal building blocks for emerging, on-board power-distribution schemes in which isolated 12V buses deliver power to any number of non-isolated, step-down buck regulators. LSN D12 DC/DC's accept a 12V input (10.8V to 13.2V input range) and convert it, with the highest efficiency in the smallest space, to a 1, 1.1, 1.2, 1.3, 1.5, 1.8, 2, 2.5, 3.3 or 5 Volt output fully rated at 10 Amps.

LSN D12's are ideal point-of-use/load power processors. They typically require no external components. Their vertical-mount packages occupy a mere 0.7 square inches (4.5 sq. cm), and reversed pin vertical mount allows mounting to meet competitor's keep out area. Horizontal-mount packages ("H" suffix) are only 0.34 inches (8.6mm) high.

The LSN's best-in-class power density is achieved with a fully synchronous, fixed-frequency, buck topology that also delivers: high efficiency (96% for 5V_{OUT} models), low noise (30 to 50mVp-p typ.), tight line/load regulation (±0.1%/±0.25% max.), quick step response (100µsec), stable no-load operation, and no output reverse conduction.

The fully functional LSN's feature output overcurrent detection, continuous short-circuit protection, an output-voltage trim function, a remote on/off control pin (pull high to disable), thermal shutdown and a sense pin. High efficiency enables the LSN D12's to deliver rated output currents of 10 Amps at ambient temperatures to +68°C with 100 lfm air flow.

If your new system boards call for three or more supply voltages, check out the economics of on-board 12V distributed power. If you don't need to pay for multiple isolation barriers, DATEL's non-isolated LSN D12 SIP's will save you money.

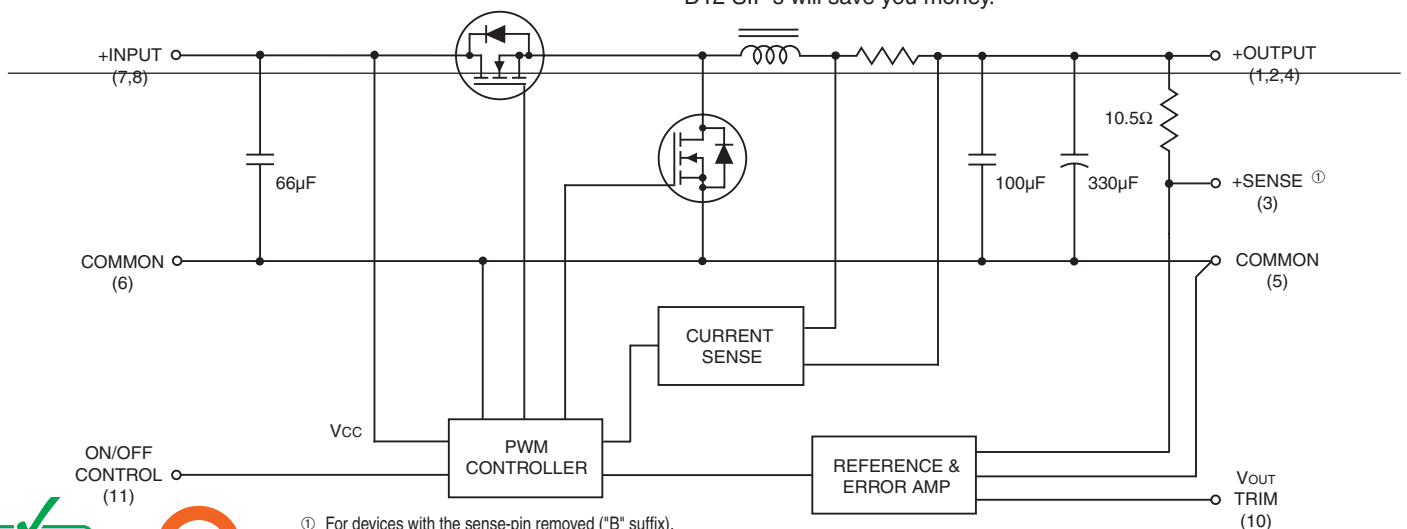

① For devices with the sense-pin removed ("B" suffix), the feedback path is through the +Output pin and not the +Sense pin.

Typical topology is shown

Figure 1. Simplified Schematic



For full details go to www.murata-ps.com/rohs

Performance Specifications and Ordering Guide ^①

Root Model ^⑤	Output						Input			Efficiency			Package (Case, Pinout)
	V _{OUT} (Volts)	I _{OUT} (Amps)	R/N (mVp-p) ^②		Regulation (Max.) ^③		V _{IN} Nom. (Volts)	Range (Volts)	I _{IN} ^④ (mA/A)	Full Load		½ Load	
			Typ.	Max.	Line	Load				Min.	Typ.		
LSN-1/10-D12	1	10	45	65	±0.1%	±0.25%	12	10.8-13.2	39/1.02	83%	86%	86%	B5/B5x, P59
LSN-1.1/10-D12	1.1	10	45	60	±0.1%	±0.25%	12	10.8-13.2	45/1.1	85%	88%	87.5%	B5/B5x, P59
LSN-1.2/10-D12	1.2	10	45	60	±0.1%	±0.25%	12	10.8-13.2	45/1.19	85%	88%	87.5%	B5/B5x, P59
LSN-1.3/10-D12	1.3	10	45	60	±0.1%	±0.25%	12	10.8-13.2	45/1.3	85%	88%	87.5%	B5/B5x, P59
LSN-1.5/10-D12	1.5	10	30	45	±0.1%	±0.25%	12	10.8-13.2	54/1.47	86%	89%	88%	B5/B5x, P59
LSN-1.8/10-D12	1.8	10	30	45	±0.1%	±0.25%	12	10.8-13.2	53/1.75	87%	90.5%	89.5%	B5/B5x, P59
LSN-2/10-D12	2	10	30	45	±0.1%	±0.25%	12	10.8-13.2	59/1.9	88.5%	91%	90%	B5/B5x, P59
LSN-2.5/10-D12	2.5	10	35	50	±0.1%	±0.25%	12	10.8-13.2	60/2.3	90.5%	92.5%	92%	B5/B5x, P59
LSN-3.3/10-D12	3.3	10	40	55	±0.1%	±0.25%	12	10.8-13.2	69/3	92.5%	94%	93.5%	B5/B5x, P59
LSN-3.8/10-D12	3.8	10	40	55	±0.1%	±0.25%	12	10.8-13.2	69/3.33	93%	95%	N/A	B5/B5x, P59
LSN-5/10-D12	5	10	50	75	±0.1%	±0.25%	12	10.8-13.2	75/4.5	94%	96%	95.5%	B5/B5x, P59

- ① Typical at T_A = +25°C under nominal line voltage and full-load conditions, unless noted. All models are tested and specified with external 22µF tantalum input and output capacitors. The capacitors are necessary to accommodate our test equipment and may not be required to achieve specified performance in your applications. See I/O Filtering and Noise Reduction.
- ② Ripple/Noise (R/N) is tested/specified over a 20MHz bandwidth and may be reduced with external filtering. See I/O Filtering and Noise Reduction for details.

- ③ These devices have no minimum-load requirements and will regulate under no-load conditions. Regulation specifications describe the output-voltage deviation as the line voltage or load is varied from its nominal/midpoint value to either extreme.
- ④ Nominal line voltage, no-load/full-load conditions.
- ⑤ These are not complete model numbers. Please refer to the Part Number Structure when ordering.

PART NUMBER STRUCTURE

LSN-1.8/10-D12BHJ-C

Output Configuration:
L = Unipolar Low Voltage

Non-Isolated SIP

Nominal Output Voltage:
1, 1.1, 1.2, 1.3, 1.5, 1.8, 2, 2.5, 3.3 or 5 Volts

Maximum Rated Output Current in Amps

RoHS-6 compliant*

J Suffix:
Reversed Pin Vertical Mount

H Suffix:
Horizontal Mount

B Suffix:
No Remote Sense (Pin 3 removed)

Input Voltage Range:
D12 = 10.8 to 13.2 Volts (12V nominal)

* Contact Murata Power Solutions Technologies (DATEL) for availability.

Note: Not all model number combinations are available. Contact Murata Power Solutions

MECHANICAL SPECIFICATIONS

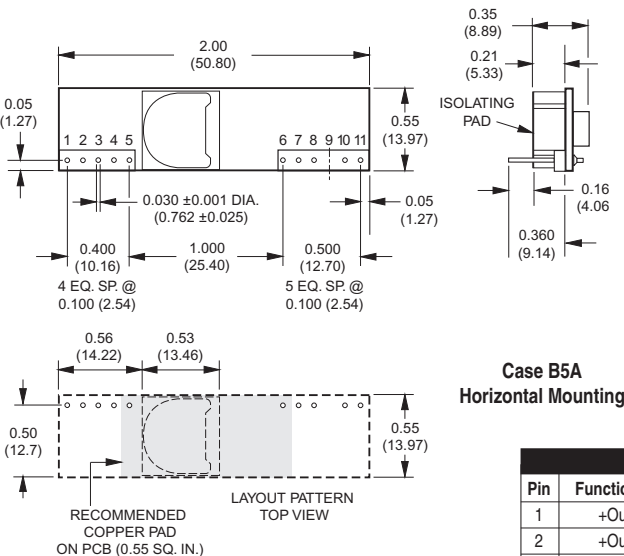
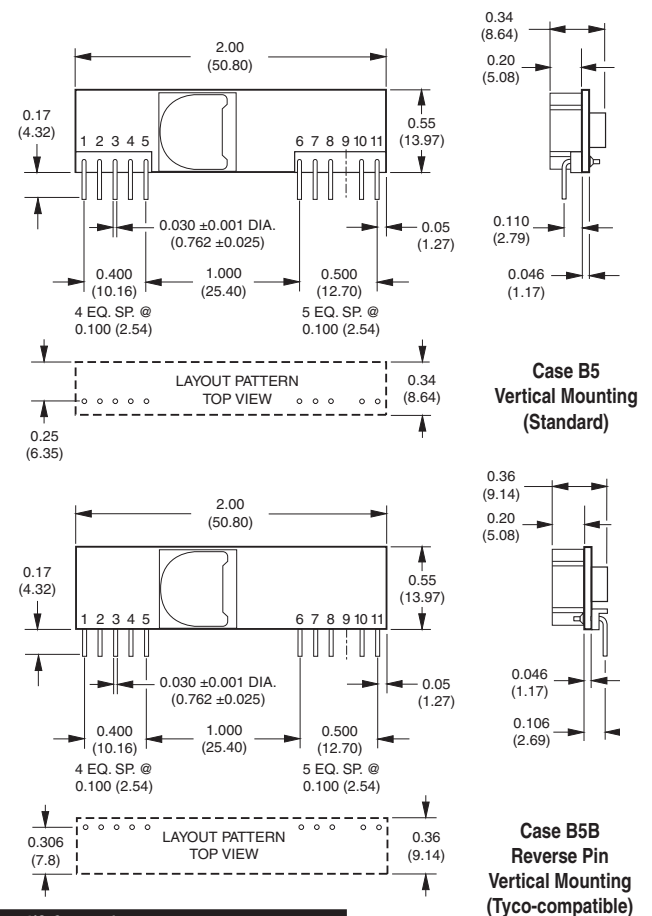

I/O Connections					
Pin	Function P59*	Pin	Function P59*	Pin	Function P59*
1	+Output	5	Common	9	No Pin
2	+Output	6	Common	10	V _{OUT} Trim
3	+Sense *	7	+Input	11	On/Off Control
4	+Output	8	+Input		

* Pin 3 (+Sense) removed for "B" suffix models.

DIMENSIONS IN INCHES (mm)

Performance/Functional Specifications

Typical @ TA = +25°C under nominal line voltage and full-load conditions unless noted. ①

Input	
Input Voltage Range	10.8-13.2 Volts (12V nominal)
Input Current:	
Normal Operating Conditions	See Ordering Guide
Inrush Transient	0.08A ² sec
Standby/Off Mode	8mA
Output Short-Circuit Condition ②	40mA average
Input Reflected Ripple Current ②	100mA _{p-p}
Input Filter Type	Capacitive (66µF)
Overvoltage Protection	None
Reverse-Polarity Protection	None
Undervoltage Shutdown	None
On/Off Control ② ③	On = open (internal pull-down) Off = +2.8V to +VIN (<3mA)
Output	
V_{OUT} Accuracy (50% load)	±1.25% maximum
Minimum Loading ①	No load
Maximum Capacitive Load	2000µF (low ESR, OSCON)
V_{OUT} Trim Range ②	±10%
Ripple/Noise (20MHz BW) ① ② ④	See Ordering Guide
Total Accuracy	3% over line/load/temperature
Efficiency ②	See Ordering Guide
Overcurrent Detection and Short-Circuit Protection: ②	
Current-Limiting Detection Point	17 (13-23.5) Amps
Short-Circuit Detection Point	98% of V _{OUT} set
SC Protection Technique	Hiccup with auto recovery
Short-Circuit Current	400mA average
Dynamic Characteristics	
Transient Response (50% load step)	100µsec to ±2% of final value
Start-Up Time: ②	
V _{IN} to V _{OUT} and On/Off to V _{OUT}	70msec for V _{OUT} = 1V 16msec for V _{OUT} = 1.1V to 5V
Switching Frequency:	
1V/1.1V, 1.2V, 1.3 Models	105/125kHz ±10%
1.5V/1.8V, 2V Models	160/177kHz ±10%
2.5V, 3.3V, 5V Models	200kHz ±7.5%
Environmental	
Calculated MTBF ⑤	2.3-1.8 million hours (1V _{OUT} to 5V _{OUT})
Operating Temperature: (Ambient) ②	
Without Derating (Natural convection)	-40 to +48/64°C (model dependent)
With Derating	See Derating Curves
Thermal Shutdown	+115°C
Physical	
Dimensions	See Mechanical Specifications
Pin Dimensions/Material	0.03" (0.76mm) round copper alloy with tin plate over nickel underplate
Weight	0.3 ounces (8.5g)
Flamability Rating	UL94V-0
Safety	UL/cUL/IEC/EN 60950, CSA-C22.2 No. 234

① All models are tested/specified with external 22µF input/output capacitors. These caps accommodate our test equipment and may not be required to achieve specified performance in your applications. All models are stable and regulate within spec under no-load conditions.

② See Technical Notes and Performance Curves for details.

③ The On/Off Control (pin 11) is designed to be driven with open-collector logic or the application of appropriate voltages (referenced to Common, pins 5 and 6).

④ Output noise may be further reduced with the installation of additional external output filtering. See I/O Filtering and Noise Reduction.

⑤ MTBF's are calculated using Telcordia SR-332(Bellcore), ground fixed, TA = +25°C, full power, natural convection, +67°C pcb temperature.

Absolute Maximum Ratings

Input Voltage:	
Continuous or transient	15 Volts
On/Off Control (Pin 11)	+VIN
Input Reverse-Polarity Protection	None
Output Overvoltage Protection	None
Output Current	Current limited. Devices can withstand sustained output short circuits without damage.
Storage Temperature	-40 to +125°C
Lead Temperature (soldering, 10 sec.)	+300°C
These are stress ratings. Exposure of devices to any of these conditions may adversely affect long-term reliability. Proper operation under conditions other than those listed in the Performance/Functional Specifications Table is not implied.	

TECHNICAL NOTES

Return Current Paths

The LSN D12 SIP's are non-isolated DC/DC converters. Their two Common pins (pins 5 and 6) are connected to each other internally (see Figure 1). To the extent possible (with the intent of minimizing ground loops), input return current should be directed through pin 6 (also referred to as -Input or Input Return), and output return current should be directed through pin 5 (also referred to as -Output or Output Return). Any on/off control signals applied to pin 11 (On/Off Control) should be referenced to Common (specifically pin 6).

I/O Filtering and Noise Reduction

All models in the LSN D12 Series are tested and specified with external 22µF tantalum input and output capacitors. These capacitors are necessary to accommodate our test equipment and may not be required to achieve desired performance in your application. The LSN D12's are designed with high-quality, high-performance *internal* I/O caps, and will operate within spec in most applications with *no additional external components*.

In particular, the LSN D12's input capacitors are specified for low ESR and are fully rated to handle the units' input ripple currents. Similarly, the internal output capacitors are specified for low ESR and full-range frequency response. As shown in the Performance Curves, removal of the external 22µF tantalum output caps has minimal effect on output noise.

In critical applications, input/output ripple/noise may be further reduced using filtering techniques, the simplest being the installation of external I/O caps.

External input capacitors serve primarily as energy-storage devices. They minimize high-frequency variations in input voltage (usually caused by IR drops in conductors leading to the DC/DC) as the switching converter draws pulses of current. Input capacitors should be selected for bulk capacitance (at appropriate frequencies), low ESR, and high rms-ripple-current ratings. The switching nature of modern DC/DC's requires that the dc input voltage source have low ac impedance at the frequencies of interest. Highly inductive source impedances can greatly affect system stability. Your specific system configuration may necessitate additional considerations.

Output ripple/noise (also referred to as periodic and random deviations or PARD) may be reduced below specified limits with the installation of additional external output capacitors. Output capacitors function as true filter

elements and should be selected for bulk capacitance, low ESR, and appropriate frequency response. Any scope measurements of PARD should be made directly at the DC/DC output pins with scope probe ground less than 0.5" in length.

All external capacitors should have appropriate voltage ratings and be located as close to the converters as possible. Temperature variations for all relevant parameters should be taken into consideration.

The most effective combination of external I/O capacitors will be a function of your line voltage and source impedance, as well as your particular load and layout conditions. Our Applications Engineers can recommend potential solutions and discuss the possibility of our modifying a given device's internal filtering to meet your specific requirements. Contact our Applications Engineering Group for additional details.

Input Fusing

Most applications and or safety agencies require the installation of fuses at the inputs of power conversion components. LSN D12 Series DC/DC converters are not internally fused. Therefore, if input fusing is mandatory, either a normal-blow or a slow-blow fuse with a value no greater than 9 Amps should be installed within the ungrounded input path to the converter.

As a rule of thumb however, we recommend to use a normal-blow or slow-blow fuse with a typical value of about twice the maximum input current, calculated at low line with the converters minimum efficiency.

Safety Considerations

LSN D12 SIP's are non-isolated DC/DC converters. In general, all DC/DC's must be installed, including considerations for I/O voltages and spacing/separation requirements, in compliance with relevant safety-agency specifications (usually UL/IEC/EN60950).

In particular, for a non-isolated converter's output voltage to meet SELV (safety extra low voltage) requirements, its input must be SELV compliant. If the output needs to be ELV (extra low voltage), the input must be ELV.

Input Overvoltage and Reverse-Polarity Protection

LSN D12 SIP Series DC/DC's do not incorporate either input overvoltage or input reverse-polarity protection. Input voltages in excess of the specified absolute maximum ratings and input polarity reversals of longer than "instantaneous" duration can cause permanent damage to these devices.

Start-Up Time

The VIN to VOUT Start-Up Time is the interval between the time at which a ramping input voltage crosses the lower limit of the specified input voltage range (10.8 Volts) and the fully loaded output voltage enters and remains within its specified accuracy band. Actual measured times will vary with input source impedance, external input capacitance, and the slew rate and final value of the input voltage as it appears to the converter.

The On/Off to VOUT Start-Up Time assumes the converter is turned off via the On/Off Control with the nominal input voltage already applied to the converter. The specification defines the interval between the time at which the converter is turned on and the fully loaded output voltage enters and remains within its specified accuracy band. See Typical Performance Curves.

Remote Sense

LSN D12 SIP Series DC/DC converters offer an output sense function on pin 3. The sense function enables point-of-use regulation for overcoming moderate IR drops in conductors and/or cabling. Since these are non-isolated devices whose inputs and outputs usually share the same ground plane, sense is provided only for the +Output.

The remote sense line is part of the feedback control loop regulating the DC/DC converter's output. The sense line carries very little current and consequently requires a minimal cross-sectional-area conductor. As such, it is not a low-impedance point and must be treated with care in layout and cabling. Sense lines should be run adjacent to signals (preferably ground), and in cable and/or discrete-wiring applications, twisted-pair or similar techniques should be used. To prevent high frequency voltage differences between VOUT and Sense, we recommend installation of a 1000pF capacitor close to the converter.

The sense function is capable of compensating for voltage drops between the +Output and +Sense pins that do not exceed 10% of VOUT.

$$[V_{OUT(+)} - \text{Common}] - [Sense(+) - \text{Common}] \leq 10\%V_{OUT}$$

Power derating (output current limiting) is based upon maximum output current and voltage at the converter's output pins. Use of trim and sense functions can cause the output voltage to increase, thereby increasing output power beyond the LSN's specified rating. Therefore:

$$(V_{OUT \text{ at pins}}) \times (I_{OUT}) \leq \text{rated output power}$$

The internal 10.5Ω resistor between +Sense and +Output (see Figure 1) serves to protect the sense function by limiting the output current flowing through the sense line if the main output is disconnected. It also prevents output voltage runaway if the sense connection is disconnected.

Note: Connect the +Sense pin (pin 3) to +Output (pin 4) at the DC/DC converter pins, if the sense function is not used for remote regulation.

On/Off Control and Power-up Sequencing

The On/Off Control pin may be used for remote on/off operation. LSN D12 SIP Series DC/DC's are designed so they are enabled when the control pin is left open (internal pull-down to Common) and disabled when the control pin is pulled high (+2.8V to +VIN), as shown in Figure 2 and 2a.

Dynamic control of the on/off function is best accomplished with a mechanical relay or open-collector/open-drain drive circuit. The drive circuit should be able to sink appropriate current when activated and withstand appropriate voltage when deactivated.

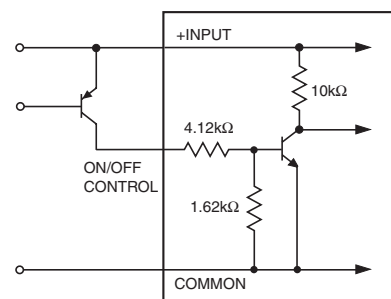

Figure 2. Driving the On/Off Control Pin with an Open-Collector Drive Circuit

The on/off control function, however, can be externally inverted so that the converter will be disabled while the input voltage is ramping up and then "released" once the input has stabilized.

For a controlled start-up of one or more LSN-D12's, or if several output voltages need to be powered-up in a given sequence, the On/Off Control pin can be pulled high (external pull-up resistor, converter disabled) and then driven low with an external open collector device to enable the converter.

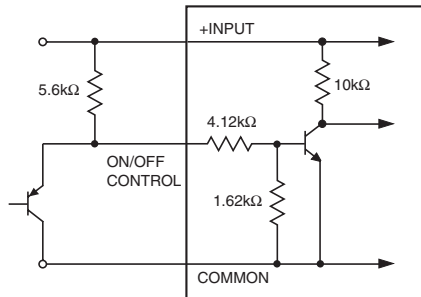

Figure 2a. Inverting On/Off Control Pin Signal and Power-Up Sequencing

Output Overvoltage Protection

LSN D12 SIP Series DC/DC converters do not incorporate output overvoltage protection. In the extremely rare situation in which the device's feedback loop is broken, the output voltage may run to excessively high levels ($V_{OUT} = V_{IN}$). If it is absolutely imperative that you protect your load against any and all possible overvoltage situations, voltage limiting circuitry must be provided external to the power converter.

Output Overcurrent Detection

Overloading the output of a power converter for an extended period of time will invariably cause internal component temperatures to exceed their maximum ratings and eventually lead to component failure. High-current-carrying components such as inductors, FET's and diodes are at the highest risk. LSN D12 SIP Series DC/DC converters incorporate an output overcurrent detection and shutdown function that serves to protect both the power converter and its load.

If the output current exceeds its maximum rating by typically 70% (17 Amps) or if the output voltage drops to less than 98% of its original value, the LSN D12's internal overcurrent-detection circuitry immediately turns off the converter, which then goes into a "hiccup" mode. While hiccupping, the converter will continuously attempt to restart itself, go into overcurrent, and then shut down. Under these conditions, the average output current will be approximately 400mA, and the average input current will be approximately 40mA. Once the output short is removed, the converter will automatically restart itself.

Output Voltage Trimming

Allowable trim ranges for each model in the LSN D12 SIP Series are $\pm 10\%$. Trimming is accomplished with either a trimpot or a single fixed resistor. The trimpot should be connected between +Output and Common with its wiper connected to the Trim pin as shown in Figure 3 below.

A trimpot can be used to determine the value of a single fixed resistor which can then be connected, as shown in Figure 4, between the Trim pin and +Output to trim down the output voltage, or between the Trim pin and Common to trim up the output voltage. Fixed resistors should have absolute TCR's less than 100ppm/°C to ensure stability.

The equations below can be used as starting points for selecting specific trim-resistor values. Recall, untrimmed devices are guaranteed to be $\pm 1\%$ accurate.

Adjustment beyond the specified $\pm 10\%$ adjustment range is not recommended.

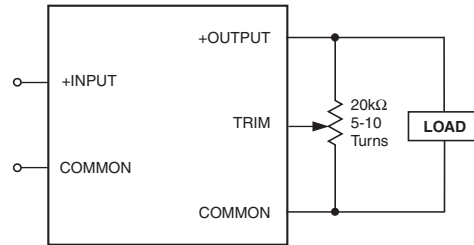
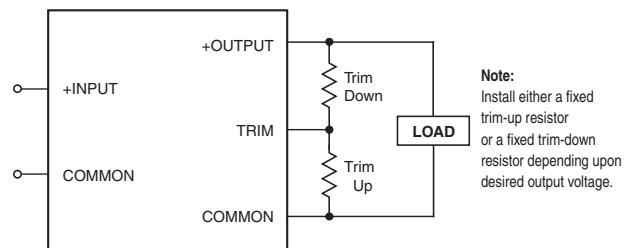

Figure 3. Trim Connections Using a Trimpot



Note:
Install either a fixed trim-up resistor or a fixed trim-down resistor depending upon desired output voltage.

Figure 4. Trim Connections Using Fixed Resistors

Trim Equations

$$R_{T_DOWN} (k\Omega) = \frac{1.82(V_O - 0.8)}{V_{O_NOM} - V_O} - X$$

$$R_{T_UP} (k\Omega) = \frac{1.46}{V_O - V_{O_NOM}} - X$$

LSN-1/10-D12: X = 0.909

LSN-1.1/10-D12: X = 2.49

LSN-1.2/10-D12: X = 3.09

LSN-1.3/10-D12: X = 4.12

$$R_{T_DOWN} (k\Omega) = \frac{4.64(V_O - 0.8)}{V_{O_NOM} - V_O} - X$$

$$R_{T_UP} (k\Omega) = \frac{3.72}{V_O - V_{O_NOM}} - X$$

LSN-1.5/10-D12: X = 13.3

LSN-1.8/10-D12: X = 16.9

LSN-2/10-D12: X = 15.4

$$R_{T_DOWN} (k\Omega) = \frac{7.5(V_O - 0.8)}{V_{O_NOM} - V_O} - X$$

$$R_{T_UP} (k\Omega) = \frac{6}{V_O - V_{O_NOM}} - X$$

LSN-2.5/10-D12: X = 20

LSN-3.3/10-D12: X = 15

LSN-5/10-D12: X = 10

Note: Resistor values are in kΩ. Accuracy of adjustment is subject to tolerances of resistors and factory-adjusted, initial output accuracy.

V_O = desired output voltage. V_{O_NOM} = nominal output voltage.

Output Reverse Conduction

Many DC/DC's using synchronous rectification suffer from Output Reverse Conduction. If those devices have a voltage applied across their output before a voltage is applied to their input (this typically occurs when another power supply starts before them in a power-sequenced application), they will either fail to start or self destruct. In both cases, the cause is the "freewheeling" or "catch" FET biasing itself on and effectively becoming a short circuit.

LSN D12 SIP DC/DC converters are not damaged from Output Reverse Conduction. They employ proprietary gate drive circuitry which makes them immune to applied voltages during the startup sequence. If you are using an external power source paralleled with the LSN, be aware that during the start up phase, some low impedance condition or transient current may be absorbed briefly into the LSN output terminals before voltage regulation is fully established. You should insure that paralleled external power sources are not disrupted by this condition during LSN start up.

Thermal Considerations and Thermal Protection

The typical output-current thermal-derating curves shown below enable designers to determine how much current they can reliably derive from each model of the LSN D12 SIP's under known ambient-temperature and air-flow conditions. Similarly, the curves indicate how much air flow is required to reliably deliver a specific output current at known temperatures.

The highest temperatures in LSN D12 SIP's occur at their output inductor, whose heat is generated primarily by I²R losses. The derating curves were developed using thermocouples to monitor the inductor temperature and

varying the load to keep that temperature below +110°C under the assorted conditions of air flow and air temperature. Once the temperature exceeds +115°C (approx.), the thermal protection will disable the converter. Automatic restart occurs after the temperature has dropped below +110°C.

All but the last two DUT's were vertical-mount models, and the direction of air flow was parallel to the unit in the direction from pin 11 to pin 1.

As you may deduce from the derating curves and observe in the efficiency curves on the following pages, LSN D12 SIP's maintain virtually constant efficiency from half to full load, and consequently deliver very impressive temperature performance even if operating at full load.

Lastly, when LSN D12 SIP's are installed in system boards, they are obviously subject to numerous factors and tolerances not taken into account here. If you are attempting to extract the most current out of these units under demanding temperature conditions, we advise you to monitor the output-inductor temperature to ensure it remains below +110°C at all times.

Thermal Performance for "H" Models

Enhanced thermal performance can be achieved when LSN D12 SIP's are mounted horizontally ("H" models) and the output inductor (with its electrically isolating, thermally conductive pad installed) is thermally coupled to a copper plane/pad (at least 0.55 square inches in area) on the system board. Your conditions may vary, however our tests indicate this configuration delivers a 16°C to 22°C improvement in ambient operating temperatures. See page 9 for thermal comparison of two horizontally mounted units.

Typical Performance Curves for LSN D12 SIP Series

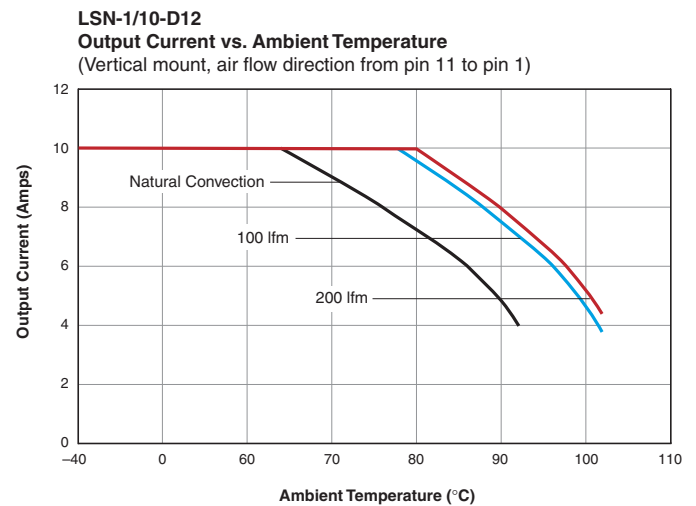
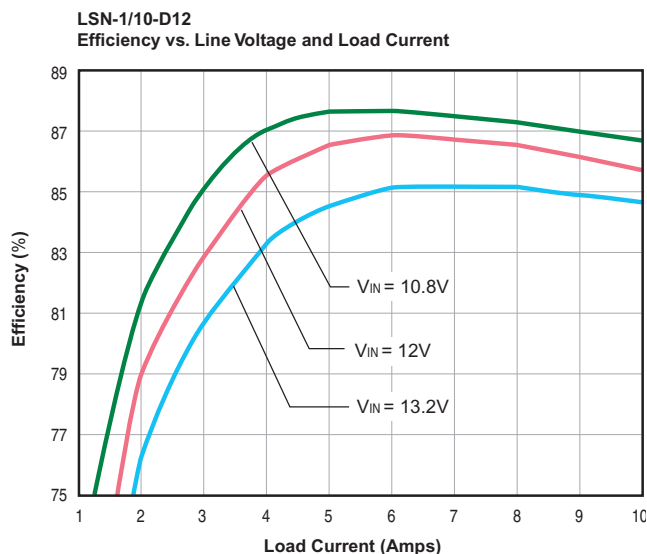

Typical Performance Curves for LSN D12 SIP Series

LSN-1.1/10-D12, LSN-1.2/10-D12, LSN-1.3/10-D12
Efficiency vs. Line Voltage and Load Current

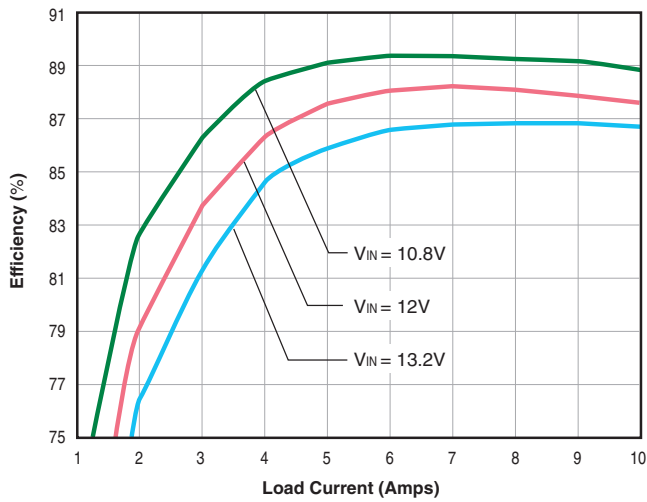

LSN-1.1/10-D12, LSN-1.2/10-D12, LSN-1.3/10-D12
Output Current vs. Ambient Temperature
(Vertical mount, air flow direction from pin 11 to pin 1)

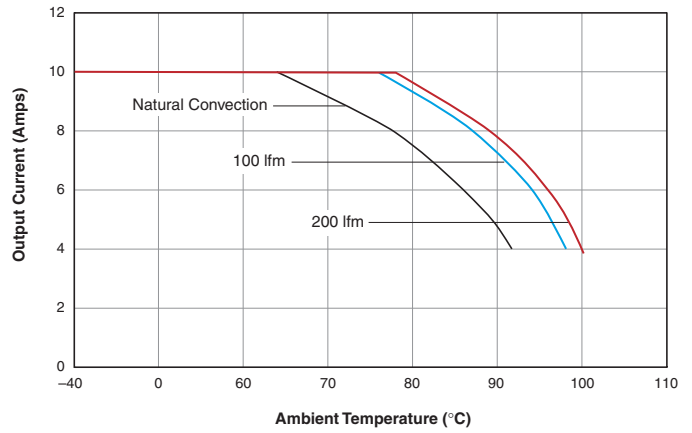

LSN-1.5/10-D12
Efficiency vs. Line Voltage and Load Current

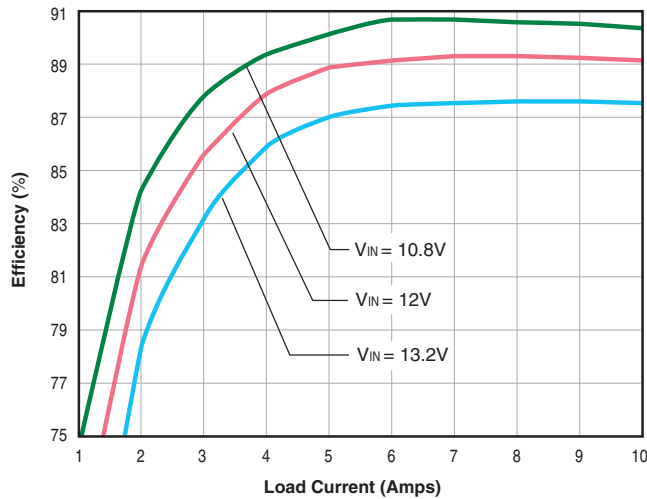

LSN-1.5/10-D12
Output Current vs. Ambient Temperature
(Vertical mount, air flow direction from pin 11 to pin 1)

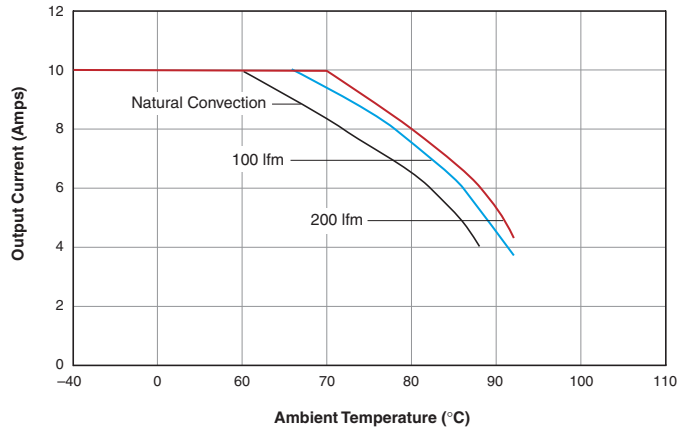

LSN-1.8/10-D12
Efficiency vs. Line Voltage and Load Current

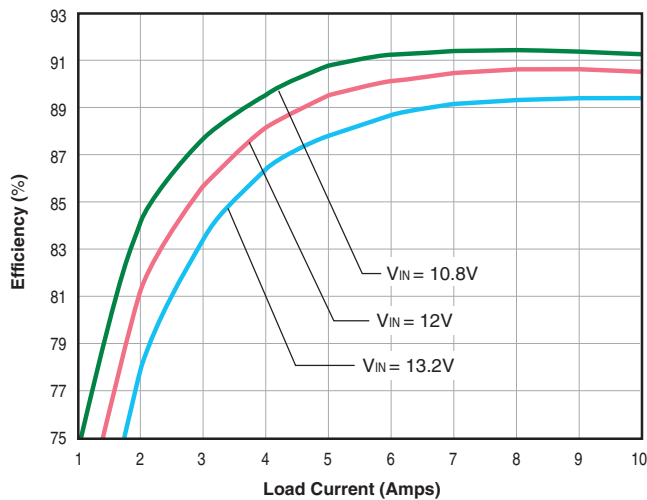

LSN-1.8/10-D12
Output Current vs. Ambient Temperature
(Vertical mount, air flow direction from pin 11 to pin 1)

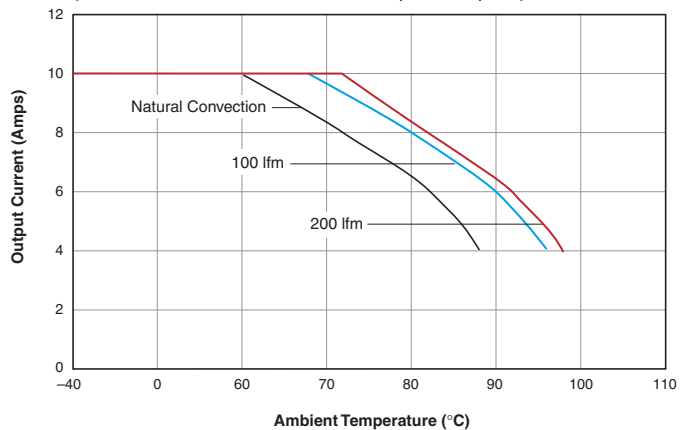

Typical Performance Curves for LSN D12 SIP Series

LSN-2/10-D12
Efficiency vs. Line Voltage and Load Current

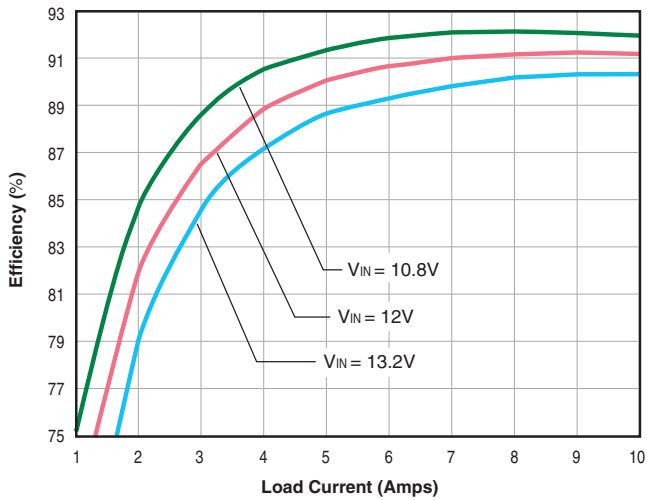

LSN-2/10-D12
Output Current vs. Ambient Temperature
(Vertical mount, air flow direction from pin 11 to pin 1)

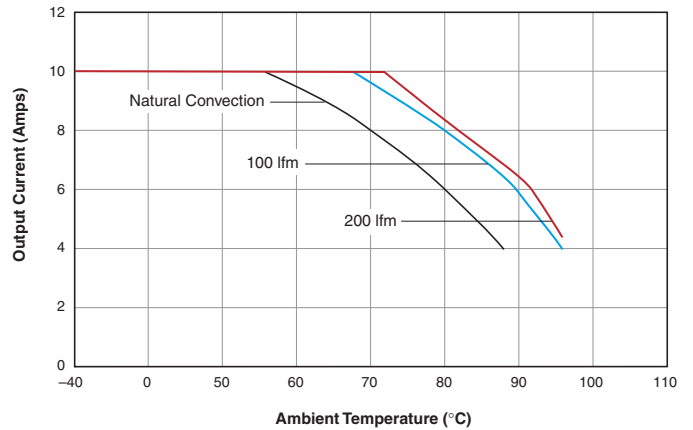

LSN-2.5/10-D12
Efficiency vs. Line Voltage and Load Current

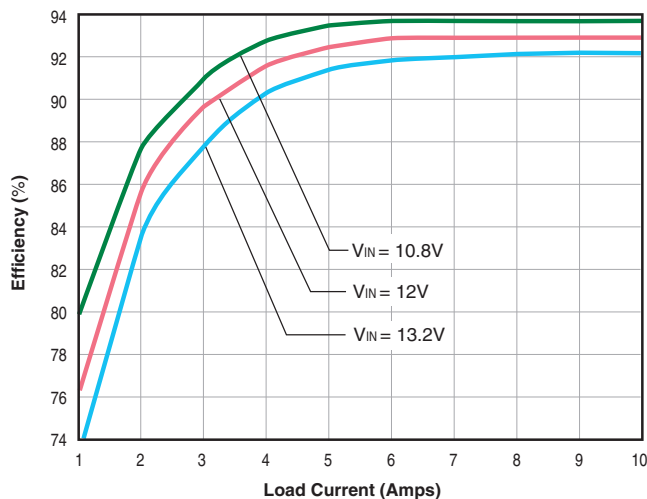

LSN-2.5/10-D12
Output Current vs. Ambient Temperature
(Vertical mount, air flow direction from pin 11 to pin 1)

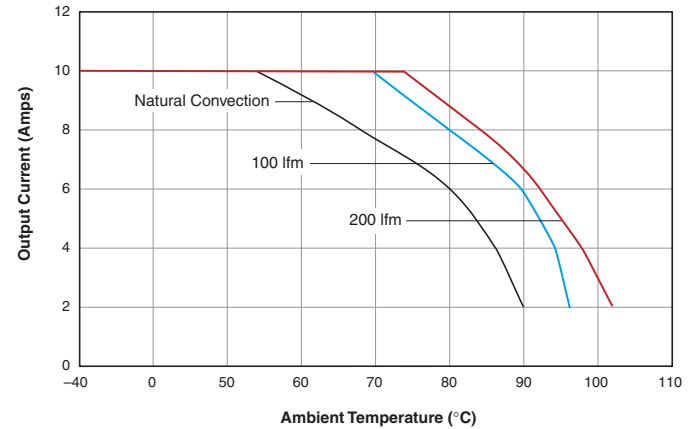

LSN-3.3/10-D12
Efficiency vs. Line Voltage and Load Current

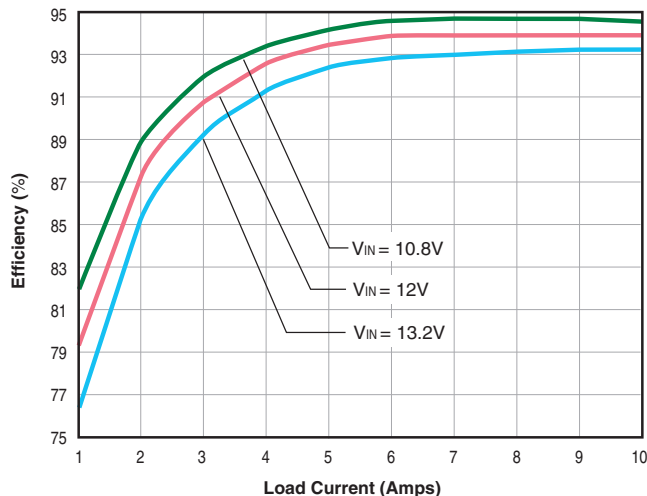

LSN-3.3/10-D12
Output Current vs. Ambient Temperature
(Vertical mount, air flow direction from pin 11 to pin 1)

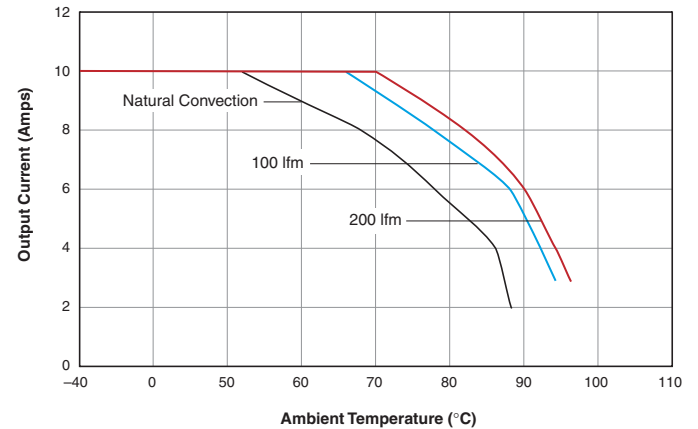

Typical Performance Curves for LSN D12 SIP Series

LSN-5/10-D12
Efficiency vs. Line Voltage and Load Current

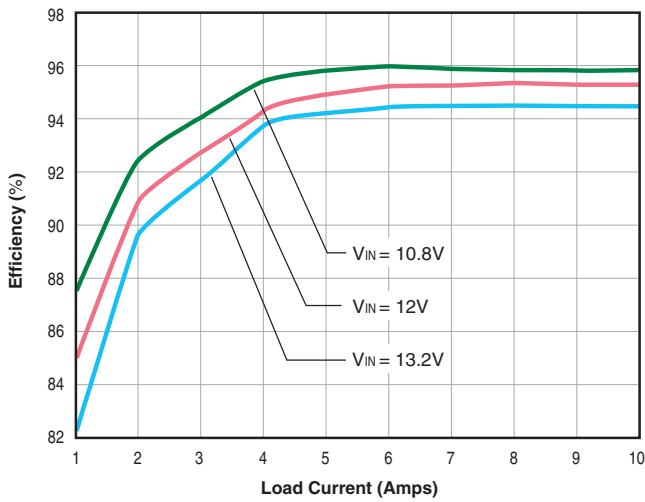

LSN-5/10-D12
Output Current vs. Ambient Temperature
(Vertical mount, air flow direction from pin 11 to pin 1)

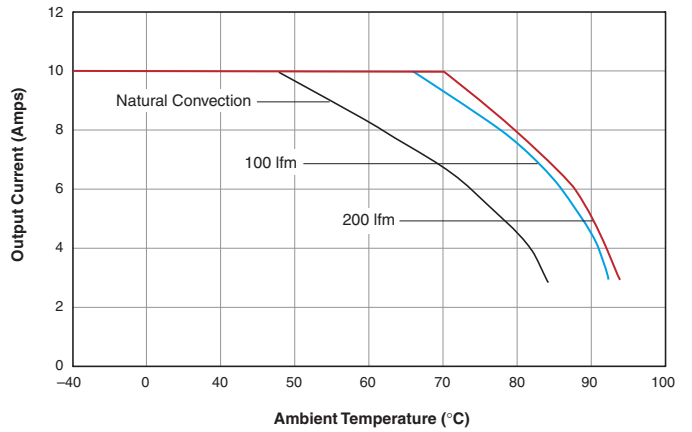

LSN-1/10-D12H (Horizontal Mount)
Output Current vs. Ambient Temperature
(Air flow direction from pin 11 to pin 1)

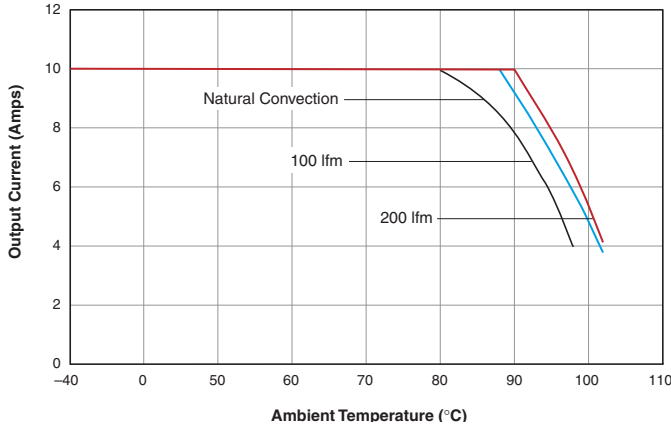

LSN-5/10-D12H (Horizontal Mount)
Output Current vs. Ambient Temperature
(Air flow direction from pin 11 to pin 1)

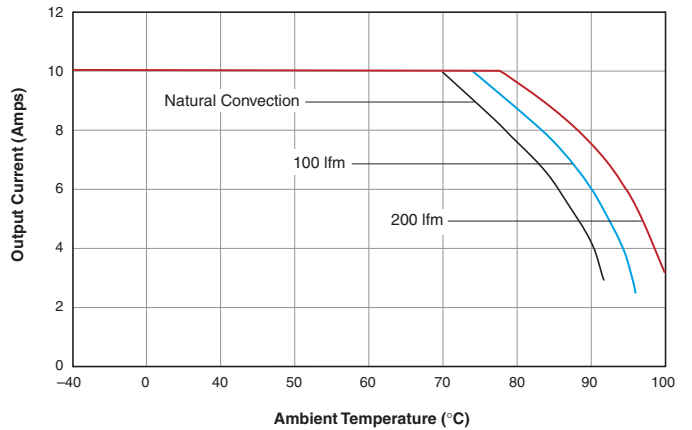

Input Inrush Current
(VIN = 12V, 7000µF as Input Switch)

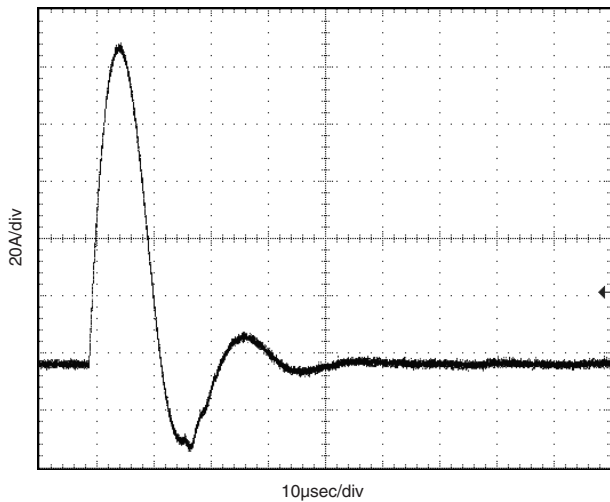

Input Reflected Ripple Current
(VIN = 12V, VOUT = 5V/10A, CIN/COUT = 22µF)

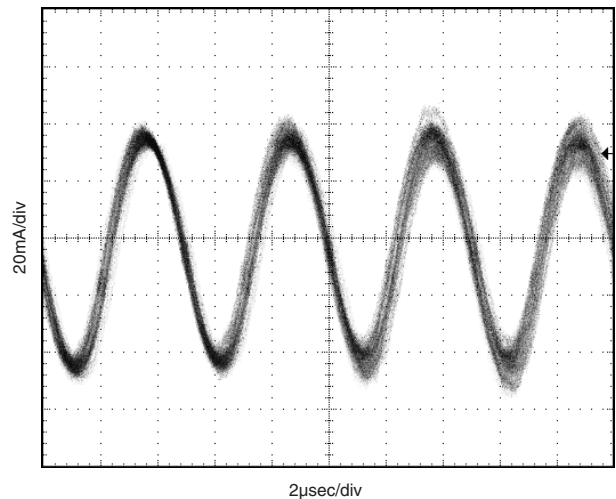

Single Output, Non-Isolated, 12VIN, 1-5VOUT, 10A, DC/DC's in SIP Packages
Typical Performance Curves for LSN D12 SIP Series

Power-Up From VIN

(VIN = 12V, VOUT = 5V/10A, CIN = 22μF, COUT = 2000μF OSCON)

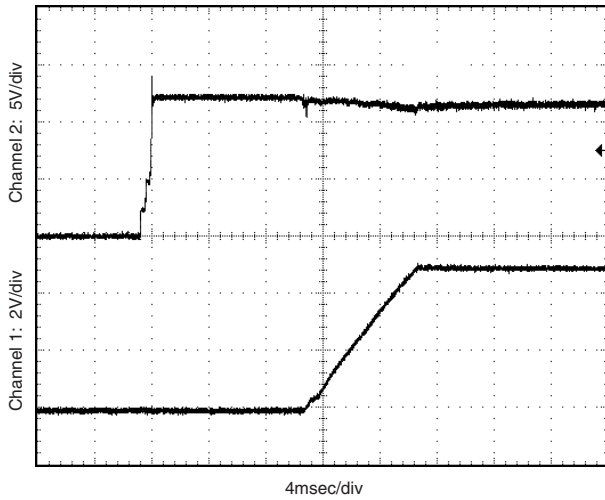

Power-Up From VIN

(VIN = 12V, VOUT = 5V/10A, CIN = 22μF, Output Filter 22μF-700nH-150μF)

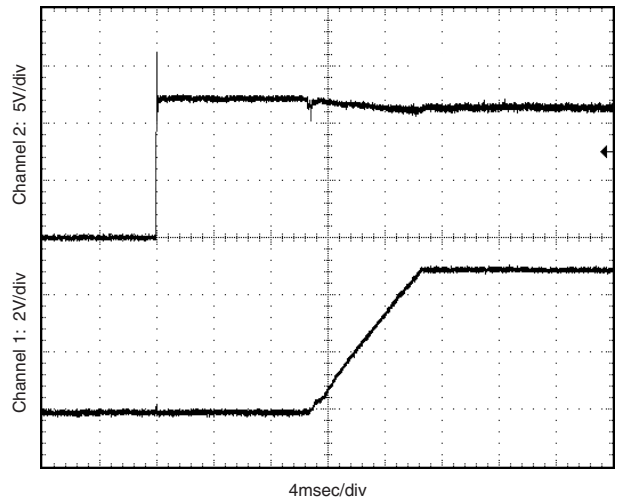

Output Ripple Noise

(VIN = 12V, VOUT = 5V, Full Load, COUT = 22μF)

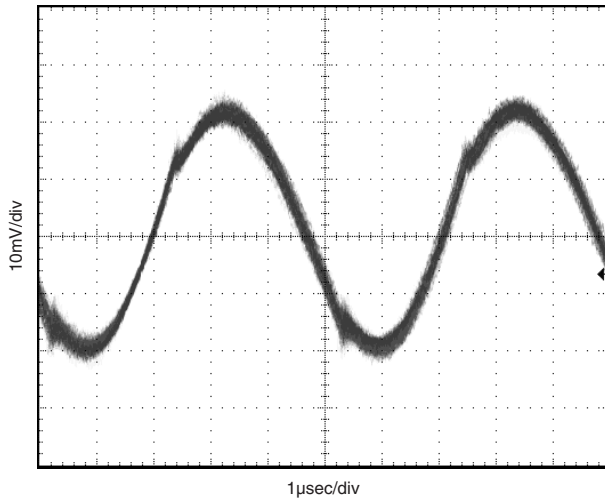

Output Ripple/Noise

(VIN = 12V, VOUT = 5V, Full Load, COUT = 2000μF OSCON)

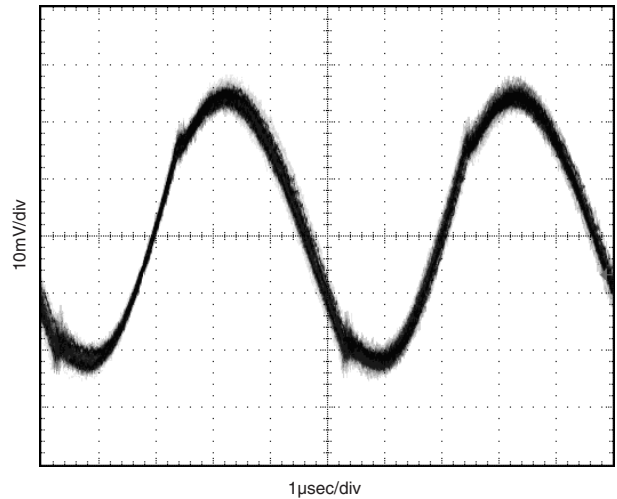

Dynamic Load Response

(VIN = 12V, VOUT = 5V/50 to 100% Load Step, CIN/COUT = 22μF)

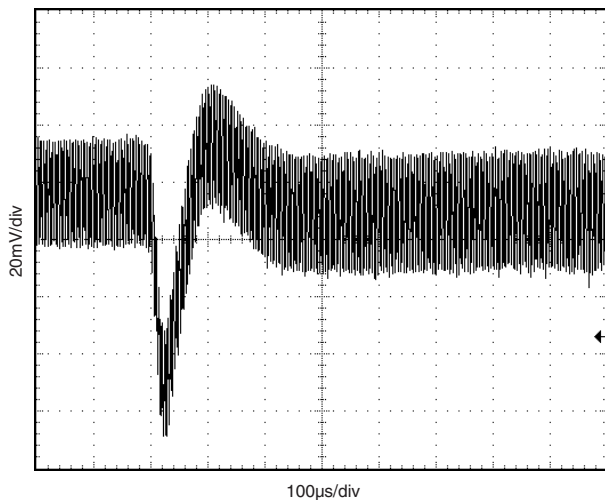

Dynamic Load Response

(VIN = 12V, VOUT = 5V, 0 - 100% Load Step, CIN = 22μF, COUT = 2000μF OSCON)

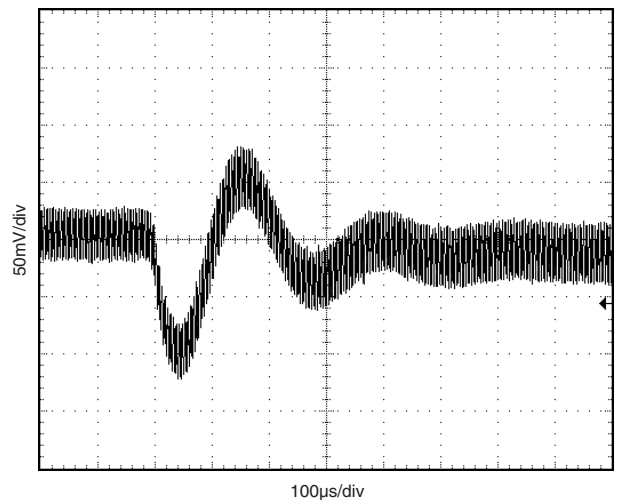

Short Circuit Output Current
 (10A/div, Period = 72msec)

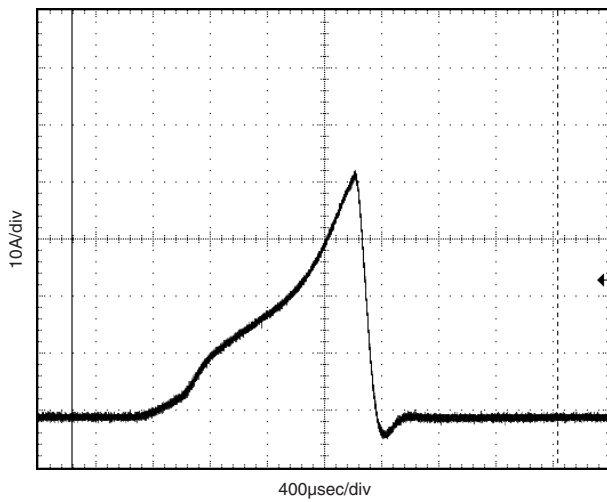

Output Hiccup
 (VIN = 12V/Output Short, CIN/COUT = 22µF)

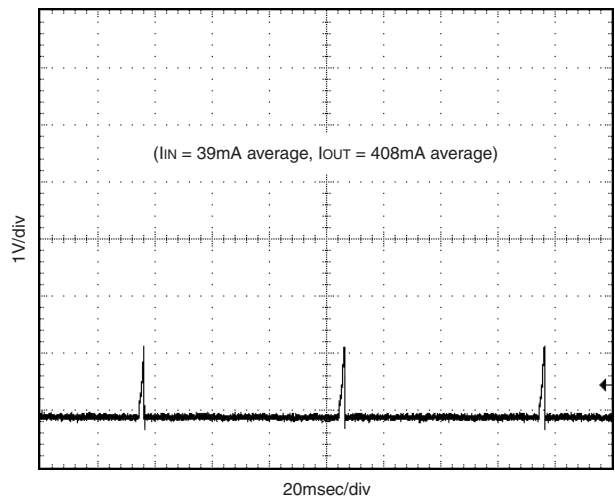

EMI CONDUCTED/RADIATED EMISSIONS

If you're designing with EMC in mind, please note that all of DATEL's LSN D12 DC/DC Converters have been characterized for conducted and radiated emissions in our EMI/EMC laboratory. Testing is conducted in an EMCO 5305 GTEM test cell utilizing EMCO automated EMC test software. Conducted/Radiated emissions are tested to the limits of FCC Part 15, Class B and CISPR 22 (EN 55022), Class B. Correlation to other specifications can be supplied upon request. The corresponding emissions plots to FCC and CISPR 22 for model LSN-5/10-D12 appear below. The published EMC test report is based on results with the highest possible output power model and is therefore representative of the whole LSN-D12 series. Contact DATEL's Applications Engineering Department for more details.

LSN-5/10-D12 Conducted Emissions
 FCC Part 15 Class B, EN55022 Class B Limit, +12 Vdc @ 4.5A
 Converter Output = +5Vdc @ 10 Amps

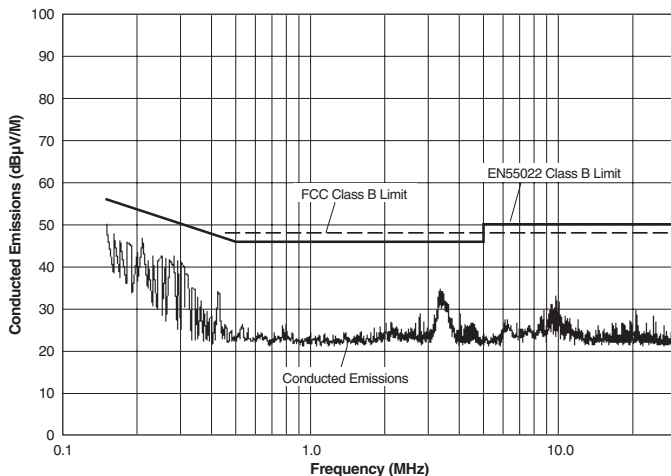

LSN-5/10-D12 Radiated Emissions
 EN55022 Class B, 10 Meters
 Converter Output = +5Vdc @ +10 Amps

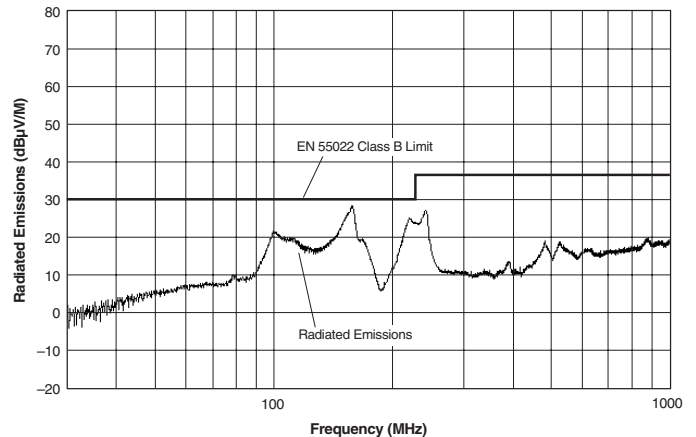

LSN-5/10-D12 Radiated Emissions
 FCC Part 15 Class B, 3 Meters
 Converter Output = +5Vdc @ 10 Amps

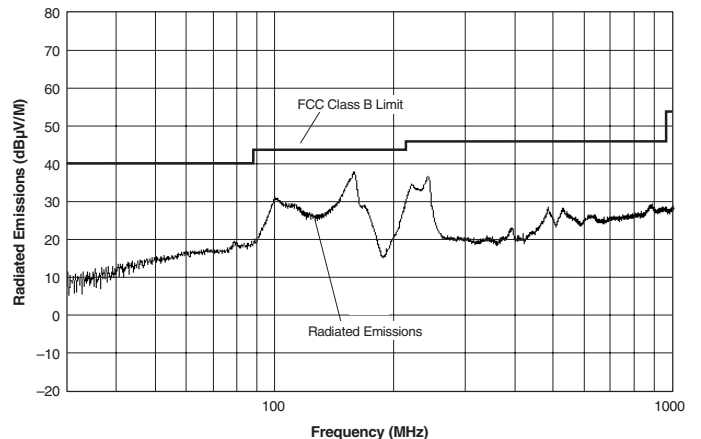

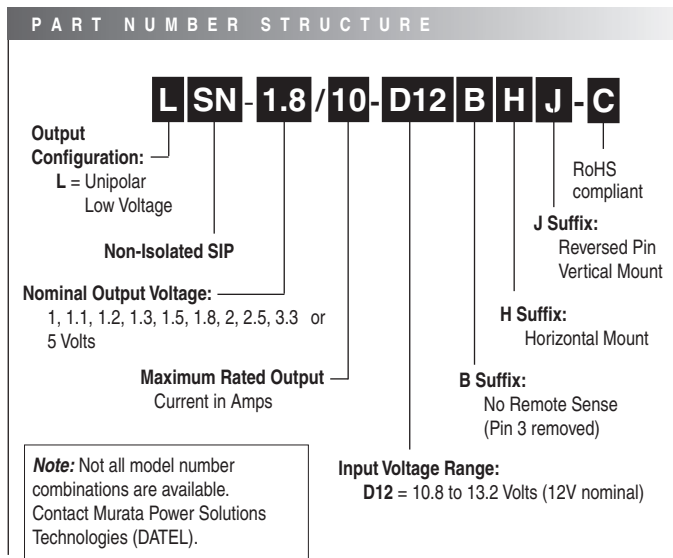

RoHS compliance ("-C" suffix)

Selected models use materials which are compatible with the Reduction of Hazardous Substances (RoHS) directive.

Contact Murata Power Solutions Technologies (DATEL) for availability.

Functional Options

Remote Sense Pin Removed ("B" suffix)

These devices have their +Sense pin (pin 3) removed, and the feedback loop is closed through the +Vout path. The 10.5Ω resistor in Figure 1 is installed in both standard and "B" models. See the Output Sense Function.

Horizontal Mounting ("H" suffix)

This packaging configuration reduces above-board height to 0.35" (8.89mm), including the isolating pad. For "H" models, a thermally conductive, electrically insulating "pad" is factory installed on the output inductor. The pad material is Bergquist Sil Pad 400. The pad size is 0.4 x 0.5 x 0.009 inches (10.16 x 12.7 x 0.23mm). This configuration can significantly improve thermal performance. See Thermal Derating for details.

Reversed pin vertical mounting ("J" suffix)

This additional mechanical configuration consists of a low-profile pin header attached to the reverse side of the converter. It allows the LSN series to be mechanically compatible with competitors' "keep out area."

Other Options and Modifications

Other options include a positive polarity (pull low to disable) on the On/Off Control. Contact DATEL directly to discuss these and other possible modifications.

Examples

- LSN-1.8/10-D12** Vertical-mount. Sense function on pin 3. No pin 9.
- LSN-1.8/10-D12B** Vertical-mount. Pin 3 (+Sense) removed. No pin 9.
- LSN-1.8/10-D12H** Horizontal-mount. Sense function on pin 3. No pin 9.
- LSN-1.8/10-D12BH** Horizontal-mount. Pin 3 (+Sense) removed. No pin 9.
- LSN-1.8/10-D12J** Reverse pin vertical-mount. Sense function on pin 3. No pin 9.