

## FEATURES

- Step-down, wide buck regulators for new distributed 12V power architectures
- 12V input (10.8-13.2V range)
- 0.75 to 5V<sub>OUT</sub> @10A
- Voltage-selectable "T" version
- Non-isolated, fixed-frequency, synchronous-rectifier topology
- Tape and reel SMT package
- ±1.25% setpoint accuracy
- Efficiencies to 96% @ 10 Amps
- Stable no-load operation
- Remote on/off control
- Sense pin and output voltage trim
- No derating to +65°C with 100 lfm
- UL/IEC/EN60950-1 certification pending
- EMC compliant

## PRODUCT OVERVIEW

LSM Series D12 SMT's (surface-mount packages) are ideal building blocks for emerging, on-board power-distribution schemes in which isolated 12V buses deliver power to any number of non-isolated, step-down buck regulators. LSM D12 DC/DC's accept a 12V input (10.8V to 13.2V input range) and convert it, with the highest efficiency in the smallest space, to a 0.75, 1, 1.2, 1.5, 1.8, 2, 2.5, 3.3 or 5 Volt output fully rated at 10 Amps.

LSM D12's are ideal point-of-use/load power processors. They typically require no external components. Their surface-mount packages occupy a mere 1.3" x 0.53" (33.0 x 13.5mm), and are only 0.34 inches (8.6mm) high.

The LSM's best-in-class power density is achieved with a fully synchronous, fixed-frequency, buck topology that also delivers: high efficiency (96% for 5V<sub>OUT</sub> models), low

noise (50mVp-p typ.), tight line/load regulation ( $\pm 0.1\%/\pm 0.25\%$  max.), quick step response (100µsec), stable no-load operation, and no output reverse conduction.

The fully functional LSM's feature output over-current detection, continuous short-circuit protection, over-temperature protection, a remote on/off control pin (pull low to disable), an output-voltage trim function, and a sense pin. High efficiency enables the LSM D12's to deliver rated output currents of 10 Amps at ambient temperatures to +65°C with 100 lfm air flow.

If your new system boards call for three or more supply voltages, check out the economics of on-board 12V distributed power. If you don't need to pay for multiple isolation barriers, Murata Power Solutions' non-isolated LSM D12 SMT's will save you money.

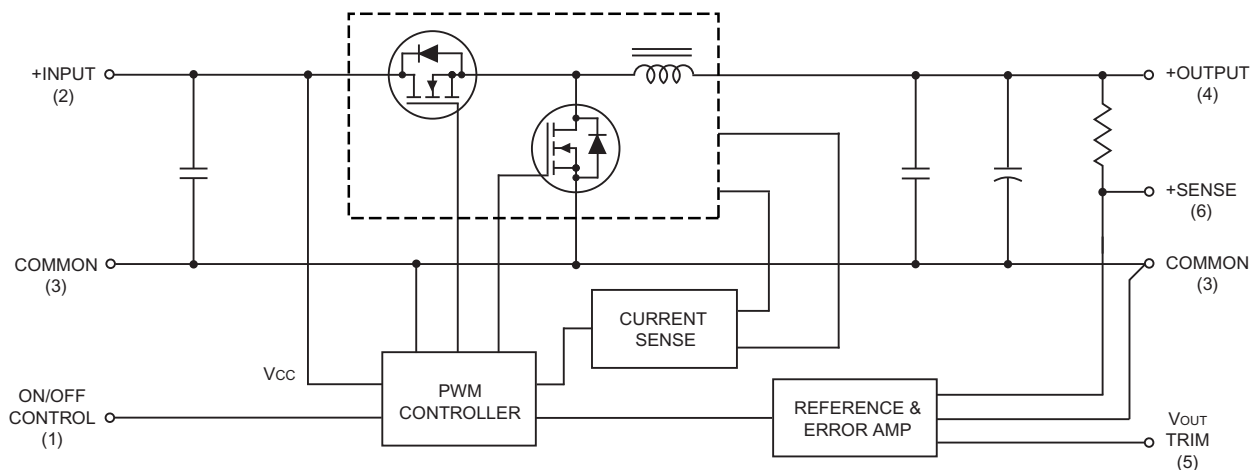

Typical topology is shown

Figure 1. Simplified Schematic

## Performance Specifications and Ordering Guide <sup>①</sup>

ORDERING GUIDE													
Models	Output				Input			Efficiency			Package (Case, Pinout)		
	V <sub>OUT</sub> (Volts)	I <sub>OUT</sub> (Amps)	R/N (mVp-p) <sup>②</sup>		Regulation (Max.) <sup>③</sup>		V <sub>IN</sub> Nom. (Volts)	Range (Volts)	I <sub>IN</sub> <sup>④</sup> (mA/A)	Full Load		½ Load	
			Typ.	Max.	Line	Load				Min.			Typ.
LSM-0.8/10-D12	0.8	10	45	60	±0.1%	±0.375%	12	10.8-13.2	30/0.84	80.5%	82.5%	85%	C45, P63
LSM-1/10-D12	1	10	50	75	±0.1%	±0.25%	12	10.8-13.2	35/1.02	83%	85%	86%	C45, P63
LSM-1.2/10-D12	1.2	10	50	75	±0.1%	±0.25%	12	10.8-13.2	40/1.19	85%	87%	88%	C45, P63
LSM-1.5/10-D12	1.5	10	50	75	±0.1%	±0.25%	12	10.8-13.2	50/1.47	86.5%	88.5%	89.5%	C45, P63
LSM-1.8/10-D12	1.8	10	50	75	±0.1%	±0.25%	12	10.8-13.2	55/1.75	88%	90%	90.5%	C45, P63
LSM-2/10-D12	2	10	50	75	±0.1%	±0.25%	12	10.8-13.2	55/1.9	89%	91%	91.5%	C45, P63
LSM-2.5/10-D12	2.5	10	50	75	±0.1%	±0.25%	12	10.8-13.2	60/2.3	90%	92.5%	92%	C45, P63
LSM-3.3/10-D12	3.3	10	50	75	±0.1%	±0.25%	12	10.8-13.2	70/3	92%	94%	93.5%	C45, P63
LSM-5/10-D12	5	10	75	100	±0.1%	±0.25%	12	10.8-13.2	85/4.5	93.5%	96%	95.5%	C45, P63
LSM-T/10-D12	0.75-5	10	50	75	±0.1%	±0.25%	12	10-14	100/6.5	92%	93%	--	C45, P63

- ① Typical at T<sub>A</sub> = +25°C under nominal line voltage and full-load conditions, unless noted. All models are tested and specified with external 22µF tantalum input and output capacitors. These capacitors are necessary to accommodate our test equipment and may not be required to achieve specified performance in your applications. See I/O Filtering and Noise Reduction.
- ② Ripple/Noise (R/N) is tested/specified over a 20MHz bandwidth and may be reduced with external filtering. See I/O Filtering and Noise Reduction for details.

- ③ These devices have no minimum-load requirements and will regulate under no-load conditions. Regulation specifications describe the output-voltage deviation as the line voltage or load is varied from its nominal/midpoint value to either extreme.
- ④ Nominal line voltage, no-load/full-load conditions.
- ⑤ LSM-T/10-D12 specifications are given at V<sub>OUT</sub> = 5V, full load.

## PART NUMBER STRUCTURE

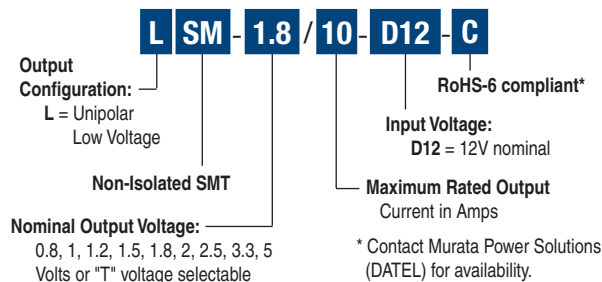

**MECHANICAL SPECIFICATIONS**

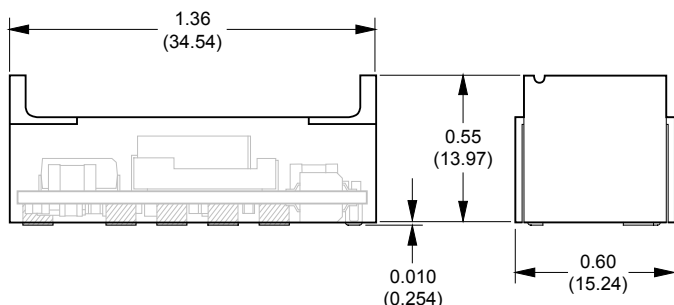

I/O Connections	
Pin	Function P63
1	On/Off Control
2	+Input
3	Common
4	+Output
5	V <sub>OUT</sub> Trim
6	+Sense

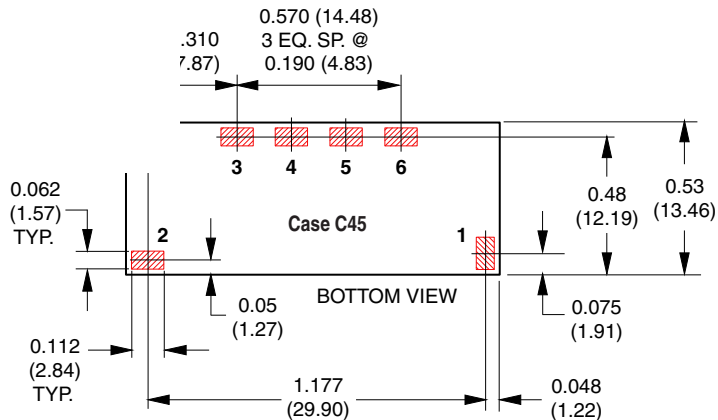
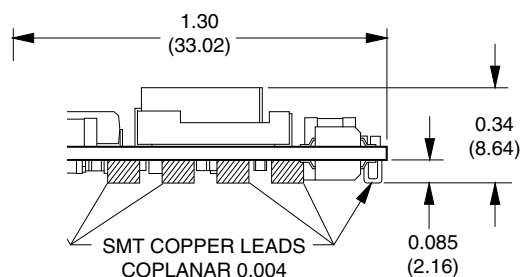
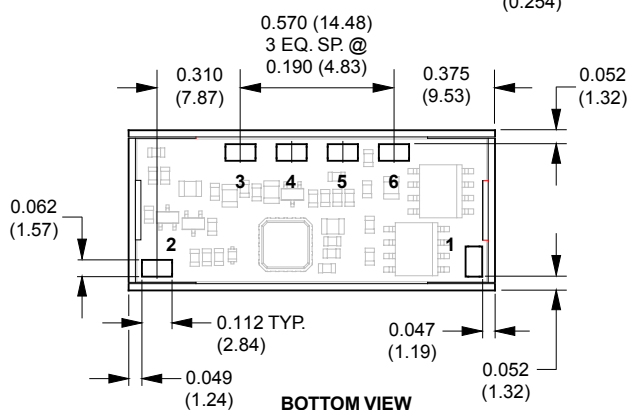

**LSM WITH REMOVEABLE HEAT SHIELD FOR HIGH TEMPERATURE SOLDER**

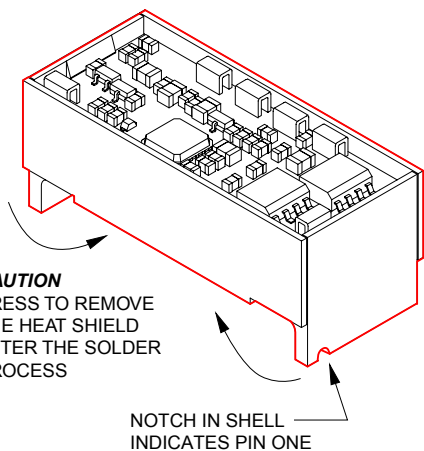

Refer to the last page for Tape and Reel information.

DIMENSIONS ARE IN INCHES (MM)

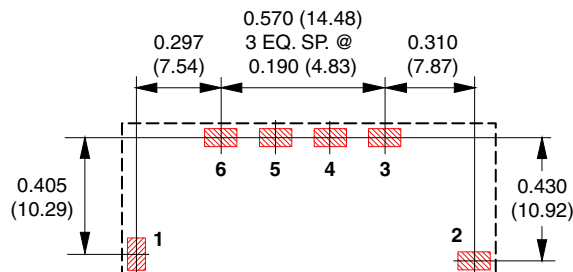

**RECOMMENDED PAD LAYOUT**

Recommended Pad Size: 0.15 x 0.10 (3.81 x 2.54)

## Performance/Functional Specifications

Typical @  $T_A = +25^\circ\text{C}$  under nominal line voltage and full-load conditions unless noted. ①

Input	
<b>Input Voltage Range</b>	See Ordering Guide
<b>Input Current:</b>	
Normal Operating Conditions	See Ordering Guide
Inrush Transient	0.08A <sup>2</sup> sec
Standby/Off Mode	1.5mA
Output Short-Circuit Condition	12-40mA average (model dependent)
<b>Input Reflected Ripple Current</b> ② ⑥	40mA <sub>p-p</sub>
<b>Input Filter Type</b>	Capacitive
<b>Overvoltage Protection</b>	None
<b>Reverse-Polarity Protection</b>	None
<b>Undervoltage Shutdown</b>	None (except 8V LSM-T/10-D12)
<b>On/Off Control</b> ② ③ ⑦	On = open (internal pull-up to +VIN) Off = 0 to +0.4V (1mA max.)
Output	
<b>V<sub>OUT</sub> Accuracy</b> (50% load)	±1.25% max. (±2% "T" version, 50% load)
<b>Minimum Loading</b> ①	No load
<b>Maximum Capacitive Load</b>	1000µF (low ESR, OSCON)
<b>V<sub>OUT</sub> Trim Range</b> ⑧	±10% (0.8V not trimmable)
<b>Ripple/Noise</b> (20MHz BW) ① ② ④	See Ordering Guide
<b>Total Accuracy</b>	3% over line/load/temperature
<b>Efficiency</b>	See Ordering Guide
<b>Overcurrent Detection and Short-Circuit Protection:</b> ⑨	
Current-Limiting Detection Point	17 Amps
Short-Circuit Detection Point	98% of V <sub>OUT</sub> set
SC Protection Technique	Hiccup with auto recovery
Short-Circuit Current	120-400mA average (model dependent)
Dynamic Characteristics	
<b>Transient Response</b> (50% load step)	100µsec to ±2% of final value
<b>Start-Up Time:</b> ②	
V <sub>IN</sub> to V <sub>OUT</sub> and On/Off to V <sub>OUT</sub>	75msec for V <sub>OUT</sub> = 1V and 0.8V 50msec for V <sub>OUT</sub> = 1.2V to 5V
<b>Switching Frequency:</b>	
0.8V, 1V/1.2V Models	105/120kHz ±10%
1.5V/1.8V, 2V Models	160/177kHz ±10%
2.5V, 3.3V, 5V Models	195kHz ±10%
LSM-T/10-D12	230kHz ±30kHz
Environmental	
<b>Calculated MTBF</b> ⑤	2.3-1.8 million hours (1V <sub>OUT</sub> to 5V <sub>OUT</sub> )
<b>Operating Temperature:</b> (Ambient) ②	
Without Derating (100 lfm)	-40 to +48/64°C (model dependent)
With Derating	See Derating Curves
<b>Thermal Shutdown</b>	+115°C (110 to 125°C)
Physical	
<b>Dimensions</b>	1.3" x 0.53" x 0.34" (33.02 x 13.46 x 8.64 mm)
<b>Pin Dimensions/Material</b>	0.112" x 0.062" (2.84 x 1.57mm) rectangular copper with gold plate over nickel underplate
<b>Weight</b>	0.28 ounces (7.8g)
<b>Flamability Rating</b>	UL94V-0
<b>EMI</b>	Conducted and radiated FCC part 15, EN55022 (may require external filter)
<b>Safety</b>	UL/cUL/IEC/EN 60950-1, CSA-C22.2 No. 234

① All models are tested and specified with external 22µF tantalum input and output capacitors. These capacitors are necessary to accommodate our test equipment and may not be required to achieve specified performance in your applications. All models are stable and regulate within spec under no-load conditions.

② See Technical Notes and Performance Curves for details.

③ The On/Off Control (pin 1) is designed to be driven with open-collector logic or the application of appropriate voltages (referenced to Common, pin 3). Applying a voltage to On/Off Control when no input voltage is applied to the converter may cause permanent damage.

## Non-Isolated, 12V<sub>IN</sub>, 0.75-5V<sub>OUT</sub> DC/DC Converters

- ④ Output noise may be further reduced with the installation of additional external output filtering. See I/O Filtering and Noise Reduction.
- ⑤ MTBF's are calculated using Telcordia SR-332(Bellcore), ground fixed,  $T_A = +25^\circ\text{C}$ , full power, natural convection, +67°C pcb temperature.
- ⑥ Input Ripple Current is tested/specified over a 5-20MHz bandwidth with an external 33µF input capacitor and a simulated source impedance of 220µF and 12µH. See I/O Filtering, Input Ripple Current and Output Noise for details.
- ⑦ On/Off Control for LSM-T/10-D12 only: Positive Logic: On = pin open or to +4V max., Off = pin grounded or 0 to +0.4V max. Shutdown current is 3µA sink.
- ⑧ The Output Voltage Range for the LSM-T/10-D12 is +0.75V to +5V, user selectable.
- ⑨ LSM-T/10-D12 Overcurrent and Short-circuit specs:
 

Current limit	25 Amps
Short Circuit Current	600mA

### Absolute Maximum Ratings

<b>Input Voltage:</b>	
Continuous or transient	15 Volts
<b>On/Off Control</b> (Pin 1)	+VIN (+4V for "T" version)
<b>Input Reverse-Polarity Protection</b>	None
<b>Output Overvoltage Protection</b>	None
<b>Output Current</b>	Current limited. Devices can withstand sustained output short circuits without damage.
<b>Storage Temperature</b>	-40 to +125°C
<b>Lead Temperature</b>	See Reflow Solder Profile

These are stress ratings. Exposure of devices to any of these conditions may adversely affect long-term reliability. Proper operation under conditions other than those listed in the Performance/Functional Specifications Table is not implied.

### TECHNICAL NOTES

#### I/O Filtering and Noise Reduction

All models in the LSM D12 Series are tested and specified with external 22µF tantalum input and output capacitors. These capacitors are necessary to accommodate our test equipment and may not be required to achieve desired performance in your application. The LSM D12's are designed with high-quality, high-performance *internal* I/O caps, and will operate within spec in most applications with *no additional external components*.

In particular, the LSM D12's input capacitors are specified for low ESR and are fully rated to handle the units' input ripple currents. Similarly, the internal output capacitors are specified for low ESR and full-range frequency response. As shown in the Performance Curves, removal of the external 22µF tantalum output caps has minimal effect on output noise.

In critical applications, input/output ripple/noise may be further reduced using filtering techniques, the simplest being the installation of external I/O caps.

External input capacitors serve primarily as energy-storage devices. They minimize high-frequency variations in input voltage (usually caused by IR drops in conductors leading to the DC/DC) as the switching converter draws pulses of current. Input capacitors should be selected for bulk capacitance (at appropriate frequencies), low ESR, and high rms-ripple-current ratings. The switching nature of modern DC/DC's requires that the dc input voltage source have low ac impedance at the frequencies of interest. Highly inductive source impedances can greatly affect system stability. Your specific system configuration may necessitate additional considerations.

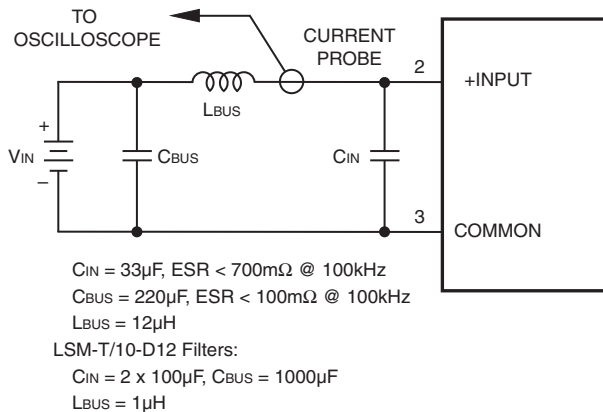

**Figure 2. Measuring Input Ripple Current**

Output ripple/noise (also referred to as periodic and random deviations or PARD) may be reduced below specified limits with the installation of additional external output capacitors. Output capacitors function as true filter elements and should be selected for bulk capacitance, low ESR, and appropriate frequency response. Any scope measurements of PARD should be made directly at the DC/DC output pins with scope probe ground less than 0.5" in length.

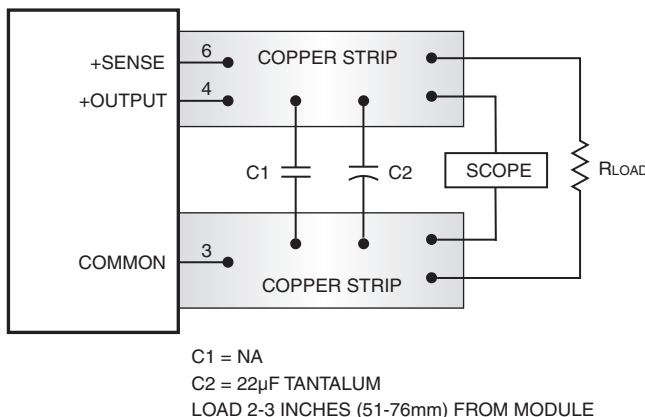

**Figure 3. Measuring Output Ripple/Noise (PARD)**

All external capacitors should have appropriate voltage ratings and be located as close to the converters as possible. Temperature variations for all relevant parameters should be taken into consideration.

The most effective combination of external I/O capacitors will be a function of your line voltage and source impedance, as well as your particular load and layout conditions. Our Applications Engineers can recommend potential solutions and discuss the possibility of our modifying a given device's internal filtering to meet your specific requirements. Contact our Applications Engineering Group for additional details.

### Input Fusing

Most applications and or safety agencies require the installation of fuses at the inputs of power conversion components. LSM D12 Series DC/DC convert-

ers are not internally fused. Therefore, if input fusing is mandatory, either a normal-blow or a fast-blow fuse with a value no greater than 20 Amps should be installed within the ungrounded input path to the converter.

As a rule of thumb however, we recommend to use a normal-blow or slow-blow fuse with a typical value of about twice the maximum input current, calculated at low line with the converters minimum efficiency.

### Safety Considerations

LSM D12 SMT's are non-isolated DC/DC converters. In general, all DC/DC's must be installed, including considerations for I/O voltages and spacing/separation requirements, in compliance with relevant safety-agency specifications (usually UL/IEC/EN60950-1).

In particular, for a non-isolated converter's output voltage to meet SELV (safety extra low voltage) requirements, its input must be SELV compliant. If the output needs to be ELV (extra low voltage), the input must be ELV.

### Input Overvoltage and Reverse-Polarity Protection

LSM D12 SMT Series DC/DCs do not incorporate either input overvoltage or input reverse-polarity protection. Input voltages in excess of the specified absolute maximum ratings and input polarity reversals of longer than "instantaneous" duration can cause permanent damage to these devices.

### Start-Up Time

The  $V_{IN}$  to  $V_{OUT}$  Start-Up Time is the interval between the time at which a ramping input voltage crosses the lower limit of the specified input voltage range and the fully loaded output voltage enters and remains within its specified accuracy band. Actual measured times will vary with input source impedance, external input capacitance, and the slew rate and final value of the input voltage as it appears to the converter.

The On/Off to  $V_{OUT}$  Start-Up Time assumes the converter is turned off via the On/Off Control with the nominal input voltage already applied to the converter. The specification defines the interval between the time at which the converter is turned on and the fully loaded output voltage enters and remains within its specified accuracy band. See Typical Performance Curves.

### Remote Sense

LSM D12 SMT Series DC/DC converters offer an output sense function on pin 6. The sense function enables point-of-use regulation for overcoming moderate IR drops in conductors and/or cabling. Since these are non-isolated devices whose inputs and outputs usually share the same ground plane, sense is provided only for the +Output.

The remote sense line is part of the feedback control loop regulating the converter's output. The sense line carries very little current and consequently requires a minimal cross-sectional-area conductor. As such, it is not a low-impedance point and must be treated with care in layout and cabling. Sense lines should be run adjacent to signals (preferably ground), and in cable and/or discrete-wiring applications, twisted-pair or similar techniques should be used. To prevent high frequency voltage differences between  $V_{OUT}$  and Sense, we recommend installation of a 1000pF capacitor close to the converter.



# Single Output LSM-10A D12 Models

Non-Isolated, 12V<sub>IN</sub>, 0.75-5V<sub>OUT</sub> DC/DC Converters

The sense function is capable of compensating for voltage drops between the +Output and +Sense pins that do not exceed 10% of V<sub>OUT</sub>.

$$[V_{OUT(+)} - \text{Common}] - [\text{Sense}(+) - \text{Common}] \leq 10\%V_{OUT}$$

Power derating (output current limiting) is based upon maximum output current and voltage at the converter's output pins. Use of trim and sense functions can cause the output voltage to increase, thereby increasing output power beyond the LSM's specified rating. Therefore:

$$(V_{OUT \text{ at pins}}) \times (I_{OUT}) \leq \text{rated output power}$$

The internal 10.5Ω resistor between +Sense and +Output (see Figure 1) serves to protect the sense function by limiting the output current flowing through the sense line if the main output is disconnected. It also prevents output voltage runaway if the sense connection is disconnected.

*Note: If the sense function is not used for remote regulation, +Sense (pin 6) must be tied to +Output (pin 4) at the DC/DC converter pins.*

### On/Off Control

The On/Off Control pin may be used for remote on/off operation. LSM D12 Series DC/DC converters are designed so that they are enabled when the control pin is left open (open collector) and disabled when the control pin is pulled low (to less than +0.4V relative to Common). As shown in Figure 4, all models have an internal pull-up resistor.

Dynamic control of the on/off function is best accomplished with a mechanical relay or open-collector/open-drain drive circuit (optically isolated if appropriate). The drive circuit should be able to sink appropriate current when activated and withstand appropriate voltage when deactivated.

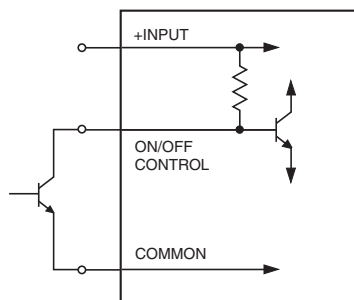

ON/OFF pin open: Logic High = DC/DC converter On  
ON/OFF pin <0.4V: Logic Low = DC/DC converter Off

**Figure 4. Driving the On/Off Control Pin with an Open-Collector Drive Circuit (All models except LSM-T/10-D12)**

Applying an external voltage to the On/Off Control pin when no input power is applied to the converter can cause permanent damage to the converter. The on/off control function, however, is designed such that the converter can be disabled (control pin pulled low) while input voltage is ramping up and then "released" once the input has stabilized (see also power-up sequencing).

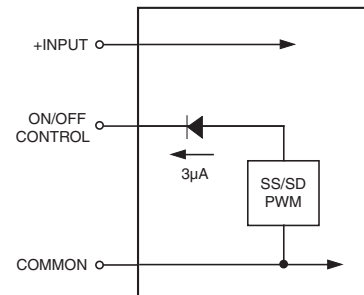

**Figure 4A. LSM-T10-D12 Driving the On/Off Control Input**

### Power-up Sequencing

If a controlled start-up of one or more LSM D12 Series DC/DC converters is required, or if several output voltages need to be powered-up in a given sequence, the On/Off control pin can be driven with an external open collector device as per Figure 5.

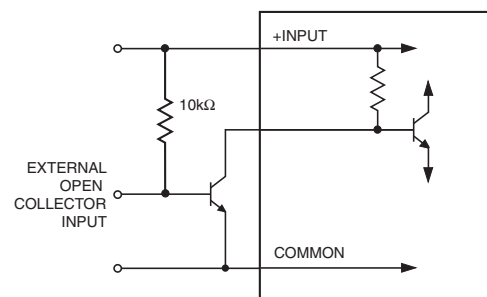

External Input Open: On/Off pin Low = DC/DC converter Off  
External Input Low: On/Off pin High = DC/DC converter On

**Figure 5. Driving the External Power-Up Open Collector**

Leaving the input of the external circuit open during power-up will have the output of the DC/DC converter disabled. When the input to the external open collector is pulled low, the DC/DC converters output will be enabled.

### Output Overvoltage Protection

LSM D12 SMT Series DC/DC converters do not incorporate output overvoltage protection. In the extremely rare situation in which the device's feedback loop is broken, the output voltage may run to excessively high levels (V<sub>OUT</sub> = V<sub>IN</sub>). If it is absolutely imperative that you protect your load against any and all possible overvoltage situations, voltage limiting circuitry must be provided external to the power converter.

### Output Overcurrent Detection

Overloading the power converter's output for an extended time will invariably cause internal component temperatures to exceed their maximum ratings and eventually lead to component failure. High-current-carrying components such as inductors, FET's and diodes are at the highest risk. LSM D12 SMT Series DC/DC converters incorporate an output overcurrent detection and shutdown function that serves to protect both the power converter and its load.

If the output current exceeds its maximum rating by typically 70% or if the output voltage drops to less than 98% of its original value, the LSM D12's internal overcurrent-detection circuitry immediately turns off the converter, which then goes into a "hiccup" mode. While hiccupping, the converter will continuously attempt to restart itself, go into overcurrent, and then shut down. Once the output short is removed, the converter will automatically restart itself.

### Output Voltage Trimming (Except "T" models—See "T" Trimming)

Allowable trim ranges for each model in the LSM D12 SMT Series are ±10%. The LSM-T/10-D12 has a user-selectable output range of +0.75V to +5V. Trimming is accomplished with either a trimpot or a single fixed resistor. The trimpot should be connected between +Output and Common with its wiper connected to the Trim pin as shown in Figure 6 below.

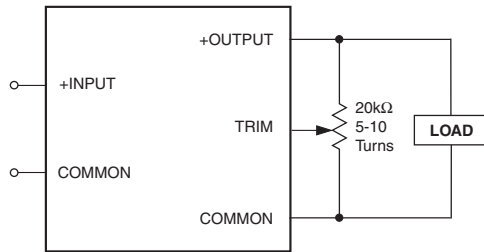

Figure 6. Trim Connections Using a Trimpot

A trimpot can be used to determine the value of a single fixed resistor which can then be connected, as shown in Figure 7, between the Trim pin and +Output to trim down the output voltage, or between the Trim pin and Common to trim up the output voltage. Fixed resistors should have absolute TCR's less than 100ppm/°C to ensure stability.

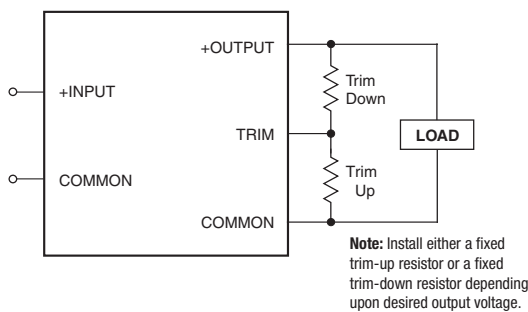

Figure 7. Trim Connections Using Fixed Resistors

The following trim equations can be starting points for selecting specific trim-resistor values. Recall, untrimmed devices are guaranteed to be ±1.25% accurate.

Adjustment beyond the specified adjustment range is not recommended. When using trim in combination with Remote Sense, the maximum rated power must not be exceeded (see Remote Sense).

### Trim Equations

$$R_{T\text{DOWN}} (\text{k}\Omega) = \frac{1.82(V_O - 0.8)}{V_{O\text{NOM}} - V_O} - X \quad R_{T\text{UP}} (\text{k}\Omega) = \frac{1.46}{V_O - V_{O\text{NOM}}} - X$$

- LSM-1/10-D12: X = 0.909
- LSM-1.1/10-D12: X = 2.49
- LSM-1.2/10-D12: X = 3.09
- LSM-1.3/10-D12: X = 4.12

$$R_{T\text{DOWN}} (\text{k}\Omega) = \frac{4.64(V_O - 0.8)}{V_{O\text{NOM}} - V_O} - X \quad R_{T\text{UP}} (\text{k}\Omega) = \frac{3.72}{V_O - V_{O\text{NOM}}} - X$$

- LSM-1.5/10-D12: X = 13.3
- LSM-1.8/10-D12: X = 16.9
- LSM-2/10-D12: X = 15.4

$$R_{T\text{DOWN}} (\text{k}\Omega) = \frac{7.5(V_O - 0.8)}{V_{O\text{NOM}} - V_O} - X \quad R_{T\text{UP}} (\text{k}\Omega) = \frac{6}{V_O - V_{O\text{NOM}}} - X$$

- LSM-2.5/10-D12: X = 20
- LSM-3.3/10-D12: X = 15
- LSM-5/10-D12: X = 10

**Note:** Resistor values are in kΩ. Accuracy of adjustment is subject to tolerances of resistors and factory-adjusted, initial output accuracy.  
V<sub>O</sub> = desired output voltage. V<sub>ONOM</sub> = nominal output voltage.

**Note:** LSM-0.8/10-D12 is not trimmable.

### "T" Model, LSM-T/10-D12, Trimming

This version of the LSM 10A series offers a special output voltage trimming feature which is fully compatible with competitive units. The output voltage may be varied from 0.75 to 5 Volts using a single external trim up resistor connected from the Trim input to Output Common. If no trim resistor is attached (Trim pin open), the output is 0.7525 Volts.

The trim may also be adjusted using an external reference voltage connected to the Trim input.

As with other trim adjustments, use a 1% metal film precision resistor with low temperature coefficient (±100 ppm/°C or less) mounted close to the converter with short leads. Also be aware that the output accuracy is ±2% (typical) therefore you may need to vary this resistance slightly to achieve your desired output setting.

The resistor trim up equation for the LSM-T/10-D12 is as follows:

$$R_{TRIM\_UP} (\Omega) = \frac{10500}{V_0 - 0.7525} - 1000$$

Where V<sub>0</sub> is the desired output voltage.

The LSM-T/10-D12 fixed resistance values to set the output values are:

V <sub>OUT</sub> (typ.)	0.7525	1.0	1.2	1.5	1.8	2	2.5	3.3	5.0
R <sub>TRIM</sub> (kΩ)	Open	41.424	22.46	13.05	9.024	7.417	5.009	3.122	1.472

**CAUTION:** To retain proper regulation, do not exceed the 5 Volt output.

### Voltage Trim

The LSM-T/10-D12 may also be trimmed using an external voltage applied between the Trim input and Output Common. Be aware that the internal "load" impedance looking into trim pin is approximately 5kΩ. Therefore, you may have to compensate for this in the source resistance of your external voltage reference.

The equation for this voltage adjustment is:

$$V_{TRIM} = 0.7 - (0.0667 \times (V_0 - 0.7525))$$

The LSM-T/10-D12 fixed trim voltages to set the output voltage are:

V <sub>OUT</sub> (typ.)	0.7525	1.0	1.2	1.5	1.8	2	2.5	3.3	5.0
V <sub>TRIM</sub>	Open	0.68354	0.67	0.65	0.63	0.617	0.583	0.53	0.4166

### Output Reverse Conduction

Many DC/DCs using synchronous rectification suffer from Output Reverse Conduction. If those devices have a voltage applied across their output before a voltage is applied to their input (this typically occurs when another power supply starts before them in a power-sequenced application), they will either fail to start or self destruct. In both cases, the cause is the "freewheeling" or "catch" FET biasing itself on and effectively becoming a short circuit.

LSM D12 SMT DC/DC converters do not suffer from Output Reverse Conduction. They employ proprietary gate drive circuitry that makes them immune to applied output voltages.

### Thermal Considerations and Thermal Protection

The typical output-current thermal-derating curves shown below enable designers to determine how much current they can reliably derive from each model of the LSM D12 SMT's under known ambient-temperature and air-flow conditions. Similarly, the curves indicate how much air flow is required to reliably deliver a specific output current at known temperatures.

The highest temperatures in LSM D12 SMT's occur at their output inductor, whose heat is generated primarily by I<sup>2</sup>R losses. The derating curves were developed using thermocouples to monitor the inductor temperature and varying the load to keep that temperature below +110°C under the assorted conditions of air flow and air temperature. Once the temperature exceeds +115°C (approx.), the thermal protection will disable the converter. Automatic restart occurs after the temperature has dropped below +110°C.

LSM-T/10-D12 thermal protection occurs at +125°C and restart at approximately +115°C.

As you may deduce from the derating curves and observe in the efficiency curves on the following pages, LSM D12 SMT's maintain virtually constant efficiency from half to full load, and consequently deliver very impressive temperature performance even if operating at full load.

Lastly, when LSM D12 SMT's are installed in system boards, they are obviously subject to numerous factors and tolerances not taken into account here. If you are attempting to extract the most current out of these units under demanding temperature conditions, we advise you to monitor the output-inductor temperature to ensure it remains below +110°C at all times.

### Start Up Considerations

When power is first applied to the DC/DC converter, operation is different than when the converter is running and stabilized. There is some risk of start up difficulties if you do not observe several application features. Lower input voltage converters may have more problems here since they tend to have higher input currents. Operation is most critical with any combination of the following external factors:

- 1 - Low initial input line voltage and/or poor regulation of the input source.
- 2 - Full output load current on lower output voltage converters.
- 3 - Slow slew rate of input voltage.
- 4 - Longer distance to input voltage source and/or higher external input source impedance.
- 5 - Limited or insufficient ground plane. External wiring that is too small.
- 6 - Too small external input capacitance. Too high ESR.
- 7 - High output capacitance causing a start up charge overcurrent surge.
- 8 - Output loads with excessive inductive reactance or constant current characteristics.

If the input voltage is already at the low limit before power is applied, the start up surge current may instantaneously reduce the voltage at the input terminals to below the specified minimum voltage. Even if this voltage depression is very brief, this may interfere with the on-board controller and possibly cause a failed start. Or the converter may start but the input current load will now drive the input voltage below its running low limit and the converter will shut down.



If you measure the input voltage before start up with a Digital Voltmeter (DVM), the voltage may appear to be adequate. Limited external capacitance and/or too high a source impedance may cause a short downward spike at power up, causing an instantaneous voltage drop. Use an oscilloscope not a DVM to observe this spike. The converter's soft-start controller is sensitive to input voltage. What matters here is the actual voltage at the input terminals at all times.

Symptoms of start-up difficulties may include failed started, output oscillation or brief start up then overcurrent shutdown. Since the input voltage is never absolutely constant, the converter may start up some times and not others.

### Solutions

To improve start up, review the conditions above. One of the better solutions is to place a moderate size capacitor very close to the input terminals. You may need two parallel capacitors. A larger electrolytic or tantalum cap supplies the surge current and a smaller parallel low-ESR ceramic cap gives low AC impedance. Too large an electrolytic capacitor may have higher internal impedance (ESR) and/or lower the start up slew rate enough to upset the DC/DC's controller. Make sure the capacitors can tolerate reflected switching current pulses from the converter.

The capacitors will not help if the input source has poor regulation. A converter which starts successfully at 3.3 Volts will turn off if the input voltage decays to below the input voltage threshold, regardless of external capacitance.

Increase the input start up voltage if possible to raise the downward voltage spike. Also, make sure that the input voltage ramps up in a reasonably short time (less than a few milliseconds). If possible, move the input source closer to the converter to reduce ohmic losses in the input wiring. Remember that the input current is carried both by the wiring and the ground plane return. Make sure the ground plane uses adequate thickness copper. Run additional bus wire if necessary.

Any added output capacitor should use just enough capacitance (and no more) to reduce output noise at the load and to avoid marginal threshold noise problems with external logic. An output cap will also "decouple" inductive reactance in the load. Certain kinds of electronic loads include "constant current" characteristics which destabilize the output with insufficient capacitance. If the wiring to the eventual load is long, consider placing this decoupling cap at the load. Use the Remote Sense input to avoid ohmic voltage drop errors.

An elegant solution to start up problems is to apply the input voltage with the Remote On/Off control first in the off setting (for those converters with an On/Off Control). After the specified start-up delay (usually under 20 mSec), turn on the converter. The controller will have already been stabilized. The short delay will not be noticed in most applications. Be aware of applications which need "power management" (phased start up).

Finally, it is challenging to model some application circuits with absolute fidelity. How low is the resistance of your ground plane? What is the inductance (and distributed capacitance) of external wiring? Even a detailed mathematical model may not get all aspects of your circuit. Therefore it is difficult to give cap values which serve all applications. Some experimentation may be required.

### Typical Performance Curves for LSM D12 SMT Series

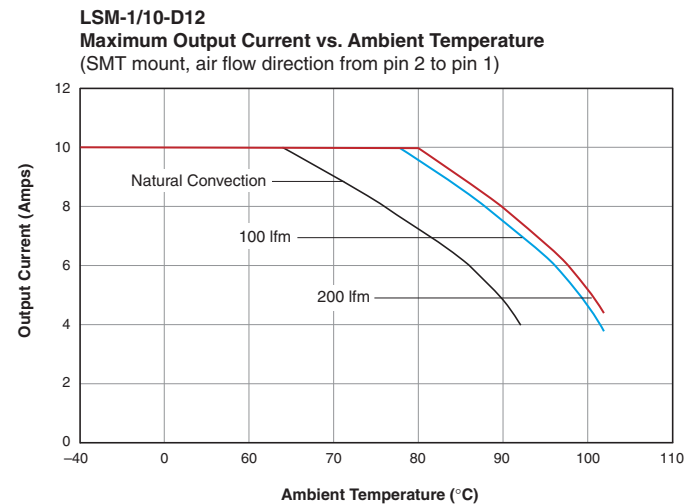
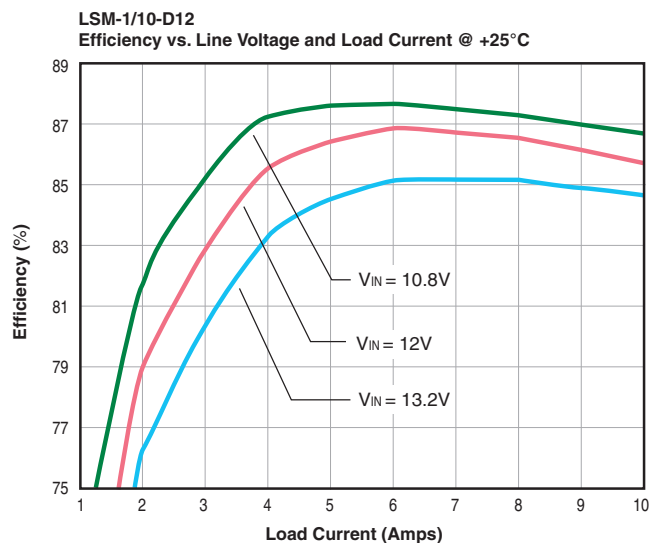

## Typical Performance Curves for LSM D12 SMT Series

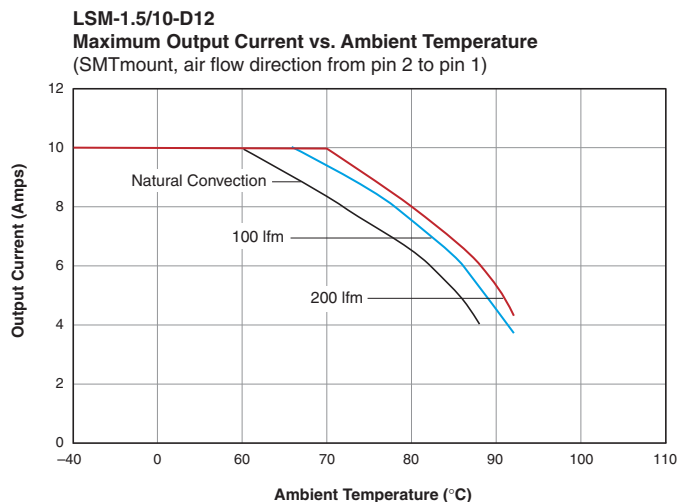
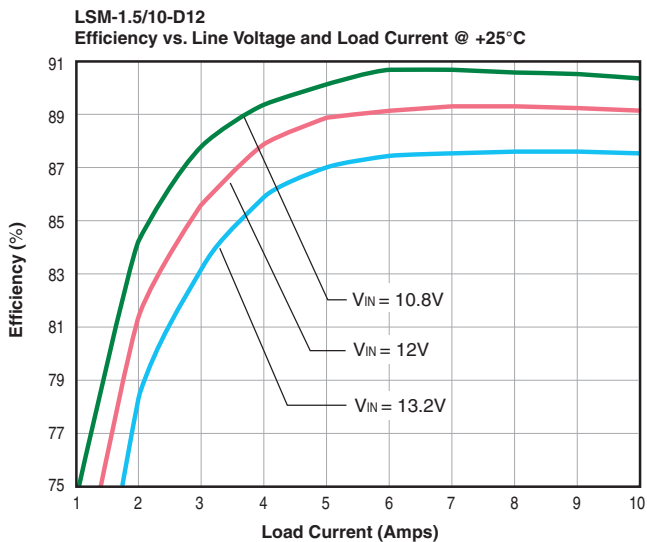
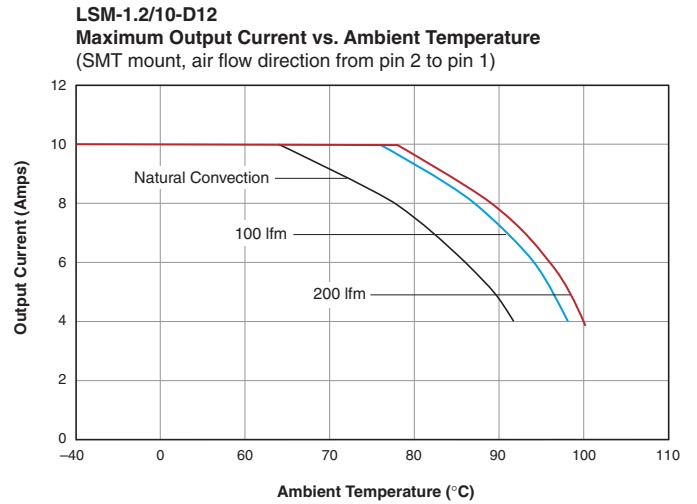
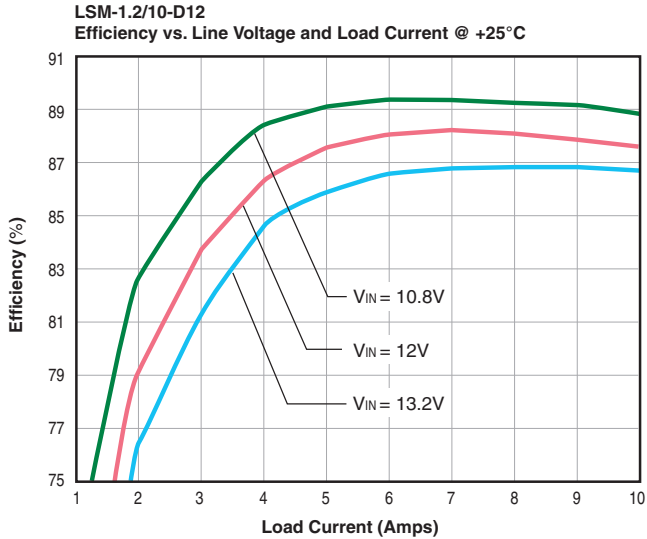

## Typical Performance Curves for LSM D12 SMT Series

**LSM-1.8/10-D12**  
Efficiency vs. Line Voltage and Load Current @ +25°C

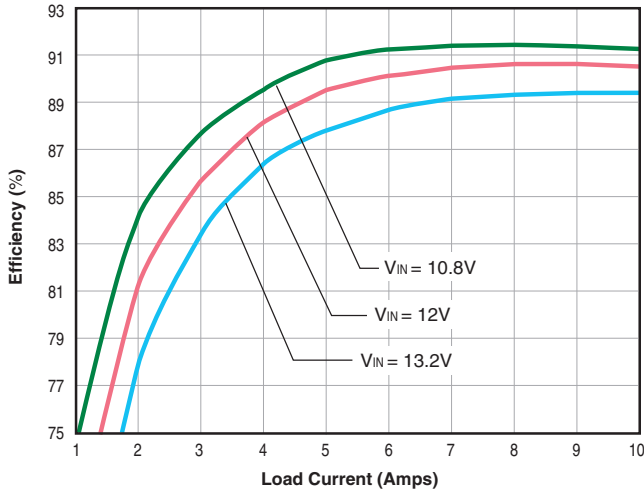

**LSM-1.8/10-D12**  
Maximum Output Current vs. Ambient Temperature  
(SMT mount, air flow direction from pin 2 to pin 1)

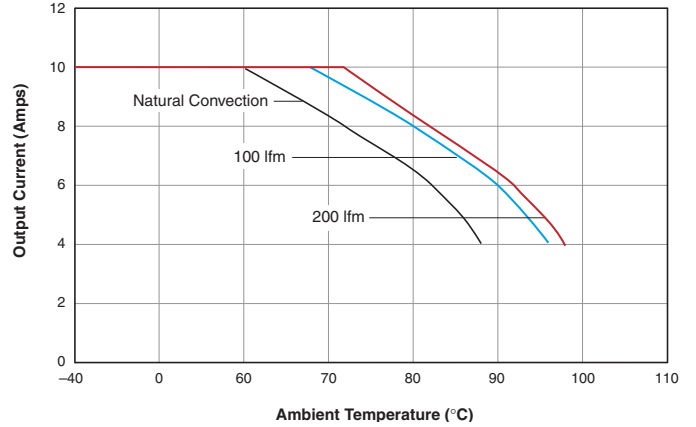

**LSM-2/10-D12**  
Efficiency vs. Line Voltage and Load Current @ +25°C

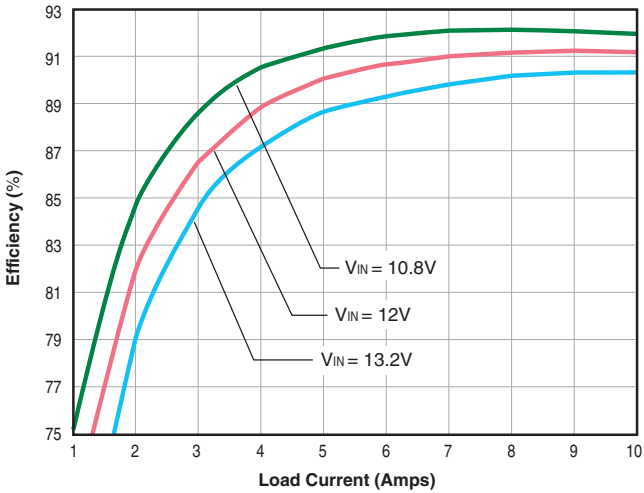

**LSM-2/10-D12**  
Maximum Output Current vs. Ambient Temperature  
(SMT mount, air flow direction from pin 2 to pin 1)

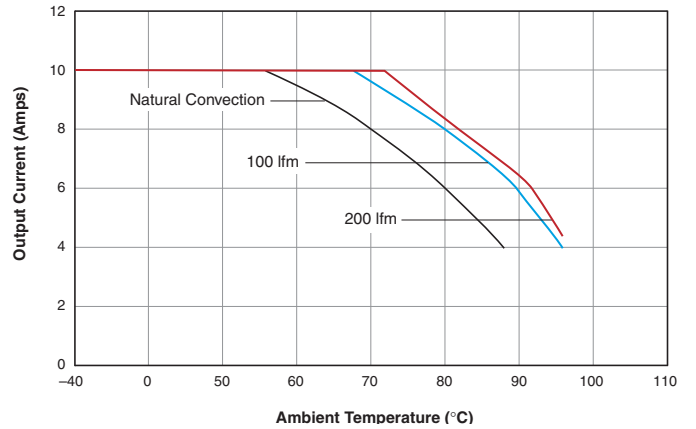

## Typical Performance Curves for LSM D12 SMT Series

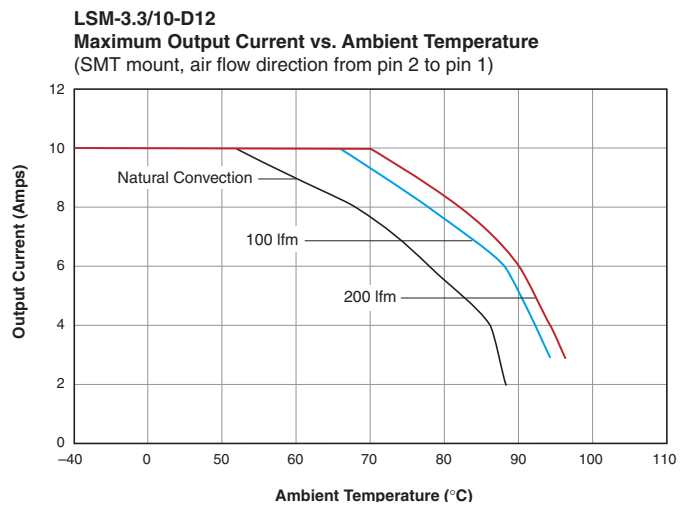
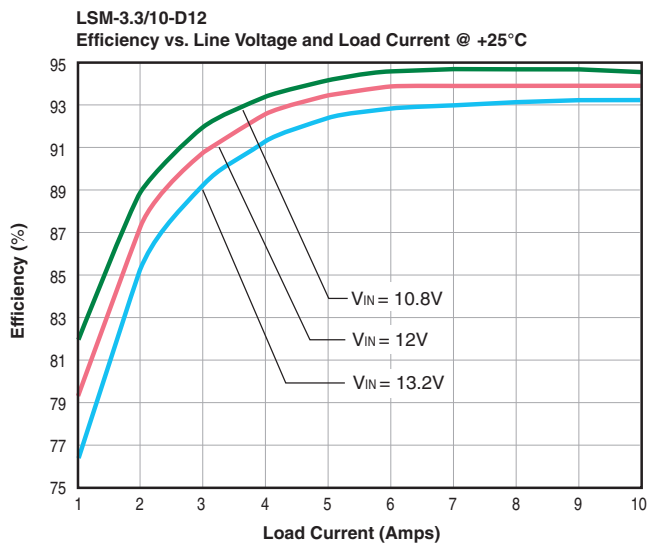
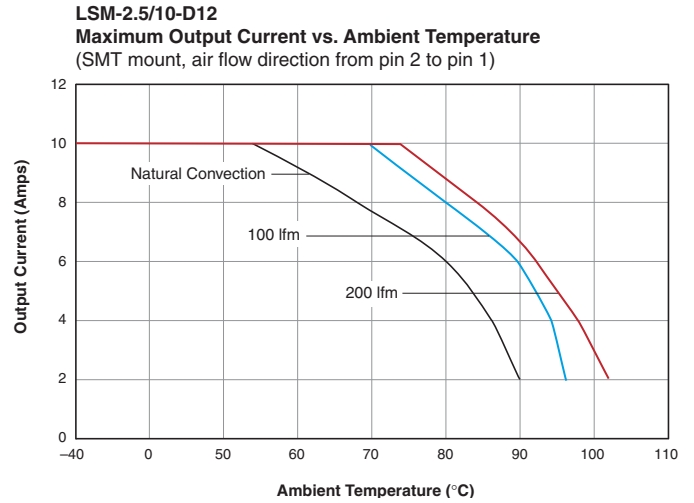
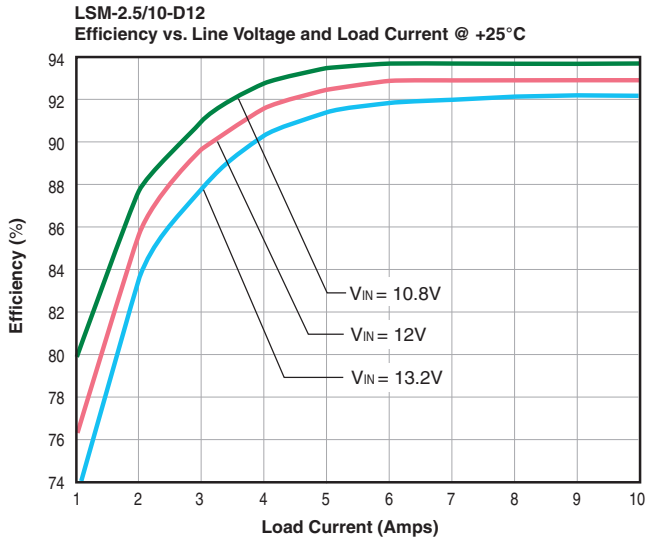

## Typical Performance Curves for LSM D12 SMT Series

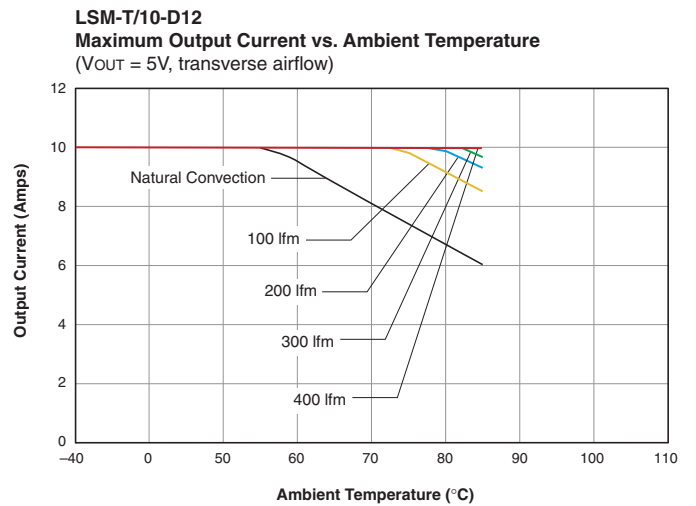
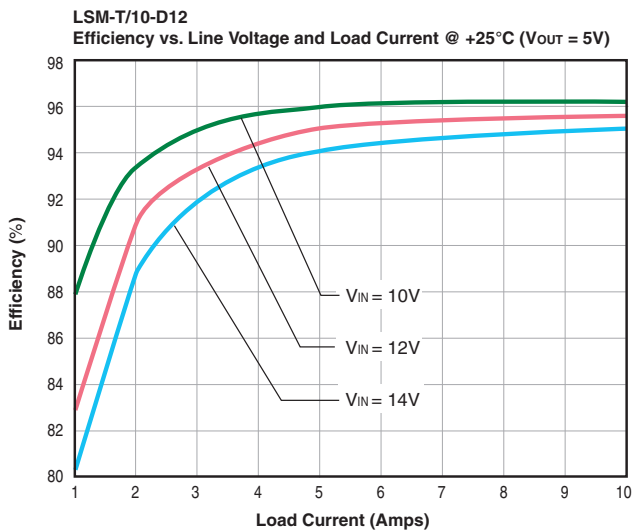
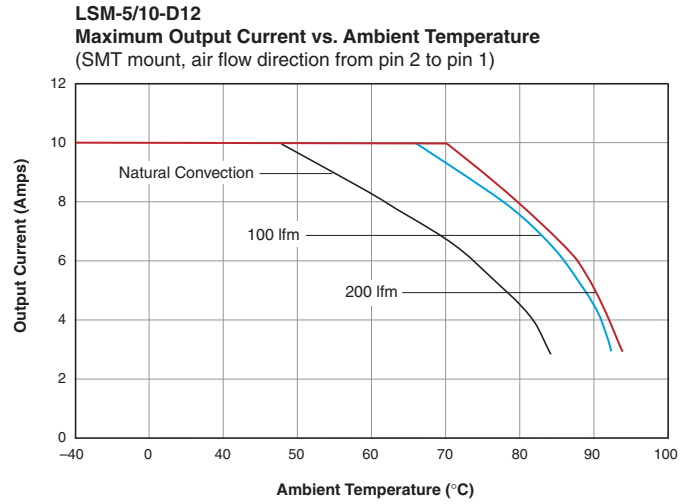
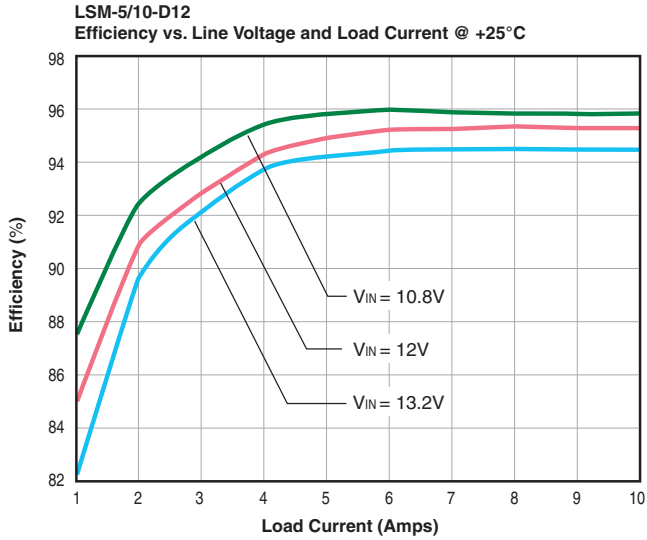



## Typical Performance Curves for LSM D12 SMT Series

**Start-Up from VIN**  
(VIN = 12V, IOUT = 0.8V/10A, COUT = 22μF)

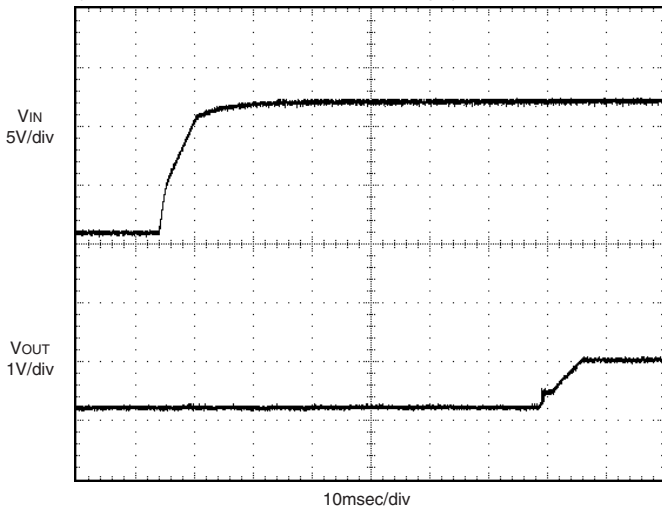

**Start-Up from ON/OFF**  
(VIN = 12V, IOUT = 0.8V/10A, COUT = 22μF)

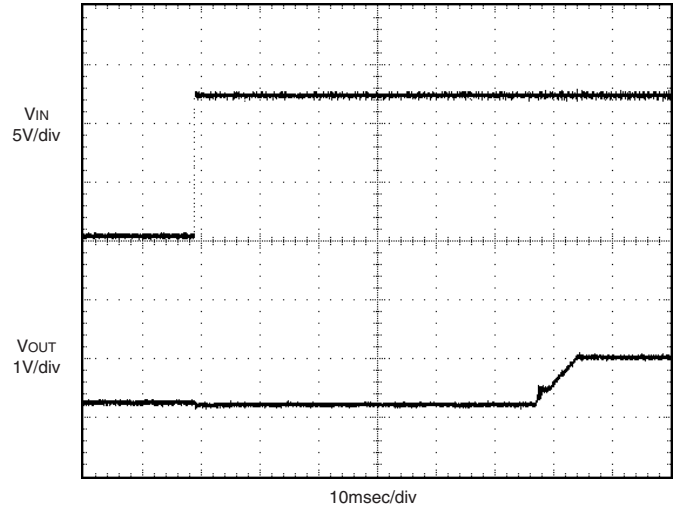

**Start-Up from VIN**  
(VIN = 12V, IOUT = 5V/10A, COUT = 22μF)

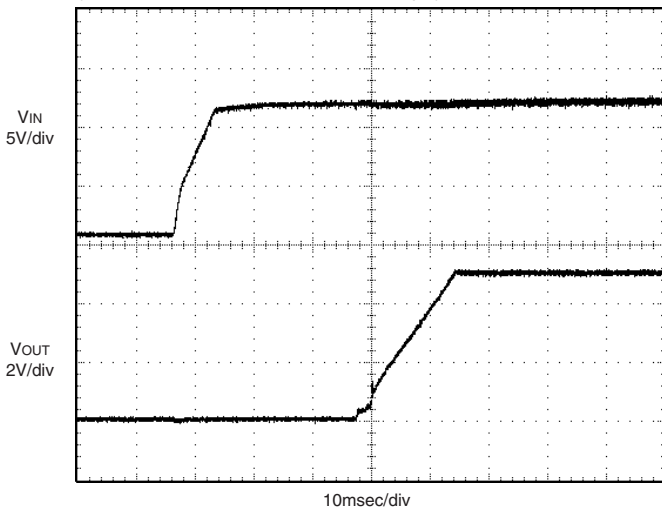

**Start-Up from ON/OFF**  
(VIN = 12V, IOUT = 5V/10A, COUT = 22μF)

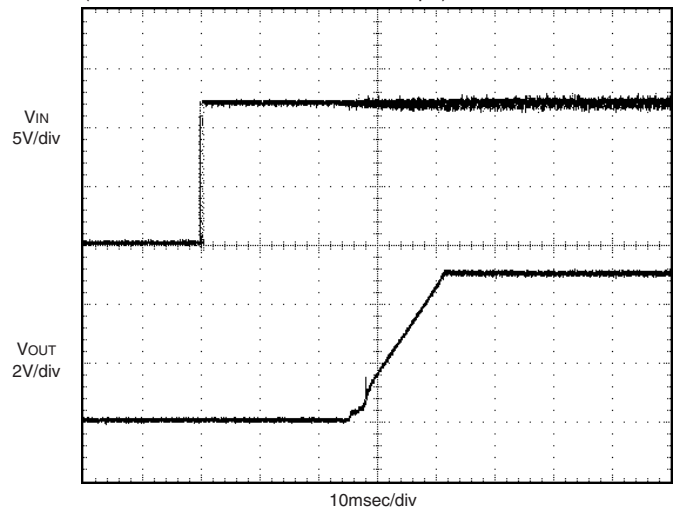

## Typical Performance Curves for LSM D12 SMT Series

**Input Reflected Ripple Current**  
(Input Filter = 220 $\mu$ F/12 $\mu$ H/33 $\mu$ F, V<sub>IN</sub> = 12V, I<sub>OUT</sub> = 5V/10A)

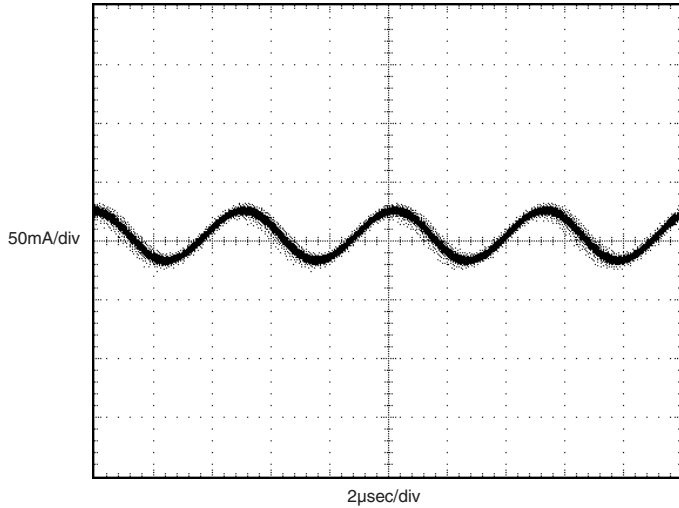

**Output Hiccup**  
(LSM-5/10-D12 Shorted V<sub>OUT</sub>, V<sub>IN</sub> = 12V)

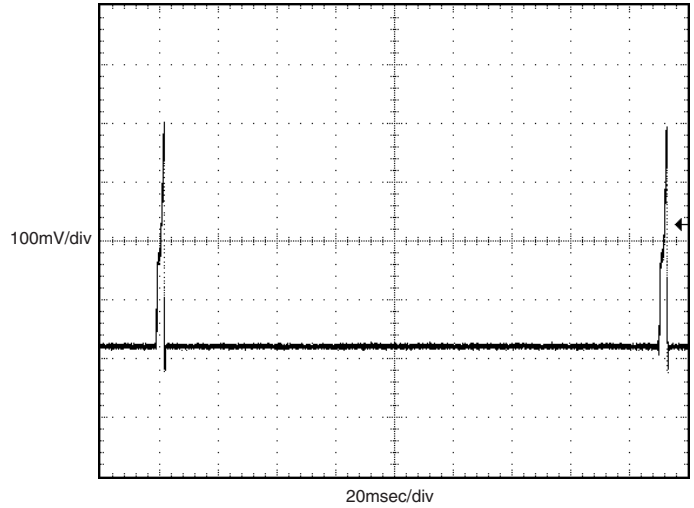

**Output Ripple and Noise**  
(V<sub>IN</sub> = 12V, V<sub>OUT</sub> = 5V/10A, C<sub>OUT</sub> = 22 $\mu$ F)

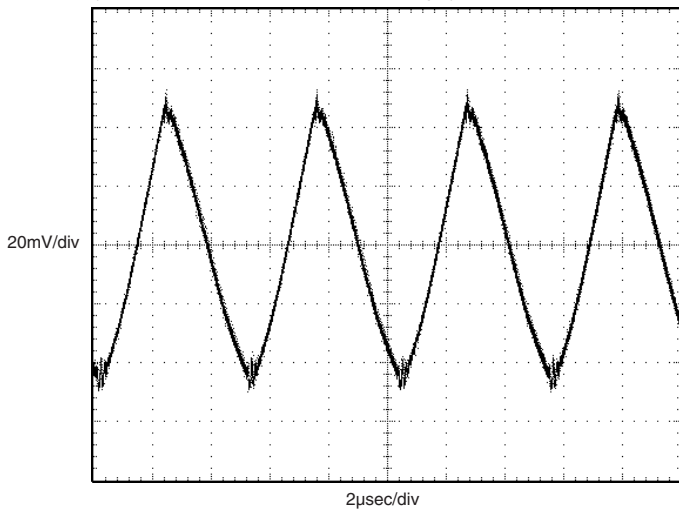

**Output Ripple and Noise**  
(V<sub>IN</sub> = 12V, V<sub>OUT</sub> = 0.8V/10A, C<sub>OUT</sub> = 22 $\mu$ F)

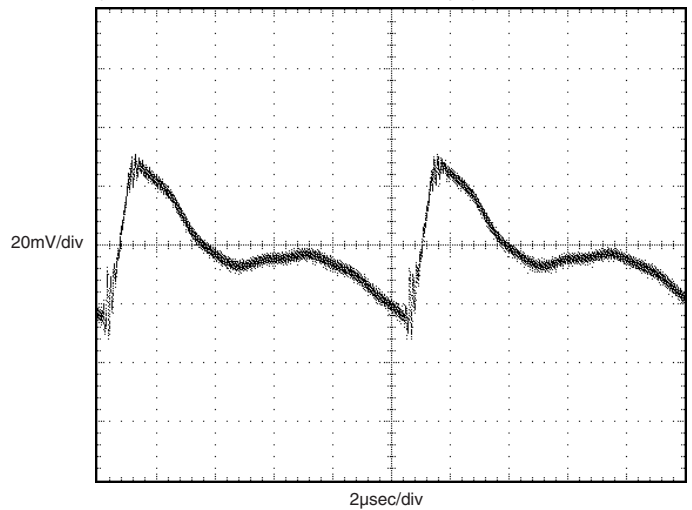

## Typical Performance Curves for LSM D12 SMT Series

**Dynamic Load Response**

(V<sub>IN</sub> = 12V, V<sub>OUT</sub> = 5V, 0 to 10A Step, C<sub>OUT</sub> = 22μF)

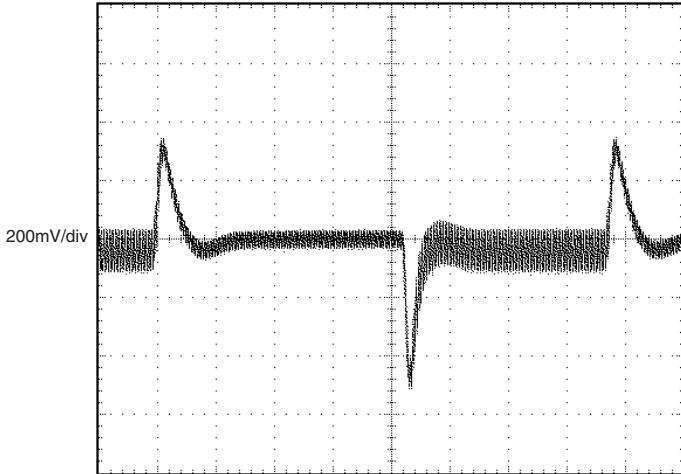

100μsec/div

**Dynamic Load Response**

(V<sub>IN</sub> = 12V, V<sub>OUT</sub> = 5V, 0 to 10A Step, Co = 22μF + 1000μF Oscon)

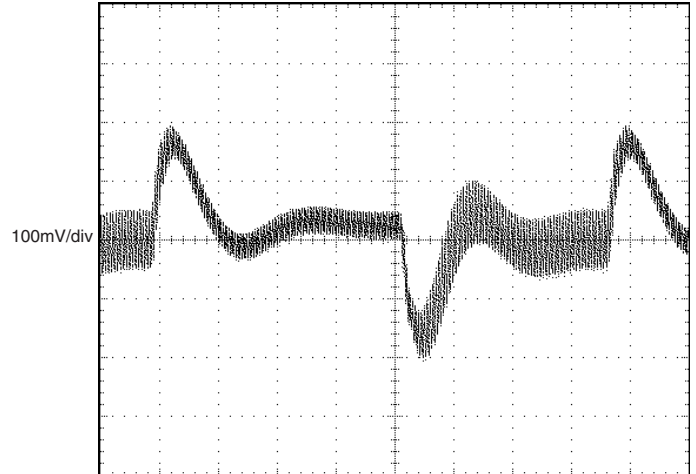

100μsec/div

**Dynamic Load Response**

(V<sub>IN</sub> = 12V, V<sub>OUT</sub> = 0.8V, 5 to 10A Step, C<sub>OUT</sub> = 22μF)

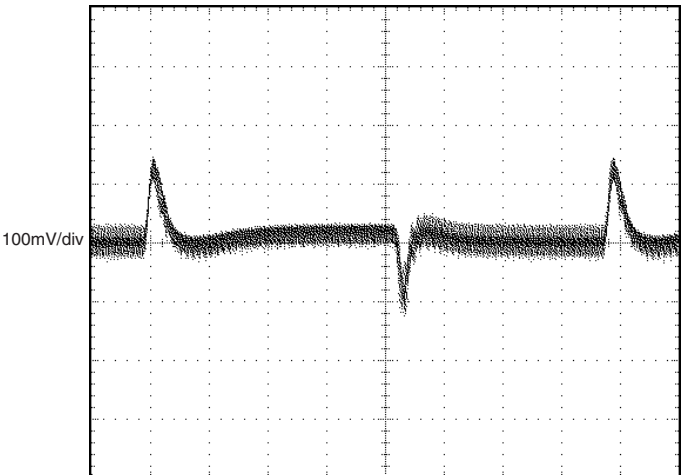

100μsec/div

**Dynamic Load Response**

(V<sub>IN</sub> = 12V, V<sub>OUT</sub> = 5V, 5 to 10A Step, Co = 22μF + 1000μF Oscon)

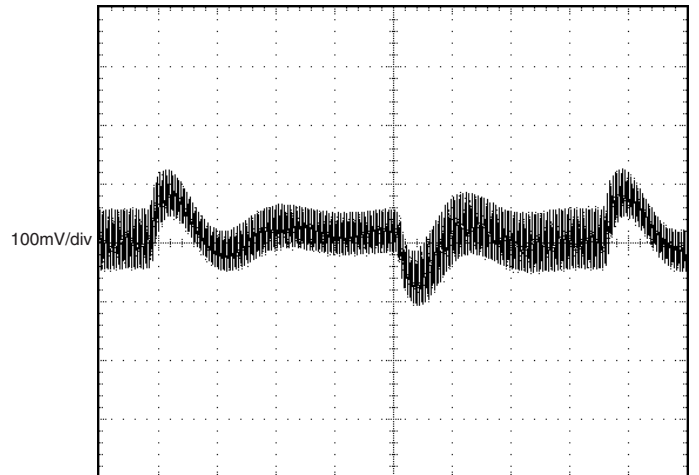

100μsec/div

### Tape & Reel Surface Mount Package

Murata Power Solutions' LSM series DC/DC converters are the only higher-current (10A) SMT DC/DC's that can be automatically "pick-and-placed" using standard vacuum-pickup equipment (nozzle size and style, vacuum pressure and placement speed may need to be optimized for automated pick and place) and subsequently reflowed using high-temperature, lead-free solder.

Virtually all SMT DC/DCs today are unprotected "open-frame" devices assembled by their vendors with high-temperature solder (usually Sn96.5/Ag3.5 with a melting point +221°C) so that you may attach them to your board using low-temperature solder (usually Sn63/Pb37 with a melting point of +183°C). Conceptually straightforward, this "stepped" solder approach has its limitations, and it is clearly out of step with an industry trending toward the broad use of lead-free solders. Are you to experiment and develop reflow profiles from other vendors that ensure the components on those DC/DC never exceed 215-216°C? If those components get too hot, "double-reflow" could compromise the reliability of their solder joints. Virtually all these devices demand you "cool down" the Sn63 profile you are likely using today.

MPS is not exempted from the Laws of Physics. And we do not have magic solders no one else has. We do have a simple and practical, straightforward approach that works. We assemble our SMT DC/DC's on a thermally-stable plastic lead-frame (nylon 46, UL94V-0 flammability rated) using a high temperature lead-free solder. In addition, the LSM is transitioning to RoHS (Reduction of Hazardous Substances) construction and SAC 305 RoHS-approved solder. The lead-frame ensures coplanarity (to within 0.004 in.) of the unit's copper leads. These leads are gold-plated with a nickel underplate. See Mechanical Data for additional information.

The disposable heat shield, with a cutaway exposing the package leads, provides thermal insulation to internal components during reflow and doubles as the vacuum pick-up location. The insulation properties of the heat shield are so effective that temperature differentials as high as 50°C develop inside-to-outside the shield. Oven temperature profiles with peaks of 250-260°C and dwell times exceeding 2 minutes above 221°C are easily achieved. MPS's new-generation SMT units are shipped in stackable, JEDEC-style plastic tray.

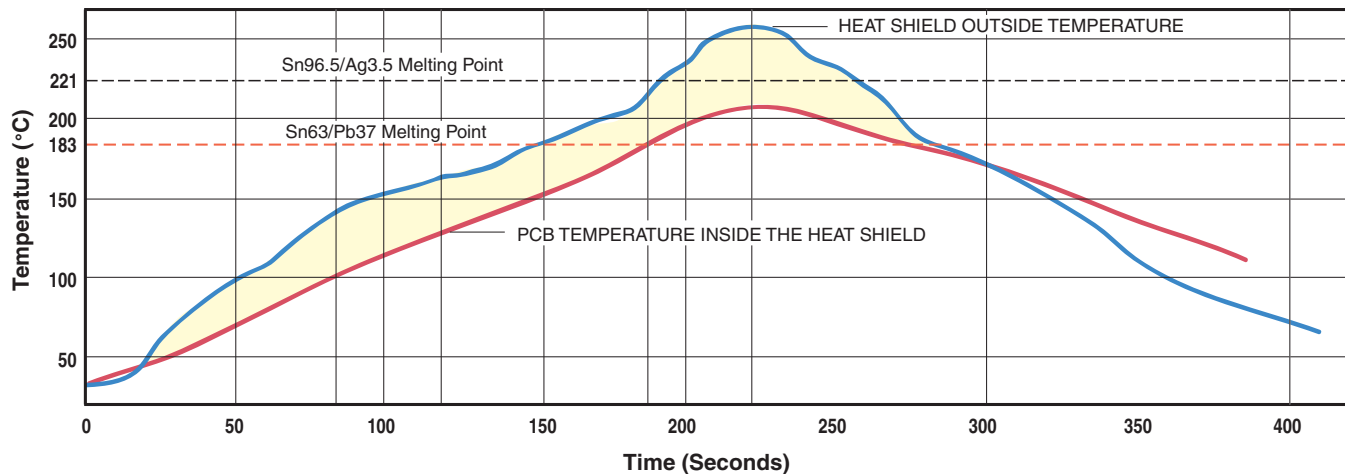

Figure 6. Reflow Solder Profile

Murata Power Solutions' new-generation LSM SMT DC/DC converters are shipped in quantities of 150 modules per tape and reel.

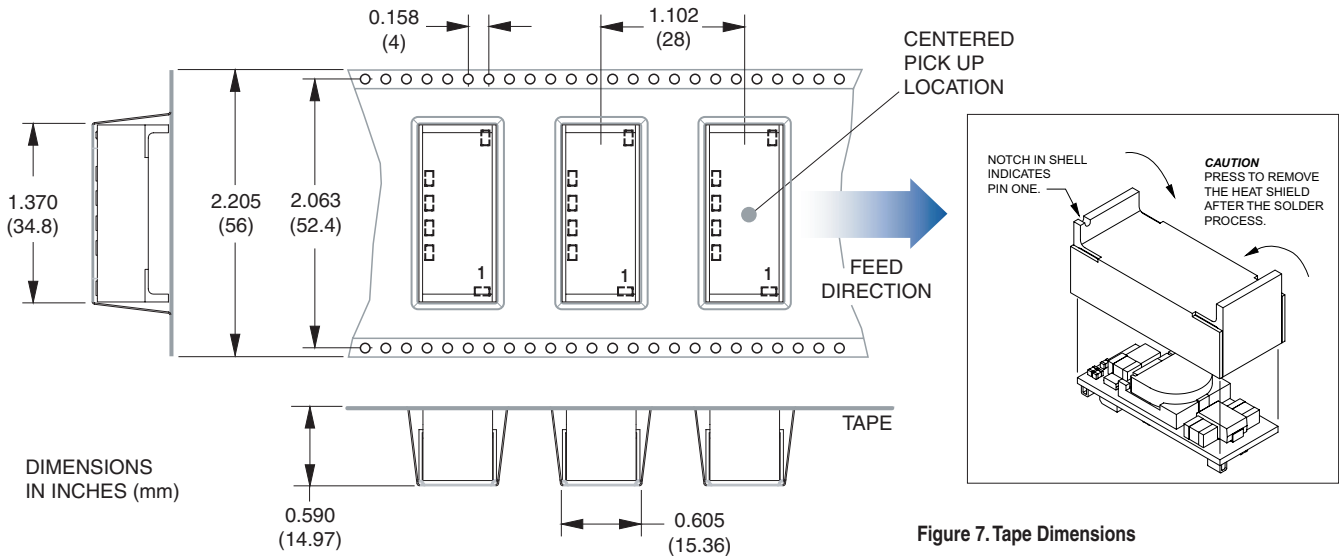

Figure 7. Tape Dimensions

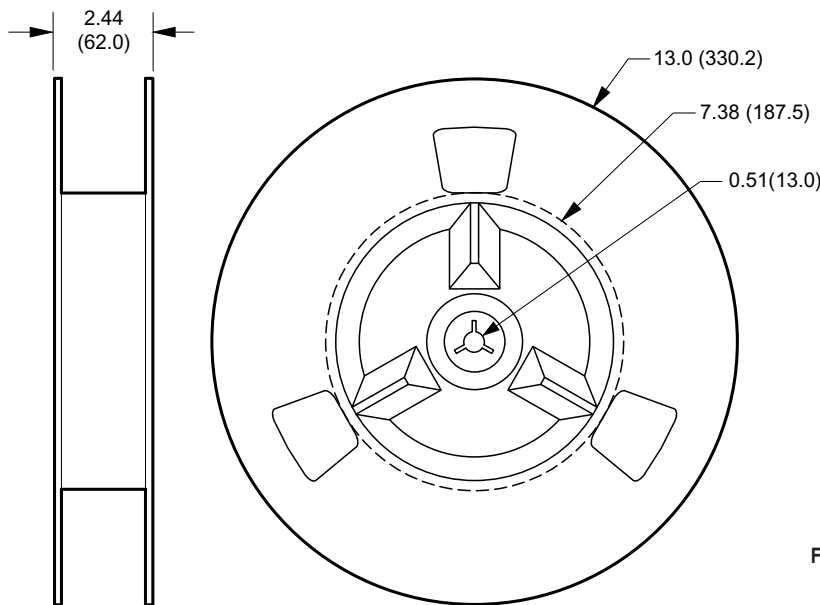

Figure 8. Reel Dimensions

Murata Power Solutions, Inc.  
11 Cabot Boulevard, Mansfield, MA 02048-1151 U.S.A.  
Tel: (508) 339-3000 (800) 233-2765 Fax: (508) 339-6356  
[www.murata-ps.com](http://www.murata-ps.com) email: [sales@murata-ps.com](mailto:sales@murata-ps.com)  
ISO 9001 REGISTERED

3/3/08

- USA:** Tucson (AZ), Tel: (800) 547 2537, email: [sales@murata-ps.com](mailto:sales@murata-ps.com)
- Canada:** Toronto, Tel: (866) 740 1232, email: [toronto@murata-ps.com](mailto:toronto@murata-ps.com)
- UK:** Milton Keynes, Tel: +44 (0)1908 615232, email: [mk@murata-ps.com](mailto:mk@murata-ps.com)
- France:** Montigny Le Bretonneux, Tel: +33 (0)1 34 60 01 01, email: [france@murata-ps.com](mailto:france@murata-ps.com)
- Germany:** München, Tel: +49 (0)89-544334-0, email: [ped.munich@murata-ps.com](mailto:ped.munich@murata-ps.com)
- Japan:** Tokyo, Tel: 3-3779-1031, email: [sales\\_tokyo@murata-ps.com](mailto:sales_tokyo@murata-ps.com)  
Osaka, Tel: 6-6354-2025, email: [sales\\_osaka@murata-ps.com](mailto:sales_osaka@murata-ps.com)  
**Website:** [www.murata-ps.jp](http://www.murata-ps.jp)
- China:** Shanghai, Tel: +86 215 027 3678, email: [shanghai@murata-ps.com](mailto:shanghai@murata-ps.com)  
Guangzhou, Tel: +86 208 221 8066, email: [guangzhou@murata-ps.com](mailto:guangzhou@murata-ps.com)

Murata Power Solutions, Inc. makes no representation that the use of its products in the circuits described herein, or the use of other technical information contained herein, will not infringe upon existing or future patent rights. The descriptions contained herein do not imply the granting of licenses to make, use, or sell equipment constructed in accordance therewith. Specifications are subject to change without notice.  
© 2008 Murata Power Solutions, Inc.