

KEY FEATURES

- Power Module for PCB Mountable
- 2:1 Input Range
- Low Ripple and Noise
- Regulated Output
- Synchronous-rectifier Topologies
- Vout Trim and ON/OFF Control Function
- 2-Years Product Warranty

ELECTRICAL SPECIFICATIONS

Model No. (Single Output)	SU40-12-5S	SU40-12-12S	SU40-12-15S	SU40-12-24S
Max Output Wattage (W)	40W	40W	40W	40W
Input Voltage (V.DC.)	12V (9-18V)	12V (9-18V)	12V (9-18V)	12V (9-18V)
Output Voltage (V.DC.)	5V / 8000mA	12V / 3333mA	15V / 2666mA	24V / 1666mA
Efficiency	85%	85%	85%	85%

Model No. (Single Output)	SU40-24-5S	SU40-24-12S	SU40-24-15S	SU40-24-24S
Max Output Wattage (W)	40W	40W	40W	40W
Input Voltage (V.DC.)	24V (18-36V)	24V (18-36V)	24V (18-36V)	24V (18-36V)
Output Voltage (V.DC.)	5V / 8000mA	12V / 3333mA	15V / 2666mA	24V / 1666mA
Efficiency	87%	86%	86%	86%

Model No. (Single Output)	SU40-48-1.8S	SU40-48-2.5S	SU40-48-3.3S	SU40-48-5S	SU40-48-12S	SU40-48-15S	SU40-48-24S
Max Output Wattage (W)	14.4W	20W	26.4W	40W	40W	40W	40W
Input Voltage (V.DC.)	48V (36-75V)	48V (36-75V)	48V (36-75V)	48V (36-75V)	48V (36-75V)	48V (36-75V)	48V (36-75V)
Output Voltage (V.DC.)	1.8V / 8000mA	2.5V / 8000mA	3.3V / 8000mA	5V / 8000mA	12V / 3333mA	15V / 2666mA	24V / 1666mA
Efficiency	76%	82%	84%	88%	87%	87%	87%

Model No. (Single Output)	SU40-48-1.8S	SU40-48-2.5S	SU40-48-3.3S	SU40-12-5S SU40-24-5S SU40-48-5S	SU40-12-12S SU40-24-12S SU40-48-12S	SU40-12-15S SU40-24-15S SU40-48-15S	SU40-12-24S SU40-24-24S SU40-48-24S	
Max Output Wattage (W)	14.4W	20W	26.4W	40W	40W	40W	40W	
Input	Input Filter π type							
Output	Voltage (V.DC.)	1.8	2.5	3.3	5	12	15	24
	Voltage Accuracy	$\pm 2\%$						
	Current (mA) max	8000	8000	8000	8000	3333	2666	1666
	Minimum Load	0%						
	Line Regulation(LL-HL) (typ)	$\pm 0.5\%$						
	Load Regulation (10-100%) (typ.)	$\pm 1\%$						
	Ripple	50 mV max.				$\pm 1\%$ max.		
	Noise	100 mV max.				$\pm 1\%$ max.		
Trim	$\pm 10\%$							
Switching Frequency	5V Output: 250KHz		12V Input: 200KHz		others: 400KHz			
Protection	Over power Protection	Works over 120% of rating and recovers automatically.						
	Over voltage Protection	Zener diode clamp						
	Short Circuit Protection	Hiccup mode, auto-recovery						
Isolation	Voltage	1600 VDC.						
	Resistance	10^8 ohms						
	Capacitance	1000 pF						
Environment	Operating Temperature	-25°C...+70°C (with derating)						
	Storage Temperature	-55°C...+105°C						
	Case Temperature	+100°C max.						
	Temperature Coefficient	$\pm 0.02\%$ Per°C						
	Humidity	95% RH						
	MTBF	>550,000 h @ 25°C (MIL-HDBK-217F)						
Physical	Dimension (L x W x H)	2.0 x 2.0 x 0.45 Inches (50.8 x 50.8 x 11.4 mm) Tolerance ± 0.5 mm						
	Case Material	Nickel-Coated Copper with Non-Conductive Base, Six-side shielded.						
	Weight	70 g						
	Cooling Method	Free-air convection						

All specifications valid at nominal input voltage, full load and +25°C after warm-up time unless otherwise stated.

ELECTRICAL SPECIFICATIONS

Model No. (Dual · Triple Output)	SU40-12-5D	SU40-12-12D	SU40-12-15D	SU40-12-5S12D	SU40-12-5S15D
Input Voltage (V.DC.)	12V (9-18V)	12V (9-18V)	12V (9-18V)	12V (9-18V)	12V (9-18V)
Output Voltage (V.DC.)	±5V / ±3500mA	±12V / ±1666mA	±15V / ±1320mA	5/±12V / 5000/±600mA	5/±15V / 5000/±500mA
Efficiency	82%	85%	85%	85%	85%

Model No. (Dual · Triple Output)	SU40-24-5D	SU40-24-12D	SU40-24-15D	SU40-24-5S12D	SU40-24-5S15D
Input Voltage (V.DC.)	24V (18-36V)	24V (18-36V)	24V (18-36V)	24V (18-36V)	24V (18-36V)
Output Voltage (V.DC.)	±5V / ±3500mA	±12V / ±1666mA	±15V / ±1320mA	5/±12V / 5000/±600mA	5/±15V / 5000/±500mA
Efficiency	83%	86%	86%	86%	86%

Model No. (Dual · Triple Output)	SU40-48-5D	SU40-48-12D	SU40-48-15D	SU40-48-5S12D	SU40-48-5S15D
Input Voltage (V.DC.)	48V (36-75V)	48V (36-75V)	48V (36-75V)	48V (36-75V)	48V (36-75V)
Output Voltage (V.DC.)	±5V / ±3500mA	±12V / ±1666mA	±15V / ±1320mA	5/±12V / 5000/±600mA	5/±15V / 5000/±500mA
Efficiency	84%	87%	87%	87%	87%

Model No. (Dual · Triple Output)	SU40-12-5D SU40-24-5D SU40-48-5D	SU40-12-12D SU40-24-12D SU40-48-12D	SU40-12-15D SU40-24-15D SU40-48-15D	SU40-12-5S12D SU40-24-5S12D SU40-48-5S12D	SU40-12-5S15D SU40-24-5S15D SU40-48-5S15D	
Max Output Wattage (W)	35W	40W	40W	40W	40W	
Input	Input Filter π type					
Output	Voltage (V.DC.)	±5	±12	±15	5/±12	5/±15
	Voltage Accuracy	±2%		±2% / ±5%		
	Current (mA) max	±3500	±1666	±1320	5000 / ±600	5000 / ±500
	Minimum Load	0%		10%		
	Line Regulation (LL-HL) (typ.)	±0.5%		±1% / ±5%		
	Load Regulation (10-100%) (typ.)	±2%		±3% / ±5%		
	Load Cross Regulation (25%) (typ.)	Triple(main): ±2% Triple(auxiliary): ±5%				
	Ripple	<0.2% Vout +20mV max (Vp-p)				
	Noise	<0.5% Vout +50mV max (Vp-p)				
	Trim	±10%			None	
Switching Frequency	5V Output: 250KHz		12V Input: 200KHz	others: 400KHz		
Protection	Over Power Protection	Works over 120% of rating and recovers automatically.				
	Over Voltage Protection	Zener diode clamp				
	Short Circuit Protection	Hiccup, auto-recovery				
Isolation	Voltage	1600 VDC.				
	Resistance	10 ⁸ ohms				
	Capacitance	1000 pF				
Environment	Operating Temperature	-25°C...+70°C (with derating)				
	Storage Temperature	-55°C...+105°C				
	Case Temperature	+100°C max.				
	Temperature Coefficient	±0.02% Per°C				
	Humidity	95% RH				
	MTBF	>550,000 h @ 25°C (MIL-HDBK-217E)				
Physical	Dimension (L x W x H)	2.0 x 2.0 x 0.45 Inches (50.8 x 50.8 x 11.4 mm) Tolerance ±0.5 mm				
	Case Material	Nickel-Coated Copper with Non-Conductive Base, Six-side shielded.				
	Weight	70 g				
	Cooling Method	Free-air convection				
Safety	Agency Approvals CE (Pending)					
EMC	EMI (Conducted & Radiated Emission) EN 55022 class A					

All specifications valid at nominal input voltage, full load and +25°C after warm-up time unless otherwise stated.

OUTPUT NOISE

The output noise is measured with 10 μ F tantalum capacitor and 0.1 μ F ceramic capacitor across output.

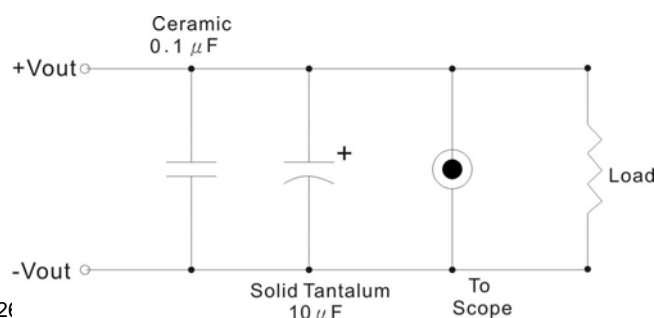

MECHANICAL DIMENSION (Top View)

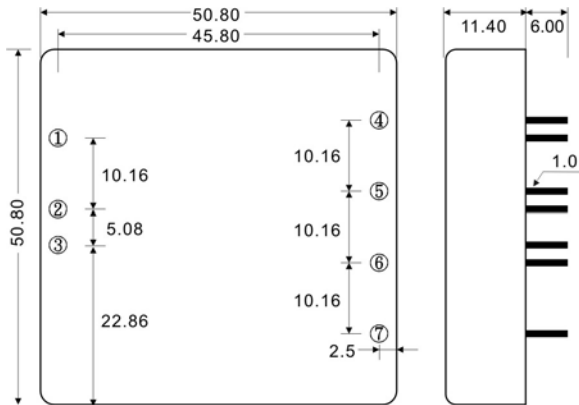

PIN#	Single	Dual	Triple
1	ON / OFF	ON / OFF	ON / OFF
2	-VIN	-VIN	-VIN
3	+VIN	+VIN	+VIN
4	TRIM	TRIM	-VOUT
5	-VOUT	-VOUT	COMMON
6	+VOUT	COMMON	+5V OUT
7	NC	+VOUT	+VOUT

BLOCK DIAGRAM

Output Voltage (V.DC) : 1.8, 2.5V, 3.3V, 5V

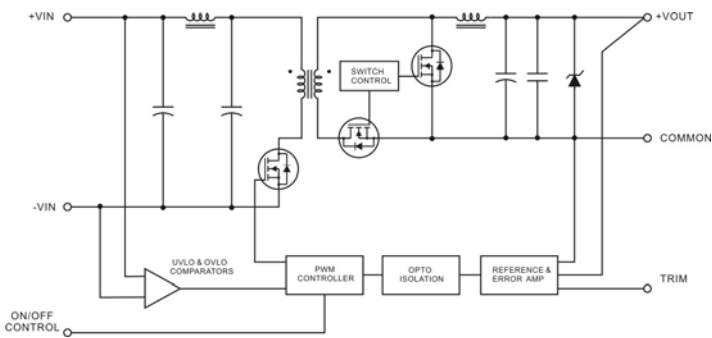

Output Voltage (V.DC) : 12V, 15V, 24V

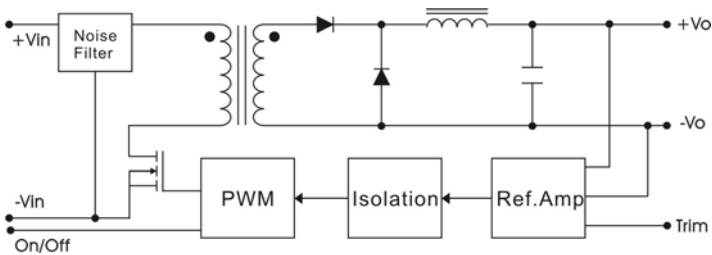

DERATING

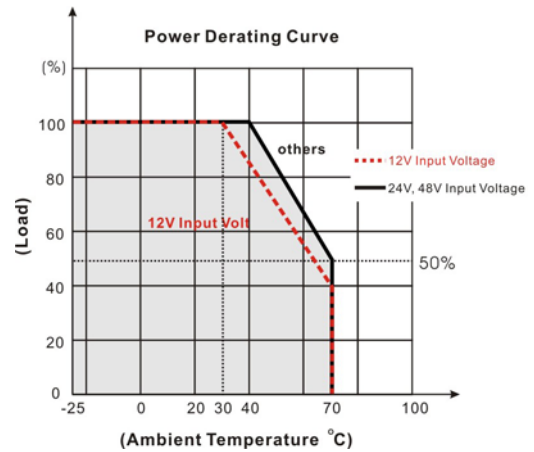

REMOTE

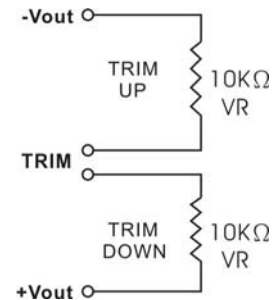

Dual Output

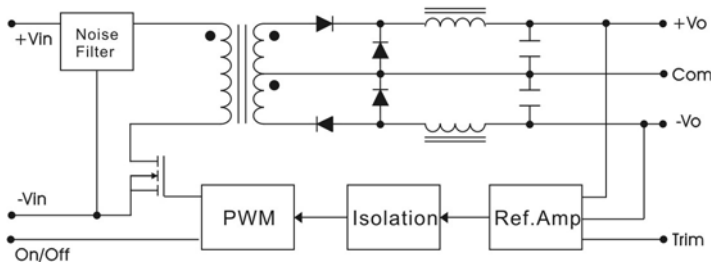

Triple Output

