

DESCRIPTION

DDP400 and MDP400 are series of extremely high efficiency, small form factor AC-DC power supplies.

The series provide a steady 400 W of regulated DC power through the full input range of 90 to 264 V_{AC}. Based on an open frame, 3.00" x 6.50" x 1.46" form factor, the series can be offered in five different packages to enable designers to integrate more advanced features into a system without compromising on its size.

By converting energy at 94% typical efficiency, the DDP400 and MDP400 series generate less heat facilitating thermal management in space constrained system and offering high reliability.

Both the DDP and MDP series are available in three standard output voltages: 12, 24, 48 V_{DC} and offer an auxiliary 12 V_{DC} and 5 V_{DC} stand-by outputs. Available control signals include AC_OK and remote on/off.

Open frame and boxed units can deliver full output power from -20 to 50 °C, can operate up to 70 °C with de-rating and is capable to start up from - 20 °C.

A built in fan speed control circuit assure proper forced air cooling minimizing operation noise and enhancing useful life.

The MDP400 range comply with the 3rd edition of the UL/IEC60601-1 safety standards for medical equipments and the DDP400 range comply with the 2nd edition of the UL/IEC 60950-1 standards for IT equipments. Both the series meets the EN55022 EMC limits of Class B for conducted and class A for radiated emissions as well as the IEC/EN 61000-3 and IEC/EN 61000-4 EMC standards.

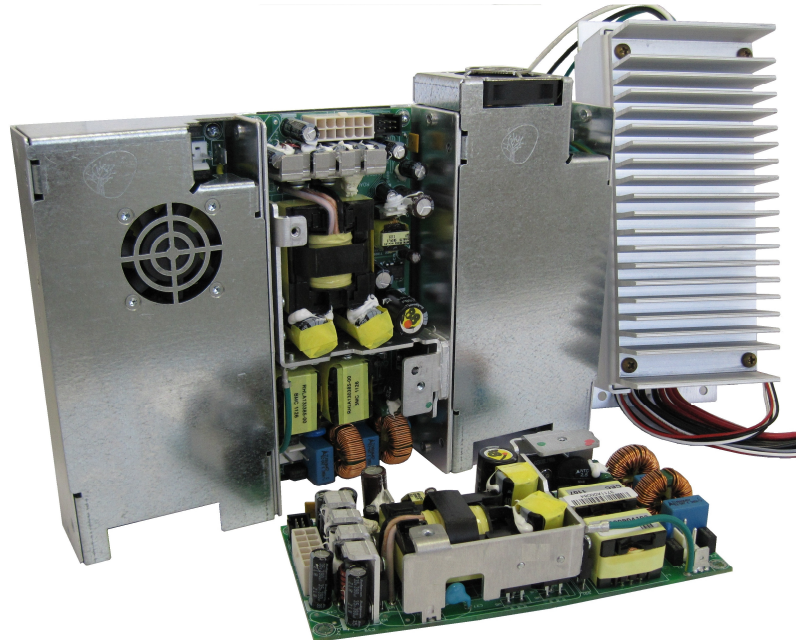

2 YEAR WARRANTY

KEY FEATURES

- Universal input voltage range
- 400 W rated power (440 W peak)
- Extremely high efficiency (94% typical)
- Low stand-by consumption (<0.5 W)
- 12V, 24V and 48V standard output variants
- Active PFC, EN61000-3-2 compliant (Class C, >40 W load).
- Low earth leakage current
- Fan speed control circuit (off at <50W load)
- Over temperature protection
- OV, OC, and short circuit protections
- Stand-by +5 V Output
- Auxiliary fan +12 V output
- Remote on/off and power good signals
- U-chassis, boxed and sealed packages fit 1U applications.
- ANSI/AAMI ES60601-1 3rd ed. compliant (Medical Equipment)
- RoHS-6 compliant (EU directive 2002/95/EC)
- 4000 m altitude operation.

MARKET SEGMENT AND APPLICATIONS

- Video Wall Display & Entertainment
- Industrial & Process Control
- Telecommunications
- Laboratory Equipment
- Test and Measurement Equipment
- Medical applications

MODEL CODING AND OUTPUT RATINGS

Model Grade and Output Power	Output Nominal Voltage	Package/Fan Options
ITE: DDP400-	12 V _{DC} : US12-	Open Frame: OF
Medical: MDP400-	24 V _{DC} : US24-	U-Chassis: UC
	48 V _{DC} : US48-	Vented Cover: VC
		Front Fan: FF
		Sealed Conduction/Convection Cooling: SC

D	DP400	-	US	24	-	OF
						UC
						VC
M	DP400	-	US	48	-	FF
						VC
						SC

Heat sink can be ordered as an accessory using the code:

DDP-HS

Mounting kit includes 4X screws, M4x10, and the thermally conductive graphite sheet

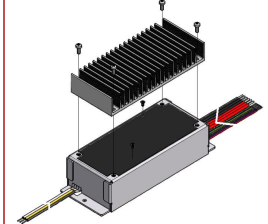

Model Number	V1 (V)	I1 ¹ Convection (A)	I1 ² Forced air (A)	V1 ³ Ripple (mV)	V2 (V)	I2 ¹ Convection (A)	I2 ² Forced Air (A)	V2 ³ Ripple (mV)	5V _{SB} (V)	I5V _{SB} ¹ Convection (A)	I5V _{SB} ² Forced air (A)	5V _{SB} ³ Ripple (mV)
DDP/MDP400-US12_OF/UC/VC/FF	12	20.8	33.3	120	12	1	1	240	5	1.5	2	50
DDP/MDP400-US24_OF/UC/VC/FF	24	10.4	16.7	240	12	1	1	240	5	1.5	2	50
DDP/MDP400-US48_OF/UC/VC/FF	48	5.2	8.3	480	12	1	1	240	5	1.5	2	50
DDP/MDP400-US12-SC	12	25/33.3 ⁴	33.3	120	12	1	1	240	5	1.5	2	50
DDP/MDP400-US24-SC	24	12.5/16.7 ⁴	16.7	240	12	1	1	240	5	1.5	2	50
DDP/MDP400-US48-SC	48	6.2/8.3 ⁴	8.3	480	12	1	1	240	5	1.5	2	50

¹ The combined output power of V1, V2 and 5 V_{SB} for all models, when convection cooled, must not exceed 250 W up to 50 °C, and 200 W up to 70 °C ambient temperature. See de-rating curves below.

² The combined output power of V1, V2 and 5V_{SB} must not exceed 400 W for all models at 300 LFM, (the maximum heat sink temperature must remain below +110 °C at +50 °C ambient temperature).

³ Peak-to-Peak measured at 20 MHz Bandwidth.

⁴ Convection output current ratings refer to <50 °C ambient temperature, nominal input voltages, and heat sink (specified in the drawing herein after) mounted.

INPUT SPECIFICATIONS

Specification	Test Conditions / Notes	Min.	Nominal	Max.	Units
AC Input Voltage	PS starts and operates at 90 V _{AC} at all load conditions	90	100-240	264	V _{AC}
DC Input Voltage		170	-	270	V _{DC}
Input Frequency		47	50/60	440	Hz
Input Current	RMS at 180 V _{AC} , maximum load RMS at 90 V _{AC} , maximum load	-	-	2.5 5	A
Inrush Current	265 V _{AC} , cold start, no damage 12 V all packages, and sealed all voltages	-	-	- 20	A
Fusing	2X Time Lag 6.3 A, 250 V on L and N	-	-	6.3	A
Efficiency	230 V _{AC} , From 50% to full load At 20% full load At 115 V _{AC} , 20% rated load At 100% load	-	94 90 90 92	- - - -	%
Input Power Consumption	Power on, 115-230 V _{RMS} , no load Stand by, 115-230 V _{RMS} , no load	-	1 0.5	1.5 -	W
Power Factor	At full rated load, 115 V _{AC} 60 Hz and 230 V _{AC} 50 Hz input voltages	0.95	-	-	-
Harmonic Current Fluctuations and Flicker	Complies with EN-61000-3-2 Class C at 230 V _{AC} 50 Hz, >40 W load. Complies with EN-61000-3-3 at nominal voltages and full load.				
Leakage Current	Normal conditions, 264 V _{RMS} , 60 Hz.	-	-	300	µA

OUTPUT SPECIFICATIONS

Specification	Test Conditions / Notes	Min.	Nom.	Max.	Units
V1 Output Voltage	12V	-	12	-	
	24V (0.5% set point accuracy)	-	24	-	V
	48V (0.5% set point accuracy)	-	48	-	
V1 Output Power Rating	All models, convection cooling	-	-	250	W
	All models, forced air cooling (300 LFM)	-	-	400	
V2 Output Voltage	All versions.				
	Load on V2: from 5 to 1000 mA Load on V1: from 0.1 to 16.7 A	11.25	12.5	13.75	V
V2 Output Current	All models, convection/forced air cooling	-	-	1	A
5V_{SB} Output Voltage	All models (3% set point accuracy)	-	5	-	V
5V_{SB} Output Current	All models, convection cooling	-	-	1.5	A
	All models, forced air cooling (400 LFM)	-	-	2	
V1 Voltage Adjustment Range		±5	-	-	%V1
V1 Load-Line-Cross Regulation	V _{AC} : 90 – 264 V _{RMS}				
	V1 Load: 0 – 33.3 A (12V)				
	0 – 16.7 A (24V)	-	-	±2	%V1
	0 – 8.3 A (48V)				
	V2 Load: 0 – 1 A				
	5V _{SB} Load: 0 – 2 A				
5V_{SB} Load-Line-Cross regulation	V _{AC} : 90 – 264 V _{RMS}				
	V1 Load: 0 – 33.3 A (12V)				
	0 – 16.7 A (24V)	-	-	±5	%5V _{SB}
	0 – 8.3 A (48V)				
	V2 Load: 0 – 1 A				
	5V _{SB} Load: 0 – 2 A				
V1 Line Regulation	V _{AC} : 90 – 264 V _{RMS}	-	-	±0.1	%V1
Transient Response (Voltage Deviation) V1, 5V_{SB}	25% load changes at 1 A/μs				
	12V at 2200 μF Load / I _{OUT} > 0.5 A				%V1
	24 V at 1000 μF Load / I _{OUT} > 0.5 A	-	-	±5	%5V _{SB}
	48V at 560 μF Load / I _{OUT} > 0.5 A				
	5V _{SB} at 560 μF Load / I _{OUT} > 0.1 A				
V1 Ripple & Noise	All models, Peak-to-peak, 20 MHz BW. 100 nF ceramic and 10 μF tantalum caps at the load.	-	-	1	%V1
Start-up Rise Time	90 < V _{IN} < 264, any load conditions.	10	-	60	ms
Start-up Delay	V1 in regulation after PS_ON is asserted			200	
	V1 in regulation after AC is applied	-	-	700	ms
	5V _{SB} in regulation after AC is applied			200	
Turn-on Overshoot	At 500 mA output current, V1 in regulation within 50 ms.	-	10	-	%V1
		-	10	-	%V2
		-	10	-	%V _{SB}
Hold-up Time	At nominal V _{IN} , full load, for all outputs	-	16	-	
	At nominal V _{IN} , 365 W, for all outputs	-	20	-	ms
	At nominal V _{IN} , 200 W, for all outputs	-	35	-	
Minimum Load *	All models; V1, V2 and 5V _{SB}	0	-	-	A
Temperature Drift		-1.2	-	+1.2	mV/°C

*- When the load on the main output is less than 100 mA, V2 output voltage might regulate below its minimum value. Contact ROAL Electronics for details.

Package Model Number

Output Power De-rating Curves

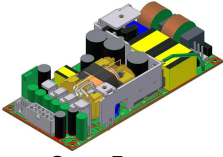

Open Frame

DDP/MDP400
-
US12/24/48
-
OF

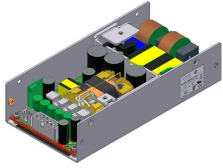

U-Chassis

DDP/MDP400
-
US12/24/48
-
UC

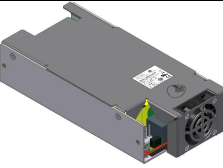

Front Fan

DDP/MDP400
-
US12/24/48
-
FF

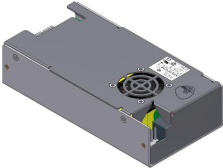

Vented Cover

DDP/MDP400
-
US12/24/48
-
VC

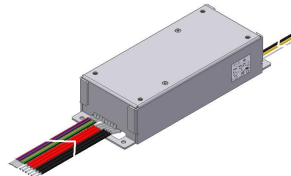
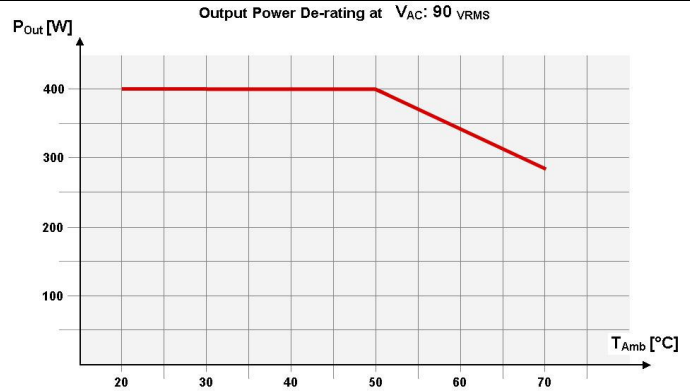
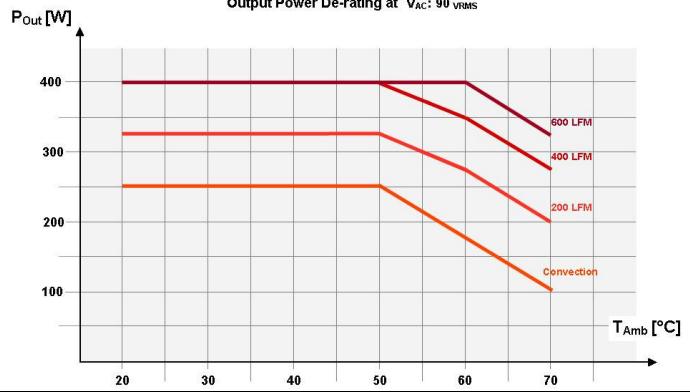

Sealed Box
w/o Heat Sink

DDP/MDP400
-
US12/24/48
-
SC

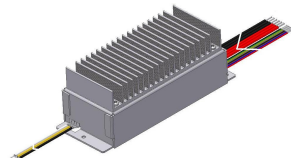
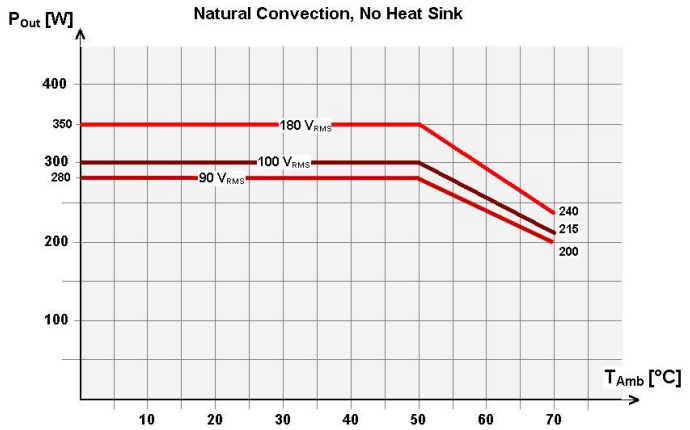

Sealed Box
w Heat Sink

DDP/MDP400
-
US12/24/48
-
SC
-
Heat Sink

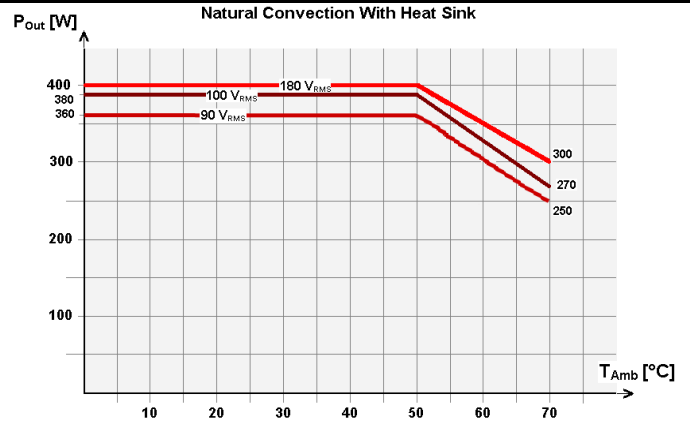

Signal	Notes	Min	Typ	Max	Unit
PS_ON	Active low, +5 V TTL signal compatible. Input low voltage	0	-	2.5	V
	Input high voltage ($I_{IN} = 200 \mu A$)	2.5	-	-	V
	V1 and V2 disabled when PS_ON is open 5V _{SB} not affected by PS_ON				
P_OK	V1 and V2 enabled with PS_ON connected to RTN +5 V TTL compatible				
	Logic level low (<10 mA sinking)	-	-	0.4	V
	Logic level high (100 μA sourcing)	2.4	-	5	V
5V_{SB} output	Low to high time after V1 in regulation	0.05	-	0.1	s
	Power down warning time	1	-	-	ms
	Active and in regulation after a $90 < V_{AC} < 264$ is applied 5V _{SB} not affected by PS_ON	-	-	200	ms

SIGNAL TIMINGS

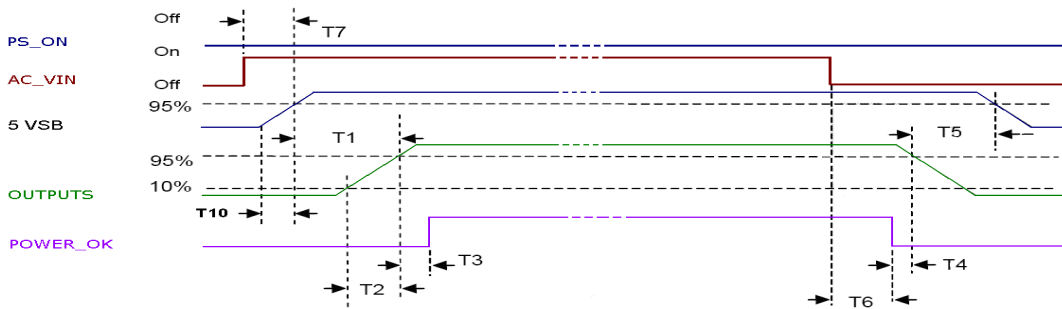

Above waveforms are expected with AC Input ON/OFF:

Standby on - Main outputs on	$50 \text{ ms} \leq T1 \leq 250 \text{ ms}$
Main output Rise Time	$10 \text{ ms} \leq T2 \leq 60 \text{ ms}$
5 VSB Rise Time	$4 \text{ ms} \leq T10 \leq 20 \text{ ms}$
Main outputs On - P_OK delay	$40 \text{ ms} \leq T3 \leq 100 \text{ ms}$
Power down warning ¹	$T4 \geq 1 \text{ ms}$
Main Output off - Standby off ²	$T5 \geq 1.2 \text{ s}$
Hold-up time (AC off - P_OK low)	$T6 \geq 15 \text{ ms (115/ 230 VAC)}$
AC_ON - Standby turn on time	$T7 \leq 500 \text{ ms}$

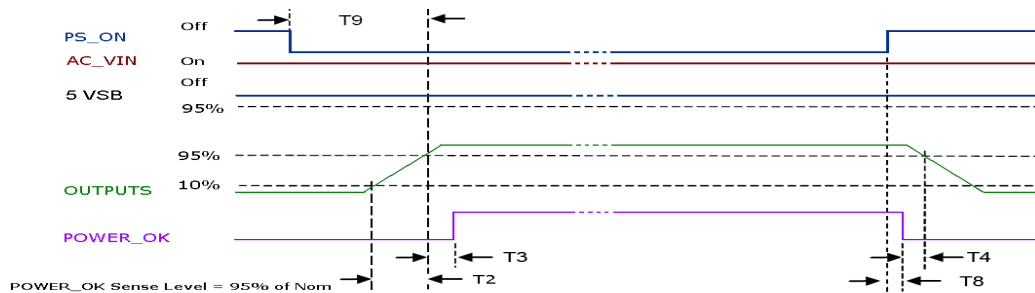

Above waveforms are expected with PS_ON Signal ON/OFF state change:

Main Output Rise Time	$10 \text{ ms} \leq T2 \leq 60 \text{ ms}$
Main Outputs on - P_OK delay	$50 \text{ ms} \leq T3 \leq 100 \text{ ms}$
Power down warning ¹	$1 \text{ ms} \leq T4 \leq 5 \text{ ms}$
PS_ON - Main Output (off) Timing	$T8 \leq 1 \text{ ms}$
PS_ON - Main Output (on) Timing	$T9 \leq 200 \text{ ms}$

¹ T4 parameter measurement setup will assume at least 10% of the maximum load on each output.

² T5 parameter measurement setup will assume at least 50% of the maximum load on main output.

PROTECTION FEATURES

Specification	Test Conditions / Notes	Min.	Nominal	Max.	Units
Input Under Voltage Lockout	Auto Recovery, Hiccup Mode	60	75	-	V _{AC}
Input Fuse	2X Time Lag 6.3 A, 250 V on L and N	-	-	6.3	A
Over Current	At nominal input voltages. V1: Hiccup mode, auto-recovery V2: PTC limiting, auto-recovering 5 VSB: Hiccup mode, auto-recovering.	110	-	150	%I _{1MAX}
Short Circuit	At nominal input voltages. V1: Shut down, latch off. V2: PTC limiting, auto-recovering 5 VSB: Hiccup mode, auto-recovering.	-	-	-	
Over Voltage	12V 24V 48V 5V _{SB}	110	-	136	%V _{NOM}
Over Temperature (on primary stage)	Unit shut down and latch off Shut down, latch off.	-	-	-	
Over Temperature (on secondary side)	Hiccup mode with auto recovery	-	-	-	
Isolation Input-Output		4000	-	-	V _{AC}
Isolation Input-Ground		1500	-	-	V _{AC}
Isolation V1/V2		100	-	-	V _{DC}
Isolation Output/Ground		500	-	-	V _{DC}

ENVIRONMENTAL SPECIFICATIONS

Specification	Test Conditions / Notes	Min	Nominal	Max	Units
Operating Temperature Range	No de-rating up to 50°C	-20	-	50	°C
De-rated Operating Temperature Range	Convection cooling: Linearly de-rate from 260 W at 50 °C, to 200 W at 70 °C Forced air cooling: Linearly de-rate from 400 W at 50 °C, to 300 W at 70 °C. Sealed versions see graphs below.	-	-	70	°C
Storage Temperature Range		-40	-	85	°C
Humidity	RH, Non-condensing Operating Non-operating	-	-	90 95	% %
Operating Altitude		-	-	4000	m
Shock	EN 60068-2-64 Operating: 5-500 Hz, 1 GRMS (0.002 g2/Hz), 3 axes, 30 min. Non-Operating: 5-500 Hz, 2.46 GRMS (0.0122 g2/Hz), 3 axes, 30 min.				
Vibration	EN 60068-2-27 Operating: 30 G /18 ms HALF SINE, 3 axes, 6x axes (3 positive and 3 negative). Non-Operating: 50 G /11ms HALF SINE, 3 axes, 6x axes (3 positive and 3 negative).				
MTBF	Full Load, Nominal V _{AC} , 50 °C Telcordia Issue 1	500000	-	-	Hours
Cooling	Convection Forced air	10 -	- -	- 300	LFM

ELECTROMAGNETIC COMPATIBILITY (EMC) - EMISSIONS

Phenomenon	Conditions / Notes	Standard	Equipment/Performance Class
Conducted	115 V _{RMS} , 230 V _{RMS} . Maximum load. 4 dB minimum margin	EN 55022 (ITE) EN 55011 (ISM) EN 60601-1-2 (Medical)	B
Radiated	At 10 m distance	EN 55022 (ITE) EN 55011 (ISM) EN 60601-1-2 (Medical)	A (Open frame and U-chassis) TBV (All Boxed Versions)
Line Voltage Fluctuation and Flicker	At 20%, 50% and 100% maximum load. Nominal input voltages.	EN 61000-3-3	
Harmonic Current Emission	Nominal input voltages. All load conditions > 30 W.	EN 61000-3-2	C

ELECTROMAGNETIC COMPATIBILITY (EMC) - IMMUNITY

Phenomenon	Conditions / Notes	Standard	Test Level	Performance criteria
	Reference standard for the medical version	EN 60601-1-2		
ESD	15 kV air discharge, 8 kV contact, at any point of the system.	EN 61000-4-2	4	A
Radiated Field	3 V/m, 80-1000 MHz, 1 KHz/2 Hz 80% AM. Dwell time is 3 sec for 2 Hz modulation Dwell time is 1 sec for 1KHz modulation	EN 61000-4-3	3	A
Electric Fast Transient Surge	±2 kV on AC power port for 1 minute; ±1 kV on signal/control lines ± kV ² line to line; ± 4 kV line to earth on AC power port; ±0.5 kV for outdoor cables	EN 61000-4-4 EN 61000-4-5	3 3	A A
Conducted RF Immunity	3 V _{RMS} , 0,15-80 MHz, 1 KHz/2 Hz 80% AM	EN 61000-4-6	3	A
Dips and Interruptions	Dip to 30% for 5 cycle (10 ms) Dip to 40% for 5 cycles (100 ms) Dip to 70% for 25 cycles (500 ms) Drop-out to 5% for 10 ms Interruptions > 95% for 5 s	EN61000-4-11 EN61000-4-11 EN61000-4-11 EN61000-4-11 EN61000-4-11		A B B B C

SAFETY AGENCIES APPROVAL

Certification Body	Safety Standards and file numbers	Category
CSA/UL	CSA C22.2 No. 60950-1, UL 60950-1; 2007, 2 nd edition	Information Technology Eq.
	CSA C22.2 No.601.1, ANSI/AAMI ES60601-1 3 rd edition	Medical
IEC IECEE CB Certification	IEC/EN 60950-1 2 nd edition	Information Technology Eq.
	IEC/EN 60601-1 3 rd edition	Medical
CE	IEC/EN 61558-2-16 (24 V _{DC} Open Frame version only)	SMPS
	Low Voltage Directive (LDV) 2006/95/EC	Information Technology Eq.
	Low Voltage Directive (LDV) 2007/47/EC MDD	Medical

OUTLINE DRAWING AND CONNECTIONS – OPEN FRAME

Connector	Manufacturer and Part Number
Input Connector J1	Molex 26-60-4030 or equivalent
J1 Mating Connector	Molex 09-91-0300 (Crimp Terminal Housing) Molex 08-50-0105 (Crimp Terminal, 18-24 AWG)
Ground Connector GND	Tyco 63849-1 equivalent
Ground Mating Connector	Any tin finished 6.35x0.81 mm receptacle
Output Connector J2	Molex 39-28-8120 or equivalent
J2 Mating Connector	Molex 39-01-2120 (Crimp Terminal Housing) Molex 39-00-0039 (Crimp Terminal, 18-24 AWG)
Output Connector J3	Molex 90130-1108 or equivalent
J3 Mating Connector	Molex 90142-0008 (Crimp Terminal Housing) Molex 90119-0109 (Crimp Terminal, 22-24 AWG)

Note: PCB head connectors and their mating are the same for all the package options, apart from the sealed Box which use flying wires.

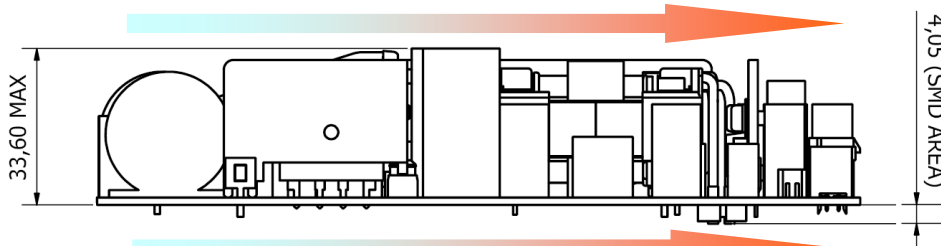
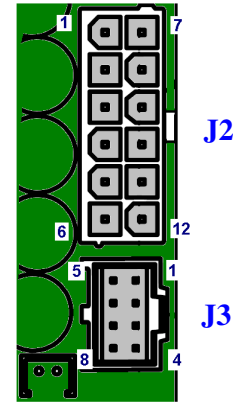

Recommended Air Flow Directions

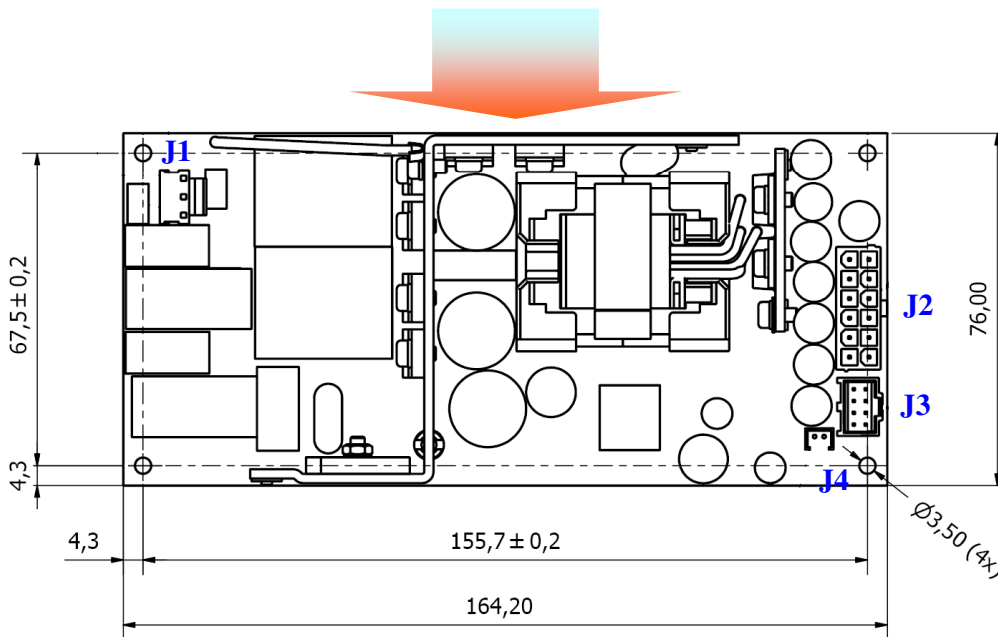

All dimension are in mm

Overall dimensions: (76.0 X 164.2 X 37.7) mm; (2.99 X 6.46 X 1.48) in

Weight: 404 g; 0.89 lb

Input Connector J1		
Pin	Function	
1	AC Live	
2	Removed	
3	AC Neutral	

Input Ground connector GND		
GND	Function	
GND	AC Ground	

Output Connector J2		
Pin	Function	
1	V1	
2	V1	
3	V1	
4	V1	
5	V1	
6	V1	
7	DC Return	
8	DC Return	
9	DC Return	
10	DC Return	
11	DC Return	
12	DC Return	

Output Connector J3		
Pin	Function	
1	+5V _{SB}	
2	-V2	
3	RS+	
4	+V2	
5	POK	
6	PS ON	
7	RTN	
8	RTN	

OUTLINE DRAWING AND CONNECTIONS _ U-CHASSIS

Overall dimensions: (84.4 X 166.5 X TBD) mm; (3.23 X 6.55 X TBD) in

Weight: 522 g; 1.15 lb

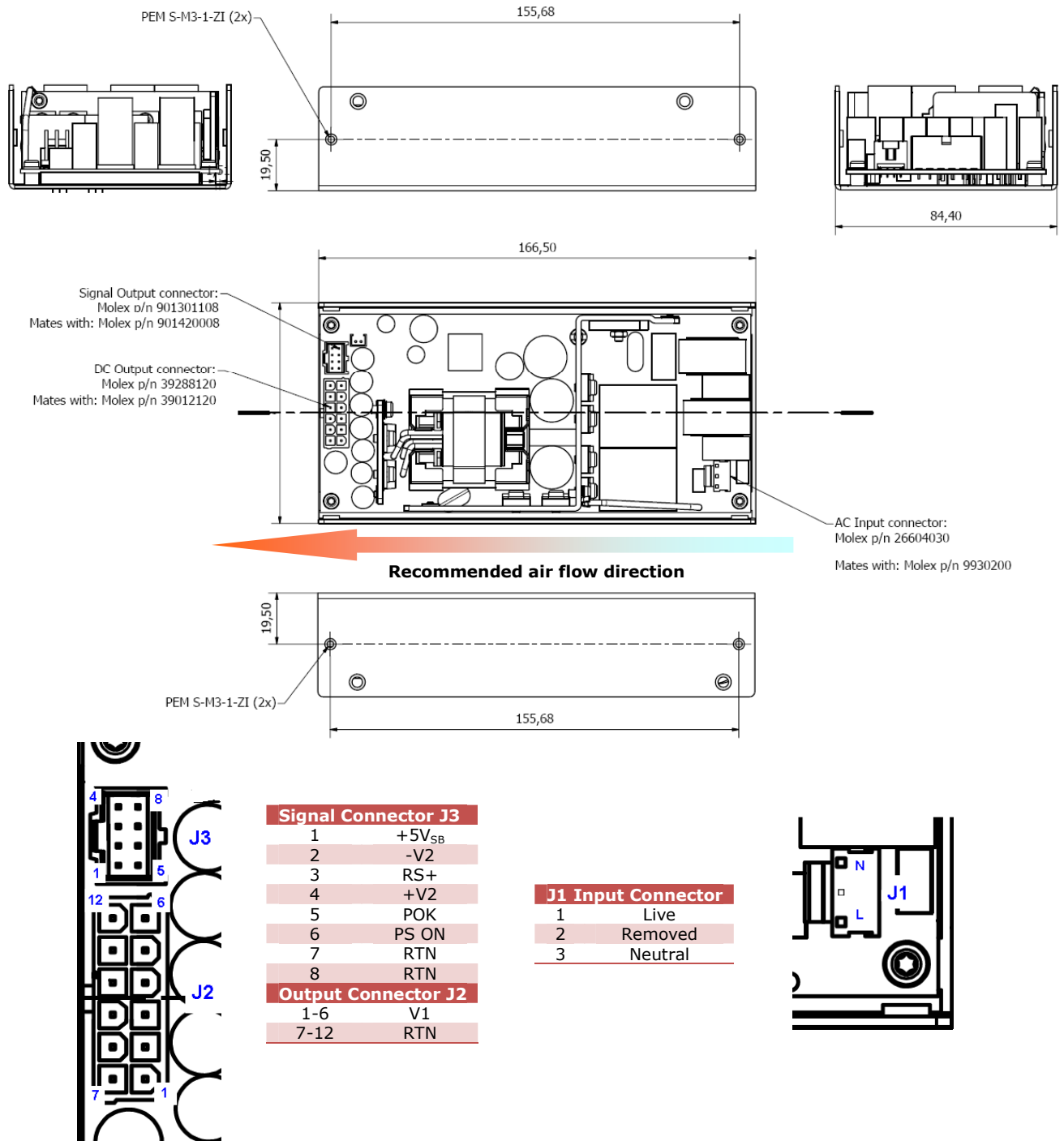

OUTLINE DRAWING AND CONNECTIONS _ VENTED COVER

Overall dimensions: (84.4 X 166.0 X 41.0) mm; (3.23 X 6.55 X 1.61) in

Weight: 670 g; 1.48 lb

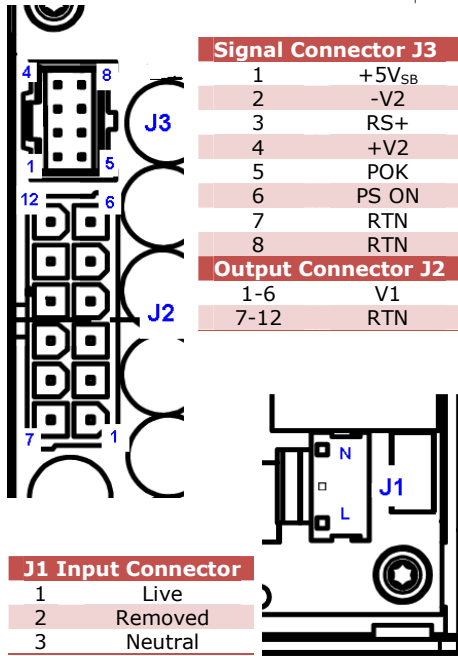
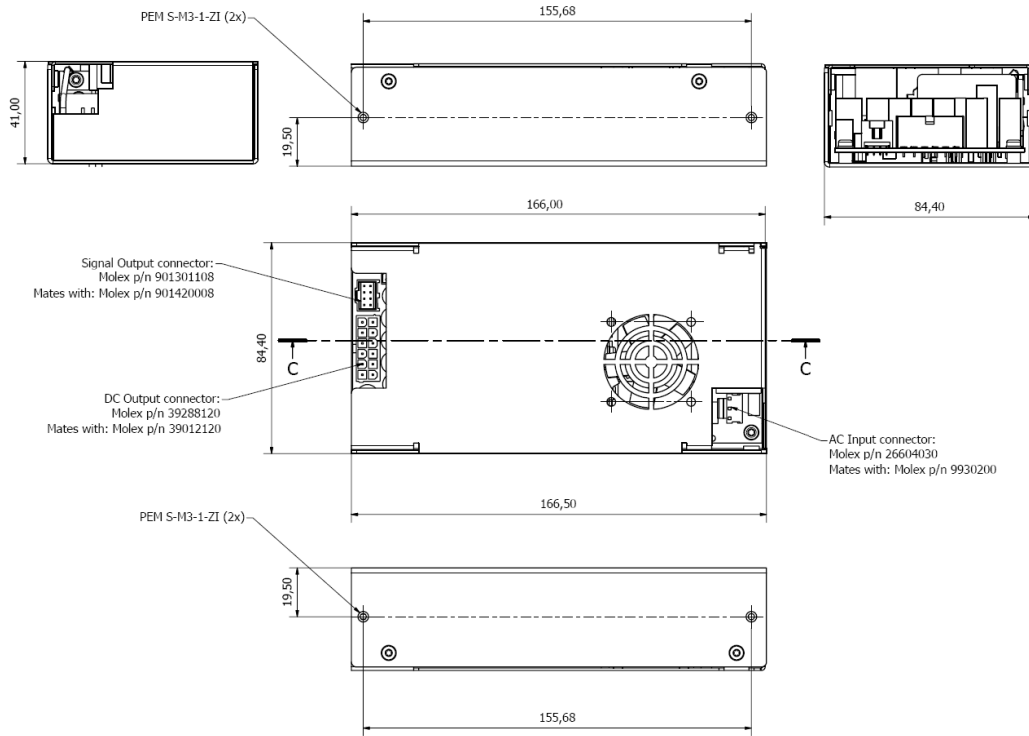

Fan speed versus load level

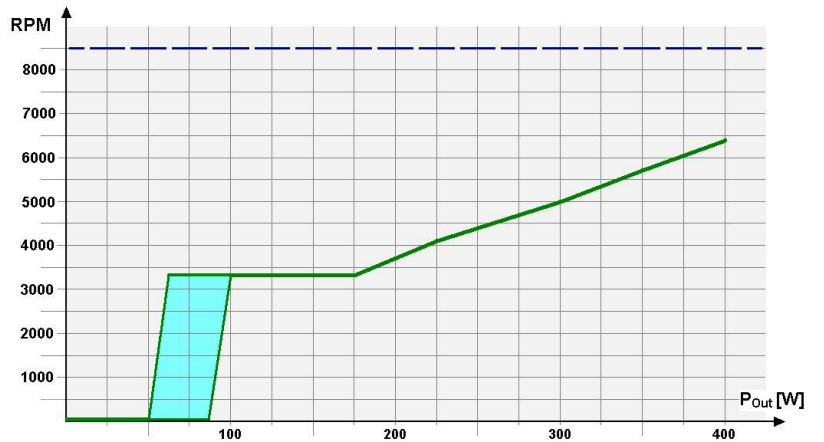

OUTLINE DRAWING AND CONNECTIONS _ FRONT FAN

Overall dimensions: (84.4 X 183.0 X 41.0) mm; (3.23 X 7.20 X 1.61) in

Weight: 682 g; 1.51 lb

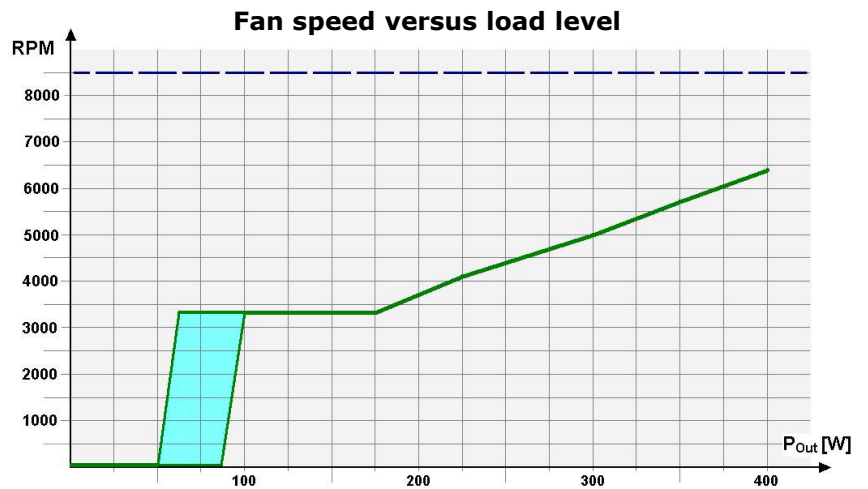
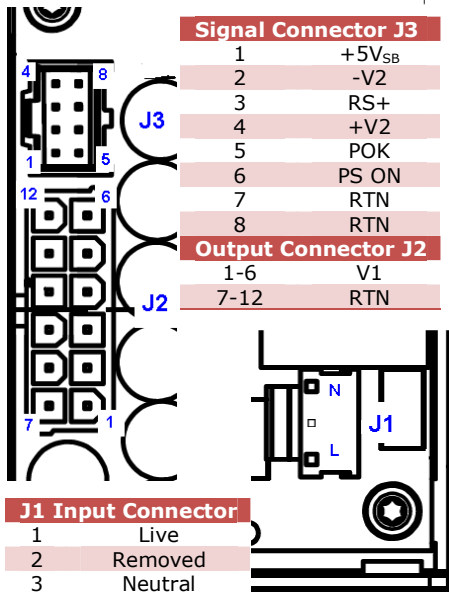
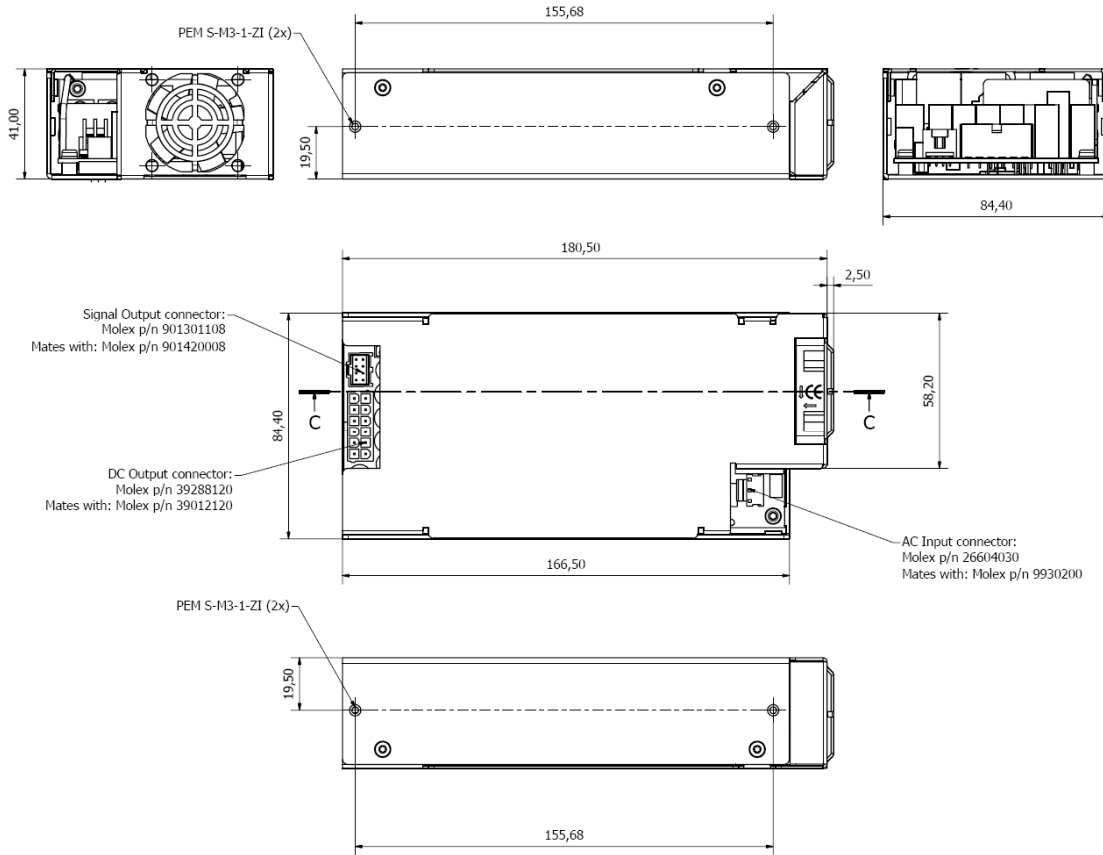

OUTLINE DRAWING AND CONNECTIONS _ SEALED BOX

Overall dimensions: (82.0 X 212.0 X 46.0/74.0) mm; (3.23 X 8.34 X 1.81/2.91) in

Weight: 1237 (1602) g; 2.73 (3.53) lb

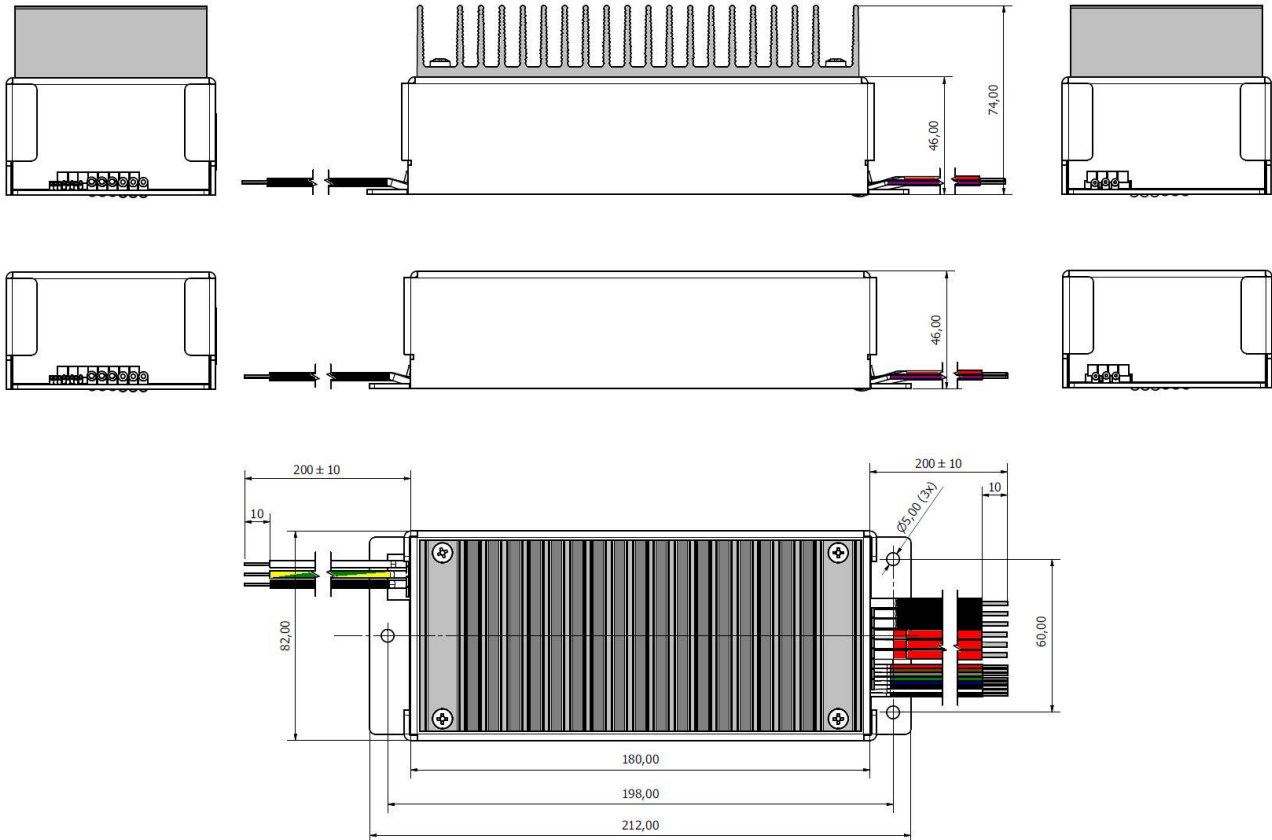

Connections	Wires Gauge and Length	Assignment	Colour
AC Input	18 AWG, Style 1015, 600 V _{AC} , 200.0 ± 10 mm Stripped and tinned	Live (L)	Black
		Neutral (N)	White
		Protective Earth (PE)	Green Yellow
DC Output	14 AWG, Style 1015, 600 V _{AC} , 200.0 ± 10 mm Stripped and tinned	+ V1 Output (+V1)	Red
		V1 Return (RTN)	Black
		+5 V Auxiliary Output (+5V _{AUX})	Red
Auxiliary Voltages Control Signals	22 AWG, Style 1569, 300 V _{AC} , 200.0 ± 10 mm Stripped and tinned	Output Power Good (P_OK)	Brown
		- Fan Voltage (-V _{FAN})	Gray
		Remote On/Off (PS_ON)	Green
		+ Terminal Remote Sense (+RS)	Blue
		Auxiliary/Signal Return (RTN)	Black
		+ Fan Voltage (+V _{FAN})	White
		Auxiliary/Signal Return (RTN)	Black

Roal Electronics, S.p.A. may change product specifications and accordingly the information presented in this document. Customers are responsible for their products and applications using Roal Electronics, S.p.A. products. Roal Electronics, S.p.A. assumes no liability from the use of its products outside of specifications. No license is granted to any intellectual property rights by this document. ROAL ELECTRONICS, S.P.A. DISCLAIMS ALL REPRESENTATIONS AND WARRANTIES OF ANY KIND, EXPRESS OR IMPLIED, INCLUDING, BUT NOT LIMITED TO, IMPLIED WARRANTIES OF NONINFRINGEMENT, MERCHANTABILITY AND FITNESS FOR A PARTICULAR PURPOSE.

Europe, Middle East and Africa

ROAL Electronics S.p.A
Via Jesina 56/A
60022 - Castelfidardo (AN) -
Italy
Tel: +39 071 721461
Fax: + 39 071 72146 480

www.roallivingenergy.com

North America

ROAL Electronics USA, Inc.
701, Main St. Suite 405
Stroudsburg, PA18360
Phone: + 1 570 421 5750
Fax: +1 570 421 5687

Rev 03 _ December 12, 2011