

EUE200/120 Series DC-DC Converter Power Module:

42 - 55Vdc Input; 12Vdc Output; 200W

42 - 58Vdc Input; 12Vdc Output; 120W

RoHS Compliant



Applications

- Distributed power architectures
- Intermediate Bus voltage application
- Optical and Access Network Equipment
- Servers and storage applications
- Wireless and Enterprise equipment including Power over Ethernet (PoE)

Options

- Negative logic, Remote On/Off
- Baseplate (-H)

Description

The EUE-series are a new generation of DC/DC power modules designed to support intermediate bus applications where multiple low voltages are generated using discrete/modular point of load (POL) converters. The EUE series provide up to 200 watt output power in an industry standard Eighth brick, which makes it an ideal choice for compact space, high current and intermediate bus voltage applications. The converter incorporates synchronous rectification technology and innovative packaging techniques to achieve ultra high efficiency reaching 95.3% at 11.6V full load. The ultra high efficiency of this converter leads to lower power dissipation such that for most applications a heat sink is not required. The EUE series power modules are isolated DC-DC converters that provide a single unregulated output voltage with a 4:1 step-down ratio between input/output.

Features

- Compliant to RoHS EU Directive 2002/95/EC (-Z versions)
- Compliant to ROHS EU Directive 2002/95/EC with lead solder exemption (non-Z versions)
- High power density: 238 W/in³
- High efficiency – 95.3% at 11.6V full load
- Exceptional Thermal Performance: 170W at 70^o C at 1 m/s (200LFM)
- Delivers up to 200W Output power
- Low output ripple and noise
- Industry standard Eight brick footprint 57.9mm x 22.9mm x 10.9mm (2.28in x 0.9in x 0.43in)
- Single unregulated output
- Narrow input voltage range
- Constant switching frequency
- Positive logic, Remote On/Off
- Input over voltage protection
- Output overcurrent protection
- Over-temperature protection
- Auto restart after fault shutdown
- Operating temperature range (-40°C to 85°C)
- *UL** 60950-1 Recognized, *CSA*[†] C22.2 No. 60950-1-03 Certified, and *VDE*[‡] 0805:2001-12 (EN60950-1) Licensed
- ISO** 9001 certified manufacturing facilities
- 2250 Vdc Isolation tested in compliance with IEEE 802.3[§] PoE standards

* *UL* is a registered trademark of Underwriters Laboratories, Inc.

[†] *CSA* is a registered trademark of Canadian Standards Association.

[‡] *VDE* is a trademark of Verband Deutscher Elektrotechniker e.V.

** *ISO* is a registered trademark of the International Organization of Standards

[§] *IEEE* and 802 are registered trademarks of the Institute of Electrical and Electronics Engineers, Incorporated.

Absolute Maximum Ratings

Stresses in excess of the absolute maximum ratings can cause permanent damage to the device. These are absolute stress ratings only, functional operation of the device is not implied at these or any other conditions in excess of those given in the operations sections of the data sheet. Exposure to absolute maximum ratings for extended periods can adversely affect the device reliability.

Parameter	Device	Symbol	Min	Max	Unit
Input Voltage	EUE200	V_{IN}	-0.3	55	Vdc
	Non-Operating Condition	All		-0.3	75
Operating Ambient Temperature (see Thermal Considerations section)	All	T_A	-40	85	°C
Storage Temperature	All	T_{stg}	-40	100	°C
I/O Isolation (100% factory Hi-Pot tested)	All	—	—	2250	Vdc

Electrical Specifications

Unless otherwise indicated, specifications apply over all operating input voltage, resistive load, and temperature conditions.

Parameter	Device	Symbol	Min	Typ	Max	Unit
Operating Input Voltage	EUE200	V_{IN}	42	48	55	Vdc
	EUE120	V_{IN}	42	48	58	Vdc
Maximum Input Current (EUE200: $V_{IN}=0$ to 55V, $P_o = 200W_{,max}$) (EUE120: $V_{IN}=0$ to 58V, $P_o = 120W_{,max}$)	EUE200	$I_{IN,max}$	—	—	5.6	Adc
	EUE120	$I_{IN,max}$	—	—	3.5	Adc
Inrush Transient	All	i^2t	—	—	1	A ² s
Input Reflected Ripple Current, peak-to-peak (5Hz to 20MHz, 12 μ H source impedance; $V_{IN}=0$ to 55V, $P_o = 200W_{,max}$; See Figure 17)	All		—	5	—	mAp-p
Input Ripple Rejection (120Hz)	All		—	12.3	—	dB

CAUTION: This power module is not internally fused. An input line fuse must always be used.

This power module can be used in a wide variety of applications, ranging from simple standalone operation to being part of complex power architecture. To preserve maximum flexibility, internal fusing is not included; however, to achieve maximum safety and system protection, always use an input line fuse. The safety agencies require a fast-acting fuse with a maximum rating of 10A (see Safety Considerations section). Based on the information provided in this data sheet on inrush energy and maximum dc input current, the same type of fuse with a lower rating can be used. Refer to the fuse manufacturer's data sheet for further information.

Electrical Specifications (continued)

Parameter	Device	Symbol	Min	Typ	Max	Unit
Output Voltage Set-point (EUE200 : $V_{IN}=V_{IN,nom}$, $P_O=200W$, $T_a=25^\circ C$) (EUE120 : $V_{IN}=V_{IN,nom}$, $P_O=120W$, $T_a=25^\circ C$)	All	$V_{O,set}$	—	12.0	—	V _{dc}
Output Regulation						
Over Line change	All		9.8	—	13.8	V _{dc}
Over Load change	All		—	0.5	0.7	V _{dc}
Temperature ($T_A = -40^\circ C$ to $+85^\circ C$)	All		—	150	—	mV
Output Ripple and Noise on nominal output ($V_{IN}=V_{IN,nom}$ and $P_O = 200W_{,max}$)						
RMS (5Hz to 20MHz bandwidth)	All		—	35	—	mV _{rms}
Peak-to-Peak (5Hz to 20MHz bandwidth)	All		—	50	—	mV _{pk-pk}
External Capacitance	All	$C_{O,max}$	—	—	3000	μF
Output Power	EUE200 EUE120	P_o P_o	0 0	— —	200 120	W W
Output Current Limit Inception (Hiccup Mode) ($V_{IN} = 48V$, $T_a=25^\circ C$)	EUE200 EUE120	$I_{o,lim}$	— —	22 13	— —	% $I_{o,max}$
Efficiency						
$V_{IN}=V_{IN,nom}$ and $P_O = 200W_{,max}$ $T_A=25^\circ C$	EUE200	η	—	95.3	—	%
$V_{IN}=V_{IN,nom}$ and $P_O = 120W_{,max}$ $T_A=25^\circ C$	EUE120	η	—	94.6	—	%
Switching Frequency		f_{sw}	—	230	—	KHz
Dynamic Load Response ($di_o/dt=1A/\mu s$; $V_{IN}=V_{IN,nom}$; $T_A=25^\circ C$; Tested with a 10 μF tantalum and a 1.0 μF ceramic capacitor across the load) Load change from $I_o = 50\%$ to 75% of $I_{o,max}$						
Peak Deviation	EUE200	V_{pk}	—	200	—	mV
Settling Time ($V_o < 10\%$ peak deviation)		t_s	—	200	—	μs
Load change from $I_o = 75\%$ to 50% of $I_{o,max}$						
Peak Deviation	EUE200	V_{pk}	—	200	—	mV
Settling Time ($V_o < 10\%$ peak deviation)		t_s	—	200	—	μs

Isolation Specifications

Parameter	Symbol	Min	Typ	Max	Unit
Isolation Capacitance	C_{ISO}	—	1000	—	pF
Isolation Resistance	R_{ISO}	10	—	—	MΩ

General Specifications

Parameter	Device	Min	Typ	Max	Unit
Calculated MTBF per Telcordia SR-332 Issue 1: Method 1, Case 3 ($V_{IN} = 48V$, $I_o = 13.8A$, $T_A=40^\circ C$, $airflow=1m/s(200 LFM)$)	EUE200		2,481,386		Hours
Weight		—	27 (0.9)	—	g (oz.)

Feature Specifications

Unless otherwise indicated, specifications apply over all operating input voltage, resistive load, and temperature conditions. See Feature Descriptions for additional information.

Parameter	Device	Symbol	Min	Typ	Max	Unit
On/Off Signal interface ($V_i = V_{i,min}$ to $V_{i,max}$; Open collector or equivalent, signal referenced to $V_{IN(-)}$ terminal) Negative logic: device code suffix "1" Logic Low =Module On, Logic High =Module Off Positive logic: No device code suffix required; Logic Low =Module Off, Logic High =Module On Logic Low Specification Remote On/Off Current –Logic Low	All	$I_{on/off}$	—	—	1.0	mA
On/Off voltage: Logic Low	All	$V_{on/off}$	0.0	—	0.8	V
Logic High-(Type=Open collector)	All	$V_{on/off}$	—	—	5	V
Logic High maximum allowable leakage current	All	$I_{on/off}$	—	—	50	μ A
Turn-On Delay and Rise Times ($I_o = I_{o,max}$, $V_{IN} = V_{IN,nom}$, $T_A = 25^\circ\text{C}$) T_{delay} = Time until $V_o = 10\%$ of $V_{o,set}$ from either application of V_{in} with Remote On/Off set to On or operation of Remote On/Off from Off to On with V_{in} already applied for at least one second. T_{rise} = time for V_o to rise from 10% of $V_{o,set}$ to 90% of $V_{o,set}$.	All	T_{delay} enable with V_{in}	—	3	—	msec
		T_{delay} enable with on/off	—	3	—	msec
		T_{rise}	—	12	—	msec
Over temperature Protection (See Thermal Considerations section)		T_{ref}	—	130	—	$^\circ\text{C}$
Input Undervoltage Lockout Turn-on Threshold	All	$V_{in,UVLO}$	—	40	41.9	V
Turn-off Threshold			35.5	36.5	—	V
Input Over voltage shutdown Turn-off Threshold	EUE200 EUE120	$V_{in,OVLO}$ $V_{in,OVLO}$	59.8 63	62 66	— —	Vdc Vdc

Characteristic Curves

The following figures provide typical characteristics for the EUE200B1 (12.0V, 17A) at 25°C. The figures are identical for either positive or negative Remote On/Off logic.

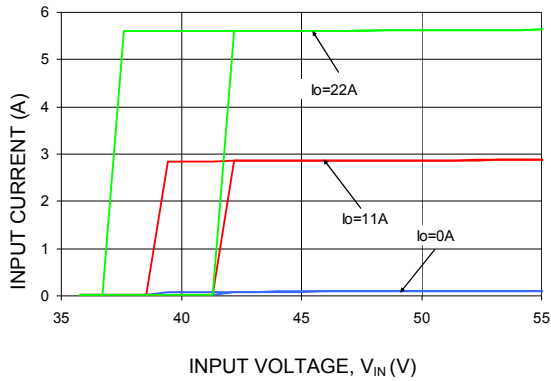

Figure 1. Typical Input Characteristic at Room Temperature.

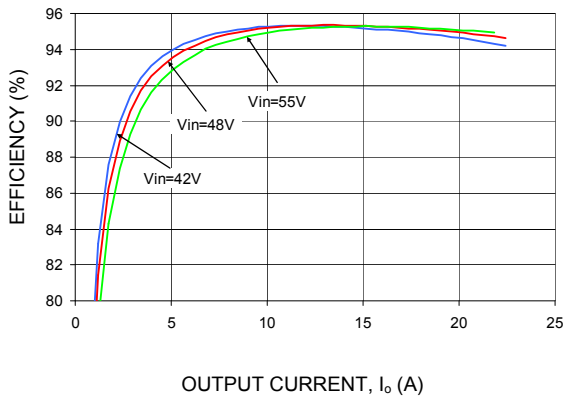

Figure 2. Typical Converter Efficiency Vs. Output current at Room Temperature.

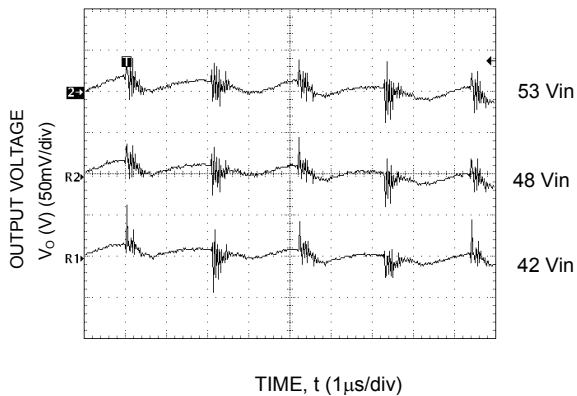

Figure 3. Typical Output Ripple and Noise at Room Temperature and $P_o = 200W$.

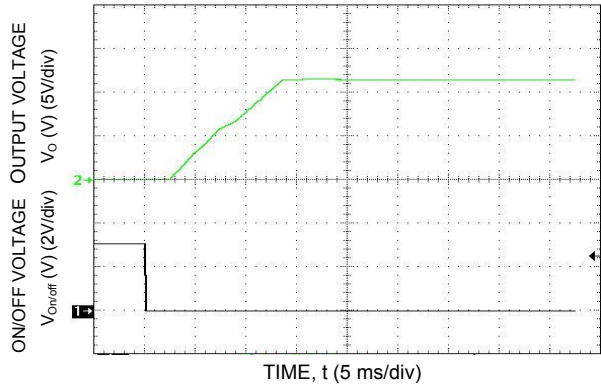

Figure 4. Typical Start-Up Using Remote On/Off, negative logic version shown.

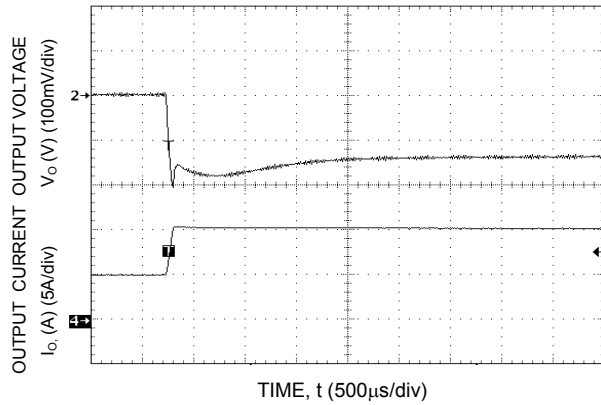

Figure 5. Typical Transient Response to Step increase in Output Load from 5A to 10A at Room Temperature and 48 Vdc Input.

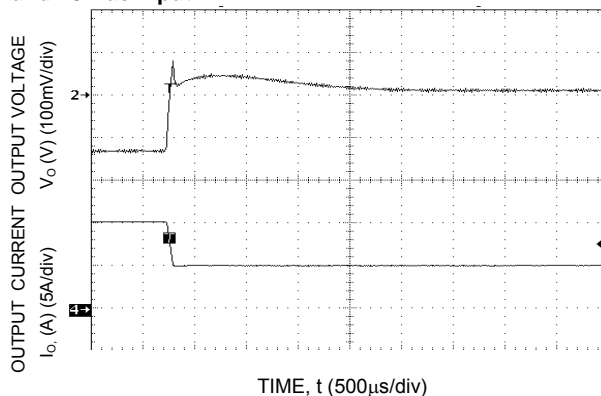

Figure 6. Typical Transient Response to Step decrease in Output Load from 10A to 5A at Room Temperature and 48 Vdc Input.

Characteristic Curves (continued)

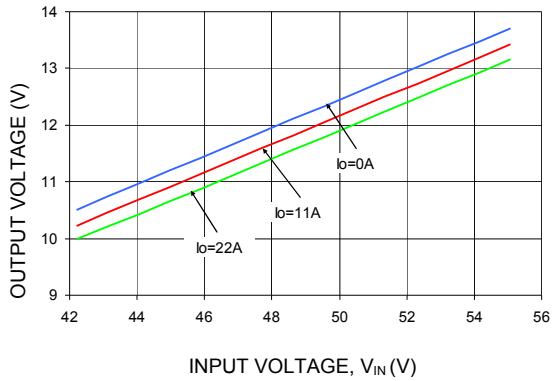

Figure 7. Typical Output voltage Vs. Input voltage Characteristic at Room Temperature.

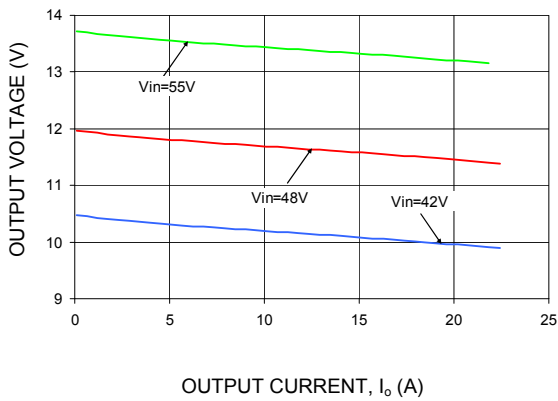

Figure 8. Typical Output voltage regulation Vs. Output current at Room Temperature.

Characteristic Curves (continued)

The following figures provide typical characteristics for the EUE120B1 (12.0V, 10A) at 25°C. The figures are identical for either positive or negative Remote On/Off logic.

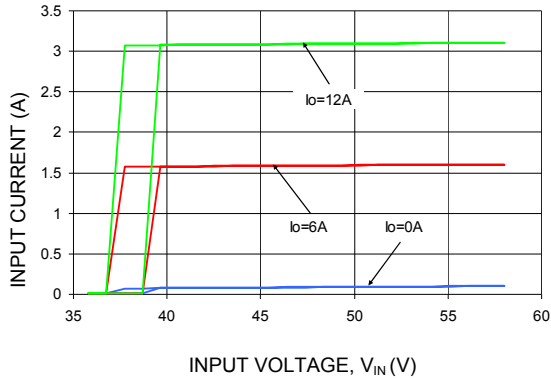

Figure 9. Typical Input Characteristic at Room Temperature.

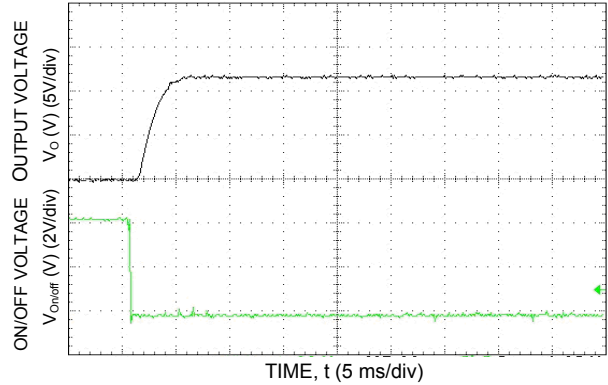

Figure 12. Typical Start-Up Using Remote On/Off, negative logic version shown.

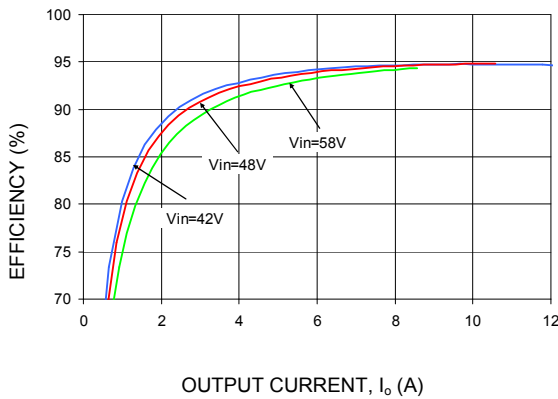

Figure 10. Typical Converter Efficiency Vs. Output current at Room Temperature.

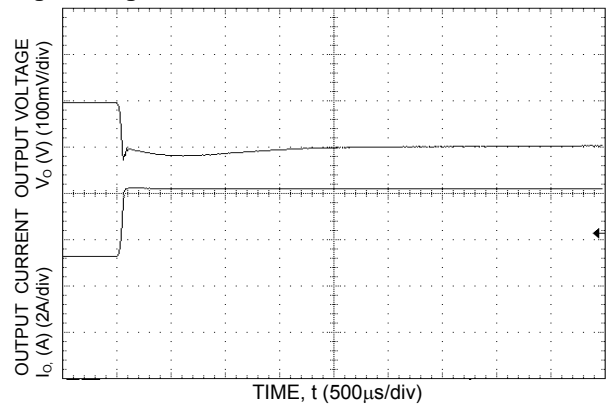

Figure 13. Typical Transient Response to Step increase in Output Load from 5.3A to 8.1A at Room Temperature and 48 Vdc Input; $C_{o,ext} = 370 \mu F$.

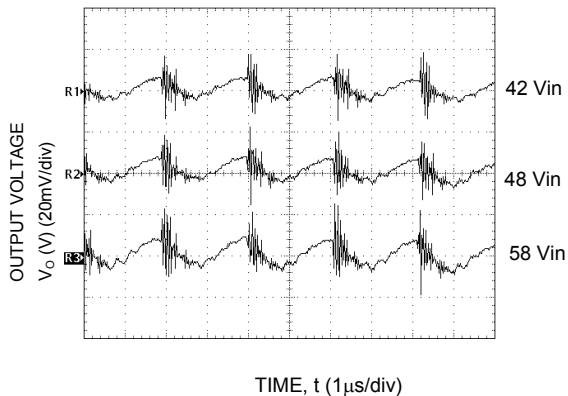

Figure 11. Typical Output Ripple and Noise at Room Temperature and $P_o = 120W$.

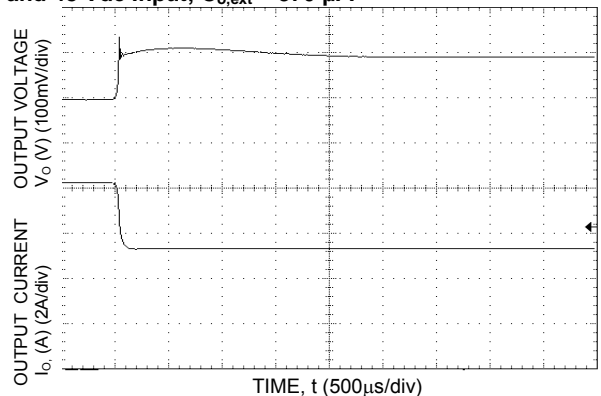

Figure 14. Typical Transient Response to Step decrease in Output Load from 8.1A to 5.3A at Room Temperature and 48 Vdc Input; $C_{o,ext} = 370 \mu F$.

Characteristic Curves (continued)

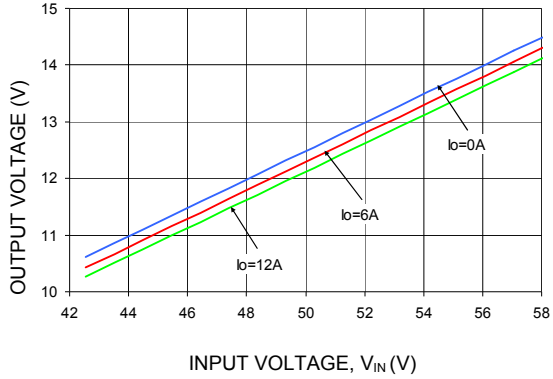

Figure 15. Typical Output voltage Vs. Input voltage Characteristic at Room Temperature.

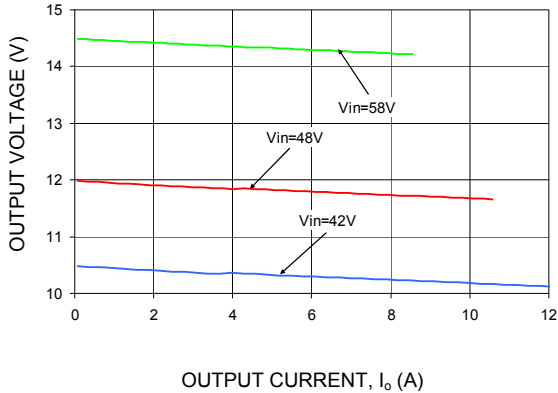
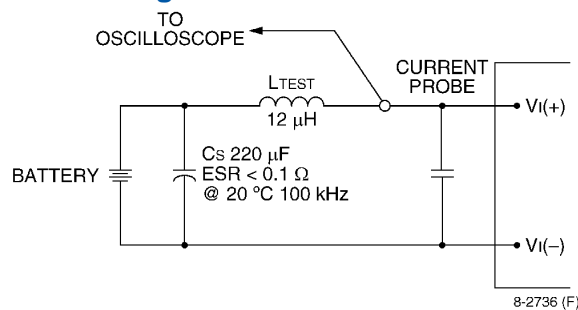

Figure 16. Typical Output voltage regulation Vs. Output current at Room Temperature.

Test Configurations



Note: Measure input reflected-ripple current with a simulated source inductance (LTEST) of 12 μH. Capacitor CS offsets possible battery impedance. Measure current as shown above.

Figure 17. Input Reflected Ripple Current Test Setup.

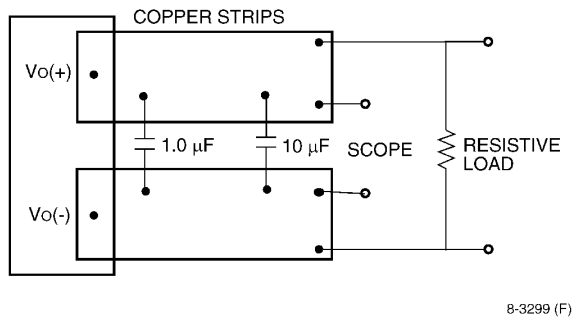

Note: Use a 1.0 μF ceramic capacitor and a 10 μF aluminum or tantalum capacitor. Scope measurement should be made using a BNC socket. Position the load between 51 mm and 76 mm (2 in. and 3 in.) from the module.

Figure 18. Output Ripple and Noise Test Setup.

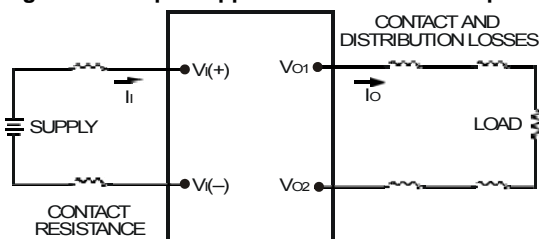

Note: All measurements are taken at the module terminals. When socketing, place Kelvin connections at module terminals to avoid measurement errors due to socket contact resistance.

Figure 19. Output Voltage and Efficiency Test Setup.

$$\text{Efficiency } \eta = \frac{V_o \cdot I_o}{V_{IN} \cdot I_{IN}} \times 100 \%$$

Safety Considerations

For safety-agency approval of the system in which the power module is used, the power module must be installed in compliance with the spacing and separation requirements of the end-use safety agency standard, i.e., UL60950-1, CSA C22.2 No. 60950-1-03, EN60950-1 and VDE 0805:2001-12.

For the converter output to be considered meeting the requirements of safety extra-low voltage (SELV), the input must meet SELV requirements.

For all input voltages, other than DC MAINS, where the input voltage is less than 60V dc, if the input meets all of the requirements for SELV, then:

- The output may be considered SELV. Output voltages will remain within SELV limits even with internally-generated non-SELV voltages. Single component failure and fault tests were performed in the power converters.
- One pole of the input and one pole of the output are to be grounded, or both circuits are to be kept floating, to maintain the output voltage to ground voltage within ELV or SELV limits.

If the input meets extra-low voltage (ELV) requirements, then the converter's output is considered ELV

All flammable materials used in the manufacturing of these modules are rated 94V-0, or tested to the UL60950 A.2 for reduced thickness.

The input to these units is to be provided with a maximum 10A fast-acting fuse in the unearthed lead.

Feature Description

Remote On/Off

Two remote on/off options are available. Positive logic remote on/off turns the module on during a logic-high voltage on the ON/OFF pin, and off during a logic low. Negative logic remote on/off turns the module off during a logic high and on during a logic low. Negative logic, device code suffix "1," is the factory-preferred configuration. To turn the power module on and off, the user must supply a switch to control the voltage between the on/off terminal and the VI (-) terminal (Von/off). The switch can be an open collector or equivalent (see Figure 20). A logic low is Von/off = 0 V to 0.8 V. The maximum Ion/off during a logic low is 1 mA. The switch should maintain a logic-low voltage while sinking 1 mA. During a logic high, the maximum Von/off generated by the power module is 5 V. The maximum allowable leakage current of the switch at Von/off = 5V is 50 μ A. If not using the remote on/off feature, perform one of the following to turn the unit on:

For negative logic, short ON/OFF pin to VI(-).

For positive logic: leave ON/OFF pin open.

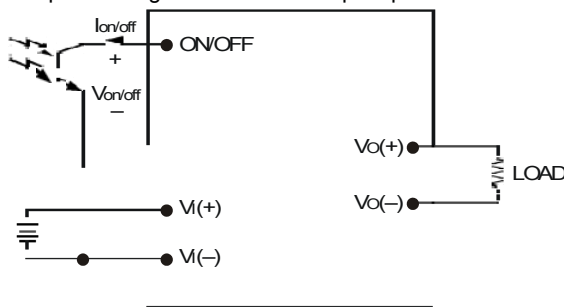

Figure 20. Circuit configuration for using Remote On/Off Implementation.

Overcurrent Protection

To provide protection in an output overload condition, the module is equipped with internal current-limiting circuitry and can endure current limiting for unlimited duration. If the output current exceeds the current limit inception value, the module enters into the hiccup mode operation, where it shuts down and automatically attempts to restart. As long as the fault condition exists, the module will remain in this hiccup mode, and can sustain this mode of operation until the overcurrent fault condition is corrected.

Input Undervoltage Lockout

At input voltage below the input under voltage lockout limit, the module operation is disabled. The module will begin to operate at an input voltage above the under voltage lockout turn-on/turn-off threshold.

Overtemperature Protection

These modules feature an overtemperature protection circuit to safeguard against thermal damage. The protection circuit shuts down the module when the maximum device reference temperature is exceeded. When the module cools down and the reference device temperature falls below the recovery threshold, the module will resume operation.

Input/Output Over Voltage Protection

The input/output overvoltage protection circuit is designed to shut down the module when the input voltage exceeds the overvoltage threshold. The module will resume operation when the input voltage enters the normal input operating range.

Thermal Considerations

The power modules operate in a variety of thermal environments and sufficient cooling should be provided to help ensure reliable operation.

Thermal considerations include ambient temperature, airflow, module power dissipation, and the need for increased reliability. A reduction in the operating temperature of the module will result in an increase in reliability. The thermal data presented here is based on physical measurements taken in a wind tunnel.

Heat-dissipating components are mounted on the top side of the module. Heat is removed by conduction, convection and radiation to the surrounding environment. Proper cooling can be verified by measuring the thermal reference temperature (T_{ref}). Peak temperature (T_{ref}) occurs at the position indicated in Figure 21. For reliable operation this temperature should not exceed listed temperature threshold.

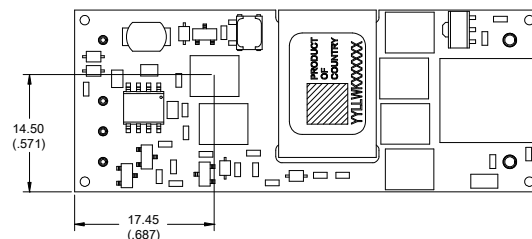

EUE120: SO-8 drain pin must not exceed 115°C.
EUE200: LF-PAK drain tab must not exceed 120°C.

Figure 21. T_{ref} Temperature Measurement Location for $V_o=12V$.

The output power of the module should not exceed the rated power for the module as listed in the Ordering Information table.

Although the maximum T_{ref} temperature of the power modules is 115°C for EUE120 and 120°C for

EUE200, you can limit this temperature to a lower value for improved reliability.

Please refer to the Application Note “Thermal Characterization Process For Open-Frame Board-Mounted Power Modules” for a detailed discussion of thermal aspects including maximum device temperatures.

Heat Transfer via Convection

Increased airflow over the module enhances the heat transfer via convection. The derating plots in figures 22 to 24 show the maximum output current that can be delivered by each module in the respective orientation without exceeding the maximum T_{ref} temperature versus local ambient temperature (T_A). The plots are for different airflow conditions ranging from 1m/s (200ft./min.) to 3m/s (600 ft./min.).

The use of Figures 22 - 24 is shown in the following example:

Example

What is the minimum airflow necessary for a EUE200B1 operating at $V_I = 48V$, an output power of 150W, and a maximum ambient temperature of 70 °C in transverse orientation?

Solution:

Given: $V_I = 48V$

$P_o = 150W$

$T_A = 70\text{ }^\circ\text{C}$

Determine airflow (V) (Use Figure 23):

$V = 1.0\text{ m/sec. (200 ft./min.)}$

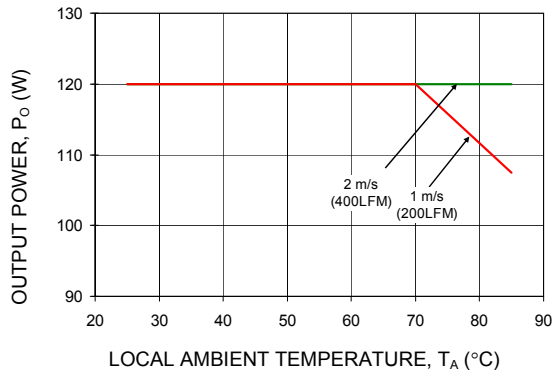

Figure 22. Output Power Derating for the EUE120B1 ($V_o = 12.0V$) in the Transverse Orientation; Airflow Direction From $V_{in}(-)$ to $V_{in}(+)$; $V_{in} = 48V$.

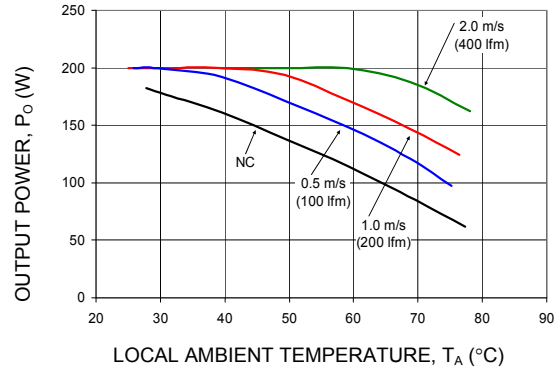

Figure 23. Output Power Derating for the EUE200B1 ($V_o = 12.0V$) in the Transverse Orientation; Airflow Direction From $V_{in}(-)$ to $V_{in}(+)$; $V_{in} = 48V$.

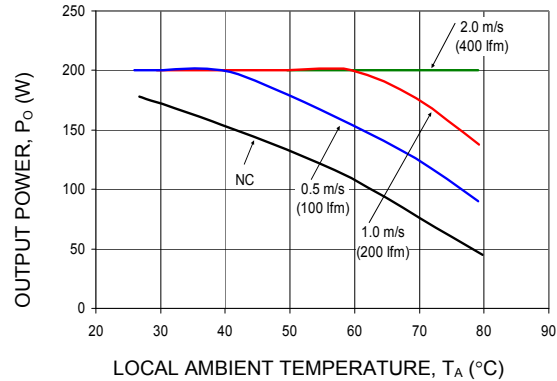

Figure 24. Output Power Derating for the EUE200B1-H ($V_o = 12.0V$) in the Transverse Orientation; Airflow Direction From $V_{in}(-)$ to $V_{in}(+)$; $V_{in} = 48V$.

Layout Considerations

The EUE series power modules have a low profile in order to be used in fine pitch system card architectures. As such, component clearance between the bottom of the power module and the mounting board is limited. Avoid placing copper areas on the outer layer directly underneath the power module. Also avoid placing via interconnects underneath the power module. For additional layout guide-lines, refer to FLTR100V10 data sheet.

Through-Hole Lead-Free Soldering Information

The RoHS-compliant through-hole products use the SAC (Sn/Ag/Cu) Pb-free solder and RoHS-compliant components. They are designed to be processed through single or dual wave soldering machines. The pins have an RoHS-compliant finish that is compatible with both Pb and Pb-free wave soldering processes. A maximum preheat rate of 3°C/s is suggested. The wave preheat process should be such that the temperature of the power module board is kept below 210°C. For Pb solder, the recommended pot temperature is 260°C, while the Pb-free solder pot is 270°C max. Not all RoHS-compliant through-hole products can be processed with paste-through-hole Pb or Pb-free reflow process. If additional information is needed, please consult with your Lineage Power representative for more details.

Post Solder Cleaning and Drying Considerations

Post solder cleaning is usually the final circuit-board assembly process prior to electrical board testing. The result of inadequate cleaning and drying can affect both the reliability of a power module and the testability of the finished circuit-board assembly. For guidance on appropriate soldering, cleaning and drying procedures, refer to Lineage Power *Board Mounted Power Modules: Soldering and Cleaning* Application Note (AN04-001).

Mechanical Outline for Through-Hole Module

Dimensions are in millimeters and [inches].

Tolerances: x.x mm ± 0.5 mm [x.xx in. ± 0.02 in.] (Unless otherwise indicated)

x.xx mm ± 0.25 mm [x.xxx in ± 0.010 in.]

TOP VIEW*

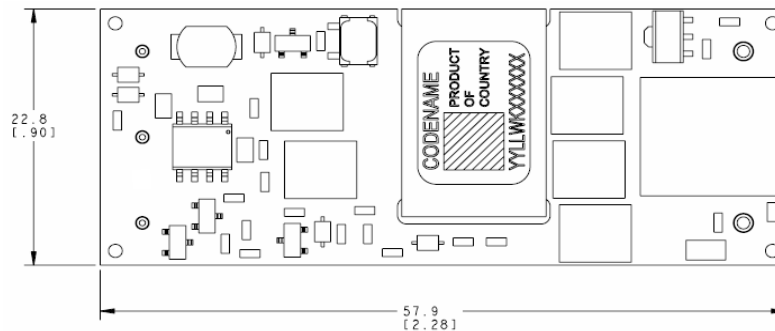

SIDE VIEW

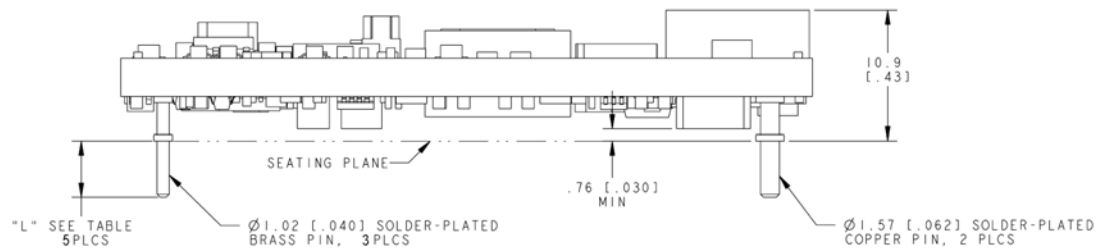

CODE NAME (OPTION)	LEAD LENGTH "L"
EUX(7,4,1)-X	.185 ± .010
EUX(*6*)-X	.145 ± .010
EUX(*8*)-X	.110 ± .010

BOTTOM VIEW

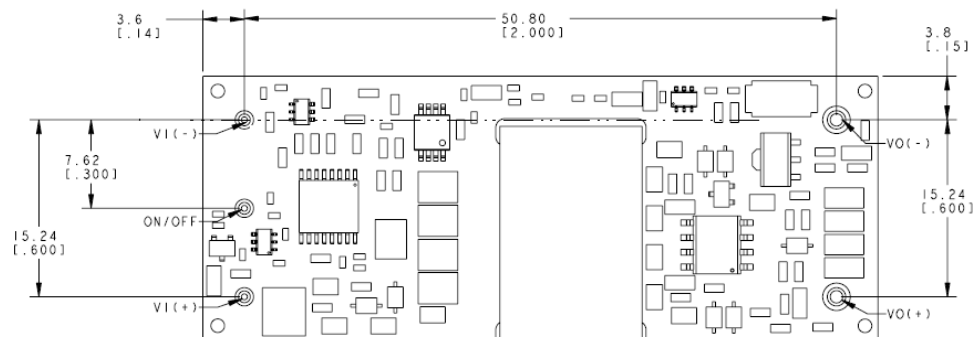

*Top side label includes Lineage Power name, product designation, and data code.

Ordering Information

Please contact your Lineage Power Sales Representative for pricing, availability and optional features.

Table 1. Device Codes

Product codes	Input Voltage	Output Voltage	Output Power	Efficiency	Connector Type	Comcodes
EUE120B41	48V (42-58Vdc)	12.0V	120W	95%	Through hole	108989736
EUE120B41Z	48V (42-58Vdc)	12.0V	120W	95%	Through hole	CC109126694
EUE120B641Z	48V (42-58Vdc)	12.0V	120W	95%	Through hole	CC109104394
EUE120B41-HZ	48V (42-58Vdc)	12.0V	120W	95%	Through hole	CC109130432
EUE200B41	48V (42-55Vdc)	12.0V	200W	95%	Through hole	108988151
EUE200B41Z	48V (42-55Vdc)	12.0V	200W	95%	Through hole	108995255
EUE200B41-HZ	48V (42-55Vdc)	12.0V	200W	95%	Through hole	108988655

-Z Indicates RoHS Compliant modules

Table 2. Device Options

Option	Device Code Suffix
Negative remote on/off logic	1
Auto-restart (must be ordered)	4
Pin Length: 3.68 mm ± 0.25mm (0.145 in. ± 0.010 in.)	6
Case pin (only available on -H modules)	7
Pin Length: 2.79 mm ± 0.25mm (0.110 in. ± 0.010 in.)	8
Base Plate option	-H
RoHS Compliant	-Z

Note: Legacy device codes may contain a -B option suffix to indicate 100% factory Hi-Pot tested to the 1500 Vdc isolation voltage specified in the Absolute Maximum Ratings table. The 100% Hi-Pot test is now applied to all device codes, with or without the -B option suffix. Existing comcodes for devices with the -B suffix are still valid; however, no new comcodes for devices containing the -B suffix will be created.



World Wide Headquarters
Lineage Power Corporation
3000 Skyline Drive, Mesquite, TX 75149, USA
+1-800-526-7819
(Outside U.S.A.: **+1-972-284-2626**)
www.lineagepower.com
e-mail: techsupport1@lineagepower.com

Asia-Pacific Headquarters
Tel: +65 6416 4283

Europe, Middle-East and Africa Headquarters
Tel: +49 89 6089 286

India Headquarters
Tel: +91 80 28411633

Lineage Power reserves the right to make changes to the product(s) or information contained herein without notice. No liability is assumed as a result of their use or application. No rights under any patent accompany the sale of any such product(s) or information.

© 2008 Lineage Power Corporation, (Mesquite, Texas) All International Rights Reserved.