

Intelligent VS Power

Up to 4920 Watts

Total Power: Up to 4920 Watts
Input Voltage: 85-264 Vdc
120-300 Vdc
of Outputs: Up to 24

Special Features

- Full medical EN60601 approval
- Intelligent I²C control
- Voltage adjustment on all outputs (manual or I²C)
- Configurable input and output OK signals and indicators
- Configurable inhibit/enable
- Configurable output UP/DOWN sequencing
- High power density (12 W/cu-in)
- Intelligent fan (speed control/ fault status)
- uP controlled PFC input with active Inrush protection
- I²C monitor of voltage, current, and temperature
- Programmable voltage, current limit, inhibit/enable through I²C
- Optional extended hold-up module (SEMI F47 compliance)
- Increased power density to 150%
- Optional conformal coating
- Industrial temp range (-40 °C to 70 °C)
- Uses standard iMP modules
- Field upgradeable firmware
- RoHS compliant

Safety

- **UL** UL60950/UL2601
- **CSA** CSA22.2 No. 234 Level 5
- **VDE** EN60950/EN60601-1
- **BABT** Compliance to EN 60950/EN60601 BS 7002
- **CB** Certificate and report
- **CE** Mark to LVD

iVS™



Electrical Specifications

Input	
Input range:	
iVS1 & iVS3	90-264 Vac 1Ø; 120 - 300 Vdc
iVS6 & iVS8	170-264 Vac 3Ø
iVS8H	480 Vac nominal 3Ø 380 Vac nominal 3Ø derate to 3800 W max.
Frequency:	47-440 Hz
Inrush current:	40 A peak maximum (soft start)
Efficiency:	Up to 85% @ full case load
Power Factor:	0.99 typ. meets EN61000-3-2
Turn-on time:	AC on 1.5 sec typical, inhibit/enable 150ms typical Programmable; 50ms internal turn-on delay (Dual Output only)
EMI Filter:	CISPR 22/EN55022 Level "B"
Leakage current:	500 µA max. @ 240 Vac; 47-63 Hz
Radiated EMI:	CISPR 22/EN55022 Level "B"
Holdover storage:	10 ms minimum (independent of input Vac) additional 20mSEC holdover storage with optional HUP module (SEMI F47 compatible)
AC OK:	>5ms early warning minutes before outputs lose regulation Full cycle ride thru (50 Hz). Programmable
Harmonic distortion:	Meets EN61000-3-2
Isolation:	Meets EN60950 and EN60601
Global inhibit / enable:	TTL, Logic "1" and Logic "0"; configurable
Warranty:	3 years



Output

Adjustment range:*	±10% minimum all outputs (manual) (full module adjustment range using I ² C)
Margining:	±4-6% nominal analog (single output module only)
Overall regulation:	0.4% or 20 mV max. (1500 W modules 1% max.)
Ripple:	RMS: 0.1% or 10 mV, whichever is greater Pk-Pk: 1.0% or 50 mV, whichever is greater Bandwidth limited to 20 MHz
Dynamic response:	<2% or 100 mV, with 25% load step
Recovery time:	To within 1% in <300 μsec
Overcurrent protection:**	Configurable through I ² C (calibration required). Single output module and main output of the dual output module 105-120% of rated output current. Aux output of dual output module 105-140% of rated output current. Special programmable OCP delay on 1500 W module from 100 mSec to 25.5
Short-circuit protection:	seconds with shutdown features. Protected for continuous short-circuit. Recovery is automatic upon removal of short (Shutdown mode on 1500 W module).
Overvoltage protection:*	Configurable through I ² C
Single output module:	2-5.5 V 122-134% ; 6-60 V 110-120%
Dual output module:	2-6 V 122-134% ; 8-28 V 110-120%
Triple output module:	No overvoltage protection provided
Thermal protection:*	Configurable through I ² C All outputs disabled when internal temp exceeds safe operating range. >5ms warning (AC OK signal) before shutdown
Remote sense:	Up to 0.5 V total drop (not available on triple output module)
Single wire parallel:	Current share to within 2% of total rated current
DC OK:*	+/-5% of nominal. Configurable through I ² C
Minimum load:	Not required
Housekeeping bias voltage:	5 Vdc @1.0 A max. present whenever AC input is applied
Module inhibit:*	Configured and controlled through I ² C
Output/Output isolation:	>1 Megohm, 500 V
* Can be controlled via I ² C	
** Controlled via I ² C but requires load calibration (except 1500W module)	

Environmental Specifications

Operating temperature:	-40 ° to 70 °C ambient. Derate each output 2.5% per degree from 50 ° to 70 °C. (-20 °C start up)
Storage temperature:	-40 °C to 85 °C
Electromagnetic susceptibility:	Designed to meet EN61000-4; -2, -3, -4, -5, -6, -8, -11 Level 3
Humidity:	Operating; non-condensing 10% to 95% RH
Vibration:	IEC68-2-6 to the levels of IEC721-3-2
MTBF demonstrated:	>550,000 hours at full load, 220 Vac and 25 °C ambient conditions

Output Module Line-up

Module Code	1	2	3	5	4	—
Module Type	Single	Single	Single	Single	Dual	Triple
Max output power	210 W	360 W	750 W	1500 W	144 W	36 W
Max output current	35 A	60 A	150 A	140 A	10 A	2 A
Output voltages available *	2-60 V	2-60 V	2-60 V	6-60 V	6 - 15, 24 - 28; 6 - 15; 6 - 15; 6 - 15; 2 - 6; 2 - 6, 2 - 6; 24 - 28, 24 - 28; 24 - 28; 2 - 6	8-15, 8-15, 2-6; 8-15, 8-15, 8-15; 8-15, 8-15, 18-28; 8-15, 18-28, 2-6
Standard voltage increments	25	25	25	18	16	18
Remote sense	Yes	Yes	Yes	Yes	Yes	No
Remote margin	Yes	Yes	Yes	Yes	No	No
V-Program - I ² C Control	Yes	Yes	Yes	Yes	Yes	No
Active Current Share	Yes	Yes	Yes	Yes	Yes	No
Module Inhibit - I ² C Control	Yes	Yes	Yes	Yes	Yes	Yes
Module Inhibit - Analog	Yes	Yes	Yes	Yes	Yes	No
Overvoltage/Overcurrent protection	Yes	Yes	Yes	Yes	Yes	Yes
Minimum load required	No	No	No	No	No	No
Slots occupied in any iVS case	1	2	3	4	1	1

Single



210 W

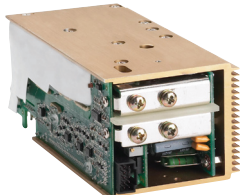

750 W



360 W



1500 W

Dual

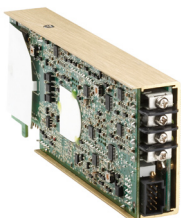

144 W

Triple



36 W

Output Module Voltage/Current*

Voltage	Voltage Code	Single Output Module Code				Dual Output**		Triple Output			I ² C Adjustment Ranges***
		1	2	3	5	4	4	-	-	-	
2 V	A	35 A	60 A	150 A	—	10 A	10 A	—	—	2 A	1.8 - 2.2
2.2 V	B	35 A	60 A	150 A	—	10 A	10 A	—	—	2 A	2.0 - 2.4
3 V	C	35 A	60 A	150 A	—	10 A	10 A	—	—	2 A	2.7 - 3.3
3.3 V	D	35 A	60 A	150 A	—	10 A	10 A	—	—	2 A	3.0 - 3.6
5 V	E	35 A	60 A	150 A	—	10 A	10 A	—	—	2 A	4.5 - 5.5
5.2 V	F	35 A	60 A	144 A	—	10 A	10 A	—	—	2 A	4.7 - 5.7
5.5 V	G	34 A	58 A	136 A	—	10 A	10 A	—	—	2 A	5.0 - 6.1
6.0 V	H	23 A	42 A	97.5 A	140 A	10 A	10 A	—	—	2 A	5.4 - 6.6
8.0 V	I	20 A	36 A	84.4 A	140 A	10 A	4 A	1 A	1 A	1 A	7.2 - 8.8
10 V	J	18 A	32 A	75 A	140 A	10 A	4 A	1 A	1 A	1 A	9.0 - 11.0
11 V	K	17 A	31 A	68 A	136.3 A	10 A	4 A	1 A	1 A	1 A	9.9 - 12.1
12 V	L	17 A	30 A	62.5 A	125 A	10 A	4 A	1 A	1 A	1 A	10.8 - 13.2
14 V	M	14 A	21 A	53.5 A	107 A	9 A	4 A	1 A	1 A	1 A	12.6 - 15.4
15 V	N	14 A	20 A	50 A	100 A	8 A	4 A	1 A	1 A	1 A	13.5 - 16.5
18 V	O	11 A	19 A	41.6 A	83.3 A	—	—	—	0.5 A	0.5 A	16.2 - 19.8
20 V	P	10.5 A	18 A	37.5 A	75 A	—	—	—	0.5 A	0.5 A	18.0 - 22.0
24 V	Q	8.5 A	15 A	30 A	62.5 A	4 A	2 A	—	0.5 A	0.5 A	21.6 - 26.4
28 V	R	6.7 A	11 A	26.8 A	53.5 A	3 A	2 A	—	0.5 A	0.5 A	25.2 - 30.8
30 V	S	6.5 A	11 A	25 A	50 A	—	—	—	—	—	27.0 - 33.0
33 V	T	6.2 A	10.9 A	22.7 A	35.8 A	—	—	—	—	—	29.7 - 36.3
36 V	U	5.8 A	10 A	20.8 A	35.8 A	—	—	—	—	—	32.4 - 39.6
42 V	V	4.2 A	7.5 A	16 A	35.7 A	—	—	—	—	—	37.8 - 46.2
48 V	W	4.0 A	7.5 A	15.6 A	31.2 A	—	—	—	—	—	43.2 - 52.8
54 V	X	3.7 A	6.0 A	13.9 A	27.7 A	—	—	—	—	—	48.6 - 59.4
60 V	Y	3.5 A	6.0 A	12.5 A	25 A	—	—	—	—	—	54.0 - 66.0

Contact Factory

Special	Z	35 A	60 A	150 A	—	—	10 A				2.3 - 2.6
Special	Z	35 A	60 A	150 A	—	—	10 A				3.7 - 4.4
Special	Z	20 A	36 A	80 A	140 A	—	8 A				6.7 - 7.1

* Note: Increments of current not shown can be achieved by paralleling modules (add currents of each module selected).

** Total output power on dual model must not exceed 144 W.

*** For single output modules only.

Ordering Information

Sample below is 3210 W case with 12 V @ 125 A; 24 V @ 8.5 A; 5 V @ 60 A; 12 V @ 10 A and 12 V @ 4 A; with no options.

Case Size	Module/Voltage/Option Codes First - Module Code Second - Voltage Code Third - Option Code	Case Option Codes	Software Code	Hardware Code
iVS1	5L1 - 1Q1- 2EO -4LLO	00	A	###
Case Size (mm) 1-Phase Input 1 = 5" x 5" x 11"; 1500 W - 3210 W, 9 Slots (127 x 127 x 279.4) 3 = 5" x 8" x 11"; 1800 W - 4500 W, 14 Slots (127 x 203.2 x 279.4) 3-Phase Input 6 = 5" x 5" x 11"; 3120 W, 9 Slots (127 x 127 x 279.4) 8 = 5" x 8" x 11"; 4920 W, 14 Slots (127 x 203.2 x 279.4) 8H= 5" x 8" x 11"; 4920 W, 14 Slots (127 x 203.2 x 279.4)	Module Codes Module/voltage/option codes Module Codes: (None) = 36 W triple O/P (1 slot) 1 = 210 W single O/P (1 slot) 2 = 360 W single O/P (2 slot) 3 = 750 W single O/P (3 slot) 5 = 1500 W single O/P (slot 4) 4 = 144 W dual O/P (1 slot) HUP = Extra 30mS hold-up (1 slot) Voltage Codes: See Output Module Voltage/Current table above Option Codes: 0 = Standard 1 = Module enable 2 = Constant current 3 = 1 & 2 combined 4 = Set for use in standard (non-intelligent case) 5 = Shutdown mode for 1500 W 6 = 1 & 5 combined 7-9 Future	Case Option Codes First Digit 0 - 9 = Parallel code (See parallel codes table below) Second Digit 0 = No options 1 = Reverse air 2 = Not used 3 = Global enable 4 = Fan Off w/inhibit 5 = Opt 1 + Opt 3 6 = Opt 1 + Opt 4 7 = Opt 3 + Opt 4 8 = Opt 1 + 3 + 4 9 = Future	Software code used for configuration change. "A" is standard	Factory assembled for hardware of firmware mods.
Ordering Note: 1. USB to I ² C module order code 73-769-001				

Parallel Code	Slot No.	iVS1, 6		iVS3, 8, 8H	
		Diagram	Possible Configurations	Diagram	Possible Configurations
1	1 & 2		210 210; 210 144; 144 144		210 210; 210 144; 144 144
2	2 & 3		360 360; 360 210; 360 144; + above		360 360; 360 210; 360 144; + above
3	3 & 4		750 360; 750 210; 750 144; 210 210; 210 144; 144 144		750 750; 750 360; 750 210; 750 144; 210 210; 210 144; 144 144
4	4 & 5		1500 210; 1500 144; 210 210; 210 144; 144 144; 360 210; 360 144		1500 1500; 1500 750; 1500 360; 1500 210; 1500 144; 210 210; 210 144; 144 144; 360 360; 360 210; 360 144
5	3, 4, & 5		750 210 210; 750 210 144; 750 144 144		750 210 210; 750 210 144; 750 144 144
6	4 & 6		1500 1500; 1500 750		
7	4, 5, & 6		1500 210 210; 1500 210 144; 1500 144 144		1500 210 210; 1500 210 144; 1500 144 144
8	iVS1,6: 3 & 6 iVS3,8,8H: 4, 5, & 9		750 750		1500 1500 1500; 1500 1500 750; 1500 1500 360; 1500 1500 210; 1500 1500 144
9	iVS1,6: 1 & 6 iVS3, 8, 8H: 4, 5 & 9; 12 & 13		1500 1500; 1500 360; 1500 144		1500 1500 1500 360; 1500 1500 1500 210; 1500 1500 1500 144
A	iVS1,6: 3 & 4; 8 & 9 iVS3, 8, 8H: 4 & 5; 11 & 12		750 210 & 750 210		1500 1500 & 750 750
C	iVS1,6: 3, 4 & 6 iVS3, 8, 8H: 6 & 7; 3, 4, 11 & 12		750, 360, 750		750 750 360 750 750
E	iVS3, 8, 8H: 3, 4, 11, & 12				750 750 750 750
F	iVS3, 8, 8H: 3 & 4; 11 & 12				750 360 & 750 210; 750 750 & 750 750
G	iVS3, 8, 8H: 3,4 & 9				750 750 750
H	iVS3, 8, 8H: 11 & 12				750 750

iVS Case Specifications

iVS1 and iVS6

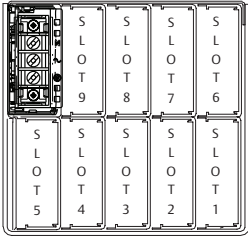

	Input	
	90-264 Vac	170-264 Vac
iVS1 = 5" x 5" x 11" (127 x 127 x 279.4) 9 available slots	1500 W max.	3210 W max.
iVS6 = 5" x 5" x 11" (127 x 127 x 279.4) 9 available slots 3-phase only	N/A	170-264 Vac 3210 W max.

iVS3, iVS8, and iVS8H

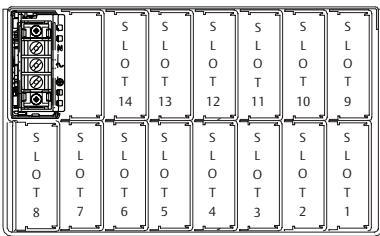

	Input	
	90-264 Vac	170-264 Vac
iVS3 = 5" x 8" x 11" (127 x 203.2 x 279.4) 14 available slots	1800 W max.	4500 W max.
iVS8 = 5" x 8" x 11" (127 x 203.2 x 279.4) 14 available slots	N/A	170-264 Vac 4920 W max.
iVS8H = 5" x 8" x 11" (127 x 203.2 x 279.4) 14 available slots	N/A	380 Vac 3800 W max. 480 Vac 4920 W max.

Pin Connectors

Figure 1. AC Input

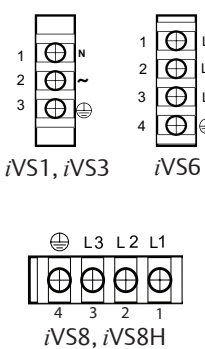

AC Input	Single Phase	3 Phase
Pin No.	Function	
1	AC neutral	Line 1
2	AC line (hot)	Line 2
3	Chassis (earth) ground	Line 3
4	Chassis (earth) ground	⊕

Figure 2. Connector J1

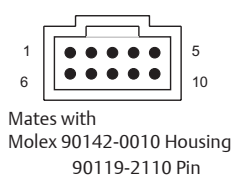

PFC Input Connector (control and signals)

Pin No.	Function
1	Input AC OK - "emitter"
2	Input AC OK - "collector"
3	Global DC OK - "emitter"
4	Global DC OK - "collector"
5	No connection
6	Global inhibit/optional enable logic "0"
7	Global inhibit/optional enable logic "1"
8	Global inhibit/optional enable return
9	+5 VSB housekeeping
10	+5 VSB housekeeping return

Figure 3. Connector J2

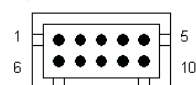

Mates with
Landwin 2050S1000 housing
2053T011P pin

I ² C Bus Output Connector	
Pin No.	Function
1	No connection
2	No connection
3	No connection
4	Serial clock signal (SCL)
5	Serial data signal (SDA)
6	Address bit 0 (A0)
7	Address bit 1 (A1)
8	Address bit 2 (A2)
9	Secondary return (GND)
10	5 VCC external bus (5 VCC bus)

iMP Modules

DC-DC Converter Output Modules

Control Signal Information, J1 Control Connector

Pin No.	Function	
1	+ Remote Sense	single or dual o/p main
2	Remote Margin / V. Program	single o/p
3	Margin High	single o/p
4	- Remote Sense / Margin Low	single or dual o/p main
5	Spare	
6	Module, Isolated Inhibit	single or dual o/p
7	Module Inhibit return	single or dual o/p
8	Current Share (SWP)	single or dual o/p main
9	+ Remote Sense V2	dual o/p, single is spare
10	- Remote Sense V2	dual o/p, single is spare

*Note: All iMP modules have a green DCOK LED.
(except for 36 W module)

Figure 4. Connector J1

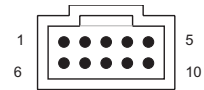

Mates with
Molex 90142-0010 Housing
90119-2110 Pin

Single 210 Watt

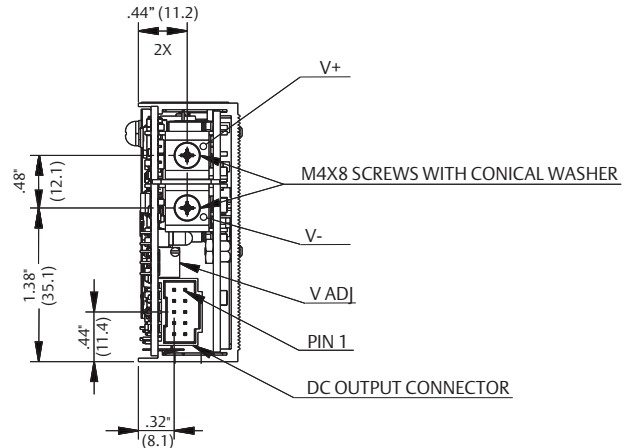

Single 360 Watt

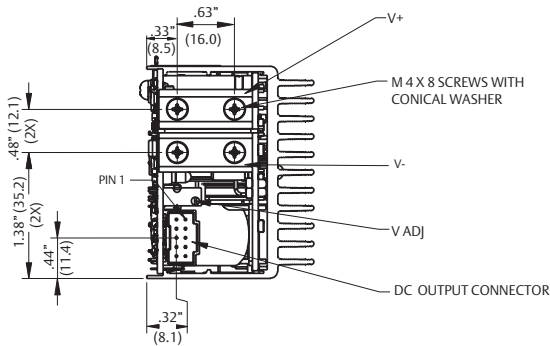

Single 750 Watt

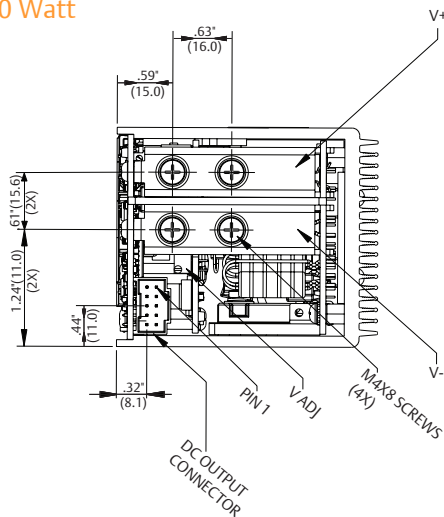

Single 1500 Watt

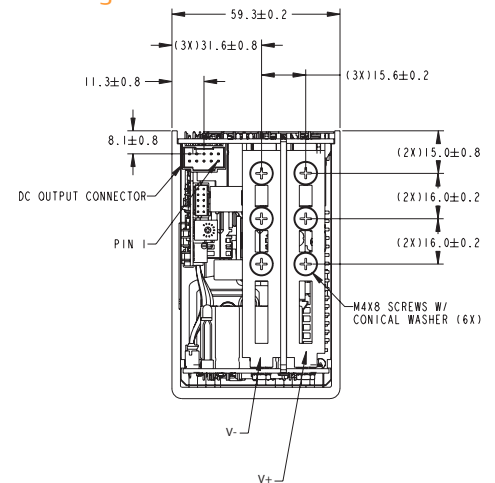

Dual 144 Watt

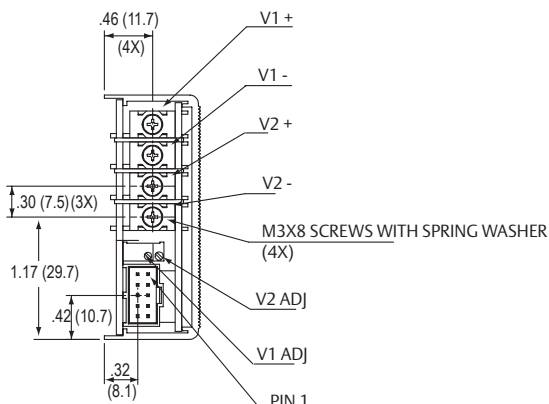

Triple 36 Watt

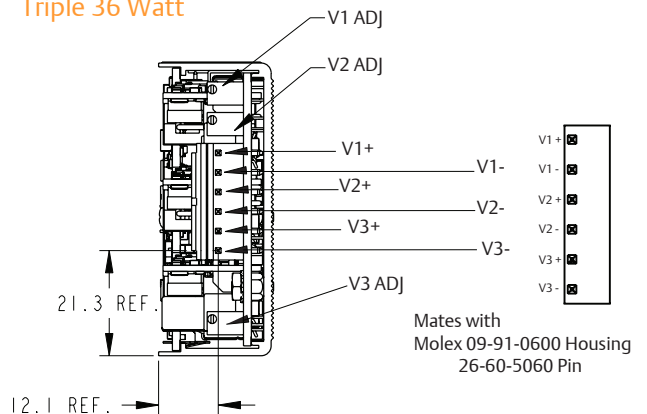

iVS Series

iVS1 (1500/3210 Watts Max)

5-Inch Case Size: iVS1: 5" x 5" x 11" (127mm x 127mm x 279.4mm)
 Weight: iVS1 Case: 6.2 lbs. • 1500 W Single: 2.0 lbs. • 750 W Single: 1.6 lbs.
 • 360 W Single: 1.0 lb. • 210 W Single: 0.6 lb. • 144 W Dual: 0.6 lb.

Rev. 4.7.09_145
 iVS Series
 7 of 11

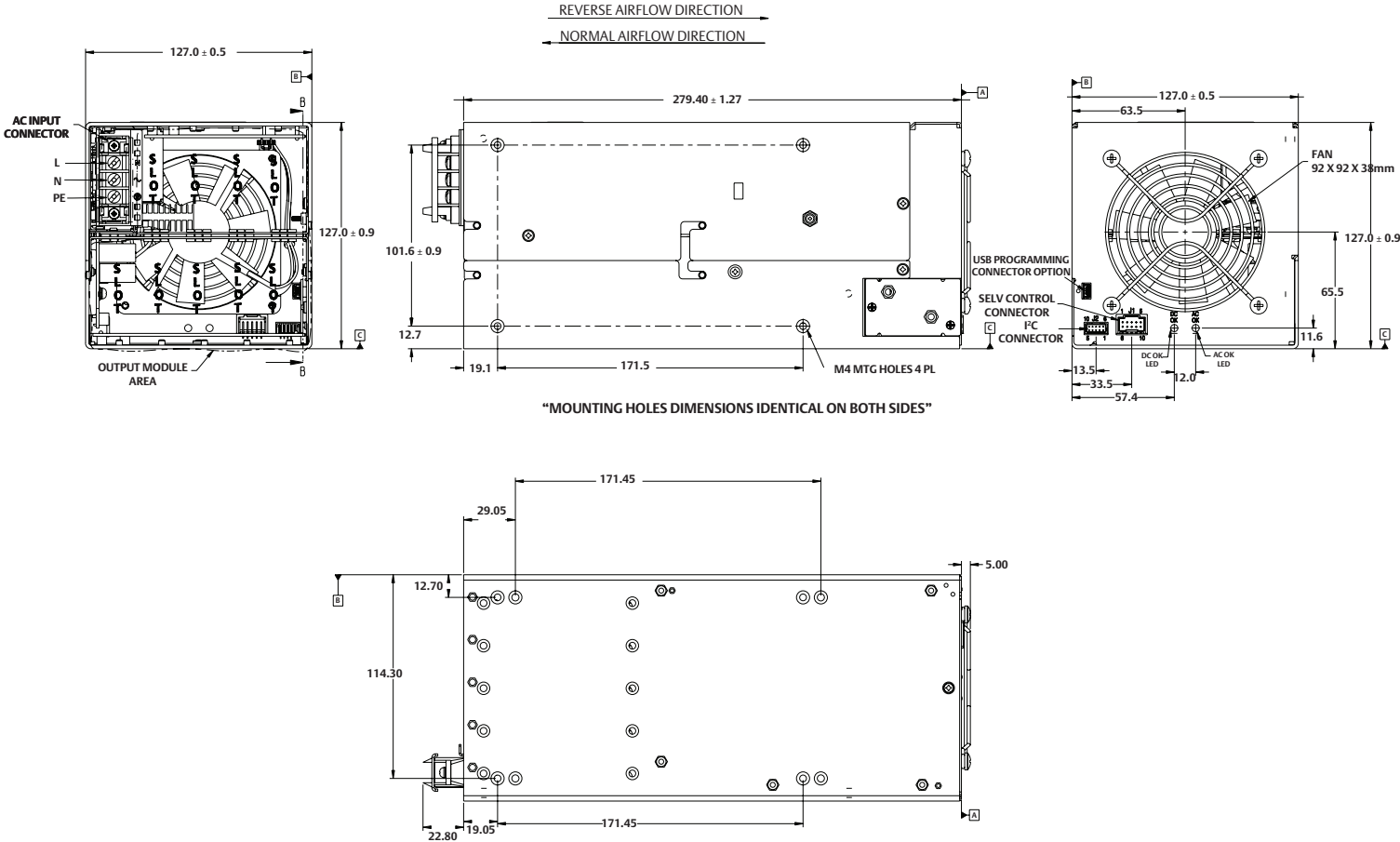

Notes

1. Input: Barrier type. Three No. 6-32 B.H. screws (0.375" centers). Max torque: 6 in-lbs. (0.67 N-m).
2. Control connectors: (J1) 10 position housing, gold plated contacts. Mates with Molex 90142-0010 housing with 90119-2110 crimp contacts (Molex C - Grid III Series). Connector kit includes mating connector and 10 pins, Astec part #70-841-004. (J2) 10 position housing (Landwin 2051P1000T). Mates with housing 2050S1000 (Landwin) with 2053T011P (Landwin) pins.
3. Chassis material: aluminum with chemical film coating (conductive).
4. All dimensions are in millimeters and inches, and are typical.
5. Customer mounting -3 sides M4, bottom also includes 8-32 mounting holes. Max. penetration is 0.155" (4.0 mm). Max. torque: 5 in-lbs. (0.57 N-m).
6. Output module connections: All single O/P modules are M4 x 8mm screws. Max. torque: 10 in-lbs. (1.13 N-m). Dual O/P module is M3 x 8mm screws. Max. torque: 5 in-lbs. (0.57 N-m).

iVS Series

iVS3 (1800/4500 Watts Max)

8-Inch Case Size: iVS3: 5" x 8" x 11" (127mm x 203.2mm x 279.4mm)
 Weight: iVS3 Case: 9.0 lbs. • 1500 W Single 2.0 lbs. • 750 W Single: 1.6 lbs.
 • 360 W Single: 1.0 lb. • 210 W Single: 0.6 lb. • 144 W Dual: 0.6 lb.

Rev. 4.7.09_145
 iVS Series
 8 of 11

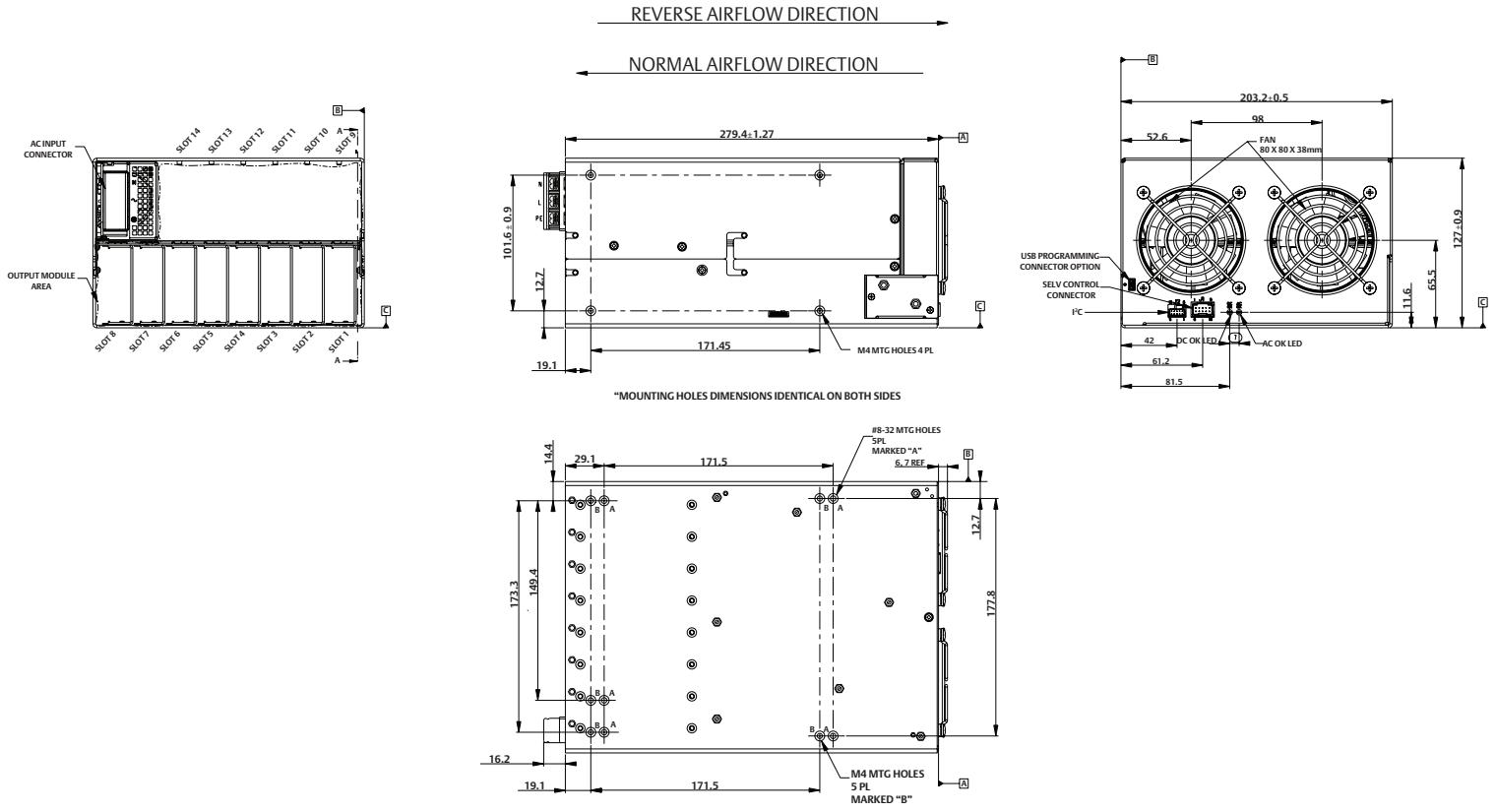

Notes

1. Input: Barrier type. Three M4 screws (0.512" centers). Max torque: 7 in-lbs. (0.79 N-m).
2. Control connectors: (J1) 10 position housing, gold plated contacts. Mates with Molex 90142-0010 housing with 90119-2110 crimp contacts (Molex C - Grid III Series). Connector kit includes mating connector and 10 pins, Astec part #70-841-004. (J2) 10 position housing (Landwin 2051P1000T). Mates with housing 2050S1000 (Landwin) with 2053T011P (Landwin) pins.
3. Chassis material: aluminum with chemical film coating (conductive).
4. All dimensions are in millimeters and inches, and are typical.
5. Customer mounting -3 sides M4, bottom also includes 8-32 mounting holes. Max. penetration is 0.155" (4.0 mm). Max. torque: 5 in-lbs. (0.57 N-m).
6. Output module connections: All single O/P modules are M4 x 8mm screws. Max. torque: 10 in-lbs. (1.13 N-m). Dual O/P module is M3 x 8mm screws. Max. torque: 5 in-lbs. (0.57 N-m).

iVS Series
iVS6 (3210 Watts Max)

5-Inch Case Size: iVS6: 5" x 5" x 11" (127mm x 127mm x 279.4mm)
 Weight: iVS6 Case: 6.0 lbs. • 1500 W Single 2.0 lbs.
 • 750 W Single: 1.6 lbs. • 360 W Single: 1.0 lb.
 • 210 W Single: 0.6 lb. • 144 W Dual: 0.6 lb.

Rev. 4.7.09_145
 iVS Series
 9 of 11

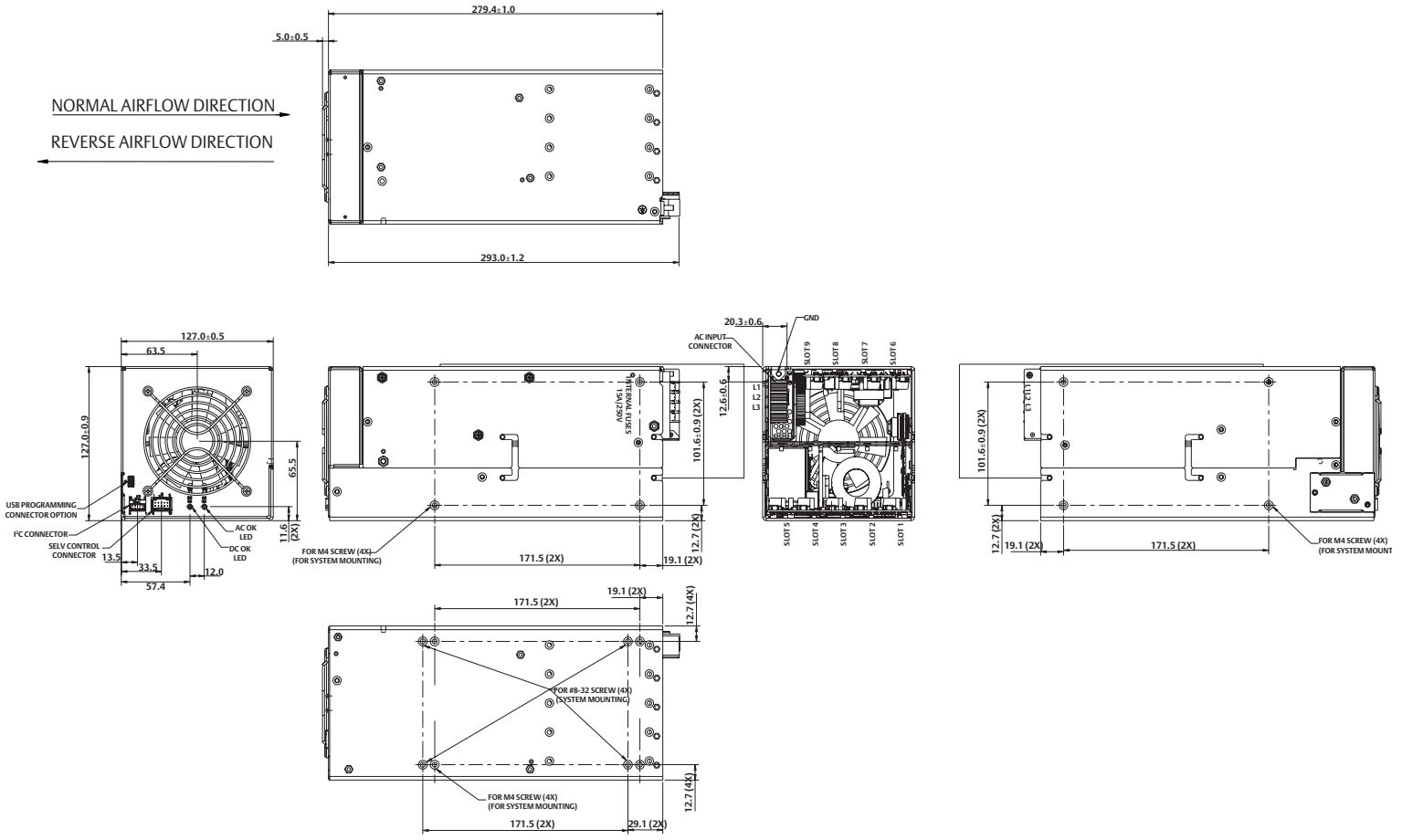

Notes

1. Input: Barrier type. Four M3 screws (0.325" centers). Max torque: 6 in-lbs. (0.67 N-m).
2. Control connectors: (J1) 10 position housing, gold plated contacts. Mates with Molex 90142-0010 housing with 90119-2110 crimp contacts (Molex C - Grid III Series). Connector kit includes mating connector and 10 pins, Astec part #70-841-004. (J2) 10 position housing (Landwin 2051P1000T). Mates with housing 2050S1000 (Landwin) with 2053T011P (Landwin) pins.
3. Chassis material: aluminum with chemical film coating (conductive).
4. All dimensions are in millimeters and inches, and are typical.
5. Customer mounting -3 sides M4, bottom also includes 8-32 mounting holes. Max. penetration is 0.155" (4.0 mm). Max. torque: 5 in-lbs. (0.57 N-m).
6. Output module connections: All single O/P modules are M4 x 8mm screws. Max. torque: 10 in-lbs. (1.13 N-m). Dual O/P module is M3 x 8mm screws. Max. torque: 5 in-lbs. (0.57 N-m).

iVS Series

iVS8 (4920 Watts Max)

8-Inch Case Size: iVS8: 5" x 8" x 11" (127mm x 203.2mm x 279.4mm)

Weight: iVS8 Case: 9.0 lbs. • 1500 W Single 2.0 lbs.

• 750 W Single: 1.6 lbs. • 360 W Single: 1.0 lb.

• 210 W Single: 0.6 lb. • 144 W Dual: 0.6 lb.

Rev. 4.7.09_145

iVS Series

10 of 11

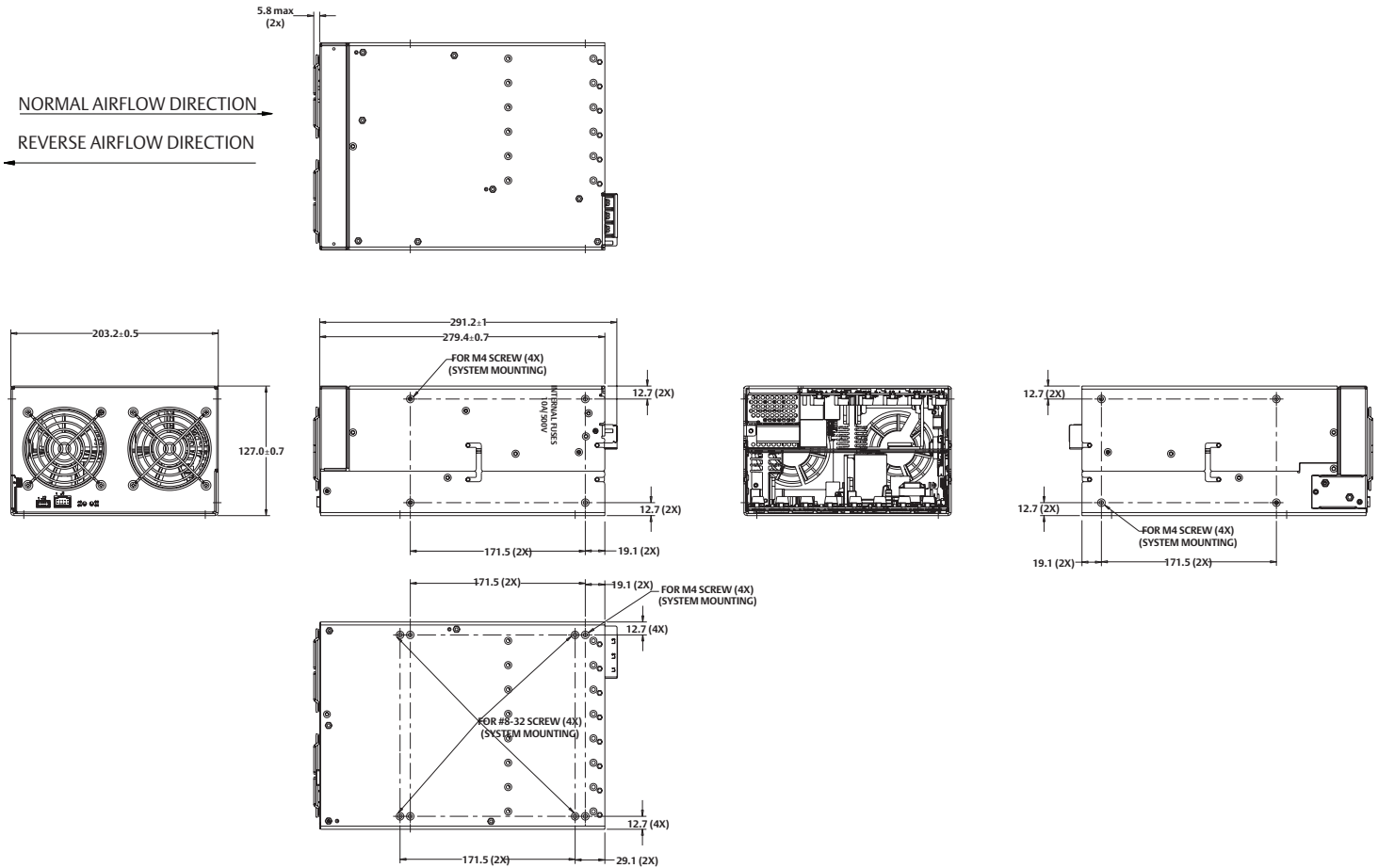

Notes

1. Input: Barrier type. Three M3.5 screws (0.394" centers). Max torque: 6 in-lbs. (0.67 N-m).
2. Control connectors: (J1) 10 position housing, gold plated contacts. Mates with Molex 90142-0010 housing with 90119-2110 crimp contacts (Molex C - Grid III Series). Connector kit includes mating connector and 10 pins, Astec part #70-841-004. (J2) 10 position housing (Landwin 2051P1000T). Mates with housing 2050S1000 (Landwin) with 2053T011P (Landwin) pins.
3. Chassis material: aluminum with chemical film coating (conductive).
4. All dimensions are in millimeters and inches, and are typical.
5. Customer mounting -3 sides M4, bottom also includes 8-32 mounting holes. Max. penetration is 0.155" (4.0 mm). Max. torque: 5 in-lbs. (0.57 N-m).
6. Output module connections: All single O/P modules are M4 x 8mm screws. Max. torque: 10 in-lbs. (1.13 N-m). Dual O/P module is M3 x 8mm screws. Max. torque: 5 in-lbs. (0.57 N-m).

Americas

5810 Van Allen Way
Carlsbad, CA 92008
USA
Telephone: +1 760 930 4600
Facsimile: +1 760 930 0698

Europe (UK)

Waterfront Business Park
Merry Hill, Dudley
West Midlands, DY5 1LX
United Kingdom
Telephone: +44 (0) 1384 842 211
Facsimile: +44 (0) 1384 843 355

Asia (HK)

14/F, Lu Plaza
2 Wing Yip Street
Kwun Tong, Kowloon
Hong Kong
Telephone: +852 2176 3333
Facsimile: +852 2176 3888

For global contact, visit:

www.PowerConversion.com
techsupport.embeddedpower@emerson.com

While every precaution has been taken to ensure accuracy and completeness in this literature, Emerson Network Power assumes no responsibility, and disclaims all liability for damages resulting from use of this information or for any errors or omissions.

Emerson Network Power.
The global leader in enabling
business-critical continuity.

- AC Power
- Connectivity
- DC Power
- Embedded Computing
- **Embedded Power**
- Monitoring
- Outside Plant
- Power Switching & Controls
- Precision Cooling
- Racks & Integrated Cabinets
- Services
- Surge Protection

EmersonNetworkPower.com

Emerson Network Power and the Emerson Network Power logo are trademarks and service marks of Emerson Electric Co.
©2008 Emerson Electric Co.