

SKF



SKF TKSA 31 & TKSA 41

宁波市镇海利德仪器设备有限公司 0574-82699700 QQ: 1175104622

Instructions for use

Table of contents

EC Declaration of conformity	2	4.3 Horizontal correction – Top view	25
Safety recommendations	3	4.4 Recheck – remeasure	27
1. Introduction	4	5. Create a report.....	28
1.1 Shaft alignment overview	4	5.1 Reporting	28
1.2 Principle of operation.....	5	5.2 Report creation page.....	29
1.3 Case content.....	6	5.3 Report content and browser	30
1.4 Product description	7	6. QR codes, machine library, soft foot.....	32
2. Getting started.....	8	6.1 QR code (TKSA 41 only)	32
2.1 Mounting the V-brackets.....	8	6.2 Machine library	33
2.2 Switching on the display unit.....	9	6.3 Soft foot 1	35
2.3 Connecting the wireless MU on TKSA 41.....	10	6.4 Soft foot 2	36
2.4 Connecting the wired MU on TKSA 31/41.....	11	7. Settings	37
2.5 Adjusting the lasers	12	7.1 Main settings menu.....	37
2.6 Home screen	13	7.2 User settings	38
2.7 Charging.....	14	7.3 Measurements settings	39
2.8 Charging the measuring units	14	7.4 Display unit and measuring unit info	40
3. Take a measurement.....	15	7.5 Languages	41
3.1 3 Ways to start an alignment.....	15	7.6 Units and date & clock	42
3.2 Dimensions screen	16	7.7 General settings.....	43
3.3 9-12-3 Measurements	17	8. Troubleshooting	44
3.4 Automatic measurements.....	19	8.1 Perform a reset.....	44
3.5 Free measurement.....	20	8.2 Power modes	44
3.6 Backlash.....	21	8.3 Firmware update	45
4. Correct the alignment	22	8.4 Wireless connection troubleshooting.....	46
4.1 Results page.....	22	9. Technical specifications	47
4.2 Vertical correction – Side view – Shimming	23		

Original instructions

EC Declaration of conformity

We, SKF Maintenance Products, Kelvinbaan 16, 3439 MT Nieuwegein, The Netherlands herewith declare that the following products:

SKF Shaft Alignment Tool TKSA 31 & TKSA 41

has been designed and manufactured in accordance with: EMC DIRECTIVE 2004/108/EC as outlined in the harmonized norm for EN 61326-1:2013 Electrical equipment for measurement, control and laboratory use – Part 1: General Requirements, EN 55011: 2009 +A1:2010, EN 61000-4-2: 2009, EN 61000-4-3: 2006 +A1:2008 +A2:2010, EN 61000-4-4: 2004 +A1:2010, EN 61000-4-5: 2006, EN 61000-4-6: 2009, EN 61000-4-11: 2004

EUROPEAN ROHS DIRECTIVE 2011/65/EU

The laser is classified in accordance with the EN 60825-1:2007. The laser complies with 21 CFR 1040.10 and 1040.11 except for deviations pursuant to Laser Notice No. 50, dated June 24, 2007.

TKSA 41 only: The enclosed device complies with Part 15 of the FCC Rules. 47CFR: 2011 Part 15 Sub Part B Unintentional Radiators. Contains FCC ID: 0C3BM1871, QDID: B020997. Manufacturer's Name, Trade Name or Brand Name: NovaComm. Model Name: NVC-MDCS71.

Nieuwegein, The Netherlands, November 2014



Sébastien David
Manager Product Development and Quality



Safety recommendations

- The complete instructions for use are available on this device and the latest version on SKF.com.
- Read and follow all warnings and operating instructions in this document before handling and operating the equipment. You can be seriously injured; equipment and data can be damaged if you do not follow the safety warnings.
- TKSA 31/41 uses Class 2 lasers with output power < 1.0mW. Never stare directly into the laser beam. Never direct the laser into anyone else's eyes.
- Dress properly. Do not wear loose clothing or jewellery. Keep your hair, clothing, and gloves away from moving parts.
- Do not overreach. Keep proper footing and balance at all times to enable better control of the device during unexpected situations.
- Use safety equipment. Non-skid safety shoes, hard hat or hearing protection must be used for appropriate conditions.
- Never work on energized equipment unless authorized by a responsible authority. Always turn off the power of the machine before you start.
- Do not expose the equipment to rough handling or impacts this will void the warranty.
- Avoid direct contact with water, wet surfaces, or condensing humidity.
- Do not attempt to open the device, this will void the warranty.
- Use only accessories that are recommended by SKF.
- Device service must be performed only by qualified SKF repair personnel.
- We recommend calibrating the tool every 2 years.



1. Introduction

1.1 Shaft alignment overview

Shaft misalignment is one of the most significant and most preventable contributors to premature machine failure.

When a machine is placed in service with less than optimal shaft alignment, the following conditions are likely:

- Poor machine performance
- Increased power consumption
- Increased noise and vibration
- Premature bearing wear
- Accelerated deterioration of gaskets, packing, and mechanical seals
- Higher coupling wear rates
- Increased unplanned downtime

Proper alignment is achieved when the centrelines of each shaft are co-linear when the machine is under load and at normal operating temperatures. This is often referred to as shaft-to-shaft alignment.

If the shafts of a machine train are not co-linear, when the machine is in operation, they are misaligned.

In essence, the objective is to have a straight line through the centres of all of the shafts of the machines. The SKF Shaft Alignment Tool TKSA 31/41 is a laser shaft alignment tool that allows an easy and accurate method for aligning the shafts of a driving machine (eg electric motor) and a driven machine (eg. pump).

1.2 Principle of operation

The TKSA 31/41 uses two measuring units (MU) both provided with a laser diode and a CCD detector. As the shafts are rotated through 180° any parallel or angular misalignment causes the two laser lines to deflect from their initial relative position.

The measurements from the two detectors are used to automatically calculate the misalignment and guide the user through the vertical (shimming) and horizontal correction steps.

The measurements can be taken according to the 9-12-3 method or with a free measurement method on the TKSA 41. Measurements can also be taken automatically without action from the user on the Display Unit.

The TKSA 41 can be used with the display flat on the floor or vertical. The screen orientation will adapt to the display unit orientation. Results can be saved on a pdf report and exported on a USB stick.



1.3 Case content



1. 1 × TKSA 31/41 Display unit	8. 1 × 12V DC 3A Power supply
2. 1 × TKSA 31/41 S Measuring unit	9. Country adapters (US, UK, EU, AUS)
3. 1 × TKSA 31/41 M Measuring unit	10. 2 × Micro USB to USB cables*
4. 2 × Shaft V-Brackets with chains	11. Printed Quick Start Guide (EN)*
5. 90 mm Extension rods (TKSA 41 only)	12. Printed certificate of Calibration and conformance*
6. 1 × Chain tightening rod	13. 1 × Page of QR code stickers (TKSA 41 only)*
7. 5 m (16 ft) metric and imperial measuring tape	* <i>not shown</i>

1.4 Product description



2. Getting started

2.1 Mounting the V-brackets

Use the V-brackets to attach the measuring units (MU) to the shafts.

Make sure the unit marked “**M**” is attached to the **Moveable machine** and the unit marked “**S**” to the **Stationary machine**.

If it is not possible to attach the V-brackets directly to the shafts (e.g. in case of space problems) the fixtures can be attached to the coupling.

For shafts with diameter < 40 mm (< 1.5 ”) hook the chain to the anchor in the V-bracket from the inside.

The tightening knob should use the space closer to the rod.

For larger diameters hook the chain from the outside.

Remove the slack of the chain and tighten it firmly with the tensioning knobs with the rod tensioning bar.



Make sure the rods are **firmly tightened** to the brackets before mounting the measuring units.

Make sure the Measuring Units are firmly tightened on the rods and **DO NOT** lie on bracket.

Brackets are symmetric, they can be mounted either way.

2.2 Switching on the display unit

Press the red **On/Off** button on the display unit (DU) for > 1 sec.

The unit is fully started when it reaches the home screen.

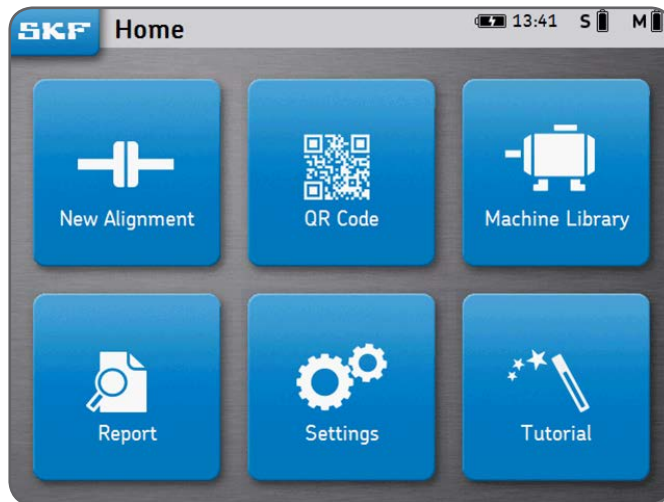

Short press the red **On/Off** button on the display unit to:

- Start the DU.
- Put the DU in stand-by.
- Wake-up the DU from stand-by.

Note:

To restart/reset the unit, keep the On/Off button pressed until the display unit switches off (~6 seconds)

- The DU will enter deep sleep after 2 hours of inactivity.
- The DU will **never** turn off during an alignment job.
- The Display Unit does **NOT** need to be switched off.
Short press for stand-by only.

2.3 Connecting the wireless MU on TKSA 41

The Measuring Units can be connected in bluetooth (wireless) or via the USB cables for charging or in the event of a power loss.

See next chapter for USB connection.

- Turn On **both** MU with a short press on the red **On/Off** button.
- The front LED first indicates the battery status:
 - **Green** = Full
 - **Amber** = Low
 - **Red** = Charge now
- The LED will start blinking in a blue colour to indicate the MU is trying to connect to the DU.
The Bluetooth symbol appears in the top right corner of the display next to the “S” and “M” letters.
- The MU will connect automatically to the DU.
When connected, the battery level of the MU is shown.



Note:

- Click on the top right corner (red zone on the right) of the display to open the MU settings.
- Once connected, the MU LED remains off.
- If the MUs do not connect, check the *Troubleshooting* section.
- **Switch off** the MU with a **long press** on the On/Off button until a **steady red LED** appears.



2.4 Connecting the wired MU on TKSA 31/41

The MU can be connected to the DU via USB cable.

- Make sure the MU are both switched off. (TKSA 41 only).
 - Connect the **USB cables** to the Display Unit.
The USB Symbol on the cable should be facing upwards.
-
- Connect the **Micro USB cables** to the Measuring Units.
The locking pins on the connector should be directed **towards the front** (laser part) of the MU.
 - The MU will automatically connect to the DU.
A USB symbol will be shown next to the “S” and “M” letters.

Note:

- Switch Off the MU before disconnecting the USB cables.
- See section *Troubleshooting* for any connection issue.



S  M 

2.5 Adjusting the lasers

- Lock the “**M**” measuring unit (MU) in position.
- Adjust the height of the “**S**” unit so that its laser line hits the “**M**” MU in the centre of the detector, on the red mark.
- Lock firmly the “**S**” unit in position.
- Use the knob on top of the “**M**” unit to vertically adjust the laser position on the “**S**” unit.



2.6 Home screen

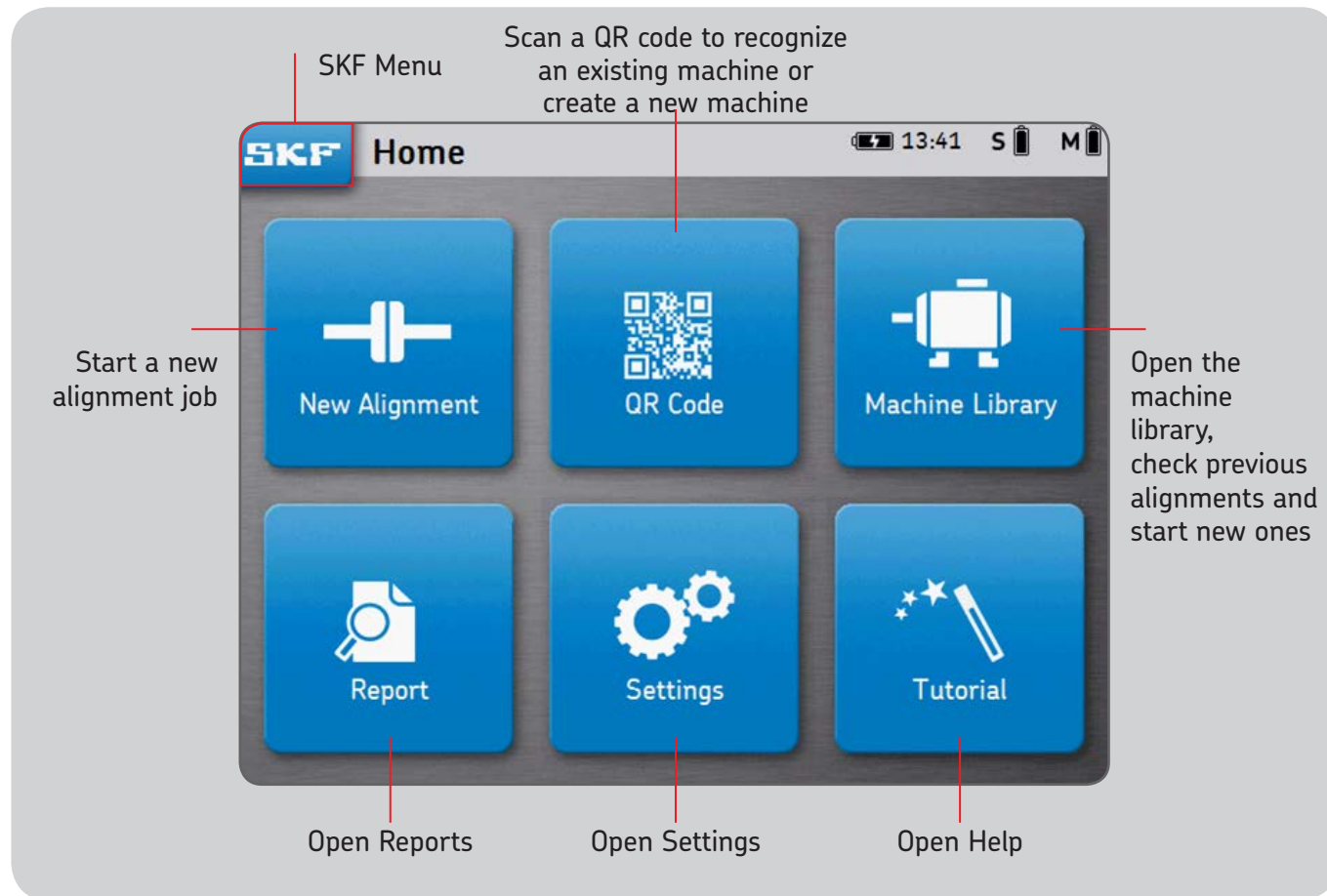

2.7 Charging

- Connect the 12V power adapter to the charging port in the back of the DU.

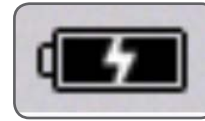

- A battery charging indicator appears on the top right of the screen to indicate charging of the DU and MU.

Note:

- The display unit will charge in standby mode.
- The display unit will wake up when connected to power.

2.8 Charging the measuring units

- Connect the MU to the display unit with the micro USB cables.
- The charging symbol will be shown on the screen.

3. Take a measurement

3.1 3 Ways to start an alignment

From the Home screen:

Click on “New alignment” or ->



Click on “QR code” or ->



Click on “Machine library”

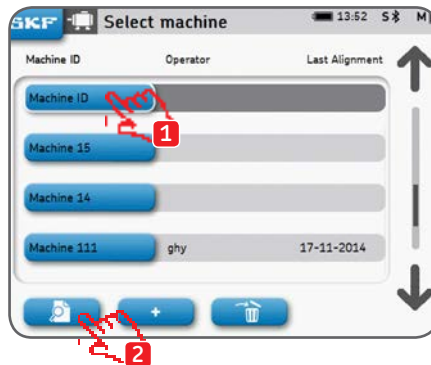

3.2 Dimensions screen

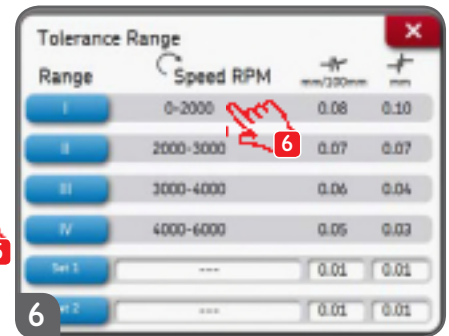
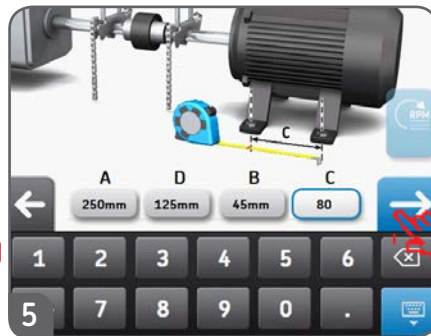
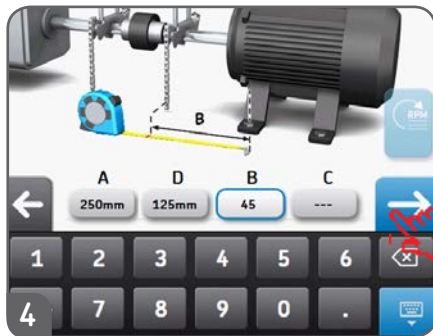
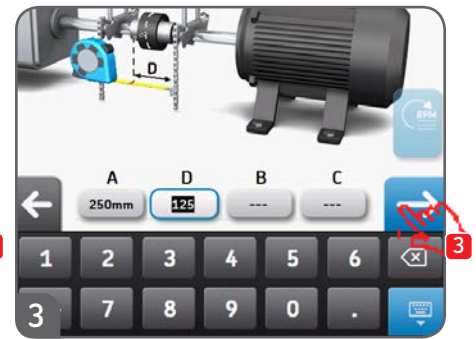
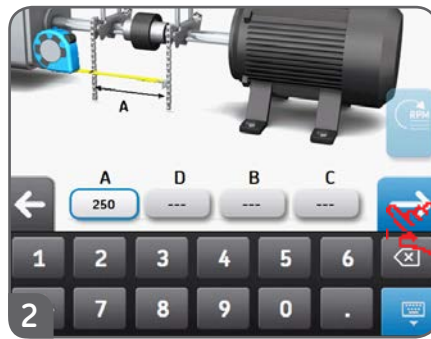
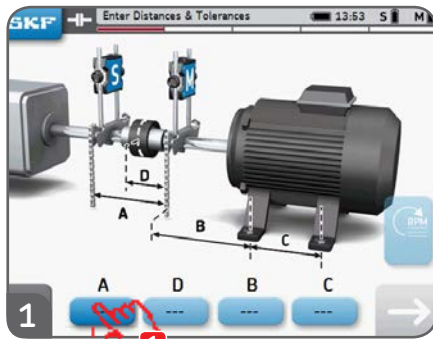

- Each dimension input box can be clicked at any time.
- Two custom tolerances can be setup “set 1” and “set 2”.
Fill in the angular and parallel misalignment and click on the corresponding blue button.
- The units English or Metric can be selected from the settings menu before the alignment is started.
- Go to the measurement screen by clicking on the next arrow.

3.3 9-12-3 Measurements

- The measurement type can be selected before starting the alignment via *Settings --> Measurement Settings*.
 - The analogy of a clock face is used to describe the different measurement positions. The first position for measurement is the 9 o'clock position, when looking from behind the moveable machine. Measurements are to be taken successively in three different positions (9 (-90°)-12 (0°)-3 (+90°)).
 - The screen shows the measuring units viewed from the movable machine.
 - A triangular wedge will indicate the required position of the measuring units during each step.
1. Turn the shafts to the blue wedge at the 9 o'clock position. (-90°)
 2. When positioned within blue wedge the wedge becomes green.
 3. Click on the "next" arrow to take a measurement.
 4. Turn the shafts to the blue wedge at the 12 o'clock position. (0°)
 5. Click on the "next" arrow to take a measurement.
 6. Turn the shafts to the blue wedge at the 3 o'clock position. (+90°)
 7. Click on the "next" arrow to take a measurement.

Note:

- Do not move or touch the measuring units or the chain V-brackets or their rods during the measurement.
- Do not use the measuring equipment as a handle to turn the shafts.
- Make sure the motor bolts are tightened before starting the measurements.
- The alignment job can be cancelled at any time. SKF --> End Alignment

9-12-3 Measurements

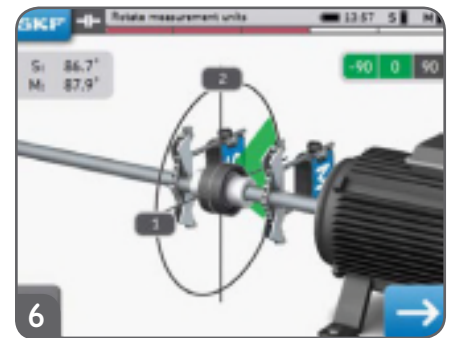
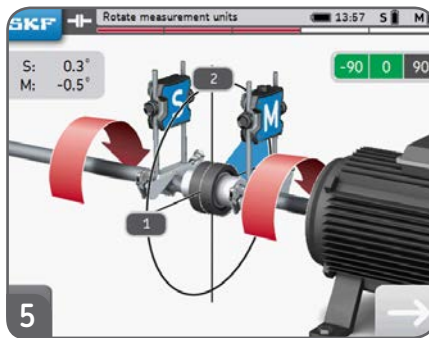
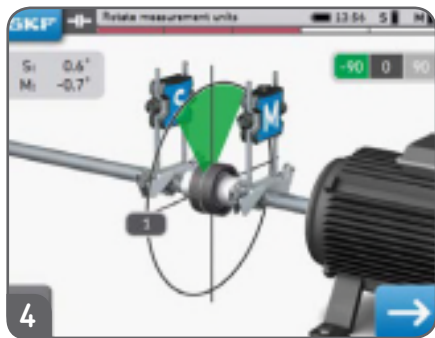
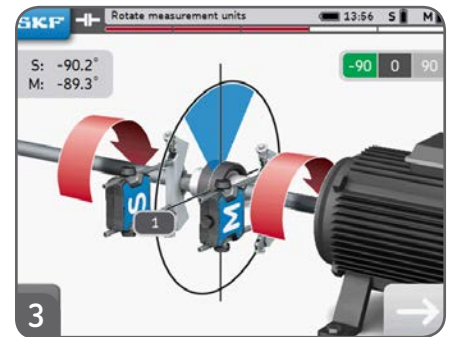
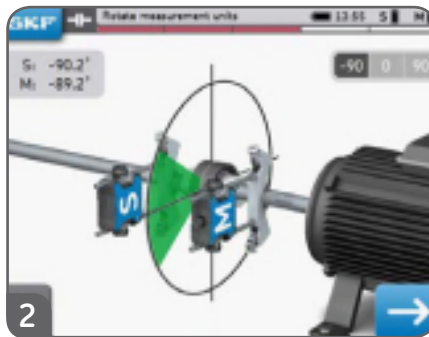
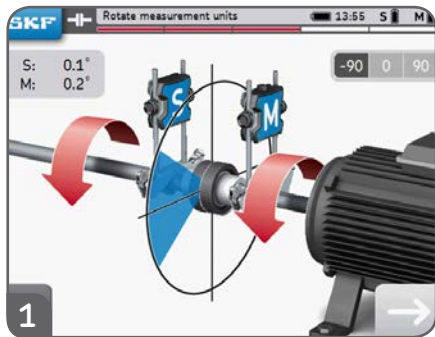

- The raw S and M reading in the bottom left of the screen can be enabled from *Settings* --> *General*.
- The angle difference between the S and M MU should be **less than 2°**.

3.4 Automatic measurements

- The automatic measurement feature allows the user to measure the alignment without having to interact with the display unit.
- The symbol AUTO appears in the bottom right instead of the arrow.
- A measurement is taken automatically after the countdown.



- **Turn the MU in the right position and the measurement will be taken automatically.**
- Once the first measurement is taken, move on with the other measurements.
- Should the MU move during countdown, the measurement will be interrupted.

3.5 Free measurement

Free measurement allow the user to:

- Start a measurement from any position.
- Take all 3 × measurements within a minimum of 90°.

Free measurement is useful when the ability to rotate the shafts is limited.

Example:

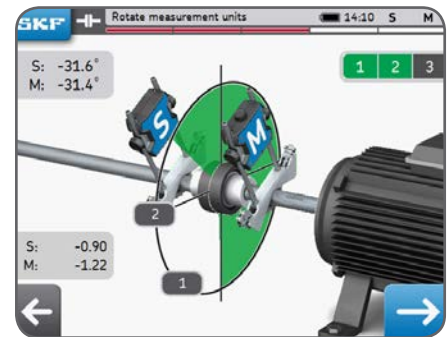
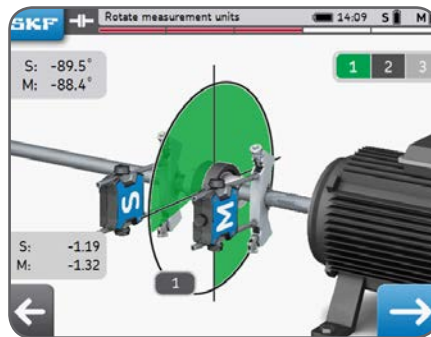
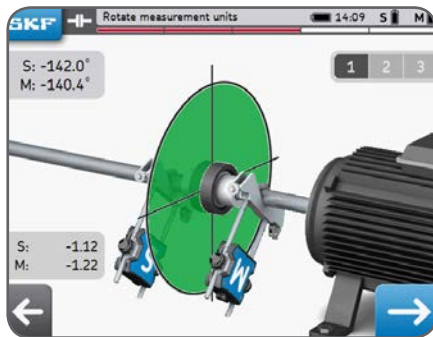

- Free measurement can be enabled from *Settings --> Measurement Settings*.
- Automatic measurement cannot be used together with free measurements.
- Better results are achieved when the total measurement angle is close to 180°.

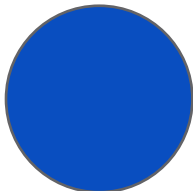

Measurement 1

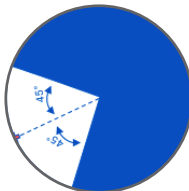

Measurement 2

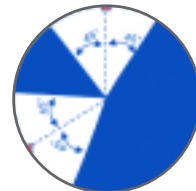

Measurement 3

3.6 Backlash

In order to achieve the best measurements accuracy, **the measuring units should not be separated by more than 2° from each other.**

When the MUs are more than 2° apart, this condition is called backlash.

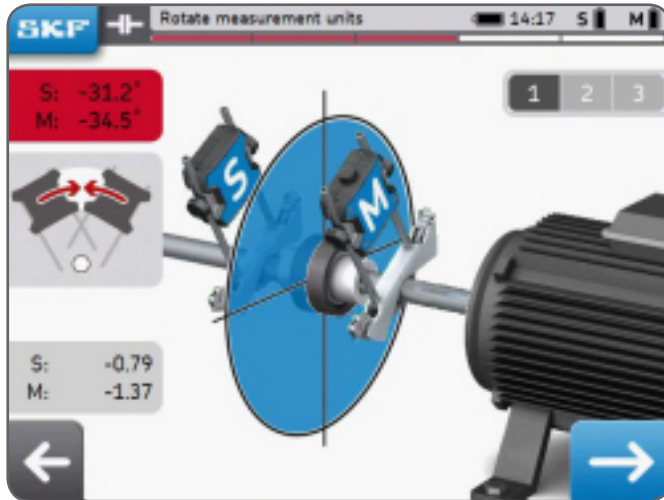

Example: MUs are 3° apart in the above example

- Backlash warnings are enabled only when the MU are within a blue wedge.
- **It is always possible to take a measurement with backlash (ie MU angle >2°).**
 - Accept the warning message to take the measurement anyway.

4. Correct the alignment

4.1 Results page

The results page shows the coupling and feet adjustment values. The symbols compare the results to the selected tolerance. The motors movement graphically represents the results.

The **black line** being where the motor should be, the **blue line** being where the motor currently is.

The screenshot displays the SKF mobile application interface for alignment results. At the top, it shows 'Result: As Found' and the time '14:18'. The main area is divided into two sections: 'Horizontal: Top View' and 'Vertical: Side View'. Each section shows two alignment parameters with their respective values, units, and status symbols.

View	Parameter	Value	Unit	Status
Horizontal: Top View	Horizontal	-0.12	mm/100mm	Close to tolerance
	Vertical	0.23	mm	Out of tolerance
Vertical: Side View	Horizontal	-0.03	mm/100mm	Within tolerance
	Vertical	0.10	mm	Within tolerance

A legend on the left side of the screen defines the status symbols:

- ✓ Within tolerance
- ≈ Close to tolerance
- ✗ Out of tolerance

At the bottom of the screen, there are four navigation buttons: a back arrow, a 'redo' button, a 'Change tolerance' button, and a 'Finish and Create report' button. A red hand icon with the number '1' is pointing to the 'Finish and Create report' button.

Labels in the image point to various elements:

- 'Graphical view' points to the motor illustrations.
- 'Horizontal Correction' points to the 'Horizontal: Top View' data box.
- 'Symbol' points to the green checkmark in the 'Vertical: Side View' data box.
- 'Take measurements again' points to the 'redo' button.
- 'Change tolerance' points to the 'Change tolerance' button.
- 'Finish and Create report' points to the 'Finish and Create report' button.

4.2 Vertical correction – Side view – Shimming

If the vertical results are out of tolerance, you need to correct the value by adding or removing shims. The system calculates the correction values at the feet.

- Start by rotating the MU at the 12 o'clock (0°) or 6 o'clock (180°) position and validate.
- The arrows show in which direction the motor has to be moved.
 - Up arrow means the motor has to go up.
 - Down arrow means the motor has to go down.
- Coupling values are a direct measurement.
- Feet values are calculated using the distances previously entered.
- Coupling and feet values are **updated live** on the screen.
 - Use the Pause button to freeze the live update.
 - This can be useful to remember the correction values.
- STOP when the coupling values are within tolerance and both **Green marks** are shown.

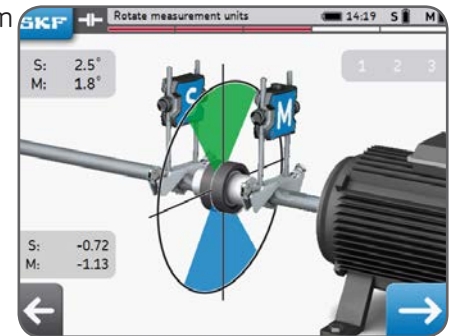

o

IMPORTANT:

- **Make sure all motor feet are shimmed.**
- Only **coupling values matter**. Once they are within chosen tolerance do not try to overcorrect and do not try to reach zero for the feet value.

Vertical correction – Side view – Shimming

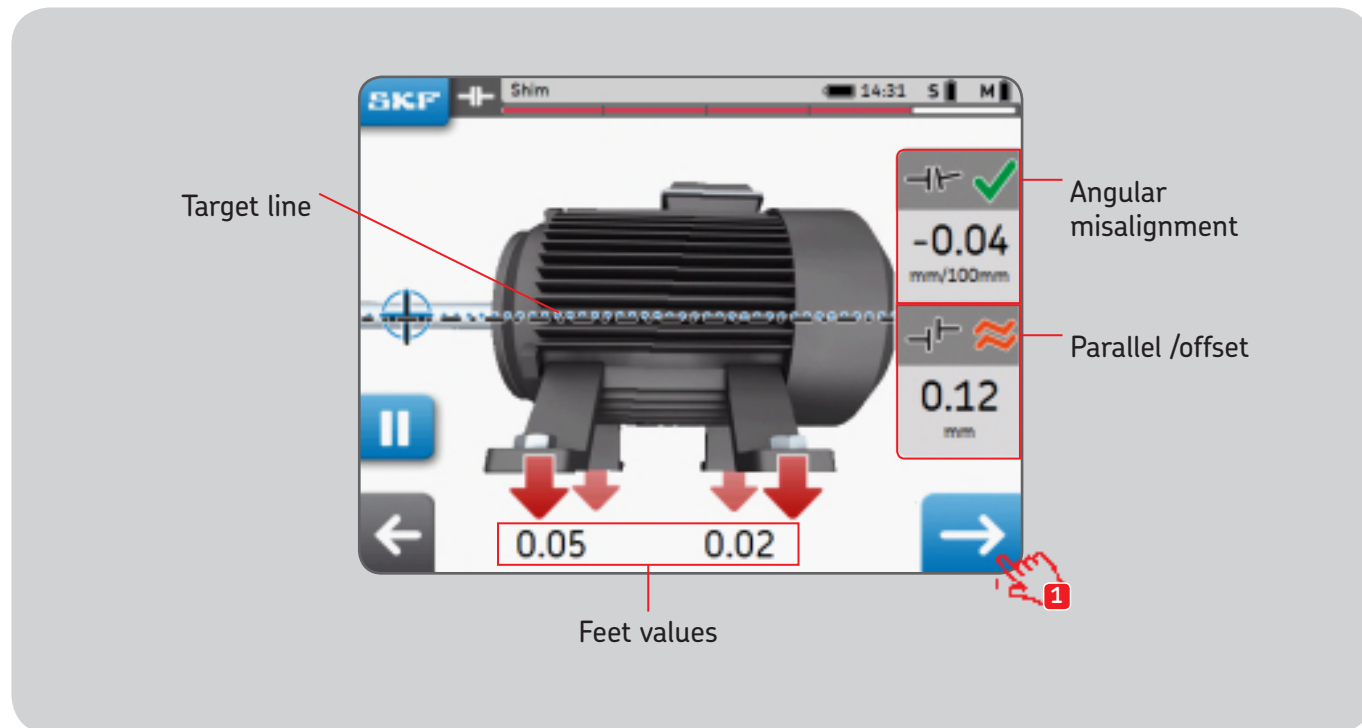

This motor has to go up!

4.3 Horizontal correction – Top view

If the horizontal results are out of tolerance, you need to correct the value by moving the movable machine. The system calculates the correction values at the feet.

- Start by rotating the MU at the 3 o'clock (+90°) or 9 o'clock (-90°) position and validate.
- The arrows show in which direction the motor has to be moved.
 - **Up** arrow means the motor has to go **to the right**.
 - **Down** arrow means the motor has to go **to the left**.
- Coupling values are a direct measurement.
- Feet values are calculated with the distances previously entered.
- Coupling and feet values are **updated live** on the screen.
 - Use the Pause button to freeze the live update.
 - This can be useful to remember the correction values.
- STOP when the coupling values are within tolerance and both **Green marks** are shown.

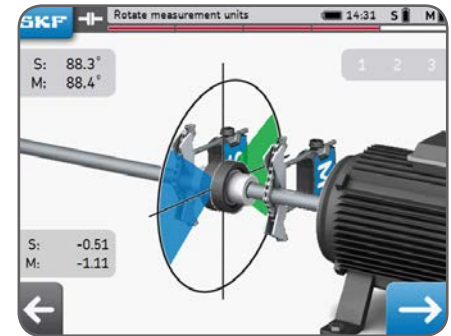

IMPORTANT:

- Start by moving the motor side with the highest correction value.
- Tighten the bolts when finished with the horizontal correction.

Horizontal correction – Top view

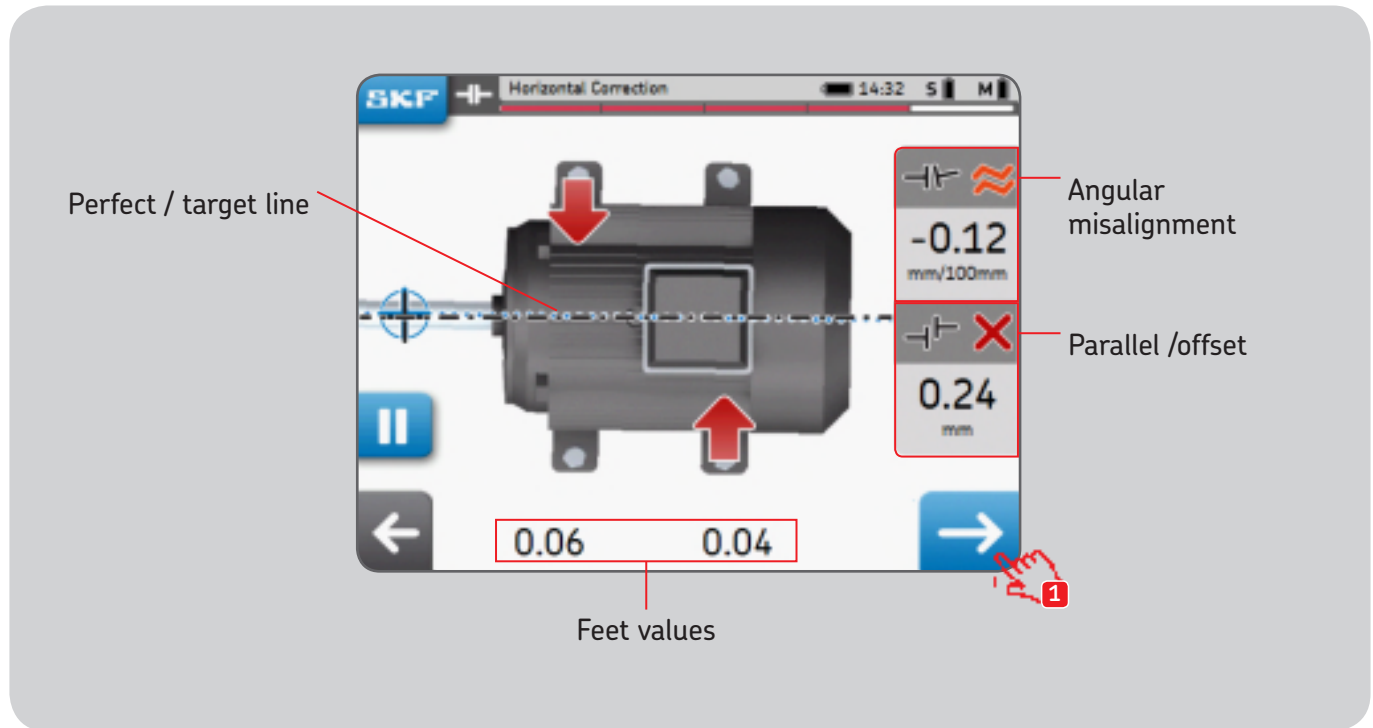

This motor has to go to the right!

4.4 Recheck – remeasure

After the horizontal correction, it is recommended to measure again the alignment.

- Answer **Yes** to the Recheck Popup to **measure again**.
- Answer **No** to **create a report**.

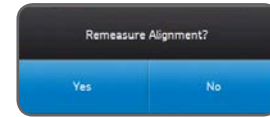

- Perform the three measurements.

- Check the result screen:

1. Click the shim button to correct the alignment.
2. Click the flag button to end the alignment and create a report.



5. Create a report

5.1 Reporting

Reports can be viewed on the display unit or exported as a pdf on a USB stick.

To export a report as pdf:

- Select the Report icon from the Home page.
- Select the report to export.
- Insert a USB stick into any USB port of the display unit.
- Select the USB icon in the bottom right. The icon becomes blue once a USB stick is inserted.
- The report will be generated as pdf and exported on the stick.

Note:

Reports can be found on the folder “*Alignment reports*” on the USB stick.
Pdf reports files are named using the report name and the date.

5.2 Report creation page

The following fields can be used:

- **Machine Name:** Enter the name of the machine
 - This field will already be filled when the alignment has been started from an existing machine.
- **Report Name:** Mandatory field
- **Operator:** Filled automatically with user data.
- **Photo:** Up to 3x photos can be added to the report (TKSA 41 only)
 - Photos can also be taken during the alignment via SKF --> *Photo notes*
- **Comments:** Comments can be added.
- Click Next to create and visualize the report



The screenshot displays the SKF Report creation interface. At the top, the SKF logo is on the left, and the title 'Report' is in the center. The status bar at the top right shows the time 14:35, signal strength, and battery level. The form contains the following fields:

- Machine ID:** A text input field containing 'My Machine'.
- Report Name:** A text input field containing 'My Report'.
- Operator:** A text input field containing 'Julien Meunier'.
- Photo:** A section with a small photo thumbnail on the left and two blue camera icons with plus signs on the right.
- Comments:** A text area containing the text 'Machines aligned within tolerance'.

A blue arrow button is located at the bottom right of the form, with a red hand icon and the number '1' pointing to it, indicating the next step in the process.

5.3 Report content and browser

The reports are organized in 4 parts/screens or 2 pages for the pdf.
Click on the top or bottom part of the screen to navigate through the pages.
Click on the back button to go back.

The report additionally contains:

- User name, address and logo when filled in.
- Dimensions, alignment and correction results, soft foot results
- Instrument information.
- Machine name, QR code.
- Space for date and signature.

Shaft Alignment Report SKF

Report name: My Report

Machine ID: My Machine Instrument: TKSA-41
 Operator: Julien Meunier Serial No. MU-M: TKSA41-M-1433-0019
 Date: 24-11-2014 Serial No. MU-S: TKSA41-S-1433-0013
 Previous Alignment: --- Measuring Unit Temperature: 32.0°C

Comments: Machines aligned within tolerance



Soft Foot

Soft Foot checked: No As Found Soft Foot corrected: No As Corrected

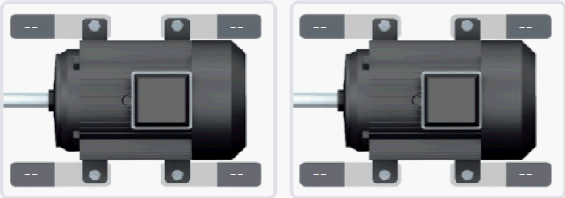

SKF, Kelvinbaan 16, Nieuwegein



Dimensions

Tolerances $\frac{\text{mm}}{200\text{mm}}$ $\frac{\text{mm}}{\text{mm}}$
 0.05 0.10

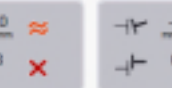

A 210mm **D** 105mm **B** 50mm **C** 80mm

Alignment Results

	As Found	As Corrected
Horizontal: Top View	 $\frac{\text{mm}}{200\text{mm}}$ -0.10 \approx $\frac{\text{mm}}{\text{mm}}$ 0.23 \times	 $\frac{\text{mm}}{200\text{mm}}$ -0.11 \approx $\frac{\text{mm}}{\text{mm}}$ 0.24 \times
Vertical: Side View	 $\frac{\text{mm}}{200\text{mm}}$ -0.06 \checkmark $\frac{\text{mm}}{\text{mm}}$ 0.09 \checkmark	 $\frac{\text{mm}}{200\text{mm}}$ -0.04 \checkmark $\frac{\text{mm}}{\text{mm}}$ 0.12 \approx

Signatures: _____ Backlash within tolerance: Yes
 Date: _____
 SKF, Kelvinbaan 16, Nieuwegein

6. QR codes, machine library, soft foot

6.1 QR code (TKSA 41 only)

Creating a new machine

- Place a QR code sticker on a machine.
- Click on the QR code icon from the home screen.
- Scan the QR code, it will be recognized automatically.
- Answer “Yes” to “New QR code detected, create new machine?”
- Add a machine name or leave the name already filled.
- Optional: Add a machine picture.
- Select “New measurement” to start a new measurement.



All future alignment jobs can be found in the machine library by scanning the QR code again.

Aligning an existing machine

- Click on the QR code icon from the home screen.
- Scan the QR code, it will be recognized automatically.
- The machine page opens in the machine library
- Select “New measurement” to start a new measurement

The machine can also be selected directly from the machine library.

Note:

Additional QR code stickers are available from SKF.

Any QR code version 2 can be recognized by the display unit (Up to 20 characters in the QR code).

6.2 Machine library

The Machine library allows:

- Seeing the alignment jobs performed on a machine including dates.
- Checking whether the machine has been aligned within tolerance.
- Attribute a QR code and a picture to a machine.
- Start a new alignment for a given machine.



Machine library – browsing and gestures

Swiping with one finger and clicking can be used in the machine library. Columns can be sorted by machine name, operator or alignment date.

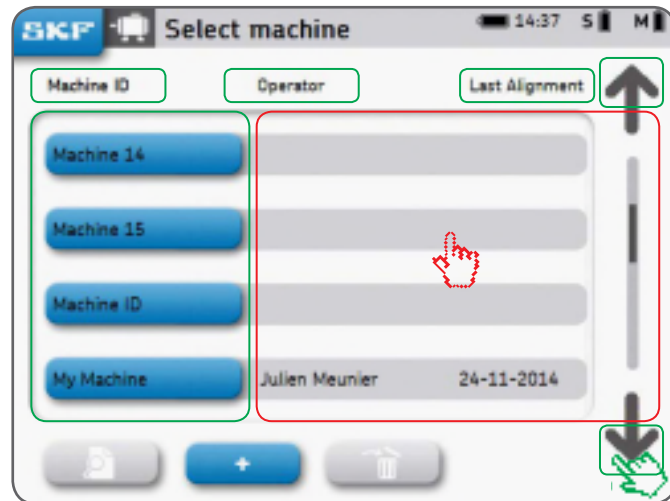

- Green = Clicking area
- Red = Swiping area

6.3 Soft foot 1

Soft foot can be enabled via *Settings* --> *Measurement Settings* --> *Soft Foot Check*.

- Place the MU at 12 o'clock (0°) position.
- Soft foot must be checked on all feet.
- Chose the tolerance by clicking on the tolerance button.

Measuring soft foot:

1. Loosen the bolt of the foot and click OK.
2. Tighten the bolt of the foot and click OK.
3. Repeat for all 4 × feet.

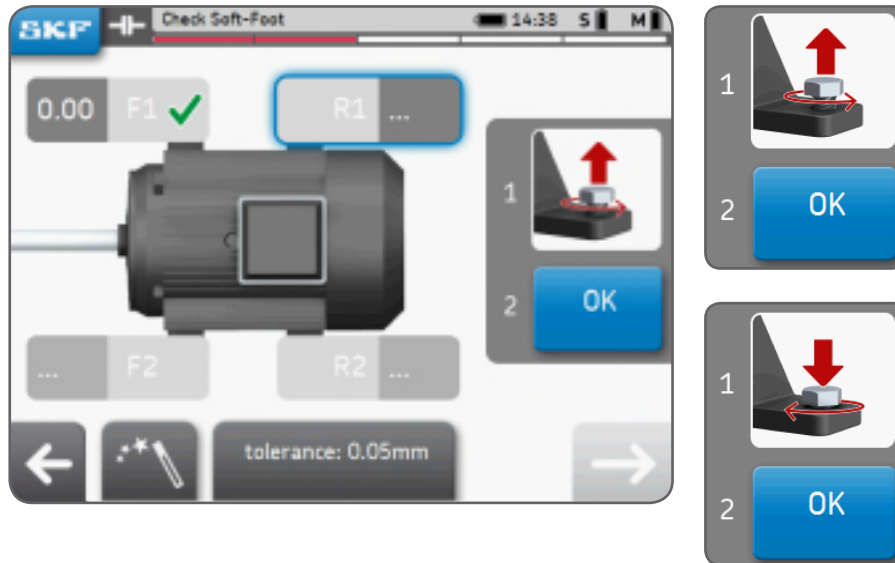

6.4 Soft foot 2

4. Correct the soft foot if any by adding shims.
5. Click on check or click the next button to leave the soft foot function.
6. Remeasure soft foot and click next to leave the function.

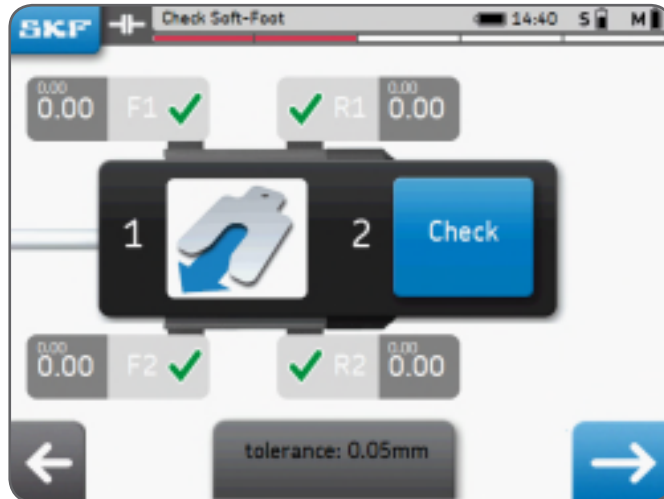

Note:

SKF high precision machinery shims, search for “TMAS” on SKF.com

7. Settings

7.1 Main settings menu



Screen Brightness:

Adjust the screen brightness by clicking the left or right sun icon or by sliding the brightness bar with a swiping gesture.

All default:

All default will reset all settings to their default values including the user preferences.

7.2 User settings

User name, company name and company address will show on the report.

These fields can be left blank.

Company logo will be used for the alignment report.

Loading your company logo:

- The image file must be named “*logo.jpg*” and be less than 256KB in size.
- Load the file on the root of a USB stick.
- When the USB stick is plugged to the display unit, the plus button becomes blue.
- Click “plus” to import the company logo.
- Click ‘minus” to delete the logo.

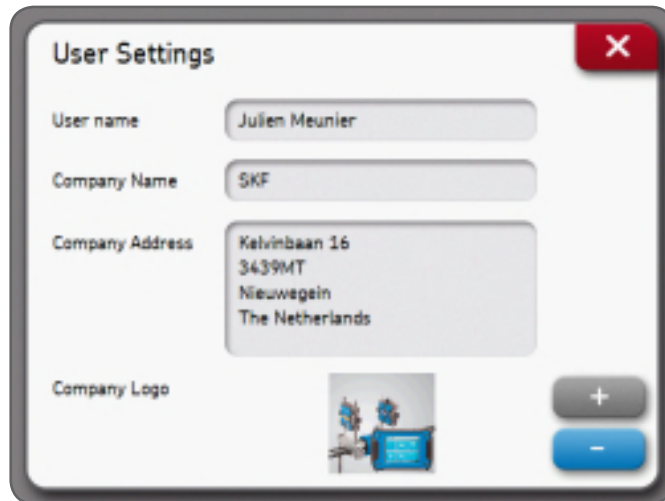

The screenshot shows a 'User Settings' dialog box with a red close button in the top right corner. The settings are as follows:

Field	Value
User name	Julien Meunier
Company Name	SKF
Company Address	Kelvinbaan 16 3439MT Nieuwegein The Netherlands
Company Logo	 +

7.3 Measurements settings

This menu is only **available before** an alignment is started.
The “ask” option means a popup window will give the choice to the user.
“Auto measurement” is available when “Free measurement” is off.

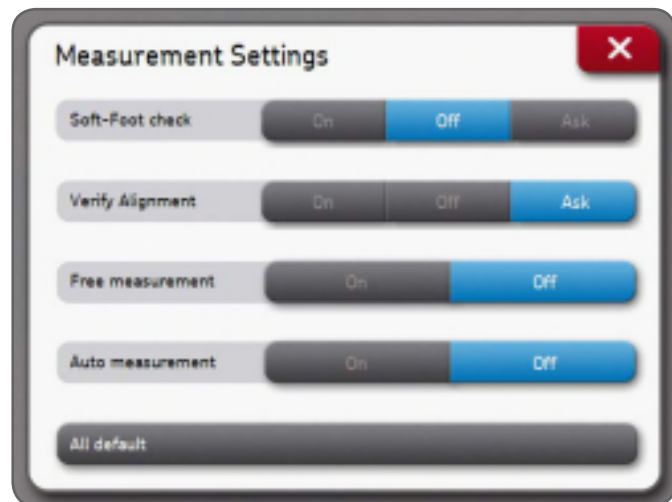

Note:

We recommend always verifying the alignment correction previously made.
See chapter 3 for more details on the measurement options.

7.4 Display unit and measuring unit info

Display unit information menu allows to:

- Find the model, serial number and app version of the display unit.
- Check the battery level of the display unit.
- Update the unit firmware.

Measuring units information menu allows to:

- Find the firmware version, serial number of the S and M measuring units.
- Check the battery level of the S and M measuring units.
- Visualize the live internal temperature, live angles and live detector reading (position) of the S and M measuring units.
- Update the measuring units firmware.
- Find existing or pair new measuring units --> *Find measuring units*.

7.5 Languages

The following languages are available:

English, French, German, Spanish, Italian, Portuguese, Russian and Simplified Chinese.



7.6 Units and date & clock

Units allows the user to choose between imperial (inches) and metric units (meters).

Note:

Units cannot be changed when an alignment job is started.

Date & clock allows setting the date and time. These will be shown on the reports.

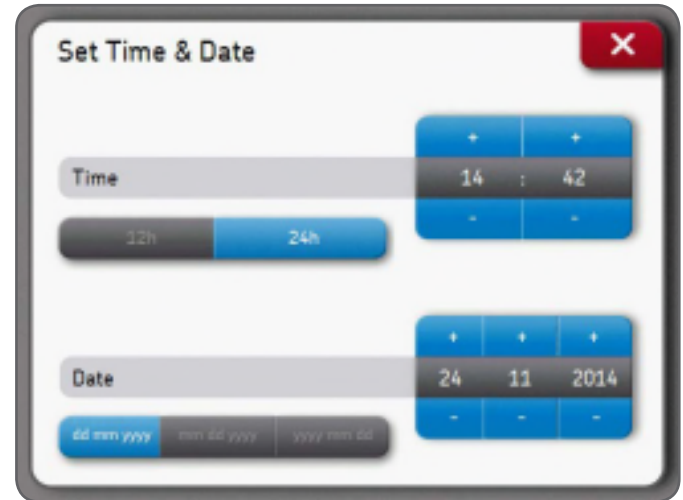
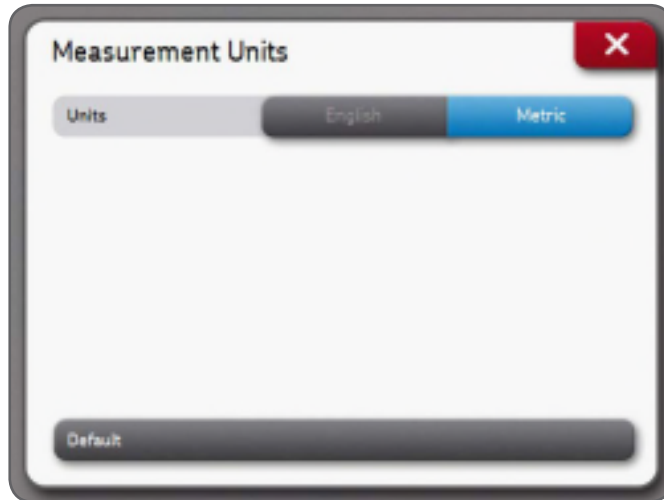

7.7 General settings

Screen beep: Enable this function to hear an audible beep when a button is pressed

Confirm delete: Ask confirmation when a report or machine is being deleted.

S and M readings: S and M measuring units live detector readings are displayed during the measurements when this option is enabled.

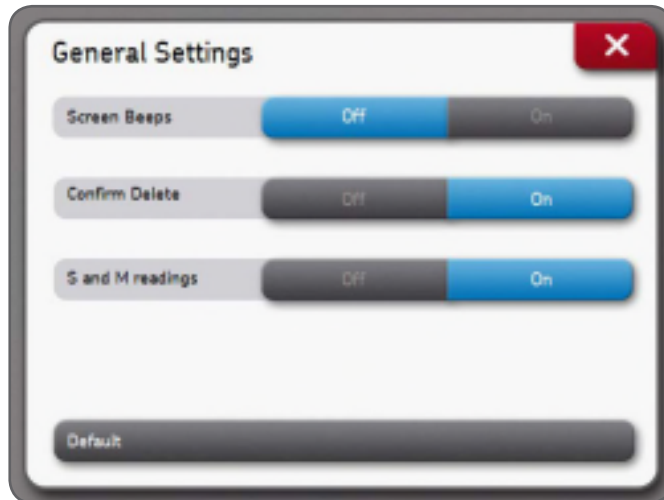

8. Troubleshooting

8.1 Perform a reset

In case the unit becomes unresponsive:

- Keep the display Unit **On/Off** button pressed until the display switches off. (~6 seconds).
- Short press on the On/Off button to start the unit.



Note:

- **No data will be erased while resetting the unit.**
- If an alignment job was in progress, its progress will be lost.
- Measuring Units do not have a reset function.

8.2 Power modes

- The DU will enter deep sleep after 2 hours of inactivity.
- The DU will **never** turn off during an alignment job.
- Measuring units keep charging when the DU is in deep sleep mode.

8.3 Firmware update

The latest version of the firmware can be found on SKF.com

Display unit firmware update

- Load the file “*firmware.pac*” on a USB stick (at the root folder).
- Plug the USB stick to the display unit while DU is switched on.
- Make sure the display unit is plugged to AC power.
- Select *Settings* --> *Display unit info* --> *Firmware update*.
- A message indicates the update is complete.
- Click on the reset popup when finished.

Measuring units firmware update

- Load the file “*heads.hex*” on a USB stick (at the root folder).
- Plug the USB stick to the display unit while DU is switched on.
- Select *Settings* --> *Measuring units info* --> *Import firmware*.
- Remove the USB stick from the display unit.
- Make sure the measuring units are switched off.
- Connect the MU to the display unit with the USB cables supplied.
- Select *Settings* --> *Measuring units info* --> *Firmware update*.
- A message indicates the update is complete.
- Click on the Reset popup when finished.

Note:

Firmware versions can be found in the Display Unit information and measuring units information menu.

8.4 Wireless connection troubleshooting

*My measuring units do not connect automatically to the display unit.
I received a new set of measuring units and I want to connect them to the DU.
I received a new display unit, I want to use it with my current MUs.*

- Check the measuring units batteries are not depleted.
 - If the batteries are empty, charge the MUs.
The instrument can be used while the MU are connected in USB and charging.

OR

- When the MU are switched on, a **blue LED** should be blinking after the original LED which indicates the battery status.

If the blue LED blinks but the MU do not connect to DU:

- *Settings --> Measuring units info --> Find measuring units*
- Wait until **both** S and M MU appear (ex: TKSA41-S-1433-0001)
- Click on both MU to make them appears in grey
- Validate with the "OK" button
- A Bluetooth symbol will appear next to the S and M letters

S  M 

- Both MU will now connect to the DU and data will be populated in the MU info menu.

9. Technical specifications

Technical data		
Designation	TKSA 31	TKSA 41
Description	SKF Shaft Alignment Tool TKSA 31	SKF Shaft Alignment Tool TKSA 41
Measuring unit(s) (MU)	TKSA 31	TKSA 41
Sensors type	29 mm (1.1 in.) CCD with line laser Class 2, 635 nm, 1 mW	29 mm (1.1 in.) CCD with line laser Class 2, 635 nm, 1 mW
Electronic Inclinometers	Yes, $\pm 0,5^\circ$	Yes, $\pm 0,5^\circ$
Wireless communication	Wired USB	Bluetooth 4.0 Low Energy & Wired USB
Communication Range	1.5 m (60 in.) USB cables	> 10 m (> 11 yds.)
Housing Material	20% Glass filled Polycarbonate	20% Glass filled Polycarbonate
Colours	SKF product Blue/Grey/Red	SKF product Blue/Grey/Red
Dimensions (H x W x D)	120 x 90 x 36 mm (4.7 x 3.5 x 1.4 in.)	120 x 90 x 36 mm (4.7 x 3.5 x 1.4 in.)
Weight	180 g (0.4 lb)	220 g (0.5 lb)
Measuring distance MU	0,07 m to 4 m (0.23 ft to 13.1 ft)	0,07 m to 4 m (0.23 ft to 13.1 ft)
System Measuring distance	0,07 m to 2 m (0.23 ft to 6.6 ft) (With cables supplied)	0,07 m to 4 m (0.23 ft to 13.1 ft)
Sensors Measuring range	24 mm (0.95 in.)	24 mm (0.95 in.)
Measuring Errors	< 0,5% $\pm 5 \mu\text{m}$	< 0,5% $\pm 5 \mu\text{m}$

Display Unit (DU) / Operating Device	TKSA 31	TKSA 41
Display Type	5.6" colour resistive touchscreen LCD display	5.6" colour resistive touchscreen LCD display
Housing Material	High Impact PC/ABS with overmould	High Impact PC/ABS with overmould
Colours	SKF Product Blue and Grey	SKF Product Blue and Grey
Dimensions	205 × 140 × 60 mm (8.1 × 5.5 × 2.4 in.)	205 × 140 × 60 mm (8.1 × 5.5 × 2.4 in.)
Weight	420 g (0.9 lb)	640 g (1.4 lb)
Operating device	Supplied	Supplied
Software/App update	via USB stick	via USB stick

Shaft brackets	TKSA 31	TKSA 41
Fixture	2 × V-brackets with chains	2 × V-brackets with chains
Material	Brushed aluminum with steel pin	Brushed aluminum with steel pin
Chains length	400 mm (15.8 in.) supplied (optional 500 mm (19.7 in.) extension chains)	400 mm (15.8 in.) supplied (optional 500 mm (19.7 in.) extension chains)
Rods supplied	2 × 150 mm (5.9 in.) threaded rods per bracket	2 × 150 mm (5.9 in.) threaded rods per bracket & 4 × additional 90 mm (3.5 in.) rods
Shaft diameters	20 to 150 mm diameter (0.8 to 5.9 in.) (300 mm (11.8 in.) with extension chains)	20 to 150 mm diameter (0.8 to 5.9 in.) (300 mm (11.8 in.) with extension chains)

Max. recom. coupling height	105 mm (4.2 in.) with standard rods 195 mm (7.7 in.) with ext. rods (not supplied)	105 mm (4.2 in.) with standard rods 195 mm (7.7 in.) with ext. rods
Brackets V-base width	21 mm (0.8 in.)	21 mm (0.8 in.)

Features	TKSA 31	TKSA 41
Alignment method	3 × measurements 9–12–3 alignment method (Min. 120° angle)	3 × measurements 9–12–3 alignment method free measurement (min. 90° angle)
Automatic measurement	No	Yes
Vertical correction (shiming)	Yes, live values	
Live horizontal correction	Yes	
Soft foot correction	Laser soft foot	
Report	Automatic .pdf report exportable via USB stick	
Digital camera	No	Yes, 3 MP
QR codes reading	No	Yes, for machine recognition up to QR code version 2
Display orientation flip	No	Landscape mode flip

Battery and Power	TKSA 31	TKSA 41
MU Operation time	N/A	16 hours of continuous use 2 000 mAh rechargeable LiPo battery
DU Operating time	8 hours of continuous use (100% backlight) 5 000 mAh rechargeable LiPo battery	8 hours of continuous use (100% backlight) 5 000 mAh rechargeable LiPo battery
Power adapter	Input: 100V–240V 50/60Hz AC power supplier Output: DC 12V 3A with EU, US, UK, AUS adapters	
System charging time	3 hours 2,5 hours of use after 1 hour charge	

Size and Weight	TKSA 31	TKSA 41
Carrying case dimensions	530 × 110 × 360 mm (20.9 × 4.3 × 14.2 in.)	
Total weight (incl. case)	4,75 kg (10.5 lb)	4,75 kg (10.5 lb)

Operating Requirements	TKSA 31	TKSA 41
Operating temperature	0 °C to 45 °C (32 to 113 °F)	
Storage temperature	–20 °C to +70 °C	
Relative humidity	10% to 90% non condensing	
IP rating	IP54	

Case contents	TKSA 31	TKSA 41
Calibration certificate	Supplied with 2 years validity	
Warranty	2 years standard warranty (1 year extra upon registration)	
In the case	2 × TKSA 31 measuring unit	2 × TKSA 41 measuring unit
	1 × TKSA 31 display unit	1 × TKSA 41 display unit
	2 × Shaft brackets with chains	2 × Shaft brackets with chains
	1 × Chain tightening rod	1 × Chain tightening rod
	–	4 × 90 mm extension rods
	1 × Power supply with country adapters	1 × Power supply with country adapters
	2 × Micro USB to USB cables	2 × Micro USB to USB cables
	1 × 5 m (16 ft) metric/imperial measuring tape	1 × 5 m (16 ft) metric/imperial measuring tape
	1 × Printed certificate of calibration and conformance	1 × Printed certificate of calibration and conformance
	1 × Printed quick start guide (English)	1 × Printed quick start guide (English)
	–	1 × Page with 12 QR code stickers
	1 × SKF carrying case	1 × SKF carrying case

The contents of this publication are the copyright of the publisher and may not be reproduced (even extracts) unless prior written permission is granted. Every care has been taken to ensure the accuracy of the information contained in this publication but no liability can be accepted for any loss or damage whether direct, indirect or consequential arising out of the use of the information contained herein.

SKF Maintenance Products

® SKF is a registered trademark of the SKF Group.
© SKF Group 2015/01

www.mapro.skf.com
www.skf.com/mount

MP5430EN

