



PROCON

103A025F+1/3HP

不锈钢高压滑片泵



Standex PROCON®

应用领域

- 反渗透
- 太阳能
- 碳酸饮料
- 冷媒循环
- 啤酒冷却
- 农药系统

规格

流量	l/h	65
功率	kw	0.25
扬程	m	150
重量	kg	1.2+3.6
流体接口		3/8NPT(F)
泵体材质		不锈钢
电压	V	100-120/200-240
电流	A	6.5/3.0
转速	rpm	1450
过载保护		自动

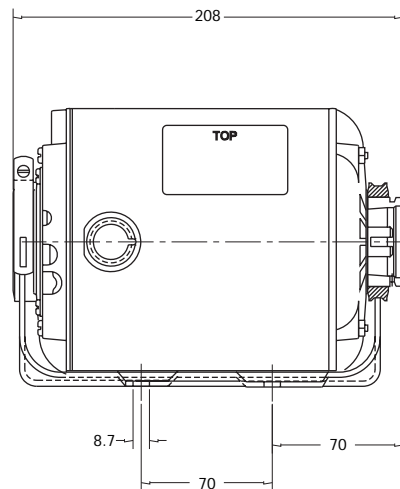
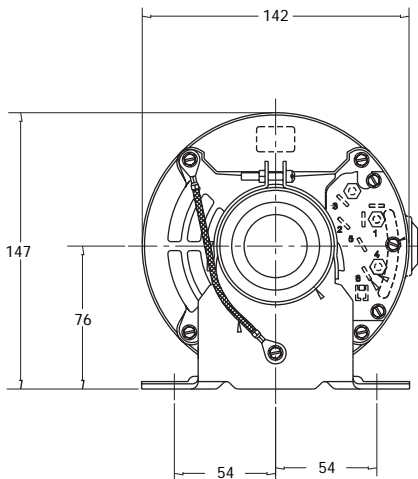
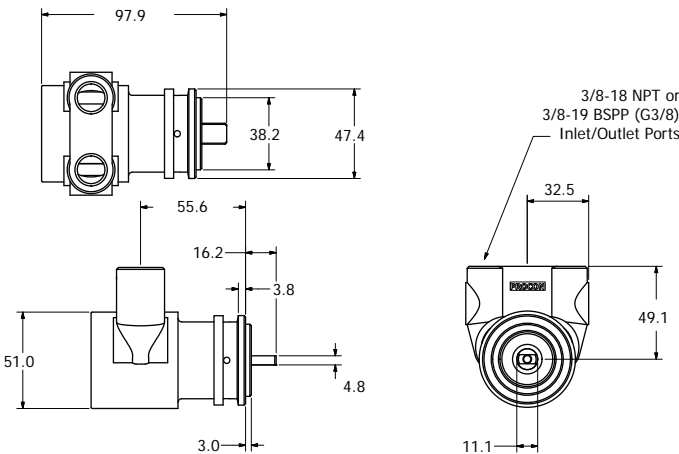



PROCON

103A025F+1/2HP

不锈钢高压滑片泵



Standex PROCON®

应用领域

- 反渗透
- 太阳能
- 碳酸饮料
- 冷媒循环
- 啤酒冷却
- 农药系统

规格

流量	l/h	65
功率	kw	0.38
扬程	m	180
重量	kg	1.2+4.4
流体接口		3/8NPT(F)
泵体材质		不锈钢
电压	V	100-120/200-240
电流	A	7.1/3.4
转速	rpm	1450
过载保护		自动

