



# PROCON

## 102A100F+1/3HP

### 黄铜高压滑片泵



**Standex PROCON®**

#### 应用领域

- 焊接
- 太阳能
- 咖啡机
- 啤酒冷却
- 农药系统

#### 规格

流量	l/h	310
功率	kw	0.25
扬程	m	90
重量	kg	1.2+3.6
流体接口	%NPT(F)	
泵体材质	黄铜	
电压	V	100-120/200-240
电流	A	6.5/3.0
转速	rpm	1450
过载保护	自动	

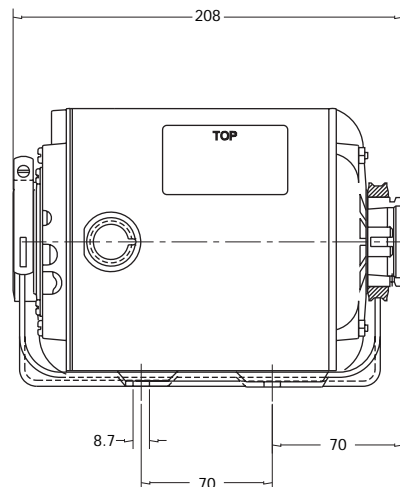
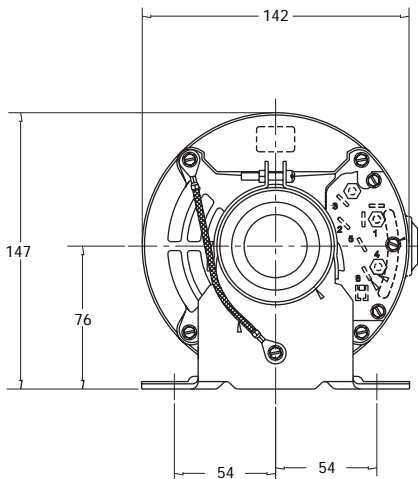
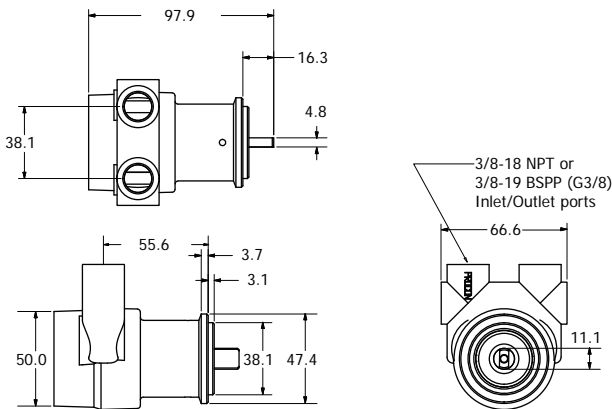



# PROCON

## 102A100F+1/2HP

### 黄铜高压滑片泵



**Standex PROCON®**

#### 应用领域

- 焊接
- 太阳能
- 咖啡机
- 啤酒冷却
- 农药系统

#### 规格

流量	l/h	310
功率	kw	0.38
扬程	m	140
重量	kg	1.2+4.4
流体接口	%NPT(F)	
泵体材质	黄铜	
电压	V	100-120/200-240
电流	A	7.1/3.4
转速	rpm	1450
过载保护	自动	

