



GAST DBMX200 线性压缩机

为什么选择我?

我们是线性压缩机与真空泵,我们用双隔膜振荡以保证可靠的工作,我们是所有系列中最安静的,甚至达到38分贝,因为使用电磁振荡原理,我们的功耗相当低,同样的为了气体的清洁我们为无油设计,同时有最小的脉冲.



优点

- 9.89CFM, 7.4PSI(50Hz)
- 9.53CFM, 7.2PSI(60Hz)
- 大容量,低振动
- 低噪音,48dB
- 含过载保护

应用

循环治疗设备,气垫床,纸张计数器,透析,液体搅拌,医疗雾化,空气测漏,分析设备,喷墨打印,空气采样,焊锡去除,汽车尾气排放测试等.

规格型号

型号	电机参数	转速RPM		功率		重量
		60Hz	50Hz	HP	KW	
大容量 压缩机						
DBMX200-101	120,60-1	1725	----	1/4	0.190	11.9Kg
DBMX200-801	230,50-1	----	1425	1/4	0.186	11.9Kg





产品尺寸(mm,英寸)

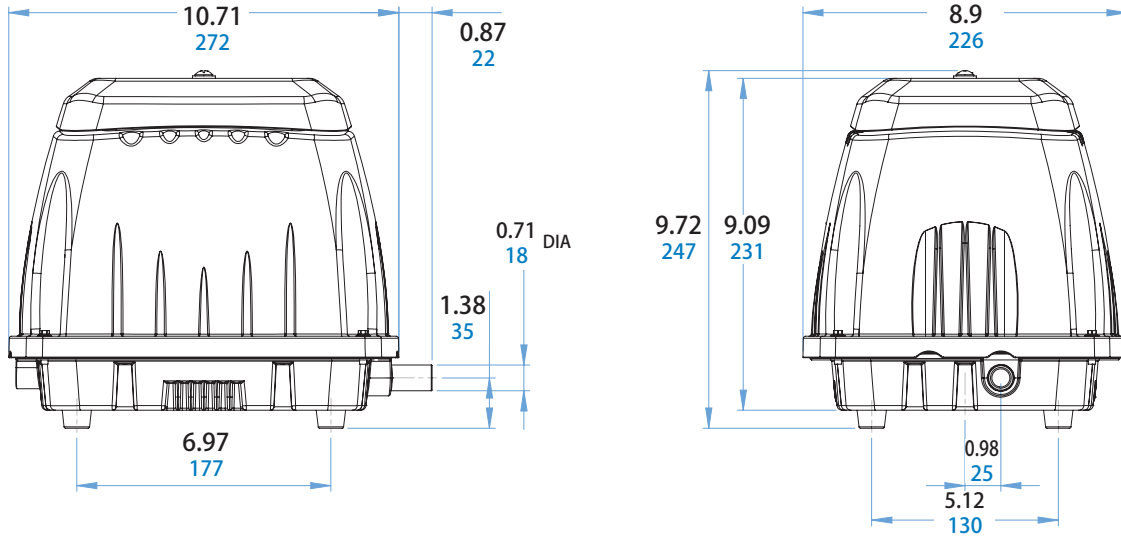

产品性能(公制,英制)

