

MULTI-PURPOSE ZOOM MICROSCOPE
MULTIZOOM
AZ100
AZ100M

Specifications and equipment are subject to change without any notice or obligation on the part of the manufacturer. May 2007 ©2006/2007 NIKON CORPORATION

The products detailed in the brochure are controlled by the Japanese Foreign Exchange and Foreign Trade Law and the International Export Control Regime. If there is a possibility that they may be utilized for the development of weapons of mass destruction, etc., they shall not be exported without authorization from the government.

WARNING TO ENSURE CORRECT USAGE, READ THE CORRESPONDING MANUALS CAREFULLY BEFORE USING THE EQUIPMENT.



NIKON CORPORATION
Parale Mitsui Bldg., 8, Higashida-cho, Kawasaki-ku, Kawasaki,
Kanagawa 210-0005, Japan
phone: +81-44-223-2175 fax: +81-44-223-2182
<http://www.nikon-instruments.jp/eng/>



NIKON INSTRUMENTS INC.

1300 Walt Whitman Road, Melville, N.Y. 11747-3064, U.S.A.
phone: +1-631-547-8500; +1-800-52-NIKON (within the U.S.A. only)
fax: +1-631-547-0306

<http://www.nikoninstruments.com/>

NIKON INSTRUMENTS EUROPE B.V.

P.O. Box 222, 1170 AE Badhoevedorp, The Netherlands
phone: +31-20-44-96-222 fax: +31-20-44-96-298

<http://www.nikon-instruments.com/>

NIKON INSTRUMENTS (SHANGHAI) CO., LTD.

CHINA phone: +86-21-5836-0050 fax: +86-21-5836-0030
(Beijing office) phone: +86-10-5869-2255 fax: +86-10-5869-2277
(Guangzhou office) phone: +86-20-3882-0552 fax: +86-20-3882-0580

NIKON SINGAPORE PTE LTD

SINGAPORE phone: +65-6559-3618 fax: +65-6559-3668

NIKON MALAYSIA SDN. BHD.

MALAYSIA phone: +60-3-78763887 fax: +60-3-78763387

NIKON INSTRUMENTS KOREA CO., LTD.

KOREA phone: +82-2-2186-8410 fax: +82-2-555-4415

NIKON CANADA INC.

CANADA phone: +1-905-625-9910 fax: +1-905-625-0103

NIKON FRANCE S.A.S.

FRANCE phone: +33-1-45-16-45-16 fax: +33-1-45-16-00-33

NIKON GMBH

GERMANY phone: +49-211-9414-0 fax: +49-211-9414-322

NIKON INSTRUMENTS S.p.A.

ITALY phone: +39-55-3009601 fax: +39-55-300993

NIKON AG

SWITZERLAND phone: +41-43-277-2860 fax: +41-43-277-2861

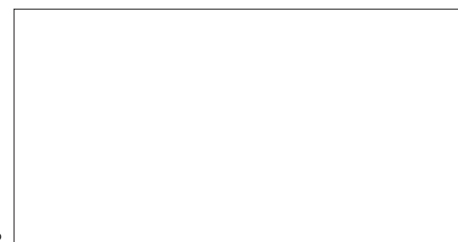

En

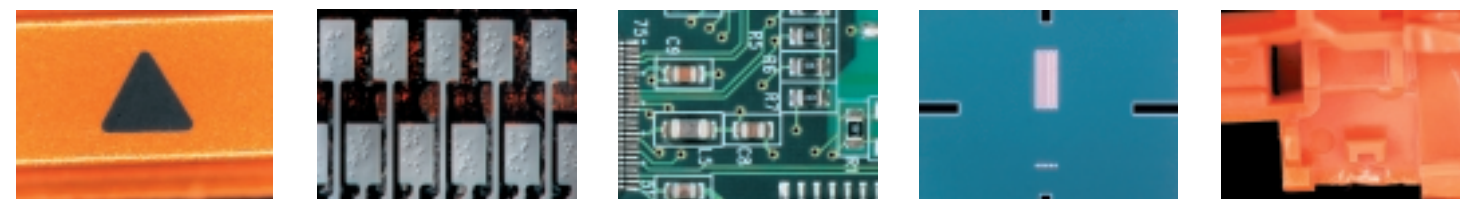

MULTI-PURPOSE ZOOM MICROSCOPE
MULTIZOOM
AZ100
AZ100M

Single integrated microscope system for all your macro observation and digital imaging requirements

The MULTIZOOM AZ100 multi-purpose zoom microscope combines the advantages of a stereoscopic microscope, which has a wide field of view and a long working distance, with the advantages of a metallographic microscope, which features high resolution brightfield and DIC observation and seamless digital documentation.

- On-Axis coaxial optical zoom system that enables macro image capture.
- Wide-range of observation magnifications from 5x to 500x.*
- High-resolution/high-contrast observation in both the macro & micro regions.
- Support for a wide array of observation methods, including reflected/transmitted light brightfield, simple POL and differential interference contrast.
- Automatic detection of objective lens magnification with intelligent triple nosepiece (AZ100M).
- Electronic remote control of motorized optical zoom and vertical stage movement.
- Communication with a PC and the DS-L2 and DS-U2 digital camera control units (AZ100M).

* Includes coaxial illuminator (unit power 1.25x)

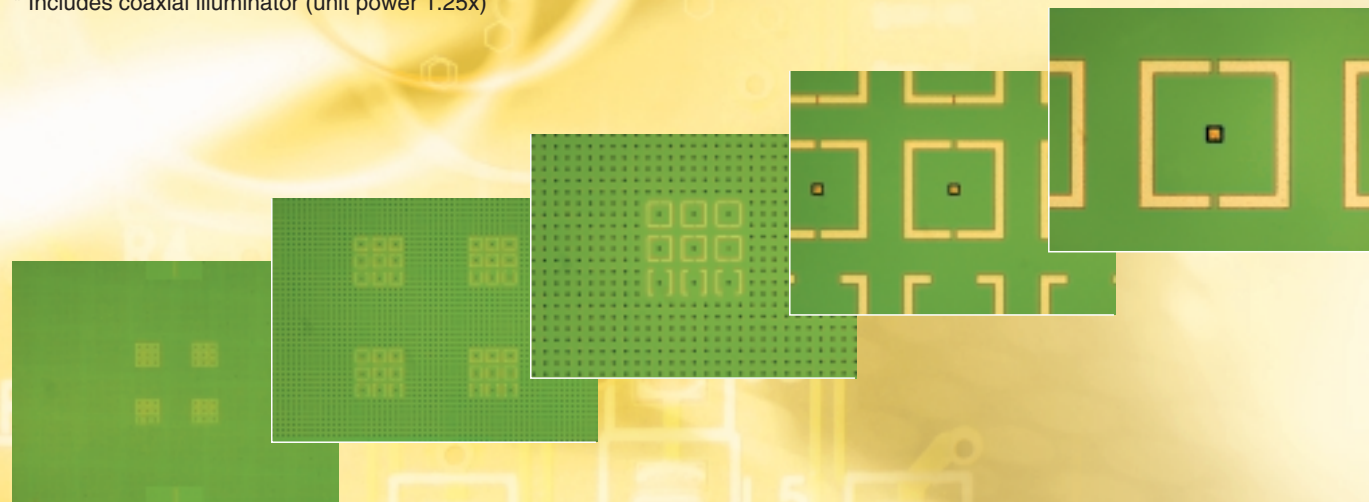

Coaxial illumination configuration

Coaxial illumination configuration + digital camera DS-F11 + controller accessories

ON-AXIS VIEWING

The AZ100 series enables on-axis observation without the lateral distortion inherent in stereo microscopes.

Optimal not only for visual observation, the AZ100/AZ100M is also ideal for capturing macro images with a digital camera or other devices. Telecentric optics, a technology with a strong reputation in the field of industrial measuring microscopes, is employed in this uniquely designed zoom microscope.

Macro observation by on-axis viewing

True on-axis observation and image capture is possible in the macro region by eliminating the traditional stereoscope's angular view of the specimen in the AZ100/AZ100M.

Comparison of macro images

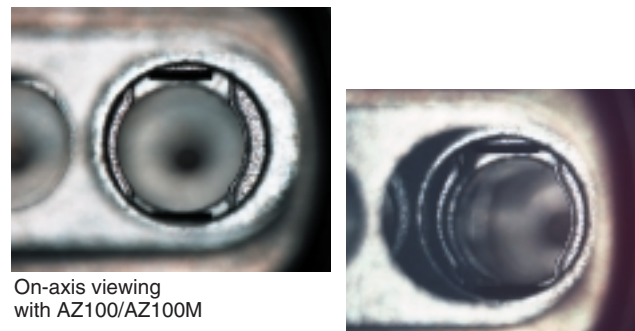

On-axis viewing with AZ100/AZ100M

Angular viewing with a stereoscopic microscope



Mono zoom mechanism

Stereoscopic microscopes always capture images in a diagonal direction due to the design of the microscope. The AZ100/AZ100M, however, captures high-resolution, high-contrast images with on-axis viewing.

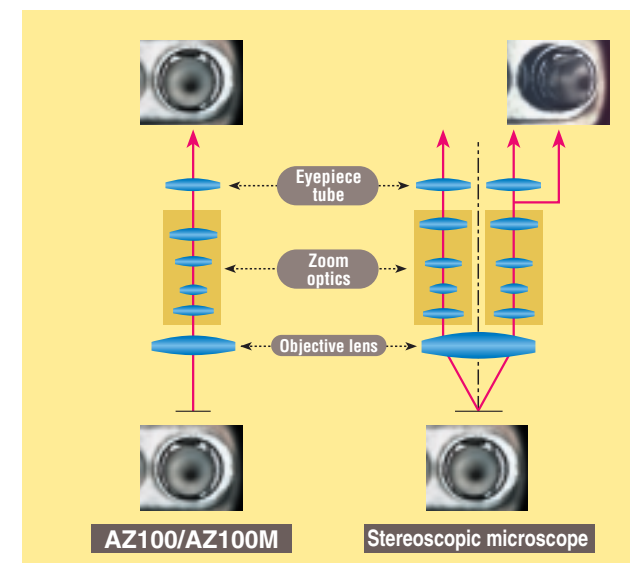

Telecentric optics

The pupil position of the AZ100/AZ100M's zoom optics remains fixed in relationship to the main objective regardless of the zoom setting. This positioning enables a wide array of illumination techniques, including diascope/episcopic Nomarski DIC, and oblique illumination.

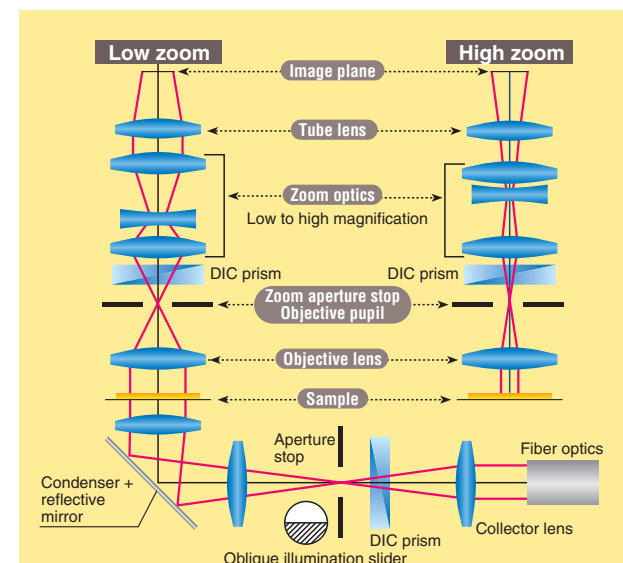

Note: Excludes epi-fluorescence illumination.

HIGH VERSATILITY

The AZ100/AZ100M enables a wide array of observation techniques suited for various samples and applications in the macro region. This system offers Nomarski DIC and fluorescence observation with episcopic illumination, oblique illumination, and simple polarizing observation with diascope illumination. In addition, it also provides for simultaneous mounting of diascope DIC and epi-fluorescence attachments.

Nikon's AZ100/AZ100M brings the power of all these capabilities to a wide range of applications, ranging from quality control and inspection, to research analysis.

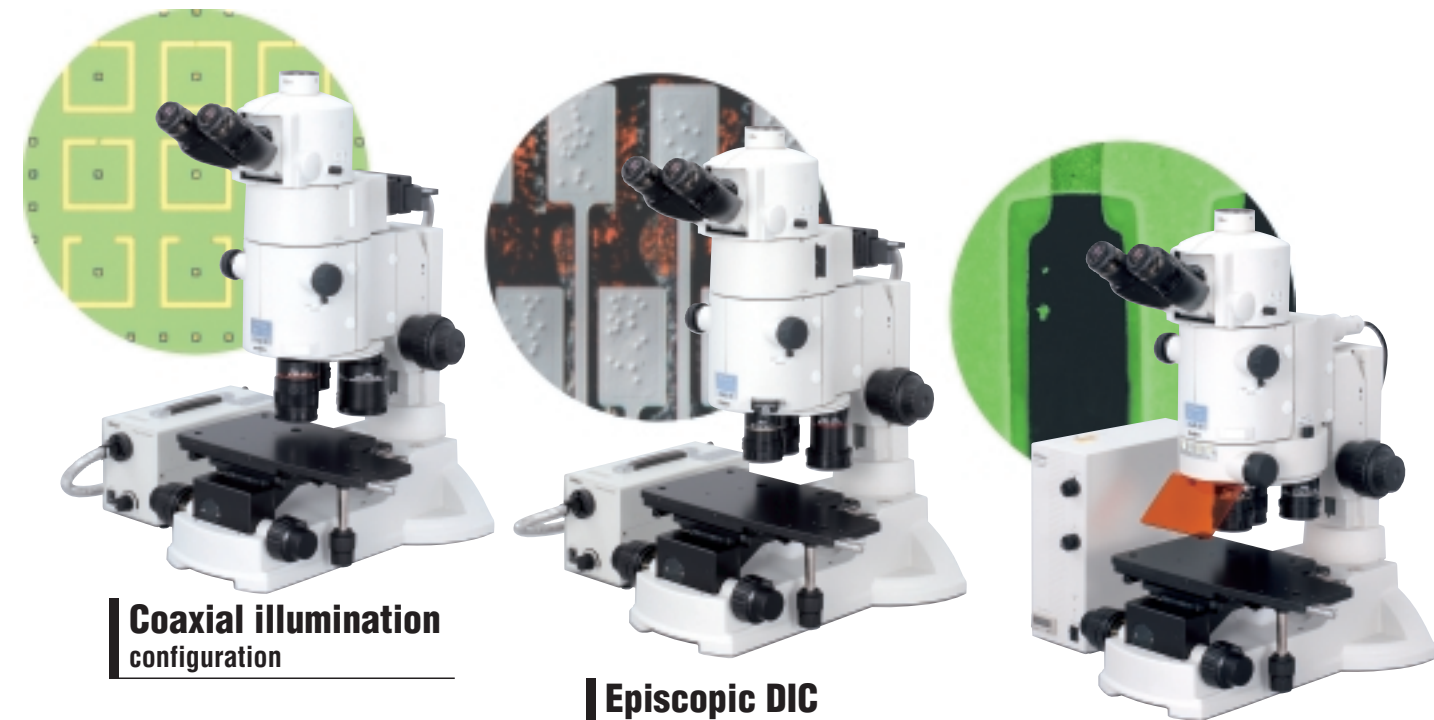

Coaxial illumination configuration

Episcopic DIC configuration

Epi-fluorescence configuration

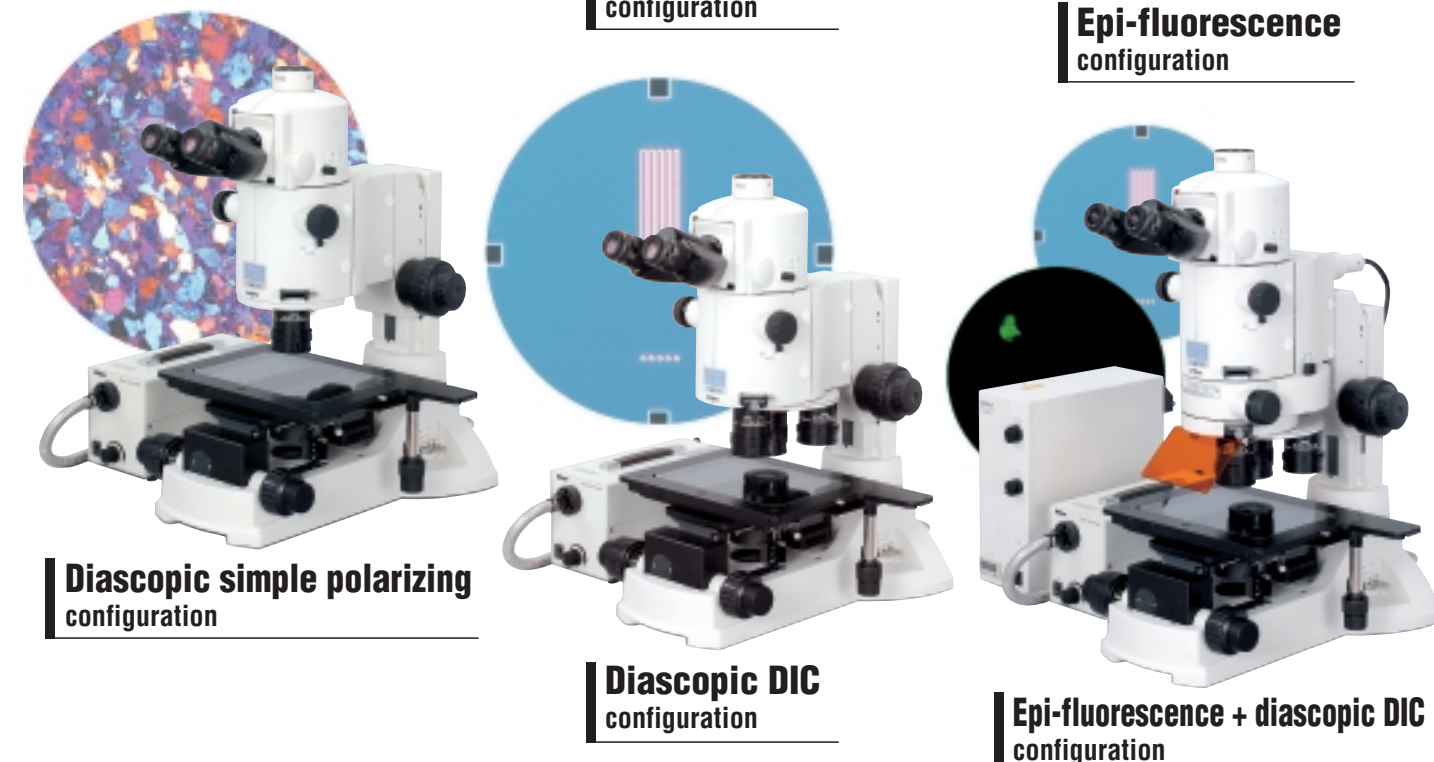

Diascopic simple polarizing configuration

Diascopic DIC configuration

Epi-fluorescence + diascope DIC configuration

FUNCTIONAL DESIGN

A wide range of magnifications

By combining built-in 8x zoom optics, which provides from 1x to 8x magnification, with a three-position objective nosepiece, the AZ100/AZ100M enables observation at the highest magnification ratio of any such device in the world. The objective lens lineup consists of 0.5x, 1x, 2x, 4x, and 5x lenses. When combined with AZ-W 10x eyepiece lenses, the AZ100/AZ100M covers everything from macro to high magnification in the range of 5x to 500x (the latter includes a coaxial illuminator with 1.25x magnification). The zoom knob incorporates an engageable click-stop mechanism, for measuring and reproducible magnification settings (The click-stop mechanism is only available on the AZ100).



Zoom click mechanism on knob



Triple Nosepiece

Comes standard with an aperture stop

The AZ100/AZ100M ships complete with an aperture stop that is effective not only for visual observation, but also for the capture of digital images. This aperture stop allows you to easily control contrast and the depth of field based on your specimen requirements.



Aperture stop

Comparative example



Maximum aperture

Minimum aperture

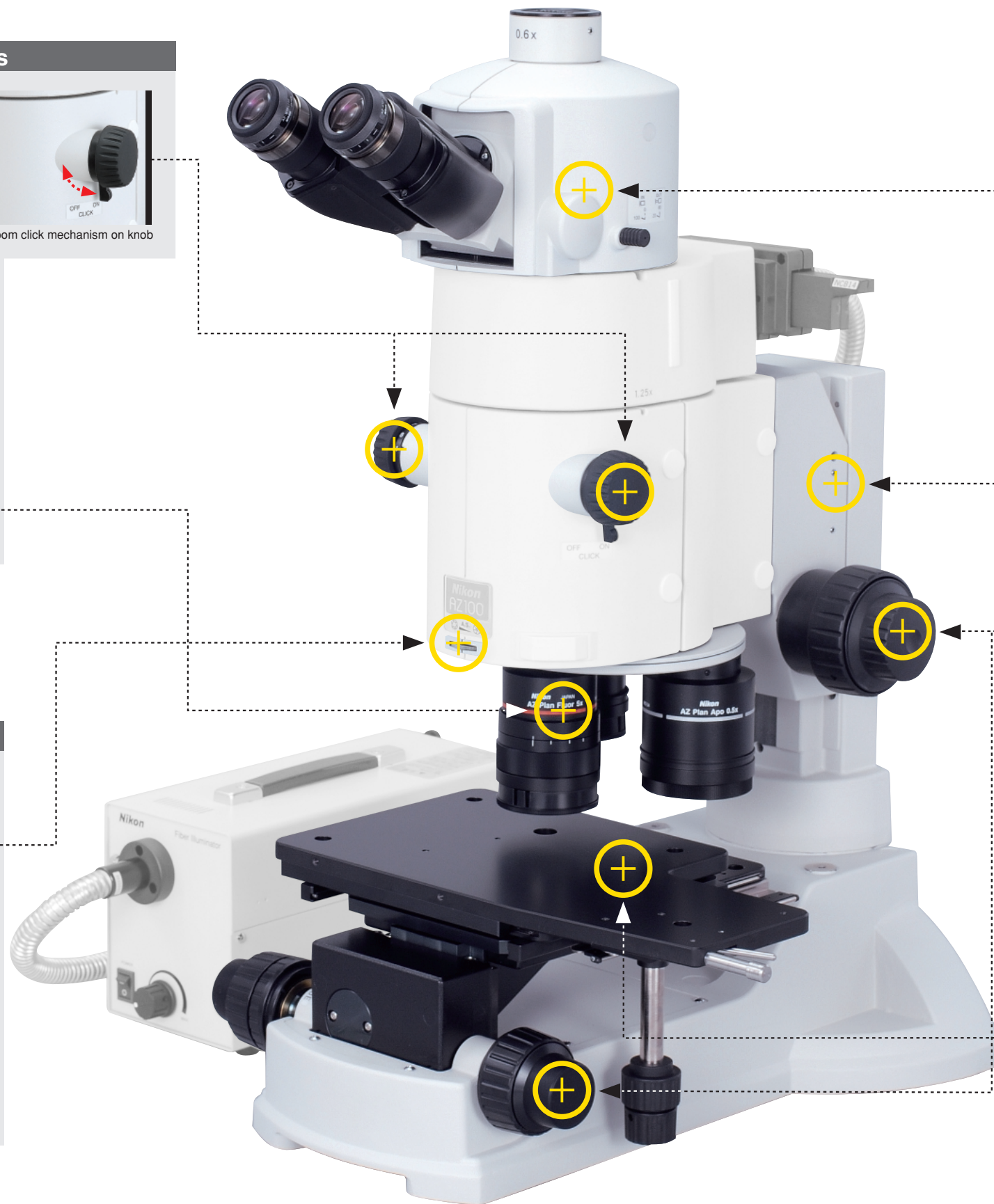

Superior flexibility

Tilting eyepiece tubes



The AZ100/AZ100M comes standard with eyepiece tubes that tilt from 0 to 30 degrees. This feature adjusts for an observer's optimal eye level, regardless of their height or posture, as well as the sample height. Two different beamsplit ratios for the binocular and photo port can be selected, 100:0/0:100, which is suitable for photo documentation, or 100:0/20:80, for simultaneous visual observation and image display on a monitor.

Stands

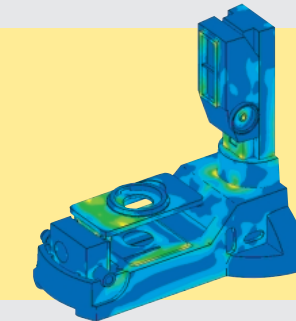

Nikon has developed two new extremely stable dedicated stand types: a reflected-only and a dual-purpose reflected/transmitted illumination stand. Even during observation at high magnifications, these stands enable stable, blur-free observation.

Double-coarse/fine focusing system

Focusing can be done using either the AZ column or stage focus controls. Since the stand column offers an 85mm stroke and the stage focus a 10mm stroke, even tall samples can easily be observed. Focusing the stage can be performed easily with up-front table-level controls, without having to reach above the sample.

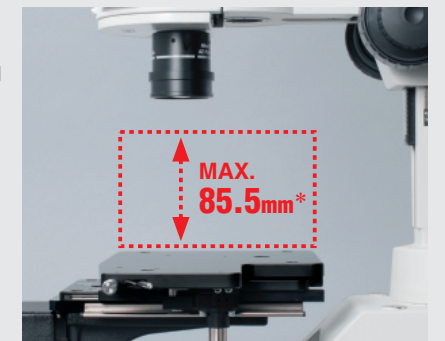

*Differs depending on the objectives and stand combination.

Dedicated stages



The product lineup consists of a reflected-only and a dual-purpose reflected/transmitted illumination stage. The stages' three-plate structure enables stable operation even when observing at high magnification. They provide superior durability even when supporting heavy industrial samples.

AZ100M FUNCTION



Microscope control window (AZ-Pad)

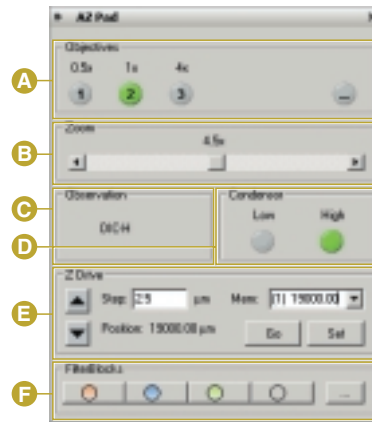

- A Objective lens power
- B Zoom power
- C Observation method
- D Condenser (low/high power)
- E Motorized vertical movement
- F Filter block (When combined with a AZ-FL FL unit)

A variety of control units that can interface with NIS-Elements software



Operation



Control

NIS-Elements imaging software interfaces

NIS-Elements imaging software, combined with these control units, provides an integrated microscope and digital imaging system. Combining motorized Z axis control with the EDF function (optional) of NIS-Elements makes it possible to easily create all-in-focus 3D images by combining a series of images with different focal planes.

Furthermore, communication between the intelligent nosepiece and motorized 8x zoom automatically maintains measurement calibration and scale displays at all magnification settings.

Elements EDF Module (option)

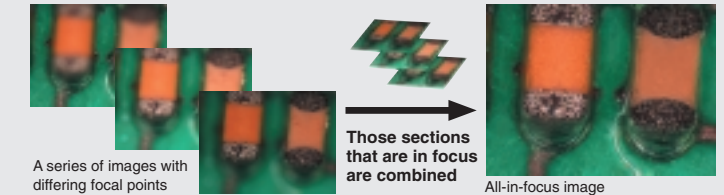

A series of images with differing focal points. Those sections that are in focus are combined. All-in-focus image.

AZ100M



Intelligent nosepiece capable of communicating with a PC

The AZ100M features an intelligent nosepiece (AZ-NPI Intelligent triple nosepiece) that can communicate with a PC. The intelligent nosepiece transmits information on objective magnification to a PC or the DS-L2 and DS-U2 digital camera control units, so that when the user changes the objective lens while measuring a component, the device will automatically switch to the appropriate calibration information. At last, accurate, efficient image capture, measurement, and scale display are all possible.

- Intelligent nosepiece
- Motorized Z axis movement
- Motorized zoom

Control units for remote control of AZ100M

Variable power zoom and motorized Z focusing can be user controlled via the AZ-MC Controller.

- 1 The AZ-HRC Hand Remote Controller puts variable power zoom and focusing at the user's fingertips.
- 2 The AZ-FSW Foot Switch enables variable power zoom and focusing via a foot control, which is especially handy when both hands are busy positioning a part under the microscope.
- 3 The AZ-PCR Photo Release enables image capture via foot control.

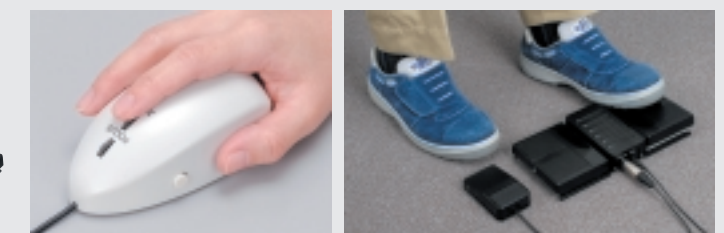
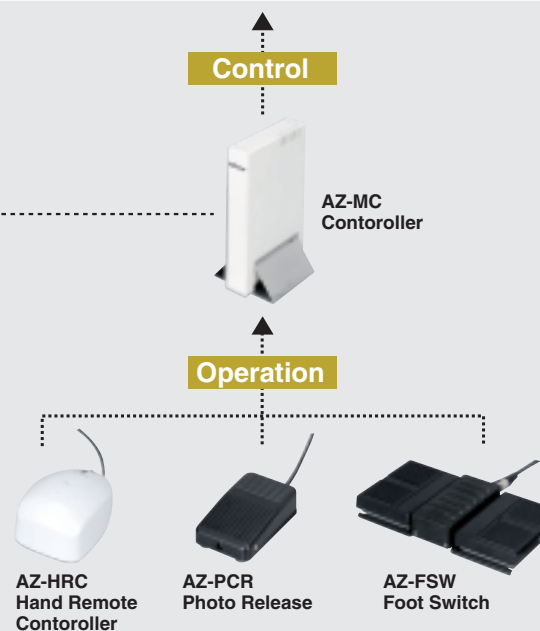

Operation via Hand Remote Controller. Operation via Foot Switch/Photo Release.

DOCUMENTATION SYSTEMS



Digital Camera System for Microscopy DIGITAL SIGHT SERIES

A flexible system that enables various configurations consisting of a camera head and a control unit to suit the needs of each sample or application.





Camera Heads



High-definition color camera head
DS-Fi1  
5-megapixel high-definition color. The DS-Fi1 offers advanced performance, including a high dynamic range and superior red sensitivity, and is optimal for brightfield, darkfield, phase contrast, and DIC image capture.



High-speed color camera head
DS-2Mv  
The DS-2Mv features a 2-megapixel color CCD with a high frame rate. This camera head enables the smooth display of live images and high quality still images.

*See the Digital Sight series catalog for more information.

Stand-alone Control Unit

DS-L2

The DS-L2 features a large high-definition LCD and a host of features. There is no need for a PC and monitor, which allows the system to be used with a flick of a switch.



Large, high-definition monitor

The unit has a built-in 8.4-inch TFT LCD monitor with 1,024 x 786 pixels.

On-screen display (OSD) for easy control

The unit employs an OSD for camera control, state confirmation, and various settings, which allows use of mouse and keyboard to manipulate buttons and menus displayed on the monitor.

Handy save/print features

The unit enables data to be saved on USB memory sticks, as well as on CF cards and microdrives, transferred through a network path. In addition, it comes standard with direct printing to PictBridge printers. It also features "Real 10" modes that make it possible to set and adjust print scaling.

Easy-to-use toolbar

Frequently used features are displayed as toolbar buttons. This enables control without hampering the display of the image to be captured. It is also possible to customize the buttons.



Example of toolbar buttons (Left: Short/Right: Large)

Split-screen display perfect for comparative observation

The unit includes a split-screen feature for the simultaneous display of a saved image and a live image, which is handy for comparative observation.

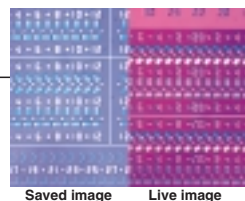

Saved image Live image

Scene mode: optimal image capture with a single button

The unit features three scene modes for industrial samples. These modes all offer capture conditions optimized for the particular sample type. Users can also register up to seven freely configurable custom modes.



An extensive array of tool functions

Users can measure captured images and enter line contrast and other settings using the overlay. Users can also save data in image files and output measurement data.

Measurement and alignment function

Measurement and alignment is possible by standard-length calibration (up to seven types can be registered).

Scale display/alignment functions



Measurement functions



Drawing functions

Users can input and display lines, comments, and other useful elements.

- Straight lines (Arrows can be set.)
- Curves
- Count markers
- Text entry
- Superimposition (semitransparent image overlay for comparative purposes)



Interoperation with microscope (option)

Enables control (including variable power zoom and vertical movement) via the various control units and detection of information on objective lens power via the intelligent revolver.



Microscope control GUI (AZ100M)

PC-based Control Unit

DS-U2

The DS-U2 controls everything from live image display and capture to advanced image processing and analysis on a computer. It supports a wide range of applications.



Simple connection via high-speed USB 2.0

The unit employs a USB 2.0 interface for easy connection with a PC.

Interoperation with microscope (option)

Enables control (including variable power zoom and vertical movement) via the various control units and detection of information on objective lens power via the intelligent revolver.

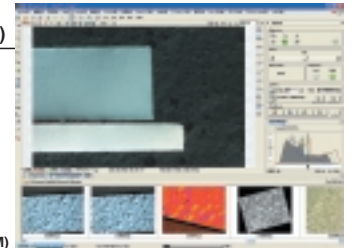

Microscope control GUI (AZ100M)

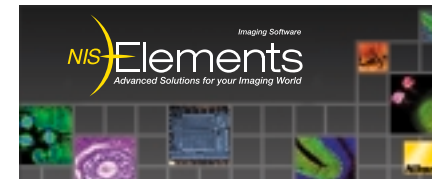

NIS-Elements series of newly developed imaging software

The NIS-Elements series is used for the control software. This software allows the user to perform everything from basic image capture to the measurement, analysis, and management of captured images. Users can add a wide array of the plug-ins to basic packages according to their intended use.

F NIS-Elements F Package

This package enables display of a scale over a live image, switching to full-screen display, and other functions. It allows the user to easily capture images with a simple intuitive control screen.

D NIS-Elements Documentation

This package provides functions for performing measurements and creating reports. Use it for general microimage capture in the industrial field. Expandability is also possible by adding plug-ins, such as EDF and databases.

Br NIS-Elements Basic Research

In addition to the measurement function and report-generating function of NIS-Elements Documentation, this package enables automatic object measurement by creating a binary image. Expandability is also possible by adding plug-ins, such as EDF and databases.

Operating environment

The following PC environment is recommended for maximizing the performance of NIS-Elements.

CPU	3.2GHz Intel® Pentium® IV processor or better
RAM	1GB or more
OS	Microsoft® Windows® XP SP2 (English version)
Hard disk space	600MB or more required for installation
Display	1280 x 1024 dots or better (TrueColor mode)

Application window

(There is no organizer window.)

Freely select the window layout according to the purpose at hand.



Docked controls window

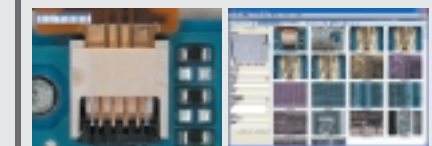

Full-screen window

Organizer window

Report generator

Create reports containing images, database descriptions, and measured data. PDF files can be created directly from NIS-Elements.



EDF (Extended Depth of Focus):

Plug-in

Create an all-in-focus image and a 3D surface image from images that have been captured in a different Z-axis.



Measurement

Measure quantity, length, radius, angle, area, and pixel intensity profile.

IMAGE GALLERY

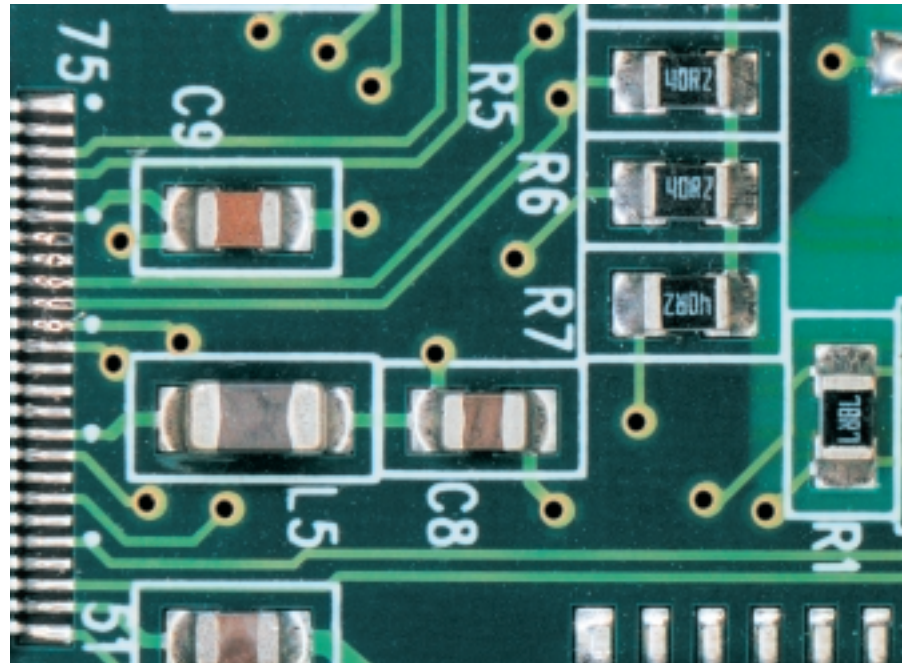

Mounted circuit board (LED illumination)

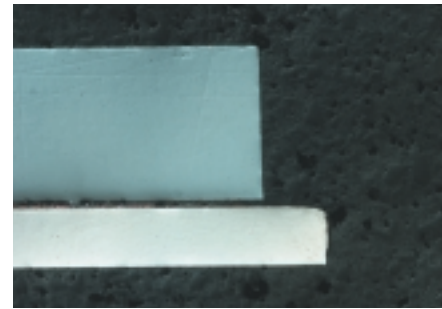

Metal structure (coaxial illumination)

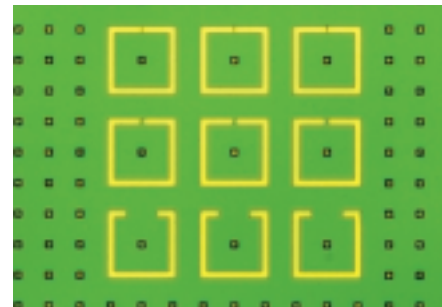

Micro-bumps (coaxial illumination)



IC chip (LED illumination)

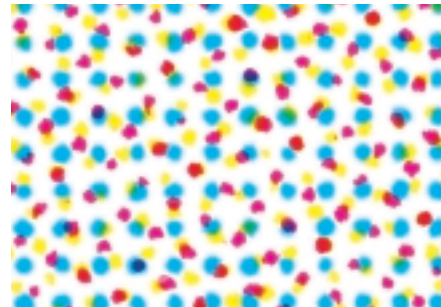

Printed material (LED illumination)

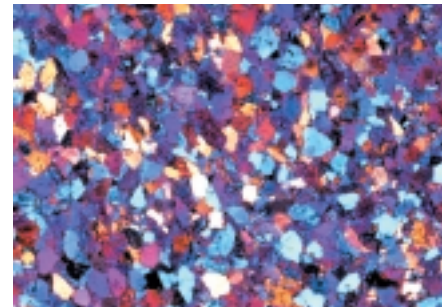

Minerals (diascopic polarizing observation)

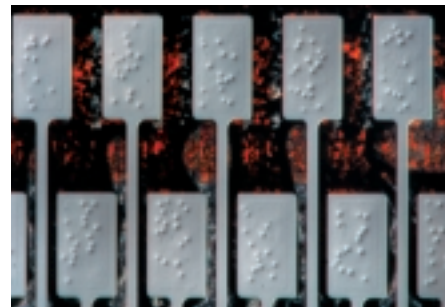

LCD (conductive particles) (episcopic DIC observation)

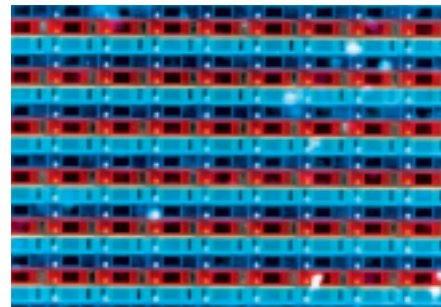

Color filter (LED illumination)

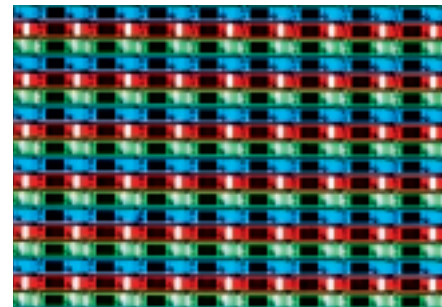

Color filter (coaxial illumination)

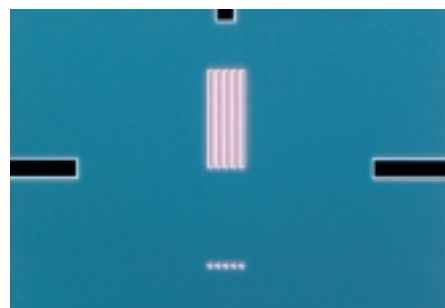

Glass etching pattern (diascopic DIC observation)

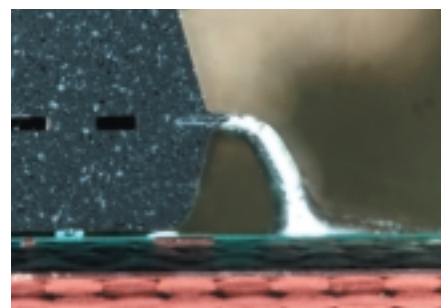

Cross section of an electronic part (LED illumination)

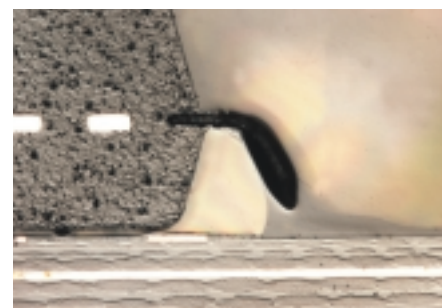

Cross section of an electronic part (coaxial illumination)

ACCESSORIES

Eyepiece tubes EPI DIA

AZ-TE100 Ergonomic Trinocular Tube 100,
AZ-TE80 Ergonomic Trinocular Tube 80, AZ-TP DSC Tube 0.6x

The lineup includes the ergonomic tilting trinocular eyepiece tube AZ-TE100 (beamsplit ratio 100:0/0:100) and AZ-TE80 (beamsplit ratio 100:0/20:80), as well as the vertical monocular tube (AZ-TP 0.6x), which is ideal for system integration. The 0.6x reduction optics built into the eyepiece tubes and photo port enable capturing of images with a wider field of view.

*Accepts ISO type C-mount Direct CCTV Adapters.



Objective lens mounts EPI DIA

AZ-NPI Triple Nosepiece I, AZ-NP3 Triple Nosepiece, AZ-NPS Single Nosepiece

Users can select either the AZ-NP3 3 nosepiece, a three-position nosepiece that delivers a magnification ratio that is among the highest in the world, the AZ-NPS Single position, a simple and compact single objective holder, or the AZ-NPI intelligent 3-Hole nosepiece (AZ100M only), a nosepiece capable of transmitting objective information whichever best suits their requirements.

*Simultaneous mounting of epi-fluorescence and diascopic DIC attachments requires the AZ-FLDIC FL-DIC Prism Holder.



Focus mount adapters EPI DIA

AZ-FM AZ Focusing Mount Adapter, AZ-SMZ SMZ Focusing Mount Adapter,
AZ-LV LV Focusing Mount Adapter

There are three types of focus mount adapters to suit various needs: AZ-FM AZ Focusing Mount Adapter for AZ-dedicated stands, AZ-SMZ SMZ Focusing Mount Adapter* for stereoscopic microscope stands, and AZ-LV LV Focusing Mount Adapter.

*When using a 4x or 5x objective lens, Nikon recommends combining the AZ-FM AZ Focusing Mount Adapter with the AZ-STE Episcopic Stand and AZ-STD Diascopic Stand.



Objective lenses EPI DIA

AZ-Plan Apo 0.5x, AZ-Plan Apo 1x, AZ-Plan Fluor 2x, AZ-Plan Apo 4x, AZ-Plan Fluor 5x

Nikon has developed new dedicated objective lenses with a high NA and low distortion. There are five lens types, each of which are capable of multiple illumination techniques.

List of objectives specs

	Plan Apo 0.5x	Plan Apo 1x	Plan Fluor 2x	Plan Apo 4x	Plan Fluor 5x (include correction ring)
	Parfocal				
NA	0.05	0.1	0.2	0.4	0.5
WD	54mm	35mm	45mm	20mm	15mm
Coaxial illumination	○ (with lambda plate)	○ (with lambda plate)	—	○ (with lambda plate)	○ (with lambda plate)
Diascopic illumination	○	○	○	○	○
DIC	—	○ EPI/DIA	—	○ EPI/DIA	○ EPI/DIA
Epi-fluorescence	○	○	○ (UV excitation possible)	○	○ (UV excitation possible)
LED illumination	○	○	—	—	—



ACCESSORIES



EPI stand/EPI stage EPI

AZ-STE Episcopic Stand, AZ-STGE EPI Stage



DIA stand/DIA stage DIA

AZ-STD Diascopic Stand, AZ-STDM Motorized Focusing Diascopic Stand, AZ-STGD DIA Stage, AZ-SG Stage Glass

* The AZ-STDM Motorized Focusing Diascopic Stand is for the AZ100M only.



Controller accessories (AZ100M only) EPI DIA

AZ-MC Controller, AZ-HRC Hand Remote Controller, AZ-FSW Foot Switch, AZ-PCR Photo Release



Coaxial illuminator EPI

AZ-ICI Coaxial Episcopic Illuminator, AZ-NCB NCB Filter for Coaxial Epi Illuminator, AZ-QLL ICI 1/4 Lambda Plate 0.5x, AZ-QLM ICI 1/4 Lambda Plate 1x, AZ-QLH ICI 1/4 Lambda Plate 4-5x, C-FI115/230 Fiber Illuminator, YM-ND25 ND4/ND16

*See "Objective lenses" on page 11 regarding compatible objective lenses.



LED illuminator EPI

AZ-LED LED Ring Illuminator

*See "Objective lenses" on page 11 regarding compatible objective lenses.



Diascopic simple polarizing attachments DIA

AZ-RP Rotatable Polarizer, AZ-AN DIA DIC Prism Holder with Analyzer, AZ-DL DIA DIC Lambda Plate



Diascopic DIC attachments DIA

AZ-RP Rotatable Polarizer, AZ-AN DIA DIC Prism Holder with Analyzer, AZ-DL DIA DIC Lambda Plate, AZ-DP1 DIA DIC Prism 1x, AZ-DP4 DIA DIC Prism 4x, AZ-DP5 DIA DIC Prism 5x, AZ-DPS1 DIA DIC Prism Slider 1-4x, AZ-DPS5 DIA DIC Prism Slider 5x

*See "Objective lenses" on page 11 regarding compatible objective lenses.

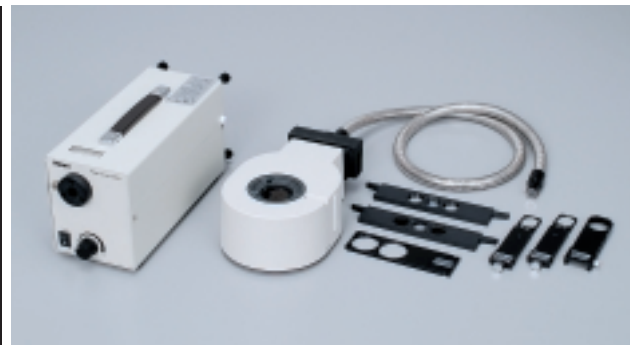

Episcopic DIC attachments EPI

AZ-ICI Coaxial Episcopic Illuminator, AZ-NCB NCB Filter for Coaxial Epi Illuminator, AZ-EL EPI DIC Lambda Plate, AZ-EPS1 EPI DIC Prism Slider 1-4x, AZ-EPI5 EPI DIC Prism Slider 5x, AZ-PH EPI DIC Prism Holder, C-FI115/230 Fiber Illuminator, YM-ND25 ND4/ND16

*See "Objective lenses" on page 11 regarding compatible objective lenses.

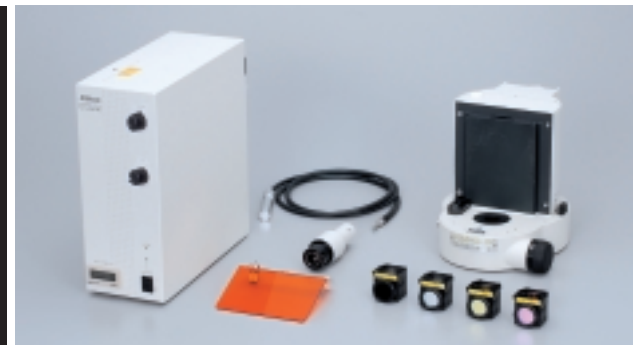

Epi-fluorescence attachments EPI

AZ-FL Epi-Fluorescence Attachment, AZ-HGFA Fiber Adapter, C-HGFIF15/C-HGFIF30 HG Fiber, C-HGFI/HGFIE HG Precentered Fiber Illuminator, Fluorescence Filter Cubes

*In the case of UV excitation, use a Hg lamphouse. See the system diagram for more information.



Epi-fluorescence + diascopic DIC attachments EPI DIA

AZ-FL Epi-Fluorescence Attachment, AZ-HGFA Fiber Adapter, C-HGFIF15/C-HGFIF30 HG Fiber, C-HGFI/HGFIE HG Precentered Fiber Illuminator, Fluorescence Filter Cubes, AZ-RP Rotatable Polarizer, AZ-AN DIA DIC Prism Holder with Analyzer, AZ-DL DIA DIC Lambda Plate, AZ-DP1 DIA DIC Prism 1x, AZ-DP4 DIA DIC Prism 4x, AZ-DP5 DIA DIC Prism 5x, AZ-DPS1 DIA DIC Prism Slider 1-4x, AZ-DPS5 DIA DIC Prism Slider 5x, AZ-FLDIC FL-DIC Prism Holder, AZ-ND128 ND128 Filter for FLDIC

*In the case of UV excitation, use a Hg lamphouse. See the system diagram for more information.

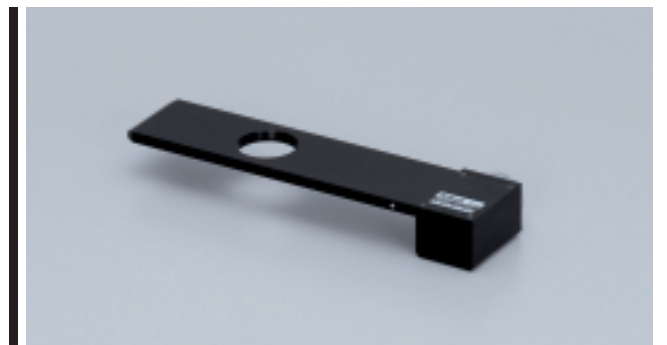

Oblique illumination slider DIA

AZ-OI Oblique Illumination Slider

*The center of the light beam is shielded by the sliding diaphragm placed at a conjugated position with the objective pupil, allowing coherent light to be projected obliquely onto the sample to produce high contrast.

SYSTEM DIAGRAM

AZ100M only

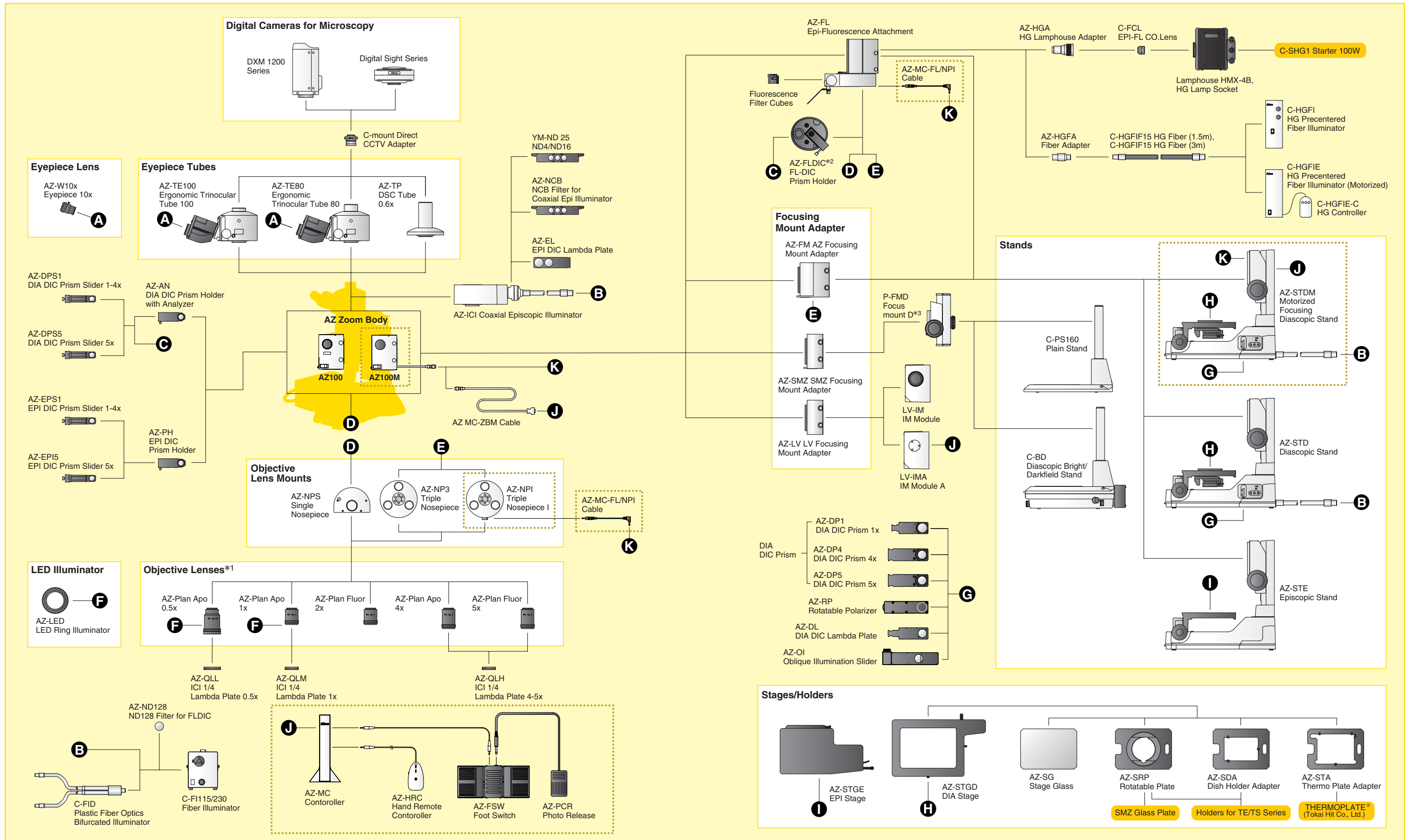

*1 See page 11 regarding combinations with illuminators. *2 Use when simultaneously mounting epi-fluorescence and diascope DIC attachments. *3 Combination with coaxial illuminator is not possible.

SPECIFICATIONS

	AZ100	AZ100M
Total magnification	5x to 400x (6.25x to 500x when coaxial illuminator is mounted) Depends on the combination of eyepiece lenses and objective lenses	
Zoom range	1 to 8 (zoom ratio: 8:1)	1 to 8 (zoom ratio: 8:1, motorized variable power zoom)
Eyepiece tubes	AZ-TE100 Ergonomic Trinocular Tube 100 (beamsplit ratio 100:0/0:100, 0.6x reduction optics built into photo port) AZ-TE80 Ergonomic Trinocular Tube 80 (beamsplit ratio 100:0/20:80, 0.6x reduction optics built into photo port) AZ-TP DSC Tube 0.6x (direct tube type, 0.6x reduction optics built in)	
Inclination angle	0 to 30 degrees (eyepiece tube AZ-TE100/AZ-TE80)	
Interpupillary adjustment range	50 to 75mm (eyepiece tube AZ-TE100/AZ-TE80)	
Eyepiece lens	AZ-W10x eyepiece 10x (FOV: 22mm)	
Focus mount adapters	AZ-FM AZ Focusing Mount Adapter (for AZ stand), AZ-SMZ SMZ Focusing Mount Adapter (for SMZ stand) AZ-LV LV Focusing Mount Adapter (for LV-IMA/LV-IM)	
Stands	AZ-STE Episcopic Stand/AZ-STD Diascopic Stand: (focus mount section: focusing stroke, 85mm; coarse, 18.5mm/rotation; fine, 3.27mm/rotation Stage focus section: focusing stroke, 10mm; coarse, 37.7mm/rotation; fine, 0.27mm/rotation) C-PS160 Plain Stand, C-BD Diascopic Bright/Darkfield Stand	AZ-STD Motorized Focusing Diascopic Stand (Focus mount section: 85mm stroke, motorized vertical movement, Note: Manual operation is not possible while power is on.)
Stages	AZ-STGE EPI Stage (150 x 150mm stroke only with AZ100), AZ-STGD DIA Stage (150 x 100mm stroke)	
Objective lens mounts	AZ-NP3 Triple Nosepiece I, AZ-NPS Single Nosepiece AZ-FLDIC FL-DIC Prism Holder (when simultaneously mounting epi-fluorescence and diascope DIC attachments)	AZ-NPI Triple Nosepiece I, AZ-FLDIC FL-DIC Prism Holder (when simultaneously mounting epi-fluorescence and diascope DIC attachments)
Objective lenses	AZ-Plan Apo 0.5x (NA: 0.05/WD: 54mm), AZ-Plan Apo 1x (NA: 0.1/WD: 35mm) AZ-Plan Fluor 2x (NA: 0.2/WD: 45mm), AZ-Plan Apo 4x (NA: 0.4/WD: 20mm) AZ-Plan Fluor 5x (NA: 0.5/WD: 15mm)	
Illuminators	AZ-ICI Coaxial Episcopic Illuminator (C-FI115/230 Fiber Illuminator: 12V 100W halogen lamp); device magnification: 1.25x AZ-LED LED Ring Illuminator, C-FID Plastic Fiber Optics Bifurcated Illuminator (C-FI115/230 Fiber Illuminator: 12V 100W halogen lamp)	
Light source for epi-fluorescence observation	C-HGFI HG Precentered Fiber Illuminator (130W mercury lamp), C-HGFIE HG Precentered Fiber Illuminator (motorized; 130W mercury lamp), Lamphouse HMX-4B (100W mercury lamp)	
Observation methods	Reflected light: coaxial illumination, Nomarski DIC, fluorescence (up to four filter cubes are mountable), and LED illumination observation Transmitted light: brightfield, Nomarski DIC, simple polarizing, and oblique illumination observation	
Weight	Coaxial illumination configuration (when using AZ-STE Episcopic Stand): approx.26kg epi-fluorescence + diascope DIC configuration (when using AZ-STD Diascopic Stand): approx.28kg	Coaxial illumination configuration: (when using AZ-STD Motorized Focusing Diascopic Stand): approx.29kg, epi-fluorescence + diascope DIC configuration: (when using AZ-STD Motorized Focusing Diascopic Stand): approx.29kg

DIMENSIONS

AZ100 Coaxial illumination configuration

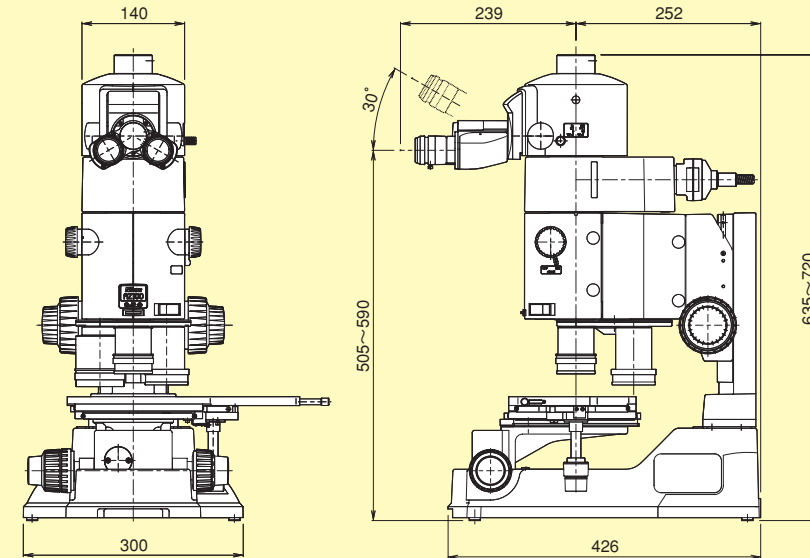

AZ100 System integration configuration

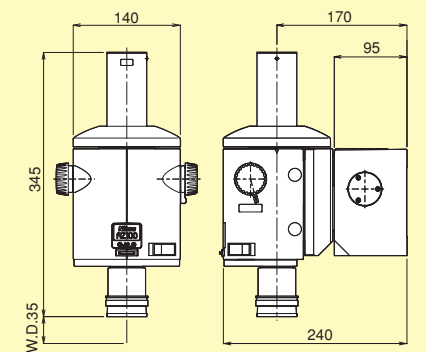

AZ100M Coaxial illumination configuration

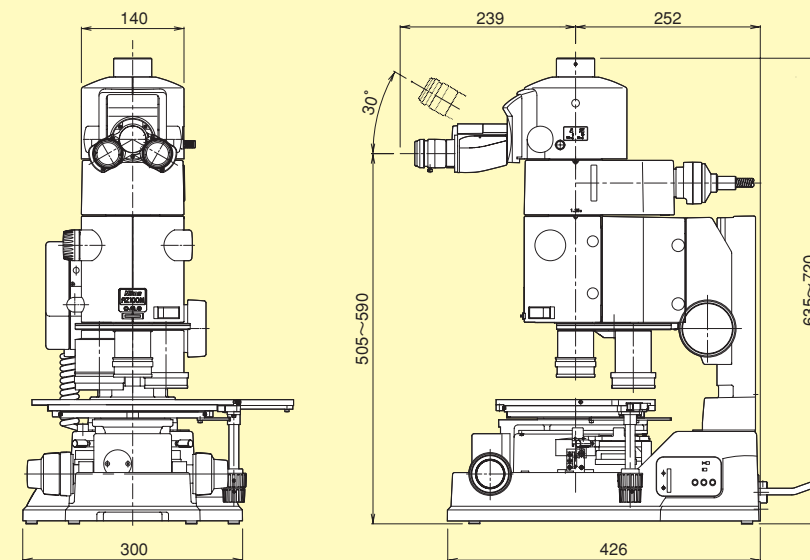

AZ100M System integration configuration

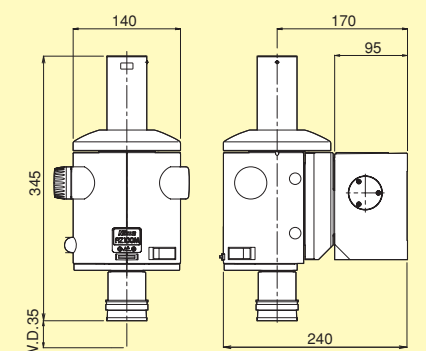

AZ-FSW Foot Switch

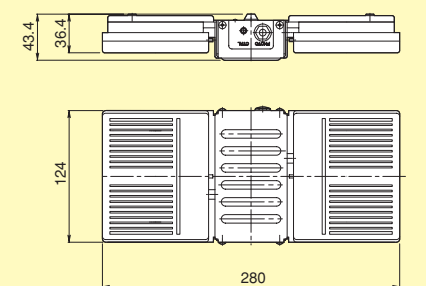

AZ-MC Controller

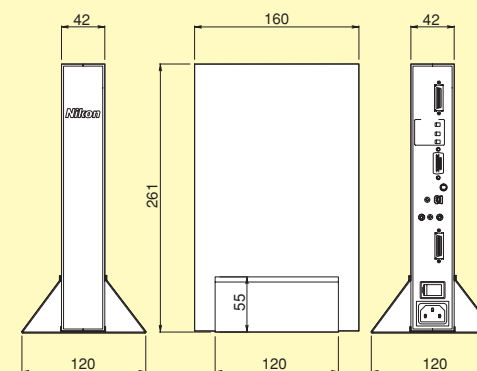

AZ-HRC Hand Remote Controller

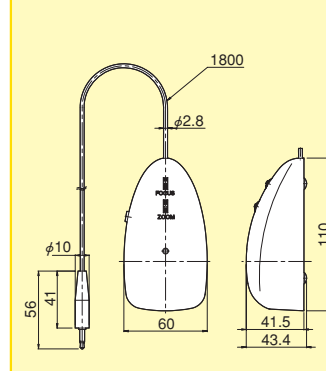

AZ-PCR Photo Release

