



# Standard Test Method for Shear Properties of Composite Materials by the V-Notched Beam Method<sup>1</sup>

This standard is issued under the fixed designation D 5379/D 5379M; the number immediately following the designation indicates the year of original adoption or, in the case of revision, the year of last revision. A number in parentheses indicates the year of last reapproval. A superscript epsilon ( $\epsilon$ ) indicates an editorial change since the last revision or reapproval.

## 1. Scope

1.1 This test method determines the shear properties of composite materials reinforced by high-modulus fibers. The composite materials are limited to continuous-fiber or discontinuous-fiber-reinforced composites in the following material forms:

1.1.1 Laminates composed only of unidirectional fibrous laminae, with the fiber direction oriented either parallel or perpendicular to the loading axis.

1.1.2 Laminates composed only of woven fabric filamentary laminae with the warp direction oriented either parallel or perpendicular to the loading axis.

1.1.3 Laminates composed only of unidirectional fibrous laminae, containing equal numbers of plies oriented at 0 and 90° in a balanced and symmetric stacking sequence, with the 0° direction oriented either parallel or perpendicular to the loading axis.

1.1.4 Short-fiber-reinforced composites with a majority of the fibers being randomly distributed.

NOTE 1—This shear test concept was originally developed without reference to fiber direction for use on isotropic materials such as metals or ceramics.

1.2 *This standard does not purport to address all of the safety concerns, if any, associated with its use. It is the responsibility of the user of this standard to establish appropriate safety and health practices and determine the applicability of regulatory limitations prior to use.*

1.3 The values stated in either SI units or inch-pound units are to be regarded separately as standard. Within the text the inch-pound units are shown in brackets. The values stated in each system are not exact equivalents; therefore, each system must be used independently of the other. Combining values from the two systems may result in nonconformance with the standard.

## 2. Referenced Documents

### 2.1 ASTM Standards:

D 792 Test Methods for Density and Specific Gravity (Rela-

<sup>1</sup> This test method is under the jurisdiction of ASTM Committee D-30 on Composite Materials and is the direct responsibility of Subcommittee D30.04 on Lamina and Laminate Test Methods.

Current edition approved Dec. 10, 1998. Published April 1999. Originally published as D 5379/D 5379M - 93. Last previous edition D 5379/D 5379M - 93.

- tive Density) of Plastics by Displacement<sup>2</sup>  
D 883 Terminology Relating to Plastics<sup>2</sup>  
D 2584 Test Method for Ignition Loss of Cured Reinforced Resins<sup>3</sup>  
D 2734 Test Method for Void Content of Reinforced Plastics<sup>3</sup>  
D 3171 Test Method for Fiber Content of Resin-Matrix Composites by Matrix Digestion<sup>4</sup>  
D 3878 Terminology for Composite Materials<sup>4</sup>  
D 5229/D 5229M Test Method for Moisture Absorption Properties and Equilibrium Conditioning of Polymer Matrix Composite Materials<sup>4</sup>  
E 4 Practices for Force Verification of Testing Machines<sup>5</sup>  
E 6 Terminology Relating to Methods of Mechanical Testing<sup>5</sup>  
E 111 Test Method for Young's Modulus, Tangent Modulus, and Chord Modulus<sup>5</sup>  
E 122 Practice for Choice of Sample Size to Estimate a Measure of Quality for a Lot or Process<sup>6</sup>  
E 177 Practice for Use of the Terms Precision and Bias in ASTM Test Methods<sup>6</sup>  
E 251 Test Methods for Performance Characteristics of Metallic Bonded Resistance Strain Gages<sup>5</sup>  
E 456 Terminology Relating to Quality and Statistics<sup>6</sup>  
E 1237 Guide for Installing Bonded Resistance Strain Gages<sup>5</sup>  
2.2 Other Documents:  
ANSI Y14.5M-1982<sup>7</sup>  
ANSI/ASME B 46.1-1985<sup>7</sup>  
2.3 ASTM Adjuncts:  
V-Notched Beam Shear Fixture Machining Drawings<sup>8</sup>

## 3. Terminology

3.1 Definitions—Terminology D 3878 defines terms relating to high-modulus fibers and their composites. Terminology D 883 defines terms relating to plastics. Terminology E 6

<sup>2</sup> Annual Book of ASTM Standards, Vol 08.01.

<sup>3</sup> Annual Book of ASTM Standards, Vol 08.02.

<sup>4</sup> Annual Book of ASTM Standards, Vol 15.03.

<sup>5</sup> Annual Book of ASTM Standards, Vol 03.01.

<sup>6</sup> Annual Book of ASTM Standards, Vol 14.02.

<sup>7</sup> Available from American National Standards Institute, 11 W. 42nd St., 13th Floor, New York, NY 10036.

<sup>8</sup> Available from ASTM Headquarters, 100 Barr Harbor Dr., PO Box C700, West Conshohocken, PA 19428-2959. Order Adjunct ADJD5379.

defines terms relating to mechanical testing. Terminology E 456 and Practice E 177 define terms relating to statistics. In the event of a conflict between terms, Terminology D 3878 shall have precedence over the other standards.

3.2 Definitions of Terms Specific to This Standard:

NOTE 2—If the term represents a physical quantity, its analytical dimensions are stated immediately following the term (or letter symbol) in fundamental dimension form, using the following ASTM standard symbology for fundamental dimensions, shown within square brackets: [M] for mass, [L] for length, [T] for time, [Θ] for thermodynamic temperature, and [nd] for nondimensional quantities. Use of these symbols is restricted to analytical dimensions when used with square brackets, as the symbols may have other definitions when used without the brackets.

3.2.1 *in-plane shear*,  $n$ —any of the shear properties describing the response resulting from a shear load or deformation applied to the 1-2 material plane. (See also material coordinate system.)

3.2.2 *interlaminar shear*,  $n$ —any of the shear properties describing the response resulting from a shear load or deformation applied to the 1-3 or 2-3 material planes. (See also material coordinate system.)

3.2.3 *material coordinate system*,  $n$ —a Cartesian coordinate system describing the principal material coordinate system, using 1, 2, and 3 for the axes, as shown in Fig. 1.

3.2.4 *nominal value*,  $n$ —a value, existing in name only, assigned to a measurable property for the purpose of convenient designation. Tolerances may be applied to a nominal value to define an acceptable range for the property.

3.2.5 *shear strength*,  $n$ —the shear stress carried by a material at failure under a pure shear condition.

3.2.5.1 *Discussion*—There are no standard test methods that are capable of producing a perfectly pure shear stress condition to failure for every material, although some test methods can come acceptably close for a specific material for a given engineering purpose.

3.3 Symbols:

3.3.1  $A$ —minimum cross-sectional area of a coupon.

3.3.2  $CV$ —coefficient of variation statistic of a sample population for a given property (in percent).

3.3.3  $F^{su}$ —ultimate shear strength in the test direction.

3.3.4  $F^u$ —ultimate strength in the test direction.

3.3.5  $F^o$  (offset)—the value of the shear stress at the intersection of the shear chord modulus of elasticity and the stress strain curve, when the modulus is offset along the shear strain axis from the origin by the reported strain offset value.

3.3.6  $G$ —shear modulus of elasticity in the test direction.

3.3.7  $h$ —coupon thickness.

3.3.8  $n$ —number of coupons per sample population.

3.3.9  $P$ —load carried by test coupon.

3.3.10  $P^f$ —load carried by test coupon at failure.

3.3.11  $P^{max}$ —maximum load carried by test coupon before failure.

3.3.12  $s_{n-1}$ —standard deviation statistic of a sample population for a given property.

3.3.13  $w$ —coupon width.

3.3.14  $x_i$ —test result for an individual coupon from the sample population for a given property.

3.3.15  $\bar{x}$ —mean or average (estimate of mean) of a sample population for a given property.

3.3.16  $\gamma$ —shear strain.

3.3.17  $\epsilon$ —general symbol for strain, whether normal strain or shear strain.

3.3.18  $\epsilon$ —indicated normal strain from strain transducer or extensometer.

3.3.19  $\sigma$ —normal stress.

3.3.20  $\tau$ —shear stress.

3.3.21  $\theta$ —ply orientation angle.

4. Summary of Test Method

4.1 A material coupon in the form of a rectangular flat strip with symmetrical centrally located v-notches, shown schematically in Fig. 2, is loaded in a mechanical testing machine by a

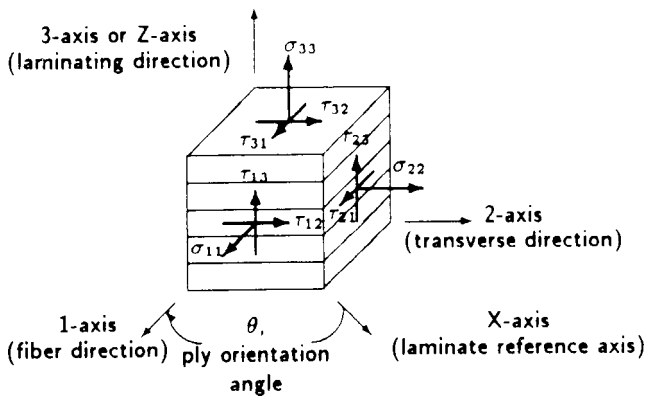
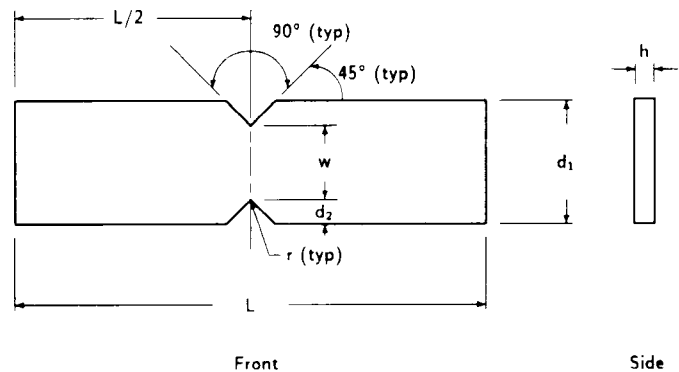

FIG. 1 Material Coordinate System



Nominal Specimen Dimensions

- $d_1$  = 20.0 mm [0.75 in.]
- $d_2$  = 4.0 mm [0.15 in.]
- $h$  = as required
- $L$  = 76.0 mm [3.0 in.]
- $r$  = 1.3 mm [0.05 in.]
- $w$  = 12.0 mm [0.45 in.]

FIG. 2 V-Notched Beam Test Coupon Schematic

special fixture (shown schematically in Fig. 3 and in more detail in the machining drawings of ASTM Adjunct ADJD5379).<sup>9</sup>

4.2 The specimen is inserted into the fixture with the notch located along the line of action of loading by means of an alignment tool that references the fixture. The two halves of the fixture are compressed by a testing machine while monitoring load. The relative displacement between the two fixture halves loads the notched specimen. By placing two strain gage elements, oriented at  $\pm 45^\circ$  to the loading axis, in the middle of the specimen (away from the notches) and along the loading axis, the shear response of the material can be measured.

4.3 The loading can be idealized as asymmetric flexure, as shown by the shear and bending moment diagrams of Fig. 4.<sup>10</sup> The notches influence the shear strain along the loading direction, making the distribution more uniform than would be seen without the notches. While the degree of uniformity is a function of material orthotropy, the best overall results, when testing in the 1-2 plane, have been obtained on [0/90]ns-type laminates.

5. Significance and Use

5.1 This test method is designed to produce shear property data for material specifications, research and development,

<sup>9</sup> The specimen and fixture are based upon work at the University of Wyoming Composite Materials Research Group (1,2), and were subsequently modified by the group (3,4) into the configuration used by this test method. The Wyoming investigations referred to the earlier work of Arcan (5-7) and Iosipescu (8-10), and the later work of a number of other researchers, including Refs (11-16) (early historical perspectives are given in Refs (1,17)). The boldface numbers in parentheses refer to the list of references at the end of this standard.

<sup>10</sup> While the idealization indicates constant shear loading and zero bending moment in the specimen at the notches, the actual load application is distributed and imperfect, which contributes to asymmetry in the shear strain distribution and to a component of normal stress that is particularly deleterious to [90]n specimens (16).

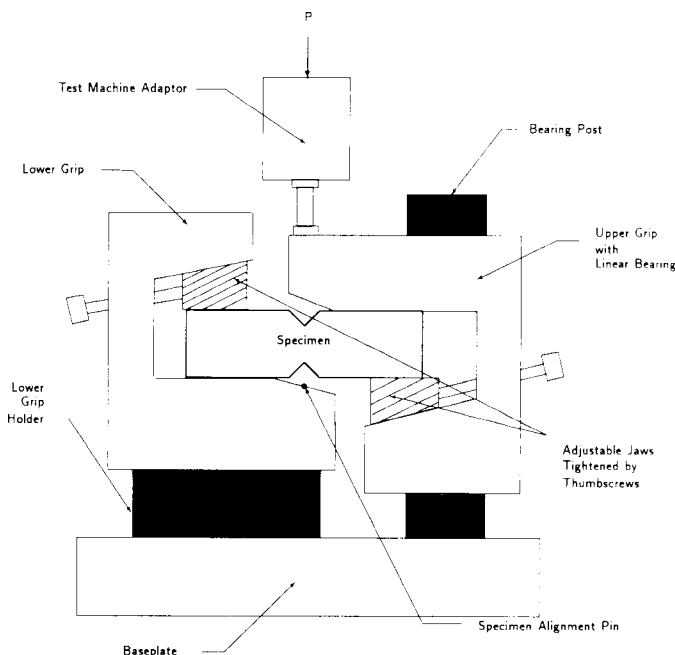
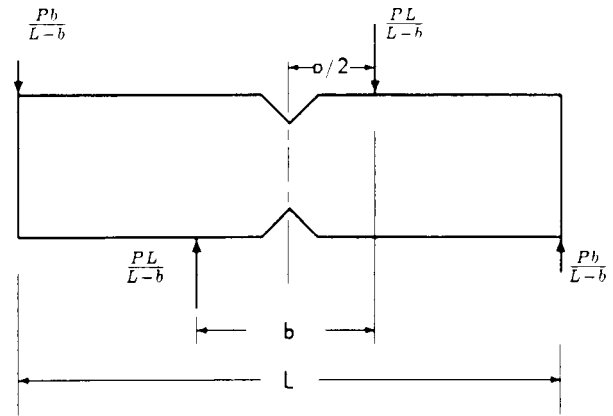
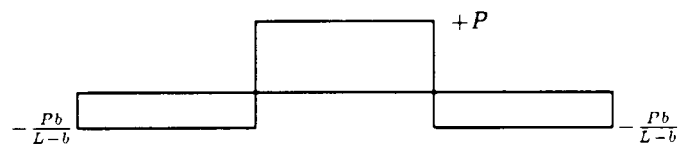

FIG. 3 V-Notched Beam Test Fixture Schematic



Force Diagram



Shear Diagram

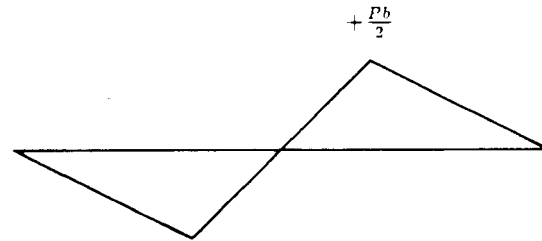

Moment Diagram  $-\frac{Pb}{2}$

NOTE 1—The value of the dimension b is not critical to the concept.

FIG. 4 Idealized Force, Shear, and Moment Diagrams

quality assurance, and structural design and analysis. Either in-plane or interlaminar shear properties may be evaluated, depending upon the orientation of the material coordinate system relative to the loading axis. Factors that influence the shear response and should therefore be reported include the following: material, methods of material preparation and lay-up, specimen stacking sequence, specimen preparation, specimen conditioning, environment of testing, specimen alignment and gripping, speed of testing, time at temperature, void content, and volume percent reinforcement.

5.2 In anisotropic materials, properties may be obtained in any of the six possible shear planes by orienting the testing plane of the specimen with the desired material plane (1-2 or 2-1, 1-3 or 3-1, 2-3 or 3-2). Only a single shear plane may be evaluated for any given specimen. Properties, in the test direction, which may be obtained from this test method, include the following:

- 5.2.1 Shear stress/strain response,
- 5.2.2 Ultimate strength,
- 5.2.3 Ultimate strain,
- 5.2.4 Shear chord modulus of elasticity, and

5.2.5 Transition strain.

6. Interferences

6.1 *Material and Specimen Preparation*—Poor material fabrication practices, lack of control of fiber alignment, and damage induced by improper coupon machining are known causes of high material data scatter in composites.

6.2 *Materials and Coarse Structure*—One of the fundamental assumptions of this test method is that the material must be relatively homogeneous with respect to the size of the test section. Materials that have relatively coarse features with respect to the test section dimensions, such as fabrics using large filament count tows (such as tows of 12 000 filaments or more) or certain braided structures, should not be tested with this specimen size. Scale-up of the specimen and the fixturing to accommodate such materials is possible, but is beyond the scope of this test method.

6.3 *Elastic Modulus Measurement*—The calculations in this test method assume a uniform shear stress state between the notches. The actual degree of uniformity varies with the level of material orthotropy and the direction of loading. Both analysis and full-field experimental strain measurement have shown that when testing in the 1-2 plane, [0]n specimens result in an elastic modulus estimate that is too high (about 10 % too high for carbon/epoxy), while [90]n specimens of the same material result in a value that is about 20 % too low. The most accurate measurements of in-plane shear modulus for unidirectional materials have been shown to result from the [0/90]ns specimen.

6.4 *Load Eccentricity*—Twisting of the specimen during loading can occur, affecting strength results, and especially, elastic modulus measurement. Twisting may occur due to an out-of-tolerance fixture, or from specimens that are too thin (unstable), improperly installed in the fixture, out-of-tolerance because of poor specimen preparation, or of a material configuration with an extremely low tolerance to twist. It is recommended that at least one specimen of each sample be tested with back-to-back rosettes to evaluate the degree of twist. Evaluate the percent twist for the specimen by substituting the shear modulus from each side,  $G_a$  and  $G_b$ , into  $|(G_a - G_b)/(G_a + G_b)| \times 100$ , evaluated at 0.004 absolute strain. If the amount of twist is greater than 3 %, then the specimens should be examined for cause of the twisting, and corrected, if possible. If no cause is apparent or correction possible, and the twisting persists, then the shear modulus measurement should be made using the average response of back-to-back rosettes.

NOTE 3—Twisting as a result of minor tolerance variations can be mitigated by use of a thin compliant interface, such as a plastic-backed adhesive tape, between the fixture and the load-bearing surface of the specimen.

6.5 *Specimen Geometry Modifications*—Detailed stress analysis of the v-notch specimen has shown that adjustments to the notch dimensions (notch angle, depth, and radius) can minimize nonuniformity in the shear-stress distribution as a result of material orthotropy. Recommendations for notch dimensions versus degree of material orthotropy are still being developed. In the interim, and in order to minimize the complexity of this test method, a single standard geometry has been adopted. However, variations to the notch angle, depth,

and radius for the purpose of optimizing the specimen performance for a particular material are acceptable when the variations are clearly noted in the report.

6.6 *Determination of Failure:*

6.6.1 *[0]n Materials*—In [0]n specimens tested in the 1-2 plane, a visible crack typically develops at the notch root, causing a small drop in load before ultimate failure, as shown in Fig. 5. The small load drop accompanying the notch root crack is not considered the failure load; rather the load that accompanies failure in the test section shall be used as the failure load.

6.6.2 *[90]n Materials*—In [90]n specimens tested in the 2-1 plane, the ultimate failure load is clearly defined by the maximum load attained on the load-deflection curve.

6.6.3 *[0/90]ns, SMC, Toughened Materials*—For [0/90]ns, SMC, or toughened materials, the shear failure load may be lower than the maximum load attainable during the test. In such materials, the fibers may reorient following shear failure, subsequently allowing the fibers to carry a major portion of the load. This reorientation is more likely to occur in composites with tough matrix materials that are very nonlinear in shear or in laminates containing off-axis fibers. In such cases, the shear failure load can often be determined by correlating visual observation of failure in the test section with a load drop or by a significant change in the slope of the load-displacement plot, as shown in Fig. 5. Additionally, some toughened materials may deform to such an extent that shear failure does not occur at all; rather the specimen ultimately fails in a mixed-mode failure. Consequently, to avoid the reporting of results that are not representative of shear strength, this test method terminates data reporting at a shear strain of 5 %.

7. Apparatus

7.1 *Micrometers*—A micrometer with a 4- to 5-mm [0.16- to 0.20-in.] nominal diameter double-ball interface shall be

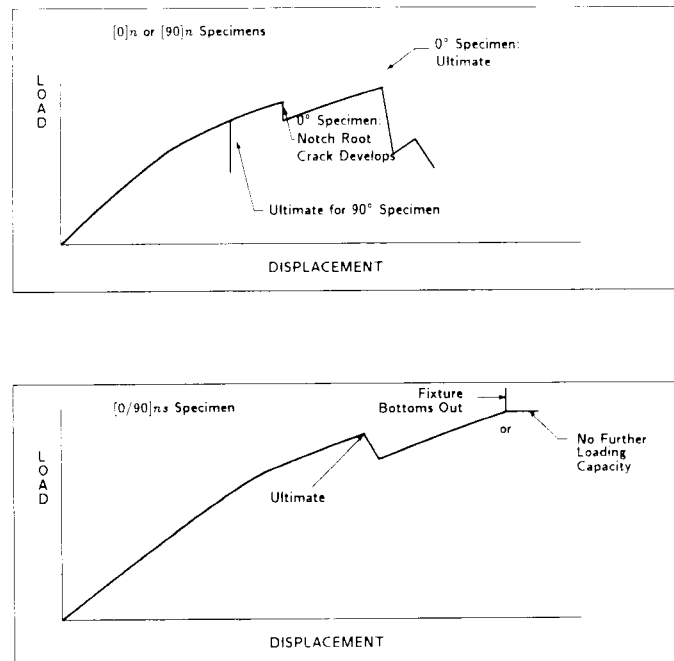

FIG. 5 Typical V-Notched Beam Load-Displacement Plots

used to measure the thickness of the specimen. A micrometer with a flat anvil interface shall be used to measure the width of the specimen. The accuracy of the instruments shall be suitable for reading to within 1 % of the sample width and thickness. For typical specimen geometries, an instrument with an accuracy of  $\pm 2.5 \mu\text{m}$  [ $\pm 0.0001 \text{ in.}$ ] is adequate for thickness measurement, while an instrument with an accuracy of  $\pm 25 \mu\text{m}$  [ $\pm 0.001 \text{ in.}$ ] is adequate for width measurement.

**7.2 Angle Measuring Device**—For measuring the specimen notch angle, accurate to within  $\pm 0.5^\circ$ .

**7.3 Radius Measuring Device**—For measuring the specimen notch radius, accurate to within  $\pm 25 \mu\text{m}$  [ $\pm 0.001 \text{ in.}$ ].

**7.4 Testing Machine**—The testing machine shall be in conformance with Practices E 4 and shall satisfy the following requirements:

**7.4.1 Testing Machine Heads**—The testing machine shall have both an essentially stationary head and a movable head.

**7.4.2 Drive Mechanism**—The testing machine drive mechanism shall be capable of imparting to the movable head a controlled velocity with respect to the stationary head. The velocity of the movable head shall be capable of being regulated as specified in 11.3.

**7.4.3 Load Indicator**—The testing machine load-sensing device shall be capable of indicating the total load being carried by the test specimen. This device shall be essentially free from inertia lag at the specified rate of testing and shall indicate the load with an accuracy over the load range(s) of interest of within  $\pm 1 \%$  of the indicated value. The load range(s) of interest may be fairly low for modulus evaluation, much higher for strength evaluation, or both, as required.

**NOTE 4**—Obtaining precision load data over a large range of interest in the same test, such as when both elastic modulus and ultimate load are being determined, place extreme requirements on the load cell and its calibration. For some equipment a special calibration may be required. For some combinations of material and load cell, simultaneous precision measurement of both elastic modulus and ultimate strength may not be possible, and measurement of modulus and strength may have to be performed in separate tests using a different load cell range for each test.

**7.4.4 Platens/Adapter**—One of the testing machine heads shall be capable of being attached to the lower half of the v-notched beam test fixture (see 7.4.5) and the other head shall be capable of being attached to the upper half of the fixture, using an adapter or platen interface as required. If required, one of the interfaces may be capable of relieving minor misalignments between the heads, such as a hemispherical ball joint.

**7.4.5 Fixturing**—The fixture used shall be a four-point asymmetric flexure fixture<sup>11</sup> shown schematically in Fig. 3, and in more detail in the machining drawings of ASTM Adjunct ADJD5379. Each half of the fixture contains a wedge-action grip which lightly clamps one half of the test specimen across the specimen width and supports the specimen on its back face. One of the grips, normally the lower half, is mounted on a base plate which also supports a linear bearing shaft, while the other grip, normally in the upper position, contains a linear bearing which mounts over the shaft on the base. Each element is

attached to or supported by one of the testing machine heads. A 13-mm [0.5-in.] span is left unsupported between fixture halves. An alignment tool is provided to ensure that the specimen notch is aligned with the line of action of the loading fixture.

**7.5 Strain Indicating Device**—Bonded resistance strain gages shall be used to measure strain. A minimum of two gage elements is required, centered about the loading axis in the gage section of the specimen, as shown in Fig. 6, and mounted at  $+45^\circ$  and  $-45^\circ$  to the loading axis. If specimen twisting is a concern, then two gage elements on each side of the specimen should be simultaneously measured to allow for a correction as a result of any twisting of the specimen, as discussed in Section 6. The output from each pair may be monitored individually and the outputs summed following the test, or each pair may be wired as a half-bridge so that the recorded strain is the sum of the absolute value of the response of each gage—yielding the shear strain response directly.

**7.5.1 Bonded Resistance Strain Gage Selection**—Strain gage selection is a compromise based on the type of material. An active gage length of 1.5 mm [0.062 in.] is recommended for most materials, although larger sizes may be more suitable for some woven fabrics. The gage length should not be so large as to extend significantly beyond the area in which shear strain is relatively uniform.<sup>12</sup> Gage calibration certification shall comply with Test Methods E 251. Strain gage rosettes with a minimum normal strain range of approximately 3 % (yielding 6 % shear strain) are recommended. When testing woven fabric laminates, gage selection should consider the use of an active gage length that is at least as great as the characteristic repeating unit of the weave. Some guidelines on the use of strain gages on composites follow. A general reference on the subject is Tuttle and Brinson (18).

**7.5.1.1 Surface preparation of fiber-reinforced composites** in accordance with Guide E 1237 can penetrate the matrix material and cause damage to the reinforcing fibers, resulting in improper coupon failures. Reinforcing fibers should not be

<sup>12</sup> A typical gage would have a 0.062- to 0.125-in. active gage length, 350- $\Omega$  resistance, a strain rating of 3 % or better, and the appropriate environmental resistance and thermal coefficient.

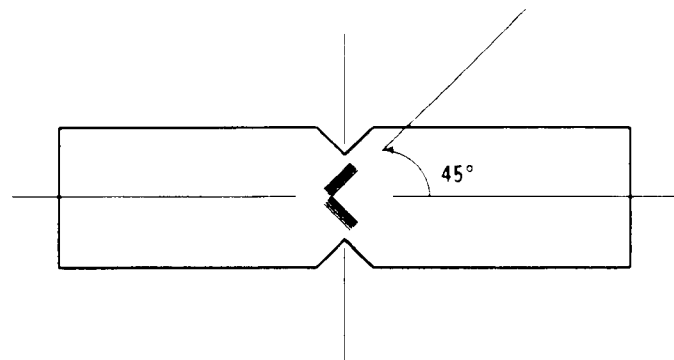

**NOTE 1**—The active elements of two orthogonal strain gages are centered between the notch roots at the angle shown. The elements may be independent, or in a stacked or or unstacked rosette.

**FIG. 6 Strain Gage Locations**

<sup>11</sup> Available from several commercial test fixture suppliers or testing equipment companies.



exposed or damaged during the surface preparation process. The strain gage manufacturer should be consulted regarding surface preparation guidelines and recommended bonding agents for composites, pending the development of a set of standard practices for strain gage installation surface preparation of fiber-reinforced composite materials.

7.5.1.2 Consideration should be given to the selection of gages having larger resistances to reduce heating effects on low-conductivity materials. Resistances of 350 Ω or higher are preferred. Additional consideration should be given to the use of the minimum possible gage excitation voltage consistent with the desired accuracy (1 to 2 V is recommended) to reduce the power consumed further by the gage. Heating of the coupon by the gage may affect the performance of the material directly or it may affect the indicated strain as a result of a difference between the gage temperature compensation factor and the coefficient of thermal expansion of the coupon material.

7.5.1.3 Consideration of some form of temperature compensation is recommended, even when testing at standard laboratory atmosphere. Temperature compensation is required when testing in nonambient temperature environments.

7.5.1.4 Consideration should be given to the transverse sensitivity of the selected strain gage. The strain gage manufacturer should be consulted for recommendations on transverse sensitivity corrections and effects on composites.

7.6 *Conditioning Chamber*—When conditioning materials at nonlaboratory environments, a temperature-vapor-level-controlled environmental conditioning chamber is required that shall be capable of maintaining the required temperature to within ±3°C [±5°F] and the required relative vapor level to within ±3%. Chamber conditions shall be monitored either on an automated continuous basis or on a manual basis at regular intervals.

7.7 *Environmental Test Chamber*—An environmental test chamber is required for test environments other than ambient testing laboratory conditions. This chamber shall be capable of maintaining the gage section of the test specimen at the required test environment during the mechanical test.

## 8. Sampling and Test Specimens

8.1 *Sampling*—Test at least five specimens per test conditions unless valid results can be gained through the use of fewer specimens, such as in the case of a designed experiment. For statistically significant data, consult the procedure outlined in Practice E 122. Report the method of sampling.

NOTE 5—If specimens are to undergo environmental conditioning to equilibrium, and are of such type or geometry that the weight change of the material cannot be properly measured by weighing the specimen itself (such as a tabbed mechanical coupon), then another traveler coupon of the same nominal thickness and appropriate size (but without tabs) shall be used to determine when equilibrium has been reached for the specimens being conditioned.

8.2 *Geometry*—The special coupon is a rectangular flat strip with symmetrical centrally located v-notches. The mandatory requirements are described in 8.2.1. Recommendations on parameters that are not required are discussed in 8.2.2.

### 8.2.1 Specimen Requirements:

#### 8.2.1.1 Shape, Dimensions, Tolerances, and

*Configuration*—The required specimen shape, dimensions, and tolerances are described in Fig. 7 (SI) and Fig. 8 (inch-pound). If required, adjust the standard notch angle of 90°, notch depth of 20%, and notch radius of 1.3 mm [0.050 in.] to meet special material requirements, but any deviation from these values must be recorded with the test results, and the standard tolerances on these features still apply. As discussed in Section 6 and 14.1, when testing laminated materials in the 1-2 material plane, the [0/90]<sub>n</sub>s specimen has been found to provide a more accurate modulus determination, shows less variation in the strength results, and is generally preferred over either the [0]<sub>n</sub> or [90]<sub>n</sub> specimens.

### 8.2.2 Specific Recommendations:

8.2.2.1 *Specimen/Tab Thickness*—A wide range is allowed in the requirement for specimen thickness and tab thickness to allow the user some flexibility in unusual cases. However, if at all possible, the specimen thickness should be kept in the range from 3 to 4 mm [0.120 to 0.160 in.]. A typical tab thickness is 1.5 mm [0.062 in.].

8.2.2.2 *Gripping/Use of Tabs*—There are many material

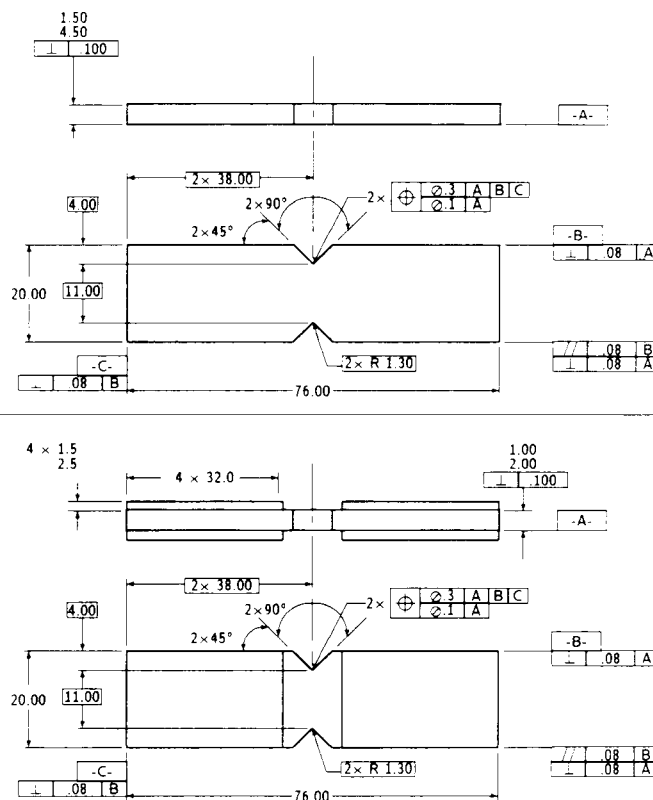

Drawing Notes—Interpret Fig. 7 in accordance with ANSI Y14.5M-1982, subject to the following:

- (1) All dimensions in millimetres with decimal tolerances as follows:  

No decimal	0.X	0.XX
±3	±1	±0.3
- (2) All angles have a tolerance of ±0.5°.
- (3) Ply orientation direction tolerance relative to -A- (or to -B-) within ±0.5°
- (4) Finish on machined edges not to exceed 1.6 √. Finish on V-notch not to exceed 0.8 √ (symbology is in accordance with ANSI/ASME B46.1-1985, with roughness height in micrometres.)
- (5) Values to be provided for the following, subject to any ranges shown ggyin the field of Fig. 7: material, lay-up, and ply orientation reference relative to -A-, coupon thickness, tab material, tab thickness, and tab adhesive.

FIG. 7 V-Notched Beam Test Specimen Drawing (SI)

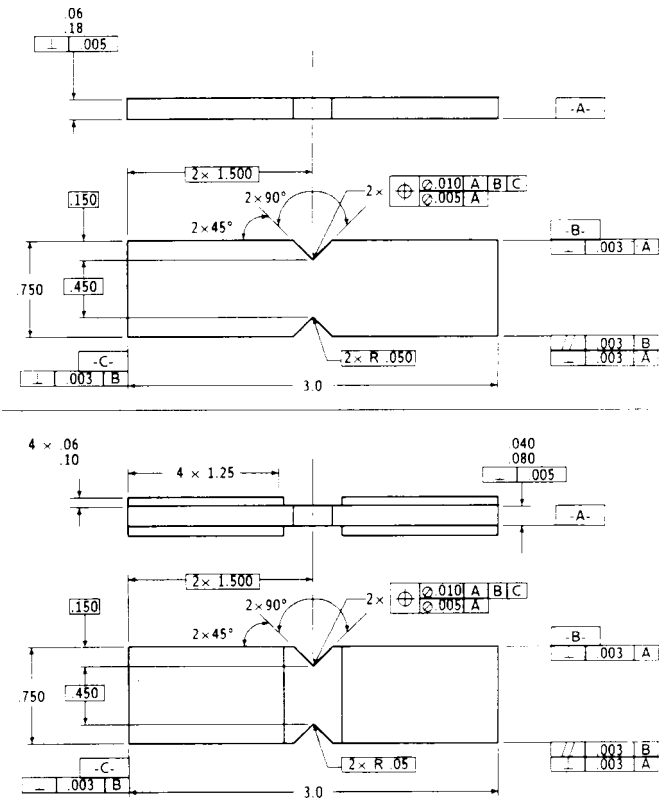

NOTE 1—Interpret Fig. 8 in accordance with ANSI Y14.5M-1982, subject to the following:

(1) All dimensions in inches with decimal tolerances as follows:

0.X 0.XX 0.XXX

±0.1 ±0.03 ±0.010

(2) All angles have a tolerance of  $\pm 0.5^\circ$ .

(3) Ply orientation direction tolerance relative to -A- (or to -B-) within  $\pm 0.5^\circ$ .

(4) Finish on machined edges not to exceed  $64 \sqrt{\text{in}}$ . Finish on V-notch not to exceed  $32 \sqrt{\text{in}}$  (symbology is in accordance with ANSI/ASME B46.1-1985, with roughness height in microinches).

(5) Values to be provided for the following, subject to any ranges shown on the the field of Fig. 8: material, lay-up, and ply orientation reference relative to

-A-, coupon thickness, tab material, tab thickness, and tab adhesive.

FIG. 8 V-Notched Beam Test Specimen Drawing (Inch Pound)

configurations, such as [0/90]ns laminates, fabric-based materials, or randomly reinforced sheet molding compounds, which can be successfully tested without tabs. However, use of tabs is recommended when testing materials that are less than 2.5 mm [0.100 in.] thick. Tabs, locally bonded to both faces of the specimen away from the test region, strengthen and stabilize the specimen by locally increasing the thickness in the gripping region, as shown in Fig. 7 and Fig. 8. This minimizes local crushing failures of the laminate by the gripping region of the fixture and reduces the possibility of twisting of the specimen in the fixture.

(1) Tab Material—The most consistently used bonded tab material has been continuous E-glass fiber-reinforced polymer matrix materials (woven or unwoven) in a [0/90]ns laminate configuration.

(2) Bonded Tab Adhesive—Use any high-elongation (tough) adhesive system that meets the environmental require-

ments when bonding tabs to the material under test. A uniform bondline of minimum thickness is desirable.

8.3 Material Orientation—Perform shear tests in any of the six material shear planes, as defined by Fig. 1 and by proper orientation of the laminate when fabricating and machining the coupon as illustrated by Fig. 9.

NOTE 6—For example: the 1-2 plane is located in the plane formed by the 1 and 2 axes and is oriented on the specimen so that the 1-direction (the first digit of the plane) is along the length of the specimen.

8.3.1 1-2/2-1 Shear Properties—The material properties in the 1-2 and 2-1 planes are in-plane properties for laminated composites. Prepare specimens for evaluation of these properties by cutting coupons from a [0] n, [90]n, or [0/90]ns laminate, so that the  $0^\circ$  direction is either along the length of the specimen or in the direction of the loading axis, as appropriate.

8.3.2 1-3/2-3 Shear Properties—The material properties in the 1-3 and 2-3 planes are interlaminar properties for laminated composites. Prepare specimens for evaluation of these properties by cutting coupons from a thick (20-mm [0.750-in.]) [0]n or [90]n laminate. The thick laminate may be manufactured several ways. The procedures in 8.3.2.1 or 8.3.2.2 are equally acceptable. The procedure in 8.3.2.3 should be used only if neither of the first two are possible, as the bondlines can influence the results.

8.3.2.1 Cure the laminate to the final panel thickness in a single operation.

8.3.2.2 Bond or cobond in two or more operations to achieve the final panel thickness, using for the test section a precured laminate that is greater than 14 mm [0.60 in.] thick to which has been symmetrically bonded on each side additional laminate to total the 20-mm [0.750-in.] total panel thickness.

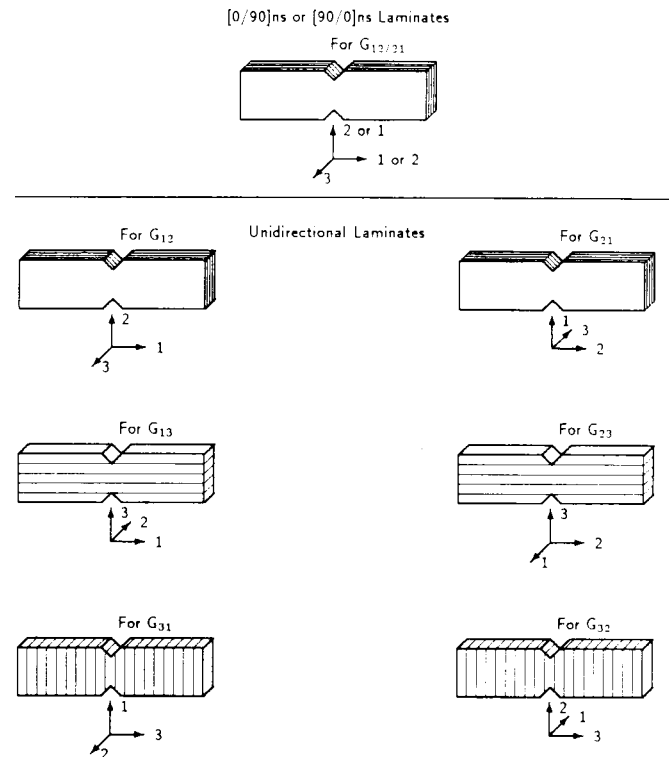

FIG. 9 Orientation of Material Planes

8.3.2.3 Bond together in two or more operations, using uniformly thin layers of adhesive, a minimum number of precured laminates to achieve the 20-mm [0.750-in.] total panel thickness.

8.3.3 *3-1/3-2 Shear Properties*—The material properties in the 3-1 and 3-2 planes are interlaminar properties for laminated composites. Prepare specimens for evaluation of these properties by cutting coupons from a [0] or [90]<sub>n</sub> laminate that is prepared as follows: Bond or cobond in two or more operations a number of precured layers, using for the test section a precured laminate which is as thick as possible (preferably greater than the width of the test section; at least 6 mm [0.25 in.] thick), to which has been symmetrically bonded on each side additional laminate of the same material to total the 76-mm [3.0-in.] total length. The number of bondlines traversing the notched section and the thickness of the bondlines should be kept to a minimum to prevent the adhesive from influencing the test results.

#### 8.4 *Specimen Preparation:*

8.4.1 *Panel Fabrication*—Control of fiber alignment is critical. Improper fiber alignment will reduce the measured properties. Erratic fiber alignment will also increase the coefficient of variation. The preparation method used shall be reported.

8.4.2 *Machining Methods*—Specimen preparation is extremely important for this specimen. The specimens may be molded individually to avoid edge and cutting effects or they may be cut from plates. If they are cut from plates, take precautions to avoid notches, undercuts, rough or uneven surfaces, or delaminations as a result of inappropriate machining methods. Obtain final dimensions by water-lubricated precision sawing, milling, or grinding. The use of diamond tooling has been found to be extremely effective for many material systems. Edges should be flat and parallel within the specified tolerances.

8.4.2.1 *Notch Preparation*—Take care to avoid delaminating specimens during notch machining. Stacking and clamping of the specimens in a vise, with a dummy specimen on the back side, has been found to be an effective method of preventing delamination during machining. Machining methods that have worked well for notch preparation include precision grinding and precision milling.

8.4.3 *Labeling*—Label the coupons so that they will be distinct from each other and traceable back to the raw material and in a manner that will both be unaffected by the test and not influence the test.

## 9. Calibration

9.1 The accuracy of all measuring equipment shall have certified calibrations that are current at the time of use of the equipment.

## 10. Conditioning

10.1 *Polymer Matrix Composites*—Unless a different environment is specified as part of the experiment, condition the test specimens in accordance with Procedure C of Test Method D 5229/D 5229M and store and test at standard laboratory atmosphere ( $23 \pm 2^\circ\text{C}$  [ $73.4 \pm 3.6^\circ\text{F}$ ] and  $50 \pm 10\%$  relative humidity).

10.2 *Nonpolymeric Materials*—No conditioning environment is required.

## 11. Procedure

### 11.1 *Parameters to Be Specified Before Test:*

11.1.1 The shear specimen sampling method, coupon type and geometry, and conditioning travelers (if required).

11.1.2 The shear properties and data reporting format desired.

NOTE 7—Specific material property, accuracy, and data reporting requirements should be determined before test for proper selection of instrumentation and data recording equipment. Estimates of operating stress and strain levels should also be made to aid in strain gage selection, calibration of equipment, and determination of equipment settings.

11.1.3 The environmental conditioning test parameters.

11.1.4 If performed, the sampling method, specimen geometry, and test parameters used to determine density and reinforcement volume.

### 11.2 *General Instructions:*

11.2.1 Report any deviations from this test method, whether intentional or inadvertent.

11.2.2 If specific gravity, density, reinforcement volume, or void volume are to be reported, then obtain these samples from the same panels being tension tested. Specific gravity and density may be evaluated by means of Test Method D 792. Volume percent of the constituents may be evaluated by one of the matrix digestion procedures of Test Method D 3171 or, for certain reinforcement materials such as glass and ceramics, by the matrix burn-off technique of Test Method D 2584. The void content equations of Test Method D 2734 are applicable to both Test Method D 2584 and the matrix digestion procedures.

11.2.3 Following any conditioning, but before the shear testing, measure and report the specimen width across the notch,  $w$ , to the nearest  $25\ \mu\text{m}$  [0.001 in.] and the specimen thickness at the notch,  $h$ , to the nearest  $2.5\ \mu\text{m}$  [0.0001 in.]. Calculate the cross-sectional area as follows:

$$A = w \times h \quad (1)$$

Record the area so obtained as the cross-sectional area for the specimen,  $A$ , in units of  $\text{mm}^2$  [ $\text{in.}^2$ ]. Verify that the notch angle, depth, and radius satisfy the required tolerances.

11.2.4 Mount the strain gages in the locations shown in Fig. 6.

11.3 *Speed of Testing*—Set the speed of testing to effect a nearly constant strain rate in the gage section. If strain control is not available on the testing machine, this may be approximated by repeated monitoring and adjusting of the rate of load application to maintain a nearly constant strain rate, as measured by strain gage response versus time. Select the strain rate so as to produce failure within 1 to 10 min. If the ultimate strain of the material cannot be reasonably estimated, conduct initial trials using standard speeds until the ultimate strain of the material and the compliance of the system are known, and the strain rate can be adjusted. The suggested standard speeds are as follows:

11.3.1 *Strain-Controlled Tests*—A standard shear strain rate of  $0.01\ \text{min}^{-1}$ .

11.3.2 *Constant Head-Speed Tests*—A standard head displacement rate of  $2\ \text{mm/min}$  [ $0.05\ \text{in./min}$ ].



NOTE 8—Use of a fixed head speed in testing machine systems with a high compliance will result in a strain rate that is much lower than required.

11.4 *Test Environment*—Condition the specimen to the desired moisture profile and, if possible, test under the same conditioning fluid exposure level. However, cases such as elevated temperature testing of a moist specimen place unrealistic requirements on the capabilities of common testing machine environmental chambers. In such cases, the mechanical test environment may need to be modified, for example, by testing at elevated temperature with no fluid exposure control, but with a specified limit on time to failure from withdrawal from the conditioning chamber. Modifications to the test environment shall be recorded.

11.4.1 Store the specimen in the conditioned environment until test time, if the testing area environment is different than the conditioning environment.

11.5 *Fixture Installation:*

NOTE 9—This test is run in compression in a testing machine with a stationary head and a moving head. While a vertical testing machine is not a requirement of this test method, for ease of description the instructions that follow assume the use of a vertical testing machine. The location of the moving head relative to the stationary head, as long as they create compression, or to which head the load transducer is attached are not important.

The fixture of this test method has two halves, either of which may be attached to either head of the testing machine. For convenience of description the half with the built-in base and bearing post is called the lower grip and is assumed to be attached to the lower head, while the fixture half with the bearing sleeve is called the upper grip and is assumed to be attached to the upper head, when oriented in a vertical testing machine.

11.5.1 *Inspect the Fixture*—Examine the fixture for signs of wear in the jaw/grip area or loose play between the linear bearing and its shaft. Correct any deficiencies in the fixture.

11.5.2 *Attach Upper Grip to Upper Head*—The adaptor that is shown in the test fixture drawings is optional and is test machine dependent. Many machines can be most easily adapted by using a threaded rod which connects the upper fixture grip to a tapped platen attached to the upper head. Two nuts run onto the rod before installation can be used as locknuts, one for the fixture movable grip and the other for the platen. Tighten the locknuts to preload the rod and stiffen the connection.

11.5.3 *Mate Lower Grip to the Upper Grip*—Support the fixture base under the fixture upper grip on a surface which is perpendicular to the line of action of loading. Move the testing machine head so that the bearing shaft of the fixture base slides through the bearing of the upper grip.

11.5.4 *Align the Grips*—Move the fixture base until the back-wall of the fixture lower grip is co-planar with the back wall of the upper grip.

NOTE 10—One method for doing this is to create a flat alignment plate which is somewhat smaller than the nominal specimen dimensions and through which two screws (through holes in the plate) can be made to mate with corresponding tapped holes in the grips, one in the stationary grip and the other in the movable grip. Installing and tightening this alignment plate forces the left (lower) grip to align with the right (upper) grip and the grip walls to be coplanar.

11.5.5 *Attach Lower Grip to Lower Head*—Following grip

alignment, attach the fixture base to the lower head of the test machine to prevent misalignment as a result of shock following specimen failure or operator handling. Remove the alignment plate. The fixture is now ready for specimen installation.

11.6 *Specimen Insertion and Transducer Connection:*

11.6.1 *Connect Gages*—Connect the specimen strain gages into the data acquisition circuitry and perform any necessary preliminary calibrations.

NOTE 11—It is highly desirable, though not required, to be able to watch strain-gage response during specimen installation as an aid to minimize undesirable preloading of the specimen.

11.6.2 *Zero Load*—Verify load-cell calibration and zero the load display. The load shall be able to be observed during specimen installation to minimize undesirable preload on the specimen.

11.6.3 *Loosen Jaws*—Loosen the jaw of each grip sufficiently to allow the specimen width to be freely inserted into the grip with clearance. Adjust the movable head position until the grips are approximately aligned vertically. Place the alignment tool in the groove in the lower fixture grip.

11.6.4 *Insert Specimen*—Place the specimen loosely into both grips and adjust strain-gage lead wires. Press the back side of the specimen flat against the back wall or shims. Pull the specimen alignment tool vertically up into the notch to center the specimen v-notch relative to the fixture in accordance with Fig. 10.

NOTE 12—If using a gage on the back side of the specimen the lead wires to the backside gage can be passed to the other side, before specimen insertion, by running the jaw of the lower grip to the left until the jaw clears the gap between the grips. Pass the wires through the opened space, then run the jaw back to the right to provide specimen clearance for installation.

11.6.5 *Tighten Left Half*—While keeping the specimen centered, lightly tighten the left-hand-side jaw (on the lower grip) to fix the specimen. DO NOT OVERTIGHTEN THE JAW; overtightening induces undesirable preload and may damage some materials. There should now be some clearance between the specimen and the upper grip and no load showing on the

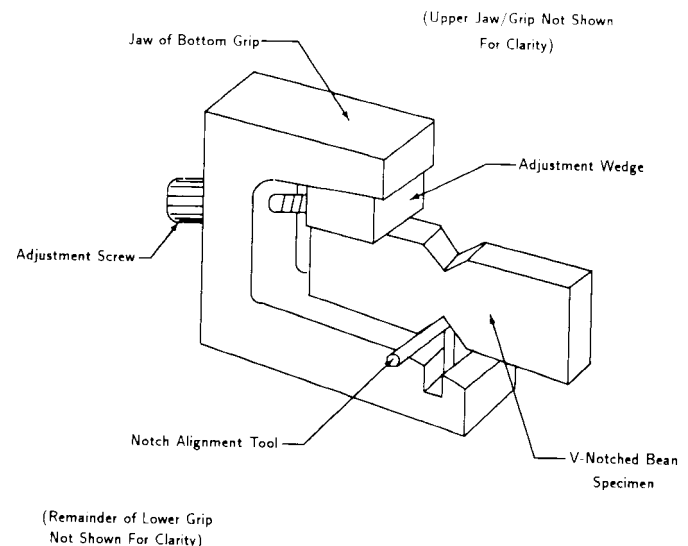

FIG. 10 Specimen Placement in the Fixture

test machine. If there is no clearance, or if load on the specimen is indicated, adjust either the head, or the jaw of the upper grip, or both, until there is both clearance and zero load. Recheck the specimen placement in the lower grip. Repeat if necessary.

11.6.6 *Tighten Right Half*—Move the testing machine head until the upper surface of the upper grip just contacts the upper surface of the right-hand side of the specimen, without loading it. Zero strain gage instrumentation. Lightly tighten the jaw of the upper, right-hand, grip onto the right-hand side of the specimen. **DO NOT OVERTIGHTEN THE JAW**; overtightening induces undesirable preload and may damage some materials. Preload should be minimized; however, a small amount of preload (40 to 80 N [10 to 20 lbf]) may be unavoidable in a given application.

11.6.7 *Check Placement*—The specimen should now be centered in the fixture so that the line of action of the load acts directly through the center of the notch on the coupon. Both jaws have been lightly tightened so that the specimen is contacting the upper and lower grip surfaces on both left- and right-hand sides and is lightly supported on the back side away from the gage section. Instrumentation checks are complete, and the specimen is now ready to complete the test.

11.7 *Loading*—Apply the load to the specimen at the specified rate until failure, while recording data.

11.8 *Data Recording*—Record load versus strain and load versus head displacement continuously, or at frequent regular intervals. If a load-strain or load-displacement discontinuity occurs or initial ply failures are observed, record the load, strain, and mode of damage at such points. If the specimen is to be failed, record the maximum load before failure and the strain at, or as near as possible to, the moment of rupture. If ultimate failure does not occur within 5 % strain, the data shall be truncated to this value. Guidance on interpretation of failure load is given in Section 6.

NOTE 13—Other valuable data that can be useful in understanding testing anomalies and gripping or specimen slipping problems includes load versus head displacement data and load versus time data.

11.8.1 *Failure Mode*—Record the mode and location of failure of the specimen. Choose, if possible, a standard description from the sketches of common v-notch shear test failure modes that are shown in Fig. 11.

## 12. Calculation

12.1 *Shear Stress/Ultimate Strength*—Calculate the ultimate strength using Eq 2 and report the results to three significant figures. If the shear modulus is to be calculated, determine the shear stress at each required data point using Eq 3.

$$F^u = P^u/A \quad (2)$$

$$\tau_i = P_i/A \quad (3)$$

Common Unacceptable Failure Modes  
(Typically Initiated At Loading Points)

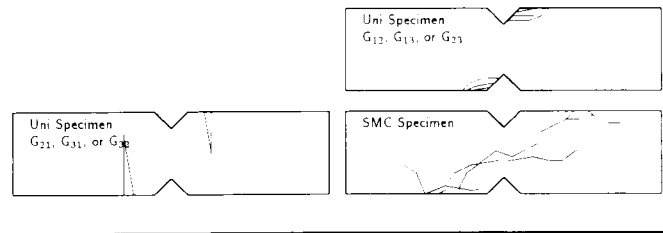

Typical Acceptable Failure Modes

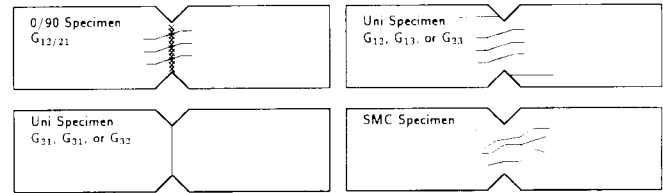

FIG. 11 Common V-Notched Beam Shear Test Failure Modes

where:

$F^u$  = ultimate strength, MPa [psi];

$P^u$  = the lower of ultimate or load at 5 % shear strain, N [lbf];

$\tau_i$  = shear stress at ith data point, MPa [psi];

$P_i$  = load at ith data point, N [lbf]; and

$A$  = cross-sectional area from 11.2.3, mm<sup>2</sup> [in.<sup>2</sup>].

12.2 *Shear Strain/Ultimate Strain*—If shear modulus or ultimate strain is to be calculated, determine the shear strain from the indicated normal strains at +45° and -45° at each required data point using Eq 4. The ultimate shear strain is determined from Eq 5. Report the results to three significant figures.

$$\gamma_i = |\epsilon_{+45}| + |\epsilon_{-45}| \quad (4)$$

$$\gamma^a = \min \left\{ \begin{array}{l} 5\% \\ \gamma \text{ at ultimate load} \end{array} \right. \quad (5)$$

where:

$\gamma_i$  = shear strain at ith data point,  $\mu\epsilon$ ;

$\epsilon_{+45}$  = +45° normal strain at ith data point,  $\mu\epsilon$ ;

$\epsilon_{-45}$  = -45° normal strain at ith data point,  $\mu\epsilon$ ; and

$\gamma^a$  = ultimate shear strain,  $\mu\epsilon$ .

### 12.3 Shear Modulus of Elasticity:

NOTE 14—To minimize potential effects of twisting, it is recommended that the strain data used for modulus of elasticity determination be the average of the indicated strains from each side of the specimen, as discussed in Section 6.

12.3.1 *Shear Chord Modulus of Elasticity*—Calculate the shear chord modulus of elasticity using Eq 6, applied over a 4000 ± 200- $\mu\epsilon$  strain range, starting with the lower strain point in the range of 1500 to 2500  $\mu\epsilon$  inclusive. If data is not available at the exact strain range end points (as often occurs with digital data), use the closest available data point. Report the shear chord modulus of elasticity to three significant figures. Also report the strain range used in the calculation. A graphical example of shear chord modulus is shown in Fig. 12.

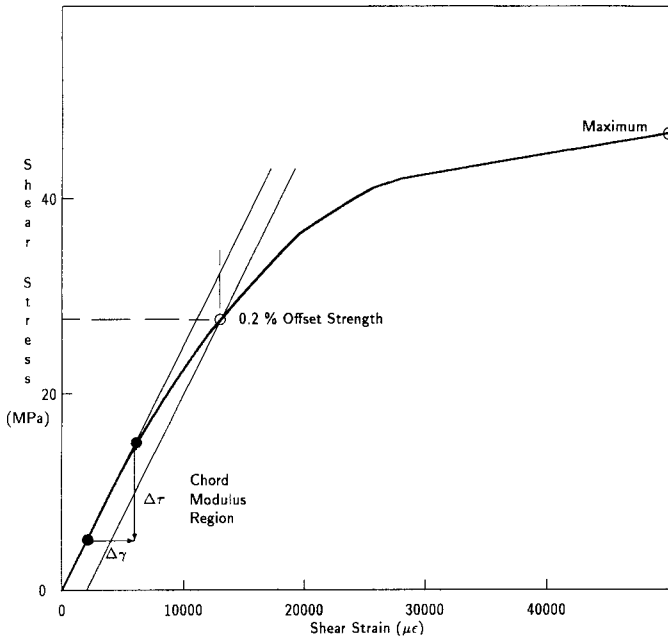

FIG. 12 Illustration of Modulus and Offset Strength Determination

12.3.1.1

$$G^{chord} = \Delta\tau / \Delta\gamma \quad (6)$$

where:

- $G^{chord}$  = shear chord modulus of elasticity, GPa [psi];
- $\Delta\tau$  = difference in applied shear stress between the two strain points; and
- $\Delta\gamma$  = difference between the two strain points (nominally 0.004).

12.3.2 *Shear Modulus of Elasticity (Other Definitions)*—Other definitions of elastic modulus may be evaluated and reported at the user’s discretion. If such data is generated and reported, report also the definition used, the strain range used, and the results to three significant figures. Test Method E 111 provides additional guidance in the determination of modulus of elasticity.

NOTE 15—An example of another modulus definition is the secondary chord modulus of elasticity for materials that exhibit essentially bilinear stress-strain behavior.

12.4 *Offset Shear Strength*—If desired, an offset shear strength may be determined from the shear stress versus shear strain curve. Translate the shear chord modulus of elasticity line along the strain axis from the origin by a fixed strain value and extend this line until it intersects the stress-strain curve. Determine the shear stress that corresponds to the intersection point and report this value, to three significant digits, as the offset shear strength, along with the value of the offset strain, as in:

$$F^o (0.2 \% \text{ offset}) = 28 \text{ MPa} \quad (7)$$

A graphical example of offset shear strength is shown in Fig. 12.

NOTE 16—In the absence of evidence suggesting the use of a more appropriate value, an offset strain value of 0.2 % is recommended.

12.5 *Statistics*—For each series of tests calculate the aver-

age value, standard deviation, and coefficient of variation (in percent) for each property determined:

$$\bar{x} = (\sum_{i=1}^n x_i) / n \quad (8)$$

$$s_{n-1} = \sqrt{(\sum_{i=1}^n x_i^2 - n\bar{x}^2) / (n - 1)} \quad (9)$$

$$CV = 100 \times s_{n-1} / \bar{x} \quad (10)$$

where:

- $\bar{x}$  = sample mean (average);
- $s_{n-1}$  = sample standard deviation;
- $CV$  = sample coefficient of variation, %;
- $n$  = number of specimens; and
- $x_i$  = measured or derived property.

13. Report

13.1 Report the following information, or references pointing to other documentation containing this information, to the maximum extent applicable (reporting of items beyond the control of a given testing laboratory, such as might occur with material details or panel fabrication parameters, shall be the responsibility of the requestor):

- 13.1.1 The revision level or date of issue of this test method.
- 13.1.2 The date(s) and location(s) of the test.
- 13.1.3 The name(s) of the test operator(s).

13.1.4 Any variations to this test method, anomalies noticed during testing, or equipment problems occurring during testing.

13.1.5 Identification of the material tested including: material specification, material type, material designation, manufacturer, manufacturer’s lot or batch number, source (if not from manufacturer), date of certification, expiration of certification, filament diameter, tow or yarn filament count and twist, sizing, form or weave, fiber areal weight, matrix type, prepreg matrix content, and prepreg volatiles content.

13.1.6 Description of the fabrication steps used to prepare the laminate including: fabrication start date, fabrication end date, process specification, cure cycle, consolidation method, and a description of the equipment used.

13.1.7 Ply orientation stacking sequence of the laminate.

13.1.8 If requested, report density, volume percent reinforcement, and void content test methods, specimen sampling method and geometries, test parameters, and test results.

13.1.9 Average ply thickness of the material.

13.1.10 Results of any nondestructive evaluation tests.

13.1.11 Method of preparing the test specimen, including specimen labeling scheme and method, specimen geometry, sampling method, coupon cutting method, identification of tab geometry, tab material, and tab adhesive used.

13.1.12 Calibration dates and methods for all measurement and test equipment.

13.1.13 Type of test machine, grips, jaws, grip pressure, alignment results, and data acquisition sampling rate and equipment type.

13.1.14 Dimensions of each test specimen.

13.1.15 Conditioning parameters and results, use of travelers and traveler geometry, and the procedure used if other than that specified in the test method.

13.1.16 Relative humidity and temperature of the testing laboratory.

13.1.17 Environment of the test machine environmental chamber (if used) and soak time at environment.

13.1.18 Number of specimens tested.

13.1.19 Speed of testing.

13.1.20 Transducer placement on the specimen and transducer type for each transducer used.

13.1.21 The strain-gage type, resistance, size, gage factor, temperature compensation method, transverse sensitivity, lead-wire resistance, and any correction factors used.

13.1.22 Load-displacement and stress-strain curves for each specimen.

13.1.23 Tabulated data of stress versus strain for each specimen.

13.1.24 Percent twisting results for each specimen so evaluated.

13.1.25 Individual strengths and average value, standard deviation, and coefficient of variation (in percent) for the population. Note if the failure load was less than the maximum load before failure.

13.1.26 Individual ultimate strains and the average value, standard deviation, and coefficient of variation (in percent) for the population. Note any test that was truncated to 5 % strain.

13.1.27 Strain range used for chord modulus determination.

13.1.28 If another definition of modulus of elasticity is used in addition to chord modulus, describe the method used, the resulting correlation coefficient (if applicable), and the strain range used for the evaluation.

13.1.29 Individual values of shear modulus of elasticity, and the average value, standard deviation, and coefficient of variation (in percent) for the population.

13.1.30 Individual values of offset shear strength with the value of the offset strain, along with the average, standard deviation, and coefficient of variation (in percent) values for the population.

13.1.31 Failure mode and location of failure for each specimen.

## 14. Precision and Bias

### 14.1 Precision:

14.1.1 *Preliminary Round-Robin Series*—A preliminary round-robin test series using an early draft of this test method

was conducted by ASTM Committee D-30 in seven laboratories, using several configurations of unidirectional carbon/epoxy and aramid/epoxy laminates as well as randomly oriented short-fiber glass/polyester sheet-molding compound (SMC). The shear plane tested in all cases was the 1-2 plane. All testing was conducted under single-operator, single-machine, same-day conditions. The detailed results of this round-robin have been published (19). As this test method and the knowledge of how to best apply it has significantly matured since the initial round-robin test series, a new round-robin series is being planned by Committee D-30 to update the precision statement, following adoption of this test method as a standard.

14.1.2 *Results*—The precision is defined as a 95 % confidence interval, requiring two standard deviations for the sample population tested. For within-laboratory results, Practice E 177 calls this the repeatability, while for between-laboratory results it is called the reproducibility. The results, summarized in Table 1, indicate that [0/90]ns laminate configuration has significantly lower strength scatter than the other configurations. Also notable is the high scatter in modulus values for all configurations tested. This has been since largely attributed not to the test method itself, but to the lack of a standard definition for elastic modulus in the draft version of the test method used for the preliminary round-robin testing.

14.2 *Bias*—Bias cannot be determined for this test method as no acceptable reference standard exists.

## 15. Keywords

15.1 composite materials; in-plane shear; interlaminar shear; shear modulus; shear properties; shear strength; shear testing

**TABLE 1 Preliminary Repeatability and Reproducibility**

Specimen Configuration and Material	95 % Confidence Interval (2σ)			
	Within Laboratory, Repeatability <sup>A</sup>		Between Laboratories, Reproducibility <sup>A</sup>	
	Strength	Modulus	Strength	Modulus
[0/90]ns carbon/epoxy	5.27	15.2	5.29	15.9
[0]n carbon/epoxy	18.7	9.88	29.2	11.1
[90]n carbon/epoxy	42.5	18.4	47.2	18.7
[0]n aramid/epoxy	18.2	11.8	59.9	0.0
[90]n aramid/epoxy	23.4	25.8	26.0	29.0
SMC	17.9	26.9	21.9	26.6

<sup>A</sup>Normalized to mean, in percent.



**REFERENCES**

- (1) Walrath, D. E., and Adams, D. F., "The Iosipescu Shear Test as Applied to Composite Materials," *Experimental Mechanics*, Vol 23, No. 1, March 1983, pp. 105–110.
- (2) Walrath, D. E., and Adams, D. F., "Analysis of the Stress State in an Iosipescu Test Specimen," University of Wyoming Department Report UWME-DR-301-102-1, June 1983.
- (3) Walrath, D. E., and Adams, D. F., "Verification and Application of the Iosipescu Shear Test Method," University of Wyoming Department Report UWME-DR-401-103-1, June 1984.
- (4) Adams, D. F., and Walrath, D. E., "Further Development of the Iosipescu Test Method," *Experimental Mechanics*, Vol 27, No. 2, June 1987, pp. 113–119.
- (5) Arcan, M., and Goldenberg, N., "On a Basic Criterion for Selecting a Shear Testing Standard for Plastic Materials," (in French), ISO/TC 61-WG 2 S.P. 171, Burgenstock, Switzerland, 1957.
- (6) Goldenberg, N., Arcan, M., and Nicolau, E., "On the Most Suitable Specimen Shape for Testing Shear Strength of Plastics," International Symposium on Plastics Testing and Standardization, (Oct. 30–31, 1985, Philadelphia), ASTM STP 247, 1959, pp. 115–121.
- (7) Arcan, M., Hashin, Z., and Voloshin, A., "A Method to Produce Uniform Plane-stress States with Applications to Fiber-reinforced Materials," *Experimental Mechanics*, Vol 18, No. 4, April 1978, pp. 141–146.
- (8) Iosipescu, N., "Photoelastic Investigations on an Accurate Procedure for the Pure Shear Testing of Materials," (in Romanian), *Studii si Cercetari de Mecanica Aplicata*, Vol 13, No. 3, 1962.
- (9) Iosipescu, N., "Photoelastic Investigations on an Accurate Procedure for the Pure Shear Testing of Materials," *Revue de Mecanique Appliquée*, Vol 8, No. 1, 1963.
- (10) Iosipescu, N., "New Accurate Procedure for Single Shear Testing of Metals," *Journal of Materials*, Vol 2, No. 3, September 1967, pp. 537–566.
- (11) Bergner, H. W., Davis, J. G., and Herakovich, C. T., "Analysis of Shear Test Methods for Composite Laminates," VPI-E-77-14, Virginia Polytechnic Institute and State University, Blacksburg, VA, April 1977; also NASA CR-152704.
- (12) Sleptez, J. M., Zagaeksi, T. F., and Novello, R. F., "In-Plane Shear Test for Composite Materials," AMMRC TR 78-30, Army Materials and Mechanics Research Center, Watertown, MA, July 1978.
- (13) Herakovich, C. T., Bergner, H. W., and Bowles, D. E., "A Comparative Study of Composite Shear Specimens Using the Finite-Element Method," *Test Methods and Design Allowables for Fibrous Composites*, ASTM STP 734, 1981, pp. 129–151.
- (14) Sullivan, J. L., Kao, B. G., and Van Oene, H., "Shear Properties and a Stress Analysis Obtained from Vinyl-ester Iosipescu Specimens," *Experimental Mechanics*, Vol 24, No. 3, September 1984, pp. 223–232.
- (15) Ho, H., Tsai, M. Y., Morton, J., and Farley, G. L., "An Experimental Investigation of Iosipescu Specimen for Composite Materials," *Experimental Mechanics*, Vol 31, No. 4, December 1991, pp. 328–336.
- (16) Morton, J., Ho, H., Tsai, M. Y., and Farley, G. L., "An Evaluation of the Iosipescu Specimen for Composite Materials Shear Property Measurement," *Journal of Composite Materials*, Vol 26, No. 5, 1992, p. 708.
- (17) Arcan, M., "The Iosipescu Shear Test as Applied to Composite Materials—Discussion," *Experimental Mechanics*, Vol 24, No. 1, March 1984, pp. 66–67.
- (18) Tuttle, M. E., and Brinson, H. F., "Resistance-Foil Strain-Gage Technology as Applied to Composite Materials," *Experimental Mechanics*, Vol 24, No. 1, March 1984, pp. 54–65; errata noted in Vol 26, No. 2, June 1986, pp. 153–154.
- (19) Wilson, D. W., "Evaluation of the V Notched Beam Shear Test Through an Interlaboratory Study," *Journal of Composite Technology and Research*, Vol 12, No. 3, 1990, pp. 131–138.

*The American Society for Testing and Materials takes no position respecting the validity of any patent rights asserted in connection with any item mentioned in this standard. Users of this standard are expressly advised that determination of the validity of any such patent rights, and the risk of infringement of such rights, are entirely their own responsibility.*

*This standard is subject to revision at any time by the responsible technical committee and must be reviewed every five years and if not revised, either reapproved or withdrawn. Your comments are invited either for revision of this standard or for additional standards and should be addressed to ASTM Headquarters. Your comments will receive careful consideration at a meeting of the responsible technical committee, which you may attend. If you feel that your comments have not received a fair hearing you should make your views known to the ASTM Committee on Standards, at the address shown below.*

*This standard is copyrighted by ASTM, 100 Barr Harbor Drive, PO Box C700, West Conshohocken, PA 19428-2959, United States. Individual reprints (single or multiple copies) of this standard may be obtained by contacting ASTM at the above address or at 610-832-9585 (phone), 610-832-9555 (fax), or service@astm.org (e-mail); or through the ASTM website (www.astm.org).*