

## flare MOVE 02/04S

### 可插拔中间继电器

插拔式中间继电器  
继电器宽度22.5mm  
底座拆卸方便快捷  
螺钉端子  
塑料和金属卡扣可自由选择  
自带LED指示灯（AC红色，DC绿色）  
线圈电压5-220VDC/110，220VAC  
2个10A的转换触点  
或4个5A的转换触点  
带可锁定的手动按钮（AC橙色，DC蓝色）

#### 订货信息:

型号	订货号	标准包装	订货号	标准包装
继电器				
flare MOVE	2 转换触点		4 转换触点	
DC5V	33.113.0173.9	20	33.113.0180.9	20
DC12V	33.113.0174.9	20	33.113.0181.9	20
DC24V	33.113.0122.9	20	33.113.0120.9	20
DC48V	33.113.0175.9	20	33.113.0138.9	20
DC110V	33.113.0176.9	20	33.113.0182.9	20
DC220V	33.113.0179.9	20	33.113.0184.9	20
AC24V	33.280.0024.0	20		
AC110V	33.113.0177.9	20	33.113.0183.9	20
AC220V	33.113.0178.9	20	33.113.0139.9	20
底座				
flare BASE	2 转换触点		4 转换触点	
flare BASE W	33.113.0123.9	10	33.113.0121.9	10
flare BASE BC	33.115.6000.3	20	33.115.6000.5	20
附件				
续流二极管*	33.114.0031.9	100	33.114.0031.9	100
阻容模块*	33.115.6000.1	100	33.115.6000.1	100
塑料锁扣*	33.114.0032.9	100	33.114.0032.9	100

\*:仅能配合 flare BASE W 底座使用

#### flare MOVE 02S 24VDC

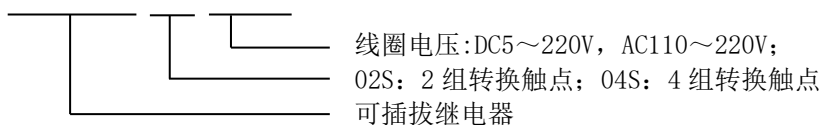

#### flare BASE 02 W

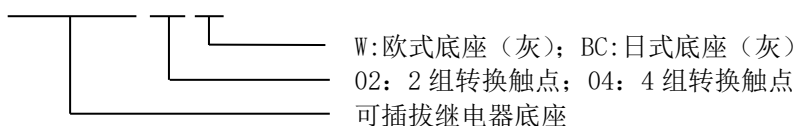

## 技术参数:

## 1. 线圈参数

额定电压 VDC		最大电压 V	动作电压 ≤V	释放电压 ≥V	线圈电阻 Ω±15%	线圈功耗
DC	5	5.5	80%	10%	28	约0.9W
	12	13.2			160	
	24	26.4			650	
	48	52.8			2560	
	110	121			13000	
	220	242			53700	
AC	110/120	132	80%	30%	4000	约1.2VA
	220/240	264			15000	

## 2. 触点参数

触点类型	2转换触点	4转换触点
额定电流	10A 250VAC/30VDC	5A 250VAC/30VDC
触点材料	AgSnO <sub>2</sub>	
最大启动电流	20A	10A
最大开关电压	300VAC/100VDC	
最小适用负载	100mA/5VDC	
接触电阻	≤100mΩ (1A 6VDC)	

## 3. 整体参数

机械寿命	1x10 <sup>7</sup>
电气寿命	1x10 <sup>5</sup> 见图...电耐久性曲线
动作时间	≤25mS
释放时间	≤25mS
断开的触点间耐压	≥1000V eff/ 1 min
触点与线圈间耐压	≥1500V eff/ 1 min
触点组间耐压	≥1500V eff/ 1 min
线圈温升	≤60k (触点空载, 额定电压下)
工作温度	-40° C...70° C
储存温度	-40° C...70° C
湿度	35%...85% 无冷凝
状态指示	机械指示窗口 (AC, 橙, DC, 蓝) 及 LED (AC, 红, DC, 绿)
连接方式	螺钉连接
底座额定电压	300V
底座额定电流	10A
接线范围	W: 软线0.25~4mm <sup>2</sup> , 硬线0.25~6mm <sup>2</sup> BC: 软线0.5~1.5mm <sup>2</sup> , 硬线0.25~2.5mm <sup>2</sup>
外型尺寸	见图
认证	CE, CQC

外型及尺寸

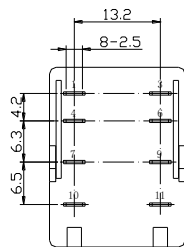
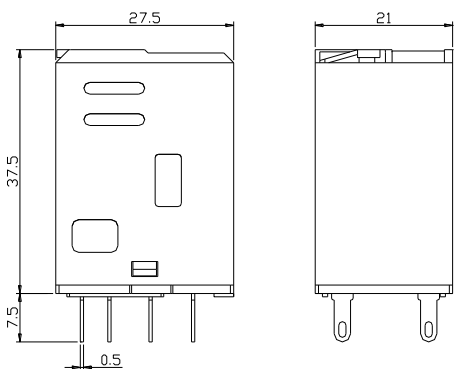

flare MOVE 02S

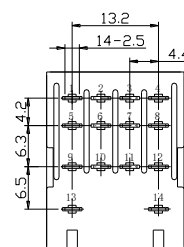

flare MOVE 04S

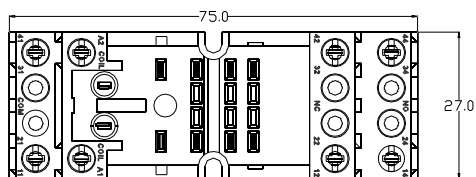
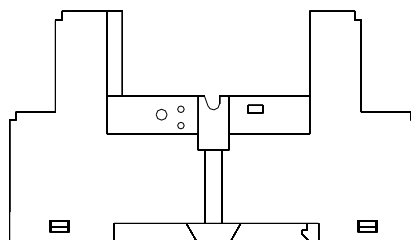
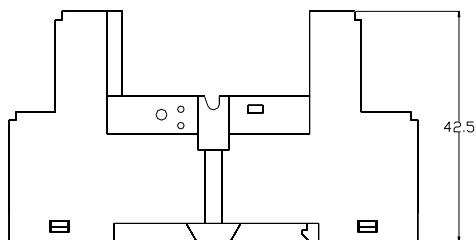

flare BASE 02 W

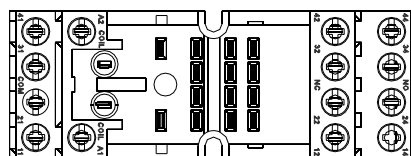

flare BASE 04 W

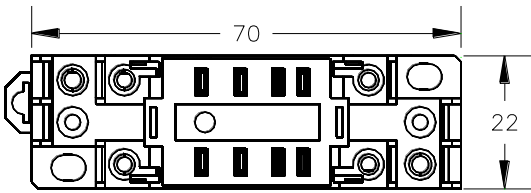
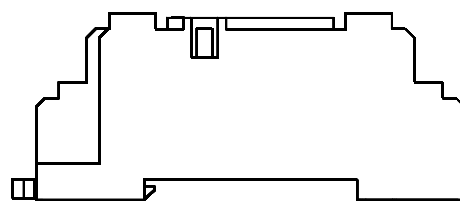
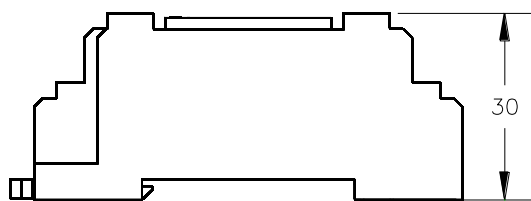

flare BASE 02 BC

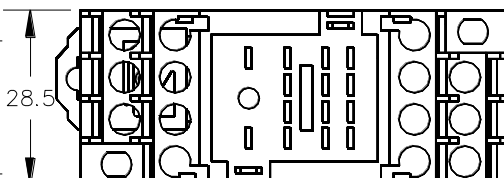

flare BASE 04 BC

接线图

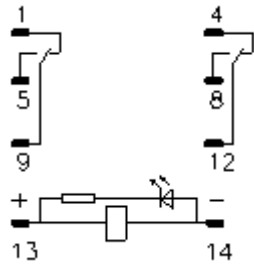

flare MOVE 02S (Bottom view)

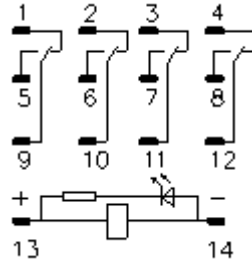

flare MOVE 04S (Bottom view)

性能曲线图

开关容量最大值

flare MOVE 02S

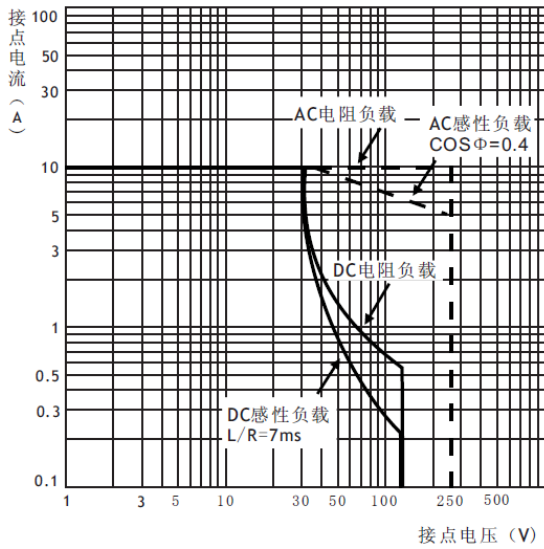

电耐久性曲线

flare MOVE 02S

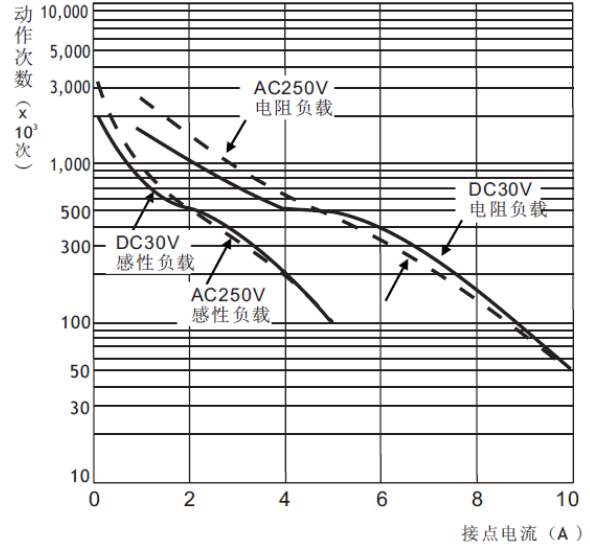

flare MOVE 04S

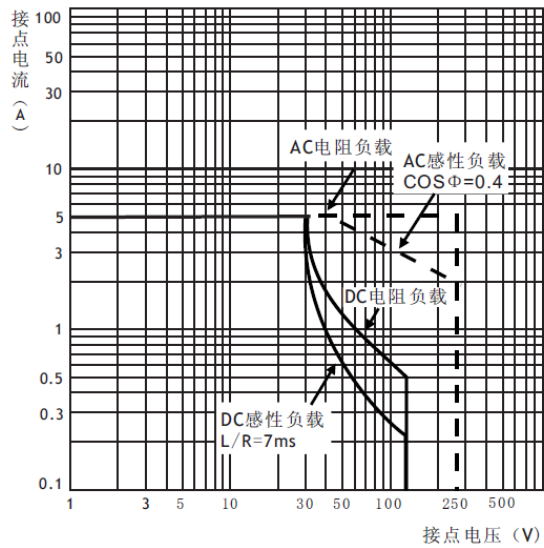

flare MOVE 04S

