

HR710 继电器

HR710 Relay

HR710-2P (2极) 2Pole
HR710-2PP (2极 PCB用) 2Pole PCB Type

HR710-2PL (2极 LED) 2Pole LED

HR710-4PL (4极 LED) 4Pole LED

HR710-2PLD

(2极LED指示, 内置浪涌吸收装置)

2Pole LED, Surge-protection

HR710-4PLD

(4极LED指示, 内置浪涌吸收装置)

4Pole LED, Surge-protection

HR710-2PLC

(2极LED指示, 内置浪涌吸收装置)

2Pole LED, Surge-protection

HR710-4PLC

(4极LED指示, 内置浪涌吸收装置)

4Pole LED, Surge-protection

● 认证事项 ●
Certification



more...www.zm365.com

HR710-2P



2极 2Pole

AC 220V
110V
24V
DC 110V
24V
12V

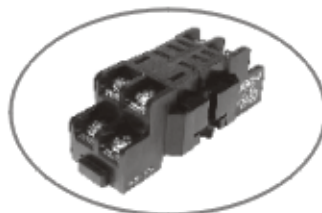

适用插座(KLY2)
Socket(KLY2)

HR710-2PL



2极 LED
2Pole LED

AC 220V
110V
24V
DC 110V
24V
12V

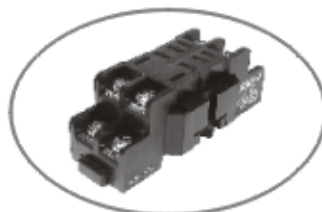

适用插座(KLY2)
Socket(KLY2)

HR710-2PP



2极 PCB型
2Pole PCB

AC 220V
DC 24V

HR710-4PL



4极 LED
4Pole LED

AC 220V
110V
24V
DC 110V
24V
12V

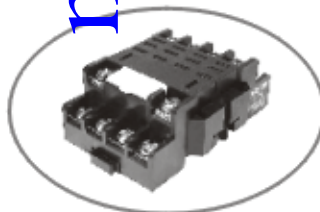

适用插座(KMY4)
Socket(KMY4)



适用插座(KTF14A)
Socket(KTF14A)

more... www.zm365.com

※上面标记规格以外的电压及特征需要订货生产，交货期与价格请与各代理商咨询。
※其他适用插座请参考(11-33)页。



HR710-2PLD



2极LED指示 2Pole LED
(内置浪涌吸收装置)
Surge-Protection

DC 24V

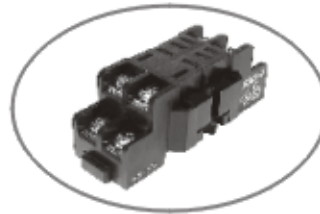

适用插座(KLY2)
Socket(KLY2)

HR710-4PLD



4极LED指示 4Pole LED
(内置浪涌吸收装置)
Surge-Protection

DC 24V

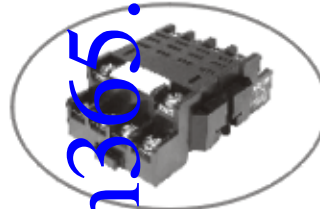

适用插座(KLY4)
Socket(KLY4)

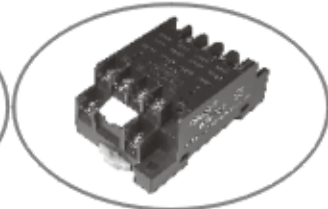

适用插座(KTF14A)
Socket(KTF14A)

HR710-2PLC



2极LED指示 2Pole LED
(内置浪涌吸收装置)
Surge-Protection

AC 220V

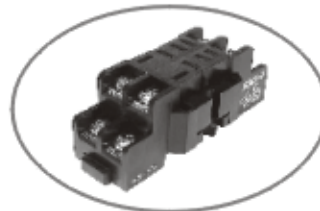

适用插座(KLY2)
Socket(KLY2)

HR710-4PLC



4极LED指示 4Pole LED
(内置浪涌吸收装置)
Surge-Protection

AC 220V

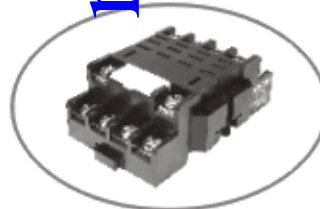

适用插座(KLY4)
Socket(KLY4)



适用插座(KTF14A)
Socket(KTF14A)

※ 内置浪涌抑制吸收装置的规格需要订货生产，交货期与价格请与各代理商咨询。
※ 其他适用插座请参考(11-33)页。

more...www.zm365.com

■ 触点部位 Contact

触点结构 Contact Arrangement	2C (2a+2b) 4C (4a+4b)	
触点材质 Contact Material	银合金 Ag Alloy	
首次接触电阻 Contact Resistance	最大50mΩ	
额定电流 Rated Current (电阻负载) (Resistive Load)	2C (2a+2b)	4C (4a+4b)
	10A 24VDC	
	10A 240VAC	
最大通电电流 Max. Carry Current	10A	
最大开闭电压 Max. Switching Voltage	125VDC/250VAC	
最小开关额定 Min. Switching Rating	100mA 5VDC	

※参考使用注意事项

■ 线圈部位 Coil

电压特征 Nominal Voltage	6VDC to 110VDC	
	6VAC to 240VAC	
消耗电力 Nominal Power Consumption	2P DC 线圈约 0.9W / 4P DC 线圈约 1.5W	
	2P AC 线圈约 1.2VA / 4P AC 线圈约 2.5VA	
最小动作电压 Operate Voltage	额定电压80%	
最大释放电压 Release Voltage	DC: 额定电压的10%	
	AC: 额定电压的30%	

■ 一般性能 General Specification

动作时间 Operate Time	25msec	
释放时间 Release Time	25msec	
绝缘电阻 Insulation Resistance	100MΩ at 500VDC	
介质耐压 Dielectric Strength	触点间 Between Contact	1,000Vrms 1分钟
	触点与线圈 Between Contact Coil	1,500Vrms 1分钟
寿命 Expected Life	机械 Mechanical	100万次
	电气 Electrical	10万次
耐振动 Vibration Resistance	10~55Hz (振动幅1.5mm)	
环境温度 Ambient Temperature	-25°C~55°C (无凝露、无结冰)	
环境湿度 Ambient Humidity	35%~80%RH	
重量 Weight	2P: 约33g / 4P: 约65g	
装配螺丝扭矩 Torque(Socket)	0.8N·m(8.16kgf·cm)	

※如因提高质量而进行产品更改，恕不另行通知。
All right reserved. Specification subject to change without notice.

HR710-2P

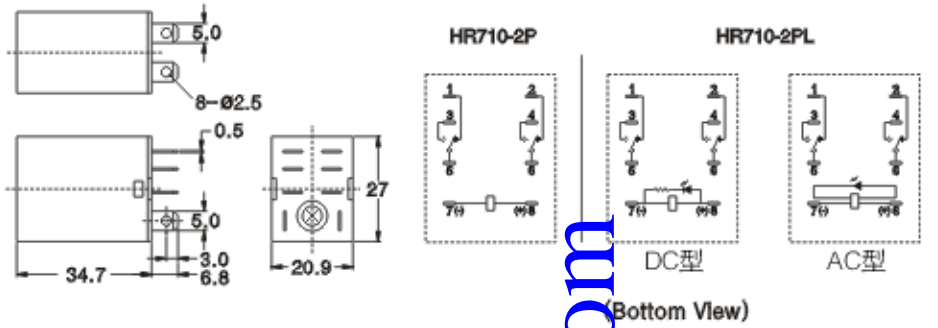

HR710-4P

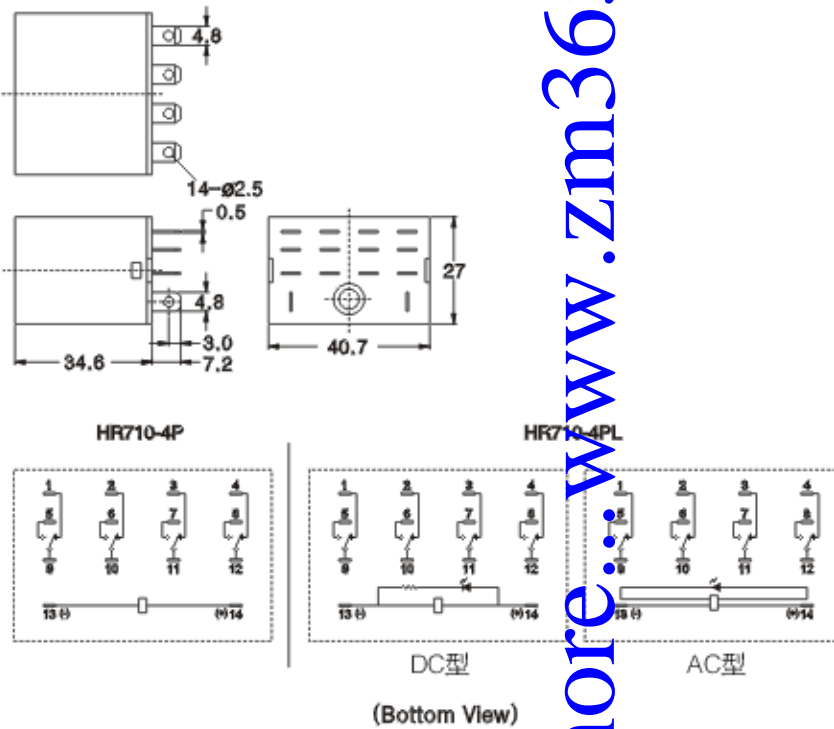

HR710-□LC/LD

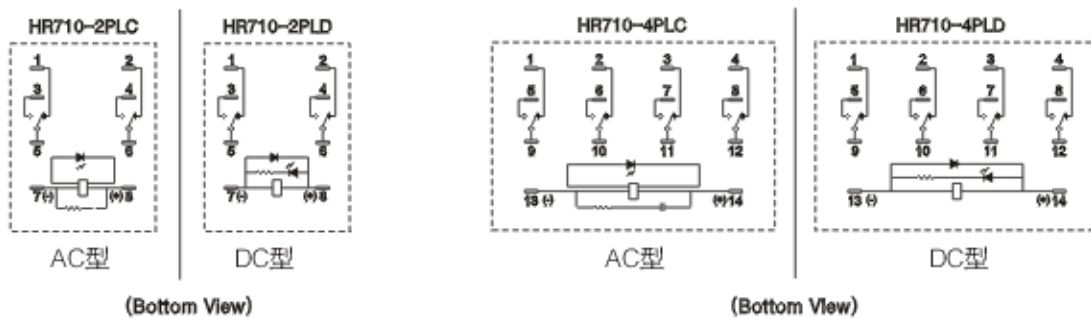

more: www.zm365.com