



## RockStar® 重载接插件产品详细目录

## 魏德米勒 —— 工业联接的伙伴

作为有着多年丰富经验的工业联接专家，魏德米勒在电源、信号以及数据处理的工业环境里，为全球的客户和合作伙伴提供产品、解决方案和服务。魏德米勒扎根于这些行业和市场，对于未来的技术挑战胸有成竹。魏德米勒坚持发展之路，为满足客户的不同需求，提供创新、可持续发展和高效的解决方案。正是如此，魏德米勒为整个工业联接设立了行业标准。目前，魏德米勒集团公司在全球80多个国家设有生产制造工厂、销售公司及办事处。

**魏德米勒电联接国际贸易(上海)有限公司**成立于2001年7月，是魏德米勒集团服务于中国市场的销售服务机构，拥有覆盖全国的销售网络和完善的售后服务体系，全国设有16个销售办事处，可以为中国市场的客户提供专业的行业应用解决方案和优质的产品。同时，在上海外高桥保税区，魏德米勒拥有一个超过8,000平方米的物流仓储中心和产品加工中心，满足客户的实际需求。

**魏德米勒电联接(苏州)有限公司**成立于2003年8月，厂房面积近20,000平方米，是魏德米勒集团全球三大生产基地之一，拥有先进的生产技术、便捷的物流支持和科学的管理体系。目前主要为中国、亚太以及全球市场的客户生产包括接线端子、工具、重载接插件、电子产品、PCB联接件及其他客户定制产品。

2010年为了更深入地了解并快速响应本土市场，魏德米勒在中国分别建立**上海卓越中心**和**苏州卓越中心**，负责研发电子产品和电气联接产品。2011年魏德米勒亚太物流中心项目正式启动，更好地实施魏德米勒集团2020战略。2012年成立香港销售公司。

## 领先的联接技术

- 多种接线技术，齐全的产品系列，为您提供整套电气联接、传输领域的解决方案，还为工业环境提供电源、信号和数据处理等工作条件。
- 拥有全球领先的电联接技术，多达1,150项专利技术应用，保证您获得世界领先的产品。
- 专业的研发团队，为您度身定制开发新品。

## 卓越的产品质量

- 位于苏州的生产制造工厂严格遵守魏德米勒全球标准化生产管理。
- 开关柜内外部的电联接产品和功能电子产品，具有五年质保，成为客户首选。
- 使用通讯电子产品帮助优化智能网络中离散式自动化系统解决方案。

## 高效的服务支持

- 实时网上产品查询、订货系统，实现快速、高效的客户服务。
- 位于上海超过8,000平方米的亚太物流仓储中心拥有充裕齐全的备货，确保最短时间发货。

## 全面的行业应用

- 为机械、电力、轨道交通、过程控制等行业提供专家级的电气应用解决方案。
- 具有丰富经验的行业应用工程师团队为您提供贯穿项目生命周期的全方位的服务支持。

## 专业的技术团队

- 分布于上海、北京、广州、成都、天津、西安、深圳、香港、杭州、武汉、厦门、沈阳、南京、无锡、青岛和长沙多达200多位技术支持和专业销售人员为您提供专业、及时的现场服务。
- 魏德米勒位于上海的亚太培训中心为销售团队以及客户提供全面的产品和技术培训，优秀的销售团队能够为您提供专业的技术支持。



① 上海销售服务总部  
② 苏州生产制造基地

③ 苏州质量测试实验室  
④ 外高桥保税区亚太物流仓储及加工中心

⑤ 外高桥保税区亚太培训中心

魏德米勒是为电气联接、传输领域和工业环境提供电源、信号及数据处理等工作条件的国际领先解决方案供应商。

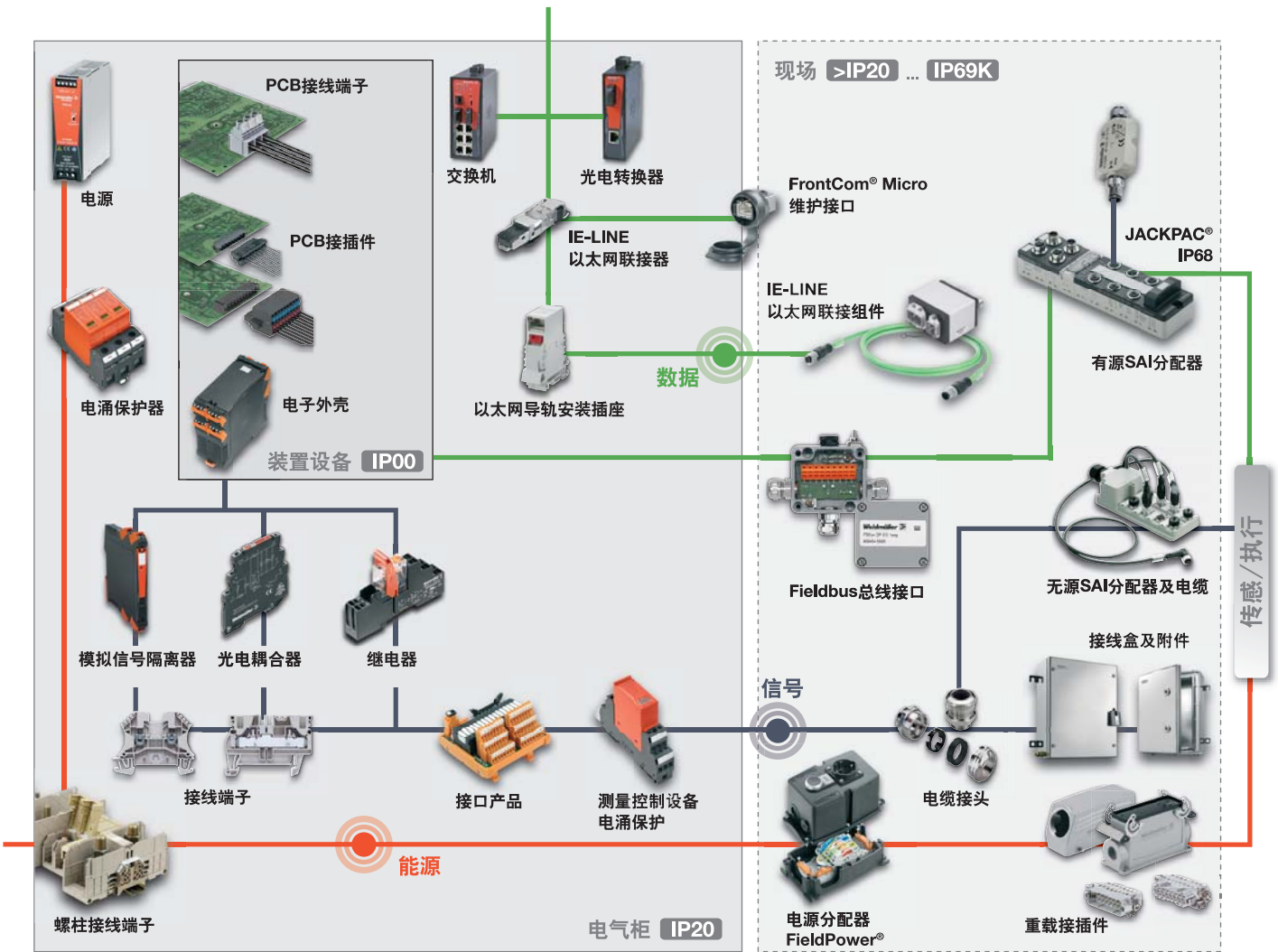

### 工具及标记号



### 客户特定应用解决方案



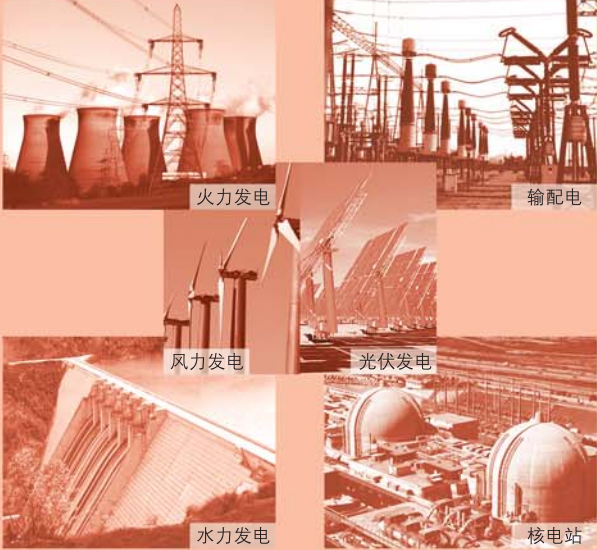

火力发电 输配电  
风力发电 光伏发电  
水力发电 核电站

### 电力行业

**典型应用案例**

- 四川瀑布沟水电站
- 嘉兴方家山核电站
- 新疆天龙火电站
- 伊朗燃油燃气空冷电厂
- 辽宁红沿河核电站项目
- 大安红岗子风电场
- 哈尔滨依兰风电场
- 国华通辽太平沼风电场
- 无锡尚德
- 常州天合

\* 更多电力行业应用信息，请与魏德米勒公司联系



机床 注塑机械  
纺织机械 港口机械  
电梯

### 机械行业

**典型应用案例**

- 三一重工
- 中联重科
- 徐工集团
- 太原重工
- 振华港机
- 利乐食品机械
- 特吕茨勒纺织机械
- 德马格起重机械
- 海达塑料机械
- 通力电梯
- 三菱电梯
- 蒂森克虏伯电梯
- 西子奥的斯电梯
- 上海新时达电梯

\* 更多机械行业应用信息，请与魏德米勒公司联系



磁悬浮 地铁  
动车组 铁路信号通讯  
机车

### 交通行业

**典型应用案例**

- 北京地铁4、5、10号线
- 广州地铁3、4、5号线
- 上海地铁4号线、1及2号线延伸段
- 大同电力机车
- 青藏线车辆
- 京津300km/h动车组
- 青岛四方-庞巴迪-鲍尔公司动车组
- 唐车CRH3动车组项目
- 天津地铁1号线、深圳地铁1号线
- 重庆地铁、成都地铁

\* 更多交通行业应用信息，请与魏德米勒公司联系



化工 污水处理  
水泥 石油  
冶金

### 过程控制行业

**典型应用案例**

- 中海石油壳牌南海乙烯项目
- 辽宁华锦化工集团乙烯原料项目
- 涩宁兰输气管线项目
- 惠州炼油项目
- 宝钢硅钢一、二期项目
- 宝钢八钢炼钢项目
- 八钢中厚板项目
- 华润平南水泥
- 闵行源江水厂
- 上海嘉北水厂

\* 更多过程控制行业应用信息，请与魏德米勒公司联系

HA系列 - 小型插芯  
B4页



HA系列 - 小型插芯  
B8页



HE系列 - 通用型插芯  
B18页



HEE系列 - 紧凑型插芯  
B32页



HD系列 - 高密度型插芯  
B42页



HD系列 - 高密度型插芯  
B46页



HDD系列 - 超高密度型插芯  
B66页



HVE系列 - 高电压型插芯  
B80页



HSB系列 - 高电流型插芯  
B88页



MixMate S4系列 - 混合型插芯  
B96页



MixMate S4/10系列 - 混合型插芯  
B99页



MixMate S6/12系列 - 混合型插芯  
B101页



MixMate S6/6系列 - 混合型插芯  
B103页



HQ高能小插芯  
B117页



HQ系列 - 4+2  
B126页



ConCept模块系统  
C3页



ConCept总线模块  
C13页



CSB  
C15页



RockStar IP65外壳  
D4页



HQ外壳  
D8页



RockStar® HDC IP68新外壳  
E2页



RockStar套件  
F4页



电伴随加热连接器  
G3页



电缆接头  
J2页



# 总目录

章节

A

B

C

D

E

F

G

H

I

J

RockStar® 重载接插件产品详细目录
-----------------------

HDC总揽
RockStar® 插芯
RockStar® Concept 模块系统
RockStar® 外壳 IP65/NEMA 4X
RockStar® HDC IP68新外壳
RockStar® 套件
RockStar® 电伴随加热连接器
RockStar® 高电流接插件
RockStar® 零配件
电缆接头

X

索引
----

根据订货号索引
---------

## HDC总揽

## 选型指南

HDC构成 – 普通插芯	A.2
尺寸1 – 普通插芯	A.3
尺寸2, 5, 7, 9 – 普通插芯	A.4
尺寸3, 4, 6, 8, 10, 12 – 普通插芯	A.5
重载接插件 – 模块插芯结构	A.6
尺寸3, 4, 6, 8, 10, 12 – 模块插芯	A.7
IP防护等级(根据DIN EN 60529)	A.8
NEMA防护等级	A.9
RockStar外壳类型	A.10
锁紧系统	A.11
插芯和防尘盖编码说明	A.12
外壳编码说明	A.13

## 技术参数

联接系统	A.14
电气参数	A.16
防化学污染/安全信息和标准	A.20
松拧工具和螺钉工具	A.21
HDC穿体式外壳开孔尺寸 – 览表	A.22

## HDC构成—普通插芯

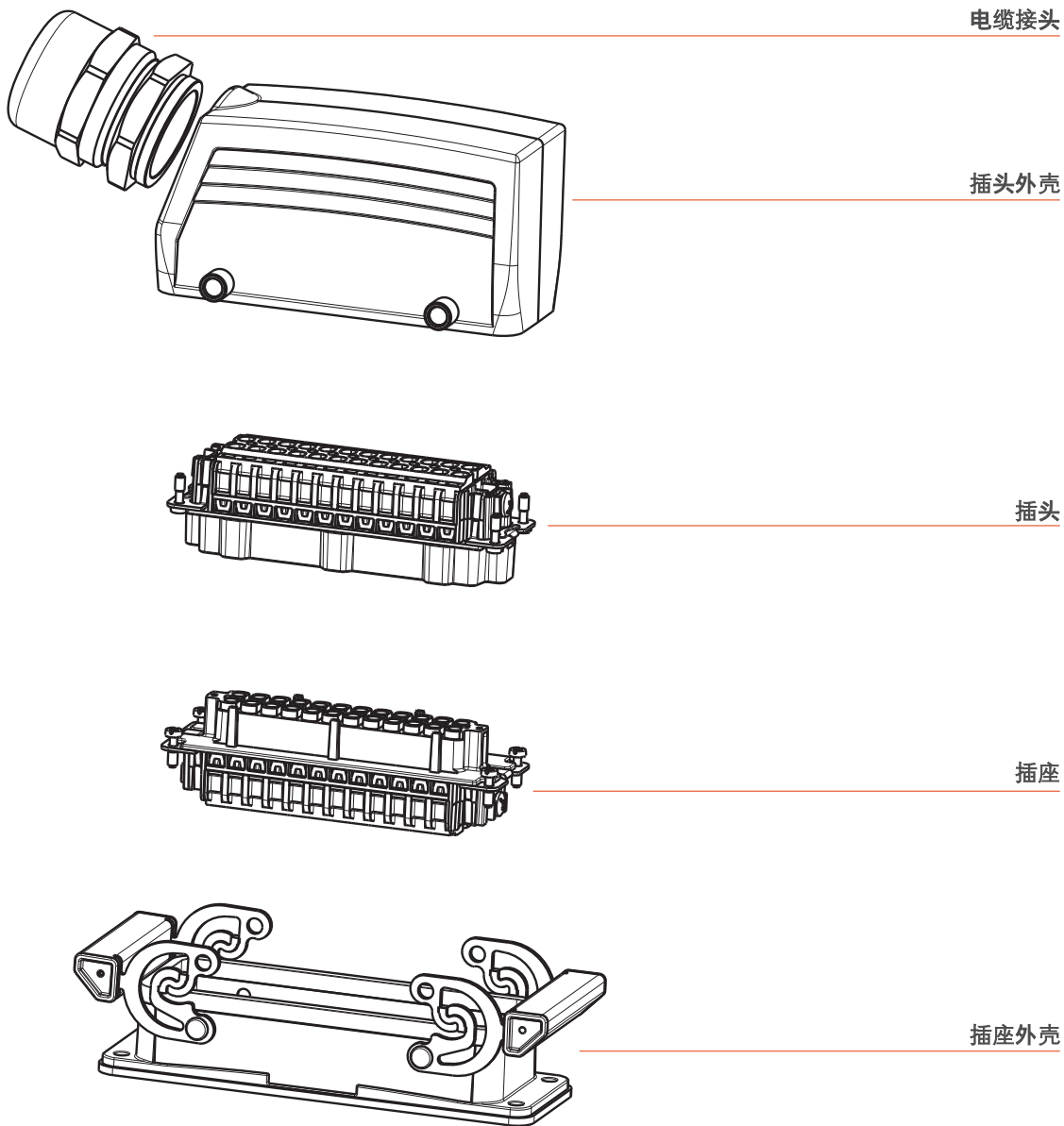



# 尺寸1—普通插芯

尺寸

1

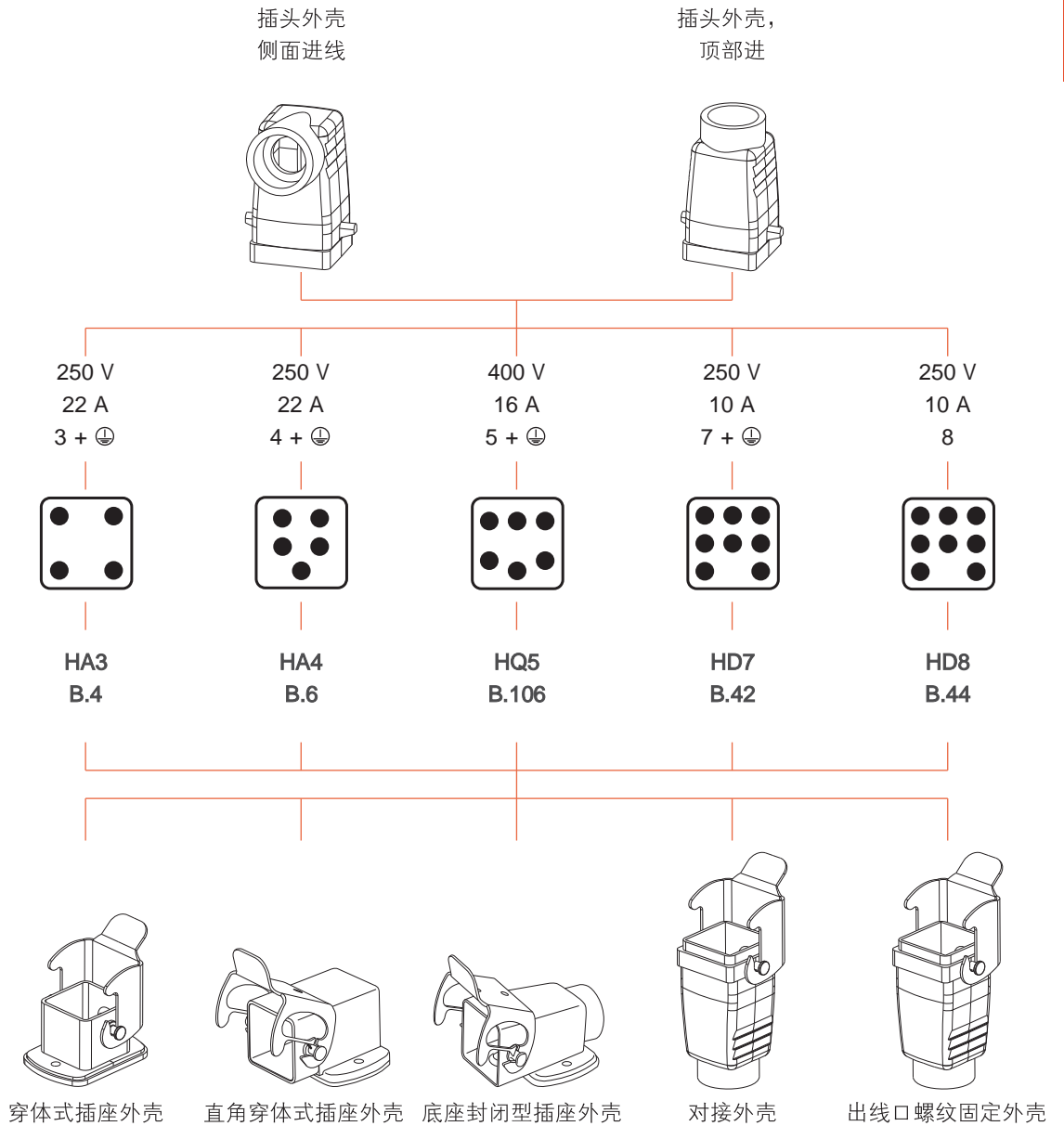

# 尺寸2, 5, 7, 9—普通插芯

尺寸

插头外壳，侧面进线

插头外壳，顶部进线

2

5

7

9

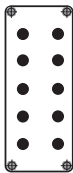
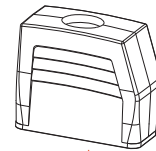
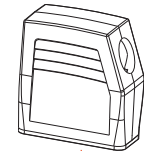

250 V  
22 A  
10 + ⊕

HA10  
B.8



250 V  
10 A  
15 + ⊕

HD15  
B.46



250 V  
22 A  
16 + ⊕

HA16  
B.10



250 V  
10 A  
25 + ⊕

HD25  
B.52

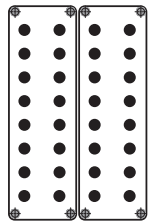

250 V  
16 A  
32 + ⊕

HA32  
B.12

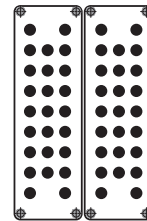

250 V  
10 A  
50 + ⊕

HD50  
B.56

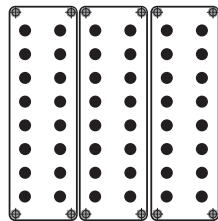

250 V  
16 A  
48 + ⊕

HA48  
B.14

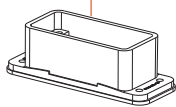

穿体式插座外壳

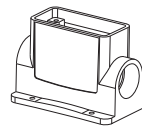

底座封闭式插座外壳

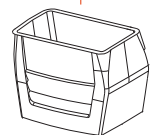

对接外壳

# 尺寸3, 4, 6, 8, 10, 12—普通插芯

Size

插头外壳，侧面进线

插头外壳，顶部进线

3

	500 V 24 A 6 + ⊕		500 V 16 A 10 + ⊕		250 V 10 A 16 + ⊕		250 V 10 A 24 + ⊕		1000 V 65 A 4 + ⊕
	HE6 B.18		HEE10 B.32		HD16 B.48		HDD24 B.66		S4 B.96

4

	500 V 16 A 10 + ⊕		500 V 16 A 18 + ⊕		250 V 10 A 24 + ⊕		250 V 10 A 42 + ⊕		830 V 24 A 3+2+ ⊕
	HE10 B.20		HEE18 B.34		HD24 B.50		HDD42 B.68		HVE3 B.80

6

	500 V 16 A 16 + ⊕		500 V 16 A 32 + ⊕		250 V 10 A 40 + ⊕		250 V 10 A 72 + ⊕		830 V 23 A 6+2+ ⊕		400 V 35 A 6 + ⊕		630 V 80 A 4+0+ ⊕
	HE16 B.22		HEE32 B.36		HD40 B.54		HDD72 B.70		HVE6 B.82		HSB6 B.88		S4/0 B.98

8

	500 V 16 A 24 + ⊕		500 V 16 A 46 + ⊕		250 V 10 A 64 + ⊕		250 V 10 A 108 + ⊕		830 V 23 A 10+2+ ⊕		630 V 100 A 6+6+ ⊕		630 V 48 A 6+12+ ⊕
	HE24 B.24		HEE46 B.38		HD64 B.58		HDD108 B.72		HVE10 B.84		S6/6 B.102		S6/12 B.100

10

	500 V 16 A 32 + ⊕		250 V 10 A 80 + ⊕		250 V 10 A 144 + ⊕		400 V 35 A 12 + ⊕
	HE32 B.26		HD80 B.60		HDD144 B.74		HSB12 B.90

12

	500 V 16 A 48 + ⊕		250 V 10 A 128 + ⊕		250 V 10 A 216 + ⊕
	HE48 B.28		HD128 B.62		HDD216 B.76

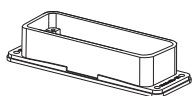

穿体式插座外壳

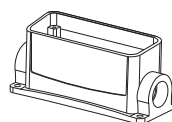

底座封闭型插座外壳

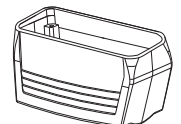

对接外壳

## 重载接插件—模块插芯结构

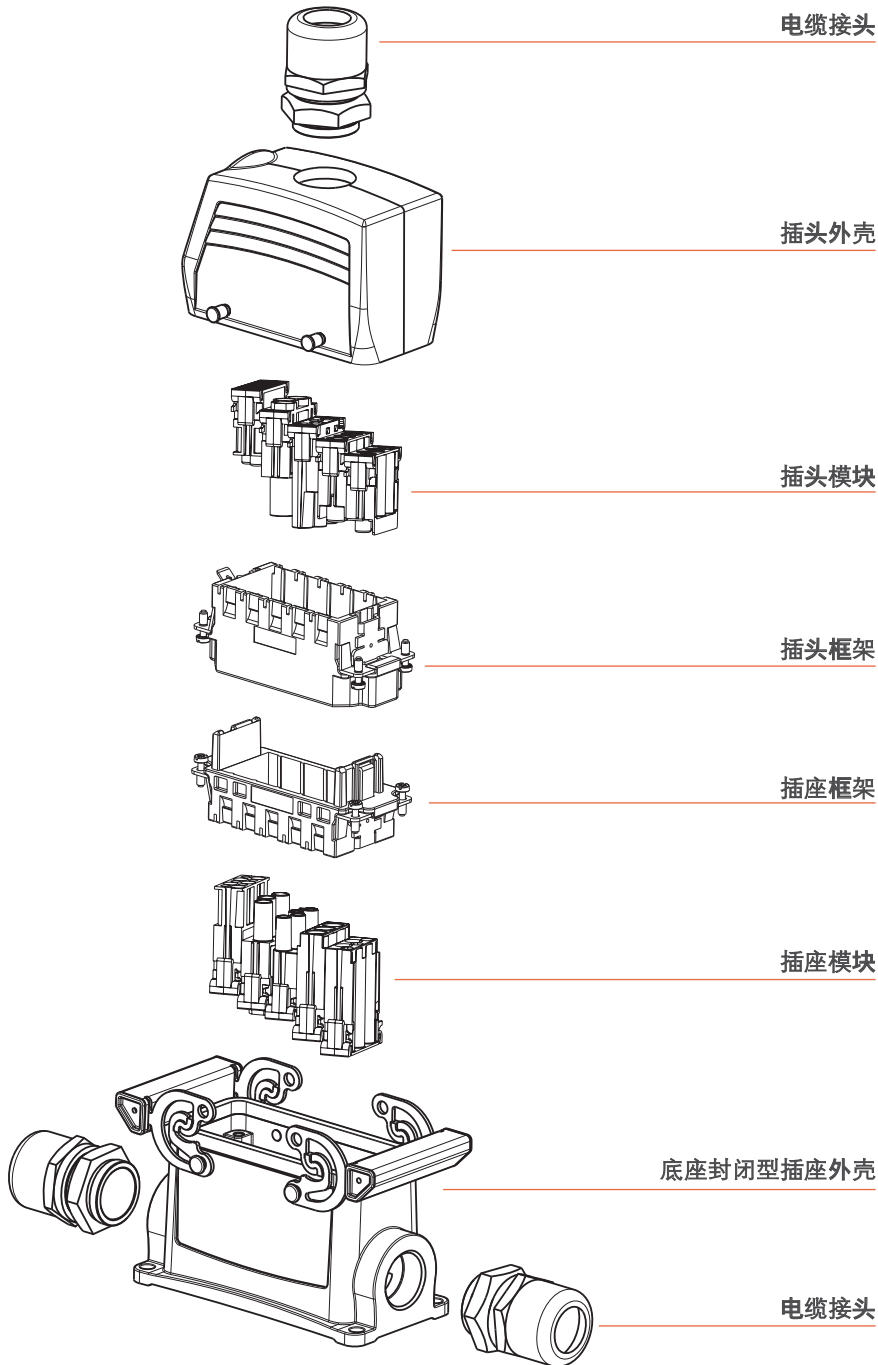

# 尺寸3, 4, 6, 8, 10, 12—模块插芯

尺寸

插头外壳，侧面进线

插头外壳，顶部进线

630 V 40 A 3	630 V 25 A 4	400 V 14 A 4	250 V 20 A 5	250 V 10 A 10	100 V 4 A 20	1000 V 82 A 2	1000 V 57 A 3	10 bar 1	10 bar 2	30 V 1 A	50 V 10 A 2×4
CM 3 C.3	CM HE C.4	CM 4 C.5	CM 5 C.6	CM 10 C.7	CM 20 C.8	CM HC C.10	CM 3 HV C.9	CM PN 1 C.11	CM PN 2 C.11	CM BUS 4 C.14	CM BUS M2 C.16

3

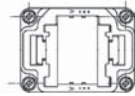

CF6—可装2个模块

4

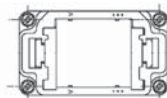

CF10—可装3个模块

6



CF16—可装5个模块

8



CF24—可装7个模块

10

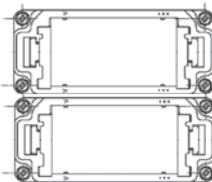

2XCF16—可装10个模块

12



2XCF24—可装14个模块

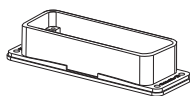

穿体式插座外壳

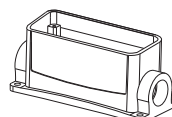

底座封闭型插座外壳

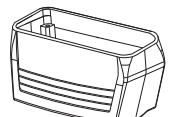

对接外壳

# IP防护等级 (根据DIN EN 60529)

防护等级的描述由两个字母“IP”加2位数字组成

例如:

**I P 6 5**

第二位数: 防液体侵入级别  
第一位数: 防固体侵入级别

## 第一位数: 防固体物侵入的级别

数字	图标	描述
0		无防护
1		防护大于50mm的物体 (如手背)
2		防护大于12.5mm的物体 (如手指)
3		防护大于2.5mm的物体 (如工具或导线)
4		防护大于1.0mm的物体 (如导线或细棍)
5		防护足以造成危害的粉尘侵入
6		粉尘无法侵入

## 第二位数: 防液体侵入级别

数字	图标	描述
0		无防护
1		防护垂直滴水 (如凝结液)
2		防护下滴倾斜角度小于15度的滴水
3		防护下滴倾斜角度小于60度的滴水
4		防护来自各个方向的溅水
5		防护来自各个方向的水柱
6		防护水塘或高洒水柱
7		埋于水中150mm-1m深, 防止水的侵入
8		埋于水中, 适合长时间浸于水中

# NEMA防护等级

美国国家电气制造商协会——NEMA标准250 - 1991

数字

**数字1**

外壳置于室内使用，可防护固体物的侵入

**数字2**

外壳置于室内使用，可防护固体物和水侵入

**数字3**

外壳置于室外使用，可防护雨，雪，灰尘和冰

**数字3R**

外壳置于室外使用，可防护雨，雪，冰雹

**数字3S**

外壳置于室外使用，可同时防护雨，雪以及外部物体，且外部机械系统可在结冰情况下正常运转。

**数字4**

外壳置于室内和室外使用，可同时防护雨，外部物体，喷水，溅水和冰雹

**数字 4X**

外壳置于室内和室外使用，可同时防护腐蚀，雨，外部物体，喷水，溅水和冰雹

**数字6**

外壳置于室内和室外使用，可防护喷水，水浸，外部物体和冰雹等

数字

**数字12**

外壳置于室内使用，可防护灰尘沉积和无腐蚀性的滴水。

**数字13**

外壳置于室内使用，可防护灰尘沉积，喷水，油和无腐蚀性的冷冻液。

# RockStar 外壳类型

## IP65/IP66 NEMA 4X 外壳



魏德米勒更进一步发展了其 IP65/IP66 外壳。新设计的外壳同样具备了防腐功能以及使用寿命长的特点。这些新型 HDC 外壳甚至在各方面都超越了我们之前的防腐外壳产品。现在所有的可操作部件都是不锈钢的。高品质，多层表面处理的产品使其达到长期的安全性。我们的水准不是一个好字就可以形容得了的。这就是为什么魏德米勒不继续其防腐产品系列的生产，同时也是您选择我们新型的 IP65/IP66 外壳的理由。

### 应用场合：

- 机械工程
- 传送设备及工厂工程
- 包装机械，灯光和舞台设备
- 露天交通工具
- 过程工程
- 运输及交通工程

### 特点：

- 至少达到IP65/IP66 (根据EN60529:1991+A1:2000)
- 至少达到NEMA 4X
- 防划痕，防腐，经久耐用

### 设计：

- 铝合金浇铸
- 2种型号 (标准和加高型)
- 多层表面处理，
- 颜色：灰色

### 锁紧系统：

- 不同的防尘不锈钢锁扣

## IP69K外壳——高密封性



IP69K外壳专为极端环境所设计。高等级防护允许其在交通工具和恶劣天气环境下正常运行。如果您想要不受电磁辐射的干扰，这些连接器是您的不二选择。

### 应用场合：

- 运输及交通工程
- 对于保护等级有高要求
- 军事通讯工程

### 特点：

- 至少达到IP69K (根据DIN40050 PART9 1993)
- 防护来自各个方向的高压溅水
- 至少达到IP68/5 bar (根据60529(1991)+part A1(2000))
- 防划痕，防腐，经久耐用

### 设计：

- 铝合金浇铸
- 2种型号 (标准和加高型)
- 外壳有金属套圈
- 电磁保护系列型号
- 外涂高效多元树脂，
- 颜色：黑色

### 锁紧系统：

- 螺钉锁紧



# 锁定系统

## 端部锁定



- 手动操作——无需工具
- 轴向两个锁紧点
- 方便与侧面进线搭配使用
- 特别适用于轴向多个接插件一起使用
- 防腐蚀不锈钢锁扣

## 中间锁定



- 手动操作——无需工具
- 轴向两个锁紧点
- 当空间较小时
- 可方便得从顶部操作锁定
- 方便与侧向进线搭配使用，防腐蚀不锈钢锁扣

## 侧边锁定



- 手动操作——无需工具
- 四个锁定点——密封性高
- 方便与顶部进线搭配使用
- 特别适用于任向多个接插件一起使用
- 防腐蚀不锈钢锁扣

## 螺栓锁定



- 使用螺丝刀操作
- 高密封性
- 轴向2个锁定点
- 特别适用于多个接插件一起使用（不受方向限制）
- 不锈钢螺栓

# 插芯和防尘盖编码说明

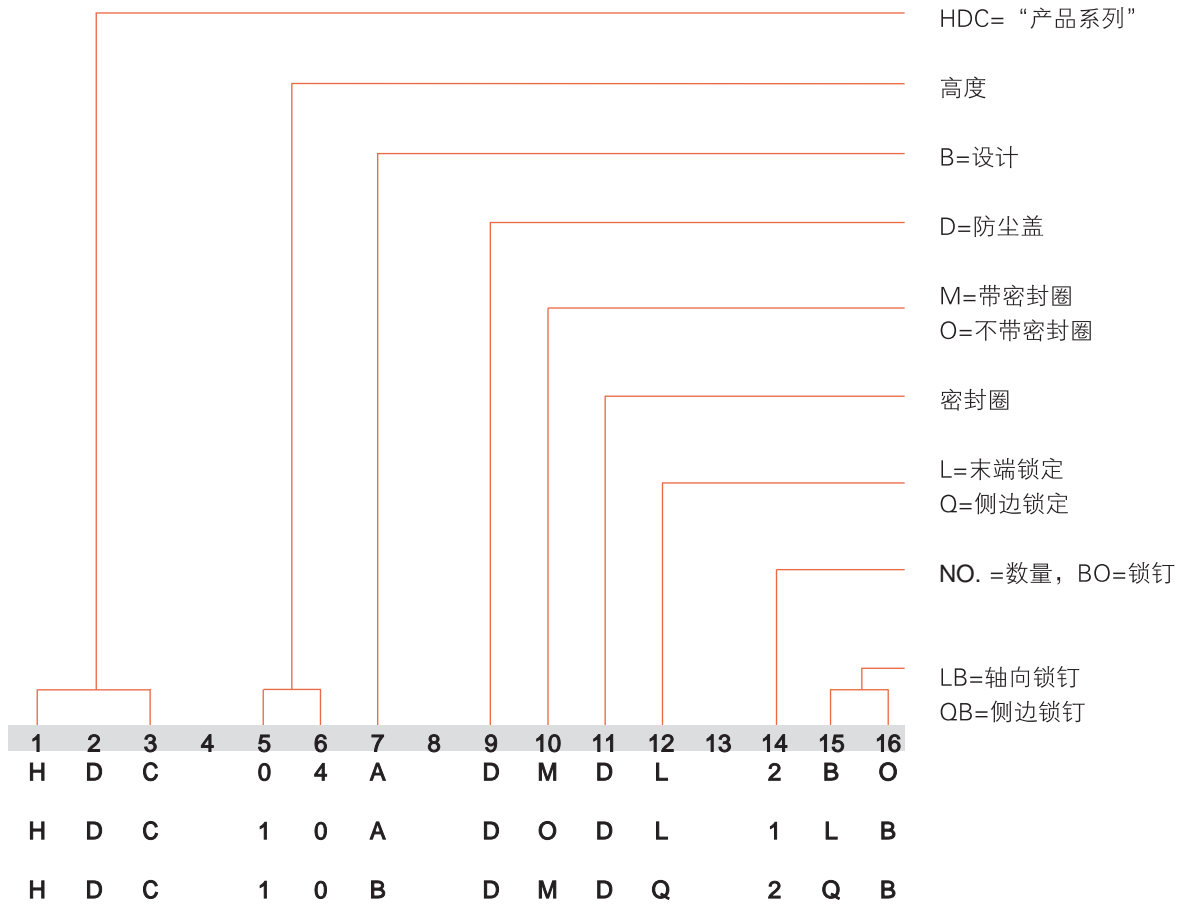
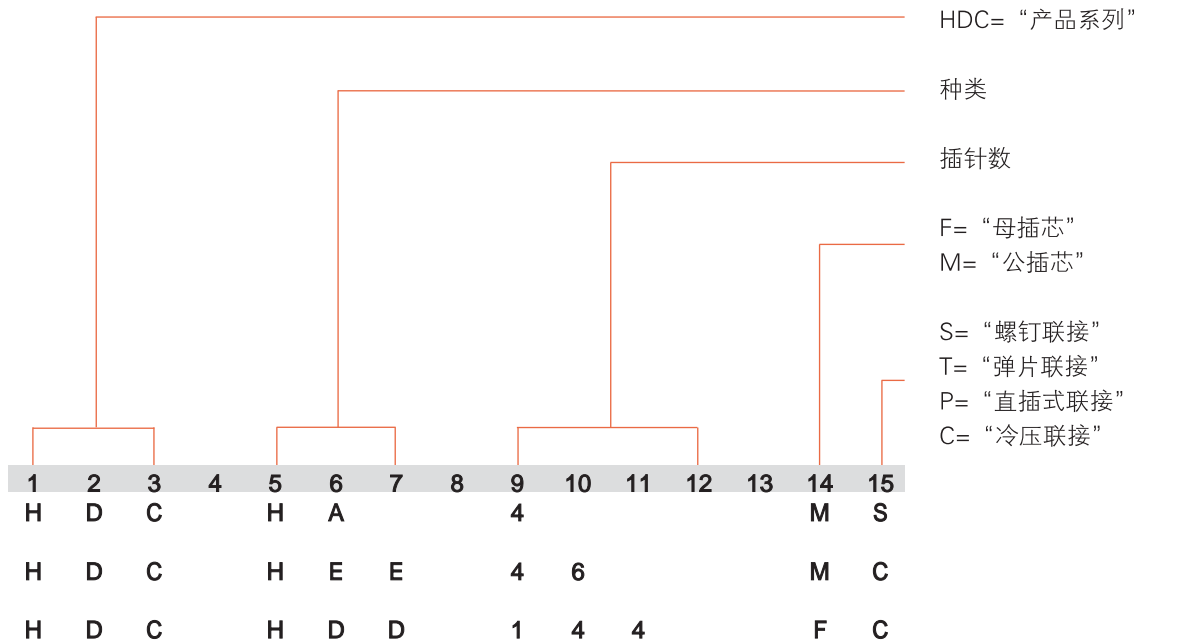

# 外壳编码说明

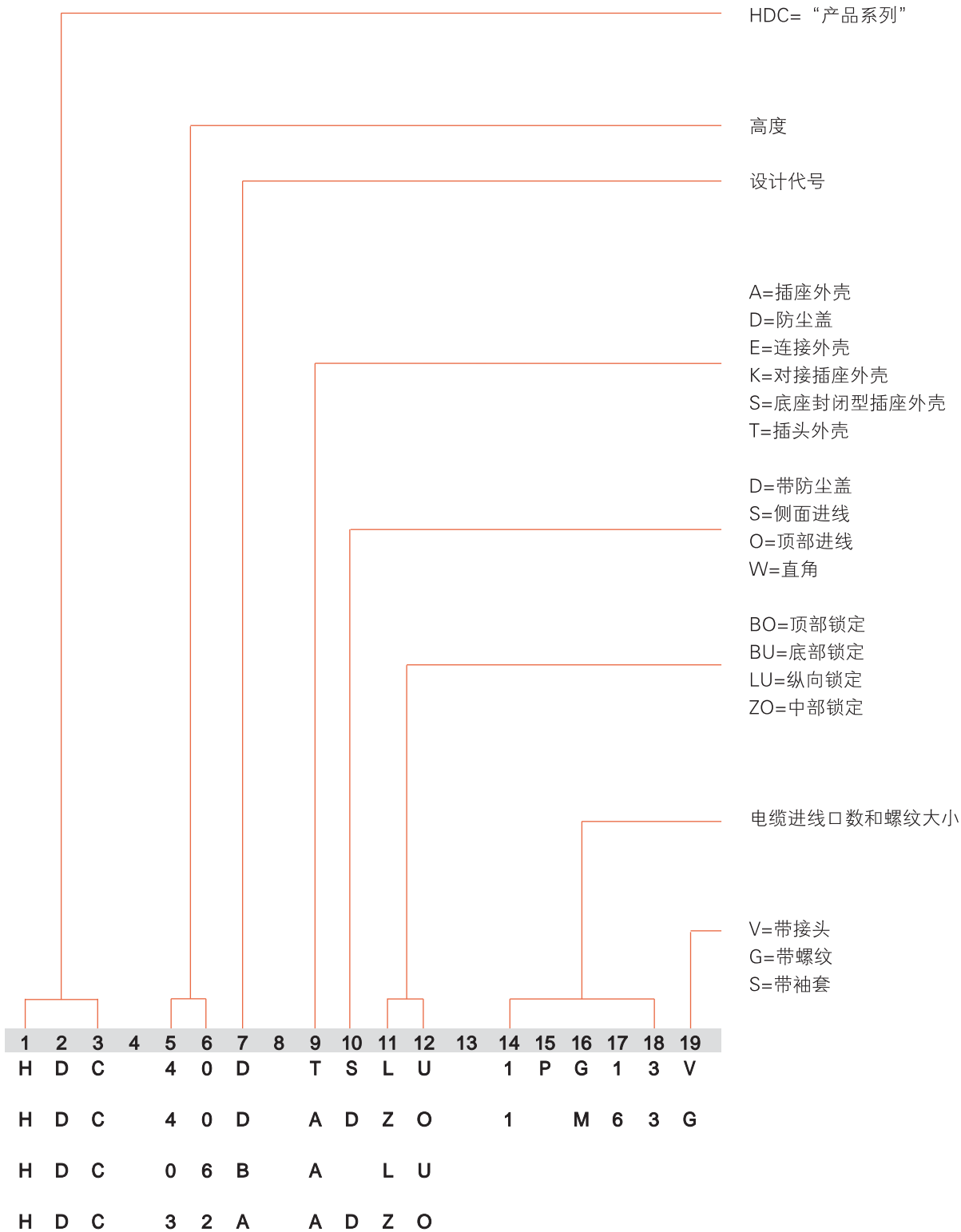

## 联接系统

### 魏德米勒的RockStar接插件有5种不同的联接系统

5种常用的联接方式：弹片式联接，螺钉联接，冷压联接，轴向螺钉联接与直插式联接技术。

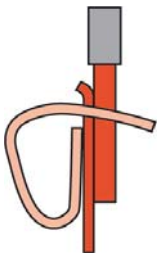

**弹片式联接：**魏德米勒弹片系统的工作方式与久经考验证明的弹片压线框相似。在此又得提到，机械与电气工作状态是分开的。弹片是由高质量的防尘与防酸钢制成，而导电部分是镀锌的铜做成。铜片这样处理，就使其接触电阻小，抗腐蚀性强。弹片的补偿作用使接线点接触很安全

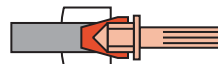

**轴向螺钉联接**的优点在于插针的占用空间很小。这增加了爬电距离并改善了电流传输。轴向螺钉联接的使用也非常简单。要完成联接，需将工具和需要联接的物体轴向放置。只需要三个步骤就可以完成联接：剥线，将螺插入插针槽，将插针拧紧——轻松搞定！

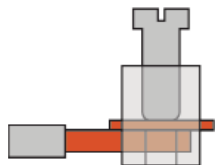

**螺钉垫片连接：**魏德米勒螺钉系统由无铁的 CuZn 材料制成。它们抗腐蚀，因为它们的钝化银表面具有保护层，可抵抗变形，防止导线的散开以及抵抗弹片螺钉的碰击。有了这一弹片系统，可以与导线间紧密，防震的联接。这一弹片系统已经在魏德米勒产品中证明了自己。

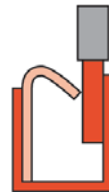

**直插式系统：**在直插式系统中，只要将剥好的硬导线，轻松插入就可以了。这样就完成了联接！无需工具就可以完成可靠，防震，紧密的联接。带管状端头或铠装的导线，也可以准确无误的联接。置于单独的外框内的不锈钢压缩弹片保证了导线与导电片（镀锌铜片）间的压力。相对于弹片连接，这一系统所需的拉出力更高。弹片与导线放置在一个钢质小外框里保证了其最佳的联接，同时也可以为螺丝刀用作拆卸时提供帮助。



在冷压联接中，电缆置于一个金属外套里，用一个特殊的工具将其压在一起。这一联接方式防腐抗震。插针可以预接线然后再放入插芯中。

**冷压插针：**除了螺钉联接，轴向螺钉联接，弹片联接与直插式联接，客户也可以选择适合于冷压联接的插针。插针是接插件的关键部分。它们缔造了准确的联接。我们需要两种插针：插头式与插座式（公的，母的）。插头式的电气电流流于其外表面，而插座式的电流流于其内表面。重载接插件有铜合金插针，插针表面镀有金或银：银提高了其导电性，金使其具有防腐性。



### 镀金或镀银插针的选择

当在一般情况下利用插拔式接插件时，插针之间的作用力很小。就算是已遭到腐蚀的镀银插针（针头式与插座式）都很少会遇到问题。

这一情况会因为在小电流特殊应用时变得不同，比如在电子商店，隧道或纤维处理。插针表面的镀银氧气层形成了强力，具感应及高电阻的电气抗力。所以，原信号大大得失真，导致了接收体不能很准确得进行检测和转换。这一结果间接地对机器运作和处理过程产生了错误。镀金插针适用于这样的情况。

使用规则：电流 < 5mA, 电压 < 5V 时使用镀金插针

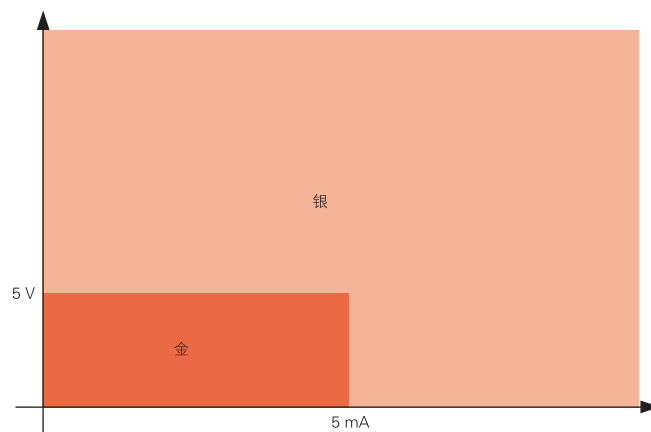

# 电气参数

为电气设备设计爬电距离

## 总概

从1997年开始，爬电距离的大小根据DIN VDE0110，第一部分“低电压系统电气设备的绝缘标准”确定。DIN VDE0110，第一部分包括了IEC Report 664 - 1(IEC 664 - 1/Oct 1992)。

2003年四月起，电气间隙和爬电距离由DIN EN 60664 - 1/11.03与DIN 61984/09.02共同制定。

设计参数由这些标准决定——如果可以应用——会在每个产品目录中加以详述。

为了设计电气间隙和爬电距离，绝缘规格有以下规定：

## 电气间隙

电气间隙根据以下几点决定：

根据额定脉冲电压预设电压：

- 过压保护预警
- 污染级别
- 爬电距离

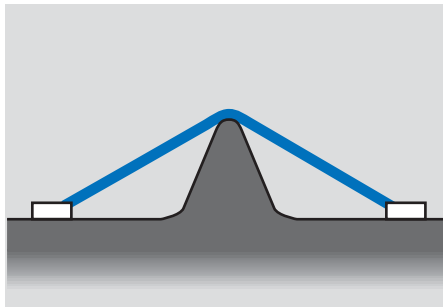

## 爬电距离

漏电距离根据以下几点决定：

- 额定电压
- 绝缘组
- 污染级别
- 在测量爬电距离时，如果它们的最小宽度与以下表格吻合，需将缝隙考虑在内。

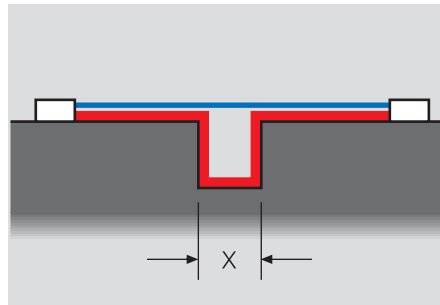
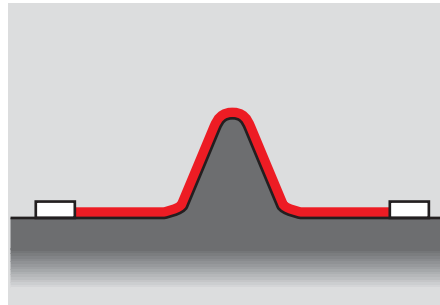

在测量爬电距离时，如果它们的最小宽度与以下表格吻合，需将缝隙考虑在内。

污染级别	污染等级最小宽度 单位：mm
1	0.25
2	1.0
3	1.5
4	2.5

如果设想的爬电距离小于3mm时，最小的缝隙为间隔距离的3分之2。

## 影响因素

### 额定脉冲电压由以下几点决定：

对地电压（网络的额定电压,需将所有的网络均考虑在内）

### 过压分类

过压类根据国际标准的DIN EN 60664-1(与低压网络直接连接的电气设备)。

#### 过压类1

- 联接在建筑物固定电气安装物上的设备。在设备外部，建筑物固定设备以及固定设备与联接设备之间需采取措施限制瞬间过压。

#### 过压类2

- 接在建筑物固定电气安装物上的设备。例如：家用电器，便携工具之类的东西。

#### 过压类3

- 设备是固体电气安装物或其他比较容易被触及一部分，例如：在固定安装物，工业应用设备与其他设备（例如：永久联接于固体安装物上的静态电动机）中的输线板，断路器，电缆系统 (IEV 826-06-01, 包括了电缆接头，总线，集线盒，开关，电源插座)。

#### 过压类4

- 装有主输线板的建筑物电气安装物的电源供应点处的设备，例如：电器仪表，断路器和浮动控制单元。

## 污染分类：

### 污染等级1

- 无污染，只有无影响的干燥无导电性污染

### 污染等级2

- 只有无导电性的污染；偶尔凝结会导致暂时导电。

### 污染等级3

- 导电污染，或者是干燥的无导电性的污染，但通过凝结会变成导电。

### 污染等级4

- 污损导致了连续导电，例如：由导电灰尘，雨雪引起。

间隔距离和爬电距离的制定以及电磁产品（端子，端子拆卸工具，PCB端子和插拔式接插件）的额定参数是根据污染等级3和过压类3决定的（考虑了所有的网络类型）

表格1：三相四线或三相三线的交流系统

电源系统的额定电压 [V]	用于导体或绝缘体		
	所有系统 [V]	用于接地绝缘	
		带中线的三相四线系统 [V]	不带中线或带导电中线的三相四线系统 [V]
60	63	32	63
110	125	80	125
120			
127			
150	160	125	160
208	200		200
220	250	160	250
230			
240			
300			
380	400	250	400
400			
415			
440	500	250	500
480	500	320	500
500			
575	630	400	630
600	630	400	630
660	630		630
690			
720			
830			
960	1000	630	1000
1000	1000		1000

# 电气参数

电气设备的电气间隙和爬电距离设计，

影响因素：

## 额定电压

额定电压由电源的额定电压与相应的网络类型决定。

## 绝缘材料

绝缘材料根据他们的CTI (相比漏电起痕指数)

## 绝缘材料

I	600	CTI
II	400	CTI < 600
III a	175	CTI < 400
III b	100	CTI < 175

Z

单相  
2或3线直流或交流系统

电源的额定电压 (主要)*	表4的电压	
	绝缘体相电压 <sup>1)</sup>	绝缘体线电压
	所有系统	3线制公共接地点
	V	V
12.5	12.5	
24 / 25 30	25 32	
42 / 48 / 50 <sup>(*)</sup> 60	50 63	
30-60	63	32
100 <sup>(*)</sup>	100	
110 / 120 150 <sup>(*)</sup>	125 160	
220	250	
110-220 120-240	250	125
300 <sup>(*)</sup>	320	
220-440	500	250
600 <sup>(*)</sup>	630	
480-960	1000	500
1000 <sup>(*)</sup>	1000	

三相  
3相3线或4线交流系统

电源的额定电压 (主要)	表4的电压		
	绝缘体相电压	绝缘体线电压	
	所有系统	3相4线制 <sup>2)</sup>	3相4线制 <sup>1)</sup>
	V	V	V
60	63	32	63
110/120/127 150 <sup>(**)</sup>	125 160	80	125 160
208	200	125	200
220/230/240	250	160	250
300 <sup>(**)</sup>	320		320
380/400/415	400	250	400
440	500	250	500
480/500	500	320	500
575	630	400	630
600 <sup>(**)</sup>	630		630
660/690	630	400	630
720/830	800	500	800
960	1000	630	1000
1000 <sup>(**)</sup>	1000		1000

1) 不带中线或带接地电阻的相系统的绝缘程度与相相之间的绝缘程度是一样的。这是因为每相的工作电压实际上都能达到理论相电压值。而且由于实际的对地电压是由每相的接地绝缘阻抗和电容所决定的；因此，一相的低绝缘阻抗（仍可行）接地后，可以提高另外两相的相间对地电压。

2) 对于接地或不接地的3相4线和3相3线电气设备，只使用三线系统的电压值。

\*) 需保证电气设备的额定电压不低于电源的额定电压。

\*\*\*) 因为总会存在误差，表1不用标符\*\*，也就是说，“/”表示了3相4线离散系统。较低电压值为线电压，而较高的电压值为相电压。如果只提到一个电压值，那它指的是3相3线系统，并且所用的电压是相电压。表1的电压值仍需在表3a与表3b中用到标符\*\*。



这一下降曲线表明了当外部温度低于其上限温度时，电流会实时得连续不断地流过所有的连接部位。

元件的上限温度根据所用材料的额定值而决定。外部温度再加上电流负载（接触时的能量损耗）所引起的温度上升不能超过元件的上限温度，否则元件会损坏甚至报废。因此载流能力不是一个连续值，但是它会随着元件外部温度的增加而降低。而且，电流电容受元件形状，插针数和与之连接导体的影响。

电流电容根据DIN IEC 60512-3决定。为了达到这个目的，元件的温度 $t_{b1}, t_{b2}$ —以及其外部温度 $t_{u1}, t_{u2}$ 要在不同的电流 $I_1, I_2, I_3$ 状态下被测量。电流值标于以下线性图表上，表示了元件的电流，外部温度和温度增长的关系。

负载电流标于Y轴上，元件外部温度标于X轴上。上限温度 $t_g$ 用一条垂直于X轴的直线表示，这就完成了整个元件参数系统的说明。元件上升温度的理想平均值，标于电流曲线上，处于垂直线的左侧。这些点就构成了粗略的描述曲线。

因为我们不可能选择最大允许接触阻抗用于测量，所以基本曲线就需下降。据经验，将电流降为原来的80%就产生了下降曲线，这样就把最大允许接触阻抗和温度测量误差都考虑在内了，可以用于实际应用。如果下降曲线超过了外部低温区的电流，导致这一低温区的是连接跨度部分的载流能力，然后下降曲线在这一区域内的电流限定值需更小。

基本曲线

元器件上限温度

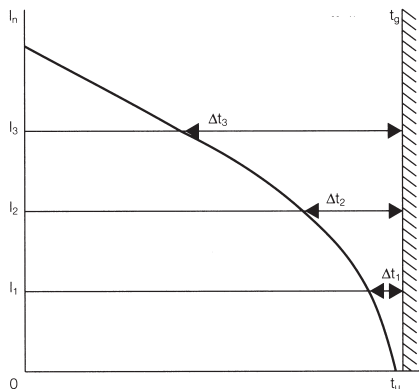

$t_g$  = 元器件上限温度  
 $t_u$  = 环境温度  
 $I_n$  = 电流

衰减温度

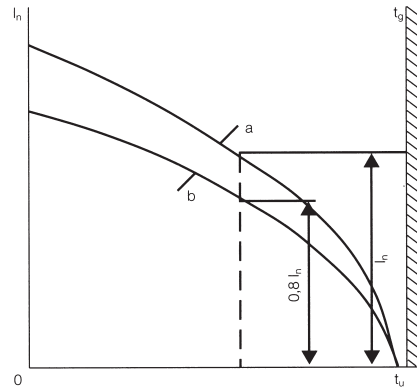

$t_g$  = 元器件上限温度  
 $t_u$  = 环境温度  
 $I_n$  = 电流  
a = 基本曲线  
b = 衰减曲线

## 防化学物质

插芯的防化学污染  
(材料PC,20%玻璃纤维)

丙酮	+
氨水	
汽油	+
石油精	+
柴油	
强酸	+
氢氧化钾	
甲醇	
机油	
稀释碱	+
氯化烃	-
户外使用	

标准外壳密封圈  
(材料NBR)

丙酮	
钴油	+
柴油	+
乙基酒精	+
齿轮油	+
水压油	+
冷却润滑油	+
汽油	+
汗水	+
高辛烷汽油	
水	+

+ 防护

- 部分防护

o 不防护

## 安全信息和标准

注意以下安全建议：

- 1) 不要在带电或运转中插拔接插件。
- 2) 我们承诺由魏德米勒所提供产品符合该样本的技术和电气技术参数。
- 3) 无需接线的部位请保持常开状态。

以下标准用于接插件附近：

- 1) DIN EN 60664-1或 IEC60664-1：针对低压系统装置的绝缘联接；原则要求和测试（代替DIN VDE 0110-1）
- 2) DIN EN 61984 IEC 61984：插入式接插件—全要求和测试
- 3) DIN EN 175301-801：细节说明：高密正方形插入型接插件，移动冷压联接（代替DIN43625）
- 4) DIN EN 60352 IEC 60352：非焊接联接
- 5) DIN EN 60529 IEC60529：密封件提供的防护等级(IP代码)
- 6) DIN VDE 0870：电磁干扰
- 7) DIN EN 60999-1：联接装置，针对螺钉联接，铜导体的非螺钉联接等等的安全要求
- 8) DIN 40050-9：道路车辆，防护等级
- 9) DIN EN 60664-1：插拔式接插件—安全要求和测试。

## 松拧工具和螺钉工具

螺钉尺寸	接插件类型	锁紧力矩 (Nm为单位)		推荐刀头与六角AF尺寸
M 2.5	S 6/6 和 S 6/12			
	接线点 单个插针	0.5	0.55	0.6 x 3.5 mm ± Gr. PZ0
M 3	螺钉连接			
	HA 3; HA 4; HQ 5	0.5	0.55	0.6 x 3.5 mm ± Gr. PZ0
M 3	螺钉连接			
	HA 10 - HA 48	0.5	0.55	0.6 x 3.5 mm ± Gr. PZ0
M 3	HE 螺钉连接			
	HVE 系列			
	锁紧螺钉	0.5	0.55	0.6 x 3.5 mm ± Gr. PZ0
	编码插针	0.5	0.55	0.6 x 3.5 mm ± Gr. PZ0
	编码插套	0.5	0.55	0.6 x 3.5 mm ± Gr. PZ0
M 4	编码销	0.4 - 0.5		0.6 x 3.5 mm ± Gr. PZ0
	PE 接地螺钉			
	HA 系列	1.2 - 1.5		0.6 x 3.5 or 0.8 x 4 mm ± Gr PZ1
	HE 系列	1.2 - 1.5		0.6 x 3.5 or 0.8 x 4 mm ± Gr PZ1
	HVE 系列	1.2 - 1.5		0.6 x 3.5 or 0.8 x 4 mm ± Gr PZ1
M 4	HD 系列	1.2 - 1.5		0.6 x 3.5 or 0.8 x 4 mm ± Gr PZ1
	HDD 系列	1.2 - 1.5		0.6 x 3.5 or 0.8 x 4 mm ± Gr PZ1
	螺钉连接			
	HSB 系列	1.2 - 1.5		0.6 x 3.5 or 0.8 x 4 mm ± Gr PZ1
	M 5	PE 接地螺钉		
HSB 系列		2 - 2.5		1 x 5.5 mm ± Gr. PZ2
M 7 x 0.75 S 4	同轴连接 (电力)	1.1	1.7	SW 2
M 4	S 4 PE 接地螺钉 (插针)	1.2	1.5	SD 0.6 x 3.5 mm
M 3	S 4 PE 接地螺钉 (插套)	0.5	0.55	SD 0.6 x 3.5 mm
M 7 x 0.75	S 6/6 同轴连接 (电力)	6	8	SW 4
M 8 x 0.75	S 6/12 同轴连接 (电力)	1.1	1.7	SW 2
M 10 x 1	S 4/0 同轴连接 (电力)	2	3	SW 3

拧得越紧并不表示越牢固。规定的拧紧尺度提供了最佳的机械，温度和电气状态。超过规定值甚至会损坏导体和接线端

## 穿体式插座外壳开孔尺寸图

IP65外壳

尺寸	型号
Size 1	04A/07A
Size 2	10A/15A
Size 3	06B/16D
Size 4	10B/24D
Size 5	16A/25A
Size 6	16B/40D

尺寸	型号
Size 7	32A
Size 8	24B/64D
Size 9	48A
Size 10	32B
Size 12	48B
HQ	

IP68外壳

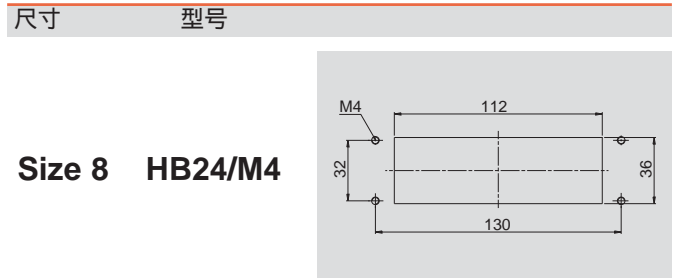
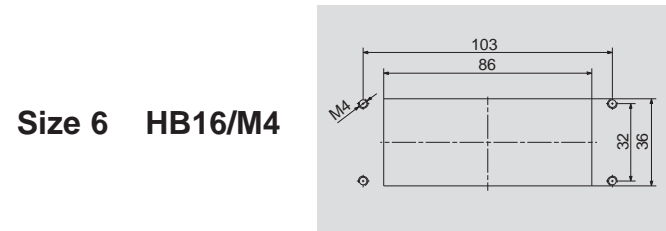
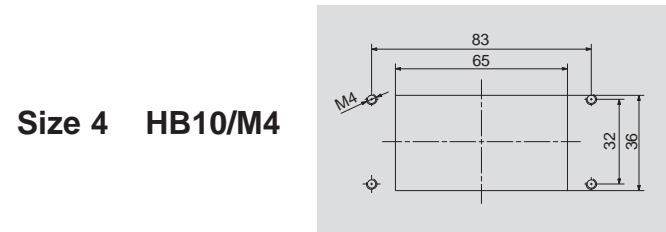
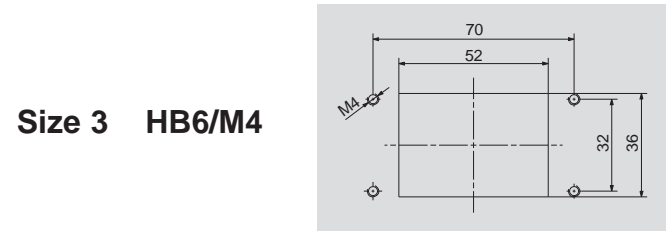
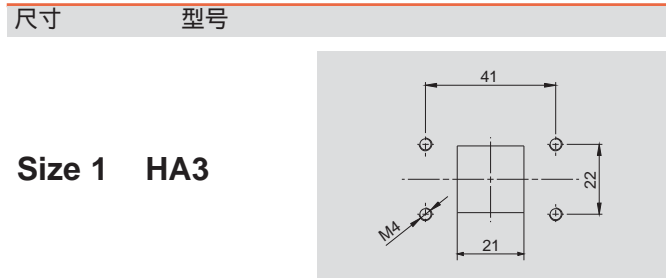

IP68外壳

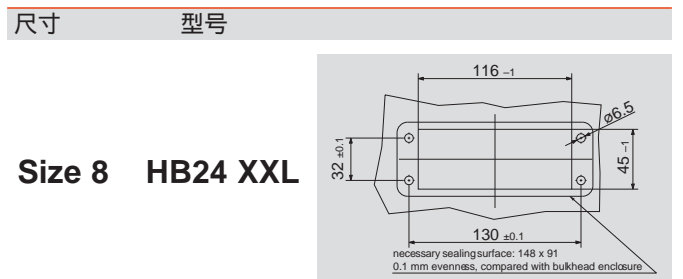

## RockStar®插芯

## RockStar®插芯

HA系列 小型插芯	B.2
250 V	
最大22 A	
3 - 48 针	
HE系列 通用型插芯	B.16
500 V	
最大24 A	
6 - 48针	
HEE系列 紧凑型插芯	B.30
500 V	
最大16 A	
10 - 46针	
HD 高密型插芯	B.42
250 V	
10 A	
7 - 128针	
HDD 超高密型插芯	B.66
250 V	
10 A	
24 - 216针	
HVE 高电压型插芯	B.80
830 V	
23 A	
3 + 2; 6 + 2; 10 + 2 针	
HSB 高电流型插芯	B.88
400 V	
35 A	
6 - 12 针	
MixMate 混合型插芯	B.94
最大1000 V	
最大100 A	
4, 4/0, 4/2, 8/24, 6/36, 6/12, 4/8, 6/6, 8/0	
HQ 高能小插芯	B.117
400 V	
16 A, 10 / 40 A	
4 / 2, 5, 7, 8, 17 针	

# HA 系列 小型插芯

当空间很小时，既小又窄的HA系列成为首选。

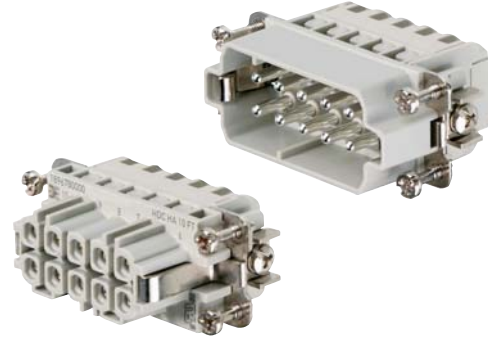

## 技术参数

标准/认证	
标准	DIN EN 61984 DIN EN 60664-1
认证	UL/CSA
<b>插芯</b>	
插针数	3,4,10,16,32,48
额定电压	250 V
据UL/CSA制定的额定电压	600 V
额定电流	22 A ( 32 针 16 A)
额定脉冲电压	4 KV
污染等级	3
绝缘阻抗	10 <sup>10</sup>
<b>材料</b>	
材料	玻璃纤维增强型PC
温度范围	-40 °C ... +125 °C
据UL94制定的阻燃等级	V0
<b>机械寿命</b>	
- 插头表面镀银	500
- 插头表面镀金	500
<b>接触电阻</b>	
- 冷压连接	2m
- 螺钉/弹片	2m
<b>插针/材料</b>	
材料	铜合金
表面	惰性银或镀金
接线单元/螺钉联接	铜合金/惰性银
<b>接线范围/剥线长度</b>	
- 冷压联接/剥线长度	0.5 - 4 mm <sup>2</sup> (AWG 20 ... 12) / 8 mm
- 螺钉联接/剥线长度	0.5 - 2.5 mm <sup>2</sup> (AWG 20 ... 14) / 9 mm
- 弹片联接/剥线长度	0.5 - 2.5 mm <sup>2</sup> (AWG 20 ... 14) / 8 mm
<b>锁紧力矩</b>	
- 螺钉联接	0.5 - 0.55 Nm
<b>螺丝刀头</b>	
- 螺钉联接	0.6 x 3.5 或者 PZ 0
- 直插式	0.4 x 2.5
- 弹片联接	0.5 x 3 或者 0.6 x 3.5
<b>PE联接</b>	
- 接线范围	0.5 ... 4 mm <sup>2</sup>
- 硬导线	0.5 ... 4 mm <sup>2</sup> / 0.5 ... 4 mm <sup>2</sup>
- 软导线 (带或不带端头)	0.5 ... 4 mm <sup>2</sup> / 0.5 ... 4 mm <sup>2</sup>
- AWG导线	AWG 20 ... 12
- 剥线长度	10 mm
- 锁紧力矩	1.2 ... 1.5 Nm
- 螺丝刀头尺寸	SD 0.8 x 4 mm 或者 PZ 1

## 电流曲线

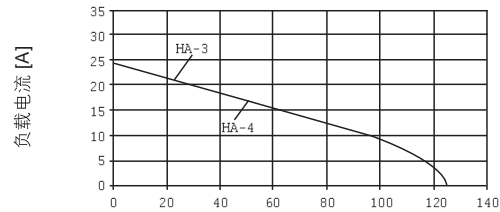

3 + 4-针, 1.5 mm<sup>2</sup> 环境温度 [°C]

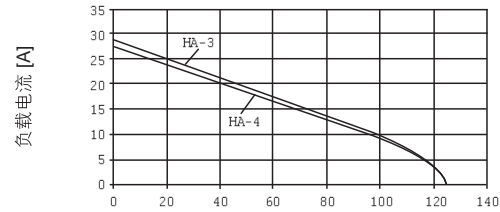

3 + 4-针, 2.5 mm<sup>2</sup> 环境温度 [°C]

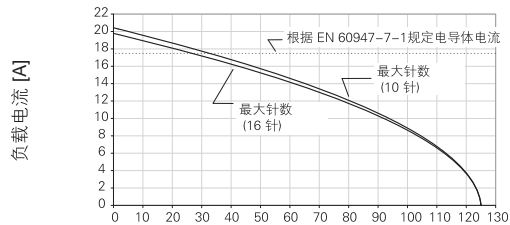

10 ... 48-针, 1.5 mm<sup>2</sup> 环境温度 [°C]

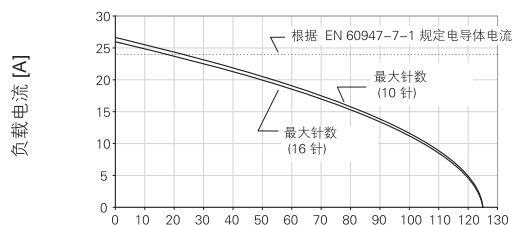

10 ... 48-针, 2.5 mm<sup>2</sup> 环境温度 [°C]

## 总览

	尺寸	额定电压	额定电流	插针数	弹片联接	螺钉联系	冷压联接	直插式联接	同轴联接	页码
	1	250 V	22 A	3 + ⊕		•				B.4
	1	250 V	22 A	4 + ⊕		•				B.6
	2	250 V	22 A	10 + ⊕	•	•	•			B.8
	5	250 V	22 A	16 + ⊕	•	•	•			B.10
	7	250 V	16 A	32 + ⊕	•	•	•			B.12
	9	250 V	16 A	48 + ⊕	•	•	•			B.14



250 V, 22 A, 尺寸 1

3 + ⊕

插芯



螺钉联接



插芯	型号	订货号
公	HDC HA 3 MS	1498100000
母	HDC HA 3 FS	1498200000

尺寸

公

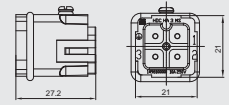

母

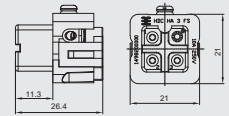

插针的排列

公



母



## RockStar® IP65外壳选择

## 尺寸1

\*更多外壳,请参D章节



## 插头外壳

材料: 铸铝

## 插头外壳, 侧面进线



a	描述	防尘盖	b (mm)	型号	订货号
M 20	带螺纹		49.2	HDC 04A TWLU 1M20G	<b>1788810000</b>

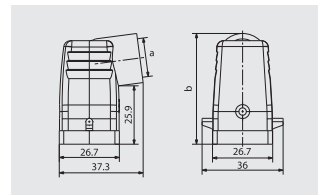

## 插头外壳, 顶部进线



a	描述	防尘盖	b (mm)	型号	订货号
M 20	带螺纹		50	HDC 04A TOLU 1M20G	<b>1788820000</b>

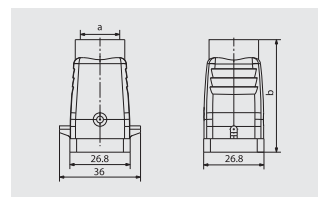

## 底座

## 穿体式插座外壳



描述	防尘盖	b (mm)	型号	订货号
		23	HDC 04A ALU	<b>1497600000</b>

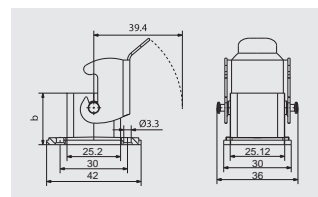

## 底座封闭式插座外壳



a	描述	防尘盖	b (mm)	型号	订货号
M 20	带螺纹		25.8	HDC 04A SLU 1M20G	<b>1788830000</b>

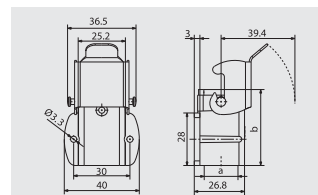

## 对接外壳



a	描述	防尘盖	b (mm)	型号	订货号
M 20	带螺纹		53.5	HDC 04A KOLU 1M20G	<b>1788840000</b>

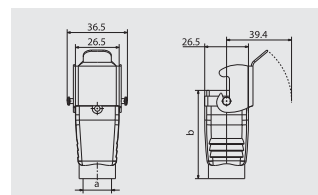

## 出线口螺纹固定外壳



a	描述	防尘盖	b (mm)	型号	订货号
M 20	带螺纹		54	HDC 04A ELU 1M20G	<b>1900320000</b>
PG 13,5	带螺纹		54	HDC 04A ELU 1PG13G	<b>1900330000</b>
PG 13,5	带螺纹		54	HDC 04A ELU 1PG13G EXI	<b>1900350000</b>

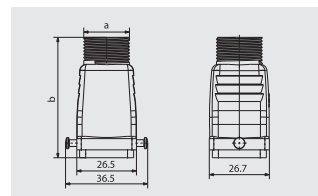

## 防尘盖



描述	型号	订货号
用于插座	HDC 04A DMDL 2BO	<b>1665750000</b>
用于插头	HDC 04A DODL 2BO	<b>1665740000</b>

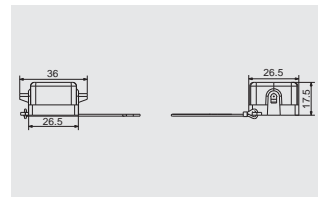

250 V, 22 A, 尺寸 1

4 + ⊕

插芯



螺钉联接



插芯	型号	订货号
公	HDC HA 4 MS	<b>1498300000</b>
母	HDC HA 4 FS	<b>1498400000</b>

尺寸

公

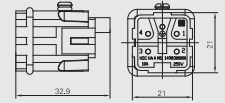

母

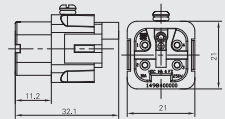

插针的排列

公



母



## RockStar® IP65外壳选择

## 尺寸1

\*更多外壳,请参阅D章节



## 插头外壳

材料: 铸铝

## 插头外壳, 侧面进线



a	描述	防尘盖	b (mm)	型号	订货号
M 20	带螺纹		49.2	HDC 04A TWLU 1M20G	<b>1788810000</b>

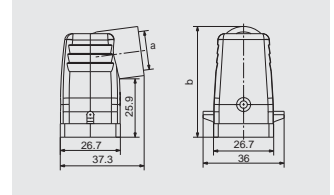

## 插头外壳, 顶部进线



a	描述	防尘盖	b (mm)	型号	订货号
M 20	带螺纹		50	HDC 04A TOLU 1M20G	<b>1788820000</b>

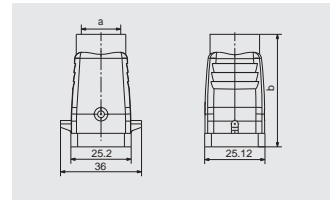

## 底座

## 穿体式插座外壳



描述	防尘盖	b (mm)	型号	订货号
		23	HDC 04A ALU	<b>1497600000</b>

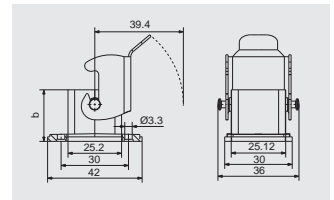

## 底座封闭式插座外壳



a	描述	防尘盖	b (mm)	型号	订货号
M 20	带螺纹		25.8	HDC 04A SLU 1M20G	<b>1788830000</b>

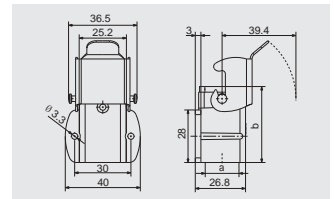

## 对接外壳



a	描述	防尘盖	b (mm)	型号	订货号
M 20	带螺纹		53.5	HDC 04A KOLU 1M20G	<b>1788840000</b>

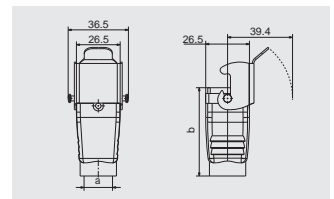

## 出线口螺纹固定外壳



a	描述	防尘盖	b (mm)	型号	订货号
M 20	带螺纹		54	HDC 04A ELU 1M20G	<b>1900320000</b>
PG 13,5	带螺纹		54	HDC 04A ELU 1PG13G	<b>1900330000</b>
PG 13,5	带螺纹		54	HDC 04A ELU 1PG13G EXI	<b>1900350000</b>

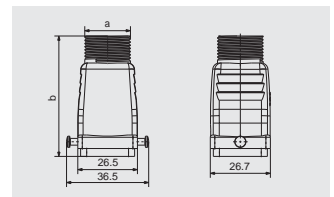

## 防尘盖



描述	型号	订货号
用于插座	HDC 04A DMDL 2BO	<b>1665750000</b>
用于插头	HDC 04A DODL 2BO	<b>1665740000</b>

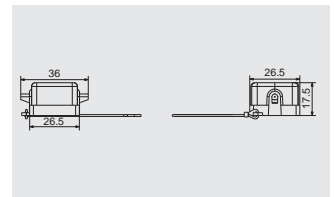

250 V, 22 A, 尺寸 2

10 + ⊕

插芯



弹片联接



插芯	型号	订货号
公	HDC HA 10 MT	1896790000
母	HDC HA 10 FT	1896780000

尺寸

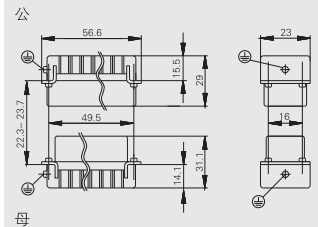

插针的排列

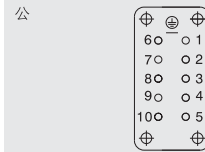

母

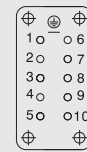

开孔尺寸

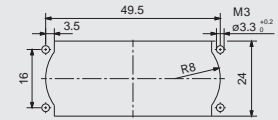

螺钉联接



插芯	型号	订货号
公	HDC HA 10 MS	1650610000
母	HDC HA 10 FS	1650620000

冷压联接



插芯	型号	订货号
母	HDC HA 10 FC	1873860000
公	HDC HA 10 MC	1873870000

零配件

冷压插针

表面镀银



表面镀金



数量	公	订货号	母	订货号
100	HDC-C-HE-SM0.5AG	1200500000	HDC-C-HE-BM0.5AG	1201100000
100	HDC-C-HE-SM0.75-1AG	1200600000	HDC-C-HE-BM0.75-1AG	1201200000
100	HDC-C-HE-SM1.5AG	1200700000	HDC-C-HE-BM1.5AG	1201300000
100	HDC-C-HE-SM2.5AG	1200800000	HDC-C-HE-BM2.5AG	1201400000
100	HDC-C-HE-SM4.0AG	1200900000	HDC-C-HE-BM4.0AG	1201500000
100	HDC-C-HE-SM0.5AU	1651420000	HDC-C-HE-BM0.5AU	1651470000
100	HDC-C-HE-SM0.75-1AU	1651430000	HDC-C-HE-BM0.75-1AU	1651480000
100	HDC-C-HE-SM1.5AU	1651440000	HDC-C-HE-BM1.5AU	1651490000
100	HDC-C-HE-SM2.5AU	1651450000	HDC-C-HE-BM2.5AU	1651500000
100	HDC-C-HE-SM4.0AU	1651460000	HDC-C-HE-BM4.0AU	1651510000

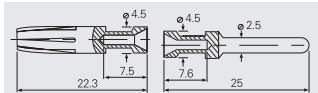

导线截面积

mm <sup>2</sup>	AWG 导线	剥线长度
0.50	20	7.5mm
0.75-1.00	18	7.5mm
1.50	16	7.5mm
2.50	14	7.5mm
4.00	12	7.5mm

工具



压针工具	订货号
CTX CM 1.6/2.5	9018490000
退针工具	订货号
退针工具 HE	1866750000

## RockStar® IP65/IP66外壳选择

## 尺寸2

\*更多外壳,请参D章节



## 插头外壳

## 插头外壳, 侧面进线



a	描述	防尘盖	型号	订货号
M 20	带螺纹	68	HDC 15A TSLU 1M20G	1788660000
M 25	带螺纹	68	HDC 15A TSLU 1M25G	1788650000

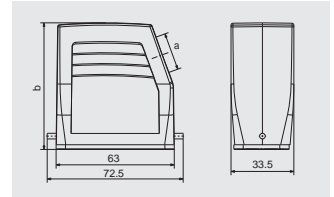

## 插头外壳, 顶部进线



a	描述	防尘盖	型号	订货号
M 20	带螺纹	54	HDC 10A TOLU 1M20G	1788620000
M 25	带螺纹	54	HDC 10A TOLU 1M25G	1788610000

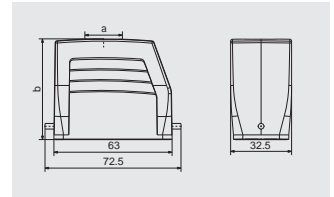

## 防尘盖



描述	型号	订货号
用于插头外壳	HDC 10A DODL 1LB	1665890000

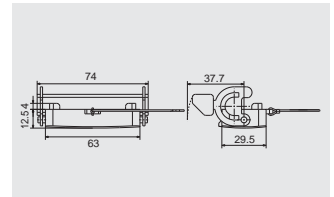

## 底座

## 穿体式插座外壳



描述	防尘盖	b (mm)	型号	订货号
	带	37.5	HDC 10A ADLU	1664060000
		25	HDC 10A ALU	1664040000

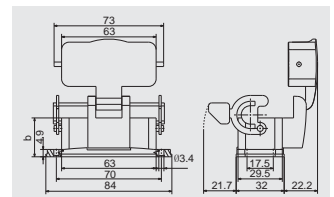

## 底座封闭式插座外壳



a	描述	防尘盖	b (mm)	型号	订货号
M 20	带螺纹	带	69.5	HDC 10A SDLU 2M20G	1788660000
M 25	带螺纹	带	69.5	HDC 10A SDLU 2M25G	1788650000
M 20	带螺纹		57	HDC 10A SLU 2M20G	1788640000
M 25	带螺纹		57	HDC 10A SLU 2M25G	1788630000

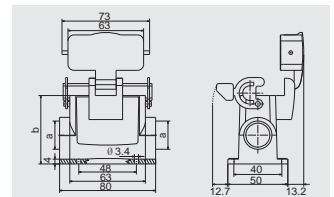

## 对接外壳



a	描述	防尘盖	b (mm)	型号	订货号
M 25	带螺纹		48	HDC 10A KLU 1M25G	1788670000

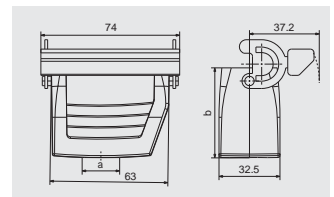

## 防尘盖



描述	型号	订货号
用于插座外壳	HDC 10A DMDL 2BO	1665880000

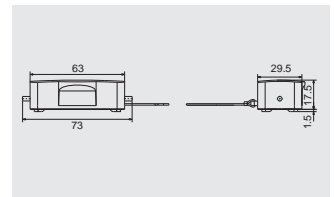

250 V, 22 A, 尺寸 5

16 + ⊕

插芯



弹片联接



插芯	型号	订货号
公	HDC HA 16 MT	1896830000
母	HDC HA 16 FT	1896800000

尺寸

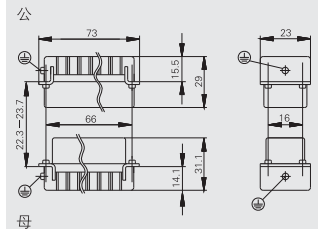

插针的排列

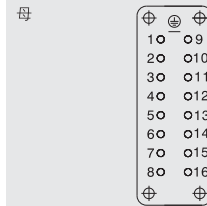
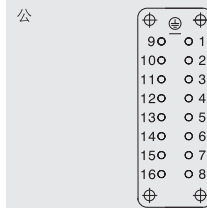

开孔尺寸

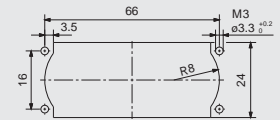

螺钉联接



插芯	型号	订货号
公	HDC HA 16 MS	1650770000
母	HDC HA 16 FS	1650780000

冷压联接



插芯	型号	订货号
公	HDC HA 16 MC	1873890000
母	HDC HA 16 FC	1873880000

零配件

冷压插针

表面镀银



表面镀金



数量	公	订货号	母	订货号
100	HDC-C-HE-SM0.5AG	1200500000	HDC-C-HE-BM0.5AG	1201100000
100	HDC-C-HE-SM0.75-1AG	1200600000	HDC-C-HE-BM0.75-1AG	1201200000
100	HDC-C-HE-SM1.5AG	1200700000	HDC-C-HE-BM1.5AG	1201300000
100	HDC-C-HE-SM2.5AG	1200800000	HDC-C-HE-BM2.5AG	1201400000
100	HDC-C-HE-SM4.0AG	1200900000	HDC-C-HE-BM4.0AG	1201500000
100	HDC-C-HE-SM0.5AU	1651420000	HDC-C-HE-BM0.5AU	1651470000
100	HDC-C-HE-SM0.75-1AU	1651430000	HDC-C-HE-BM0.75-1AU	1651480000
100	HDC-C-HE-SM1.5AU	1651440000	HDC-C-HE-BM1.5AU	1651490000
100	HDC-C-HE-SM2.5AU	1651450000	HDC-C-HE-BM2.5AU	1651500000
100	HDC-C-HE-SM4.0AU	1651460000	HDC-C-HE-BM4.0AU	1651510000

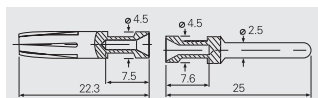

导线截面积

mm <sup>2</sup>	AWG 导线	剥线长度
0.50	20	7.5mm
0.75-1.00	18	7.5mm
1.50	16	7.5mm
2.50	14	7.5mm
4.00	12	7.5mm

工具



压针工具	订货号
CTX CM 1.6/2.5	9018490000
退针工具	订货号
退针工具 HE	1866750000

## RockStar® IP65/IP66外壳选择

## 尺寸5

\*更多外壳,请参阅D章节

## 插头外壳



## 插头外壳, 侧面进线



a	描述	防尘盖	型号	订货号
M 25	带螺纹	58	HDC 16A TSLU 1M25G	<b>1788740000</b>
M 20	带螺纹	72	HDC 25A TSLU 1M20G	<b>1788680000</b>
M 25	带螺纹	72	HDC 25A TSLU 1M25G	<b>1788690000</b>

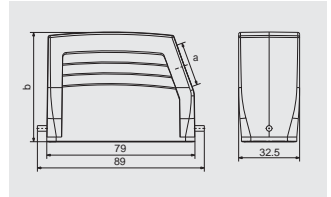

## 插头外壳, 顶部进线



a	描述	防尘盖	型号	订货号
M 25	带螺纹	58	HDC 16A TOLU 1M25G	<b>1788750000</b>
M 20	带螺纹	72	HDC 25A TOLU 1M20G	<b>1788710000</b>
M 25	带螺纹	72	HDC 25A TOLU 1M25G	<b>1788700000</b>

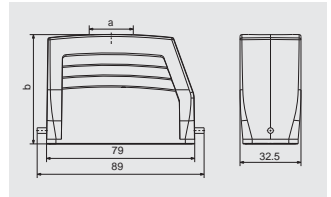

## 防尘盖



描述	型号	订货号
用于插头外壳	HDC 16A DODL 1LB	<b>1665900000</b>

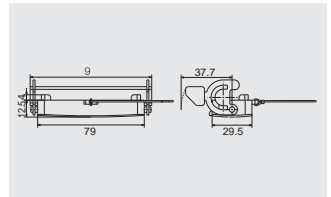

## 底座

## 穿体式插座外壳



描述	防尘盖	b (mm)	型号	订货号
带	44.5	25	HDC 16A ADLU	<b>1664940000</b>
			HDC 16A ALU	<b>1664920000</b>

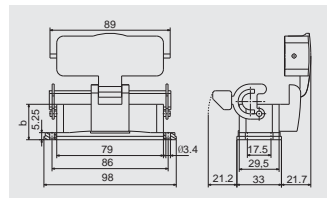

## 底座封闭型插座外壳



a	描述	防尘盖	b (mm)	型号	订货号
M 20	带螺纹	带	76.5	HDC 16A SDLU 2M20G	<b>1788790000</b>
M 25	带螺纹	带	76.5	HDC 16A SDLU 2M25G	<b>1788780000</b>
M 20	带螺纹		57	HDC 16A SLU 2M20G	<b>1788770000</b>
M 25	带螺纹		57	HDC 16A SLU 2M25G	<b>1788760000</b>

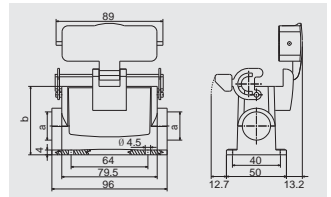

## 对接外壳



a	描述	防尘盖	b (mm)	型号	订货号
M 25	带螺纹		53	HDC 16A KLU 1M25G	<b>1788800000</b>

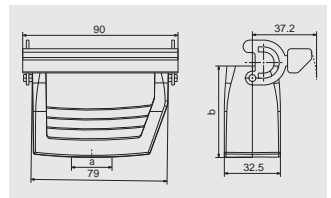

## 防尘盖



描述	型号	订货号
用于插座外壳	HDC 16A DMDL 2BO	<b>1665910000</b>

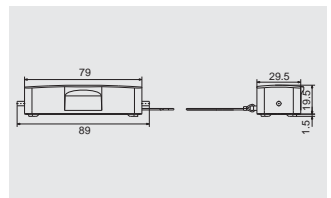



250 V, 16 A, 尺寸 7

32 + ⊕

插芯



弹片联接



插芯	型号	订货号
公	HDC HA 16 MT	1896830000
母	HDC HA 16 FT	1896800000
公	HDC HA 16 MT 17-32	1896840000
母	HDC HA 16 FT 17-32	1896810000

尺寸

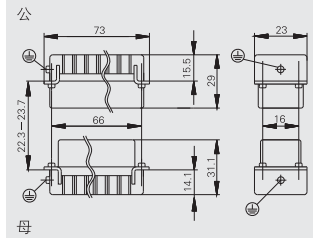

母

插针的排列

公	母
250	90
260	100
270	110
280	120
290	130
300	140
310	150
320	160

母

开孔尺寸

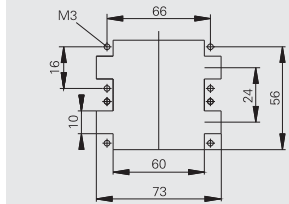

螺钉联接



插芯	型号	订货号
公	HDC HA 16 MS	1650770000
母	HDC HA 16 FS	1650780000
公	HDC HA 16 MS 17-32	1650880000
母	HDC HA 16 FS 17-32	1650900000

冷压联接



插芯	型号	订货号
公	HDC HA 16 MC	1873890000
母	HDC HA 16 FC	1873880000
公	HDC HA 16 MC 17-32	1875620000
母	HDC HA 16 FC 17-32	1876040000

零配件

冷压插针

表面镀银



表面镀金



数量	公	订货号	母	订货号
100	HDC-C-HE-SM0.5AG	1200500000	HDC-C-HE-BM0.5AG	1201100000
100	HDC-C-HE-SM0.75-1AG	1200600000	HDC-C-HE-BM0.75-1AG	1201200000
100	HDC-C-HE-SM1.5AG	1200700000	HDC-C-HE-BM1.5AG	1201300000
100	HDC-C-HE-SM2.5AG	1200800000	HDC-C-HE-BM2.5AG	1201400000
100	HDC-C-HE-SM4.0AG	1200900000	HDC-C-HE-BM4.0AG	1201500000
100	HDC-C-HE-SM0.5AU	1651420000	HDC-C-HE-BM0.5AU	1651470000
100	HDC-C-HE-SM0.75-1AU	1651430000	HDC-C-HE-BM0.75-1AU	1651480000
100	HDC-C-HE-SM1.5AU	1651440000	HDC-C-HE-BM1.5AU	1651490000
100	HDC-C-HE-SM2.5AU	1651450000	HDC-C-HE-BM2.5AU	1651500000
100	HDC-C-HE-SM4.0AU	1651460000	HDC-C-HE-BM4.0AU	1651510000

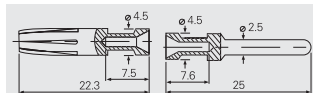

导线截面积

mm <sup>2</sup>	AWG 导线	剥线长度
0.50	20	7.5mm
0.75-1.00	18	7.5mm
1.50	16	7.5mm
2.50	14	7.5mm
4.00	12	7.5mm

工具



压针工具	订货号
CTX CM 1.6/2.5	9018490000
退针工具	订货号
退针工具 HE	1866750000

## RockStar® IP65/IP66外壳选择

## 尺寸7

\*更多外壳,请参D章节

## 插头外壳



## 插头外壳, 侧面进线



a	描述	防尘盖	b (mm)	型号	订货号
M 25	带螺纹		75	HDC 32A TSBU 1M25G	<b>1787960000</b>
M 32	带螺纹		75	HDC 32A TSBU 1M32G	<b>1787950000</b>

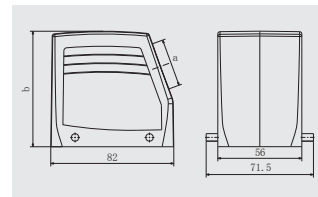

## 插头外壳, 顶部进线



a	描述	防尘盖	b (mm)	型号	订货号
M 32	带螺纹		75	HDC 32A TOBU 1M32G	<b>1787990000</b>

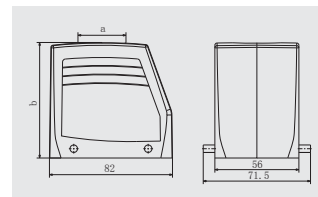

## 底座

## 穿体式插座外壳



描述	防尘盖	b (mm)	型号	订货号
		25	HDC 32A ABU	<b>1665860000</b>

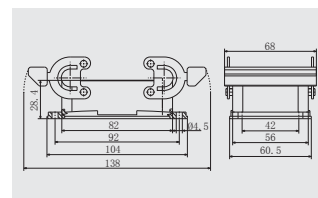

## 底座封闭型插座外壳



a	描述	防尘盖	b (mm)	型号	订货号
M 25	带螺纹		75	HDC 32A SBU 2M25G	<b>1788040000</b>

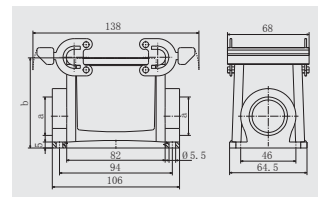

## 对接外壳



a	描述	防尘盖	b (mm)	型号	订货号
M 25	带螺纹		76.5	HDC 32A KBU 1M25G	<b>1788080000</b>
M 32	带螺纹		76.5	HDC 32A KBU 1M32G	<b>1788070000</b>

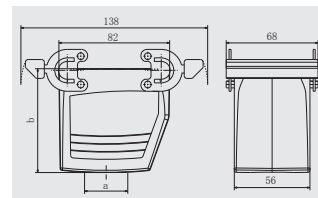

250 V, 16 A, 尺寸 9

48 + ⊕

插芯



弹片联接



插芯	型号	订货号
公	HDC HA 16 MT	1896830000
母	HDC HA 16 FT	1896800000
公	HDC HA 16 MT 17-32	1896840000
母	HDC HA 16 FT 17-32	1896810000
公	HDC HA 16 MT 33-48	1896850000
母	HDC HA 16 FT 33-48	1896820000

螺钉联接



插芯	型号	订货号
公	HDC HA 16 MS	1650770000
母	HDC HA 16 FS	1650780000
公	HDC HA 16 MS 17-32	1650880000
母	HDC HA 16 FS 17-32	1650900000
公	HDC HA 16 MS 33-48	1650990000
母	HDC HA 16 FS 33-48	1651020000

冷压联接



插芯	型号	订货号
公	HDC HA 16 MC	1873890000
母	HDC HA 16 FC	1873880000
公	HDC HA 16 MC 17-32	1875620000
母	HDC HA 16 FC 17-32	1876040000
公	HDC HA 16 MC 33-48	1875630000
母	HDC HA 16 FC 33-48	1875540000

尺寸

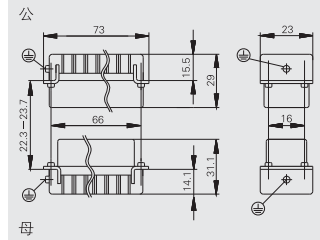

插针的排列

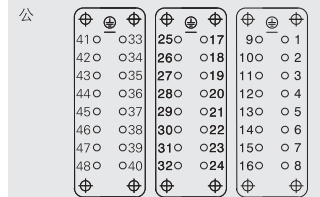

母

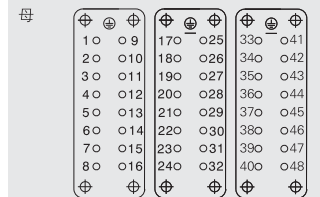

开孔尺寸

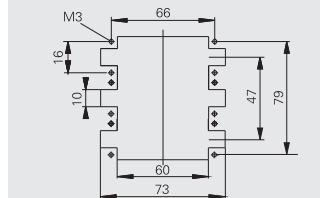

零配件

冷压插针

表面镀银



表面镀金



数量	公	订货号	母	订货号
100	HDC-C-HE-SM0.5AG	1200500000	HDC-C-HE-BM0.5AG	1201100000
100	HDC-C-HE-SM0.75-1AG	1200600000	HDC-C-HE-BM0.75-1AG	1201200000
100	HDC-C-HE-SM1.5AG	1200700000	HDC-C-HE-BM1.5AG	1201300000
100	HDC-C-HE-SM2.5AG	1200800000	HDC-C-HE-BM2.5AG	1201400000
100	HDC-C-HE-SM4.0AG	1200900000	HDC-C-HE-BM4.0AG	1201500000
100	HDC-C-HE-SM0.5AU	1651420000	HDC-C-HE-BM0.5AU	1651470000
100	HDC-C-HE-SM0.75-1AU	1651430000	HDC-C-HE-BM0.75-1AU	1651480000
100	HDC-C-HE-SM1.5AU	1651440000	HDC-C-HE-BM1.5AU	1651490000
100	HDC-C-HE-SM2.5AU	1651450000	HDC-C-HE-BM2.5AU	1651500000
100	HDC-C-HE-SM4.0AU	1651460000	HDC-C-HE-BM4.0AU	1651510000

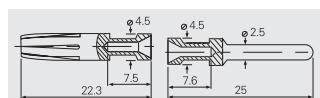

导线截面积

mm <sup>2</sup>	AWG 导线	剥线长度
0.50	20	7.5mm
0.75-1.00	18	7.5mm
1.50	16	7.5mm
2.50	14	7.5mm
4.00	12	7.5mm

工具



压针工具	订货号
CTX CM 1.6/2.5	9018490000
退针工具	订货号
退针工具 HE	1866750000

## RockStar® IP65/IP66外壳选择

## 尺寸9

\*更多外壳,请参阅D章节

## 插头外壳



## 插头外壳, 侧面进线



a	描述	防尘盖	b (mm)	型号	订货号
M 32	带螺纹		79	HDC 48A TSLU 1M32G	<b>1788550000</b>

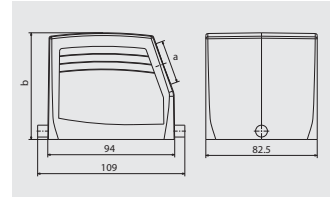

## 插头外壳, 顶部进线



a	描述	防尘盖	b (mm)	型号	订货号
M 32	带螺纹		79	HDC 48A TOLU 1M32G	<b>1788560000</b>

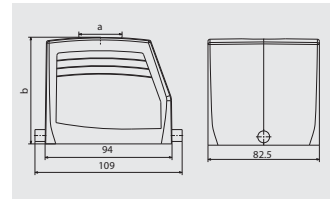

## 底座

## 穿体式插座外壳



描述	防尘盖	b (mm)	型号	订货号
	带	53	HDC 48A ADLU	<b>1666750000</b>
		36	HDC 48A ALU	<b>1666740000</b>

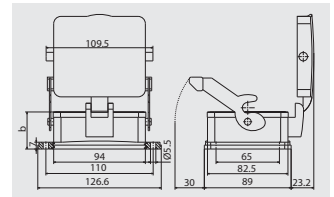

## 底座封闭式插座外壳



a	描述	防尘盖	b (mm)	型号	订货号
M 32	带螺纹		79	HDC 48A SLU 2M32G	<b>1788570000</b>

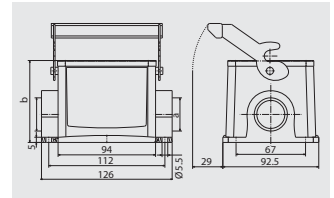

# HE系列 通用型插芯

有了HE系列，就可以向客户提供不同的接线方式，除了已有的弹片联接，还有螺钉钉、冷压联接。

并且魏德米勒是第一个提供直插式联接的厂商。

你可以自由地选择您需要的联接系统。

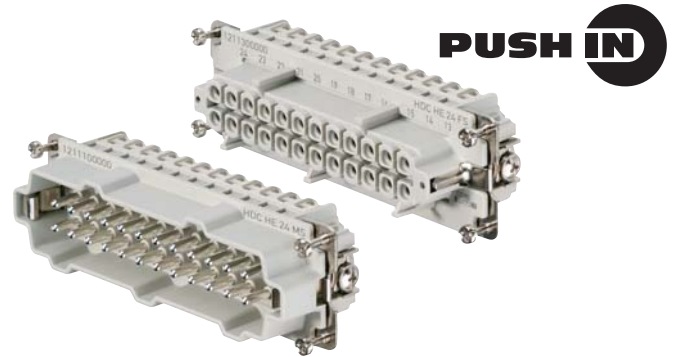

## 技术参数

标准/认证	
标准	DIN EN 61984 DIN EN 60664-1
认证	UL/CSA
插芯	
插针数	6, 10, 16, 24, 32, 48
额定电压	500 V
据UL/CSA制定的额定电压	600 V
额定电流	16 A (6针24 A)
额定脉冲电压	6 kV
污染等级	3
绝缘阻抗	10 <sup>10</sup>
材料	
材料	玻璃纤维增强型PC
温度范围	-40 °C ... +125 °C
据UL94制定的阻燃等级	V0
机械寿命	
- 插孔银表面	500
- 插孔金表面	500
接触阻抗	
- 冷压联接	1.5 m
- 螺钉弹片+直插式	2 m
插针/材料	
材料	
表面	铜合金 惰性银或镀金
接线单元/螺钉联接	铜合金/惰性银
接线范围/剥线长度	
- 冷压联接	
- 软导线/剥线长度	0.5 ... 4 mm <sup>2</sup> (AWG 20 ... 12) / 7.5 mm
- 螺钉联接	0.5 - 2.5 mm <sup>2</sup> (AWG 20 ... 14) / 9 mm
- 直插式	0.5 - 2.5 mm <sup>2</sup> (AWG 20 ... 14) / 8 mm
- 弹片联接	0.5 - 2.5 mm <sup>2</sup> (AWG 20 ... 14) / 8 mm
拧紧力矩	
- 螺钉联接	0.5 - 0.55 Nm
螺丝刀头	
- 螺钉联接	0.6 x 3.5 或者 PZ 0
- 直插式	0.4 x 2.5
- 弹片联接	0.5 x 3 或者 0.6 x 3.5
PE联接	
- 接线范围	0.5 ... 4 mm <sup>2</sup>
- 硬导线	0.5 ... 4 mm <sup>2</sup> / 0.5 ... 4 mm <sup>2</sup>
- 软导线	0.5 ... 4 mm <sup>2</sup> / 0.5 ... 4 mm <sup>2</sup>
- AWG导线	AWG 20 ... 12
- 剥线长度	10 mm
- 拧紧转矩	1.2 ... 1.5 Nm
- 螺丝刀头尺寸	SD 0.8 x 4 mm 或者 PZ 1

## 电流曲线

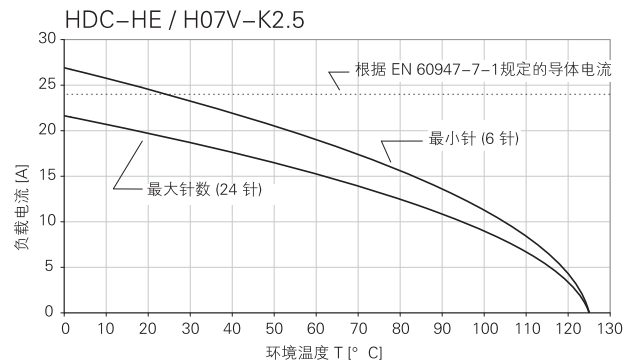
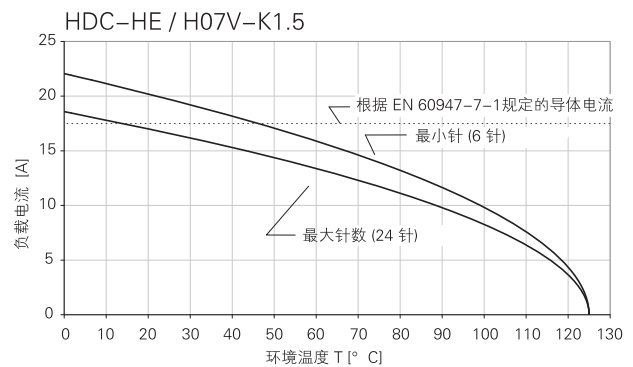

## 总揽

	尺寸	额定电压	额定电流	插针数	弹片联接	螺钉联系	冷压联接	直插式联接	同轴联接	页码
	3	500 V	24 A	6 + ⊕	•	•	•	•		B.18
	4	500 V	16 A	10 + ⊕	•	•	•	•		B.20
	6	500 V	16 A	16 + ⊕	•	•	•	•		B.22
	8	500 V	16 A	24 + ⊕	•	•	•	•		B.24
	10	500 V	16 A	32 + ⊕	•	•	•	•		B.26
	12	500 V	16 A	48 + ⊕	•	•	•	•		B.28

500 V, 24 A, 尺寸 3

6 + ⊕

插芯



弹片联接



插芯	型号	订货号
公	HDC HE 6 MT	1745820000
母	HDC HE 6 FT	1745760000

螺钉联接



插芯	型号	订货号
公	HDC HE 6 MS	1200000000
母	HDC HE 6 FS	1200200000

直插式联接



插芯	型号	订货号
公	HDC HE 6 MP	1873530000
母	HDC HE 6 FP	1873520000

冷压联接



插芯	型号	订货号
公	HDC HE 6 MC	1200400000
母	HDC HE 6 FC	1201000000

零配件

冷压插针

表面镀银



表面镀金



数量	公	订货号	母	订货号
100	HDC - C - HE - SM0.5AG	1200500000	HDC - C - HE - BM0.5AG	1201100000
100	HDC - C - HE - SM0.75 - 1AG	1200600000	HDC - C - HE - BM0.75 - 1AG	1201200000
100	HDC - C - HE - SM1.5AG	1200700000	HDC - C - HE - BM1.5AG	1201300000
100	HDC - C - HE - SM2.5AG	1200800000	HDC - C - HE - BM2.5AG	1201400000
100	HDC - C - HE - SM4.0AG	1200900000	HDC - C - HE - BM4.0AG	1201500000
100	HDC - C - HE - SM0.5AU	1651420000	HDC - C - HE - BM0.5AU	1651470000
100	HDC - C - HE - SM0.75 - 1AU	1651430000	HDC - C - HE - BM0.75 - 1AU	1651480000
100	HDC - C - HE - SM1.5AU	1651440000	HDC - C - HE - BM1.5AU	1651490000
100	HDC - C - HE - SM2.5AU	1651450000	HDC - C - HE - BM2.5AU	1651500000
100	HDC - C - HE - SM4.0AU	1651460000	HDC - C - HE - BM4.0AU	1651510000

工具



压针工具	订货号
CTX CM 1.6/2.5	9018490000
退针工具	订货号
退针工具 HE	1866750000

尺寸

公

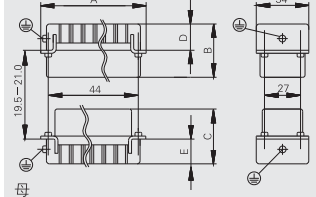

A (mm)	B (mm)	C (mm)	D (mm)	E (mm)
49.80	33.80	33.20	19.10	16.50

插针的排列

公

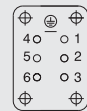

母

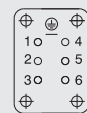

插针的排列

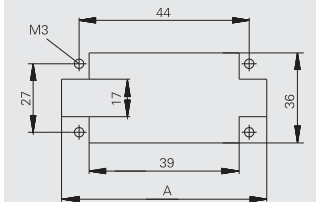

A (mm)
51.00

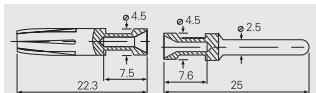

导线截面积

mm <sup>2</sup>	AWG 导线	剥线长度
0.50	20	7.5mm
0.75 - 1.00	18	7.5mm
1.50	16	7.5mm
2.50	14	7.5mm
4.00	12	7.5mm

## RockStar® IP65/IP66外壳选择

## 尺寸3

\*更多外壳,请参阅D章节

## 插头外壳



## 插头外壳, 侧面进线



a	描述	防尘盖	b (mm)	型号	订货号
M 20	带螺纹		52	HDC 06B TSLU 1M20G	<b>1788100000</b>
M 20	带螺纹		52	HDC 06B TSLU 1M20G	<b>1805930000</b>
M 25	带螺纹		52	HDC 06B TSLU 1M25G	<b>1788090000</b>
M 25	带螺纹		72	HDC 16D TSLU 1M25G	<b>1787480000</b>

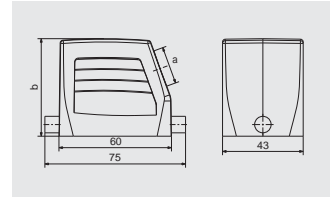

## 插头外壳, 顶部进线



a	描述	防尘盖	b (mm)	型号	订货号
M 20	带螺纹		52	HDC 06B TOLU 1M20G	<b>1788120000</b>
M 25	带螺纹		52	HDC 06B TOLU 1M25G	<b>1788110000</b>
M 25	带螺纹		72	HDC 16D TOLU 1M25G	<b>1787500000</b>
M 32	带螺纹		72	HDC 16D TOLU 1M32G	<b>1787490000</b>

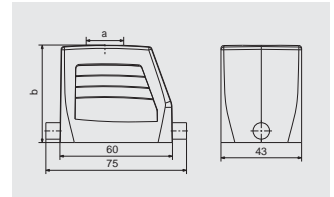

## 防尘盖



描述	型号	订货号
用于插头外壳	HDC 06B DMDL 1LB	<b>1665210000</b>

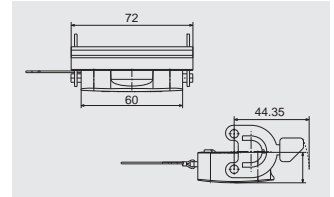

## 底座

## 穿体式插座外壳



描述	防尘盖	b (mm)	型号	订货号
		29	HDC 06B ALU	<b>1202100000</b>
	带	47	HDC 06B ADLU	<b>1202500000</b>

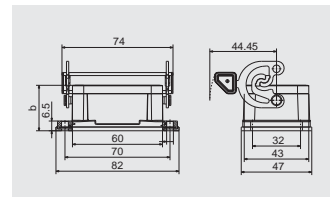

## 底座封闭式插座外壳



a	描述	防尘盖	b (mm)	型号	订货号
M 20	带螺纹		54	HDC 06B SLU 2M20G	<b>1788140000</b>
M 20	带螺纹	带	72	HDC 06B SDLU 2M20G	<b>1788170000</b>
M 25	带螺纹		54	HDC 06B SLU 2M25G	<b>1788130000</b>
M 25	带螺纹	带	72	HDC 06B SDLU 2M25G	<b>1788160000</b>

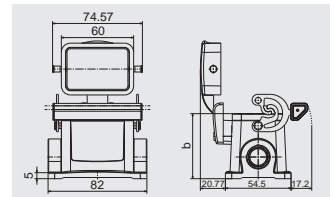

## 防尘盖



描述	型号	订货号
用于插座外壳	HDC 06B DODL 2BO	<b>1665200000</b>

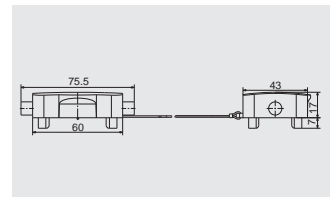



500 V, 16 A, 尺寸 4

10 + ⊕

插芯



弹片联接



插芯	型号	订货号
公	HDC HE 10 MT	1745830000
母	HDC HE 10 FT	1745770000

螺钉联接



插芯	型号	订货号
母	HDC HE 10 FS	1204100000
公	HDC HE 10 MS	1203900000

直插式联接



插芯	型号	订货号
公	HDC HE 10 MP	1873550000
母	HDC HE 10 FP	1873540000

冷压联接



插芯	型号	订货号
公	HDC HE 10 MC	1204300000
母	HDC HE 10 FC	1204400000

零配件

冷压插针

表面镀银



表面镀金



数量	公	订货号	母	订货号
100	HDC-C-HE-SM0.5AG	1200500000	HDC-C-HE-BM0.5AG	1201100000
100	HDC-C-HE-SM0.75-1AG	1200600000	HDC-C-HE-BM0.75-1AG	1201200000
100	HDC-C-HE-SM1.5AG	1200700000	HDC-C-HE-BM1.5AG	1201300000
100	HDC-C-HE-SM2.5AG	1200800000	HDC-C-HE-BM2.5AG	1201400000
100	HDC-C-HE-SM4.0AG	1200900000	HDC-C-HE-BM4.0AG	1201500000
100	HDC-C-HE-SM0.5AU	1651420000	HDC-C-HE-BM0.5AU	1651470000
100	HDC-C-HE-SM0.75-1AU	1651430000	HDC-C-HE-BM0.75-1AU	1651480000
100	HDC-C-HE-SM1.5AU	1651440000	HDC-C-HE-BM1.5AU	1651490000
100	HDC-C-HE-SM2.5AU	1651450000	HDC-C-HE-BM2.5AU	1651500000
100	HDC-C-HE-SM4.0AU	1651460000	HDC-C-HE-BM4.0AU	1651510000

工具



压针工具	订货号
CTX CM 1.6/2.5	9018490000
C退针工具	订货号
退针工具 HE	1866750000

尺寸

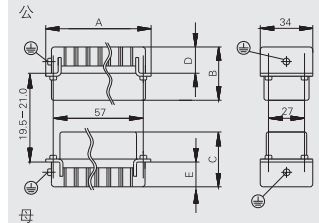

A (mm)	B (mm)	C (mm)	D (mm)	E (mm)
62.80	33.80	33.20	19.10	16.50

插针的排列

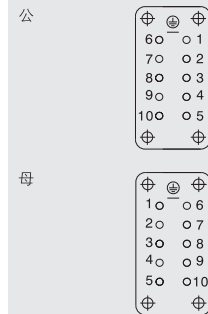

开孔尺寸

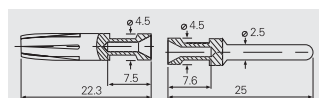
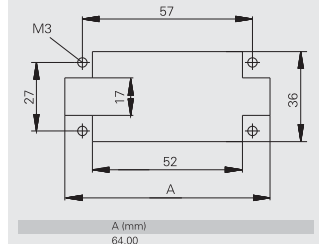

导线截面积

mm <sup>2</sup>	AWG 导线	剥线长度
0.50	20	7.5mm
0.75-1.00	18	7.5mm
1.50	16	7.5mm
2.50	14	7.5mm
4.00	12	7.5mm

## RockStar® IP65/IP66外壳选择

## 尺寸4

\*更多外壳,请参阅D章节

## 插头外壳

## 插头外壳, 侧面进线



a	描述	防尘盖	b (mm)	型号	订货号
M 20	带螺纹		52	HDC 10B TSBU 1M20G	<b>1787560000</b>
M 25	带螺纹		52	HDC 10B TSBU 1M25G	<b>1787550000</b>
M 25	带螺纹		72	HDC 24D TSBU 1M25G	<b>1787240000</b>
M 32	带螺纹		72	HDC 24D TSBU 1M32G	<b>1787230000</b>

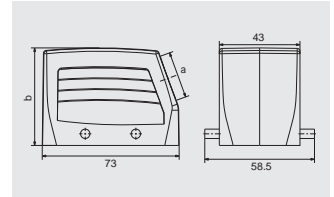

## 插头外壳, 顶部进线



a	描述	防尘盖	b (mm)	型号	订货号
M 20	带螺纹		52	HDC 10B TOBU 1M20G	<b>1787600000</b>
M 25	带螺纹		52	HDC 10B TOBU 1M25G	<b>1787590000</b>
M 25	带螺纹		72	HDC 24D TOBU 1M25G	<b>1787300000</b>
M 32	带螺纹		72	HDC 24D TOBU 1M32G	<b>1787290000</b>

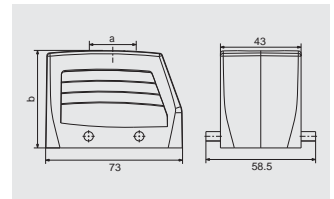

## 防尘盖



描述	型号	订货号
用于插头外壳	HDC 10B DMDQ 2QB	<b>1665240000</b>

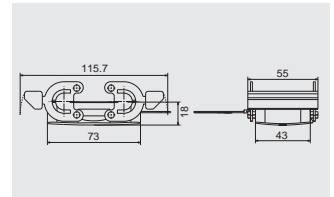

## 底座

## 穿体式插座外壳



描述	防尘盖	b (mm)	型号	订货号
		29.3	HDC 10B ABU	<b>1205000000</b>

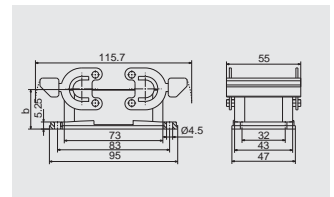

## 底座封闭式插座外壳



a	描述	防尘盖	b (mm)	型号	订货号
M 20	带螺纹		57	HDC 10B SBU 2M20G	<b>1787640000</b>
M 25	带螺纹		57	HDC 10B SBU 2M25G	<b>1787630000</b>
M 25	带螺纹		74	HDC 24D SBU 2M25G	<b>1787350000</b>
M 32	带螺纹		74	HDC 24D SBU 2M32G	<b>1787360000</b>

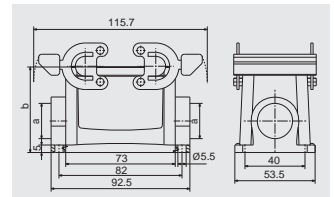

## 对接外壳



a	描述	防尘盖	b (mm)	型号	订货号
M 20	带螺纹		55	HDC 10B KBU 1M20G	<b>1787720000</b>

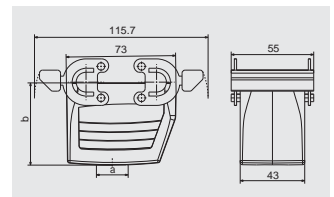

## 防尘盖



描述	型号	订货号
用于插座外壳	HDC 10B DODQ 4B0	<b>1665230000</b>

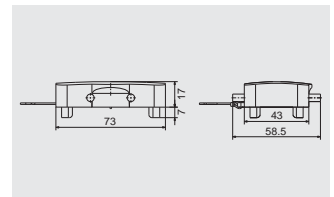

500 V, 16 A, 尺寸 6

16 + ⊕

插芯



弹片联接



插芯	型号	订货号
公	HDC HE 16 MT	1745840000
母	HDC HE 16 FT	1745780000

尺寸

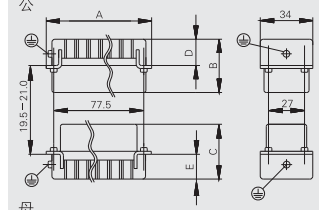

A (mm)	B (mm)	C (mm)	D (mm)	E (mm)
83.30	33.80	33.20	19.10	16.50

插针的排列

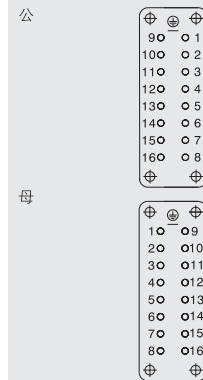

开孔尺寸

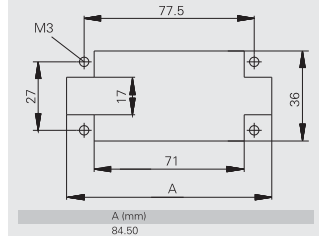

螺钉联接



插芯	型号	订货号
公	HDC HE 16 MS	1207500000
母	HDC HE 16 FS	1207700000

直插式联接



插芯	型号	订货号
公	HDC HE 16 MP	1873570000
母	HDC HE 16 FP	1873560000

冷压联接



插芯	描述	订货号
公	HDC HE 16 MC	1207900000
母	HDC HE 16 FC	1208000000

零配件

冷压插针

表面镀银



表面镀金



数量	公	订货号	母	订货号
100	HDC - C - HE - SM0.5AG	1200500000	HDC - C - HE - BM0.5AG	1201100000
100	HDC - C - HE - SM0.75 - 1AG	1200600000	HDC - C - HE - BM0.75 - 1AG	1201200000
100	HDC - C - HE - SM1.5AG	1200700000	HDC - C - HE - BM1.5AG	1201300000
100	HDC - C - HE - SM2.5AG	1200800000	HDC - C - HE - BM2.5AG	1201400000
100	HDC - C - HE - SM4.0AG	1200900000	HDC - C - HE - BM4.0AG	1201500000
100	HDC - C - HE - SM0.5AU	1651420000	HDC - C - HE - BM0.5AU	1651470000
100	HDC - C - HE - SM0.75 - 1AU	1651430000	HDC - C - HE - BM0.75 - 1AU	1651480000
100	HDC - C - HE - SM1.5AU	1651440000	HDC - C - HE - BM1.5AU	1651490000
100	HDC - C - HE - SM2.5AU	1651450000	HDC - C - HE - BM2.5AU	1651500000
100	HDC - C - HE - SM4.0AU	1651460000	HDC - C - HE - BM4.0AU	1651510000

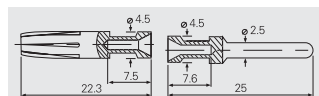

导线截面积

mm <sup>2</sup>	AWG 导线	剥线长度
0.50	20	7.5mm
0.75-1.00	18	7.5mm
1.50	16	7.5mm
2.50	14	7.5mm
4.00	12	7.5mm

工具



压针工具	订货号
CTX CM 1.6/2.5	9018490000
退针工具	订货号
退针工具 HE	1866750000

## RockStar® IP65/IP66外壳选择

## 尺寸6

\*更多外壳,请参阅D章节

## 插头外壳



## 插头外壳, 侧面进线



a	描述	防尘盖	b (mm)	型号	订货号
M 25	带螺纹		61	HDC 16B TSBU 1M25G	1788180000
M 25	带螺纹		76	HDC 40D TSBU 1M25G	1787010000
M 32	带螺纹		76	HDC 40D TSBU 1M32G	1787000000

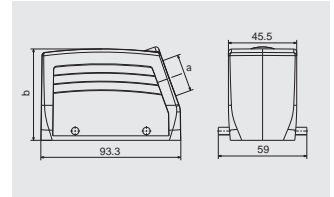

## 插头外壳, 顶部进线



a	描述	防尘盖	b (mm)	型号	订货号
M 25	带螺纹		61	HDC 16B TOBU 1M25G	1788210000
M 25	带螺纹		76	HDC 40D TOBU 1M25G	1787070000
M 32	带螺纹		76	HDC 40D TOBU 1M32G	1787060000

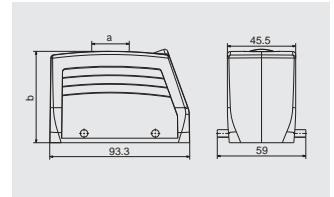

## 防尘盖



描述	型号	订货号
用于插头外壳	HDC 16B DMDQ 2QB	1665270000

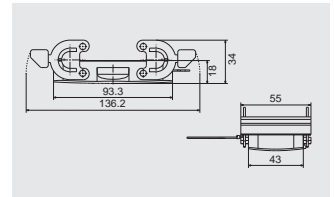

## 底座

## 穿体式插座外壳



描述	防尘盖	b (mm)	型号	订货号
		29	HDC 16B ABU	1208600000

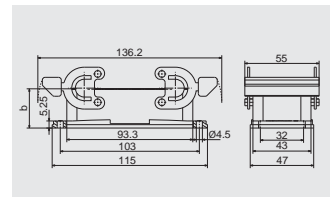

## 底座封闭型插座外壳



a	描述	防尘盖	b (mm)	型号	订货号
M 25	带螺纹		64	HDC 16B SBU 2M25G	1788240000
M 25	带螺纹		84	HDC 40D SBU 2M25G	1787120000
M 32	带螺纹		84	HDC 40D SBU 2M32G	1787110000

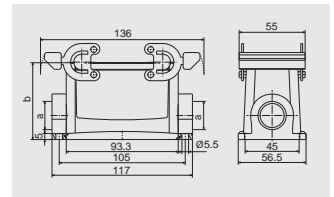

## 对接外壳



a	描述	防尘盖	b (mm)	型号	订货号
M 25	带螺纹		79	HDC 40D KBU 1M25G	1787200000
M 32	带螺纹		79	HDC 40D KBU 1M32G	1787190000

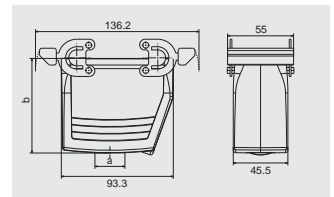

## 防尘盖



描述	型号	订货号
用于插座外壳	HDC 16B DODQ 4B0	1665260000

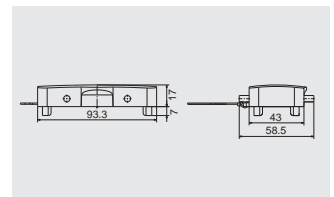

500 V, 16 A, 尺寸 8

24 + ⊕

插芯



弹片联接



插芯	型号	订货号
公	HDC HE 24 MT	1745850000
母	HDC HE 24 FT	1745790000

螺钉联接



插芯	型号	订货号
公	HDC HE 24 MS	1211100000
母	HDC HE 24 FS	1211300000

直插式联接



插芯	型号	订货号
公	HDC HE 24 MP	1873590000
母	HDC HE 24 FP	1873580000

冷压联接



插芯	型号	订货号
公	HDC HE 24 MC	1211500000
母	HDC HE 24 FC	1211600000

零配件

冷压插针

表面镀银



表面镀金



数量	公	订货号	母	订货号
100	HDC-C-HE-SM0.5AG	1200500000	HDC-C-HE-BM0.5AG	1201100000
100	HDC-C-HE-SM0.75-1AG	1200600000	HDC-C-HE-BM0.75-1AG	1201200000
100	HDC-C-HE-SM1.5AG	1200700000	HDC-C-HE-BM1.5AG	1201300000
100	HDC-C-HE-SM2.5AG	1200800000	HDC-C-HE-BM2.5AG	1201400000
100	HDC-C-HE-SM4.0AG	1200900000	HDC-C-HE-BM4.0AG	1201500000
100	HDC-C-HE-SM0.5AU	1651420000	HDC-C-HE-BM0.5AU	1651470000
100	HDC-C-HE-SM0.75-1AU	1651430000	HDC-C-HE-BM0.75-1AU	1651480000
100	HDC-C-HE-SM1.5AU	1651440000	HDC-C-HE-BM1.5AU	1651490000
100	HDC-C-HE-SM2.5AU	1651450000	HDC-C-HE-BM2.5AU	1651500000
100	HDC-C-HE-SM4.0AU	1651460000	HDC-C-HE-BM4.0AU	1651510000

工具



压针工具	订货号
CTX CM 1.6/2.5	9018490000
退针工具	订货号
退针工具 HE	1866750000

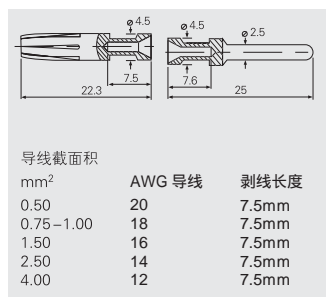
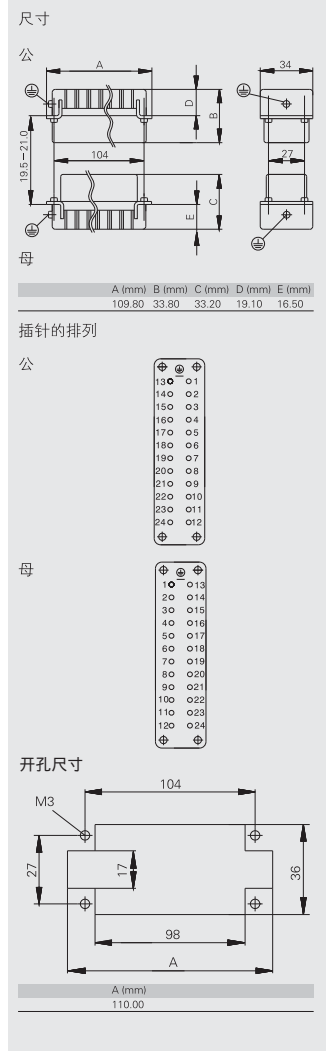

## RockStar® IP65/IP66外壳选择

## 尺寸8

\*更多外壳,请参阅D章节

## 插头外壳



## 插头外壳, 侧面进线



a	描述	防尘盖	b (mm)	型号	订货号
M 25	带螺纹		61	HDC 24B TSBU 1M25G	<b>1787760000</b>
M 32	带螺纹		61	HDC 24B TSBU 1M32G	<b>1787750000</b>
M 25	带螺纹		76	HDC 64D TSBU 1M25G	<b>1786780000</b>
M 32	带螺纹		76	HDC 64D TSBU 1M32G	<b>1786770000</b>

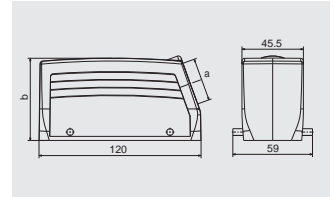

## 插头外壳, 顶部进线



a	描述	防尘盖	b (mm)	型号	订货号
M 25	带螺纹		61	HDC 24B TOBU 1M25G	<b>1787820000</b>
M 32	带螺纹		61	HDC 24B TOBU 1M32G	<b>1787810000</b>
M 32	带螺纹		76	HDC 64D TOBU 1M32G	<b>1786830000</b>

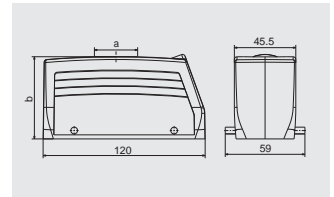

## 防尘盖



描述	型号	订货号
用于插头外壳	HDC 24B DMDQ 2QB	<b>1665640000</b>

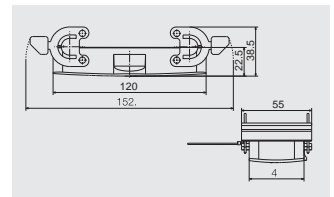

## 底座

## 穿体式插座外壳



描述	防尘盖	b (mm)	型号	订货号
		29,3	HDC 24B ABU	<b>1212400000</b>

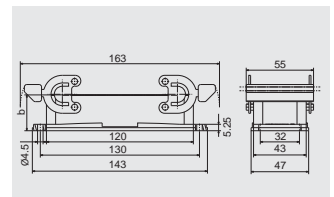

## 底座封闭型插座外壳



a	描述	防尘盖	b (mm)	型号	订货号
M 25	带螺纹		64	HDC 24B SBU 2M25G	<b>1787870000</b>
M 25	带螺纹		84	HDC 64D SBU 2M25G	<b>1786890000</b>
M 32	带螺纹		84	HDC 64D SBU 2M32G	<b>1786880000</b>

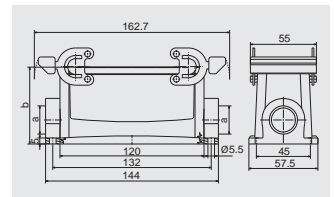

## 对接外壳



a	描述	防尘盖	b (mm)	型号	订货号
M 25	带螺纹		65	HDC 24B KBU 1M25G	<b>1787920000</b>
M 32	带螺纹		79	HDC 64D KBU 1M32G	<b>1786960000</b>

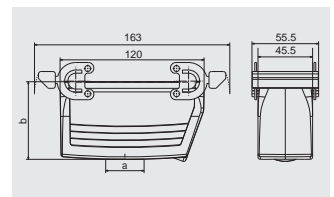

## 防尘盖



描述	型号	订货号
用于插座外壳	HDC 24B DODQ 4B0	<b>1665630000</b>

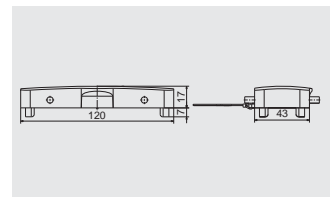

500 V, 16 A, 尺寸 10

32 + ⊕

插芯



弹片联接



插芯	型号	订货号
公	HDC HE 16 MT	1745840000
母	HDC HE 16 FT	1745780000
公	HDC HE 16 MT 17-32	1745860000
母	HDC HE 16 FT 17-32	1745800000

螺钉联接



插芯	型号	订货号
公	HDC HE 16 MS	1207500000
母	HDC HE 16 FS	1207700000
公	HDC HE 16 MS 17-32	1215700000
母	HDC HE 16 FS 17-32	1216100000

直插式联接



插芯	型号	订货号
公	HDC HE 16 MP	1873570000
母	HDC HE 16 FP	1873560000
公	HDC HE 16 MP 17-32	1875800000
母	HDC HE 16 FP 17-32	1875740000

冷压联接



插芯	型号	订货号
公	HDC HE 16 MC	1207900000
母	HDC HE 16 FC	1208000000
公	HDC HE 16 MC 17-32	1216500000
母	HDC HE 16 FC 17-32	1216700000

零配件

冷压插针

表面镀银



表面镀金



数量	公	订货号	母	订货号
100	HDC-C-HE-SM0.5AG	1200500000	HDC-C-HE-BM0.5AG	1201100000
100	HDC-C-HE-SM0.75-1AG	1200600000	HDC-C-HE-BM0.75-1AG	1201200000
100	HDC-C-HE-SM1.5AG	1200700000	HDC-C-HE-BM1.5AG	1201300000
100	HDC-C-HE-SM2.5AG	1200800000	HDC-C-HE-BM2.5AG	1201400000
100	HDC-C-HE-SM4.0AG	1200900000	HDC-C-HE-BM4.0AG	1201500000
100	HDC-C-HE-SM0.5AU	1651420000	HDC-C-HE-BM0.5AU	1651470000
100	HDC-C-HE-SM0.75-1AU	1651430000	HDC-C-HE-BM0.75-1AU	1651480000
100	HDC-C-HE-SM1.5AU	1651440000	HDC-C-HE-BM1.5AU	1651490000
100	HDC-C-HE-SM2.5AU	1651450000	HDC-C-HE-BM2.5AU	1651500000
100	HDC-C-HE-SM4.0AU	1651460000	HDC-C-HE-BM4.0AU	1651510000

工具



压针工具	订货号
CTX CM 1.6/2.5	9018490000
退针工具	订货号
退针工具 HE	1866750000

尺寸

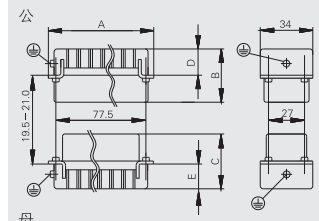

A (mm)	B (mm)	C (mm)	D (mm)	E (mm)
83.30	33.80	33.20	19.10	16.50

插针的排列

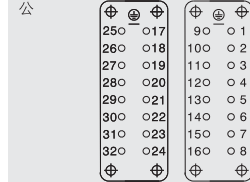

母

开孔尺寸

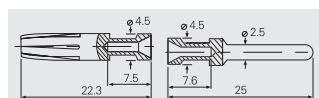
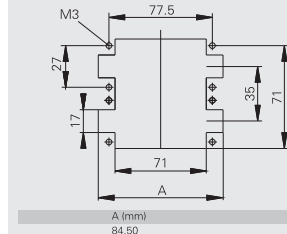

导线截面积

mm <sup>2</sup>	AWG 导线	剥线长度
0.50	20	7.5mm
0.75-1.00	18	7.5mm
1.50	16	7.5mm
2.50	14	7.5mm
4.00	12	7.5mm

## RockStar® IP65/IP66外壳选择

## 尺寸10

\*更多外壳,请参D章节

## 插头外壳



## 插头外壳, 侧面进线



a	描述	防尘盖	b (mm)	型号	订货号
M 32	带螺纹		79	HDC 32B TSLU 1M32G	<b>1788420000</b>

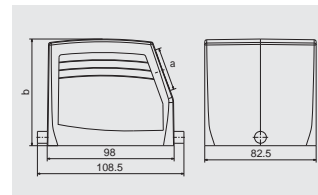

## 底座

## 穿体式插座外壳



描述	防尘盖	b (mm)	型号	订货号
	带	55	HDC 32B ADLU	<b>1219800000</b>
		38	HDC 32B ALU	<b>1219500000</b>

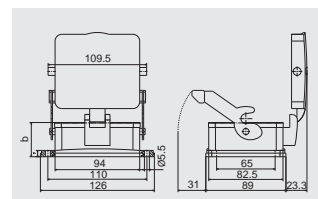

## 底座封闭式插座外壳



a	描述	防尘盖	b (mm)	型号	订货号
M 32	带螺纹	带	96	HDC 32B SDLU 2M32G	<b>1788490000</b>
M 32	带螺纹		79	HDC 32B SLU 2M32G	<b>1788470000</b>

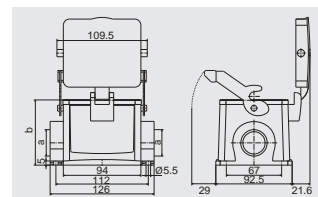

## 对接外壳



a	描述	防尘盖	b (mm)	型号	订货号
M 32	带螺纹		83	HDC 32B KLU 1M32G	<b>1788500000</b>

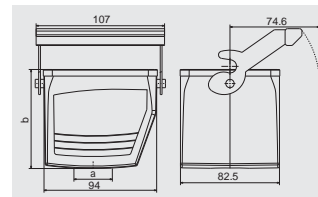



500 V, 16 A, 尺寸 12

48 + ⊕

插芯



弹片联接



插芯	型号	订货号
公	HDC HE 24 MT	1745850000
母	HDC HE 24 FT	1745790000
公	HDC HE 24 MT 25-48	1745870000
母	HDC HE 24 FT 25-48	1745810000

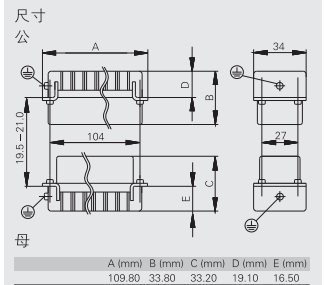

螺钉联接



插芯	型号	订货号
公	HDC HE 24 MS	1211300000
母	HDC HE 24 FS	1211300000
公	HDC HE 24 MS 25-48	1220800000
母	HDC HE 24 FS 25-48	1221200000



插针的排列

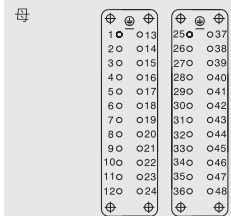
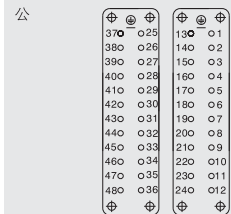

直插式联接

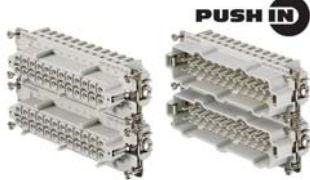

插芯	型号	订货号
公	HDC HE 24 MP	1873590000
母	HDC HE 24 FP	1873580000
公	HDC HE 24 MP 25-48	1875890000
母	HDC HE 24 FP 25-48	1875850000

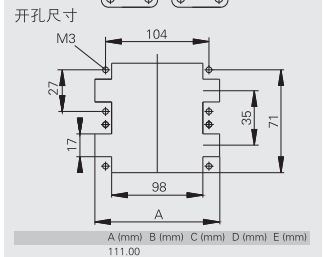

冷压联接



插芯	型号	订货号
公	HDC HE 24 MC	1211500000
母	HDC HE 24 FC	1211600000
公	HDC HE 24 MC 25-48	1226400000
母	HDC HE 24 FC 25-48	1226600000

零配件

冷压插针

表面镀银



表面镀金



数量	公	订货号	母	订货号
100	HDC-C-HE-SM0.5AG	1200500000	HDC-C-HE-BM0.5AG	1201100000
100	HDC-C-HE-SM0.75-1AG	1200600000	HDC-C-HE-BM0.75-1AG	1201200000
100	HDC-C-HE-SM1.5AG	1200700000	HDC-C-HE-BM1.5AG	1201300000
100	HDC-C-HE-SM2.5AG	1200800000	HDC-C-HE-BM2.5AG	1201400000
100	HDC-C-HE-SM4.0AG	1200900000	HDC-C-HE-BM4.0AG	1201500000
100	HDC-C-HE-SM0.5AU	1651420000	HDC-C-HE-BM0.5AU	1651470000
100	HDC-C-HE-SM0.75-1AU	1651430000	HDC-C-HE-BM0.75-1AU	1651480000
100	HDC-C-HE-SM1.5AU	1651440000	HDC-C-HE-BM1.5AU	1651490000
100	HDC-C-HE-SM2.5AU	1651450000	HDC-C-HE-BM2.5AU	1651500000
100	HDC-C-HE-SM4.0AU	1651460000	HDC-C-HE-BM4.0AU	1651510000

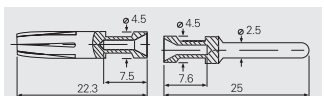

导线截面积	AWG 导线	剥线长度
mm <sup>2</sup>		
0.50	20	7.5mm
0.75-1.00	18	7.5mm
1.50	16	7.5mm
2.50	14	7.5mm
4.00	12	7.5mm

工具



压针工具	订货号
CTX CM 1.6/2.5	9018490000
退针工具	订货号
退针工具 HE	1866750000

## RockStar® IP65/IP66外壳选择

## 尺寸12

\*更多外壳,请参阅D章节

## 插头外壳



## 插头外壳, 侧面进线



a	描述	防尘盖	b (mm)	型号	订货号
M 32	带螺纹		94	HDC 48B TSLU 1M32G	<b>1788320000</b>
M 40	带螺纹		94	HDC 48B TSLU 1M40G	<b>1788310000</b>
M 50	带螺纹		94	HDC 48B TSLU 1M50G	<b>1788300000</b>

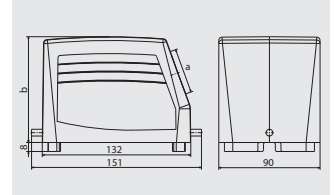

## 插头外壳, 顶部进线



a	描述	防尘盖	b (mm)	型号	订货号
M 32	带螺纹		94	HDC 48B TOLU 1M32G	<b>1788350000</b>
M 50	带螺纹		94	HDC 48B TOLU 1M50G	<b>1788330000</b>

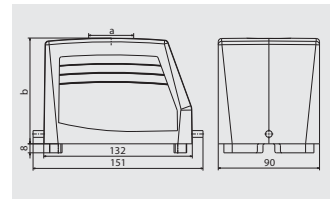

## 底座

## 穿体式插座外壳



描述	防尘盖	b (mm)	型号	订货号
	带	62	HDC 48B ADLU	<b>1222900000</b>

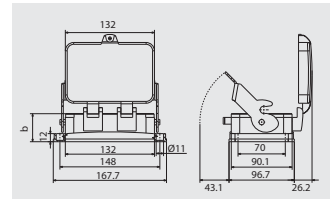

## 底座封闭型插座外壳



a	描述	防尘盖	b (mm)	型号	订货号
M 32	带螺纹	带	120	HDC 48B SDLU 2M32G	<b>1788390000</b>
M 32	带螺纹		100	HDC 48B SLU 2M32G	<b>1788370000</b>
M 40	带螺纹		100	HDC 48B SLU 2M40G	<b>1788360000</b>

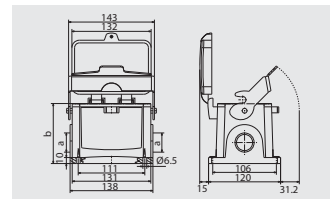

# HEE系列 紧凑型插芯

当你只有较小的安装空间，而同时需要保持较高的电气特性，HEE系列将会是你的选择！

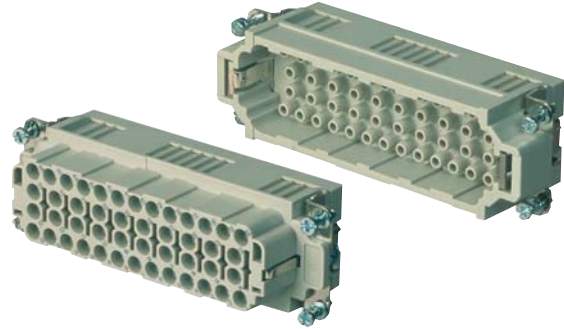

## 技术参数





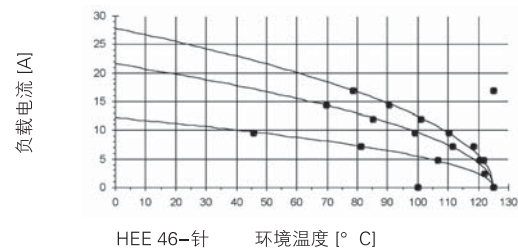
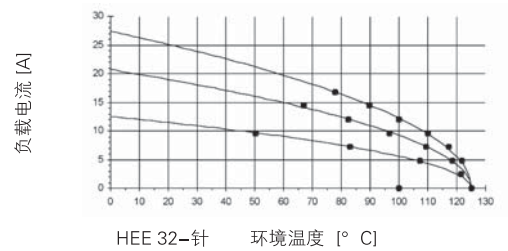
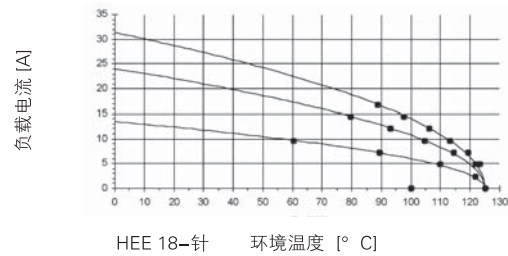
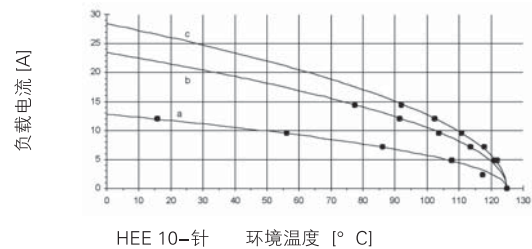





标准/认证	
标准	DIN EN 61984 DIN EN 60664-1
认证	UL/CSA
插芯	
插针数	10, 18, 32, 46, 64 (+PE)
额定电压	500 V
据UL/CSA制定的额定电压	600 V
额定电流	16 A
额定脉冲电压	6 kV
污染等级	3
绝缘阻抗	$\geq 10^{10} \Omega$
材料	玻璃纤维增强型PC
温度范围	-40 °C ... +125 °C
据UL94制定的阻燃等级	V0
机械寿命	
-插孔银表面	$\geq 500$
-插孔金表面	$\geq 500$
接触阻抗	
-冷压联接	$\leq 4 \text{ m}\Omega$
插针材料	
材料	铜合金
表面	惰性银或镀金
接线范围	
-软导线	0.5 – 4 mm <sup>2</sup> (AWG 20 ... 12)
-剥线长度	7,5 mm
PE联接	
-接线范围	0.5 ... 4 mm <sup>2</sup>
-硬导线	0.5 ... 4 mm <sup>2</sup> / 0.5 ... 4 mm <sup>2</sup>
-软导线 (带或不带端头)	0.5 ... 4 mm <sup>2</sup> / 0.5 ... 4 mm <sup>2</sup>
-AWG导线	AWG 20 .. 12
-剥线长度	10 mm
-拧紧转矩	1.2 ... 1.5 Nm
-螺丝刀头尺寸	SD 0.8 x 4 mm或者PZ 1

## 电流曲线



曲线 a: 0.5 mm<sup>2</sup> 导线  
曲线 b: 2.5 mm<sup>2</sup> 导线  
曲线 c: 4.0 mm<sup>2</sup> 导线

## 总览

		尺寸	额定电压	额定电流	插针数	弹片联接	螺钉联系	冷压联接	直插式联接	同轴联接	页码
		3	500 V	16 A	10 + ⊕			•			B.32
		4	500 V	16 A	18 + ⊕			•			B.34
		6	500 V	16 A	32 + ⊕			•			B.36
		8	500 V	16 A	46 + ⊕			•			B.38
		10	500 V	16 A	64 + ⊕			•			B.40

500 V, 16 A, 尺寸 3

10 + ⊕

插芯



冷压联接



插芯	型号	订货
公	HDC HEE 10 SCM	<b>1826830000</b>
母	HDC HEE 10 BCM	<b>1826840000</b>

尺寸

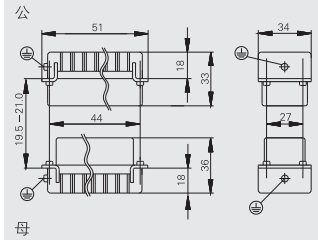

插针的排列

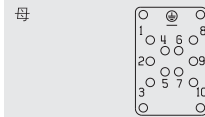
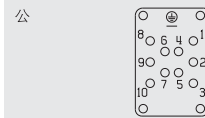

开孔尺寸

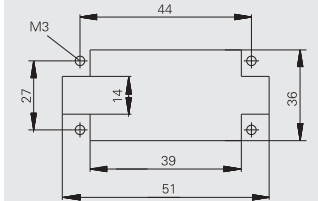

零配件

冷压插针

表面镀银



表面镀金



数量	公	订货号	母	订货号
100	HDC-C-HE-SM0.5AG	<b>1200500000</b>	HDC-C-HE-BM0.5AG	<b>1201100000</b>
100	HDC-C-HE-SM0.75-1AG	<b>1200600000</b>	HDC-C-HE-BM0.75-1AG	<b>1201200000</b>
100	HDC-C-HE-SM1.5AG	<b>1200700000</b>	HDC-C-HE-BM1.5AG	<b>1201300000</b>
100	HDC-C-HE-SM2.5AG	<b>1200800000</b>	HDC-C-HE-BM2.5AG	<b>1201400000</b>
100	HDC-C-HE-SM4.0AG	<b>1200900000</b>	HDC-C-HE-BM4.0AG	<b>1201500000</b>
100	HDC-C-HE-SM0.5AU	<b>1651420000</b>	HDC-C-HE-BM0.5AU	<b>1651470000</b>
100	HDC-C-HE-SM0.75-1AU	<b>1651430000</b>	HDC-C-HE-BM0.75-1AU	<b>1651480000</b>
100	HDC-C-HE-SM1.5AU	<b>1651440000</b>	HDC-C-HE-BM1.5AU	<b>1651490000</b>
100	HDC-C-HE-SM2.5AU	<b>1651450000</b>	HDC-C-HE-BM2.5AU	<b>1651500000</b>
100	HDC-C-HE-SM4.0AU	<b>1651460000</b>	HDC-C-HE-BM4.0AU	<b>1651510000</b>

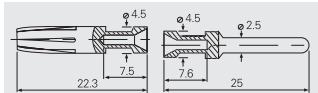

导线截面积

mm <sup>2</sup>	AWG 导线	剥线长度
0.50	20	7.5mm
0.75-1.00	18	7.5mm
1.50	16	7.5mm
2.50	14	7.5mm
4.00	12	7.5mm

工具



压针工具	订货号
CTX CM 1.6/2.5	<b>9018490000</b>
退针工具	订货号
退针工具 HE	<b>1866750000</b>

## RockStar® IP65/IP66外壳选择

## 尺寸3

\*更多外壳,请参阅D章节

## 插头外壳



## 插头外壳, 侧面进线



a	描述	防尘盖	b (mm)	型号	订货号
M 20	带螺纹		52	HDC 06B TSLU 1M20G	<b>1788100000</b>
M 25	带螺纹		52	HDC 06B TSLU 1M25G	<b>1788090000</b>
M 25	带螺纹		72	HDC 16D TSLU 1M25G	<b>1787480000</b>

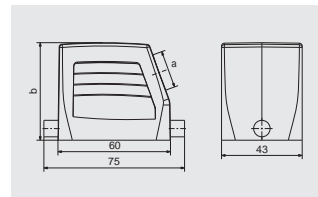

## 插头外壳, 顶部进线



a	描述	防尘盖	b (mm)	型号	订货号
M 20	带螺纹		52	HDC 06B TOLU 1M20G	<b>1788120000</b>
M 25	带螺纹		52	HDC 06B TOLU 1M25G	<b>1788110000</b>
M 25	带螺纹		72	HDC 16D TOLU 1M25G	<b>1787500000</b>
M 32	带螺纹		72	HDC 16D TOLU 1M32G	<b>1787490000</b>

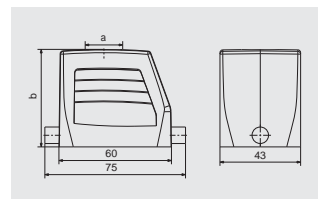

## 防尘盖



描述	型号	订货号
用于插头外壳	HDC 06B DMDL 1LB	<b>1665210000</b>

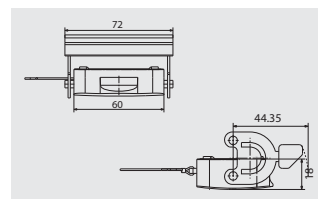

## 底座

## 穿体式插座外壳



描述	防尘盖	b (mm)	型号	订货号
		29	HDC 06B ALU	<b>1202100000</b>
	带	47	HDC 06B ADLU	<b>1202500000</b>

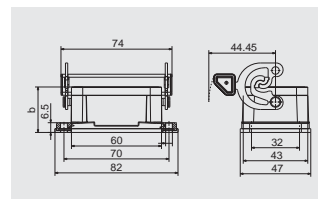

## 底座封闭式插座外壳



a	描述	防尘盖	b (mm)	型号	订货号
M 20	带螺纹		54	HDC 06B SLU 2M20G	<b>1788140000</b>
M 20	带螺纹	带	72	HDC 06B SDLU 2M20G	<b>1788170000</b>
M 25	带螺纹		54	HDC 06B SLU 2M25G	<b>1788130000</b>
M 25	带螺纹	带	72	HDC 06B SDLU 2M25G	<b>1788160000</b>

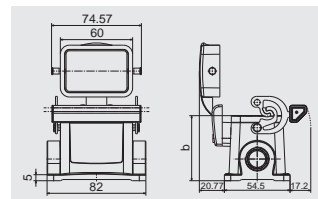

## 防尘盖



描述	型号	订货号
用于插座外壳	HDC 06B DODL 2BO	<b>1665200000</b>

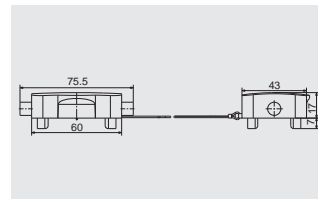

500 V, 16 A, 尺寸 4

18 + ⊕

插芯



冷压联接



插芯	型号	订货号
公	HDC HEE 18 SCM	1826810000
母	HDC HEE 18 BCM	1826820000

尺寸

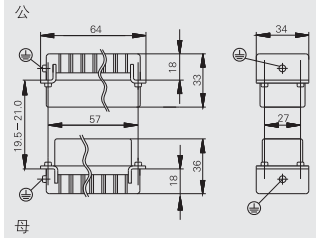

插芯的排列

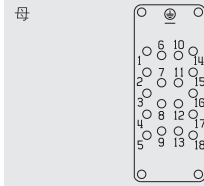
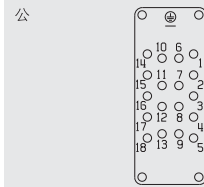

Mounting cut-out

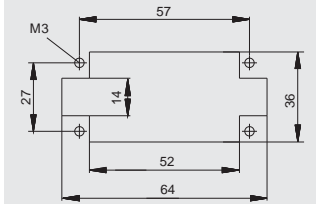

零配件

冷压插针

表面镀银



表面镀金



数量	公	订货号	母	订货号
100	HDC - C - HE - SM0.5AG	1200500000	HDC - C - HE - BM0.5AG	1201100000
100	HDC - C - HE - SM0.75 - 1AG	1200600000	HDC - C - HE - BM0.75 - 1AG	1201200000
100	HDC - C - HE - SM1.5AG	1200700000	HDC - C - HE - BM1.5AG	1201300000
100	HDC - C - HE - SM2.5AG	1200800000	HDC - C - HE - BM2.5AG	1201400000
100	HDC - C - HE - SM4.0AG	1200900000	HDC - C - HE - BM4.0AG	1201500000
100	HDC - C - HE - SM0.5AU	1651420000	HDC - C - HE - BM0.5AU	1651470000
100	HDC - C - HE - SM0.75 - 1AU	1651430000	HDC - C - HE - BM0.75 - 1AU	1651480000
100	HDC - C - HE - SM1.5AU	1651440000	HDC - C - HE - BM1.5AU	1651490000
100	HDC - C - HE - SM2.5AU	1651450000	HDC - C - HE - BM2.5AU	1651500000
100	HDC - C - HE - SM4.0AU	1651460000	HDC - C - HE - BM4.0AU	1651510000

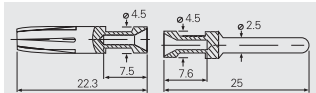

导线截面积

mm <sup>2</sup>	AWG 导线	剥线长度
0.50	20	7.5mm
0.75 - 1.00	18	7.5mm
1.50	16	7.5mm
2.50	14	7.5mm
4.00	12	7.5mm

工具



压针工具	订货号
CTX CM 1.6/2.5	9018490000
C退针工具	订货号
退针工具 HE	1866750000

## RockStar® IP65/IP66外壳选择

## 尺寸4

\*更多外壳,请参阅D章节

## 插头外壳

## 插头外壳, 侧面进线



a	描述	防尘盖	b (mm)	型号	订货号
M 20	带螺纹		52	HDC 10B TSBU 1M20G	1787560000
M 25	带螺纹		52	HDC 10B TSBU 1M25G	1787550000
M 25	带螺纹		72	HDC 24D TSBU 1M25G	1787240000
M 32	带螺纹		72	HDC 24D TSBU 1M32G	1787230000

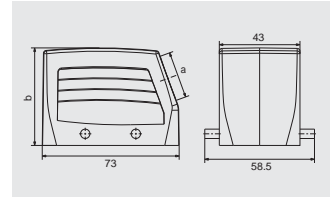

## 插头外壳, 顶部进线



a	描述	防尘盖	b (mm)	型号	订货号
M 20	带螺纹		52	HDC 10B TOBU 1M20G	1787600000
M 25	带螺纹		52	HDC 10B TOBU 1M25G	1787590000
M 25	带螺纹		72	HDC 24D TOBU 1M25G	1787300000
M 32	带螺纹		72	HDC 24D TOBU 1M32G	1787290000

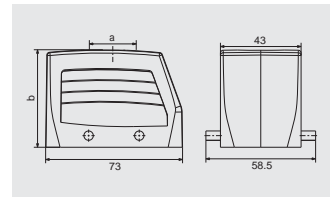

## 防尘盖



描述	型号	订货号
用于插头外壳	HDC 10B DMDQ 2QB	1665240000

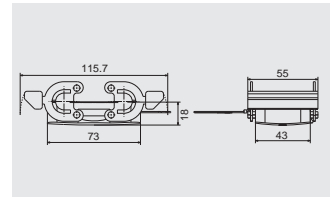

## 底座

## 穿体式插座外壳



描述	防尘盖	b (mm)	型号	订货号
		29.3	HDC 10B ABU	1205000000

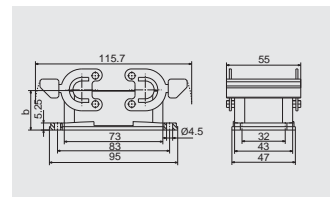

## 底座封闭式插座外壳



a	描述	防尘盖	b (mm)	型号	订货号
M 20	带螺纹		57	HDC 10B SBU 2M20G	1787640000
M 25	带螺纹		57	HDC 10B SBU 2M25G	1787630000
M 25	带螺纹		74	HDC 24D SBU 2M25G	1787350000
M 32	带螺纹		74	HDC 24D SBU 2M32G	1787360000

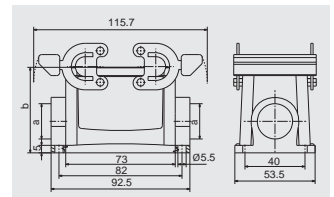

## 对接外壳



a	描述	防尘盖	b (mm)	型号	订货号
M 20	带螺纹		55	HDC 10B KBU 1M20G	1787720000

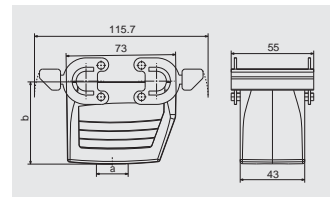

## 防尘盖



描述	型号	订货号
用于插座外壳	HDC 10B DODQ 4BO	1665230000

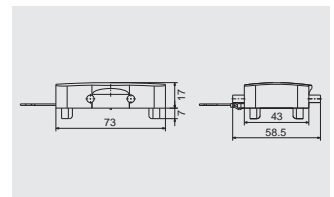



500 V, 16 A, 尺寸 6

32 + ⊕

插芯



冷压联接



插芯	型号	订货号
公	HDC HEE 32 SCM	<b>1826790000</b>
母	HDC HEE 32 BCM	<b>1826800000</b>

尺寸

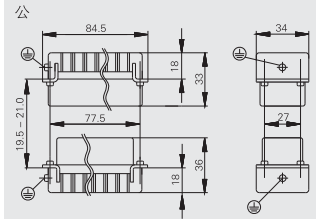

母

插针的排列

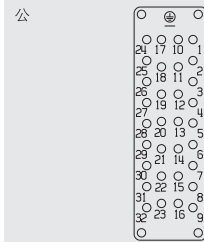

母

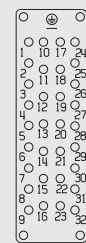

开孔尺寸

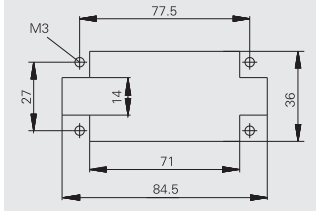

工具

冷压插针

表面镀银



表面镀金



数量	公	订货号	母	订货号
100	HDC - C - HE - SM0.5AG	<b>1200500000</b>	HDC - C - HE - BM0.5AG	<b>1201100000</b>
100	HDC - C - HE - SM0.75 - 1AG	<b>1200600000</b>	HDC - C - HE - BM0.75 - 1AG	<b>1201200000</b>
100	HDC - C - HE - SM1.5AG	<b>1200700000</b>	HDC - C - HE - BM1.5AG	<b>1201300000</b>
100	HDC - C - HE - SM2.5AG	<b>1200800000</b>	HDC - C - HE - BM2.5AG	<b>1201400000</b>
100	HDC - C - HE - SM4.0AG	<b>1200900000</b>	HDC - C - HE - BM4.0AG	<b>1201500000</b>
100	HDC - C - HE - SM0.5AU	<b>1651420000</b>	HDC - C - HE - BM0.5AU	<b>1651470000</b>
100	HDC - C - HE - SM0.75 - 1AU	<b>1651430000</b>	HDC - C - HE - BM0.75 - 1AU	<b>1651480000</b>
100	HDC - C - HE - SM1.5AU	<b>1651440000</b>	HDC - C - HE - BM1.5AU	<b>1651490000</b>
100	HDC - C - HE - SM2.5AU	<b>1651450000</b>	HDC - C - HE - BM2.5AU	<b>1651500000</b>
100	HDC - C - HE - SM4.0AU	<b>1651460000</b>	HDC - C - HE - BM4.0AU	<b>1651510000</b>

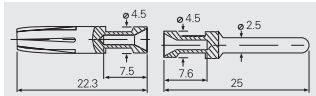

导线截面积

mm <sup>2</sup>	AWG 导线	剥线长度
0.50	20	7.5mm
0.75 - 1.00	18	7.5mm
1.50	16	7.5mm
2.50	14	7.5mm
4.00	12	7.5mm

工具



压针工具	订货号
CTX CM 1.6/2.5	<b>9018490000</b>
退针工具	订货号
退针工具 HE	<b>1866750000</b>

## RockStar® IP65/IP66外壳选择

## 尺寸6

\*更多外壳,请参阅D章节

## 插头外壳

## 插头外壳, 侧面进线



a	描述	防尘盖	b (mm)	型号	订货号
M 25	带螺纹		61	HDC 16B TSBU 1M25G	<b>1788180000</b>
M 25	带螺纹		76	HDC 40D TSBU 1M25G	<b>1787010000</b>
M 32	带螺纹		76	HDC 40D TSBU 1M32G	<b>1787000000</b>

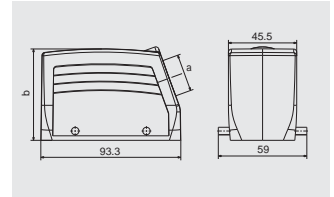

## 插头外壳, 顶部进线



a	描述	防尘盖	b (mm)	型号	订货号
M 25	带螺纹		61	HDC 16B TOBU 1M25G	<b>1788210000</b>
M 25	带螺纹		76	HDC 40D TOBU 1M25G	<b>1787070000</b>
M 32	带螺纹		76	HDC 40D TOBU 1M32G	<b>1787060000</b>

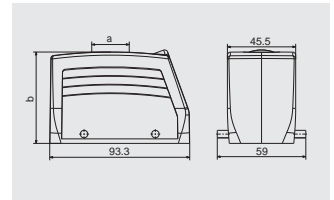

## 防尘盖



描述	型号	订货号
用于插头外壳	HDC 16B DMDQ 2QB	<b>1665270000</b>

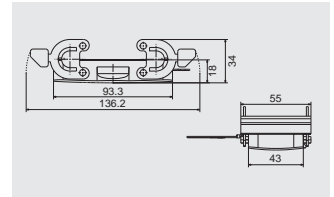

## 底座

## 穿体式插座外壳



描述	防尘盖	b (mm)	型号	订货号
		29	HDC 16B ABU	<b>1208600000</b>

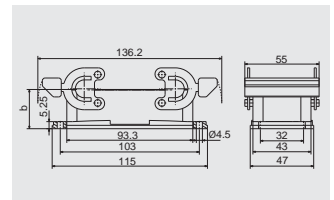

## 底座封闭式插座外壳



a	描述	防尘盖	b (mm)	型号	订货号
M 25	带螺纹		64	HDC 16B SBU 2M25G	<b>1788240000</b>
M 25	带螺纹		84	HDC 40D SBU 2M25G	<b>1787120000</b>
M 32	带螺纹		84	HDC 40D SBU 2M32G	<b>1787110000</b>

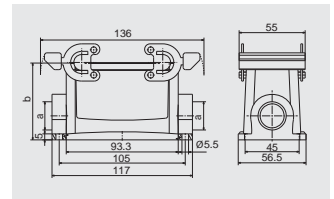

## 对接外壳



a	描述	防尘盖	b (mm)	型号	订货号
M 25	带螺纹		79	HDC 40D KBU 1M25G	<b>1787200000</b>
M 32	带螺纹		79	HDC 40D KBU 1M32G	<b>1787190000</b>

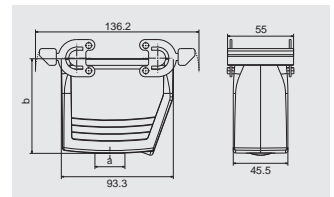

## 防尘盖



描述	型号	订货号
用于插座外壳	HDC 16B DODQ 4B0	<b>1665260000</b>

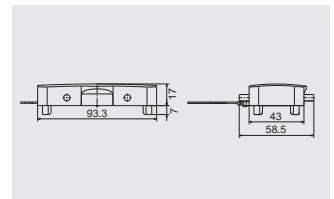

500 V, 16 A, 尺寸 8

46 + ⊕

插芯

冷压联接



插芯	型号	订货号
公	HDC HEE 46 SCM	<b>1826770000</b>
母	HDC HEE 46 BCM	<b>1826780000</b>

尺寸

公

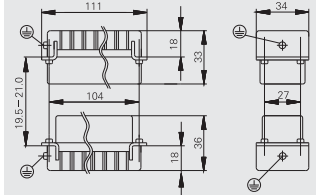

母

插针的排列

公

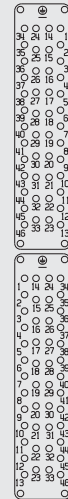

母

Mounting cut-out

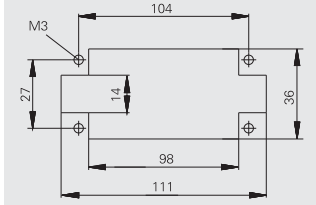

零配件

冷压插针

表面镀银



表面镀金



数量	公	订货号	母	订货号
100	HDC - C - HE - SM0.5AG	<b>1200500000</b>	HDC - C - HE - BM0.5AG	<b>1201100000</b>
100	HDC - C - HE - SM0.75 - 1AG	<b>1200600000</b>	HDC - C - HE - BM0.75 - 1AG	<b>1201200000</b>
100	HDC - C - HE - SM1.5AG	<b>1200700000</b>	HDC - C - HE - BM1.5AG	<b>1201300000</b>
100	HDC - C - HE - SM2.5AG	<b>1200800000</b>	HDC - C - HE - BM2.5AG	<b>1201400000</b>
100	HDC - C - HE - SM4.0AG	<b>1200900000</b>	HDC - C - HE - BM4.0AG	<b>1201500000</b>
100	HDC - C - HE - SM0.5AU	<b>1651420000</b>	HDC - C - HE - BM0.5AU	<b>1651470000</b>
100	HDC - C - HE - SM0.75 - 1AU	<b>1651430000</b>	HDC - C - HE - BM0.75 - 1AU	<b>1651480000</b>
100	HDC - C - HE - SM1.5AU	<b>1651440000</b>	HDC - C - HE - BM1.5AU	<b>1651490000</b>
100	HDC - C - HE - SM2.5AU	<b>1651450000</b>	HDC - C - HE - BM2.5AU	<b>1651500000</b>
100	HDC - C - HE - SM4.0AU	<b>1651460000</b>	HDC - C - HE - BM4.0AU	<b>1651510000</b>

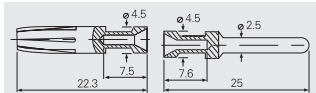

导线截面积

mm <sup>2</sup>	AWG 导线	剥线长度
0.50	20	7.5mm
0.75 - 1.00	18	7.5mm
1.50	16	7.5mm
2.50	14	7.5mm
4.00	12	7.5mm

工具



压针工具	订货号
CTX CM 1.6/2.5	<b>9018490000</b>
退针工具	订货号
退针工具 HE	<b>1866750000</b>

## RockStar® IP65/IP66外壳选择

## 尺寸8

\*更多外壳,请参阅D章节

## 插头外壳



## 插头外壳, 侧面进线



a	描述	防尘盖	b (mm)	型号	订货号
M 25	带螺纹		61	HDC 24B TSBU 1M25G	<b>1787760000</b>
M 32	带螺纹		61	HDC 24B TSBU 1M32G	<b>1787750000</b>
M 25	带螺纹		76	HDC 64D TSBU 1M25G	<b>1786780000</b>
M 32	带螺纹		76	HDC 64D TSBU 1M32G	<b>1786770000</b>

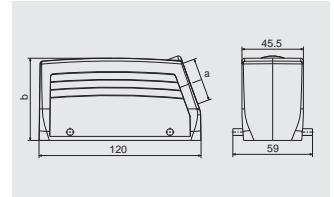

## 插头外壳, 顶部进线



a	描述	防尘盖	b (mm)	型号	订货号
M 25	带螺纹		61	HDC 24B TOBU 1M25G	<b>1787820000</b>
M 32	带螺纹		61	HDC 24B TOBU 1M32G	<b>1787810000</b>
M 32	带螺纹		76	HDC 64D TOBU 1M32G	<b>1786830000</b>

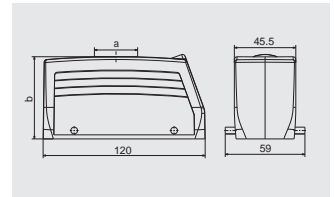

## 防尘盖



描述	型号	订货号
用于插头外壳	HDC 24B DMDQ 2QB	<b>1665640000</b>

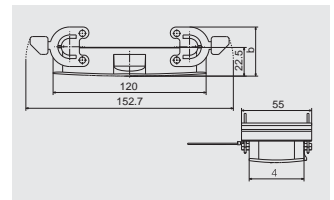

## 底座

## 穿体式插座外壳



描述	防尘盖	b (mm)	型号	订货号
		29.3	HDC 24B ABU	<b>1212400000</b>

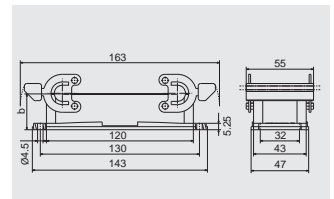

## 底座封闭式插座外壳



a	描述	防尘盖	b (mm)	型号	订货号
M 25	带螺纹		64	HDC 24B SBU 2M25G	<b>1787870000</b>
M 25	带螺纹		84	HDC 64D SBU 2M25G	<b>1786890000</b>
M 32	带螺纹		84	HDC 64D SBU 2M32G	<b>1786880000</b>

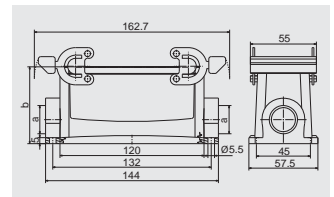

## 对接外壳



a	描述	防尘盖	b (mm)	型号	订货号
M 25	带螺纹		65	HDC 24B KBU 1M25G	<b>1787920000</b>
M 32	带螺纹		79	HDC 64D KBU 1M32G	<b>1786960000</b>

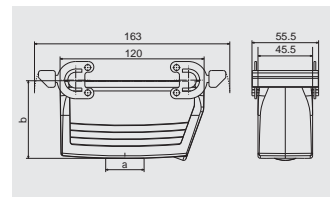

## 防尘盖



描述	型号	订货号
用于插座外壳	HDC 24B DODQ 4BO	<b>1665630000</b>

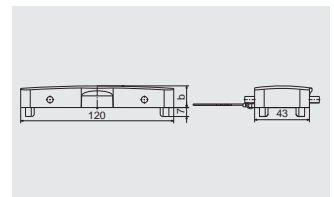

500 V, 16 A, 尺寸 10

64 + ⊕

插芯

冷压联接



插芯	型号	订货号
公	HDC HEE 32 SCM	1826790000
母	HDC HEE 32 BCM	1826800000
公	HDC HEE 32 SCM 33-64	1018950000
母	HDC HEE 32 BCM 33-64	1018960000

尺寸

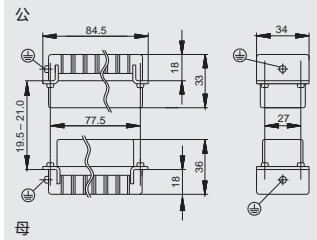

插针的排列

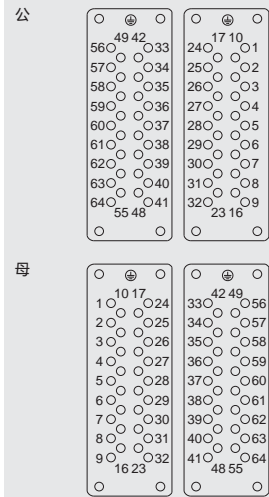

Mounting cut-out

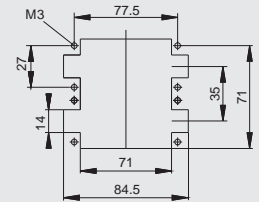

零配件

冷压插针

表面镀银



表面镀金



数量	公	订货号	母	订货号
100	HDC-C-HE-SM0.5AG	1200500000	HDC-C-HE-BM0.5AG	1201100000
100	HDC-C-HE-SM0.75-1AG	1200600000	HDC-C-HE-BM0.75-1AG	1201200000
100	HDC-C-HE-SM1.5AG	1200700000	HDC-C-HE-BM1.5AG	1201300000
100	HDC-C-HE-SM2.5AG	1200800000	HDC-C-HE-BM2.5AG	1201400000
100	HDC-C-HE-SM4.0AG	1200900000	HDC-C-HE-BM4.0AG	1201500000
100	HDC-C-HE-SM0.5AU	1651420000	HDC-C-HE-BM0.5AU	1651470000
100	HDC-C-HE-SM0.75-1AU	1651430000	HDC-C-HE-BM0.75-1AU	1651480000
100	HDC-C-HE-SM1.5AU	1651440000	HDC-C-HE-BM1.5AU	1651490000
100	HDC-C-HE-SM2.5AU	1651450000	HDC-C-HE-BM2.5AU	1651500000
100	HDC-C-HE-SM4.0AU	1651460000	HDC-C-HE-BM4.0AU	1651510000

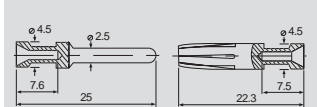

导线截面积	AWG 导线	剥线长度
0.50 mm <sup>2</sup>	AWG 20	7.5 mm
0.75 - 1.00 mm <sup>2</sup>	AWG 18	7.5 mm
1.50 mm <sup>2</sup>	AWG 16	7.5 mm
2.50 mm <sup>2</sup>	AWG 14	7.5 mm
4.00 mm <sup>2</sup>	AWG 12	7.5 mm

工具



压针工具	订货号
退针工具	9018490000
退针工具 HE	1866750000

## RockStar® IP65/IP66外壳选择

## 尺寸10

\*更多外壳,请参阅D章节

## 插头外壳



## 插头外壳, 侧面进线



a	描述	防尘盖	b (mm)	型号	订货号
M32	带螺纹	不带	79	HDC 32B TSLU 1M32G	<b>1788420000</b>

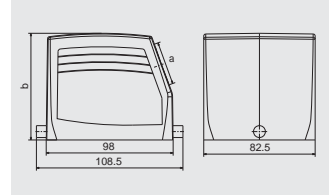

## 底座

## 穿体式插座外壳



描述	防尘盖	b (mm)	型号	订货号
	带	55	HDC 32B ADLU	<b>1219800000</b>
	不带	38	HDC 32B ALU	<b>1219500000</b>

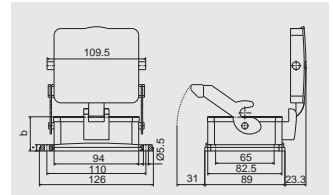

## 底座封闭式插座外壳



a	描述	防尘盖	b (mm)	型号	订货号
M32	带螺纹	带	96	HDC 32B SDLU 2M32G	<b>1788490000</b>
M32	带螺纹	不带	79	HDC 32B SLU 2M32G	<b>1788470000</b>

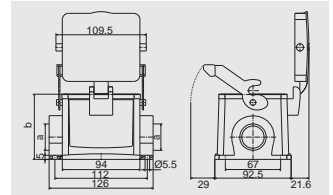

## 对接外壳



a	描述	防尘盖	b (mm)	型号	订货号
M32	带螺纹	带	83	HDC 32B KLU 1M32G	<b>1788500000</b>

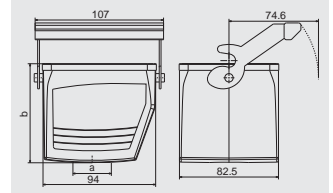

# HD 高密型插芯

HD系列是过程信号联接的理想接插件，HD插芯不仅可以使  
用冲压型或车削型插针、插套，同时也可联接光纤联接件。允许  
选择不同的联接介质！



## 技术参数

标准/认证	
标准	DIN EN 61984 DIN EN 60664 - 1
认证	UL/CSA
插芯	
插针数	7, 8, 15, 16, 20, 25, 40, 50, 64, 80, 128 (+PE)
额定电压	42 V / 250 V
据UL/CSA制定的额定电压	600 V
额定电流	10 A
额定脉冲电压	4 kV
污染等级	3
绝缘阻抗	10 <sup>10</sup>
材料	玻璃纤维增强型PC
温度范围	-40 °C ... +125 °C
据UL94制定的阻燃等级	V0
机械寿命	
- 插孔银表面	500
- 插孔金表面	500
接触阻抗	
- 冷压联接	4 m
插针/材料	
材料	铜合金
表面	惰性银或镀金
接线范围	
- 软导线	0.14 - 2.5 mm <sup>2</sup> (AWG 26 ... 14)
- 剥线长度	8.0 mm
PE联接	
- 接线范围	0.5 ... 2.5 mm <sup>2</sup>
- 硬导线	0.5 ... 2.5 mm <sup>2</sup> / 0.5 ... 2.5 mm <sup>2</sup>
- 软导线 (带或不带端头)	0.5 ... 2.5 mm <sup>2</sup> / 0.5 ... 2.5 mm <sup>2</sup>
- AWG导体	AWG 20 ... 14
- 剥线长度	10 mm
- 拧紧转矩	1.2 ... 1.5 Nm
- 螺丝刀头尺寸	SD 0.8 x 4 mm 或者 PZ 1

## 电流曲线

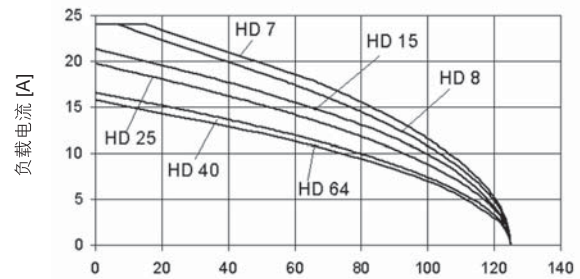

HD 车削式冷插针 1.5 mm<sup>2</sup> 环境温度 [°C]

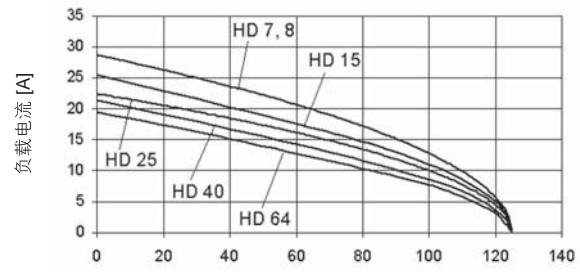

HD 车削式冷插针 2.5 mm<sup>2</sup> 环境温度 [°C]

## 总揽

		尺寸	额定电压	额定电流	插针数	弹片联接	螺钉联系	冷压联接	直插式联接	同轴联接	页码
		1	250 V	10 A	7 + ⊕			•			B.44
		1	42 V	10 A	8			•			B.46
		2	250 V	10 A	15 + ⊕			•			B.48
		3	250 V	10 A	16 + ⊕			•			B.50
		4	250 V	10 A	24 + ⊕			•			B.52
		5	250 V	10 A	25 + ⊕			•			B.54
		6	250 V	10 A	40 + ⊕			•			B.56
		7	250 V	10 A	50 + ⊕			•			B.58
		8	250 V	10 A	64 + ⊕			•			B.60
		10	250 V	10 A	80 + ⊕			•			B.62
		12	250 V	10 A	128 + ⊕			•			B.64



250 V, 10 A, 尺寸 1

7 + ⊕

插芯



冷压联接



插芯	型号	订货号
公	HDC HD 7 MC	<b>1650570000</b>
母	HDC HD 7 FC	<b>1650580000</b>

尺寸  
公

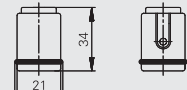

母

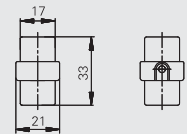

插针的排列

公



母



### 零配件

冷压插针

表面镀银



表面镀金



数量	公	订货号	母	订货号
100	HDC - C - HD - SM0.14 - 0.37AG	<b>1651520000</b>	HDC - C - HD - BM0.14 - 0.37AG	<b>1651570000</b>
100	HDC - C - HD - SM0.5AG	<b>1651530000</b>	HDC - C - HD - BM0.5AG	<b>1651580000</b>
100	HDC - C - HD - SM0.75 - 1AG	<b>1601750000</b>	HDC - C - HD - BM0.75 - 1AG	<b>1601760000</b>
100	HDC - C - HD - SM1.5AG	<b>1651550000</b>	HDC - C - HD - BM1.5AG	<b>1651600000</b>
100	HDC - C - HD - SM2.5AG	<b>1651560000</b>	HDC - C - HD - BM2.5AG	<b>1651610000</b>
100	HDC - C - HD - SM0.14 - 0.37AU	<b>1651620000</b>	HDC - C - HD - BM0.14 - 0.37AU	<b>1651670000</b>
100	HDC - C - HD - SM0.5AU	<b>1651630000</b>	HDC - C - HD - BM0.5AU	<b>1651680000</b>
100	HDC - C - HD - SM0.75 - 1AU	<b>1651640000</b>	HDC - C - HD - BM0.75 - 1AU	<b>1651690000</b>
100	HDC - C - HD - SM1.5AU	<b>1651650000</b>	HDC - C - HD - BM1.5AU	<b>1651700000</b>
100	HDC - C - HD - SM2.5AU	<b>1651660000</b>	HDC - C - HD - BM2.5AU	<b>1651710000</b>

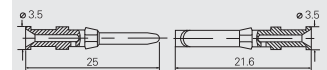

导线截面积

mm <sup>2</sup>	AWG 导线	剥线长度
0.14 - 0.37	22	8mm
0.50	20	8mm
0.75 - 1.00	18	8mm
1.50	16	8mm
2.50	14	8mm

工具



压针工具	订货号
CTX CM 1.6/2.5	<b>9018490000</b>
退针工具	订货号
退针工具 HD	<b>1866730000</b>

## RockStar® IP65外壳选择

## 尺寸1

\*更多外壳,请参阅D章节



## 插头外壳

材料: 铸铝

## 插头外壳, 侧面进线



a	描述	防尘盖	b (mm)	型号	订货号
M 20	带螺纹		49.2	HDC 04A TWLU 1M20G	<b>1788810000</b>

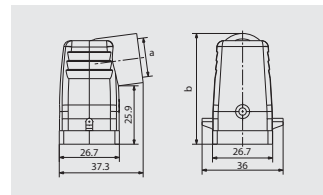

## 插头外壳, 顶部进线



a	描述	防尘盖	b (mm)	型号	订货号
M 20	带螺纹		50	HDC 04A TOLU 1M20G	<b>1788820000</b>

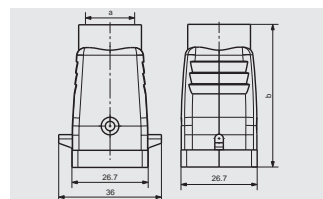

## 底座

## 穿体式插座外壳



描述	防尘盖	b (mm)	型号	订货号
		23	HDC 04A ALU	<b>1497600000</b>

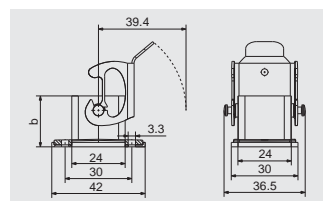

## 底座封闭式插座外壳



a	描述	防尘盖	b (mm)	型号	订货号
M 20	带螺纹		25.8	HDC 04A SLU 1M20G	<b>1788830000</b>

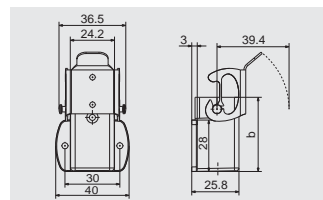

## 对接外壳



a	描述	防尘盖	b (mm)	型号	订货号
M 20	带螺纹		53.5	HDC 04A KOLU 1M20G	<b>1788840000</b>

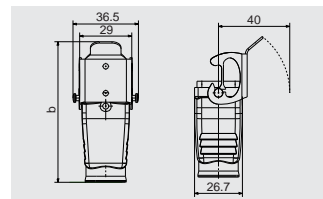

## 出线口螺纹固定外壳



a	描述	防尘盖	b (mm)	型号	订货号
M 20	带螺纹		54	HDC 04A ELU 1M20G	<b>1900320000</b>
PG 13,5	带螺纹		54	HDC 04A ELU 1PG13G	<b>1900330000</b>
PG 13,5	带螺纹		54	HDC 04A ELU 1PG13G EXI	<b>1900350000</b>

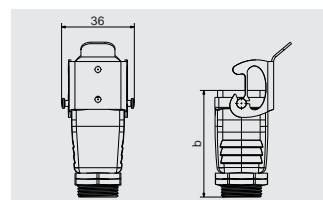

## 防尘盖



描述	型号	订货号
母	HDC 04A DMDL 2BO	<b>1665750000</b>
公	HDC 04A DODL 2BO	<b>1665740000</b>

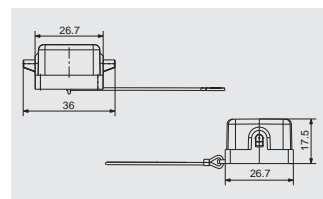

42 V, 10 A, 尺寸 1

8

插芯



冷压联接



插芯	型号	订货号
公	HDC HD 8 MC	1650590000
母	HDC HD 8 FC	1650600000

尺寸

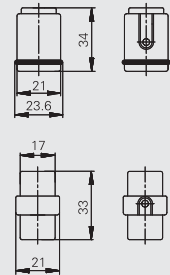

插针的排列

公



母



零配件

冷压插针

表面镀银



表面镀金



数量	公	订货号	母	订货号
100	HDC-C-HD-SM0.14-0.37AG	1651520000	HDC-C-HD-BM0.14-0.37AG	1651570000
100	HDC-C-HD-SM0.5AG	1651530000	HDC-C-HD-BM0.5AG	1651580000
100	HDC-C-HD-SM0.75-1AG	1601750000	HDC-C-HD-BM0.75-1AG	1601760000
100	HDC-C-HD-SM1.5AG	1651550000	HDC-C-HD-BM1.5AG	1651600000
100	HDC-C-HD-SM2.5AG	1651560000	HDC-C-HD-BM2.5AG	1651610000
100	HDC-C-HD-SM0.14-0.37AU	1651620000	HDC-C-HD-BM0.14-0.37AU	1651670000
100	HDC-C-HD-SM0.5AU	1651630000	HDC-C-HD-BM0.5AU	1651680000
100	HDC-C-HD-SM0.75-1AU	1651640000	HDC-C-HD-BM0.75-1AU	1651690000
100	HDC-C-HD-SM1.5AU	1651650000	HDC-C-HD-BM1.5AU	1651700000
100	HDC-C-HD-SM2.5AU	1651660000	HDC-C-HD-BM2.5AU	1651710000

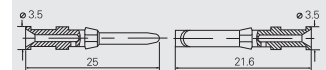

导线截面积

mm <sup>2</sup>	AWG 导线	剥线长度
0.14 - 0.37	22	8mm
0.50	20	8mm
0.75 - 1.00	18	8mm
1.50	16	8mm
2.50	14	8mm

工具



压针工具	订货号
CTX CM 1.6/2.5	9018490000
C退针工具	订货号
退针工具 HD	1866730000

## RockStar® IP65外壳选择

## 尺寸1

\*更多外壳,请参D章节



## 插头外壳

材料: 铸铝

## 插头外壳, 侧面进线



a	描述	防尘盖	b (mm)	型号	订货号
M 20	带螺纹		49.2	HDC 04A TWLU 1M20G	<b>1788810000</b>

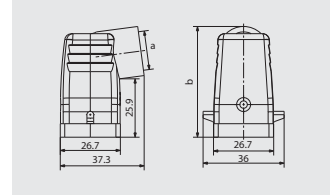

## 插头外壳, 顶部进线



a	描述	防尘盖	b (mm)	型号	订货号
M 20	带螺纹		50	HDC 04A TOLU 1M20G	<b>1788820000</b>

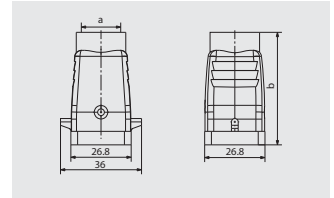

## 底座

## 穿体式插座外壳



描述	防尘盖	b (mm)	型号	订货号
		23	HDC 04A ALU	<b>1497600000</b>

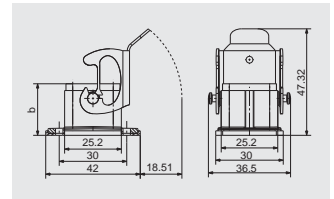

## 底座封闭式插座外壳



a	描述	防尘盖	b (mm)	型号	订货号
M 20	带螺纹		25.8	HDC 04A SLU 1M20G	<b>1788830000</b>

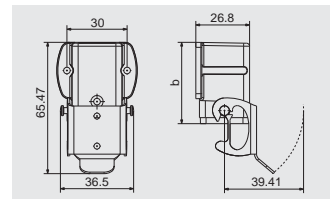

## 对接外壳



a	描述	防尘盖	b (mm)	型号	订货号
M 20	带螺纹		53.5	HDC 04A KOLU 1M20G	<b>1788840000</b>

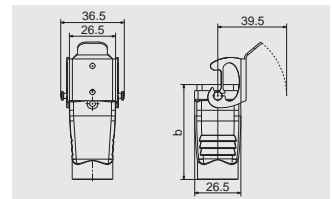

## 出线口螺纹固定外壳



a	描述	防尘盖	b (mm)	型号	订货号
M 20	带螺纹		54	HDC 04A ELU 1M20G	<b>1900320000</b>
PG 13,5	带螺纹		54	HDC 04A ELU 1PG13G	<b>1900330000</b>
PG 13,5	带螺纹		54	HDC 04A ELU 1PG13G EXI	<b>1900350000</b>

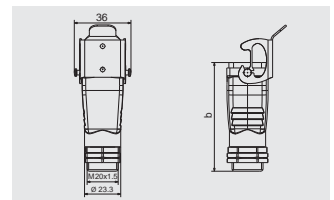

## 防尘盖



描述	型号	订货号
母	HDC 04A DMDL 2BO	<b>1665750000</b>
公	HDC 04A DODL 2BO	<b>1665740000</b>

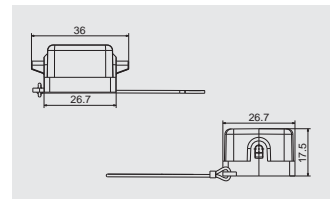

250 V, 10 A, 尺寸 2

15 + ⊕

插芯

冷压联接



插芯	型号	订货号
母	HDC HD 15 FC	1650660000
公	HDC HD 15 MC	1650650000

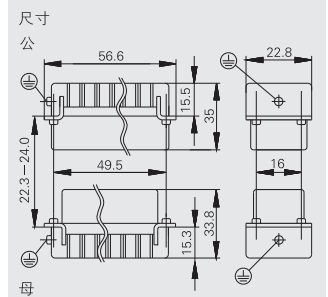

插针的排列

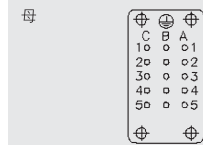
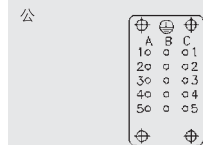

开孔尺寸

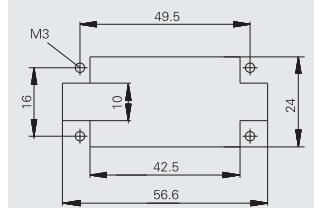

工具

冷压插针

表面镀银



表面镀金



数量	公	订货号	母	订货号
100	HDC-C-HD-SM0.14-0.37AG	1651520000	HDC-C-HD-BM0.14-0.37AG	1651570000
100	HDC-C-HD-SM0.5AG	1651530000	HDC-C-HD-BM0.5AG	1651580000
100	HDC-C-HD-SM0.75-1AG	1601750000	HDC-C-HD-BM0.75-1AG	1601760000
100	HDC-C-HD-SM1.5AG	1651550000	HDC-C-HD-BM1.5AG	1651600000
100	HDC-C-HD-SM2.5AG	1651560000	HDC-C-HD-BM2.5AG	1651610000
100	HDC-C-HD-SM0.14-0.37AU	1651620000	HDC-C-HD-BM0.14-0.37AU	1651670000
100	HDC-C-HD-SM0.5AU	1651630000	HDC-C-HD-BM0.5AU	1651680000
100	HDC-C-HD-SM0.75-1AU	1651640000	HDC-C-HD-BM0.75-1AU	1651690000
100	HDC-C-HD-SM1.5AU	1651650000	HDC-C-HD-BM1.5AU	1651700000
100	HDC-C-HD-SM2.5AU	1651660000	HDC-C-HD-BM2.5AU	1651710000



导线截面积

mm <sup>2</sup>	AWG 导线	剥线长度
0.14 - 0.37	22	8mm
0.50	20	8mm
0.75 - 1.00	18	8mm
1.50	16	8mm
2.50	14	8mm

工具



压针工具	订货号
CTX CM 1.6/2.5	9018490000
退针工具	订货号
退针工具 HD	1866730000

## RockStar® IP65/IP66外壳选择

## 尺寸2

\*更多外壳,请参D章节

## 插头外壳



## 插头外壳, 侧面进线



a	描述	防尘盖	b (mm)	型号	订货号
M 20	带螺纹		68	HDC 15A TSLU 1M20G	178860000
M 25	带螺纹		68	HDC 15A TSLU 1M25G	178865000

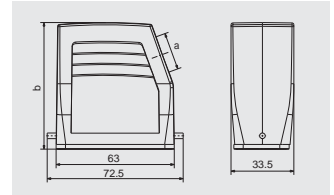

## 插头外壳, 顶部进线



a	描述	防尘盖	b (mm)	型号	订货号
M 20	带螺纹		54	HDC 10A TOLU 1M20G	178862000
M 25	带螺纹		54	HDC 10A TOLU 1M25G	178861000

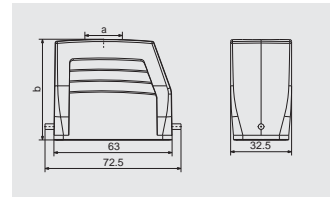

## 防尘盖



描述	型号	订货号
用于插头外壳	HDC 10A DODL 1LB	1665890000

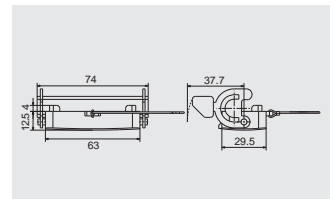

## 底座

## 穿体式插座外壳



描述	防尘盖	b (mm)	型号	订货号
	带	37.5	HDC 10A ADLU	1664060000
		25	HDC 10A ALU	1664040000

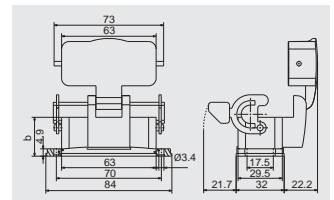

## 底座封闭型插座外壳



a	描述	防尘盖	b (mm)	型号	订货号
M 20	带螺纹	带	69.5	HDC 10A SDLU 2M20G	1788660000
M 25	带螺纹	带	69.5	HDC 10A SDLU 2M25G	1788650000
M 20	带螺纹		57	HDC 10A SLU 2M20G	1788640000
M 25	带螺纹		57	HDC 10A SLU 2M25G	1788630000

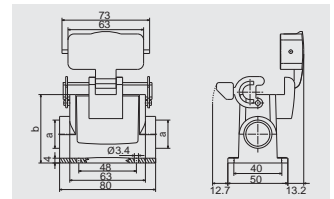

## 对接外壳



a	描述	防尘盖	b (mm)	型号	订货号
M 25	带螺纹		48	HDC 10A KLU 1M25G	1788670000

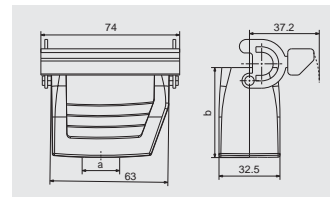

## 防尘盖



描述	型号	订货号
用于插座外壳	HDC 10A DMDL 2BO	1665880000

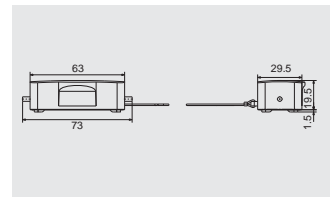

250 V, 10 A, 尺寸 3

16 + ⊕

插芯



冷压联接



插芯	型号	订货号
公	HDC HD 16 MC	<b>1650710000</b>
母	HDC HD 16 FC	<b>1650720000</b>

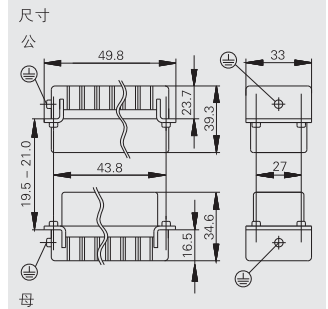

插针的排列

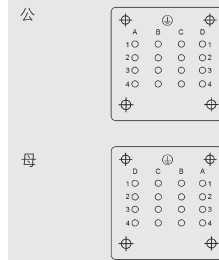

开孔尺寸

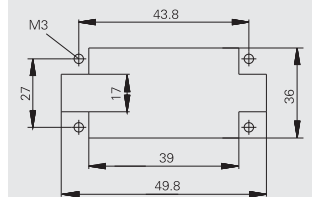

零配件

冷压插针

表面镀银



表面镀金



数量	公	订货号	母	订货号
100	HDC-C-HD-SM0.14-0.37AG	<b>1651520000</b>	HDC-C-HD-BM0.14-0.37AG	<b>1651570000</b>
100	HDC-C-HD-SM0.5AG	<b>1651530000</b>	HDC-C-HD-BM0.5AG	<b>1651580000</b>
100	HDC-C-HD-SM0.75-1AG	<b>1601750000</b>	HDC-C-HD-BM0.75-1AG	<b>1601760000</b>
100	HDC-C-HD-SM1.5AG	<b>1651550000</b>	HDC-C-HD-BM1.5AG	<b>1651600000</b>
100	HDC-C-HD-SM2.5AG	<b>1651560000</b>	HDC-C-HD-BM2.5AG	<b>1651610000</b>
100	HDC-C-HD-SM0.14-0.37AU	<b>1651620000</b>	HDC-C-HD-BM0.14-0.37AU	<b>1651670000</b>
100	HDC-C-HD-SM0.5AU	<b>1651630000</b>	HDC-C-HD-BM0.5AU	<b>1651680000</b>
100	HDC-C-HD-SM0.75-1AU	<b>1651640000</b>	HDC-C-HD-BM0.75-1AU	<b>1651690000</b>
100	HDC-C-HD-SM1.5AU	<b>1651650000</b>	HDC-C-HD-BM1.5AU	<b>1651700000</b>
100	HDC-C-HD-SM2.5AU	<b>1651660000</b>	HDC-C-HD-BM2.5AU	<b>1651710000</b>



导线截面积

mm <sup>2</sup>	AWG 导线	剥线长度
0.14 - 0.37	22	8mm
0.50	20	8mm
0.75 - 1.00	18	8mm
1.50	16	8mm
2.50	14	8mm

工具



压针工具	订货号
CTX CM 1.6/2.5	<b>9018490000</b>
退针工具	订货号
退针工具 HD	<b>1866730000</b>

## RockStar® IP65/IP66外壳选择

## 尺寸3

\*更多外壳,请参阅D章节

## 插头外壳



## 插头外壳, 侧面进线



a	描述	防尘盖	b (mm)	型号	订货号
M 20	带螺纹		52	HDC 06B TSLU 1M20G	<b>1805900000</b>
M 20	带螺纹		52	HDC 06B TSLU 1M20G	<b>1805930000</b>
M 25	带螺纹		52	HDC 06B TSLU 1M25G	<b>1788090000</b>
M 25	带螺纹		72	HDC 16D TSLU 1M25G	<b>1787480000</b>

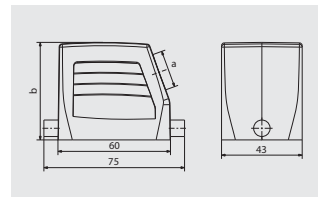

## 插头外壳, 顶部进线



a	描述	防尘盖	b (mm)	型号	订货号
M 20	带螺纹		52	HDC 06B TOLU 1M20G	<b>1788120000</b>
M 25	带螺纹		52	HDC 06B TOLU 1M25G	<b>1788110000</b>
M 25	带螺纹		72	HDC 16D TOLU 1M25G	<b>1787500000</b>
M 32	带螺纹		72	HDC 16D TOLU 1M32G	<b>1787490000</b>

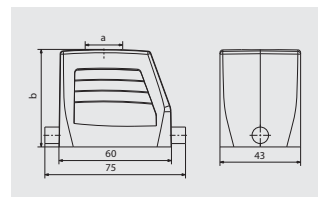

## Cover



描述	型号	订货号
用于插头外壳	HDC 06B DMDL 1LB	<b>1665210000</b>

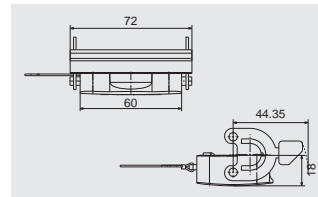

## 底座

## 穿体式插座外壳



描述	防尘盖	b (mm)	型号	订货号
		29	HDC 06B ALU	<b>1202100000</b>
	带	47	HDC 06B ADLU	<b>1202500000</b>

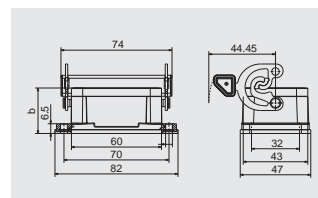

## 底座封闭型插座外壳



a	描述	防尘盖	b (mm)	型号	订货号
M 20	带螺纹		54	HDC 06B SLU 2M20G	<b>1788140000</b>
M 20	带螺纹	带	72	HDC 06B SDLU 2M20G	<b>1788170000</b>
M 25	带螺纹		54	HDC 06B SLU 2M25G	<b>1788130000</b>
M 25	带螺纹	带	72	HDC 06B SDLU 2M25G	<b>1788160000</b>

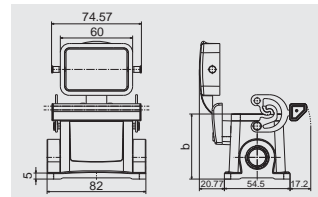

## 防尘盖



描述	型号	订货号
用于插座外壳	HDC 06B DODL 2BO	<b>1665200000</b>





250 V, 10 A, 尺寸 4

24 + ⊕

插芯



冷压联接



插芯	型号	订货号
公	HDC HD 24 MC	<b>1650870000</b>
母	HDC HD 24 FC	<b>1650890000</b>

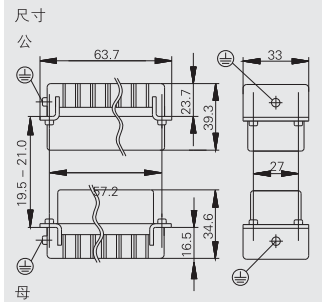

插芯的排列

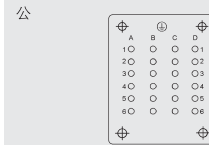

开孔尺寸

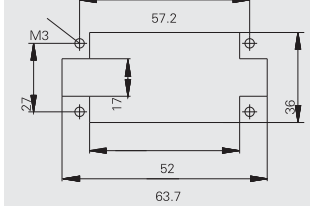

零配件

冷压插针

表面镀银



表面镀金



数量	公	订货号	母	订货号
100	HDC-C-HD-SM0.14-0.37AG	<b>1651520000</b>	HDC-C-HD-BM0.14-0.37AG	<b>1651570000</b>
100	HDC-C-HD-SM0.5AG	<b>1651530000</b>	HDC-C-HD-BM0.5AG	<b>1651580000</b>
100	HDC-C-HD-SM0.75-1AG	<b>1601750000</b>	HDC-C-HD-BM0.75-1AG	<b>1601760000</b>
100	HDC-C-HD-SM1.5AG	<b>1651550000</b>	HDC-C-HD-BM1.5AG	<b>1651600000</b>
100	HDC-C-HD-SM2.5AG	<b>1651560000</b>	HDC-C-HD-BM2.5AG	<b>1651610000</b>
100	HDC-C-HD-SM0.14-0.37AU	<b>1651620000</b>	HDC-C-HD-BM0.14-0.37AU	<b>1651670000</b>
100	HDC-C-HD-SM0.5AU	<b>1651630000</b>	HDC-C-HD-BM0.5AU	<b>1651680000</b>
100	HDC-C-HD-SM0.75-1AU	<b>1651640000</b>	HDC-C-HD-BM0.75-1AU	<b>1651690000</b>
100	HDC-C-HD-SM1.5AU	<b>1651650000</b>	HDC-C-HD-BM1.5AU	<b>1651700000</b>
100	HDC-C-HD-SM2.5AU	<b>1651660000</b>	HDC-C-HD-BM2.5AU	<b>1651710000</b>



导线截面积

mm <sup>2</sup>	AWG 导线	剥线长度
0.14 - 0.37	22	8mm
0.50	20	8mm
0.75 - 1.00	18	8mm
1.50	16	8mm
2.50	14	8mm

工具



压针工具	订货号
CTX CM 1.6/2.5	<b>9018490000</b>
退针工具	订货号
退针工具 HD	<b>1866730000</b>

## RockStar® IP65/IP66外壳选择

## 尺寸4

\*更多外壳,请参D章节

## 插头外壳

## 插头外壳, 侧面进线



a	描述	防尘盖	b (mm)	型号	订货号
M 20	带螺纹		52	HDC 10B TSBU 1M20G	<b>1787560000</b>
M 25	带螺纹		52	HDC 10B TSBU 1M25G	<b>1787550000</b>
M 25	带螺纹		72	HDC 24D TSBU 1M25G	<b>1787240000</b>
M 32	带螺纹		72	HDC 24D TSBU 1M32G	<b>1787230000</b>

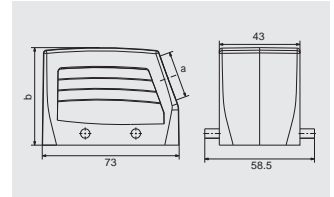

## 插头外壳, 顶部进线



a	描述	防尘盖	b (mm)	型号	订货号
M 20	带螺纹		52	HDC 10B TOBU 1M20G	<b>1787600000</b>
M 25	带螺纹		52	HDC 10B TOBU 1M25G	<b>1787590000</b>
M 25	带螺纹		72	HDC 24D TOBU 1M25G	<b>1787300000</b>
M 32	带螺纹		72	HDC 24D TOBU 1M32G	<b>1787290000</b>

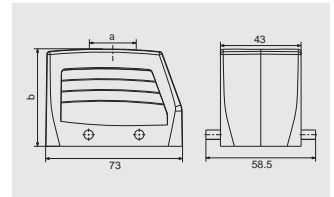

## 防尘盖



描述	型号	订货号
用于插头外壳	HDC 10B DMDQ 2QB	<b>1665240000</b>

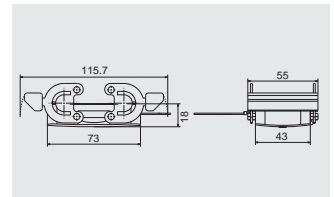

## 底座

## 穿体式插座外壳



描述	防尘盖	b (mm)	型号	订货号
		29.3	HDC 10B ABU	<b>1205000000</b>

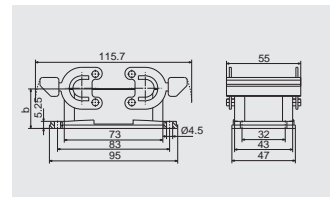

## 底座封闭式插座外壳



a	描述	防尘盖	b (mm)	型号	订货号
M 20	带螺纹		57	HDC 10B SBU 2M20G	<b>1787640000</b>
M 25	带螺纹		57	HDC 10B SBU 2M25G	<b>1787630000</b>
M 25	带螺纹		74	HDC 24D SBU 2M25G	<b>1787350000</b>
M 32	带螺纹		74	HDC 24D SBU 2M32G	<b>1787360000</b>

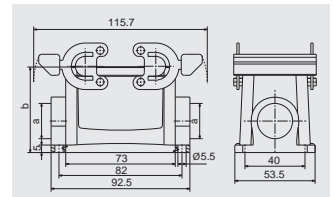

## 对接外壳



a	描述	防尘盖	b (mm)	型号	订货号
M 20	带螺纹		55	HDC 10B KBU 1M20G	<b>1787720000</b>

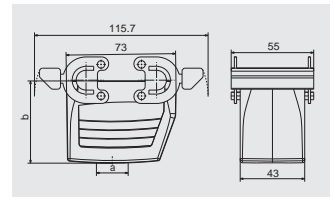

## 防尘盖



描述	型号	订货号
用于插座外壳	HDC 10B DODQ 4BO	<b>1665230000</b>

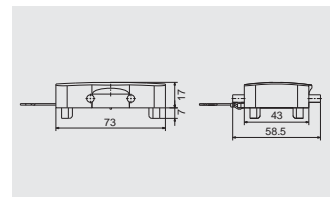

250 V, 10 A, 尺寸 5

25 + ⊕

插芯

弹片联接



插芯	型号	订货号
公	HDC HD 25 MC	<b>1650810000</b>
母	HDC HD 25 FC	<b>1650820000</b>

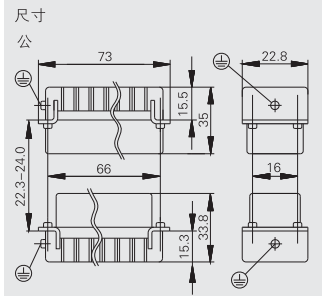

插针的排列

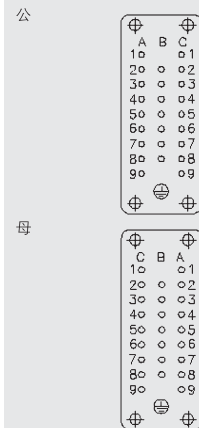

开孔尺寸

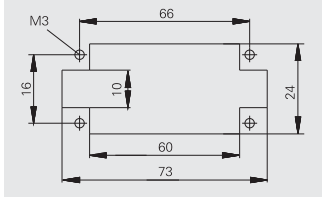

零配件

冷压插针

表面镀银



表面镀金



数量	公	订货号	母	订货号
100	HDC-C-HD-SM0.14-0.37AG	<b>1651520000</b>	HDC-C-HD-BM0.14-0.37AG	<b>1651570000</b>
100	HDC-C-HD-SM0.5AG	<b>1651530000</b>	HDC-C-HD-BM0.5AG	<b>1651580000</b>
100	HDC-C-HD-SM0.75-1AG	<b>1601750000</b>	HDC-C-HD-BM0.75-1AG	<b>1601760000</b>
100	HDC-C-HD-SM1.5AG	<b>1651550000</b>	HDC-C-HD-BM1.5AG	<b>1651600000</b>
100	HDC-C-HD-SM2.5AG	<b>1651560000</b>	HDC-C-HD-BM2.5AG	<b>1651610000</b>
100	HDC-C-HD-SM0.14-0.37AU	<b>1651620000</b>	HDC-C-HD-BM0.14-0.37AU	<b>1651670000</b>
100	HDC-C-HD-SM0.5AU	<b>1651630000</b>	HDC-C-HD-BM0.5AU	<b>1651680000</b>
100	HDC-C-HD-SM0.75-1AU	<b>1651640000</b>	HDC-C-HD-BM0.75-1AU	<b>1651690000</b>
100	HDC-C-HD-SM1.5AU	<b>1651650000</b>	HDC-C-HD-BM1.5AU	<b>1651700000</b>
100	HDC-C-HD-SM2.5AU	<b>1651660000</b>	HDC-C-HD-BM2.5AU	<b>1651710000</b>



导线截面积

mm <sup>2</sup>	AWG 导线	剥线长度
0.14 - 0.37	22	8mm
0.50	20	8mm
0.75 - 1.00	18	8mm
1.50	16	8mm
2.50	14	8mm

工具



压针工具	订货号
CTX CM 1.6/2.5	<b>9018490000</b>
退针工具	订货号
退针工具 HD	<b>1866730000</b>

## RockStar® IP65/IP66外壳选择

## 尺寸5

\*更多外壳,请参阅D章节

## 插头外壳



## 插头外壳, 侧面进线



a	描述	防尘盖	b (mm)	型号	订货号
M 25	带螺纹		58	HDC 16A TSLU 1M25G	<b>1788740000</b>
M 20	带螺纹		72	HDC 25A TSLU 1M20G	<b>1788680000</b>
M 25	带螺纹		72	HDC 25A TSLU 1M25G	<b>1788690000</b>

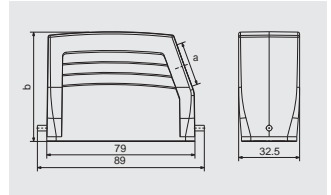

## 插头外壳, 顶部进线



a	描述	防尘盖	b (mm)	型号	订货号
M 25	带螺纹		58	HDC 16A TOLU 1M25G	<b>1788750000</b>
M 20	带螺纹		72	HDC 25A TOLU 1M20G	<b>1788710000</b>
M 25	带螺纹		72	HDC 25A TOLU 1M25G	<b>1788700000</b>

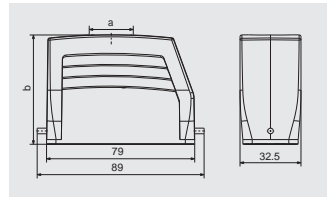

## 防尘盖



描述	型号	订货号
用于插头外壳	HDC 16A DODL 1LB	<b>1665900000</b>

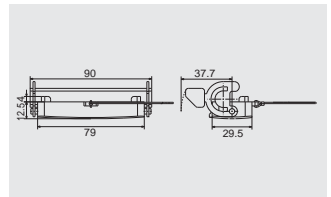

## 底座

## 穿体式插座外壳



描述	防尘盖	b (mm)	型号	订货号
	带	44.5	HDC 16A ADLU	<b>1664940000</b>
		25	HDC 16A ALU	<b>1664920000</b>

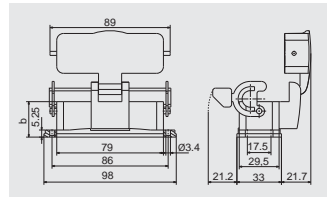

## 底座封闭式插座外壳



a	描述	防尘盖	b (mm)	型号	订货号
M 20	带螺纹	带	76.5	HDC 16A SDLU 2M20G	<b>1788790000</b>
M 25	带螺纹	带	76.5	HDC 16A SDLU 2M25G	<b>1788780000</b>
M 20	带螺纹		57	HDC 16A SLU 2M20G	<b>1788770000</b>
M 25	带螺纹		57	HDC 16A SLU 2M25G	<b>1788760000</b>

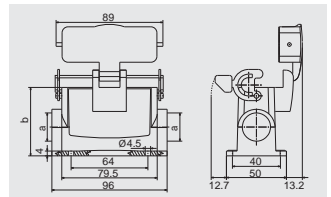

## 对接外壳



a	描述	防尘盖	b (mm)	型号	订货号
M 25	带螺纹		53	HDC 16A KLU 1M25G	<b>1788800000</b>

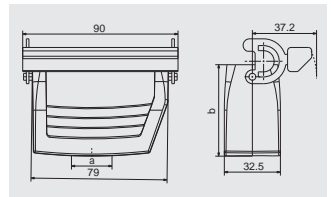

## 防尘盖



描述	型号	订货号
用于插座外壳	HDC 16A DMDL 2B0	<b>1665910000</b>

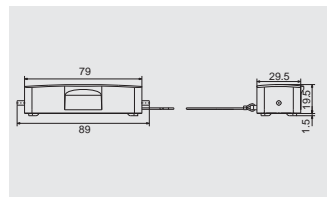

250 V, 10 A, 尺寸 6

40 + ⊕

插芯

冷压联接



插芯	型号	订货号
公	HDC HD 40 MC	<b>1601710000</b>
母	HDC HD 40 FC	<b>1601730000</b>

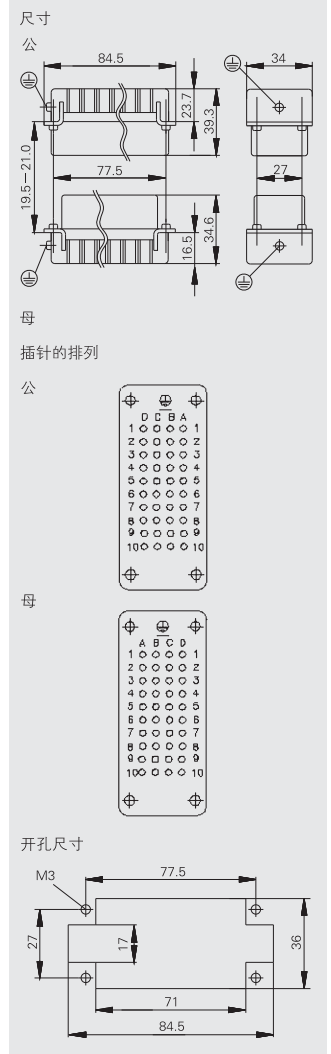

零配件

冷压插针

表面镀银



表面镀金



数量	公	订货号	母	订货号
100	HDC - C - HD - SM0.14 - 0.37AG	<b>1651520000</b>	HDC - C - HD - BM0.14 - 0.37AG	<b>1651570000</b>
100	HDC - C - HD - SM0.5AG	<b>1651530000</b>	HDC - C - HD - BM0.5AG	<b>1651580000</b>
100	HDC - C - HD - SM0.75 - 1AG	<b>1601750000</b>	HDC - C - HD - BM0.75 - 1AG	<b>1601760000</b>
100	HDC - C - HD - SM1.5AG	<b>1651550000</b>	HDC - C - HD - BM1.5AG	<b>1651600000</b>
100	HDC - C - HD - SM2.5AG	<b>1651560000</b>	HDC - C - HD - BM2.5AG	<b>1651610000</b>
100	HDC - C - HD - SM0.14 - 0.37AU	<b>1651620000</b>	HDC - C - HD - BM0.14 - 0.37AU	<b>1651670000</b>
100	HDC - C - HD - SM0.5AU	<b>1651630000</b>	HDC - C - HD - BM0.5AU	<b>1651680000</b>
100	HDC - C - HD - SM0.75 - 1AU	<b>1651640000</b>	HDC - C - HD - BM0.75 - 1AU	<b>1651690000</b>
100	HDC - C - HD - SM1.5AU	<b>1651650000</b>	HDC - C - HD - BM1.5AU	<b>1651700000</b>
100	HDC - C - HD - SM2.5AU	<b>1651660000</b>	HDC - C - HD - BM2.5AU	<b>1651710000</b>



导线截面积	AWG 导线	剥线长度
mm <sup>2</sup>		
0.14 - 0.37	22	8mm
0.50	20	8mm
0.75 - 1.00	18	8mm
1.50	16	8mm
2.50	14	8mm

工具



压针工具	订货号
CTX CM 1.6/2.5	<b>9018490000</b>
退针工具	订货号
退针工具 HD	<b>1866730000</b>

## RockStar® IP65/IP66外壳选择

## 尺寸6

\*更多外壳,请参阅D章节

## 插头外壳



## 插头外壳, 侧面进线



a	描述	防尘盖	b (mm)	型号	订货号
M 25	带螺纹		61	HDC 16B TSBU 1M25G	<b>1788180000</b>
M 25	带螺纹		76	HDC 40D TSBU 1M25G	<b>1787010000</b>
M 32	带螺纹		76	HDC 40D TSBU 1M32G	<b>1787000000</b>

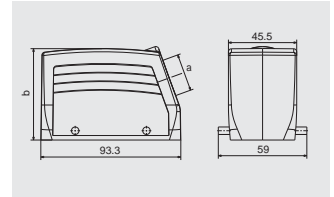

## 插头外壳, 顶部进线



a	描述	防尘盖	b (mm)	型号	订货号
M 25	带螺纹		61	HDC 16B TOBU 1M25G	<b>1788210000</b>
M 25	带螺纹		76	HDC 40D TOBU 1M25G	<b>1787070000</b>
M 32	带螺纹		76	HDC 40D TOBU 1M32G	<b>1787060000</b>

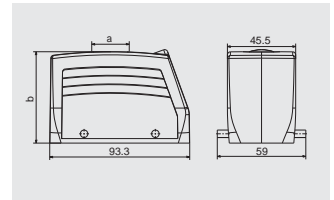

## 防尘盖



描述	型号	订货号
用于插头外壳	HDC 16B DMDQ 2QB	<b>1665270000</b>

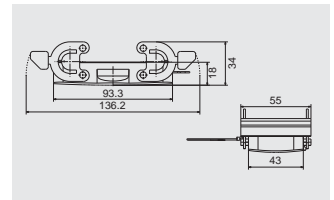

## 底座

## 穿体式插座外壳



描述	防尘盖	b (mm)	型号	订货号
		29	HDC 16B ABU	<b>1208600000</b>

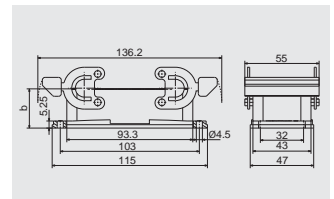

## 底座封闭式插座外壳



a	描述	防尘盖	b (mm)	型号	订货号
M 25	带螺纹		64	HDC 16B SBU 2M25G	<b>1788240000</b>
M 25	带螺纹		84	HDC 40D SBU 2M25G	<b>1787120000</b>
M 32	带螺纹		84	HDC 40D SBU 2M32G	<b>1787110000</b>

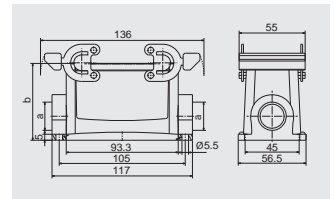

## 对接外壳



a	描述	防尘盖	b (mm)	型号	订货号
M 25	带螺纹		79	HDC 40D KBU 1M25G	<b>1787200000</b>
M 32	带螺纹		79	HDC 40D KBU 1M32G	<b>1787190000</b>

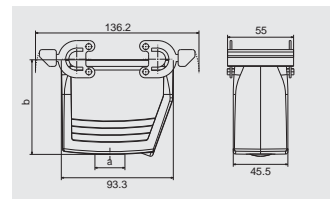

## 防尘盖



描述	型号	订货号
用于插座外壳	HDC 16B DODQ 4BO	<b>1665260000</b>

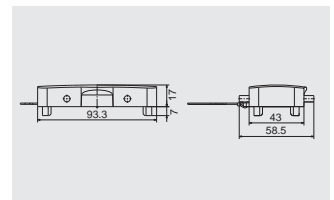

250 V, 10 A, 尺寸 7

50 + ⊕

插芯

冷压联接



插芯	型号	订货号
公	HDC HD 25 MC	<b>1650810000</b>
母	HDC HD 25 FC	<b>1650820000</b>

注:需要订2对以上插芯才能拥有50路

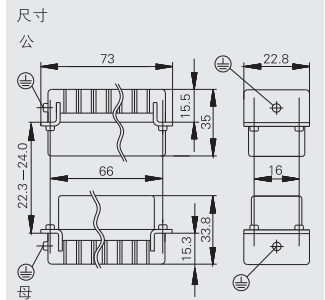

插针的排列

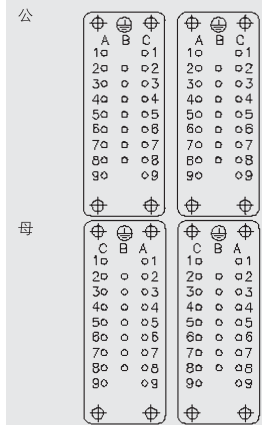

开孔尺寸

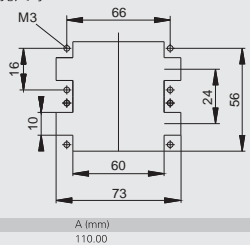

零配件

冷压插针

表面镀银



表面镀金



数量	公	订货号	母	订货号
100	HDC - C - HD - SM0.14 - 0.37AG	<b>1651520000</b>	HDC - C - HD - BM0.14 - 0.37AG	<b>1651570000</b>
100	HDC - C - HD - SM0.5AG	<b>1651530000</b>	HDC - C - HD - BM0.5AG	<b>1651580000</b>
100	HDC - C - HD - SM0.75 - 1AG	<b>1601750000</b>	HDC - C - HD - BM0.75 - 1AG	<b>1601760000</b>
100	HDC - C - HD - SM1.5AG	<b>1651550000</b>	HDC - C - HD - BM1.5AG	<b>1651600000</b>
100	HDC - C - HD - SM2.5AG	<b>1651560000</b>	HDC - C - HD - BM2.5AG	<b>1651610000</b>
100	HDC - C - HD - SM0.14 - 0.37AU	<b>1651620000</b>	HDC - C - HD - BM0.14 - 0.37AU	<b>1651670000</b>
100	HDC - C - HD - SM0.5AU	<b>1651630000</b>	HDC - C - HD - BM0.5AU	<b>1651680000</b>
100	HDC - C - HD - SM0.75 - 1AU	<b>1651640000</b>	HDC - C - HD - BM0.75 - 1AU	<b>1651690000</b>
100	HDC - C - HD - SM1.5AU	<b>1651650000</b>	HDC - C - HD - BM1.5AU	<b>1651700000</b>
100	HDC - C - HD - SM2.5AU	<b>1651660000</b>	HDC - C - HD - BM2.5AU	<b>1651710000</b>



导线截面积

mm <sup>2</sup>	AWG 导线	剥线长度
0.14 - 0.37	22	8mm
0.50	20	8mm
0.75 - 1.00	18	8mm
1.50	16	8mm
2.50	14	8mm

工具



压针工具	订货号
CTX CM 1.6/2.5	<b>9018490000</b>
退针工具	订货号
退针工具 HD	<b>1866730000</b>

## RockStar® IP65/IP66外壳选择

## 尺寸7

\*更多外壳,请参阅D章节

## 插头外壳



## 插头外壳, 侧面进线



a	描述	防尘盖	b (mm)	型号	订货号
M 25	带螺纹		75	HDC 32A TSBU 1M25G	<b>1787960000</b>
M 32	带螺纹		75	HDC 32A TSBU 1M32G	<b>1787950000</b>

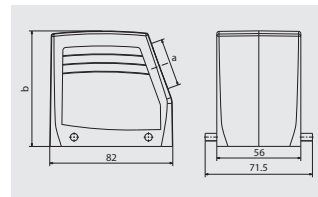

## 插头外壳, 顶部进线



a	描述	防尘盖	b (mm)	型号	订货号
M 32	带螺纹		75	HDC 32A TOBU 1M32G	<b>1787990000</b>

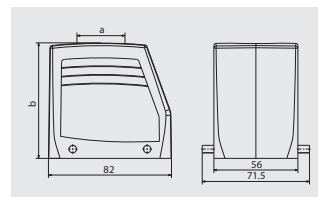

## 底座

## 穿体式插座外壳



描述	防尘盖	b (mm)	型号	订货号
		25	HDC 32A ABU	<b>1665860000</b>

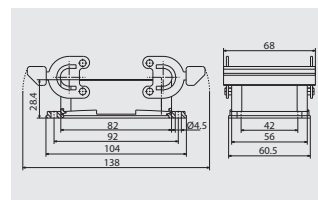

## 底座封闭式插座外壳



a	描述	防尘盖	b (mm)	型号	订货号
M 25	带螺纹		75	HDC 32A SBU 2M25G	<b>1788040000</b>

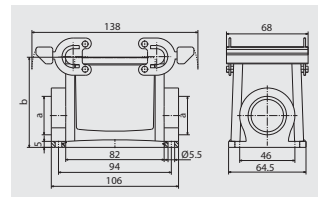

## 对接外壳



a	描述	防尘盖	b (mm)	型号	订货号
M 25	带螺纹		76.5	HDC 32A KBU 1M25G	<b>1788080000</b>
M 32	带螺纹		76.5	HDC 32A KBU 1M32G	<b>1788070000</b>

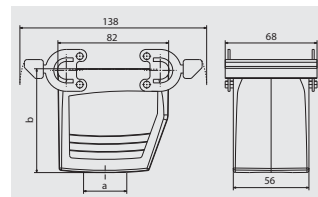



HD 高密型插芯

250 V, 10 A, 尺寸 8

64 + ⊕

插芯



冷压联接



插芯	型号	订货号
公	HDC HD 64 MC	1601720000
母	HDC HD 64 FC	1601740000

B

冲压针联接



插芯	型号	订货号
公	HDC HD 64 MCG	1058730000
母	HDC HD 64 FCG	1058720000

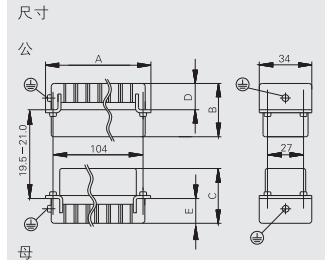

插针的排列

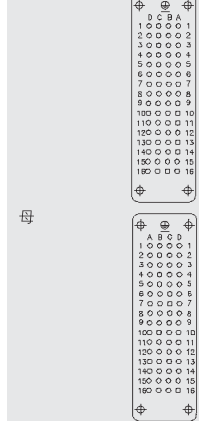

零配件

冲压针

表面镀银, 散装



数量	公	订货号	母	订货号
100	HDC - C - HD - MCG0.5 - 1.5AG	1060160000	HDC - C - HD - FCG0.5 - 1.5AG	1060140000
100	HDC - C - HD - MCG1.5 - 2.5AG	1060170000	HDC - C - HD - FCG1.5 - 2.5AG	1060150000

表面镀银, 卷装

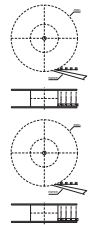

2000	HD64 - MCG0.5 - 1.5AG - KP	1107970000	HD64 - FCG0.5 - 1.5AG - KP	1107950000
2000	HD64 - MCG1.5 - 2.5AG - KP	1118600000	HD64 - FCG1.5 - 2.5AG - KP	1118610000

开孔尺寸

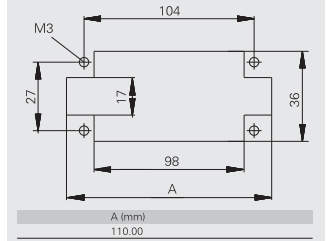

冷压插针

表面镀银



数量	公	订货号	母	订货号
100	HDC - C - HD - SM0.14 - 0.37AG	1651520000	HDC - C - HD - BM0.14 - 0.37AG	1651570000
100	HDC - C - HD - SM0.5AG	1651530000	HDC - C - HD - BM0.5AG	1651580000
100	HDC - C - HD - SM0.75 - 1AG	1601750000	HDC - C - HD - BM0.75 - 1AG	1601760000
100	HDC - C - HD - SM1.5AG	1651550000	HDC - C - HD - BM1.5AG	1651600000
100	HDC - C - HD - SM2.5AG	1651560000	HDC - C - HD - BM2.5AG	1651610000

表面镀金



100	HDC - C - HD - SM0.14 - 0.37AU	1651620000	HDC - C - HD - BM0.14 - 0.37AU	1651670000
100	HDC - C - HD - SM0.5AU	1651630000	HDC - C - HD - BM0.5AU	1651680000
100	HDC - C - HD - SM0.75 - 1AU	1651640000	HDC - C - HD - BM0.75 - 1AU	1651690000
100	HDC - C - HD - SM1.5AU	1651650000	HDC - C - HD - BM1.5AU	1651700000
100	HDC - C - HD - SM2.5AU	1651660000	HDC - C - HD - BM2.5AU	1651710000

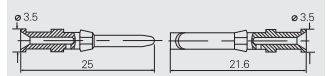

导线截面积	AWG 导线	剥线长度
0.14 - 0.37	22	8mm
0.50	20	8mm
0.75 - 1.00	18	8mm
1.50	16	8mm
2.50	14	8mm

工具



压针工具	订货号
冷压CTX CM 1.6/2.5	9018490000
冲压针CTX HD - punched	7760172110
退针工具	订货号
退针工具 HD	1866730000
退针工具 - 冲压针	7760172200

## RockStar® IP65/IP66外壳选择

## 尺寸8

\*更多外壳,请参阅D章节

## 插头外壳

## 插头外壳, 侧面进线



a	描述	防尘盖	b (mm)	型号	订货号
M 25	带螺纹		61	HDC 24B TSBU 1M25G	<b>1787760000</b>
M 32	带螺纹		61	HDC 24B TSBU 1M32G	<b>1787750000</b>
M 25	带螺纹		76	HDC 64D TSBU 1M25G	<b>1786780000</b>
M 32	带螺纹		76	HDC 64D TSBU 1M32G	<b>1786770000</b>

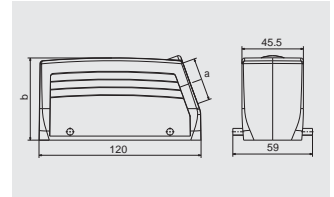

## 插头外壳, 顶部进线



a	描述	防尘盖	b (mm)	型号	订货号
M 25	带螺纹		61	HDC 24B TOBU 1M25G	<b>1787820000</b>
M 32	带螺纹		61	HDC 24B TOBU 1M32G	<b>1787810000</b>
M 32	带螺纹		76	HDC 64D TOBU 1M32G	<b>1786830000</b>

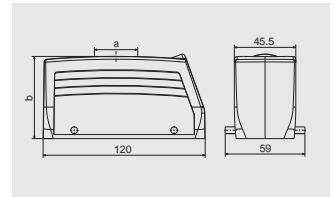

## 防尘盖



描述	型号	订货号
用于插头外壳	HDC 24B DMDQ 2QB	<b>1665640000</b>

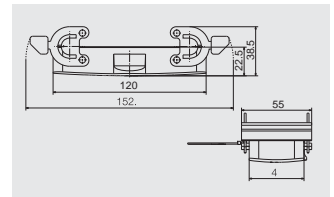

## 底座

## 穿体式插座外壳



描述	防尘盖	b (mm)	型号	订货号
		29.3	HDC 24B ABU	<b>1212400000</b>

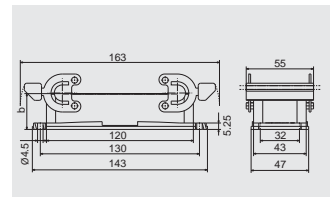

## 底座封闭式插座外壳



a	描述	防尘盖	b (mm)	型号	订货号
M 25	带螺纹		64	HDC 24B SBU 2M25G	<b>1787870000</b>
M 25	带螺纹		84	HDC 64D SBU 2M25G	<b>1786890000</b>
M 32	带螺纹		84	HDC 64D SBU 2M32G	<b>1786880000</b>

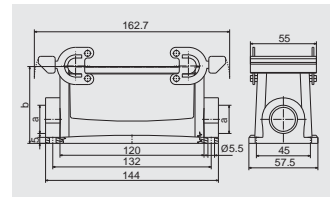

## 对接外壳



a	描述	防尘盖	b (mm)	型号	订货号
M 25	带螺纹		65	HDC 24B KBU 1M25G	<b>1787920000</b>
M 32	带螺纹		79	HDC 64D KBU 1M32G	<b>1786960000</b>

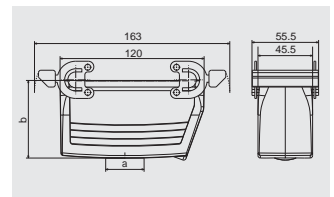

## 防尘盖



描述	型号	订货号
用于插座外壳	HDC 24B DODQ 4BO	<b>1665630000</b>

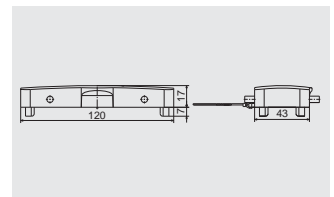

250 V, 10 A, 尺寸 10

80 + ⊕

插芯

冷压联接



插芯	型号	订货号.
公	HDC HD 40 MC	<b>1601710000</b>
母	HDC HD 40 FC	<b>1601730000</b>

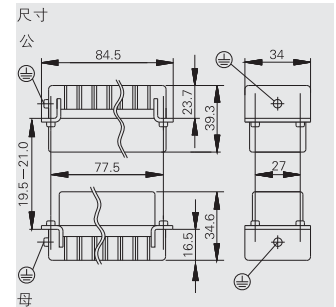

插针的排列

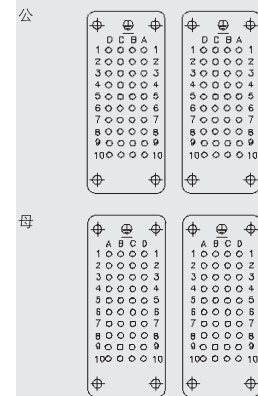

开孔尺寸

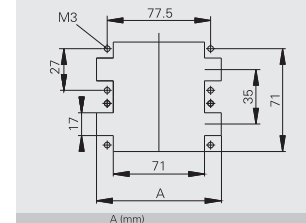

零配件

冷压插针

表面镀银



表面镀金



数量	公	订货号.	母	订货号.
100	HDC-C-HD-SM0.14-0.37AG	<b>1651520000</b>	HDC-C-HD-BM0.14-0.37AG	<b>1651570000</b>
100	HDC-C-HD-SM0.5AG	<b>1651530000</b>	HDC-C-HD-BM0.5AG	<b>1651580000</b>
100	HDC-C-HD-SM0.75-1AG	<b>1601750000</b>	HDC-C-HD-BM0.75-1AG	<b>1601760000</b>
100	HDC-C-HD-SM1.5AG	<b>1651550000</b>	HDC-C-HD-BM1.5AG	<b>1651600000</b>
100	HDC-C-HD-SM2.5AG	<b>1651560000</b>	HDC-C-HD-BM2.5AG	<b>1651610000</b>
100	HDC-C-HD-SM0.14-0.37AU	<b>1651620000</b>	HDC-C-HD-BM0.14-0.37AU	<b>1651670000</b>
100	HDC-C-HD-SM0.5AU	<b>1651630000</b>	HDC-C-HD-BM0.5AU	<b>1651680000</b>
100	HDC-C-HD-SM0.75-1AU	<b>1651640000</b>	HDC-C-HD-BM0.75-1AU	<b>1651690000</b>
100	HDC-C-HD-SM1.5AU	<b>1651650000</b>	HDC-C-HD-BM1.5AU	<b>1651700000</b>
100	HDC-C-HD-SM2.5AU	<b>1651660000</b>	HDC-C-HD-BM2.5AU	<b>1651710000</b>



导线截面积

mm <sup>2</sup>	AWG 导线	剥线长度
0.14 - 0.37	22	8mm
0.50	20	8mm
0.75 - 1.00	18	8mm
1.50	16	8mm
2.50	14	8mm

工具



压针工具	订货号.
CTX CM 1.6/2.5	<b>9018490000</b>
退针工具	订货号.
退针工具 HD	<b>1866730000</b>

## RockStar® IP65/IP66外壳选择

## 尺寸10

\*更多外壳,请参阅D章节

## 插头外壳



## 插头外壳, 侧面进线



a	描述	防尘盖	b (mm)	型号	订货号
M 32	带螺纹		79	HDC 32B TSLU 1M32G	<b>1788420000</b>

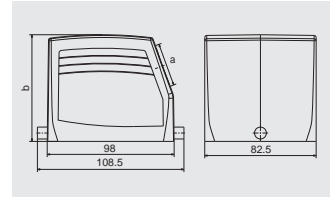

## 底座

## 穿体式插座外壳



Version	防尘盖	b (mm)	描述	订货号
	带	55	HDC 32B ADLU	<b>1219800000</b>
		38	HDC 32B ALU	<b>1219500000</b>

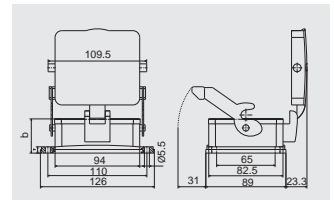

## 底座封闭型插座外壳



a	描述	防尘盖	b (mm)	型号	订货号
M 32	带螺纹	带	96	HDC 32B SDLU 2M32G	<b>1788490000</b>
M 32	带螺纹		79	HDC 32B SLU 2M32G	<b>1788470000</b>

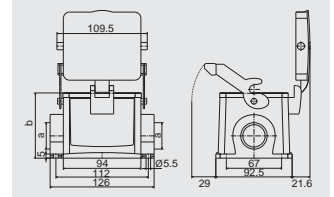

## 对接外壳



a	描述	防尘盖	b (mm)	型号	订货号
M 32	带螺纹		83	HDC 32B KLU 1M32G	<b>1788500000</b>

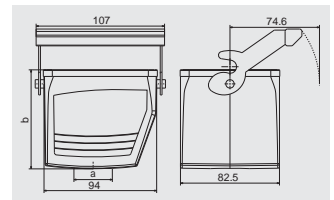

250 V, 10 A, 尺寸 12

128 + ⊕

插芯

冷压联接



插芯	型号	订货号
公	HDC HD 64 MC	<b>1601720000</b>
母	HDC HD 64 FC	<b>1601740000</b>

注:128针需要选2组(上述产品)

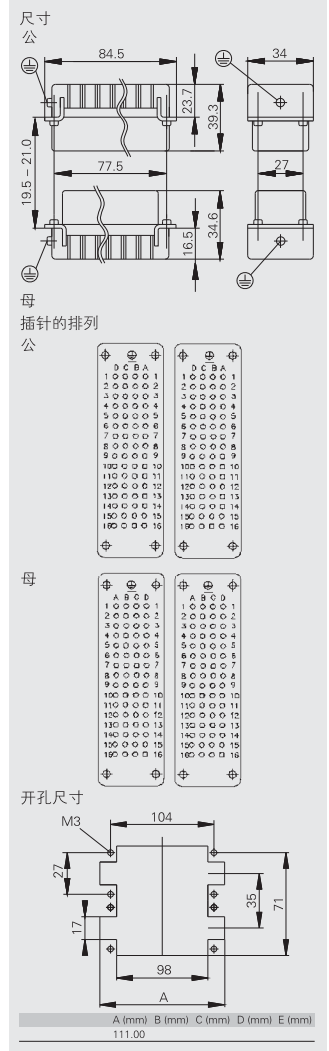

零配件

冷压插针

表面镀银



表面镀金



数量	公	订货号	母	订货号
100	HDC-C-HD-SM0.14-0.37AG	<b>1651520000</b>	HDC-C-HD-BM0.14-0.37AG	<b>1651570000</b>
100	HDC-C-HD-SM0.5AG	<b>1651530000</b>	HDC-C-HD-BM0.5AG	<b>1651580000</b>
100	HDC-C-HD-SM0.75-1AG	<b>1601750000</b>	HDC-C-HD-BM0.75-1AG	<b>1601760000</b>
100	HDC-C-HD-SM1.5AG	<b>1651550000</b>	HDC-C-HD-BM1.5AG	<b>1651600000</b>
100	HDC-C-HD-SM2.5AG	<b>1651560000</b>	HDC-C-HD-BM2.5AG	<b>1651610000</b>
100	HDC-C-HD-SM0.14-0.37AU	<b>1651620000</b>	HDC-C-HD-BM0.14-0.37AU	<b>1651670000</b>
100	HDC-C-HD-SM0.5AU	<b>1651630000</b>	HDC-C-HD-BM0.5AU	<b>1651680000</b>
100	HDC-C-HD-SM0.75-1AU	<b>1651640000</b>	HDC-C-HD-BM0.75-1AU	<b>1651690000</b>
100	HDC-C-HD-SM1.5AU	<b>1651650000</b>	HDC-C-HD-BM1.5AU	<b>1651700000</b>
100	HDC-C-HD-SM2.5AU	<b>1651660000</b>	HDC-C-HD-BM2.5AU	<b>1651710000</b>

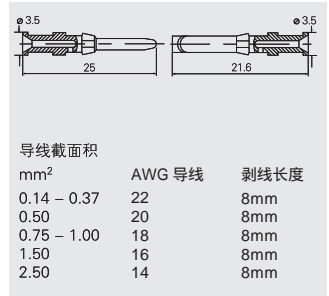

工具



压针工具	订货号
CTX CM 1.6/2.5	<b>9018490000</b>
退针工具	订货号
退针工具 HD	<b>1866730000</b>

## RockStar® IP65/IP66外壳选择

## 尺寸12

\*更多外壳,请参阅D章节

## 插头外壳



## 插头外壳, 侧面进线



a	描述	防尘盖	b (mm)	型号	订货号
M 32	带螺纹		94	HDC 48B TSLU 1M32G	<b>1788320000</b>
M 40	带螺纹		94	HDC 48B TSLU 1M40G	<b>1788310000</b>
M 50	带螺纹		94	HDC 48B TSLU 1M50G	<b>1788300000</b>

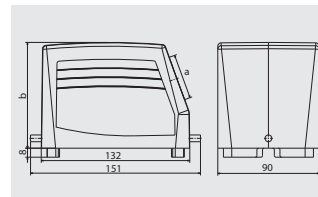

## 插头外壳, 顶部进线



a	描述	防尘盖	b (mm)	型号	订货号
M 32	带螺纹		94	HDC 48B TOLU 1M32G	<b>1788350000</b>
M 50	带螺纹		94	HDC 48B TOLU 1M50G	<b>1788330000</b>

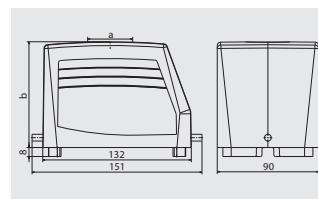

## 底座

## 穿体式插座外壳



描述	防尘盖	b (mm)	型号	订货号
	带	62	HDC 48B ADLU	<b>1222900000</b>

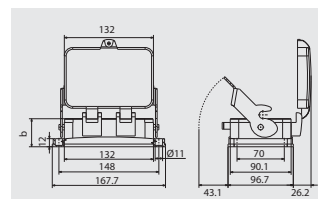

## 底座封闭型插座外壳



a	描述	防尘盖	b (mm)	型号	订货号
M 32	带螺纹	带	120	HDC 48B SDLU 2M32G	<b>1788390000</b>
M 32	带螺纹		100	HDC 48B SLU 2M32G	<b>1788370000</b>
M 40	带螺纹		100	HDC 48B SLU 2M40G	<b>1788360000</b>

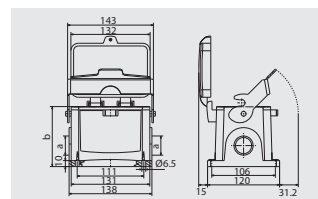

# HDD 超高密度插芯

使用车削式插针/插套的HDD系列插芯，是设计用来满足在极小的空间需联接大量回路的应用场合。紧凑的防护外壳设计。使用户节约大量的空间，而无需牺牲回路数。



## 技术参数

标准/认证	
标准	DIN EN 61984 DIN EN 60664-1
认证	UL/CSA
插芯	
插针数	24, 42, 72, 108, 144, 216 + PE
额定电压	250 V
据UL/CSA制定的额定电压	600 V
额定电流	10 A
额定脉冲电压	4 kV
污染等级	3
绝缘阻抗	10 <sup>10</sup>
材料	玻璃纤维增强型PC
温度范围	-40 °C... +125 °C
据UL94制定的阻燃等级	V0
机械寿命	
-插孔银表面	500
-插孔金表面	500
接触阻抗	
-冷压联接	4 m
插针/材料	
材料	铜合金
表面	惰性银或镀金
接线范围	
-软导线	0.14 ... 2.5 mm <sup>2</sup> (AWG 26 ... 14)
-剥线长度	8.0 mm
PE联接	
-接线范围	0.5 ... 2.5 mm <sup>2</sup>
-硬导线	0.5 2.5 mm <sup>2</sup> / 0.5 ... 2.5 mm <sup>2</sup>
-软导线 (带或不带端头)	0.5 1.5 mm <sup>2</sup> / 0.5 ... 1.5 mm <sup>2</sup>
-AWG导线	AWG 20 ... 14
-剥线长度	10 mm
-拧紧转矩	1.2 ... 1.5 Nm
-螺丝刀头尺寸	SD 0.8 x 4 mm 或者PZ 1

电流曲线

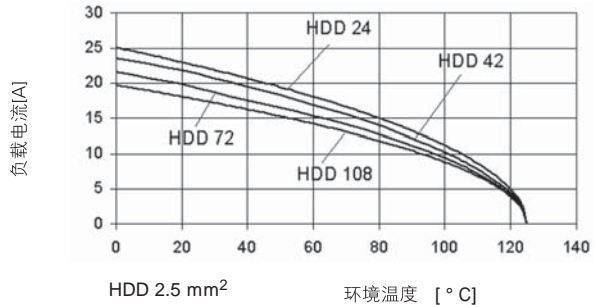
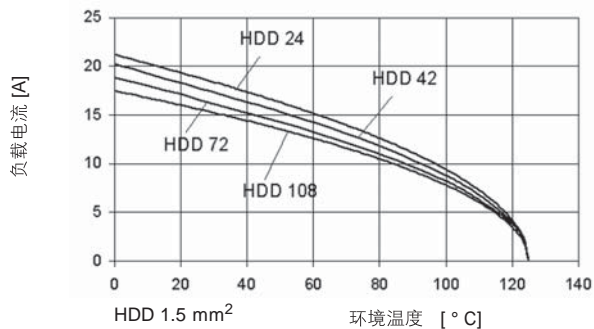

## 总揽

	尺寸	额定电压	额定电流	插针数	弹片联接	螺钉联系	冷压联接	直插式联接	同轴联接	页码
	3	250 V	10 A	24 + ⊕			•			B.68
	4	250 V	10 A	42 + ⊕			•			B.70
	6	250 V	10 A	72 + ⊕			•			B.72
	8	250 V	10 A	108 + ⊕			•			B.74
	10	250 V	10 A	144 + ⊕			•			B.76
	12	250 V	10 A	216 + ⊕			•			B.78



250 V, 10 A, 尺寸 3

24 + ⊕

插芯



冷压联接



插芯	型号	订货号
公	HDC HDD 24 MC	<b>1651150000</b>
母	HDC HDD 24 FC	<b>1651160000</b>

尺寸  
公

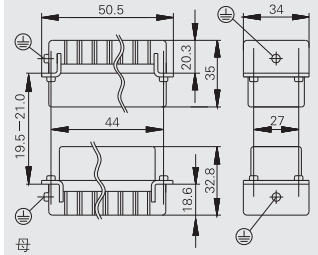

插针的排列  
公



母



开孔尺寸

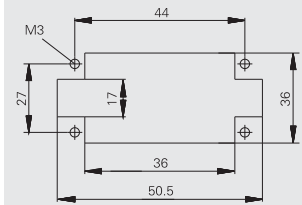

零配件

冷压插针

表面镀银



表面镀金



数量	公	订货号	母	订货号
100	HDC - C - HD - SM0.14 - 0.37AG	<b>1651520000</b>	HDC - C - HD - BM0.14 - 0.37AG	<b>1651570000</b>
100	HDC - C - HD - SM0.5AG	<b>1651530000</b>	HDC - C - HD - BM0.5AG	<b>1651580000</b>
100	HDC - C - HD - SM0.75 - 1AG	<b>1601750000</b>	HDC - C - HD - BM0.75 - 1AG	<b>1601760000</b>
100	HDC - C - HD - SM1.5AG	<b>1651550000</b>	HDC - C - HD - BM1.5AG	<b>1651600000</b>
100	HDC - C - HD - SM2.5AG	<b>1651560000</b>	HDC - C - HD - BM2.5AG	<b>1651610000</b>
100	HDC - C - HD - SM0.14 - 0.37AU	<b>1651620000</b>	HDC - C - HD - BM0.14 - 0.37AU	<b>1651670000</b>
100	HDC - C - HD - SM0.5AU	<b>1651630000</b>	HDC - C - HD - BM0.5AU	<b>1651680000</b>
100	HDC - C - HD - SM0.75 - 1AU	<b>1651640000</b>	HDC - C - HD - BM0.75 - 1AU	<b>1651690000</b>
100	HDC - C - HD - SM1.5AU	<b>1651650000</b>	HDC - C - HD - BM1.5AU	<b>1651700000</b>
100	HDC - C - HD - SM2.5AU	<b>1651660000</b>	HDC - C - HD - BM2.5AU	<b>1651710000</b>

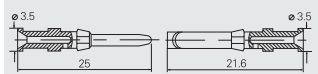

导线截面积

mm <sup>2</sup>	AWG 导线	剥线长度
0.14 - 0.37	22	8mm
0.50	20	8mm
0.75 - 1.00	18	8mm
1.50	16	8mm
2.50	14	8mm

工具



压针工具	订货号
CTX CM 1.6/2.5	<b>9018490000</b>
退针工具	订货号
退针工具 HD	<b>1866730000</b>

## RockStar® IP65/IP66外壳选择

## 尺寸3

\*更多外壳,请参阅D章节

## 插头外壳



## 插头外壳, 侧面进线



a	描述	防尘盖	b (mm)	型号	订货号
M 20	带螺纹		52	HDC 06B TSLU 1M20G	<b>1788100000</b>
M 20	带螺纹		52	HDC 06B TSLU 1M20G	<b>1805930000</b>
M 25	带螺纹		52	HDC 06B TSLU 1M25G	<b>1788090000</b>
M 25	带螺纹		72	HDC 16D TSLU 1M25G	<b>1787480000</b>

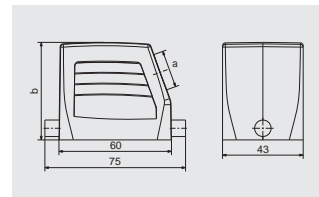

## 插头外壳, 顶部进线



a	描述	防尘盖	b (mm)	型号	订货号
M 20	带螺纹		52	HDC 06B TOLU 1M20G	<b>1788120000</b>
M 25	带螺纹		52	HDC 06B TOLU 1M25G	<b>1788110000</b>
M 25	带螺纹		72	HDC 16D TOLU 1M25G	<b>1787500000</b>
M 32	带螺纹		72	HDC 16D TOLU 1M32G	<b>1787490000</b>

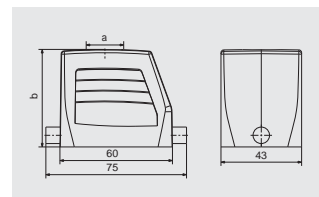

## 防尘盖



描述	型号	订货号
用于插头外壳	HDC 06B DMDL 1LB	<b>1665210000</b>

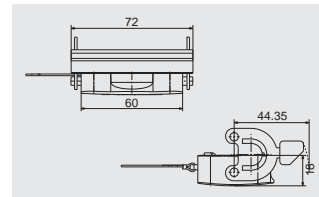

## 底座

## 穿体式插座外壳



描述	防尘盖	b (mm)	型号	订货号
		29	HDC 06B ALU	<b>1202100000</b>
	带	47	HDC 06B ADLU	<b>1202500000</b>

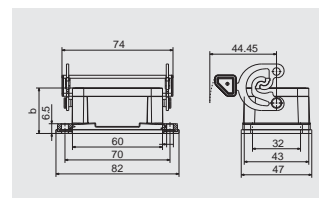

## 底座封闭式插座外壳



a	描述	防尘盖	b (mm)	型号	订货号
M 20	带螺纹		54	HDC 06B SLU 2M20G	<b>1788140000</b>
M 20	带螺纹	带	72	HDC 06B SDLU 2M20G	<b>1788170000</b>
M 25	带螺纹		54	HDC 06B SLU 2M25G	<b>1788130000</b>
M 25	带螺纹	带	72	HDC 06B SDLU 2M25G	<b>1788160000</b>

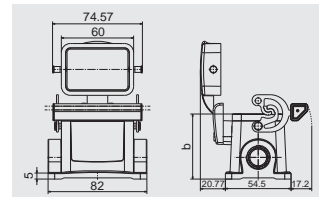

## 防尘盖



描述	型号	订货号
用于插座外壳	HDC 06B DODL 2BO	<b>1665200000</b>

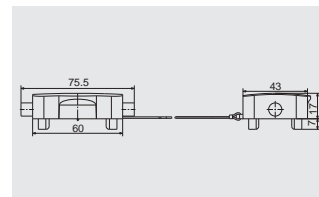

250 V, 10 A, 尺寸 4

42 + ⊕

插芯



冷压联接



插芯	型号	订货号
公	HDC HDD 42 MC	<b>1651170000</b>
母	HDC HDD 42 FC	<b>1651180000</b>

尺寸

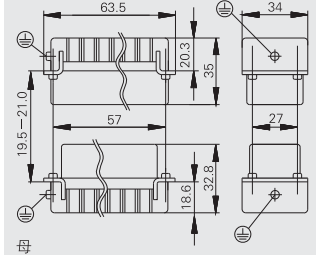

插针的排列

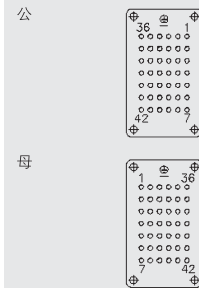

开孔尺寸

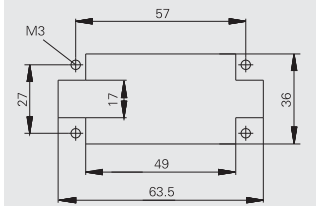

零配件

冷压插针

表面镀银



表面镀金



数量	公	订货号	母	订货号
100	HDC - C - HD - SM0.14 - 0.37AG	<b>1651520000</b>	HDC - C - HD - BM0.14 - 0.37AG	<b>1651570000</b>
100	HDC - C - HD - SM0.5AG	<b>1651530000</b>	HDC - C - HD - BM0.5AG	<b>1651580000</b>
100	HDC - C - HD - SM0.75 - 1AG	<b>1601750000</b>	HDC - C - HD - BM0.75 - 1AG	<b>1601760000</b>
100	HDC - C - HD - SM1.5AG	<b>1651550000</b>	HDC - C - HD - BM1.5AG	<b>1651600000</b>
100	HDC - C - HD - SM2.5AG	<b>1651560000</b>	HDC - C - HD - BM2.5AG	<b>1651610000</b>

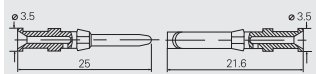

导线截面积

mm <sup>2</sup>	AWG 导线	剥线长度
0.14 - 0.37	22	8mm
0.50	20	8mm
0.75 - 1.00	18	8mm
1.50	16	8mm
2.50	14	8mm

工具



压针工具	订货号
CTX CM 1.6/2.5	<b>9018490000</b>
退针工具	订货号
退针工具 HD	<b>1866730000</b>

## RockStar® IP65/IP66外壳选择

## 尺寸4

\*更多外壳,请参D章节

## 插头外壳

## 插头外壳, 侧面进线



a	描述	防尘盖	b (mm)	型号	订货号
M 20	带螺纹		52	HDC 10B TSBU 1M20G	<b>1787560000</b>
M 25	带螺纹		52	HDC 10B TSBU 1M25G	<b>1787550000</b>
M 25	带螺纹		72	HDC 24D TSBU 1M25G	<b>1787240000</b>
M 32	带螺纹		72	HDC 24D TSBU 1M32G	<b>1787230000</b>

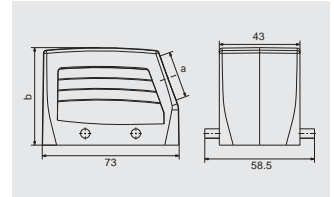

## 插头外壳, 顶部进线



a	描述	防尘盖	b (mm)	型号	订货号
M 20	带螺纹		52	HDC 10B TOBU 1M20G	<b>1787600000</b>
M 25	带螺纹		52	HDC 10B TOBU 1M25G	<b>1787590000</b>
M 25	带螺纹		72	HDC 24D TOBU 1M25G	<b>1787300000</b>
M 32	带螺纹		72	HDC 24D TOBU 1M32G	<b>1787290000</b>

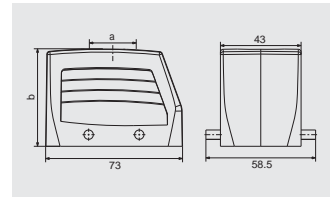

## 防尘盖



描述	型号	订货号
用于插头外壳	HDC 10B DMDQ 2QB	<b>1665240000</b>

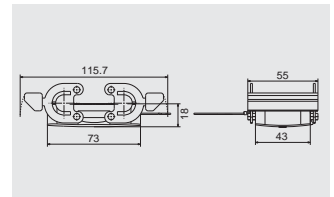

## 底座

## 穿体式插座外壳



描述	防尘盖	b (mm)	型号	订货号
		29.3	HDC 10B ABU	<b>1205000000</b>

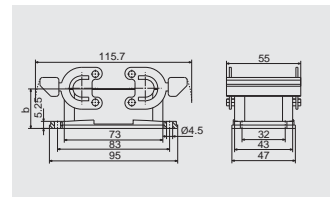

## 底座封闭型插座外壳



a	描述	防尘盖	b (mm)	型号	订货号
M 20	带螺纹		57	HDC 10B SBU 2M20G	<b>1787640000</b>
M 25	带螺纹		57	HDC 10B SBU 2M25G	<b>1787630000</b>
M 25	带螺纹		74	HDC 24D SBU 2M25G	<b>1787350000</b>
M 32	带螺纹		74	HDC 24D SBU 2M32G	<b>1787360000</b>

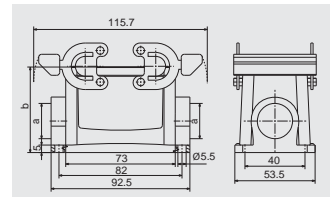

## 对接外壳



a	描述	防尘盖	b (mm)	型号	订货号
M 20	带螺纹		55	HDC 10B KBU 1M20G	<b>1787720000</b>

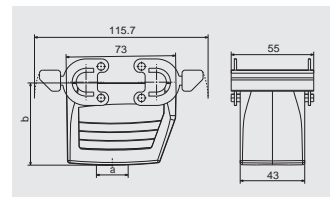

## 防尘盖



描述	型号	订货号
用于插座外壳	HDC 10B DODQ 4B0	<b>1665230000</b>

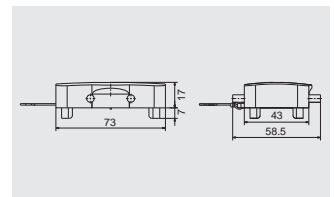

250 V, 10 A, 尺寸 6

72 + ⊕

插芯

冷压联接



插芯	型号	订货号
公	HDC HDD 72 MC	<b>1651190000</b>
母	HDC HDD 72 FC	<b>1651200000</b>

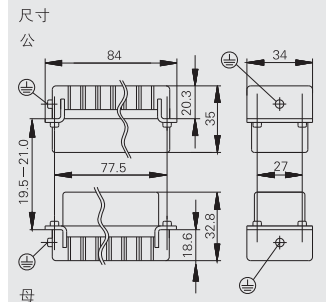

插芯的排列

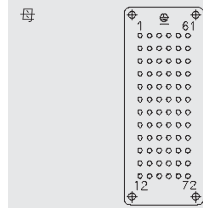
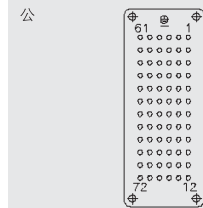

开孔尺寸

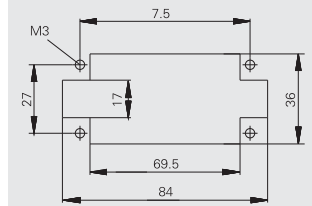

零配件

冷压插针

表面镀银



表面镀金



数量	公	订货号	母	订货号
100	HDC - C - HD - SM0.14 - 0.37AG	<b>1651520000</b>	HDC - C - HD - BM0.14 - 0.37AG	<b>1651570000</b>
100	HDC - C - HD - SM0.5AG	<b>1651530000</b>	HDC - C - HD - BM0.5AG	<b>1651580000</b>
100	HDC - C - HD - SM0.75 - 1AG	<b>1601750000</b>	HDC - C - HD - BM0.75 - 1AG	<b>1601760000</b>
100	HDC - C - HD - SM1.5AG	<b>1651550000</b>	HDC - C - HD - BM1.5AG	<b>1651600000</b>
100	HDC - C - HD - SM2.5AG	<b>1651560000</b>	HDC - C - HD - BM2.5AG	<b>1651610000</b>
100	HDC - C - HD - SM0.14 - 0.37AU	<b>1651620000</b>	HDC - C - HD - BM0.14 - 0.37AU	<b>1651670000</b>
100	HDC - C - HD - SM0.5AU	<b>1651630000</b>	HDC - C - HD - BM0.5AU	<b>1651680000</b>
100	HDC - C - HD - SM0.75 - 1AU	<b>1651640000</b>	HDC - C - HD - BM0.75 - 1AU	<b>1651690000</b>
100	HDC - C - HD - SM1.5AU	<b>1651650000</b>	HDC - C - HD - BM1.5AU	<b>1651700000</b>
100	HDC - C - HD - SM2.5AU	<b>1651660000</b>	HDC - C - HD - BM2.5AU	<b>1651710000</b>



导线截面积

mm <sup>2</sup>	AWG 导线	剥线长度
0.14 - 0.37	22	8mm
0.50	20	8mm
0.75 - 1.00	18	8mm
1.50	16	8mm
2.50	14	8mm

工具



压针工具	订货号
CTX CM 1.6/2.5	<b>9018490000</b>
退针工具	订货号
退针工具 HD	<b>1866730000</b>

## RockStar® IP65/IP66外壳选择

## 尺寸6

\*更多外壳,请参阅D章节

## 插头外壳



## 插头外壳, 侧面进线



a	描述	防尘盖	b (mm)	型号	订货号
M 25	带螺纹		61	HDC 16B TSBU 1M25G	<b>1788180000</b>
M 25	带螺纹		76	HDC 40D TSBU 1M25G	<b>1787010000</b>
M 32	带螺纹		76	HDC 40D TSBU 1M32G	<b>1787000000</b>

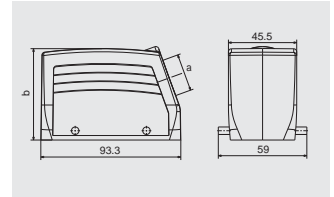

## 插头外壳, 顶部进线



a	描述	防尘盖	b (mm)	型号	订货号
M 25	带螺纹		61	HDC 16B TOBU 1M25G	<b>1788210000</b>
M 25	带螺纹		76	HDC 40D TOBU 1M25G	<b>1787070000</b>
M 32	带螺纹		76	HDC 40D TOBU 1M32G	<b>1787060000</b>

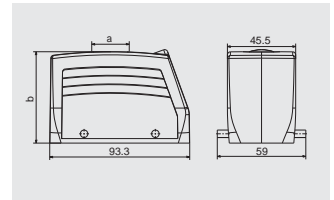

## 防尘盖



描述	型号	订货号
用于插头外壳	HDC 16B DMDQ 2QB	<b>1665270000</b>

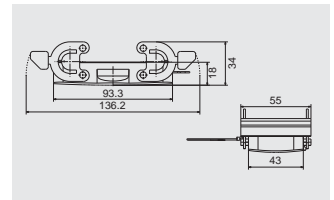

## 底座

## 穿体式插座外壳



描述	防尘盖	b (mm)	型号	订货号
		29	HDC 16B ABU	<b>1208600000</b>

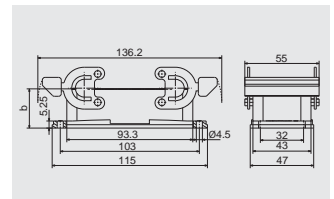

## 底座封闭式插座外壳



a	描述	防尘盖	b (mm)	型号	订货号
M 25	带螺纹		64	HDC 16B SBU 2M25G	<b>1788240000</b>
M 25	带螺纹		84	HDC 40D SBU 2M25G	<b>1787120000</b>
M 32	带螺纹		84	HDC 40D SBU 2M32G	<b>1787110000</b>

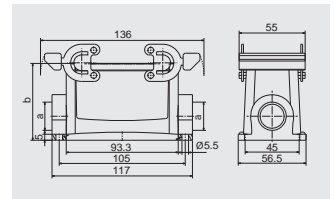

## 对接外壳



a	描述	防尘盖	b (mm)	型号	订货号
M 25	带螺纹		79	HDC 40D KBU 1M25G	<b>1787200000</b>
M 32	带螺纹		79	HDC 40D KBU 1M32G	<b>1787190000</b>

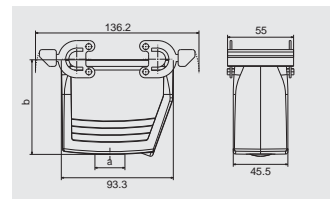

## 防尘盖



描述	型号	订货号
用于插座外壳	HDC 16B DODQ 4BO	<b>1665260000</b>

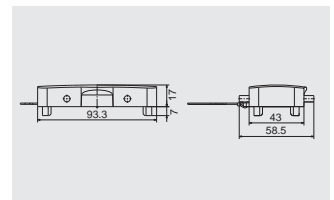

250 V, 10 A, 尺寸 8

108 + ⊕

插芯

冷压联接



插芯	型号	订货号
公	HDC HDD 108 MC	<b>1651210000</b>
母	HDC HDD 108 FC	<b>1651220000</b>

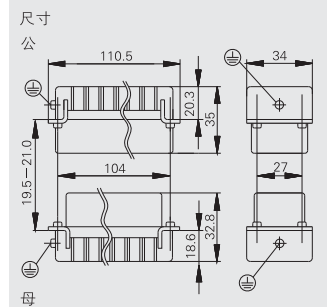

插针的排列

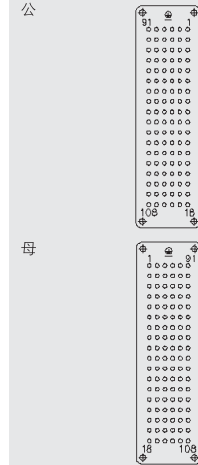

开孔尺寸

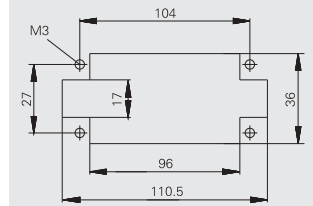

零配件

冷压插针

表面镀银



表面镀金



数量	公	订货号	母	订货号
100	HDC - C - HD - SM0.14 - 0.37AG	<b>1651520000</b>	HDC - C - HD - BM0.14 - 0.37AG	<b>1651570000</b>
100	HDC - C - HD - SM0.5AG	<b>1651530000</b>	HDC - C - HD - BM0.5AG	<b>1651580000</b>
100	HDC - C - HD - SM0.75 - 1AG	<b>1601750000</b>	HDC - C - HD - BM0.75 - 1AG	<b>1601760000</b>
100	HDC - C - HD - SM1.5AG	<b>1651550000</b>	HDC - C - HD - BM1.5AG	<b>1651600000</b>
100	HDC - C - HD - SM2.5AG	<b>1651560000</b>	HDC - C - HD - BM2.5AG	<b>1651610000</b>
100	HDC - C - HD - SM0.14 - 0.37AU	<b>1651620000</b>	HDC - C - HD - BM0.14 - 0.37AU	<b>1651670000</b>
100	HDC - C - HD - SM0.5AU	<b>1651630000</b>	HDC - C - HD - BM0.5AU	<b>1651680000</b>
100	HDC - C - HD - SM0.75 - 1AU	<b>1651640000</b>	HDC - C - HD - BM0.75 - 1AU	<b>1651690000</b>
100	HDC - C - HD - SM1.5AU	<b>1651650000</b>	HDC - C - HD - BM1.5AU	<b>1651700000</b>
100	HDC - C - HD - SM2.5AU	<b>1651660000</b>	HDC - C - HD - BM2.5AU	<b>1651710000</b>



导线截面积

mm <sup>2</sup>	AWG 导线	剥线长度
0.14 - 0.37	22	8mm
0.50	20	8mm
0.75 - 1.00	18	8mm
1.50	16	8mm
2.50	14	8mm

工具



压针工具	订货号
CTX CM 1.6/2.5	<b>9018490000</b>
退针工具	订货号
退针工具 HD	<b>1866730000</b>

## RockStar® IP65/IP66外壳选择

## 尺寸8

\*更多外壳,请参阅D章节

## 插头外壳

## 插头外壳, 侧面进线



a	描述	防尘盖	b (mm)	型号	订货号
M 25	带螺纹		61	HDC 24B TSBU 1M25G	<b>1787760000</b>
M 32	带螺纹		61	HDC 24B TSBU 1M32G	<b>1787750000</b>
M 25	带螺纹		76	HDC 64D TSBU 1M25G	<b>1786780000</b>
M 32	带螺纹		76	HDC 64D TSBU 1M32G	<b>1786770000</b>

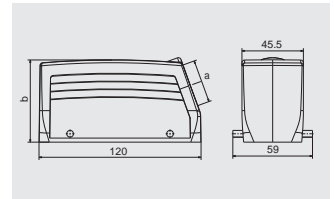

## 插头外壳, 顶部进线



a	描述	防尘盖	b (mm)	型号	订货号
M 25	带螺纹		61	HDC 24B TOBU 1M25G	<b>1787820000</b>
M 32	带螺纹		61	HDC 24B TOBU 1M32G	<b>1787810000</b>
M 32	带螺纹		76	HDC 64D TOBU 1M32G	<b>1786830000</b>

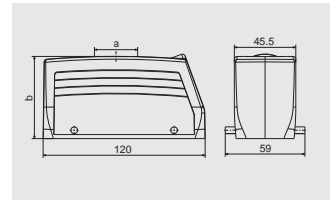

## 防尘盖



描述	型号	订货号
用于插头外壳	HDC 24B DMDQ 2QB	<b>1665640000</b>

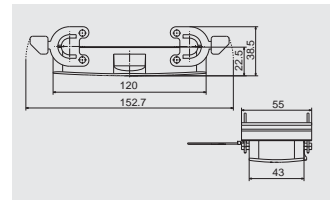

## 底座

## 穿体式插座外壳



描述	防尘盖	b (mm)	型号	订货号
		29.3	HDC 24B ABU	<b>1212400000</b>

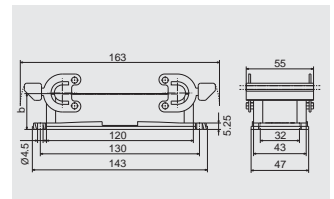

## 底座封闭式插座外壳



a	描述	防尘盖	b (mm)	型号	订货号
M 25	带螺纹		64	HDC 24B SBU 2M25G	<b>1787870000</b>
M 25	带螺纹		84	HDC 64D SBU 2M25G	<b>1786890000</b>
M 32	带螺纹		84	HDC 64D SBU 2M32G	<b>1786880000</b>

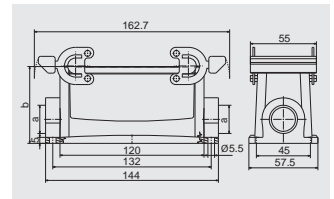

## 对接外壳



a	描述	防尘盖	b (mm)	型号	订货号
M 25	带螺纹		65	HDC 24B KBU 1M25G	<b>1787920000</b>
M 32	带螺纹		79	HDC 64D KBU 1M32G	<b>1786960000</b>

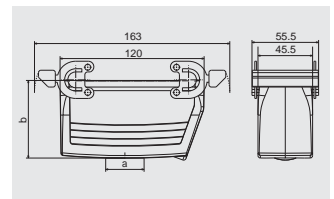

## 防尘盖



描述	型号	订货号
用于插座外壳	HDC 24B DODQ 4BO	<b>1665630000</b>

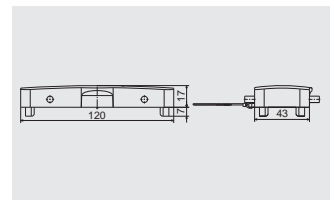



250 V, 10 A, 尺寸 10

144 + ⊕

插芯

冷压联接



插芯	型号	订货号
公	HDC HDD 72 MC	1651190000
母	HDC HDD 72 FC	1651200000
公	HDC HDD 144 MC	1651240000
母	HDC HDD 144 FC	1651260000

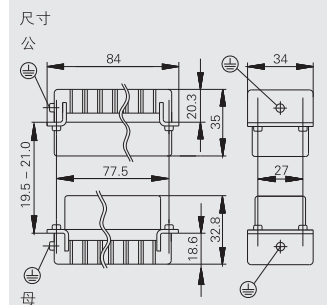

插芯的排列

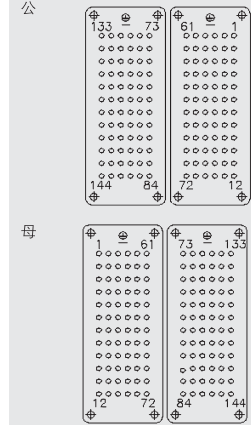

开孔尺寸

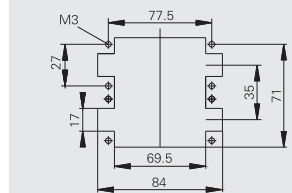

零配件

冷压插针

表面镀银



表面镀金



数量	公	订货号	母	订货号
100	HDC-C-HD-SM0.14-0.37AG	1651520000	HDC-C-HD-BM0.14-0.37AG	1651570000
100	HDC-C-HD-SM0.5AG	1651530000	HDC-C-HD-BM0.5AG	1651580000
100	HDC-C-HD-SM0.75-1AG	1601750000	HDC-C-HD-BM0.75-1AG	1601760000
100	HDC-C-HD-SM1.5AG	1651550000	HDC-C-HD-BM1.5AG	1651600000
100	HDC-C-HD-SM2.5AG	1651560000	HDC-C-HD-BM2.5AG	1651610000
100	HDC-C-HD-SM0.14-0.37AU	1651620000	HDC-C-HD-BM0.14-0.37AU	1651670000
100	HDC-C-HD-SM0.5AU	1651630000	HDC-C-HD-BM0.5AU	1651680000
100	HDC-C-HD-SM0.75-1AU	1651640000	HDC-C-HD-BM0.75-1AU	1651690000
100	HDC-C-HD-SM1.5AU	1651650000	HDC-C-HD-BM1.5AU	1651700000
100	HDC-C-HD-SM2.5AU	1651660000	HDC-C-HD-BM2.5AU	1651710000



导线截面积

mm <sup>2</sup>	AWG 导线	剥线长度
0.14 - 0.37	22	8mm
0.50	20	8mm
0.75 - 1.00	18	8mm
1.50	16	8mm
2.50	14	8mm

工具



压针工具	订货号
CTX CM 1.6/2.5	9018490000
退针工具	订货号
退针工具 HD	1866730000

## RockStar® IP65/IP66外壳选择

## 尺寸10

\*更多外壳,请参阅D章节

## 插头外壳



## 插头外壳, 侧面进线



a	描述	防尘盖	b (mm)	型号	订货号
M 32	带螺纹		79	HDC 32B TSLU 1M32G	<b>1788420000</b>

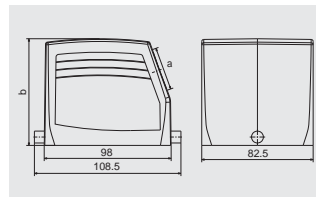

## 底座

## 穿体式插座外壳



描述	防尘盖	b (mm)	型号	订货号
	带	55	HDC 32B ADLU	<b>1219800000</b>
		38	HDC 32B ALU	<b>1219500000</b>

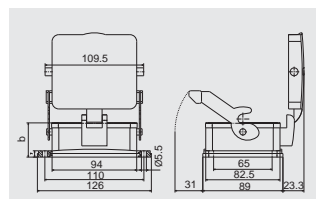

## 底座封闭式插座外壳



a	描述	防尘盖	b (mm)	型号	订货号
M 32	带螺纹	带	96	HDC 32B SDLU 2M32G	<b>1788490000</b>
M 32	带螺纹		79	HDC 32B SLU 2M32G	<b>1788470000</b>

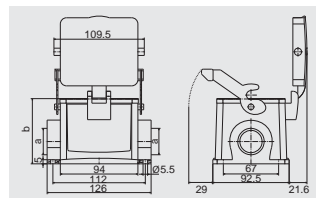

## 对接外壳



a	描述	防尘盖	b (mm)	型号	订货号
M 32	带螺纹		83	HDC 32B KLU 1M32G	<b>1788500000</b>

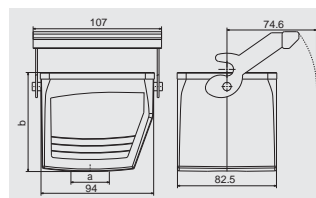

250 V, 10 A, 尺寸 12

216 + ⊕

插芯



冷压联接



插芯	型号	订货号
公	HDC HDD 108 MC	<b>1651210000</b>
母	HDC HDD 108 FC	<b>1651220000</b>
公	HDC HDD 216 MC	<b>1651280000</b>
母	HDC HDD 216 FC	<b>1651300000</b>

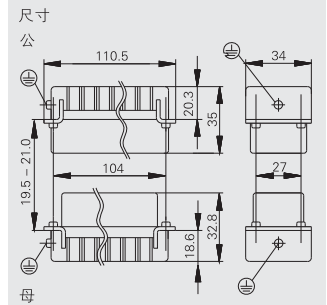

插针的排列

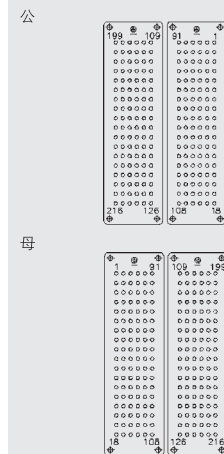

开孔尺寸

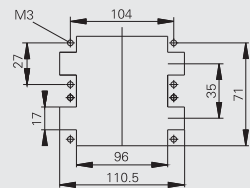

零配件

冷压插针

表面镀银



表面镀金



数量	公	订货号	母	订货号
100	HDC-C-HD-SM0.14-0.37AG	<b>1651520000</b>	HDC-C-HD-BM0.14-0.37AG	<b>1651570000</b>
100	HDC-C-HD-SM0.5AG	<b>1651530000</b>	HDC-C-HD-BM0.5AG	<b>1651580000</b>
100	HDC-C-HD-SM0.75-1AG	<b>1601750000</b>	HDC-C-HD-BM0.75-1AG	<b>1601760000</b>
100	HDC-C-HD-SM1.5AG	<b>1651550000</b>	HDC-C-HD-BM1.5AG	<b>1651600000</b>
100	HDC-C-HD-SM2.5AG	<b>1651560000</b>	HDC-C-HD-BM2.5AG	<b>1651610000</b>
100	HDC-C-HD-SM0.14-0.37AU	<b>1651620000</b>	HDC-C-HD-BM0.14-0.37AU	<b>1651670000</b>
100	HDC-C-HD-SM0.5AU	<b>1651630000</b>	HDC-C-HD-BM0.5AU	<b>1651680000</b>
100	HDC-C-HD-SM0.75-1AU	<b>1651640000</b>	HDC-C-HD-BM0.75-1AU	<b>1651690000</b>
100	HDC-C-HD-SM1.5AU	<b>1651650000</b>	HDC-C-HD-BM1.5AU	<b>1651700000</b>
100	HDC-C-HD-SM2.5AU	<b>1651660000</b>	HDC-C-HD-BM2.5AU	<b>1651710000</b>



导线截面积

mm <sup>2</sup>	AWG 导线	剥线长度
0.14 - 0.37	22	8mm
0.50	20	8mm
0.75 - 1.00	18	8mm
1.50	16	8mm
2.50	14	8mm

工具



压针工具	订货号
CTX CM 1.6/2.5	<b>9018490000</b>
退针工具	订货号
退针工具 HD	<b>1866730000</b>

## RockStar® IP65/IP66外壳选择

## 尺寸12

\*更多外壳,请参阅D章节

## 插头外壳



## 插头外壳, 侧面进线



a	描述	防尘盖	b (mm)	型号	订货号
M 32	带螺纹		94	HDC 48B TSLU 1M32G	<b>1788320000</b>
M 40	带螺纹		94	HDC 48B TSLU 1M40G	<b>1788310000</b>
M 50	带螺纹		94	HDC 48B TSLU 1M50G	<b>1788300000</b>

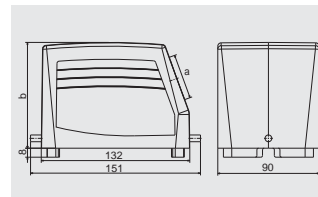

## 插头外壳, 顶部进线



a	描述	防尘盖	b (mm)	型号	订货号
M 32	带螺纹		94	HDC 48B TOLU 1M32G	<b>1788350000</b>
M 50	带螺纹		94	HDC 48B TOLU 1M50G	<b>1788330000</b>

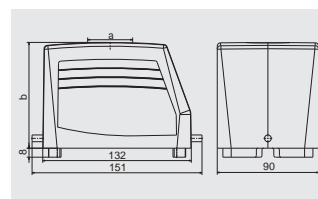

## 底座

## 穿体式插座外壳



描述	防尘盖	b (mm)	型号	订货号
	带	62	HDC 48B ADLU	<b>1222900000</b>

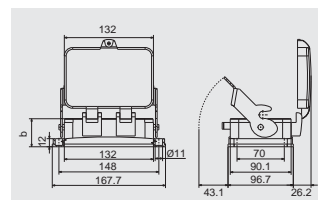

## 底座封闭型插座外壳



a	描述	防尘盖	b (mm)	型号	订货号
M 32	带螺纹	带	120	HDC 48B SDLU 2M32G	<b>1788390000</b>
M 32	带螺纹		100	HDC 48B SLU 2M32G	<b>1788370000</b>
M 40	带螺纹		100	HDC 48B SLU 2M40G	<b>1788360000</b>

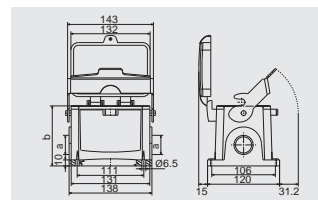

# HVE 高电压型插芯

魏德米勒高电压插芯带有防带电插拔保护插针，这意味着在带电的情况下不会有联接或断开的状态产生，保护了用户和设备。

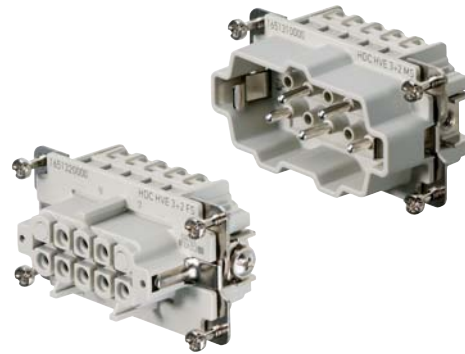

## 技术参数

标准/认证	
标准	DIN EN 61984 DIN EN 60664-1
认证	UL/CSA
插芯	
插针数	3 + 2, 6 + 2, 10 + 2
额定电压	830 V
据UL/CSA制定的额定电压	600 V
额定电流	23 A (HVE 3+2=24 A)
额定脉冲电压	8 KV
污染等级	3
绝缘阻抗	10 <sup>10</sup>
材料	玻璃纤维增强型PC
温度范围	-40 °C ... +125 °C
据UL94制定的阻燃等级	V0
机械寿命	
- 插孔银表面	500
插针/插套	
材料	铜合金
表面	惰性银
接线单元/螺钉联接	铜合金 / 惰性银
接线范围	
- 软导线	0.5 - 2.5 mm <sup>2</sup> (AWG 20 ... 14) / 9 mm
- 剥线长度	0.5 - 2.5 mm <sup>2</sup> (AWG 20 ... 14) / 8 mm
拧紧力矩	
- 螺钉联接	0.5 - 0.55 Nm
螺丝刀头	
- 螺钉联接	0.6 x 3.5 或者 PZ 0
- 弹片联接	0.5 x 3 或者 0.6 x 3.5
PE联接	
- 接线范围	0.5 ... 4 mm <sup>2</sup>
- 硬导线	0.5 ... 4 mm <sup>2</sup> / 0.5 ... 4 mm <sup>2</sup>
- 软导线 (带或不带端头)	0.5 ... 4 mm <sup>2</sup> / 0.5 ... 4 mm <sup>2</sup>
- AWG导线	AWG 20 .. 12
- 剥线长度	10 mm
- 拧紧转矩	1.2 ... 1.5 Nm
- 螺丝刀头尺寸	SD 0.8 x 4 mm 或者 PZ 1

## 电流曲线

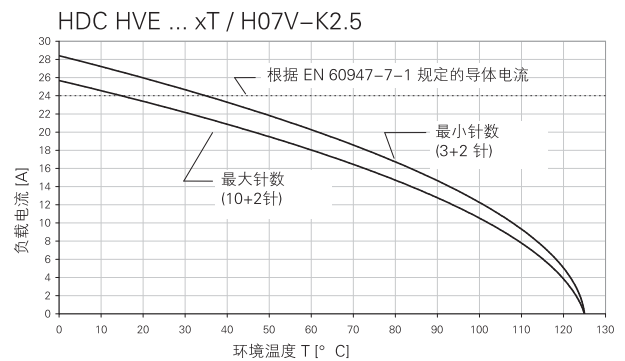
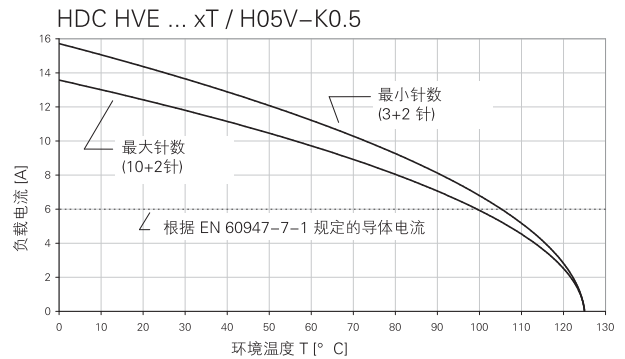

## 总揽

		尺寸	额定电压	额定电流	插针数	弹片联接	螺钉联系	冷压联接	直插式联接	同轴联接	页码
		4	830 V	24 A	3 + 2 + ⊕	•	•				B.82
		6	830 V	23 A	6 + 2 + ⊕	•	•				B.84
		8	830 V	23 A	10 + 2 + ⊕	•	•				B.86

830 V, 24 A, 尺寸 4

3+2 + ⊕

插芯



弹片联接



插芯	型号	订货号
公	HDC HVE 3+2 MT	1967230000
母	HDC HVE 3+2 FT	1967220000

螺钉联接



插芯	型号	订货号
公	HDC HVE 3+2 MS	1651310000
母	HDC HVE 3+2 FS	1651320000

尺寸

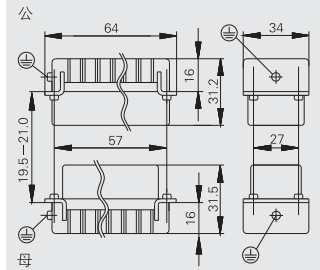

插针的排列

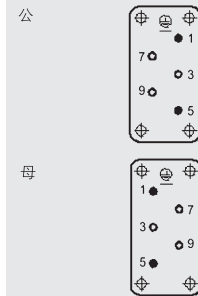

开孔尺寸

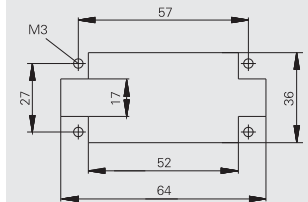

## RockStar® IP65/IP66外壳选择

## 尺寸4

\*更多外壳,请参阅D章节

## 插头外壳

## 插头外壳, 侧面进线



a	描述	防尘盖	b (mm)	型号	订货号
M 20	带螺纹		52	HDC 10B TSBU 1M20G	<b>1787560000</b>
M 25	带螺纹		52	HDC 10B TSBU 1M25G	<b>1787550000</b>
M 25	带螺纹		72	HDC 24D TSBU 1M25G	<b>1787240000</b>
M 32	带螺纹		72	HDC 24D TSBU 1M32G	<b>1787230000</b>

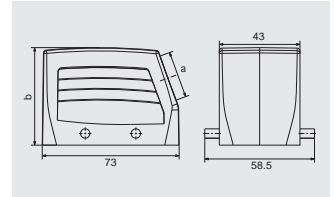

## 插头外壳, 顶部进线



a	描述	防尘盖	b (mm)	型号	订货号
M 20	带螺纹		52	HDC 10B TOBU 1M20G	<b>1787600000</b>
M 25	带螺纹		52	HDC 10B TOBU 1M25G	<b>1787590000</b>
M 25	带螺纹		72	HDC 24D TOBU 1M25G	<b>1787300000</b>
M 32	带螺纹		72	HDC 24D TOBU 1M32G	<b>1787290000</b>

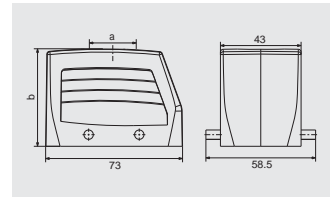

## 防尘盖



描述	型号	订货号
用于插头外壳	HDC 10B DMDQ 2QB	<b>1665240000</b>

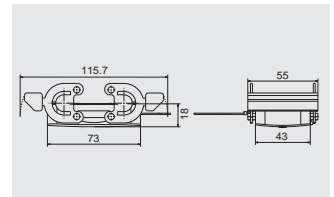

## 底座

## 穿体式插座外壳



描述	防尘盖	b (mm)	型号	订货号
		29.3	HDC 10B ABU	<b>1205000000</b>

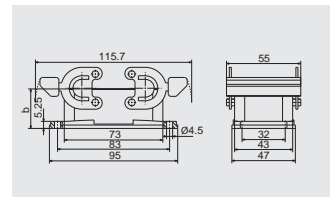

## 底座封闭式插座外壳



a	描述	防尘盖	b (mm)	型号	订货号
M 20	带螺纹		57	HDC 10B SBU 2M20G	<b>1787640000</b>
M 25	带螺纹		57	HDC 10B SBU 2M25G	<b>1787630000</b>
M 25	带螺纹		74	HDC 24D SBU 2M25G	<b>1787350000</b>
M 32	带螺纹		74	HDC 24D SBU 2M32G	<b>1787360000</b>

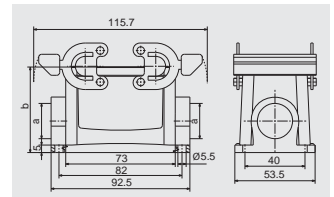

## 对接外壳



a	描述	防尘盖	b (mm)	型号	订货号
M 20	带螺纹		55	HDC 10B KBU 1M20G	<b>1787720000</b>

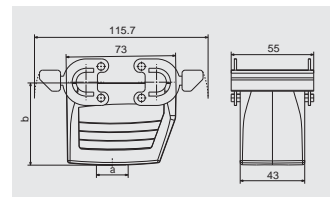

## 防尘盖



描述	型号	订货号
用于插座外壳	HDC 10B DODQ 4B0	<b>1665230000</b>

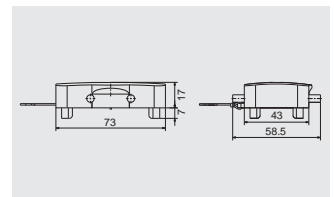



830 V, 23 A, 尺寸 6

6+2 + ⊕

插芯



弹片联接



插芯	型号	订货号
公	HDC HVE 6+2 MT	<b>1967250000</b>
母	HDC HVE 6+2 FT	<b>1967240000</b>

螺钉联接



插芯	型号	订货号
公	HDC HVE 6+2 MS	<b>1651330000</b>
母	HDC HVE 6+2 FS	<b>1651340000</b>

尺寸

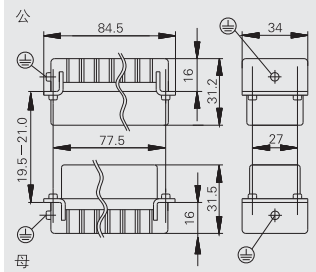

插针的排列

公



母



开孔尺寸

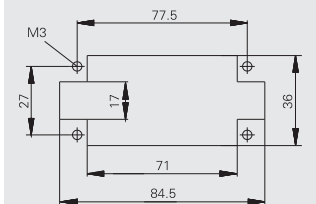

## RockStar® IP65/IP66外壳选择

## 尺寸6

\*更多外壳,请参D章节

## 插头外壳



## 插头外壳, 侧面进线



a	描述	防尘盖	b (mm)	型号	订货号
M 25	带螺纹		61	HDC 16B TSBU 1M25G	<b>1788180000</b>
M 25	带螺纹		76	HDC 40D TSBU 1M25G	<b>1787010000</b>
M 32	带螺纹		76	HDC 40D TSBU 1M32G	<b>1787000000</b>

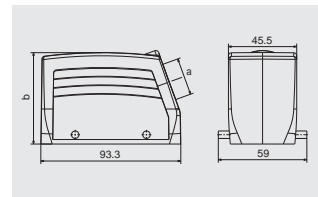

## 插头外壳, 顶部进线



a	描述	防尘盖	b (mm)	型号	订货号
M 25	带螺纹		61	HDC 16B TOBU 1M25G	<b>1788210000</b>
M 25	带螺纹		76	HDC 40D TOBU 1M25G	<b>1787070000</b>
M 32	带螺纹		76	HDC 40D TOBU 1M32G	<b>1787060000</b>

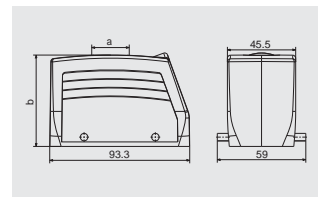

## 防尘盖



描述	型号	订货号
用于插头外壳	HDC 16B DMDQ 2QB	<b>1665270000</b>

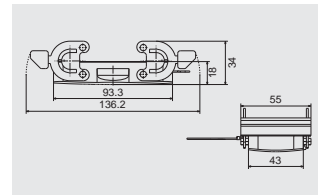

## 底座

## 穿体式插座外壳



描述	防尘盖	b (mm)	型号	订货号
		29	HDC 16B ABU	<b>1208600000</b>

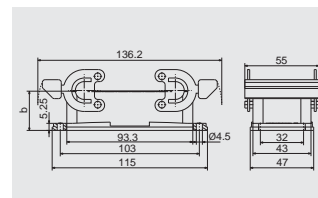

## 底座封闭型插座外壳



a	描述	防尘盖	b (mm)	型号	订货号
M 25	带螺纹		64	HDC 16B SBU 2M25G	<b>1788240000</b>
M 25	带螺纹		84	HDC 40D SBU 2M25G	<b>1787120000</b>
M 32	带螺纹		84	HDC 40D SBU 2M32G	<b>1787110000</b>

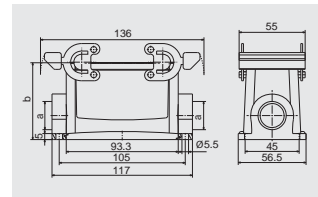

## 对接外壳



a	描述	防尘盖	b (mm)	型号	订货号
M 25	带螺纹		79	HDC 40D KBU 1M25G	<b>1787200000</b>
M 32	带螺纹		79	HDC 40D KBU 1M32G	<b>1787190000</b>

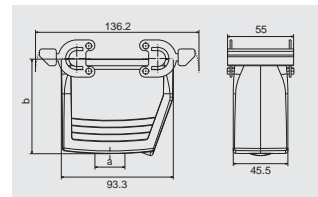

## 防尘盖



描述	型号	订货号
用于插座外壳	HDC 16B DODQ 4B0	<b>1665260000</b>

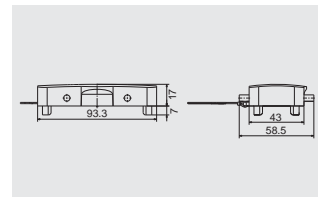

830 V, 23 A, 尺寸 8

10+2 + ⊕

插芯



弹片联接



插芯	型号	订货号
公	HDC HVE 10+2 MT	1967210000
母	HDC HVE 10+2 FT	1967260000

B

螺钉联接



插芯	型号	订货号
公	HDC HVE 10+2 MS	1651350000
母	HDC HVE 10+2 FS	1651360000

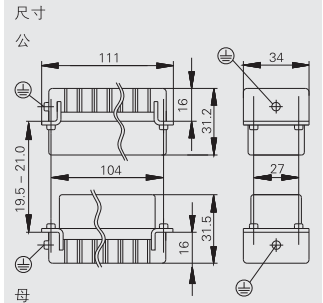

插针的排列

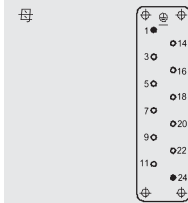
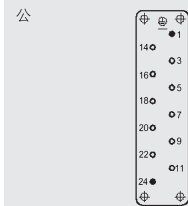

开孔尺寸

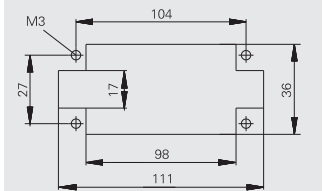

## RockStar® IP65/IP66外壳选择

## 尺寸8

\*更多外壳,请参阅D章节

## 插头外壳



## 插头外壳, 侧面进线



a	描述	防尘盖	b (mm)	型号	订货号
M 25	带螺纹		61	HDC 24B TSBU 1M25G	<b>1787760000</b>
M 32	带螺纹		61	HDC 24B TSBU 1M32G	<b>1787750000</b>
M 25	带螺纹		76	HDC 64D TSBU 1M25G	<b>1786780000</b>
M 32	带螺纹		76	HDC 64D TSBU 1M32G	<b>1786770000</b>

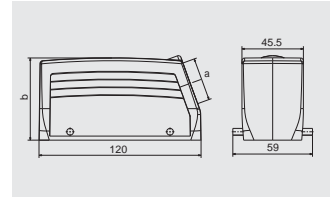

## 插头外壳, 顶部进线



a	描述	防尘盖	b (mm)	型号	订货号
M 25	带螺纹		61	HDC 24B TOBU 1M25G	<b>1787820000</b>
M 32	带螺纹		61	HDC 24B TOBU 1M32G	<b>1787810000</b>
M 32	带螺纹		76	HDC 64D TOBU 1M32G	<b>1786830000</b>

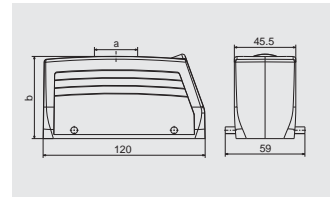

## 防尘盖



描述	型号	订货号
用于插头外壳	HDC 24B DMDQ 2QB	<b>1665640000</b>

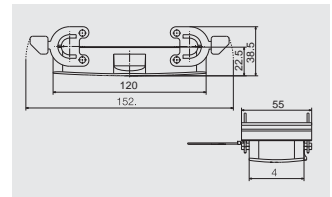

## 底座

## 穿体式插座外壳



描述	防尘盖	b (mm)	型号	订货号
		29.3	HDC 24B ABU	<b>1212400000</b>

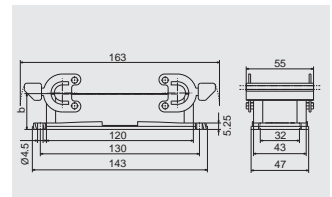

## 底座封闭式插座外壳



a	描述	防尘盖	b (mm)	型号	订货号
M 25	带螺纹		64	HDC 24B SBU 2M25G	<b>1787870000</b>
M 25	带螺纹		84	HDC 64D SBU 2M25G	<b>1786890000</b>
M 32	带螺纹		84	HDC 64D SBU 2M32G	<b>1786880000</b>

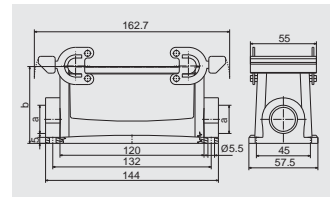

## 对接外壳



a	描述	防尘盖	b (mm)	型号	订货号
M 25	带螺纹		65	HDC 24B KBU 1M25G	<b>1787920000</b>
M 32	带螺纹		79	HDC 64D KBU 1M32G	<b>1786960000</b>

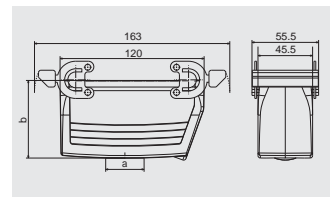

## 防尘盖



描述	型号	订货号
用于插座外壳	HDC 24B DODQ 4BO	<b>1665630000</b>

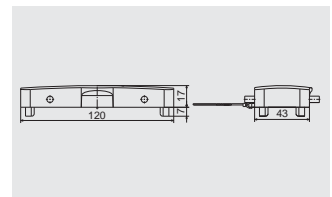

# HSB 高电流型插芯

每一回路可以提供35 A的电流，螺钉联接的接线方式提供客户一个安全而可靠的联接。

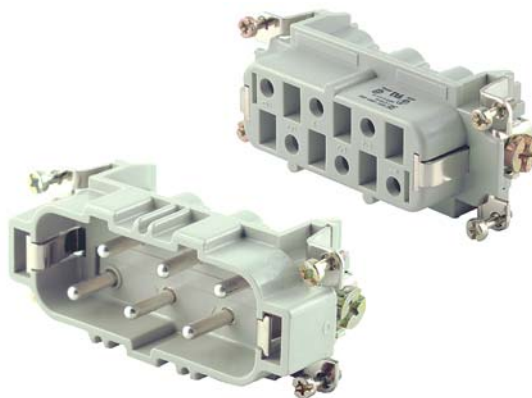

## 技术参数

标准/认证	
标准	DIN EN 61984 DIN EN 60664 - 1
认证	UL/CSA
插芯	
插针数	6, 12
额定电压	400 V
据UL/CSA制定的额定电压	600 V
额定电流	35 A
额定脉冲电压	6 kV
污染等级	3
绝缘阻抗	10 <sup>10</sup>
材料	玻璃纤维增强型PC
温度范围	-40 °C... +125 °C
据UL94制定的阻燃等级	V0
机械寿命	
- 插孔银表面	500
- 插孔金表面	500
接触阻抗	
- 螺钉联接	2 m
插针/插套	
材料	铜合金
表面	惰性银或镀金
接线单元/螺钉联接	铜合金/惰性银
接线范围	
- 软导线	0.5 - 6 mm <sup>2</sup> (AWG 20 ... 10)
- 剥线长度	11 mm
- 软导线带端头	4 mm <sup>2</sup>
拧紧力矩	
- 螺钉联接	1.2 ... 1.5 Nm
螺丝刀头	0.6 x 3.5 或者 0.8 x 4 mm
PE联接	
- 螺钉联接	0.5 ... 6 mm <sup>2</sup>
- 硬导线	0.5 ... 6 mm <sup>2</sup> / 0.5 ... 6 mm <sup>2</sup>
- 软导线 (带或不带端头)	0.5 ... 6 mm <sup>2</sup> / 0.5 ... 6 mm <sup>2</sup>
- AWG导线	AWG 20 .. 12
- 剥线长度	10 mm
- 拧紧转矩	2 ... 2.5 Nm
- 螺丝刀头尺寸	SD 1 x 5.5 mm 或者 PH 2

## 电流曲线

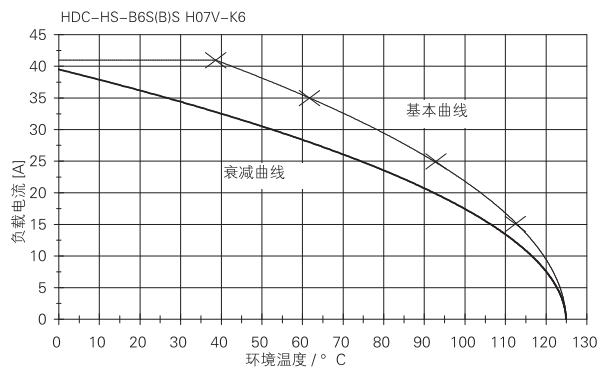

## 总揽

	尺寸	额定电压	额定电流	插针数	弹片联接	螺钉联系	冷压联接	直插式联接	同轴联接	页码
	6	400 V	35 A	6 + ⊕		•				B.90
	8	400 V	35 A	12 + ⊕		•				B.92

400 V, 35 A, 尺寸 6

6 + ⊕

插芯



螺钉联接



插芯	型号	订货
公	HDC HSB 6 MS	1498700000
母	HDC HSB 6 FS	1498900000

尺寸

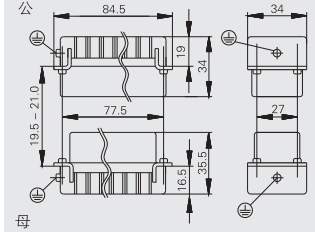

插针的排列

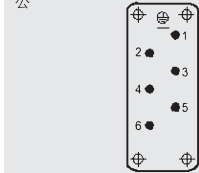

母

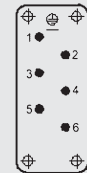

开孔尺寸

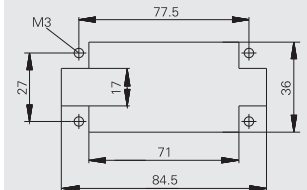

## RockStar® IP65/IP66外壳选择

## 尺寸6

\*更多外壳,请参阅D章节

## 插头外壳



## 插头外壳, 侧面进线



a	描述	防尘盖	b (mm)	型号	订货号
M 25	带螺纹		61	HDC 16B TSBU 1M25G	<b>1788180000</b>
M 25	带螺纹		76	HDC 40D TSBU 1M25G	<b>1787010000</b>
M 32	带螺纹		76	HDC 40D TSBU 1M32G	<b>1787000000</b>

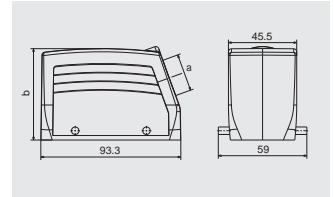

## 插头外壳, 顶部进线



a	描述	防尘盖	b (mm)	型号	订货号
M 25	带螺纹		61	HDC 16B TOBU 1M25G	<b>1788210000</b>
M 25	带螺纹		76	HDC 40D TOBU 1M25G	<b>1787070000</b>
M 32	带螺纹		76	HDC 40D TOBU 1M32G	<b>1787060000</b>

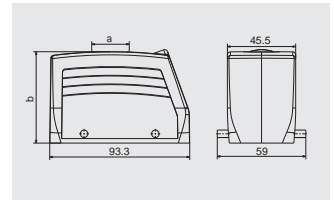

## 防尘盖



描述	型号	订货号
用于插头外壳	HDC 16B DMDQ 2QB	<b>1665270000</b>

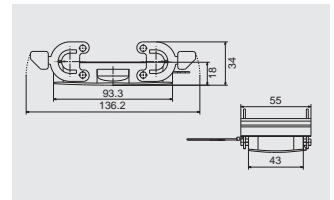

## 底座

## 穿体式插座外壳



描述	防尘盖	b (mm)	型号	订货号
		29	HDC 16B ABU	<b>1208600000</b>

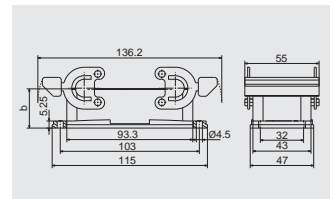

## 底座封闭式插外壳



a	描述	防尘盖	b (mm)	型号	订货号
M 25	带螺纹		64	HDC 16B SBU 2M25G	<b>1788240000</b>
M 25	带螺纹		84	HDC 40D SBU 2M25G	<b>1787120000</b>
M 32	带螺纹		84	HDC 40D SBU 2M32G	<b>1787110000</b>

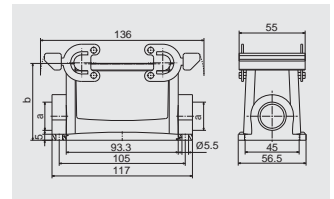

## 对接外壳



a	描述	防尘盖	b (mm)	型号	订货号
M 25	带螺纹		79	HDC 40D KBU 1M25G	<b>1787200000</b>
M 32	带螺纹		79	HDC 40D KBU 1M32G	<b>1787190000</b>

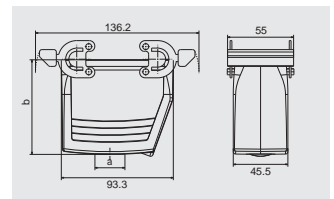

## 防尘盖



描述	型号	订货号
用于插座外壳	HDC 16B DODQ 4BO	<b>1665260000</b>

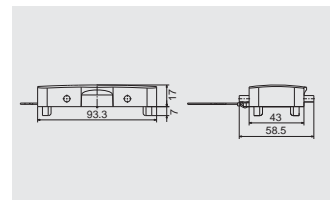



400 V, 35 A, 尺寸 10

12 + ⊕

插芯



螺钉联接



插芯	型号	订货
公	HDC HSB 6 MS	1498700000
母	HDC HSB 6 FS	1498900000
公	HDC HSB 6 MS 7 - 12	1498800000
母	HDC HSB 6 FS 7 - 12	1499000000

尺寸

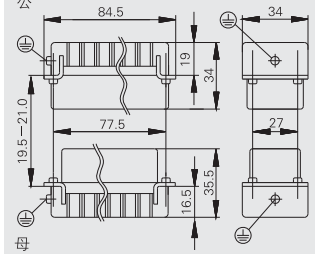

插针的排列

公

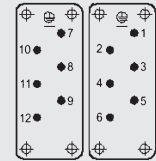

母

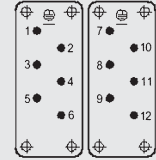

开孔尺寸

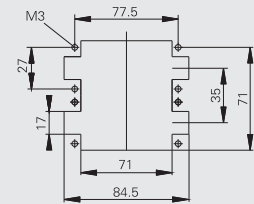

## RockStar® IP65/IP66外壳选择

## 尺寸10

\*更多外壳,请参阅D章节

## 插头外壳



## 插头外壳, 侧面进线



a	描述	防尘盖	b (mm)	型号	订货号
M 32	带螺纹		79	HDC 32B TSLU 1M32G	<b>1788420000</b>

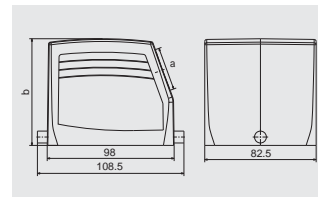

## 底座

## 穿体式插座外壳



描述	防尘盖	b (mm)	型号	订货号
	带防尘盖	55	HDC 32B ADLU	<b>1219800000</b>
		38	HDC 32B ALU	<b>1219500000</b>

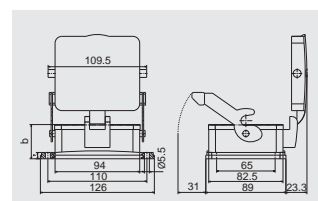

## 底座封闭型插座外壳



a	描述	防尘盖	b (mm)	型号	订货号
M 32	带螺纹	带防尘盖	96	HDC 32B SDLU 2M32G	<b>1788490000</b>
M 32	带螺纹		79	HDC 32B SLU 2M32G	<b>1788470000</b>

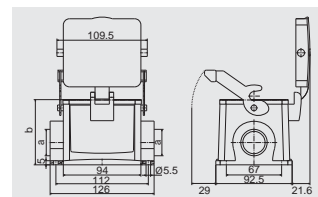

## 底座封闭型插座外壳



a	描述	防尘盖	b (mm)	型号	订货号
M 32	带螺纹		83	HDC 32B KLU 1M32G	<b>1788500000</b>

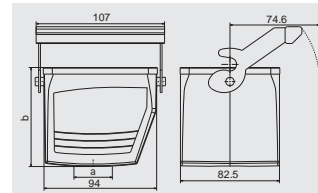

# MixMate - 混合型插芯

MixMate系列插芯拥有螺钉，同轴螺钉，冷压三种接线方式同时以传输大电流的电源信号和小的信号控制。



## 技术参数

	S4	S8/24	S4/0 Axial	S4/0	S4/2
标准 / 认证					
标准	DIN EN 61984 DIN EN 60664 - 1	DIN EN 61984 DIN EN 60664 - 1	DIN EN 61984 DIN EN 60664 - 1	DIN EN 61984 DIN EN 60664 - 1	DIN EN 61984 DIN EN 60664 - 1
认证	UL/CSA	UL/CSA/VDE	UL/CSA	UL/CSA/VDE	UL/CSA/VDE
插芯					
插针数					
- 电力触点	4 (+PE)	8 (+PE)	4 (+PE)	4 (+PE)	4 (+PE)
- 信号触点		24			2
额定电压					
- 电力触点	1000 V	400 V	690 V	830 V	830 V
- 信号触点		160 V			400 V
据UL/CSA制定的额定电压	600 V	600 V	600 V	600 V	600 V
额定电流					
- 电力触点	65 A	16 A	80 A	80 A	80 A
- 信号触点		10 A			16 A
额定脉冲电压					
- 电力触点	8 KV	4 KV	8 KV	8 KV	8 KV
- 信号触点		2.5 KV			6 KV
污染等级	3	3	3 (1000 V / 8 kV / 2)	3	3
绝缘阻抗	10 <sup>10</sup>	10 <sup>10</sup>	10 <sup>10</sup>	10 <sup>10</sup>	10 <sup>10</sup>
材料	玻璃纤维增强型PC	玻璃纤维增强型PC	玻璃纤维增强型PC	玻璃纤维增强型PC	玻璃纤维增强型PC
温度范围	-40 °C ... +125 °C	-40 °C ... +125 °C	-40 °C ... +125 °C	-40 °C ... +125 °C	-40 °C ... +125 °C
根据UL 94制定的阻燃等级	V-0	V-0	V-0	V-0	V-0
机械寿命					
- 插孔银表面	500	500	500	500	500
- 插孔金表面		500			
接触阻抗	1 m	2 m (电力触点) 4 m (信号触点)	1 m	1 m	1 m (电力触点) 2 m (信号触点)
插针 / 材料					
材料	铜合金	铜合金	铜合金	铜合金	铜合金
表面	惰性银	惰性银或金	惰性银	惰性银	惰性银
接线范围					
- 电力触点	2.5 - 10 mm <sup>2</sup> (AWG 14 ... 8)	0.5 - 4 mm <sup>2</sup> (AWG 20 ... 12)	1.5 - 16 mm <sup>2</sup> (AWG 16 ... 6)	1.5 - 16 mm <sup>2</sup> (AWG 16 ... 6)	1.5 - 16 mm <sup>2</sup> (AWG 16 ... 6)
- 信号触点		0.14 - 2.5 mm <sup>2</sup> (AWG 26 ... 14)			0.5 - 2.5 mm <sup>2</sup> (AWG 22 ... 14)
剥线长度					
- 电力触点	8 mm	7.5 mm	13 mm	15 mm	15 mm
- 信号触点		8 mm			8 mm
扭矩					
- 电力触点	1.1 - 1.7 Nm		2 ... 3 Nm	1.2 Nm (1.5 mm <sup>2</sup> ) / 2 Nm (2.5 mm <sup>2</sup> ) / 3 Nm (4 - 16 mm <sup>2</sup> )	1.2 Nm (1.5 mm <sup>2</sup> ) / 2 Nm (2.5 mm <sup>2</sup> ) / 3 Nm (4 - 16 mm <sup>2</sup> )
- 信号触点					0.5 - 0.55 Nm
工具					
- 内六角螺丝刀	SW 2		SW 3		
- 螺钉刀	0.6 x 3.5 mm			SD 0.8 x 4 mm	SD 0.8 x 4 mm (电力触点) SD 0.6 x 3.5 mm 或者 PH1(信号触点)
- 压接工具		CTIN 1.6/2.5			
PE 联接					
螺钉联接					
- 公制	1.5/2.5 - 4/10 mm <sup>2</sup>	0.5 - 6 mm <sup>2</sup>	1.5 - 16 mm <sup>2</sup>	0.5 - 16 mm <sup>2</sup> 10 - 16 mm <sup>2</sup>	0.5 - 16 mm <sup>2</sup> 10 - 16 mm <sup>2</sup>
- AWG 型号	AWG 16/14 ... 12/8	AWG 20 ... 10	AWG 16 ... 4	AWG 20 ... 6	AWG 20 ... 6
- 剥线长度	8 mm	13 mm	8 mm	13 mm	13 mm
- 拧紧力矩	0.5 - 0.8 Nm	2 - 2.5 Nm	2 - 2.5 Nm	2 - 2.5 Nm	2 - 2.5 Nm
- 螺丝刀头尺寸	SD 0.8 x 4 mm	SD 1.2 x 6.5 mm 或 PH 2	SD 0.8 x 4 mm 或 PZ 2	SD 1.2 x 6.5 mm 或 PH 2	SD 1.2 x 6.5 mm 或 PH 2

S6/12*	S6/36	S12/2	S4/8	S6/6*	S8/0
DIN EN 61984 DIN EN 60664-1 UL/CSA	DIN EN 61984 DIN EN 60664-1 UL/CSA/VDE	DIN EN 61984 DIN EN 60664-1 UL/CSA/VDE	DIN EN 61984 DIN EN 60664-1 UL/CSA/VDE	DIN EN 61984 DIN EN 60664-1 UL/CSA	DIN EN 61984 DIN EN 60664-1 UL/CSA/VDE
6 (+PE) 12	6 (+PE) 36	12 (+PE) 2	4 (+PE) 8	6 (+PE) 6	8 (+PE x 2)
690 V 400 V 600 V	690 V 160 V 600 V	690 V 250 V 600 V	400 V 400 V 600 V	690 V 400 V 600 V	690 V 600 V
48 A 16 A	40 A 10 A	40 A 10 A	80 A 16 A	100 A 16 A	110 A
8 KV 6 KV 3	8 KV 2.5 KV 3	8 KV 4 KV 3	6 KV 6 KV 3	8 KV 6 KV 3	8 KV 3
10 <sup>10</sup> 玻璃纤维增强型PC -40 °C ... +125 °C V - 0	10 <sup>10</sup> 玻璃纤维增强型PC -40 °C ... +125 °C V - 0	10 <sup>10</sup> 玻璃纤维增强型PC -40 °C ... +125 °C V - 0	10 <sup>10</sup> 玻璃纤维增强型PC -40 °C ... +125 °C V - 0	10 <sup>10</sup> 玻璃纤维增强型PC -40 °C ... +125 °C V - 0	10 <sup>10</sup> 玻璃纤维增强型PC -40 °C ... +125 °C V - 0
500 2 m (电力触点) 2 m (信号触点)	500 500 2 m (电力触点) 4 m (信号触点)	500 500 2 m (电力触点) 4 m (信号触点)	500 1 m (电力触点) 2 m (信号触点)	500 1 m (电力触点) 2 m (信号触点)	500 1 m
铜合金 惰性银	铜合金 惰性银或金	铜合金 惰性银或金	铜合金 惰性银	铜合金 惰性银	铜合金 惰性银
2.5 - 10 mm <sup>2</sup> (AWG 14 ... 8) 0.5 - 2.5 mm <sup>2</sup> (AWG 24 ... 14)	1.5 - 6 mm <sup>2</sup> (AWG 16 ... 10) 0.14 - 2.5 mm <sup>2</sup> (AWG 26 ... 14)	1.5 - 6 mm <sup>2</sup> (AWG 16 ... 10) 0.14 - 2.5 mm <sup>2</sup> (AWG 26 ... 14)	1.5 - 16 mm <sup>2</sup> (AWG 16 ... 6) 0.5 - 2.5 mm <sup>2</sup> (AWG 22 ... 14)	16 - 35 mm <sup>2</sup> (AWG 6 ... 2) 0.5 - 2.5 mm <sup>2</sup> (AWG 24 ... 14)	10 - 25 mm <sup>2</sup> (AWG 8 ... 4)**
8 mm 12 mm	9 mm 8 mm	9 mm 8 mm	15 mm 8 mm	13 mm 12 mm	12 mm
1.1 ... 1.7 Nm			1.2 Nm (1.5 mm <sup>2</sup> ) / 2 Nm (2.5 mm <sup>2</sup> ) / 3 Nm (4 - 16 mm <sup>2</sup> )	6 ... 8 Nm	6 Nm (10 - 16 mm <sup>2</sup> ) / 7 Nm (25 mm <sup>2</sup> )
0.45 ... 0.9 Nm			0.5 - 0.55 Nm	0.45 ... 0.9 Nm	
SW 2 0.6 x 3.5 mm				SW 4 SD 0.6 x 3.5 或者 PZ 0	SW 4
	CTIN 1.6/2.5	CTIN 1.6/2.5			
2.5 - 10 mm <sup>2</sup>	0.5 - 6 mm <sup>2</sup>	0.5 - 6 mm <sup>2</sup>	0.5 - 16 mm <sup>2</sup> 10 - 16 mm <sup>2</sup>	16 - 35 mm <sup>2</sup>	10 - 25 mm <sup>2</sup> **
AWG 14 ... 8	AWG 20 ... 10	AWG 20 ... 10	AWG 20 ... 6	AWG 6 ... 2	AWG 8 ... 4
8 mm 2 - 2.5 Nm	13 mm 2 - 2.5 Nm	13 mm 2 - 2.5 Nm	13 mm 2 - 2.5 Nm	8 mm 6 - 8 Nm	12 mm 6 Nm (10 - 16 mm <sup>2</sup> )/7 Nm (25 mm <sup>2</sup> )
SD 0.8 x 4 mm 或 PZ 2	SD 1.2 x 6.5 mm 或 PH 2	SD 1.2 x 6.5 mm 或 PH 2	SD 1.2 x 6.5 mm 或 PH 2	SD 0.8 x 4 mm 或 PZ 1	SD 5.5 x 1.0 或 PH 2

总揽

	尺寸	额定电压	额定电流	插针数	弹片联接	螺钉联接	冷压联接	直插联接	同轴联接	页码
	3	1000 V	65 A	4 + ⊕					•	B.99
	4	400 V	16 A	8 + 24 + ⊕				•		B.107
	6	830 V	80 A	4 + 0 + ⊕					•	B.101
	6	830 V	80 A	4 + 0 + ⊕		•				B.101
	6	830 V	80 A	4 + 2 + ⊕		•				B.101
	6	690 V	40 A	6 + 36 + ⊕				•		B.109
	6	690 V	48 A	6 + 12 + ⊕		•			•	B.103
	6	690 V	40 A	12 + 2 + ⊕				•		B.111
	8	400 V	80 A	4 + 8 + ⊕		•				B.113
	8	690 V	100 A	6 + 6 + ⊕		•			•	B.105
	8	690 V	110 A	8 + 0 + ⊕					•	B.115

## 内六角螺丝刀



## 订货数据

型号	数量	订货号
IS 2 KG	2	1806630000
IS 3 KG	2	1806650000
IS 4 KG	2	1806660000

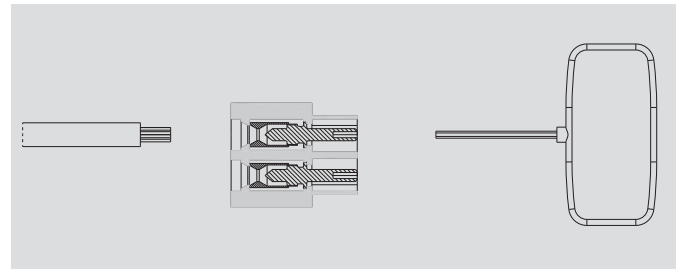

## 接线指南：

1. 根据技术参数表中告知的剥线长度剥线，注意不要伤到或扭曲导线铜丝
2. 将导线插入插针，覆盖在插针背部锥面上，直到导线绝缘皮进入接线框内
3. 将内六角螺丝刀伸入插针的对插面中间的孔，拧动螺丝刀，将后面的导线压紧

## 技术参数

电力插针	S 4	S 4/0	S 6/12	S 6/6
剥线长度	8 mm	13 mm	8 mm	13 mm
拧紧力矩	1.1 - 1.7 Nm	2 - 3 Nm	1.1 - 1.7 Nm	6 ... 8 Nm
内六角螺丝刀	IS 2 KG	IS 3 KG	IS 2 KG	IS 4 KG

## 技术参数

## 电流衰减曲线

尺寸 3  
HDC S4  
电力插针: H07V-K14  
衰减系数: 0.80

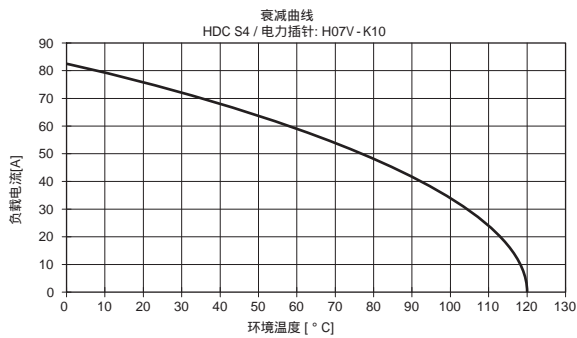

## 尺寸 4

HDC S8/24  
电力插针: H07V-K14  
信号插针: H07V-K2.5  
衰减系数: 0.80

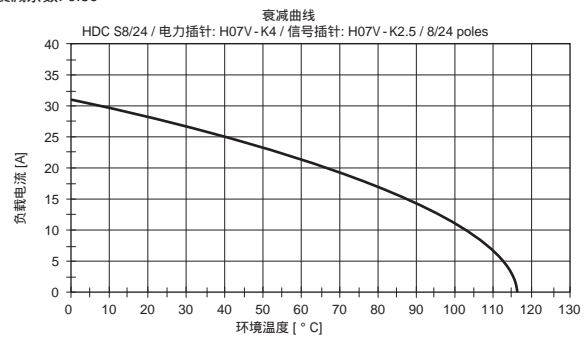

## 尺寸 6

HDC S4/0  
电力插针 H07V-K16  
信号插针  
衰减系数: 0.80

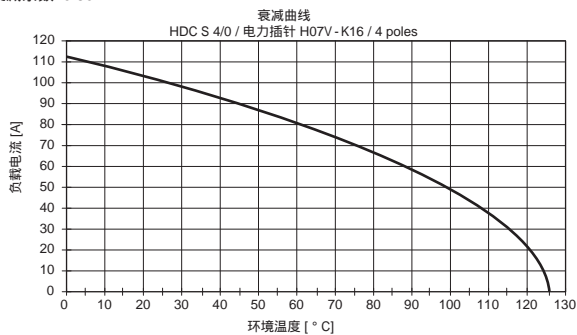

## 尺寸 6

HDC S4/2  
电力插针 H07V-K16  
信号插针 H07V-K2.5  
衰减系数: 0.80

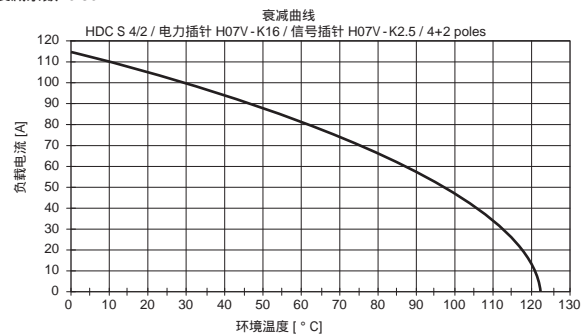

技术参数

衰减曲线

尺寸 6  
HDC S6/12  
电力插针: H07V-K10  
信号插针:  
衰减系数: 0.80

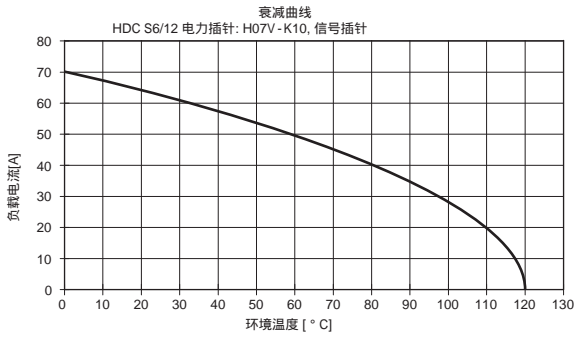

尺寸 6  
HDC S6/36  
电力插针: H07V-K6  
信号插针: H07V-K2.5  
衰减系数: 0.80

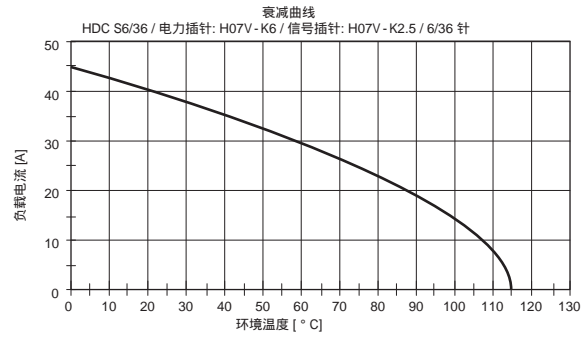

尺寸 6  
HDC S12/2  
电力插针: H07V-K10  
信号插针: H07V-K2.5  
衰减系数: 0.80

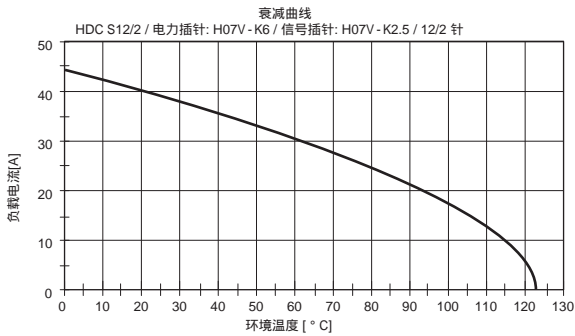

尺寸 8  
HDC S4/8  
电力插针: H07V-K16  
信号插针: H07V-K2.5  
衰减系数: 0.80

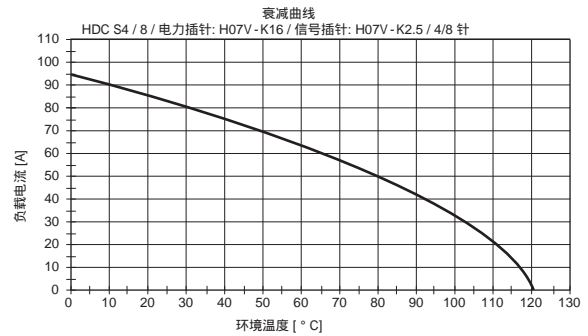

尺寸 8  
HDC S6/6  
电力插针: H07V-K35  
信号插针: H07V-K2.5  
衰减系数: 0.80

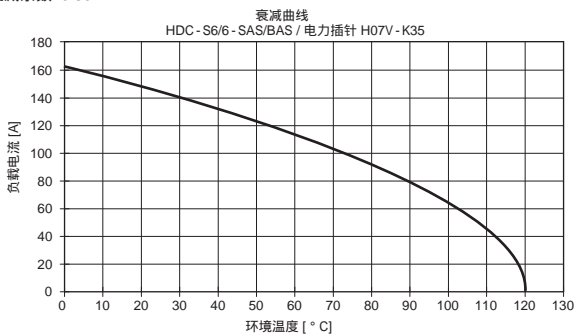

尺寸 8  
HDC S8/0  
电力插针: H07V-K25  
信号插针: not available  
衰减系数: 0.80

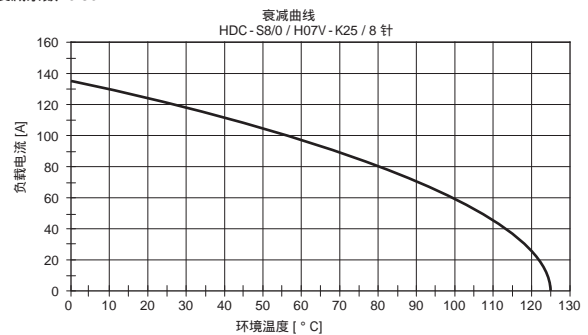

1000 V, 65 A, 尺寸 3

4 + ⊕

插芯



同轴螺钉联接



插芯	型号	订货号
公	HDC S4 SAS	1789990000
母	HDC S4 BAS	1789980000

尺寸

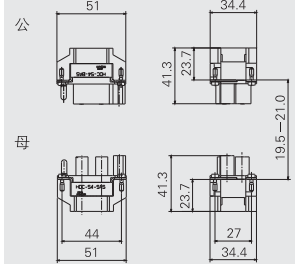

插针的排列

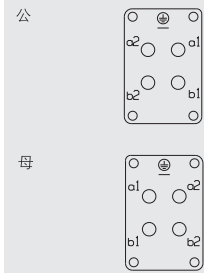

开孔尺寸

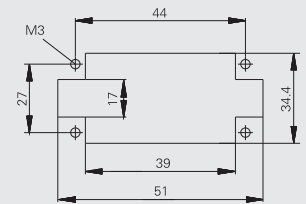



RockStar® IP65/IP66外壳选择

尺寸3

\*更多外壳,请参阅D章节



插头外壳

插头外壳, 侧面进线



a	描述	防尘盖	b (mm)	型号	订货号
M 20	带螺纹		52	HDC 06B TSLU 1M20G	<b>1788100000</b>
M 20	带螺纹		52	HDC 06B TSLU 1M20G	<b>1805930000</b>
M 25	带螺纹		52	HDC 06B TSLU 1M25G	<b>1788090000</b>
M 25	带螺纹		72	HDC 16D TSLU 1M25G	<b>1787480000</b>

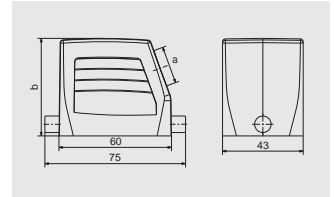

插头外壳, 顶部进线



a	描述	防尘盖	b (mm)	型号	订货号
M 20	带螺纹		52	HDC 06B TOLU 1M20G	<b>1788120000</b>
M 25	带螺纹		52	HDC 06B TOLU 1M25G	<b>1788110000</b>
M 25	带螺纹		72	HDC 16D TOLU 1M25G	<b>1787500000</b>
M 32	带螺纹		72	HDC 16D TOLU 1M32G	<b>1787490000</b>

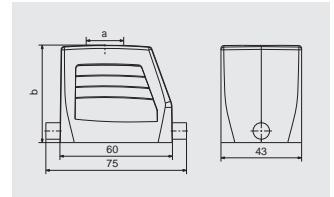

防尘盖



描述	型号	订货号
用于插头外壳	HDC 06B DMDL 1LB	<b>1665210000</b>

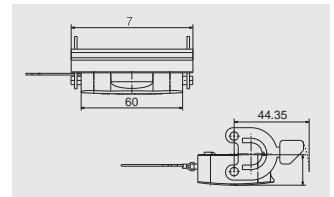

底座

穿体式插座外壳



描述	防尘盖	b (mm)	型号	订货号
		29	HDC 06B ALU	<b>1202100000</b>
	带	47	HDC 06B ADLU	<b>1202500000</b>

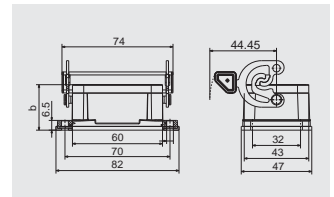

底座封闭式插座外壳



a	描述	防尘盖	b (mm)	型号	订货号
M 20	带螺纹		54	HDC 06B SLU 2M20G	<b>1788140000</b>
M 20	带螺纹	带	72	HDC 06B SDLU 2M20G	<b>1788170000</b>
M 25	带螺纹		54	HDC 06B SLU 2M25G	<b>1788130000</b>
M 25	带螺纹	带	72	HDC 06B SDLU 2M25G	<b>1788160000</b>

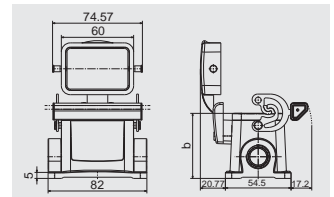

防尘盖



描述	型号	订货号
用于插座外壳	HDC 06B DODL 2BO	<b>1665200000</b>

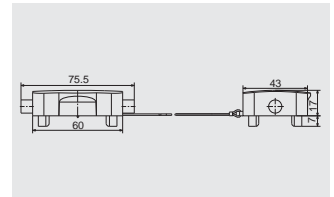

830 V, 80 A, 尺寸 6  
 400V, 16 A  
 4 + 0 + ⊕  
 4 + 2 + ⊕  
 插芯



同轴螺钉联接



插芯	型号	订货号
公	HDC S4 0 SAS	1789960000
母	HDC S4 0 BAS	1789970000

螺钉联接



插芯	型号	订货号
公	HDC S4/0 MS	1023220000
母	HDC S4/0 FS	1023210000

螺钉联接



插芯	型号	订货号
公	HDC S4/2 MS	1023240000
母	HDC S4/2 FS	1023230000

尺寸 - S4 0

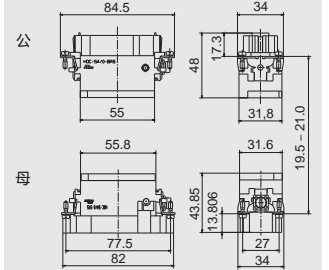

插针的排列

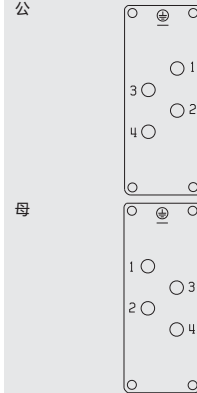

开孔尺寸 - S4/0, S4/2

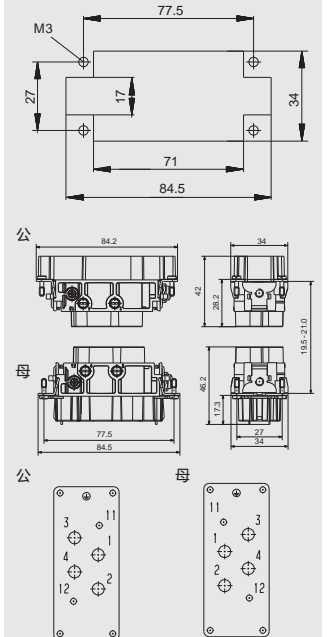

开孔尺寸

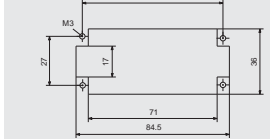

混合型插芯

RockStar® IP65/IP66外壳选择

尺寸6

\*更多外壳,请参阅D章节

插头外壳



插头外壳, 侧面进线



a	描述	防尘盖	b (mm)	型号	订货号
M 25	带螺纹		61	HDC 16B TSBU 1M25G	1788180000
M 25	带螺纹		76	HDC 40D TSBU 1M25G	1787010000
M 32	带螺纹		76	HDC 40D TSBU 1M32G	1787000000

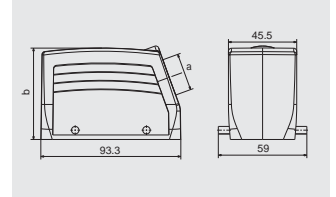

插头外壳, 顶部进线



a	描述	防尘盖	b (mm)	型号	订货号
M 25	带螺纹		61	HDC 16B TOBU 1M25G	1788210000
M 25	带螺纹		76	HDC 40D TOBU 1M25G	1787070000
M 32	带螺纹		76	HDC 40D TOBU 1M32G	1787060000

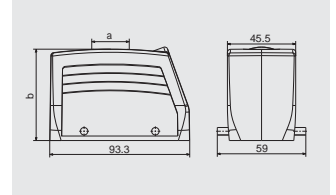

防尘盖



描述	型号	订货号
用于插头外壳	HDC 16B DMDQ 2QB	1665270000

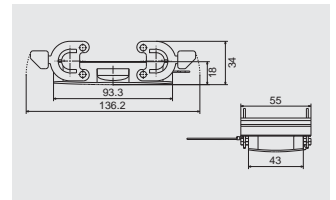

底座

穿体式插座外壳



描述	防尘盖	b (mm)	型号	订货号
		29	HDC 16B ABU	1208600000

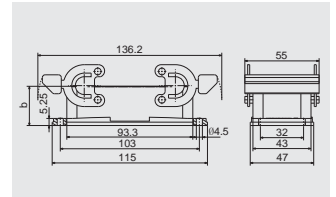

底座封闭型插座外壳



a	描述	防尘盖	b (mm)	型号	订货号
M 25	带螺纹		64	HDC 16B SBU 2M25G	1788240000
M 25	带螺纹		84	HDC 40D SBU 2M25G	1787120000
M 32	带螺纹		84	HDC 40D SBU 2M32G	1787110000

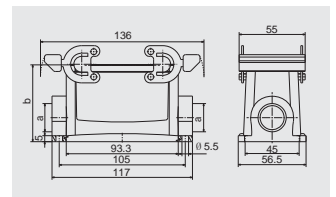

对接外壳



a	描述	防尘盖	b (mm)	型号	订货号
M 25	带螺纹		79	HDC 40D KBU 1M25G	1787200000
M 32	带螺纹		79	HDC 40D KBU 1M32G	1787190000

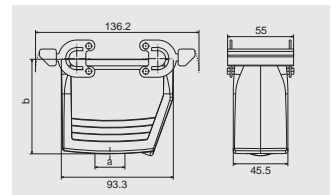

防尘盖



描述	型号	订货号
用于插座外壳	HDC 16B DODQ 4B0	1665260000

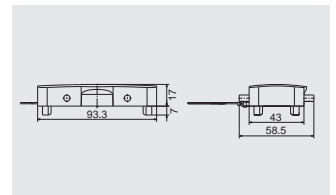

B

690 V, 48 A, 尺寸 6  
400V, 16 A  
6 + 12 + ⊕



插芯

同轴螺钉联接+螺钉联接



插芯	型号	订货号
公	HDC S6 12 SAS	1790000000
母	HDC S6 12 BAS	1790010000

尺寸

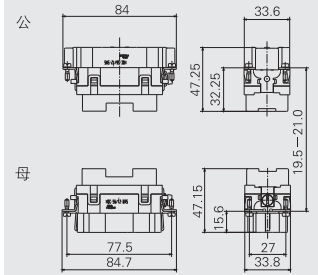

插针的排列

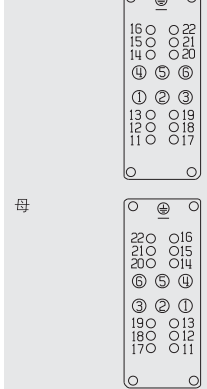

开孔尺寸

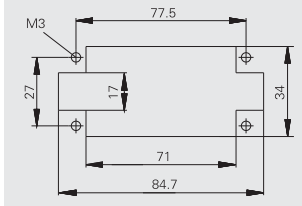

RockStar® 插芯

B

RockStar® IP65/IP66外壳选择

尺寸6

\*更多外壳,请参阅D章节

插头外壳



插头外壳, 侧面进线



a	描述	防尘盖	b (mm)	型号	订货号
M 25	带螺纹		61	HDC 16B TSBU 1M25G	<b>1788180000</b>
M 25	带螺纹		76	HDC 40D TSBU 1M25G	<b>1787010000</b>
M 32	带螺纹		76	HDC 40D TSBU 1M32G	<b>1787000000</b>

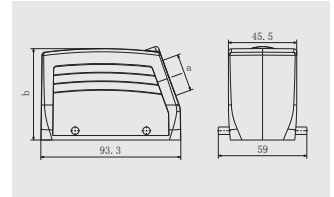

插头外壳, 顶部进线



a	描述	防尘盖	b (mm)	型号	订货号
M 25	带螺纹		61	HDC 16B TOBU 1M25G	<b>1788210000</b>
M 25	带螺纹		76	HDC 40D TOBU 1M25G	<b>1787070000</b>
M 32	带螺纹		76	HDC 40D TOBU 1M32G	<b>1787060000</b>

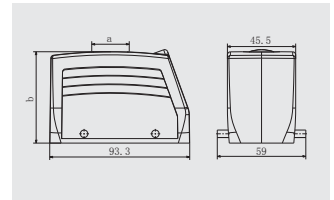

防尘盖



描述	型号	订货号
用于插头外壳	HDC 16B DMDQ 2QB	<b>1665270000</b>

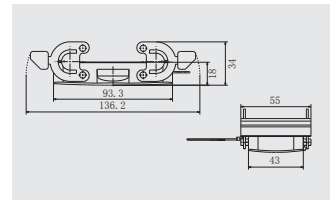

底座

穿体式插座外壳



描述	防尘盖	b (mm)	型号	订货号
		29	HDC 16B ABU	<b>1208600000</b>

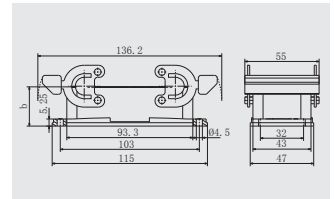

底座封闭式插座外壳



a	描述	防尘盖	b (mm)	型号	订货号
M 25	带螺纹		64	HDC 16B SBU 2M25G	<b>1788240000</b>
M 25	带螺纹		84	HDC 40D SBU 2M25G	<b>1787120000</b>
M 32	带螺纹		84	HDC 40D SBU 2M32G	<b>1787110000</b>

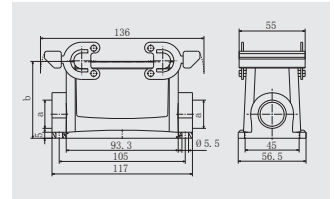

对接外壳



a	描述	防尘盖	b (mm)	型号	订货号
M 25	带螺纹		79	HDC 40D KBU 1M25G	<b>1787200000</b>
M 32	带螺纹		79	HDC 40D KBU 1M32G	<b>1787190000</b>

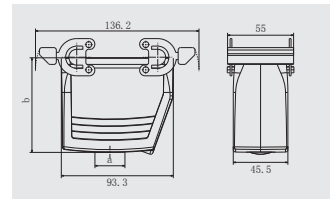

防尘盖



描述	型号	订货号
用于插座外壳	HDC 16B DODQ 4BO	<b>1665260000</b>

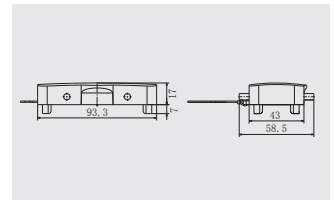

690 V, 100 A, 尺寸 8  
400V, 16 A  
6 + 6 + ⊕



插芯

同轴螺钉联接+螺钉联接



插芯	型号	订货号
公	HDC S6 6 SAS	1790030000
母	HDC S6 6 BAS	1790020000

尺寸

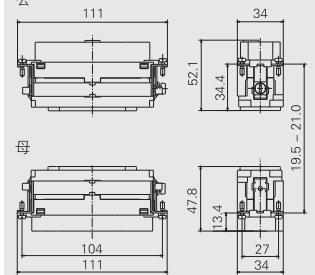

插针的排列

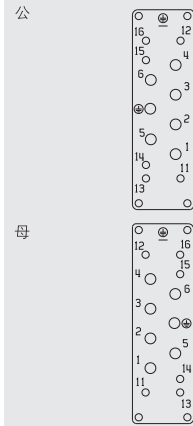

开孔尺寸

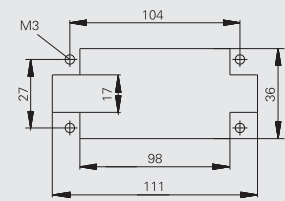

RockStar® 插芯

B

RockStar® IP65/IP66外壳选择

尺寸8

\*更多外壳,请参阅D章节

插头外壳



插头外壳, 侧面进线



a	描述	防尘盖	b (mm)	型号	订货号
M 25	带螺纹		61	HDC 24B TSBU 1M25G	<b>1787760000</b>
M 32	带螺纹		61	HDC 24B TSBU 1M32G	<b>1787750000</b>
M 25	带螺纹		76	HDC 64D TSBU 1M25G	<b>1786780000</b>
M 32	带螺纹		76	HDC 64D TSBU 1M32G	<b>1786770000</b>

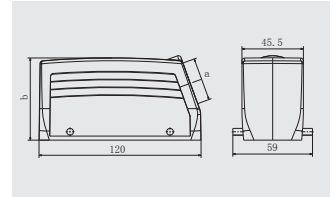

插头外壳, 顶部进线



a	描述	防尘盖	b (mm)	型号	订货号
M 25	带螺纹		61	HDC 24B TOBU 1M25G	<b>1787820000</b>
M 32	带螺纹		61	HDC 24B TOBU 1M32G	<b>1787810000</b>
M 32	带螺纹		76	HDC 64D TOBU 1M32G	<b>1786830000</b>

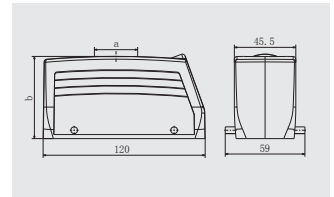

防尘盖



描述	型号	订货号
用于插头外壳	HDC 24B DMDQ 2QB	<b>1665640000</b>

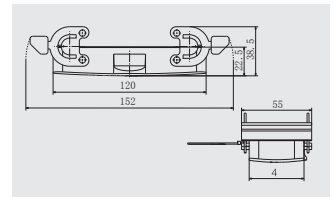

底座

穿体式插座外壳



描述	防尘盖	b (mm)	型号	订货号
		29.3	HDC 24B ABU	<b>1212400000</b>

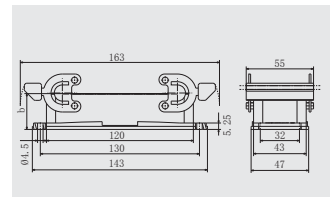

底座封闭式插座外壳



a	描述	防尘盖	b (mm)	型号	订货号
M 25	带螺纹		64	HDC 24B SBU 2M25G	<b>1787870000</b>
M 25	带螺纹		84	HDC 64D SBU 2M25G	<b>1786890000</b>
M 32	带螺纹		84	HDC 64D SBU 2M32G	<b>1786880000</b>

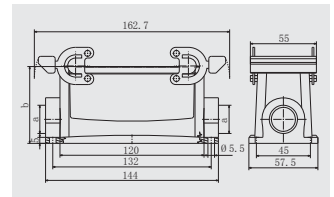

对接外壳



a	描述	防尘盖	b (mm)	型号	订货号
M 25	带螺纹		65	HDC 24B KBU 1M25G	<b>1787920000</b>
M 32	带螺纹		79	HDC 64D KBU 1M32G	<b>1786960000</b>

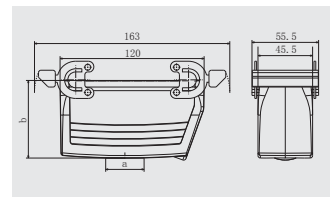

防尘盖



描述	型号	订货号
用于插座外壳	HDC 24B DODQ 4BO	<b>1665630000</b>

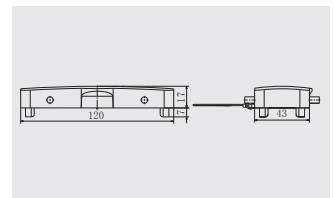

400 V, 16 A, 尺寸 4  
160 V, 10 A  
8 + 24 + ⊕



插芯

冷压联接



插芯	型号	订货号
母	HDC S8/24 FC	1023270000
公	HDC S8/24 MC	1023290000

尺寸

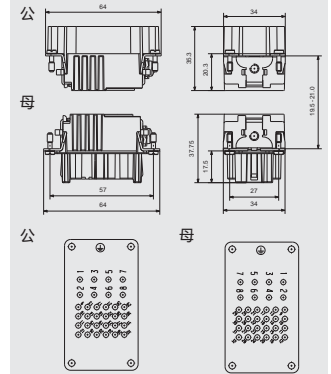

零配件

冷压插件

表面镀银



表面镀金



数量	公	订货号	母	订货号
100	HDC-C-HE-SM0.5AG	1200500000	HDC-C-HE-BM0.5AG	1201100000
100	HDC-C-HE-SM0.75-1AG	1200600000	HDC-C-HE-BM0.75-1AG	1201200000
100	HDC-C-HE-SM1.5AG	1200700000	HDC-C-HE-BM1.5AG	1201300000
100	HDC-C-HE-SM2.5AG	1200800000	HDC-C-HE-BM2.5AG	1201400000
100	HDC-C-HE-SM4.0AG	1200900000	HDC-C-HE-BM4.0AG	1201500000
100	HDC-C-HE-SM0.5AU	1651420000	HDC-C-HE-BM0.5AU	1651470000
100	HDC-C-HE-SM0.75-1AU	1651430000	HDC-C-HE-BM0.75-1AU	1651480000
100	HDC-C-HE-SM1.5AU	1651440000	HDC-C-HE-BM1.5AU	1651490000
100	HDC-C-HE-SM2.5AU	1651450000	HDC-C-HE-BM2.5AU	1651500000
100	HDC-C-HE-SM4.0AU	1651460000	HDC-C-HE-BM4.0AU	1651510000

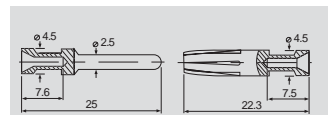

导线截面积	AWG导线	剥线长度
0.50 mm <sup>2</sup>	AWG 20	7.5 mm
0.75 - 1.00 mm <sup>2</sup>	AWG 18	7.5 mm
1.50 mm <sup>2</sup>	AWG 16	7.5 mm
2.50 mm <sup>2</sup>	AWG 14	7.5 mm
4.00 mm <sup>2</sup>	AWG 12	7.5 mm

工具



压针工具	订货号
CTX CM 1.6/2.5	9018490000
退针工具	订货号
退针工具 HE	1866750000

冷压插件

表面镀银



表面镀金



数量	母	订货号	公	订货号
100	HDC-C-HD-SM0.14-0.37AG	1651520000	HDC-C-HD-BM0.14-0.37AG	1651570000
100	HDC-C-HD-SM0.5AG	1651530000	HDC-C-HD-BM0.5AG	1651580000
100	HDC-C-HD-SM0.75-1AG	1601750000	HDC-C-HD-BM0.75-1AG	1601760000
100	HDC-C-HD-SM1.5AG	1651550000	HDC-C-HD-BM1.5AG	1651600000
100	HDC-C-HD-SM2.5AG	1651560000	HDC-C-HD-BM2.5AG	1651610000
100	HDC-C-HD-SM0.14-0.37AU	1651620000	HDC-C-HD-BM0.14-0.37AU	1651670000
100	HDC-C-HD-SM0.5AU	1651630000	HDC-C-HD-BM0.5AU	1651680000
100	HDC-C-HD-SM0.75-1AU	1651640000	HDC-C-HD-BM0.75-1AU	1651690000
100	HDC-C-HD-SM1.5AU	1651650000	HDC-C-HD-BM1.5AU	1651700000
100	HDC-C-HD-SM2.5AU	1651660000	HDC-C-HD-BM2.5AU	1651710000

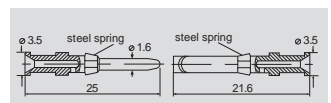

导线截面积	AWG导线	剥线长度
0.14 - 0.37 mm <sup>2</sup>	AWG 26 - 22	8 mm
0.50 mm <sup>2</sup>	AWG 20	8 mm
0.75 - 1.00 mm <sup>2</sup>	AWG 18	8 mm
1.50 mm <sup>2</sup>	AWG 16	8 mm
2.50 mm <sup>2</sup>	AWG 14	6 mm

工具



压针工具	订货号
CTX CM 1.6/2.5	9018490000
CTIN CM 1.6/2.5	9205430000
退针工具	订货号
退针工具HD	1866730000



RockStar® IP65/IP66外壳选择

尺寸4

\*更多外壳,请参阅D章节



插头外壳

插头外壳, 侧面进线



a	描述	防尘盖	b (mm)	型号	订货号
M 20	带螺纹		52	HDC 10B TSBU 1M20G	<b>1787560000</b>
M 25	带螺纹		52	HDC 10B TSBU 1M25G	<b>1787550000</b>
M 25	带螺纹		72	HDC 24D TSBU 1M25G	<b>1787240000</b>
M 32	带螺纹		72	HDC 24D TSBU 1M32G	<b>1787230000</b>

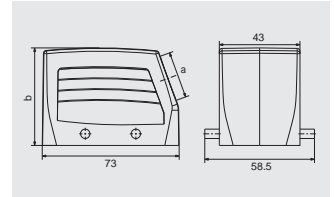

插头外壳, 顶部进线



a	描述	防尘盖	b (mm)	型号	订货号
M 20	带螺纹		52	HDC 10B TOBU 1M20G	<b>1787600000</b>
M 25	带螺纹		52	HDC 10B TOBU 1M25G	<b>1787590000</b>
M 25	带螺纹		72	HDC 24D TOBU 1M25G	<b>1787300000</b>
M 32	带螺纹		72	HDC 24D TOBU 1M32G	<b>1787290000</b>

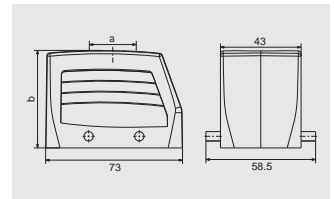

防尘盖



描述	型号	订货号
用于插头外壳	HDC 10B DMDQ 2QB	<b>1665240000</b>

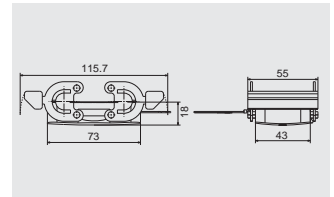

底座

穿体式插座外壳



描述	防尘盖	b (mm)	型号	订货号
		29.3	HDC 10B ABU	<b>1205000000</b>

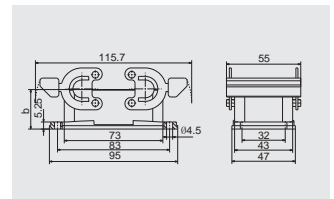

底座封闭式插座外壳



a	描述	防尘盖	b (mm)	型号	订货号
M 20	带螺纹		57	HDC 10B SBU 2M20G	<b>1787640000</b>
M 25	带螺纹		57	HDC 10B SBU 2M25G	<b>1787630000</b>
M 25	带螺纹		74	HDC 24D SBU 2M25G	<b>1787350000</b>
M 32	带螺纹		74	HDC 24D SBU 2M32G	<b>1787360000</b>

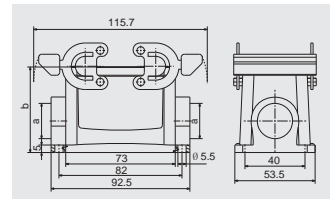

对接外壳



a	描述	防尘盖	b (mm)	型号	订货号
M 20	带螺纹		55	HDC 10B KBU 1M20G	<b>1787720000</b>

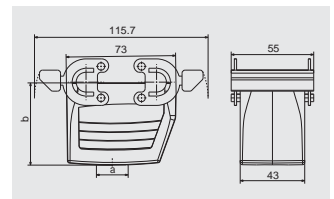

防尘盖



描述	型号	订货号
用于插座外壳	HDC 10B DODQ 4B0	<b>1665230000</b>

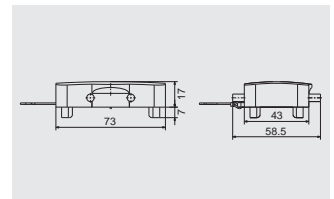

690 V, 40 A, 尺寸 6  
160 V, 10 A  
6 + 36 + ⊕



插芯

冷压联接



插芯	型号	订货号
母	HDC S6/36 FC	1023310000
公	HDC S6/36 MC	1023320000

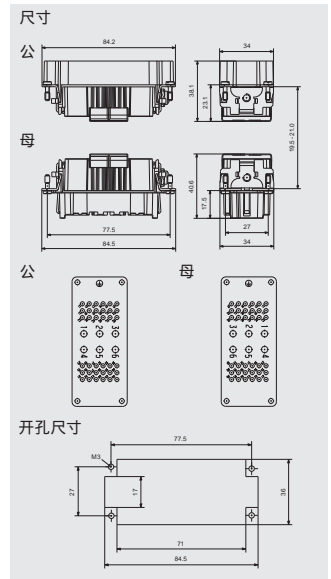

零配件

冷压插件

表面镀银



数量	母	订货号	公	订货号
25	HDC C HX SM1.5AG	1002910000	HDC C HX BM1.5AG	1002950000
25	HDC C HX SM2.5AG	1002920000	HDC C HX BM2.5AG	1002960000
25	HDC C HX SM4.0AG	1002930000	HDC C HX BM4.0AG	1002970000
25	HDC C HX SM6.0AG	1002940000	HDC C HX BM6.0AG	1002980000

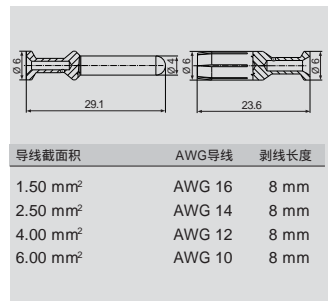

工具



压针工具	订货号
CTIN CM 1.6/2.5	9205430000
退针工具	订货号
退针工具 HX	1002990000

冷压插件

表面镀银



数量	母	订货号	公	订货号
100	HDC-C-HD-SM0.14-0.37AG	1651520000	HDC-C-HD-BM0.14-0.37AG	1651570000
100	HDC-C-HD-SM0.5AG	1651530000	HDC-C-HD-BM0.5AG	1651580000
100	HDC-C-HD-SM0.75-1AG	1601750000	HDC-C-HD-BM0.75-1AG	1601760000
100	HDC-C-HD-SM1.5AG	1651550000	HDC-C-HD-BM1.5AG	1651600000
100	HDC-C-HD-SM2.5AG	1651560000	HDC-C-HD-BM2.5AG	1651610000

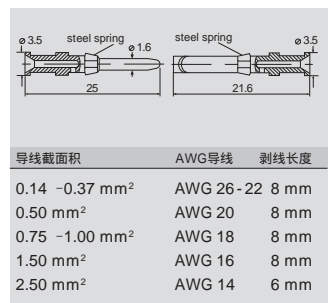

表面镀金



压针工具	订货号
CTX CM 1.6/2.5	9018490000
CTIN CM 1.6/2.5	9205430000
退针工具	订货号
退针工具HD	1866730000

工具



RockStar® IP65/IP66外壳选择

尺寸6

\*更多外壳,请参阅D章节

插头外壳



插头外壳, 侧面进线



a	描述	防尘盖	b (mm)	型号	订货号
M 25	带螺纹		61	HDC 16B TSBU 1M25G	<b>1788180000</b>
M 25	带螺纹		76	HDC 40D TSBU 1M25G	<b>1787010000</b>
M 32	带螺纹		76	HDC 40D TSBU 1M32G	<b>1787000000</b>

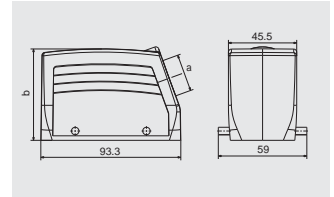

插头外壳, 顶部进线



a	描述	防尘盖	b (mm)	型号	订货号
M 25	带螺纹		61	HDC 16B TOBU 1M25G	<b>1788210000</b>
M 25	带螺纹		76	HDC 40D TOBU 1M25G	<b>1787070000</b>
M 32	带螺纹		76	HDC 40D TOBU 1M32G	<b>1787060000</b>

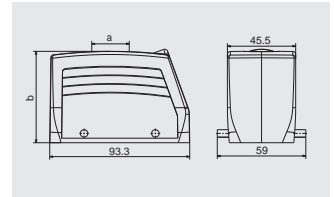

防尘盖



描述	型号	订货号
用于插头外壳	HDC 16B DMDQ 2QB	<b>1665270000</b>

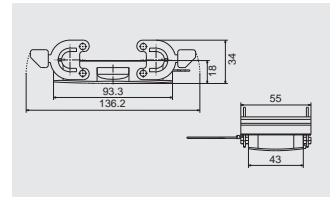

底座

穿体式插座外壳



描述	防尘盖	b (mm)	型号	订货号
		29	HDC 16B ABU	<b>1208600000</b>

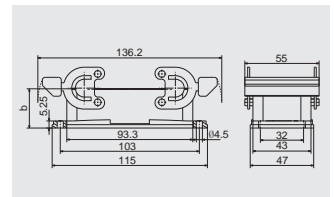

底座封闭型插座外壳



a	描述	防尘盖	b (mm)	型号	订货号
M 25	带螺纹		64	HDC 16B SBU 2M25G	<b>1788240000</b>
M 25	带螺纹		84	HDC 40D SBU 2M25G	<b>1787120000</b>
M 32	带螺纹		84	HDC 40D SBU 2M32G	<b>1787110000</b>

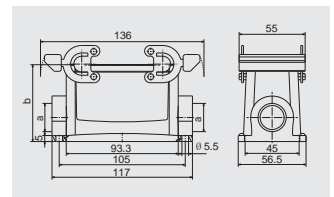

对接外壳



a	描述	防尘盖	b (mm)	型号	订货号
M 25	带螺纹		79	HDC 40D KBU 1M25G	<b>1787200000</b>
M 32	带螺纹		79	HDC 40D KBU 1M32G	<b>1787190000</b>

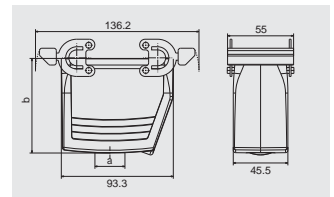

防尘盖



描述	型号	订货号
用于插座外壳	HDC 16B DODQ 4B0	<b>1665260000</b>

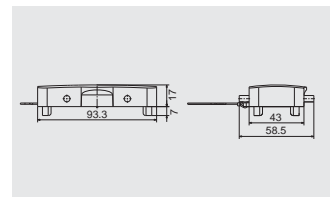

690 V, 40 A, 尺寸 6  
250 V, 10 A  
12 + 2 + ⊕



插芯

冷压联接



插芯	型号	订货号
母	HDC S12/2 FC	1023330000
公	HDC S12/2 MC	1023340000

尺寸

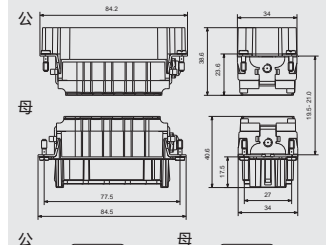

开孔尺寸

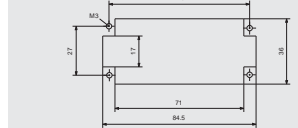

零配件

冷压插件

表面镀银



数量	母	订货号	公	订货号
25	HDC C HX SM1.5AG	1002910000	HDC C HX BM1.5AG	1002950000
25	HDC C HX SM2.5AG	1002920000	HDC C HX BM2.5AG	1002960000
25	HDC C HX SM4.0AG	1002930000	HDC C HX BM4.0AG	1002970000
25	HDC C HX SM6.0AG	1002940000	HDC C HX BM6.0AG	1002980000

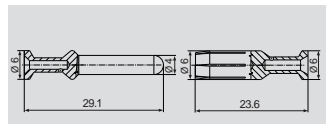

导线截面积	AWG导线	剥线长度
1.50 mm <sup>2</sup>	AWG 16	8 mm
2.50 mm <sup>2</sup>	AWG 14	8 mm
4.00 mm <sup>2</sup>	AWG 12	8 mm
6.00 mm <sup>2</sup>	AWG 10	8 mm

工具



压针工具	订货号
CTIN CM 1.6/2.5	9205430000
退针工具	订货号
退针工具 HX	1002990000

冷压插件

表面镀银



数量	母	订货号	公	订货号
100	HDC-C-HD-SM0.14-0.37AG	1651520000	HDC-C-HD-BM0.14-0.37AG	1651570000
100	HDC-C-HD-SM0.5AG	1651530000	HDC-C-HD-BM0.5AG	1651580000
100	HDC-C-HD-SM0.75-1AG	1601750000	HDC-C-HD-BM0.75-1AG	1601760000
100	HDC-C-HD-SM1.5AG	1651550000	HDC-C-HD-BM1.5AG	1651600000
100	HDC-C-HD-SM2.5AG	1651560000	HDC-C-HD-BM2.5AG	1651610000

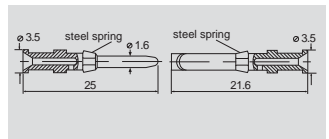

导线截面积	AWG导线	剥线长度
0.14 - 0.37 mm <sup>2</sup>	AWG 26 - 22	8 mm
0.50 mm <sup>2</sup>	AWG 20	8 mm
0.75 - 1.00 mm <sup>2</sup>	AWG 18	8 mm
1.50 mm <sup>2</sup>	AWG 16	8 mm
2.50 mm <sup>2</sup>	AWG 14	6 mm

表面镀金



数量	母	订货号	公	订货号
100	HDC-C-HD-SM0.14-0.37AU	1651620000	HDC-C-HD-BM0.14-0.37AU	1651670000
100	HDC-C-HD-SM0.5AU	1651630000	HDC-C-HD-BM0.5AU	1651680000
100	HDC-C-HD-SM0.75-1AU	1651640000	HDC-C-HD-BM0.75-1AU	1651690000
100	HDC-C-HD-SM1.5AU	1651650000	HDC-C-HD-BM1.5AU	1651700000
100	HDC-C-HD-SM2.5AU	1651660000	HDC-C-HD-BM2.5AU	1651710000

工具



压针工具	订货号
CTX CM 1.6/2.5	9018490000
CTIN CM 1.6/2.5	9205430000
退针工具	订货号
退针工具HD	1866730000

## RockStar® IP65/IP66外壳选择

### 尺寸6

\*更多外壳,请参阅D章节

#### 插头外壳



##### 插头外壳, 侧面进线



a	描述	防尘盖	b (mm)	型号	订货号
M 25	带螺纹		61	HDC 16B TSBU 1M25G	<b>1788180000</b>
M 25	带螺纹		76	HDC 40D TSBU 1M25G	<b>1787010000</b>
M 32	带螺纹		76	HDC 40D TSBU 1M32G	<b>1787000000</b>

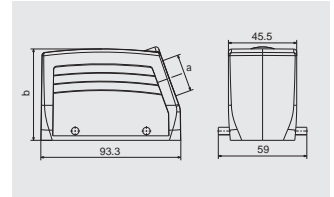

##### 插头外壳, 顶部进线



a	描述	防尘盖	b (mm)	型号	订货号
M 25	带螺纹		61	HDC 16B TOBU 1M25G	<b>1788210000</b>
M 25	带螺纹		76	HDC 40D TOBU 1M25G	<b>1787070000</b>
M 32	带螺纹		76	HDC 40D TOBU 1M32G	<b>1787060000</b>

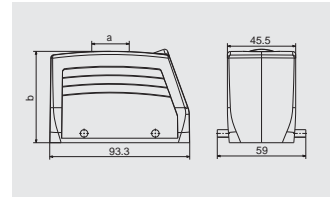

##### 防尘盖



描述	型号	订货号
用于插头外壳	HDC 16B DMDQ 2QB	<b>1665270000</b>

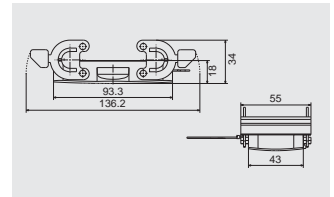

#### 底座

##### 穿体式插座外壳



描述	防尘盖	b (mm)	型号	订货号
		29	HDC 16B ABU	<b>1208600000</b>

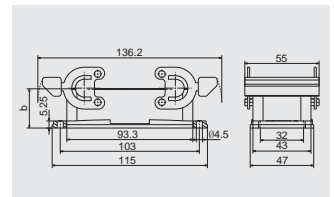

##### 底座封闭式插座外壳



a	描述	防尘盖	b (mm)	型号	订货号
M 25	带螺纹		64	HDC 16B SBU 2M25G	<b>1788240000</b>
M 25	带螺纹		84	HDC 40D SBU 2M25G	<b>1787120000</b>
M 32	带螺纹		84	HDC 40D SBU 2M32G	<b>1787110000</b>

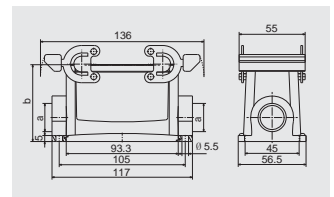

##### 对接外壳



a	描述	防尘盖	b (mm)	型号	订货号
M 25	带螺纹		79	HDC 40D KBU 1M25G	<b>1787200000</b>
M 32	带螺纹		79	HDC 40D KBU 1M32G	<b>1787190000</b>

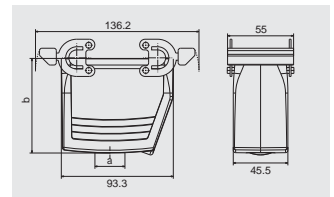

##### 防尘盖



描述	型号	订货号
用于插座外壳	HDC 16B DODQ 4B0	<b>1665260000</b>

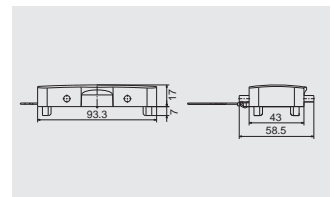

400 V, 80 A, 尺寸 8  
400 V, 16 A  
4 + 8 + ⊕



插芯

螺钉联接



插芯	型号	订货号
公	HDC S4/8 MS	1023260000
母	HDC S4/8 FS	1023250000

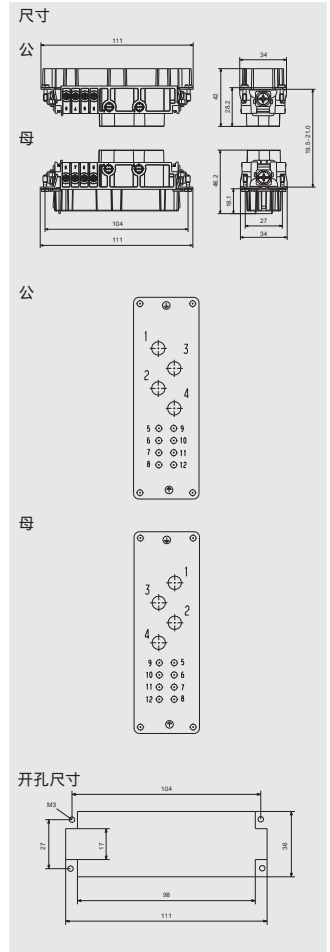

RockStar® 插芯

B

RockStar® IP65/IP66外壳选择

尺寸8

\*更多外壳,请参阅D章节

插头外壳



插头外壳, 侧面进线



a	描述	防尘盖	b (mm)	型号	订货号
M 25	带螺纹		61	HDC 24B TSBU 1M25G	<b>1787760000</b>
M 32	带螺纹		61	HDC 24B TSBU 1M32G	<b>1787750000</b>
M 25	带螺纹		76	HDC 64D TSBU 1M25G	<b>1786780000</b>
M 32	带螺纹		76	HDC 64D TSBU 1M32G	<b>1786770000</b>

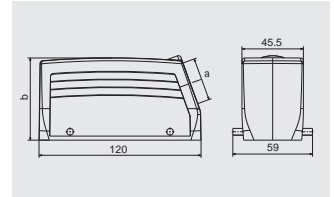

插头外壳, 顶部进线



a	描述	防尘盖	b (mm)	型号	订货号
M 25	带螺纹		61	HDC 24B TOBU 1M25G	<b>1787820000</b>
M 32	带螺纹		61	HDC 24B TOBU 1M32G	<b>1787810000</b>
M 32	带螺纹		76	HDC 64D TOBU 1M32G	<b>1786830000</b>

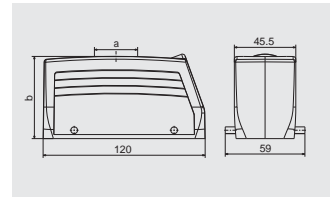

防尘盖



描述	型号	订货号
用于插头外壳	HDC 24B DMDQ 2QB	<b>1665640000</b>

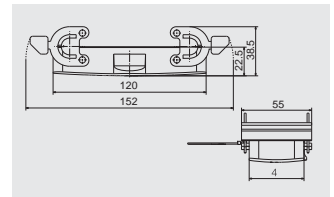

底座

穿体式插座外壳



描述	防尘盖	b (mm)	型号	订货号
		29.3	HDC 24B ABU	<b>1212400000</b>

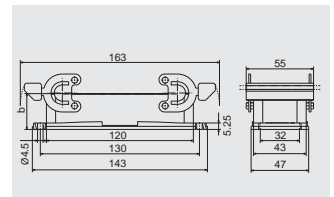

底座封闭式插座外壳



a	描述	防尘盖	b (mm)	型号	订货号
M 25	带螺纹		64	HDC 24B SBU 2M25G	<b>1787870000</b>
M 25	带螺纹		84	HDC 64D SBU 2M25G	<b>1786890000</b>
M 32	带螺纹		84	HDC 64D SBU 2M32G	<b>1786880000</b>

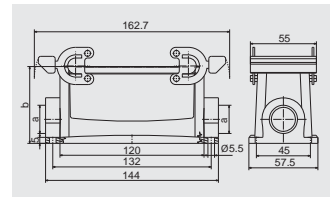

对接外壳



a	描述	防尘盖	b (mm)	型号	订货号
M 25	带螺纹		65	HDC 24B KBU 1M25G	<b>1787920000</b>
M 32	带螺纹		79	HDC 64D KBU 1M32G	<b>1786960000</b>

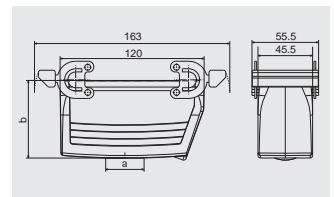

防尘盖



描述	型号	订货号
用于插座外壳	HDC 24B DODQ 4B0	<b>1665630000</b>

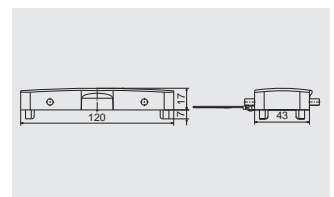

690 V, 100 A, 尺寸 8

8 + 0 + ⊕

插芯



同轴螺钉联接



插芯	型号	订货号
公	HDC S8/0 MAS	1023360000
母	HDC S8/0 FAS	1023350000

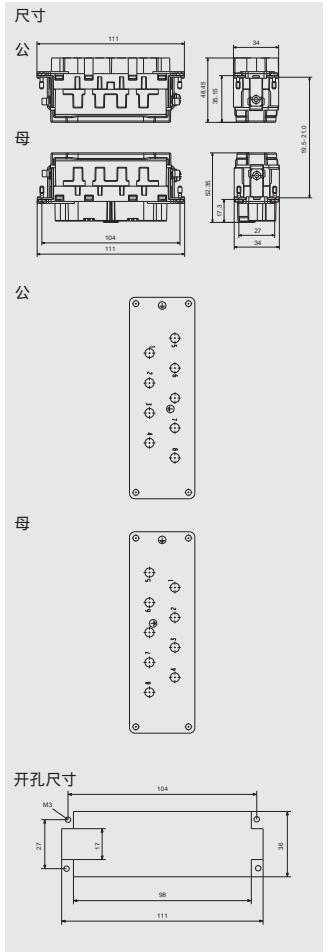

RockStar® 插芯

B



RockStar® IP65/IP66外壳选择

尺寸8

\*更多外壳,请参阅D章节

插头外壳



插头外壳, 侧面进线



a	描述	防尘盖	b (mm)	型号	订货号
M 25	带螺纹		61	HDC 24B TSBU 1M25G	<b>1787760000</b>
M 32	带螺纹		61	HDC 24B TSBU 1M32G	<b>1787750000</b>
M 25	带螺纹		76	HDC 64D TSBU 1M25G	<b>1786780000</b>
M 32	带螺纹		76	HDC 64D TSBU 1M32G	<b>1786770000</b>

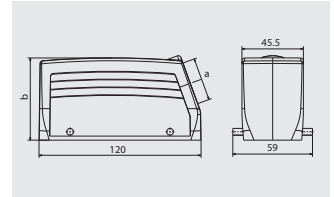

插头外壳, 顶部进线



a	描述	防尘盖	b (mm)	型号	订货号
M 25	带螺纹		61	HDC 24B TOBU 1M25G	<b>1787820000</b>
M 32	带螺纹		61	HDC 24B TOBU 1M32G	<b>1787810000</b>
M 32	带螺纹		76	HDC 64D TOBU 1M32G	<b>1786830000</b>

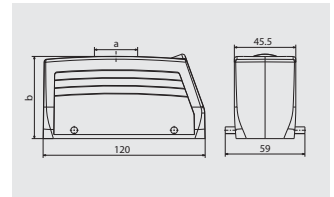

防尘盖



描述	型号	订货号
用于插头外壳	HDC 24B DMDQ 2QB	<b>1665640000</b>

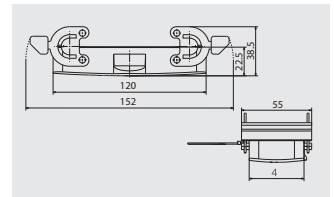

底座

穿体式插座外壳



描述	防尘盖	b (mm)	型号	订货号
		29.3	HDC 24B ABU	<b>1212400000</b>

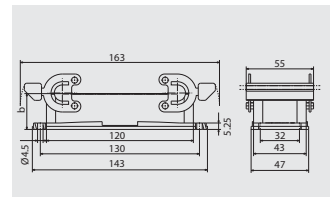

底座封闭式插座外壳



a	描述	防尘盖	b (mm)	型号	订货号
M 25	带螺纹		64	HDC 24B SBU 2M25G	<b>1787870000</b>
M 25	带螺纹		84	HDC 64D SBU 2M25G	<b>1786890000</b>
M 32	带螺纹		84	HDC 64D SBU 2M32G	<b>1786880000</b>

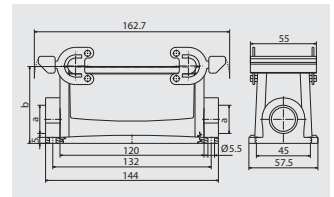

对接外壳



a	描述	防尘盖	b (mm)	型号	订货号
M 25	带螺纹		65	HDC 24B KBU 1M25G	<b>1787920000</b>
M 32	带螺纹		79	HDC 64D KBU 1M32G	<b>1786960000</b>

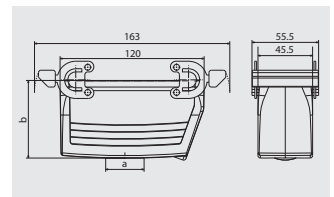

防尘盖



描述	型号	订货号
用于插座外壳	HDC 24B DODQ 4BO	<b>1665630000</b>

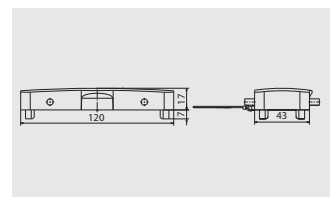

# HQ 高能小插芯

尺寸紧凑,能量传输大,使用HE/HD/HX冷压插针



## 技术参数

	HQ 5	HQ 7	HQ 8	HQ 4 2	HQ 17
<b>标准/认证</b>					
标准	DIN EN 61984 DIN EN 60664-1	DIN EN 61984 DIN EN 60664-1	DIN EN 61984 DIN EN 60664-1	DIN EN 61984 DIN EN 60664-1	DIN EN 61984 DIN EN 60664-1
认证	UL/CSA/DESINA 23570	UL/CSA/DESINA 23570	UL/CSA/DESINA 23570	UL/CSA/DESINA 23570	UL/CSA/DESINA 23570
<b>插芯</b>					
插针数	5 + PE	7 + PE	8 + PE	4 根电源线, 2 根信号线 + PE	17 + PE
<b>联接系统</b>	冷压联接, HE 插针	冷压联接, HD 插针	冷压联接, HE 插针	冷压联接, HX/HD 插针	冷压联接, HD 插针
额定电压	400 V	400 V	500 V	690 V, 250 V	250 V
UL/CSA额定电压	600 V	600 V	600 V	600 V	600 V
额定电流	16 A	10 A	16 A	40/10 A	10 A
额定脉冲电压	4 kV	6 kV	6 kV	6 kV/4 kV	4 kV
污染等级	3	3	3	3	2
绝缘阻抗	$\geq 10^{10} \Omega$	$\geq 10^{10} \Omega$	$\geq 10^{10} \Omega$	$\geq 10^{10} \Omega$	$\geq 10^{10} \Omega$
材料	玻璃纤维增强型PC	玻璃纤维增强型PC	玻璃纤维增强型PC	玻璃纤维增强型PC	玻璃纤维增强型PC
温度范围	-40 ...+125	-40 ...+125	-40 ...+125	-40 ...+125	-40 ...+125
UL 94阻燃等级	V-0	V-0	V-0	V-0	V-0
<b>机械寿命</b>					
插孔银表面	$\geq 500$	$\geq 500$	$\geq 500$	$\geq 500$	$\geq 500$
插孔金表面	$\geq 500$	$\geq 500$	$\geq 500$	$\geq 500$	$\geq 500$
接触阻抗	$\leq 1.5 m\Omega$	$\leq 1.5 m\Omega$	$\leq 1.5 m\Omega$	$\leq 5 m\Omega$	$\leq 5 m\Omega$
<b>插针 / 材料</b>					
插针材料	铜合金	铜合金	铜合金	铜合金	铜合金
表面	惰性银	惰性银/金	惰性银	惰性银/金	惰性银/金
<b>冷压连接</b>					
电源线	0.5...4 mm <sup>2</sup> (AWG 20...12)		0.5...4 mm <sup>2</sup> (AWG 20...12)	1.5...6 mm <sup>2</sup> (AWG 16...10)	
信号线		0.14...2.5 mm <sup>2</sup> (AWG 26...14)		0.14...2.5 mm <sup>2</sup> (AWG 26...14)	0.14...2.5 mm <sup>2</sup> (AWG 26...14)
剥线长度	7.5 mm	8.0 mm	7.5 mm	10 mm/8 mm	8.0 mm
<b>接地</b>			冷压插针	冷压插针	冷压插针
接线范围	0.5...2.5 mm <sup>2</sup>	0.14...2.5 mm <sup>2</sup>	0.5...2.5 mm <sup>2</sup>	1.5...6 mm <sup>2</sup>	0.14...2.5 mm <sup>2</sup>
固定/牵引	0.5...2.5 mm <sup>2</sup> /0.5...2.5 mm <sup>2</sup>	0.14...2.5 mm <sup>2</sup>	0.5...2.5 mm <sup>2</sup> /0.5...2.5 mm <sup>2</sup>		
软导线/带端头软导线	0.5...2.5 mm <sup>2</sup> /0.5...2.5 mm <sup>2</sup>	0.14...2.5 mm <sup>2</sup>	0.5...2.5 mm <sup>2</sup> /0.5...2.5 mm <sup>2</sup>		
AWG 导线	AWG 20...14	AWG 26...14	AWG 20...14	AWG 16...10	AWG 26...14
剥线长度	10 mm	5 mm	10 mm	8 mm	8 mm
拧紧转矩	0.5...0.55 Nm	0.5...0.55 Nm	0.5...0.55 Nm		
螺丝刀尺寸	SD 0.8 x 4 mm 或者 PH1	SD 0.8 x 4 mm 或者 PH1	SD 0.8 x 4 mm 或者 PH1		
<b>附件与工具</b>					
压针工具	9205430000 CTIN CM 1.6/2.5 9018490000 CTX CM 1.6/2.5	9205430000 CTIN CM 1.6/2.5 9018490000 CTX CM 1.6/2.5 9010950000 HTX HDC/POF	9205430000 CTIN CM 1.6/2.5 9018490000 CTX CM 1.6/2.5	9205430000 CTIN CM 1.6/2.5 9018490000 CTX CM 3.6 9018490000 CTX CM 1.6/2.5 9010950000 HTX HDC/POF	9205430000 CTIN CM 1.6/2.5 9018490000 CTX CM 1.6/2.5 9010950000 HTX HDC/POF
螺丝刀			十字螺丝刀 一字螺丝刀 ISO 7049-ST 2.9x9.5-F-H	十字螺丝刀 一字螺丝刀 ISO 7049-ST 2.9x9.5-F-H	十字螺丝刀 一字螺丝刀 ISO 7049-ST 2.9x9.5-F-H
退针工具	1866750000 退针工具HE	1866730000 退针工具 HD 1688220000 HDC DW M 10 用于光纤连接	1866750000 退针工具HE	1002990000 退针工具 HX 1866730000 退针工具 HD 1688220000 HDC DW M 10 用于光纤连接	1002990000 退针工具 HX 1866730000 退针工具 HD 1688220000 HDC DW M 10 用于光纤连接

总揽

	尺寸	额定电压	额定电流	插针数	弹片连接	螺钉连接	冷压连接	直插式连接	同扁连接	页码
	1	400 V	16 A	5 + ⊕			•			B.119
	1	400 V	10 A	7 + ⊕			•			B.120
	HQ	500 V	16 A	8 + ⊕			•			B.122
	HQ	250 V	10 A	17+ ⊕			•			B.124
	HQ	690/250 V	40/10 A	4/2 + ⊕			•			B.126

技术参数

电流曲线

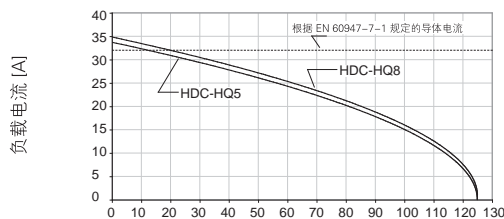

HDC-HQ5 和 HDC-HQ8 / H07V-K4.0 环境温度 [C]

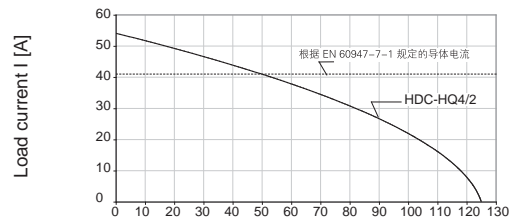

HDC-HQ4/2 / H07V-K6.0 环境温度 [C]

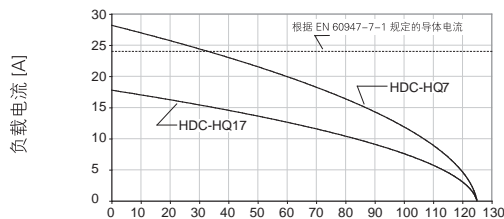

HDC-HQ7 and HDC-HQ17 / H07V-K2.5 环境温度 [C]

400 V, 16 A, 尺寸 1

5 + ⊕

插芯



冷压联接



插芯	描述	订货号
公	HDC HQ 5 MC	<b>1912440000</b>
母	HDC HQ 5 FC	<b>1912460000</b>

尺寸

公

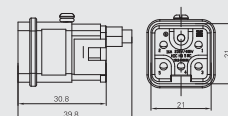

母

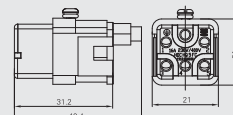

零配件

冷压插件

表面镀银



表面镀金



数量	公	订货号	母	订货号
100	HDC - C - HE - SM0.5AG	<b>1200500000</b>	HDC - C - HE - BM0.5AG	<b>1201100000</b>
100	HDC - C - HE - SM0.75 - 1AG	<b>1200600000</b>	HDC - C - HE - BM0.75 - 1AG	<b>1201200000</b>
100	HDC - C - HE - SM1.5AG	<b>1200700000</b>	HDC - C - HE - BM1.5AG	<b>1201300000</b>
100	HDC - C - HE - SM2.5AG	<b>1200800000</b>	HDC - C - HE - BM2.5AG	<b>1201400000</b>
100	HDC - C - HE - SM4.0AG	<b>1200900000</b>	HDC - C - HE - BM4.0AG	<b>1201500000</b>
100	HDC - C - HE - SM0.5AU	<b>1651420000</b>	HDC - C - HE - BM0.5AU	<b>1651470000</b>
100	HDC - C - HE - SM0.75 - 1AU	<b>1651430000</b>	HDC - C - HE - BM0.75 - 1AU	<b>1651480000</b>
100	HDC - C - HE - SM1.5AU	<b>1651440000</b>	HDC - C - HE - BM1.5AU	<b>1651490000</b>
100	HDC - C - HE - SM2.5AU	<b>1651450000</b>	HDC - C - HE - BM2.5AU	<b>1651500000</b>
100	HDC - C - HE - SM4.0AU	<b>1651460000</b>	HDC - C - HE - BM4.0AU	<b>1651510000</b>

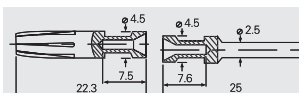

导线截面积	AWG 导线	剥线长度
0.50mm <sup>2</sup>	20	7.5mm
0.75 - 1.00mm <sup>2</sup>	18	7.5mm
1.50mm <sup>2</sup>	16	7.5mm
2.50mm <sup>2</sup>	14	7.5mm
4.00mm <sup>2</sup>	12	7.5mm

编码针



数量	订货号
100	HDC HE CP

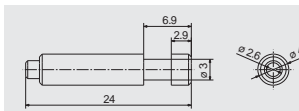

工具



压针工具	订货号
CTX CM 1.6/2.5	<b>9018490000</b>
退针工具	订货号
退针工具 HE	<b>1866750000</b>

400 V, 10 A, 尺寸1



插芯

冷压联接



插芯	描述	订货号
公	HDC HQ 7 MC	<b>1003190000</b>
母	HDC HQ 7 FC	<b>1003180000</b>

尺寸

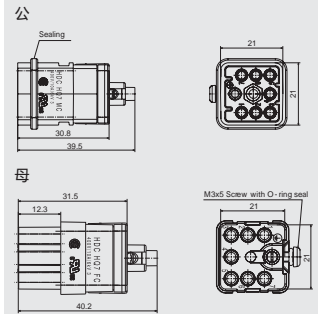

零配件

冷压插件

表面镀银



表面镀金



数量	公	订货号	母	订货号
100	HDC - C - HD - SM0.14 - 0.37AG	<b>1651520000</b>	HDC - C - HD - BM0.14 - 0.37AG	<b>1651570000</b>
100	HDC - C - HD - SM0.5AG	<b>1651530000</b>	HDC - C - HD - BM0.5AG	<b>1651580000</b>
100	HDC - C - HD - SM0.75 - 1AG	<b>1601750000</b>	HDC - C - HD - BM0.75 - 1AG	<b>1601760000</b>
100	HDC - C - HD - SM1.5AG	<b>1651550000</b>	HDC - C - HD - BM1.5AG	<b>1651600000</b>
100	HDC - C - HD - SM2.5AG	<b>1651560000</b>	HDC - C - HD - BM2.5AG	<b>1651610000</b>
100	HDC - C - HD - SM0.14 - 0.37AU	<b>1651620000</b>	HDC - C - HD - BM0.14 - 0.37AU	<b>1651670000</b>
100	HDC - C - HD - SM0.5AU	<b>1651630000</b>	HDC - C - HD - BM0.5AU	<b>1651680000</b>
100	HDC - C - HD - SM0.75 - 1AU	<b>1651640000</b>	HDC - C - HD - BM0.75 - 1AU	<b>1651690000</b>
100	HDC - C - HD - SM1.5AU	<b>1651650000</b>	HDC - C - HD - BM1.5AU	<b>1651700000</b>
100	HDC - C - HD - SM2.5AU	<b>1651660000</b>	HDC - C - HD - BM2.5AU	<b>1651710000</b>



导线截面积	AWG导线	剥线长度
0.14 - 0.37 mm <sup>2</sup>	AWG 26 - 22	8 mm
0.50 mm <sup>2</sup>	AWG 20	8 mm
0.75 - 1.00 mm <sup>2</sup>	AWG 18	8 mm
1.50 mm <sup>2</sup>	AWG 16	8 mm
2.50 mm <sup>2</sup>	AWG 14	6 mm

编码针



数量	订货号	
50	HDC HQ 7 CPM	<b>1003230000</b>
50	HDC HQ 7 CPF	<b>1003220000</b>

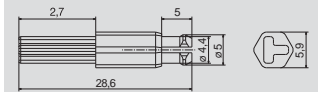
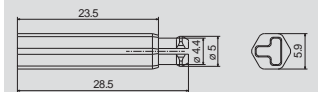

Note: six - way coding is possible with a coding pin.

工具



压针工具	订货号
CTX CM 1.6/2.5	<b>9018490000</b>
CTIN CM 1.6/2.5	<b>9205430000</b>
退针工具	订货号
退针工具 HE	<b>1866750000</b>

## RockStar® IP65外壳选择

## 尺寸1

\*更多外壳,请参D章节



## 插头外壳

材料: 铸铝

## 插头外壳, 侧面进线



a	描述	防尘盖	b (mm)	型号	订货号
M 20	带螺纹		49.2	HDC 04A TWLU 1M20G	<b>1788810000</b>

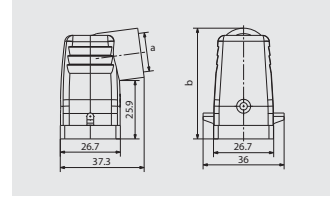

## 插头外壳, 顶部进线



a	描述	防尘盖	b (mm)	型号	订货号
M 20	带螺纹		50	HDC 04A TOLU 1M20G	<b>1788820000</b>

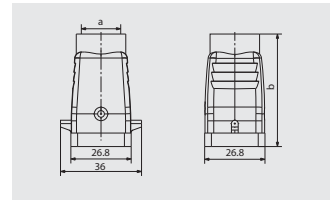

## 底座

## 穿体式插座外壳



描述	防尘盖	b (mm)	型号	订货号
		23	HDC 04A ALU	<b>1497600000</b>

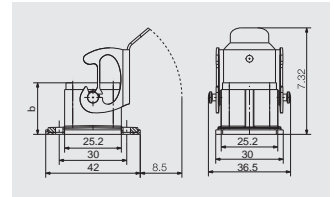

## 底座封闭型插座外壳



a	描述	防尘盖	b (mm)	型号	订货号
M 20	带螺纹		25.8	HDC 04A SLU 1M20G	<b>1788830000</b>

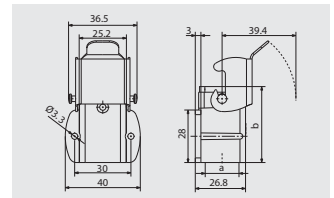

## 对接外壳



a	描述	防尘盖	b (mm)	型号	订货号
M 20	带螺纹		53.5	HDC 04A KOLU 1M20G	<b>1788840000</b>

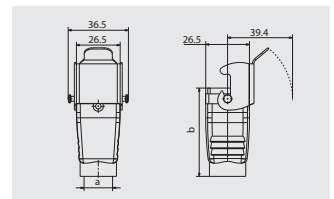

## 出线口螺纹固定外壳



a	描述	防尘盖	b (mm)	型号	订货号
M 20	带螺纹		54	HDC 04A ELU 1M20G	<b>1900320000</b>
PG 13.5	带螺纹		54	HDC 04A ELU 1PG13G	<b>1900330000</b>
PG 13.5	带螺纹		54	HDC 04A ELU 1PG13G EXI	<b>1900350000</b>

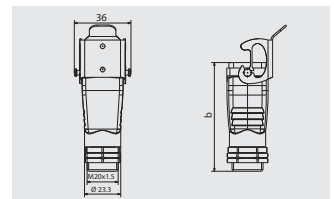

## 防尘盖



描述	型号	订货号
母	HDC 04A DMDL 2BO	<b>1665750000</b>
公	HDC 04A DODL 2BO	<b>1665740000</b>

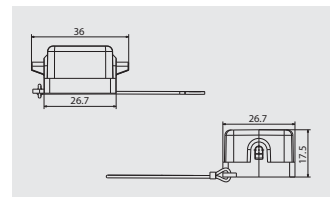

500 V, 16 A, 尺寸HQ

8 + ⊕

插芯



弹片联接



插芯	型号	订货号
公	HDC HQ 8 MC	1919970000
母	HDC HQ 8 FC	1919980000

尺寸

公

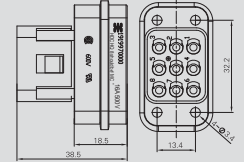

母

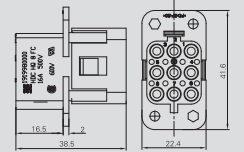

零配件

冷压插针

表面镀银



表面镀金



数量	公	订货号	母	订货号
100	HDC - C - HE - SM0.5AG	1200500000	HDC - C - HE - BM0.5AG	1201100000
100	HDC - C - HE - SM0.75 - 1AG	1200600000	HDC - C - HE - BM0.75 - 1AG	1201200000
100	HDC - C - HE - SM1.5AG	1200700000	HDC - C - HE - BM1.5AG	1201300000
100	HDC - C - HE - SM2.5AG	1200800000	HDC - C - HE - BM2.5AG	1201400000
100	HDC - C - HE - SM4.0AG	1200900000	HDC - C - HE - BM4.0AG	1201500000
100	HDC - C - HE - SM0.5AU	1651420000	HDC - C - HE - BM0.5AU	1651470000
100	HDC - C - HE - SM0.75 - 1AU	1651430000	HDC - C - HE - BM0.75 - 1AU	1651480000
100	HDC - C - HE - SM1.5AU	1651440000	HDC - C - HE - BM1.5AU	1651490000
100	HDC - C - HE - SM2.5AU	1651450000	HDC - C - HE - BM2.5AU	1651500000
100	HDC - C - HE - SM4.0AU	1651460000	HDC - C - HE - BM4.0AU	1651510000

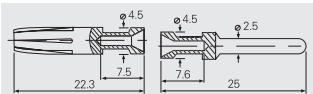

导线截面积

mm <sup>2</sup>	AWG 导线	剥线长度
0.50	20	7.5mm
0.75 - 1.00	18	7.5mm
1.50	16	7.5mm
2.50	14	7.5mm
4.00	12	7.5mm

编码针



数量	订货号
100	HDC HE CP
	1003240000

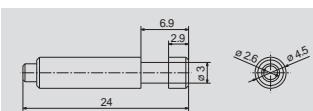

工具



压针工具	订货号
CTX CM 1.6/2.5	9018490000
退针工具	订货号
退针工具 HE	1866750000

## RockStar® IP65/IP66外壳选择

## 尺寸HQ

\*更多外壳,请参阅D章节



## 插头外壳

材料:塑料

## 插头外壳,侧面进线



a	描述	防尘盖	b (mm)	型号	订货号
PG 16	带螺纹		54	HDC HQP TSLU 1PG16	1003090000

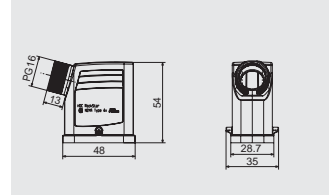

## 插头外壳,顶部进线



a	描述	防尘盖	b (mm)	型号	订货号
PG 16	带螺纹		67	HDC HQP TOLU 1PG16	1003070000

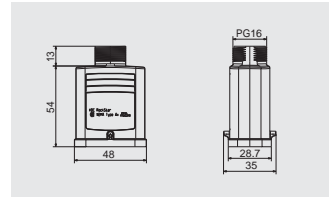

## 底座

## 穿体式插座外壳



描述	防尘盖	b (mm)	型号	订货号
		19.5	HDC HQP ALU	1003040000

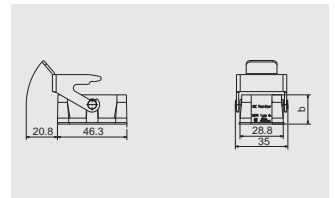

## 穿体式转角插座外壳



描述	防尘盖	b (mm)	型号	订货号
		54.5	HDC HQP AWLU	1003060000

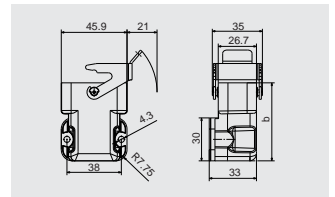

## 底座封闭式插座外壳



a	描述	防尘盖	b (mm)	型号	订货号
PG 16	带螺纹		33	HDC HQP SLU 1PG16	1003110000

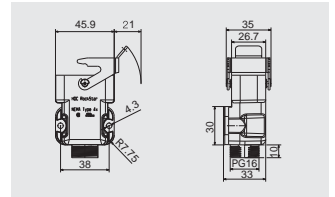

## 对插外壳



a	描述	防尘盖	b (mm)	型号	订货号
PG 16	带螺纹		63.5	HDC HQP KOLU 1PG16	1003120000

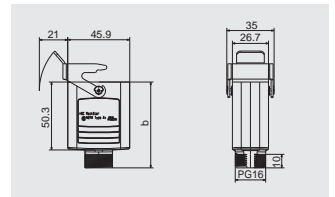

## 防尘盖



描述	型号	订货号
用于母插芯	HDC HQP DMD 2BO	1003130000
用于公插芯	HDC HQP DOD 2BO	1003140000

备注:可选金属外壳

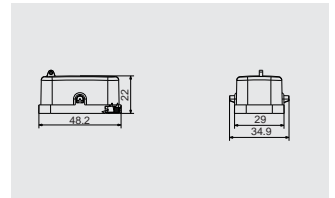



250 V, 10 A, 尺寸 HQ

17 + ⊕

描述

冷压联接



描述	型号	订货号
公	HDC HQ 17 MC	1003210000
母	HDC HQ 17 FC	1003200000

型号

公

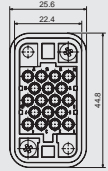
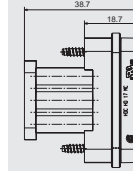

母

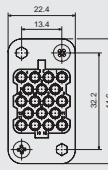
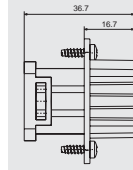

零配件

冷压插件

表面镀银



表面镀金



数量	公	订货号	母	订货号
100	HDC - C - HD - SM0.14 - 0.37AG	1651520000	HDC - C - HD - BM0.14 - 0.37AG	1651570000
100	HDC - C - HD - SM0.5AG	1651530000	HDC - C - HD - BM0.5AG	1651580000
100	HDC - C - HD - SM0.75 - 1AG	1601750000	HDC - C - HD - BM0.75 - 1AG	1601760000
100	HDC - C - HD - SM1.5AG	1651550000	HDC - C - HD - BM1.5AG	1651600000
100	HDC - C - HD - SM2.5AG	1651560000	HDC - C - HD - BM2.5AG	1651610000
100	HDC - C - HD - SM0.14 - 0.37AU	1651620000	HDC - C - HD - BM0.14 - 0.37AU	1651670000
100	HDC - C - HD - SM0.5AU	1651630000	HDC - C - HD - BM0.5AU	1651680000
100	HDC - C - HD - SM0.75 - 1AU	1651640000	HDC - C - HD - BM0.75 - 1AU	1651690000
100	HDC - C - HD - SM1.5AU	1651650000	HDC - C - HD - BM1.5AU	1651700000
100	HDC - C - HD - SM2.5AU	1651660000	HDC - C - HD - BM2.5AU	1651710000



导线截面积	AWG导线	剥线长度
0.14 - 0.37 mm <sup>2</sup>	AWG 26 - 22	8 mm
0.50 mm <sup>2</sup>	AWG 20	8 mm
0.75 - 1.00 mm <sup>2</sup>	AWG 18	8 mm
1.50 mm <sup>2</sup>	AWG 16	8 mm
2.50 mm <sup>2</sup>	AWG 14	6 mm

工具



压针工具	订货号
CTX CM 1.6/2.5	9018490000
CTIN CM 1.6/2.5	9205430000
退针工具	订货号
退针工具HD	1866730000

## RockStar® IP65/IP66外壳选择

## 尺寸HQ

\*更多外壳,请参阅D章节



## 插头外壳

材料:镀锌(电磁屏蔽)

## 插头外壳,侧面进线



a	描述	防尘盖	b (mm)	型号	订货号
PG21	带螺纹		60.5	HDC HQM TSLU 1PG21	<b>1003100000</b>

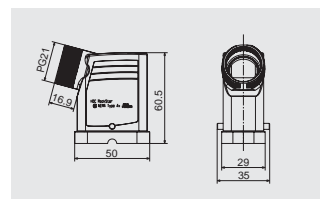

## 插头外壳,顶部进线



a	描述	防尘盖	b (mm)	型号	订货号
PG21	带螺纹		77.5	HDC HQM TOLU 1PG21	<b>1003080000</b>

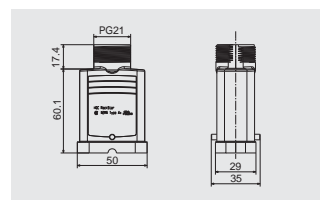

## 底座

## 穿体式插座外壳



描述	防尘盖	b (mm)	型号	订货号
		18.5	HDC HQM ALU	<b>1003050000</b>

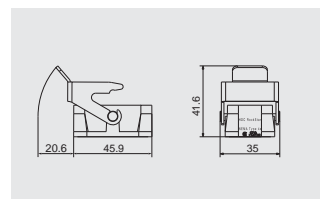

## 防尘盖



材料:	塑料	型号	订货号
描述			
用于母插芯		HDC HQP DMD 2BO	<b>1003130000</b>
用于公插芯		HDC HQP DOD 2BO	<b>1003140000</b>

备注:可选金属外壳

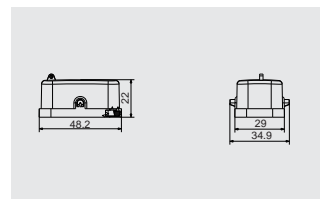

690 V, 40 A, 尺寸 HQ

4 + 2 + ⊕

插芯



冷压联接



插芯	型号	订货号
公	HDC HQ 4 2 MC	1003170000
母	HDC HQ 4 2 FC	1003160000

型号

公

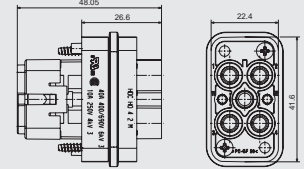

母

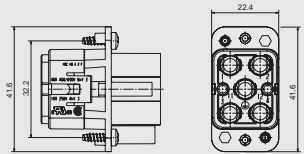

零配件

冷压插件

表面镀银



数量	公	订货号	母	订货号
25	HDC C HX SM1.5AG	1002910000	HDC C HX BM1.5AG	1002950000
25	HDC C HX SM2.5AG	1002920000	HDC C HX BM2.5AG	1002960000
25	HDC C HX SM4.0AG	1002930000	HDC C HX BM4.0AG	1002970000
25	HDC C HX SM6.0AG	1002940000	HDC C HX BM6.0AG	1002980000

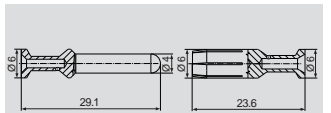

导线截面积	AWG导线	剥线长度
1.50 mm <sup>2</sup>	AWG 16	8 mm
2.50 mm <sup>2</sup>	AWG 14	8 mm
4.00 mm <sup>2</sup>	AWG 12	8 mm
6.00 mm <sup>2</sup>	AWG 10	8 mm

工具



压针工具	订货号
CTIN CM 1.6/2.5	9205430000
退针工具	订货号
退针工具 HX	1002990000

冷压插件

表面镀银



数量	公	订货号	母	订货号
100	HDC-C-HD-SM0.14-0.37AG	1651520000	HDC-C-HD-BM0.14-0.37AG	1651570000
100	HDC-C-HD-SM0.5AG	1651530000	HDC-C-HD-BM0.5AG	1651580000
100	HDC-C-HD-SM0.75-1AG	1601750000	HDC-C-HD-BM0.75-1AG	1601760000
100	HDC-C-HD-SM1.5AG	1651550000	HDC-C-HD-BM1.5AG	1651600000
100	HDC-C-HD-SM2.5AG	1651560000	HDC-C-HD-BM2.5AG	1651610000

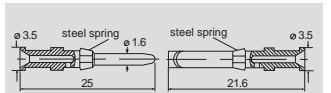

导线截面积	AWG导线	剥线长度
0.14 - 0.37 mm <sup>2</sup>	AWG 26 - 22	8 mm
0.50 mm <sup>2</sup>	AWG 20	8 mm
0.75 - 1.00 mm <sup>2</sup>	AWG 18	8 mm
1.50 mm <sup>2</sup>	AWG 16	8 mm
2.50 mm <sup>2</sup>	AWG 14	6 mm

表面镀金



100	HDC-C-HD-SM0.14-0.37AU	1651620000	HDC-C-HD-BM0.14-0.37AU	1651670000
100	HDC-C-HD-SM0.5AU	1651630000	HDC-C-HD-BM0.5AU	1651680000
100	HDC-C-HD-SM0.75-1AU	1651640000	HDC-C-HD-BM0.75-1AU	1651690000
100	HDC-C-HD-SM1.5AU	1651650000	HDC-C-HD-BM1.5AU	1651700000
100	HDC-C-HD-SM2.5AU	1651660000	HDC-C-HD-BM2.5AU	1651710000

工具



压针工具	订货号
CTX CM 1.6/2.5	9018490000
CTIN CM 1.6/2.5	9205430000
退针工具	订货号
退针工具HD	1866730000

RockStar® IP65/IP66外壳选择

尺寸HQ

\*更多外壳,请参阅D章节



插头外壳

材料:塑料

插头外壳,侧面进线



a	描述	防尘盖	b (mm)	型号	订货号
PG 16	带螺纹		54	HDC HQP TSLU 1PG16	1003090000

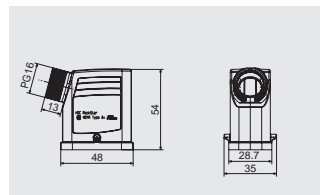

插头外壳,顶部进线



a	描述	防尘盖	b (mm)	型号	订货号
PG 16	带螺纹		67	HDC HQP TOLU 1PG16	1003070000

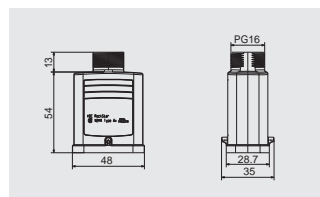

底座

穿体式插座外壳



描述	防尘盖	b (mm)	型号	订货号
		19.5	HDC HQP ALU	1003040000

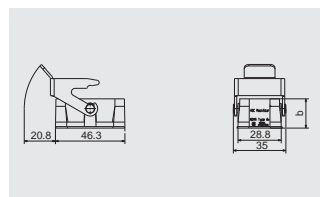

穿体式转角插座外壳



描述	防尘盖	b (mm)	型号	订货号
		54.5	HDC HQP AWLU	1003060000

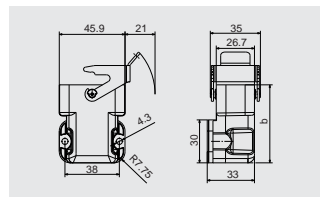

底座封闭式插座外壳



a	描述	防尘盖	b (mm)	型号	订货号
PG 16	带螺纹		33	HDC HQP SLU 1PG16	1003110000

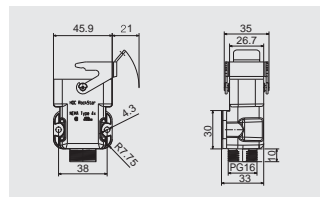

对插外壳



a	描述	防尘盖	b (mm)	型号	订货号
PG 16	带螺纹		63.5	HDC HQP KOLU 1PG16	1003120000

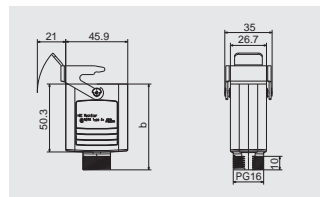

防尘盖



描述	型号	订货号
用于母插芯	HDC HQP DMD 2BO	1003130000
用于公插芯	HDC HQP DOD 2BO	1003140000

备注:可选金属外壳

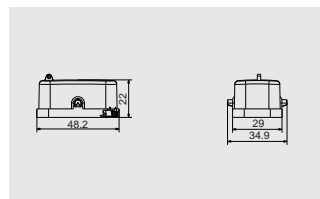

索引

索引

索引
----

索引	X.2
----	-----

X

Table with columns: 订货号, 型号, 页码. Contains multiple sections of product data including 026000000, 029000000, 049000000, 050000000, 100000000, 101000000, 102000000, 104000000, 105000000, 106000000, 107000000, 108000000, 110000000, 111000000, 112000000, 114000000, 116000000, 117000000, 119000000, 120000000, 121000000, 122000000, 123000000, 124000000, 125000000, 126000000, 127000000, 128000000, 129000000, 130000000, 131000000, 132000000, 133000000, 134000000, 135000000, 136000000, 137000000, 138000000, 139000000, 140000000, 141000000, 142000000, 143000000, 144000000, 145000000, 146000000, 147000000, 148000000, 149000000, 150000000, 151000000, 152000000, 153000000, 154000000, 155000000, 156000000, 157000000, 158000000, 159000000, 160000000, 161000000, 162000000, 163000000, 164000000, 165000000, 166000000, 167000000, 168000000, 169000000, 170000000, 171000000, 172000000, 173000000, 174000000, 175000000, 176000000, 177000000, 178000000, 179000000, 180000000, 181000000, 182000000, 183000000, 184000000, 185000000, 186000000, 187000000, 188000000, 189000000, 190000000, 191000000, 192000000, 193000000, 194000000, 195000000, 196000000, 197000000, 198000000, 199000000, 200000000.



Table with columns: 订货号, 型号, 页码, 订货号, 型号, 页码, 订货号, 型号, 页码, 订货号, 型号, 页码. It lists various Weidmuller HDC and HD connector models and their corresponding page numbers.





Table with columns: 订货号, 型号, 页码. Multiple columns of data listing product part numbers, models, and page references.



Table with columns: 订货号, 型号, 页码, 订货号, 型号, 页码, 订货号, 型号, 页码, 订货号, 型号, 页码. Contains multiple columns of product data for Weidmuller HDC and HD connectors.

