

# MS5535B (RoHS<sup>\*</sup>)

# PRESSURE SENSOR MODULE

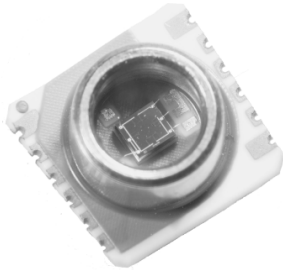

- 0 - 14 bar absolute pressure range
- 6 coefficients for software compensation stored on-chip
- Piezoresistive silicon micromachined sensor
- Integrated miniature pressure sensor 9 x 9 mm
- 15 Bit ADC
- 3-wire serial interface
- 1 system clock line (32.768 kHz)
- Low voltage and low power consumption
- RoHS-compatible & Pb-free<sup>\*</sup>

## DESCRIPTION

The MS5535B is a SMD-hybrid device including a piezoresistive pressure sensor and an ADC-Interface IC. It provides a 16 Bit data word from a pressure and temperature dependent voltage. Additionally the module contains 6 readable coefficients for a highly accurate software calibration of the sensor. MS5535B is a low power, low voltage device with automatic power down (ON/OFF) switching. A 3-wire interface is used for all communications with a microcontroller.

Compared to the previous version (MS5535A) the temperature range has been improved (-40 to +125°C. Other improvements concern the ESD sensitivity, current consumption and converter accuracy.

## FEATURES

- Supply voltage 2.2 V to 3.6 V
- Low supply current
- -40°C to +125°C operation temperature
- No external components required

## APPLICATIONS

- 15 Bit ADC resolution pressure measurement and control systems
- Mobile water depth measurement systems
- Diving computers and divers watches

## BLOCK DIAGRAM

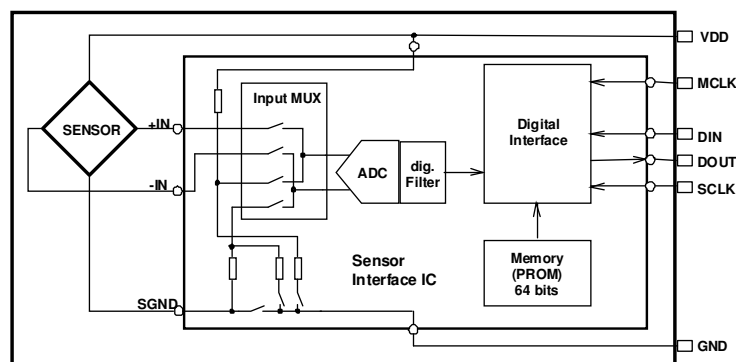

Fig. 1: Block diagram 5535B.

<sup>\*</sup> The European RoHS directive 2002/95/EC (Restriction of the use of certain Hazardous Substances in electrical and electronic equipment) bans the use of lead, mercury, cadmium, hexavalent chromium and polybrominated biphenyls (PBB) or polybrominated diphenyl ethers (PBDE).

## PIN CONFIGURATION

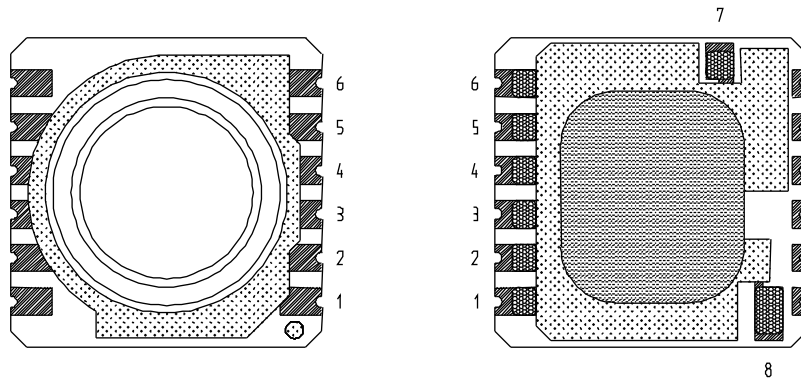

Fig. 2: Pin configuration of MS5535B.

Pin Name	Pin	Type	Function
GND	1	G	Ground
SCLK	2	I	Serial data clock
DOUT	3	O	Data output
DIN	4	I	Data input
MCLK	5	I	Master clock (32.768 kHz)
VDD	6	P	Positive supply voltage
PEN (1)	7	I	Programming enable
PV (1)	8	N	Negative programming voltage

### NOTE

- 1) Pin 7 (PEN) and PIN 8 (PV) are only used by the manufacturer for calibration purposes and should not be connected.

## ABSOLUTE MAXIMUM RATINGS

Parameter	Symbol	Conditions	Min	Max	Unit	Notes
Supply voltage	VDD	Ta = 25 °C	-0.3	4	V	
Storage temperature	T <sub>s</sub>		-40	+125	°C	1
Overpressure	P	Ta = 25 °C		30	bar	

### NOTE

- 1) Storage and operation in an environment of dry and non-corrosive gases.

## RECOMMENDED OPERATING CONDITIONS

(Ta = 25°C, VDD = 3.0 V unless noted otherwise)

Parameter	Symbol	Conditions	Min.	Typ.	Max	Unit
Operating pressure range	p		0		14	bar abs.
Supply voltage	VDD		2.2	3.0	3.6	V
Supply current, average (1) during conversion (2) standby (no conversion)	$I_{avg}$ $I_{sc}$ $I_{ss}$	VDD = 3.0 V		4 1	0.1	$\mu$ A mA $\mu$ A
Current consumption into MCLK (3)		MCLK = 32.768 kHz			0.5	$\mu$ A
Operating temperature range	T		-40		+125	°C
Conversion time	$t_{conv}$	MCLK = 32.768 kHz			35	ms
External clock signal (4)	MCLK		30.000	32.768	35.000	kHz
Duty cycle of MCLK			40/60	50/50	60/40	%
Serial data clock	SCLK				500	kHz

### NOTES

- 1) Under the assumption of one conversion every second. Conversion means either a pressure or a temperature measurement started by a command to the serial interface of MS5535B.
- 2) During conversion the sensor will be switched on and off in order to reduce power consumption; the total on time within a conversion is about 2 ms.
- 3) This value can be reduced by switching off MCLK while MS5535B is in standby mode.
- 4) It is strongly recommended that a crystal oscillator be used because the device is sensitive to clock jitter. A square-wave form of the clock signal is a must.

## ELECTRICAL CHARACTERISTICS

### DIGITAL INPUTS

(T = -40°C .. 125°C, VDD = 2.2 V .. 3.6 V)

Parameter	Symbol	Conditions	Min	Typ	Max	Unit
Input High Voltage	$V_{IH}$		80% VDD		100% VDD	V
Input Low Voltage	$V_{IL}$		0% VDD		20% VDD	V
Signal Rise Time	$t_r$			200		ns
Signal Fall Time	$t_f$			200		ns

### DIGITAL OUTPUTS

(T = -40°C .. 125°C, VDD = 2.2 V .. 3.6 V)

Parameter	Symbol	Conditions	Min	Typ	Max	Unit
Output High Voltage	$V_{OH}$	$I_{source} = 0.6 \text{ mA}$	75% VDD		100% VDD	V
Output Low Voltage	$V_{OL}$	$I_{sink} = 0.6 \text{ mA}$	0% VDD		20% VDD	V
Signal Rise Time	$t_r$			200		ns
Signal Fall Time	$t_f$			200		ns

### AD-CONVERTER

(T = -40°C .. 125°C, VDD = 2.2 V .. 3.6 V)

Parameter	Symbol	Conditions	Min	Typ	Max	Unit
Resolution				15		Bit
Linear Range			0		40000	LSB
Conversion Time		MCLK = 32.768 kHz			35	ms
INL		Within linear range	-4		+4	LSB

## PRESSURE OUTPUT CHARACTERISTICS

With the calibration data stored in the interface IC of the MS5535B the following characteristics can be achieved:

(VDD = 3.0 V unless noted otherwise)

Parameter	Conditions	Min	Typ	Max	Unit	Notes
Resolution			1.2		mbar	1
Absolute Pressure Accuracy (Temperature range 0 .. +40°C)	p = 0 .. 5 bar p = 0 .. 10 bar p = 0 .. 14 bar	-25 -60 -150		+20 +20 +20	mbar	2
Absolute Pressure Accuracy (Temperature range -40 .. +85°C)	p = 0 .. 5 bar p = 0 .. 10 bar p = 0 .. 14 bar	-40 -60 -160		+100 +180 +200	mbar	2
Absolute Pressure Accuracy (Temperature range -40 .. +125°C)	p = 0 .. 5 bar p = 0 .. 10 bar p = 0 .. 14 bar	-80 -100 -200		+200 +300 +400	mbar	2
Long-term Stability	6 months		20		mbar	3
Maximum Error over Supply Voltage	VDD = 2.2 .. 3.6 V	-20		+20	mbar/V	

### NOTES

- 1) A stable pressure reading of the given resolution requires taking the average of 2 to 4 subsequent pressure values due to noise of the ADC.
- 2) Maximum error of pressure reading over the pressure range.
- 3) The long-term stability is measured with non-soldered devices.

## TEMPERATURE OUTPUT CHARACTERISTICS

This temperature information is not required for most applications, but it is necessary to allow for temperature compensation of the pressure output.

(VDD = 3.0 V unless noted otherwise)

Parameter	Conditions	Min	Typ	Max	Unit	Notes
Resolution		0.005	0.01	0.015	°C	
Accuracy	T = 20°C	-0.8		0.8	°C	
	T = -40 .. +125°C	- 2		+4	°C	1
Maximum Error over Supply Voltage	VDD = 2.2 .. 3.6 V	-0.3		0.3	°C	

### NOTE

- 1) With the second-order temperature compensation as described in Section "FUNCTION". See next section for typical operating curves.

**TYPICAL PERFORMANCE CURVES**

**ADC-value D1 vs Pressure (typical)**

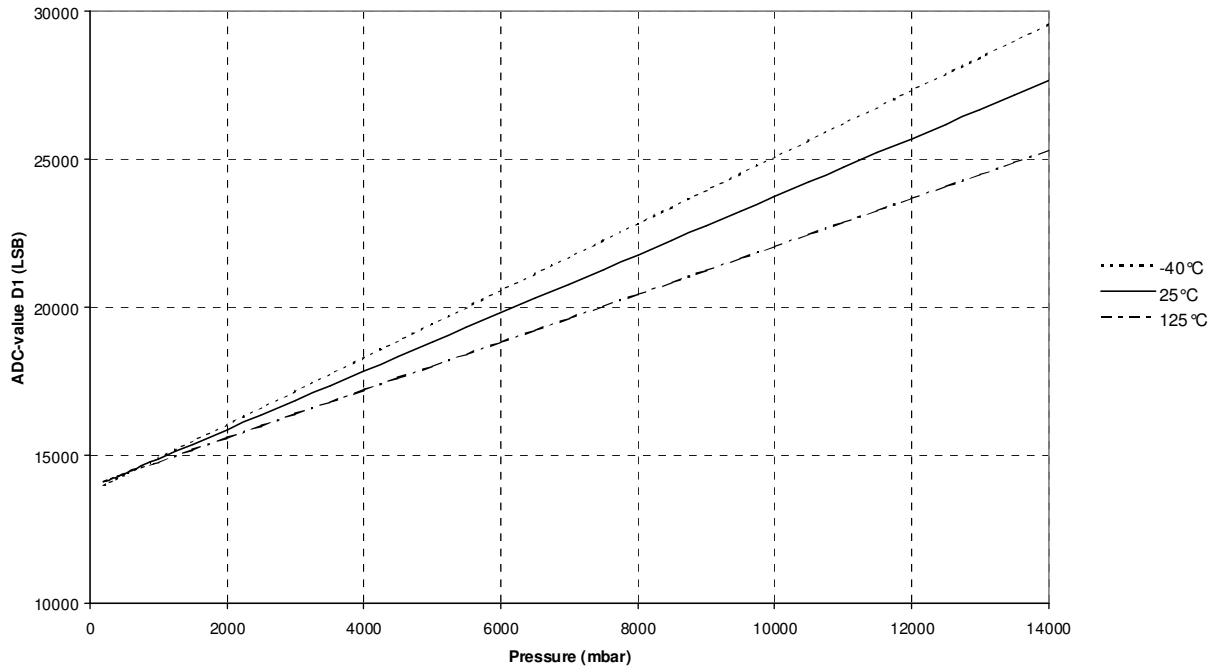

**ADC-value D2 vs Temperature (typical)**

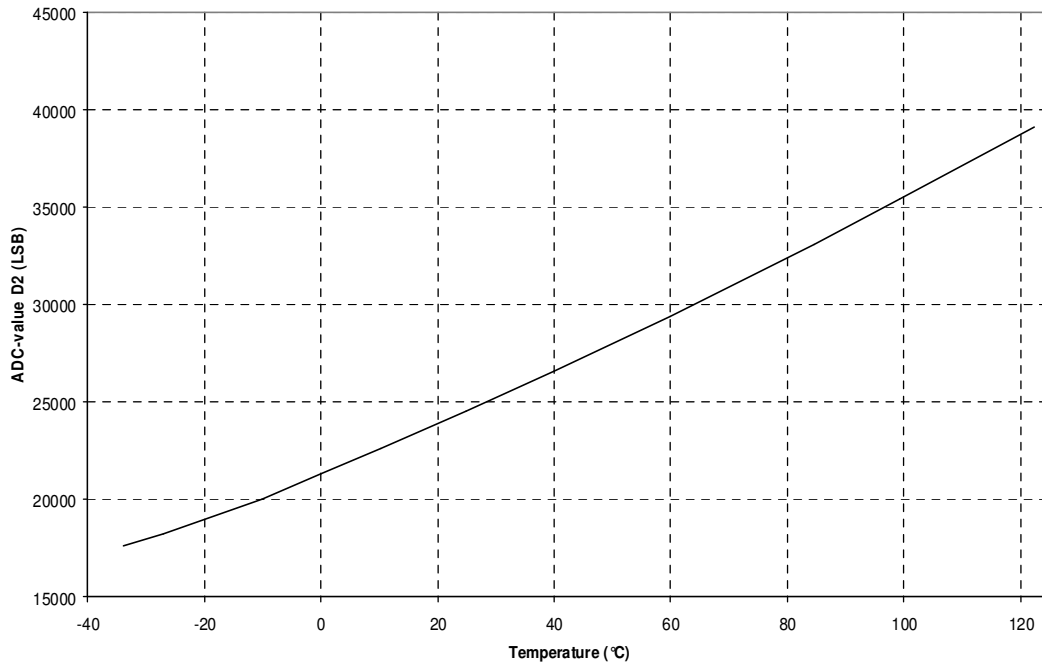

**Absolute Pressure Accuracy after Calibration**

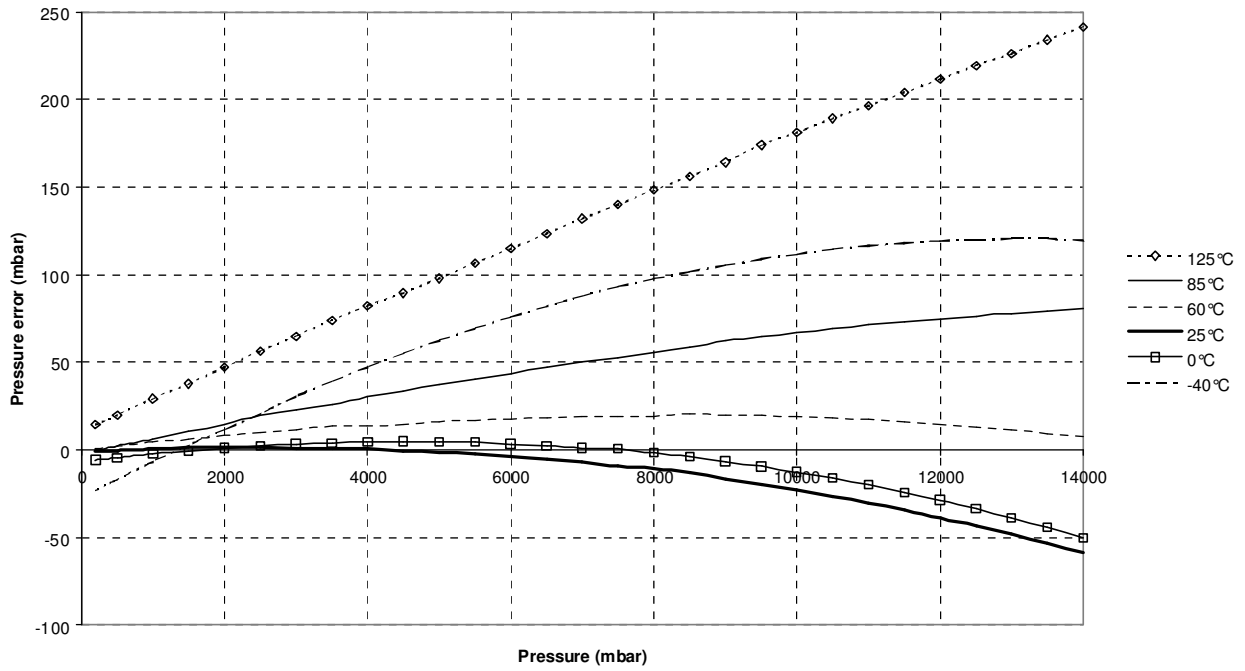

**Absolute Pressure Accuracy (2nd order) after Calibration**

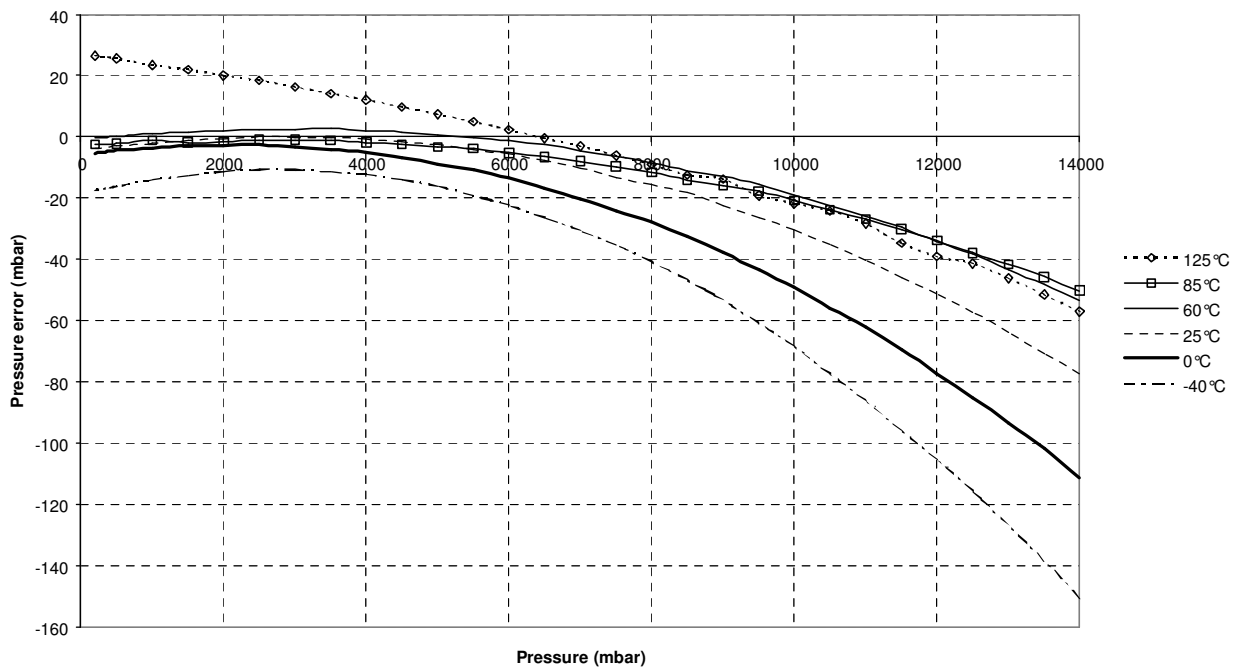

**Pressure Error Accuracy vs temperature (typical)**

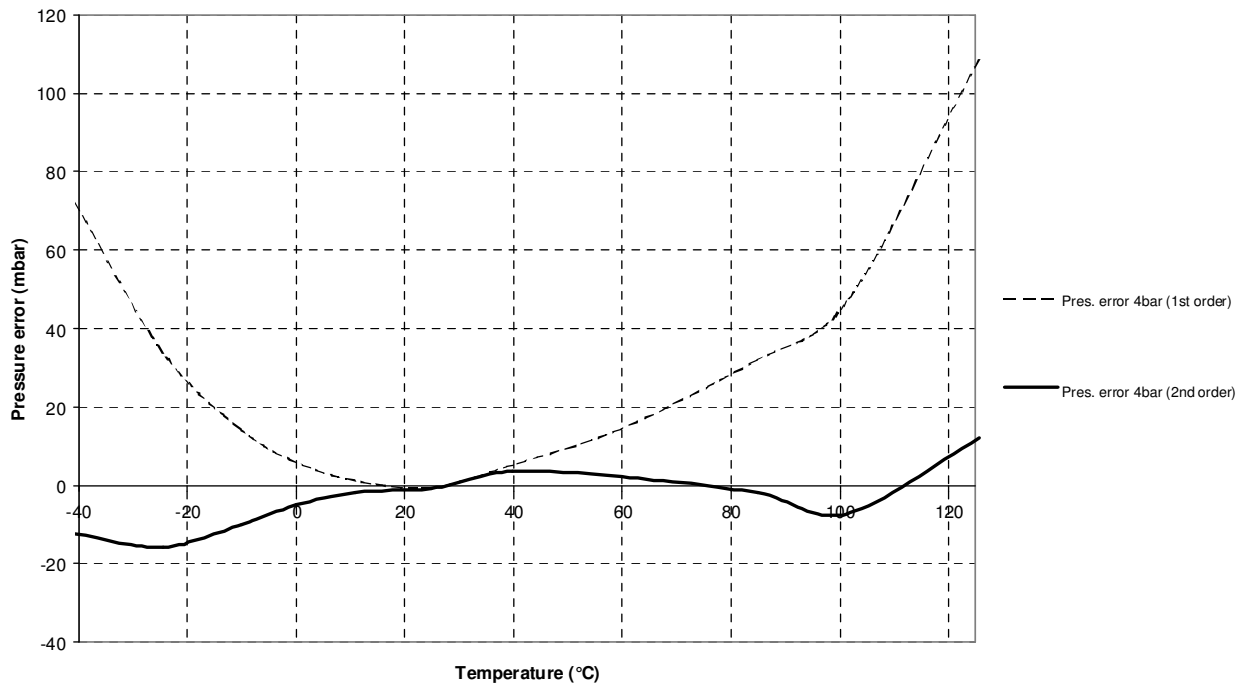

**Temperature Error Accuracy vs temperature (typical)**

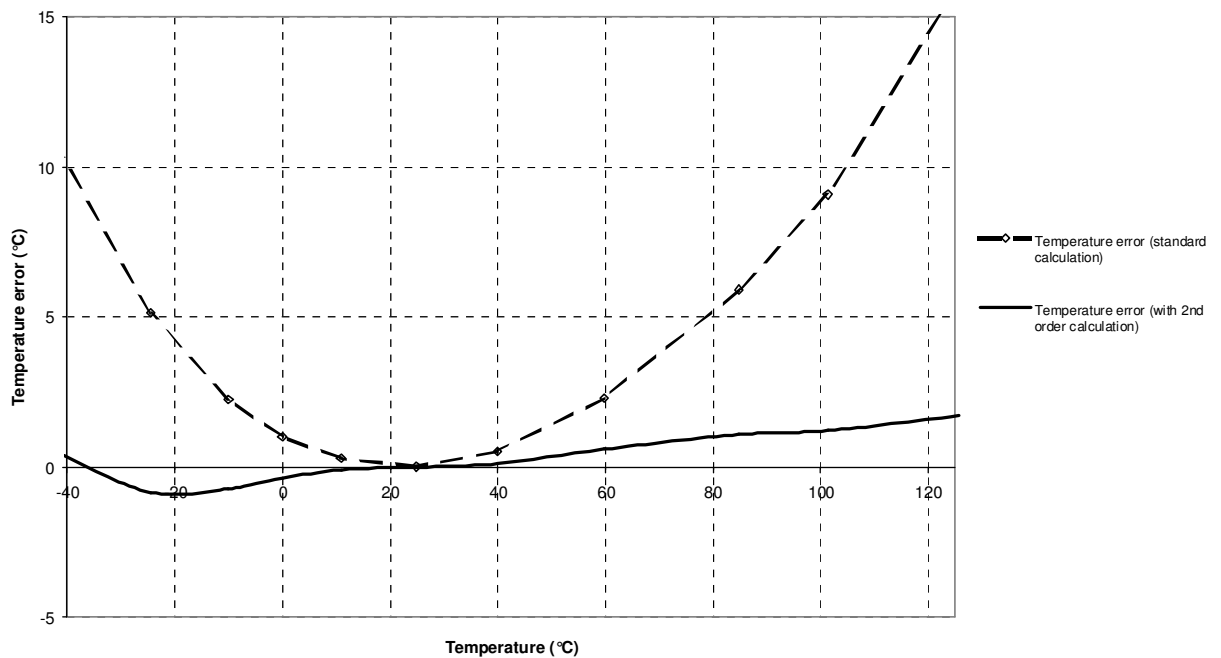



**Pressure error vs supply voltage (typical)**

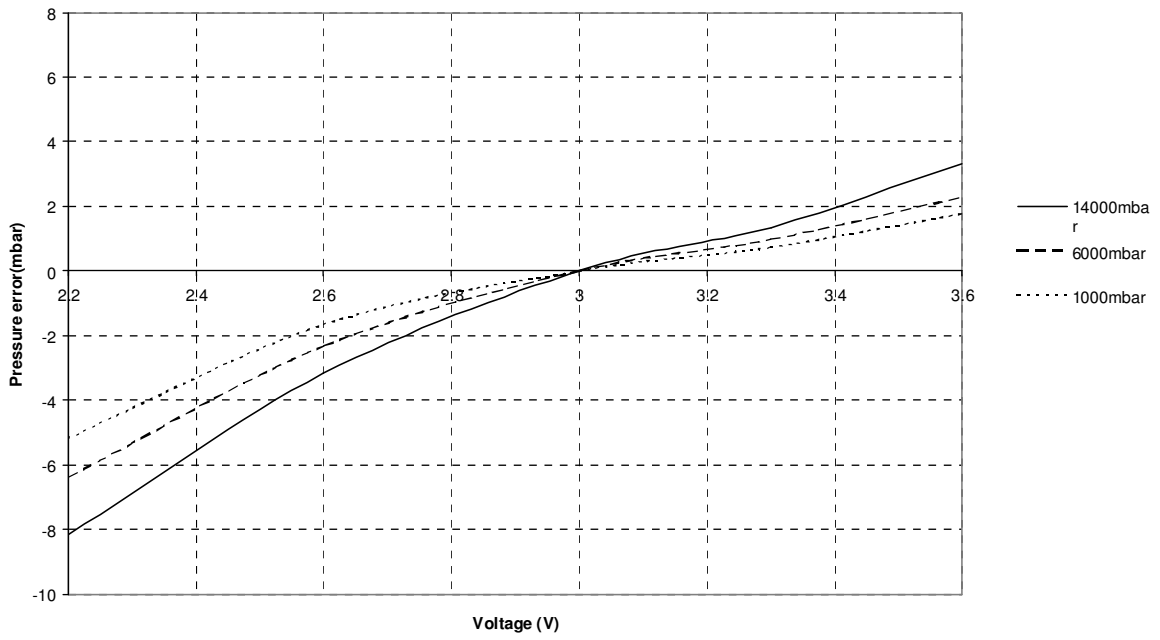

**Temperature error (25°C) vs supply voltage (typical)**

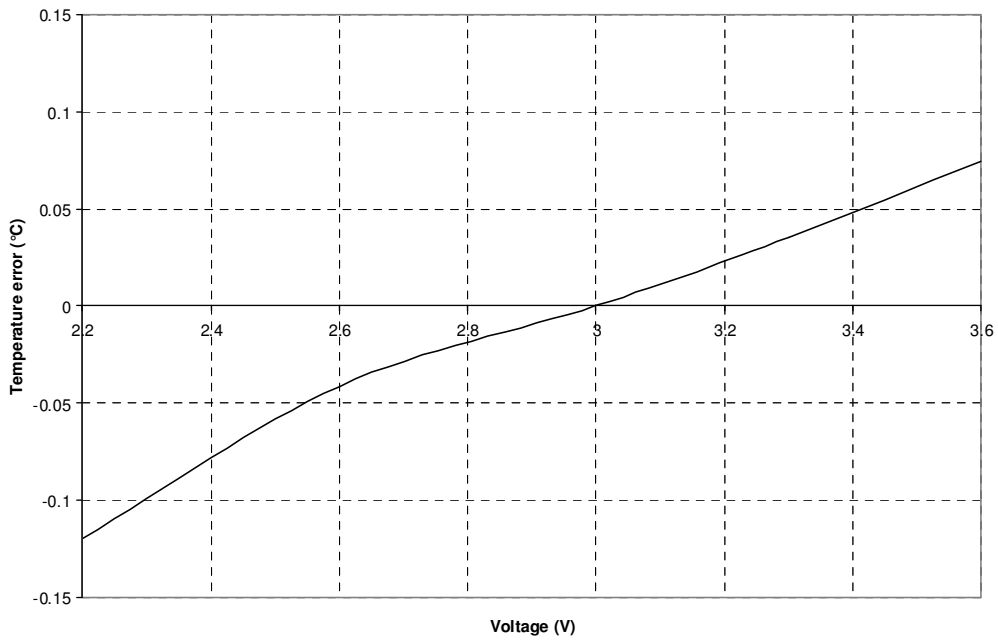

## FUNCTION

### GENERAL

The MS5535B consists of a piezoresistive sensor and a sensor interface IC. The main function of the MS5535B is to convert the uncompensated analogue output voltage from the piezoresistive pressure sensor to a 16-Bit digital value, as well as providing a 16-Bit digital value for the temperature of the sensor.

- measured pressure (16-Bit) "D1"
- measured temperature (16-Bit) "D2"

As the output voltage of a pressure sensor is strongly dependent on temperature and process tolerances, it is necessary to compensate for these effects. This compensation procedure must be performed by software using an external microcontroller.

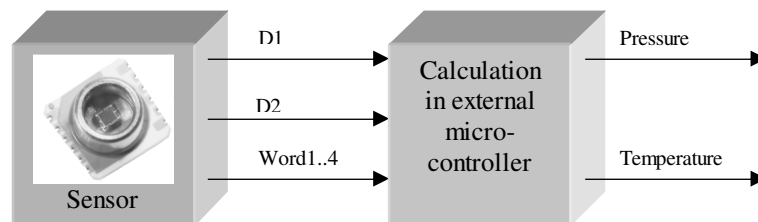

For both pressure and temperature measurement the same ADC is used (sigma delta converter):

- for the pressure measurement, the differential output voltage from the pressure sensor is converted
- for the temperature measurement, the sensor bridge resistor is sensed and converted

During both measurements the sensor will only be switched on for a very short time in order to reduce power consumption. As both, the bridge bias and the reference voltage for the ADC are derived from VDD, the digital output data is independent of the supply voltage.

### FACTORY CALIBRATION

Every module is individually factory calibrated at two temperatures and two pressures. As a result, 6 coefficients necessary to compensate for process variations and temperature variations are calculated and stored in the 64-Bit PROM of each module. These 64-Bit (partitioned into four words of 16-Bit) must be read by the microcontroller software and used in the program converting D1 and D2 into compensated pressure and temperature values.

### PRESSURE AND TEMPERATURE MEASUREMENT

The sequence of reading pressure and temperature as well as of performing the software compensation is depicted in Fig. 3 and Fig. 5.

First the Word1 to Word4 have to be read through the serial interface. This can be done once after reset of the microcontroller that interfaces to the MS5535B. Next the compensation coefficients C1 to C6 are extracted using Bit-wise logical- and shift-operations (refer to Fig. 4 for the Bit-pattern of Word1 to Word4).

For the pressure measurement the microcontroller has to read the 16 Bit values for pressure (D1) and temperature (D2) via the serial interface in a loop (for instance every second). Then, the compensated pressure is calculated out of D1, D2 and C1 to C6 according to the algorithm in Fig. 3 (possibly using quadratic temperature compensation according to Fig. 5). All calculations can be performed with signed 16-Bit variables. Results of multiplications may be up to 32-Bit long (+sign). In the flow according to Fig. 3 each multiplication is

followed by a division. This division can be performed by Bit-wise shifting (divisors are to the power of 2). It is ensured that the results of these divisions are less than 65536 (16-Bit).

For the timing of signals to read out Word1 to Word4, D1, and D2 please refer to the paragraph "SERIAL INTERFACE".

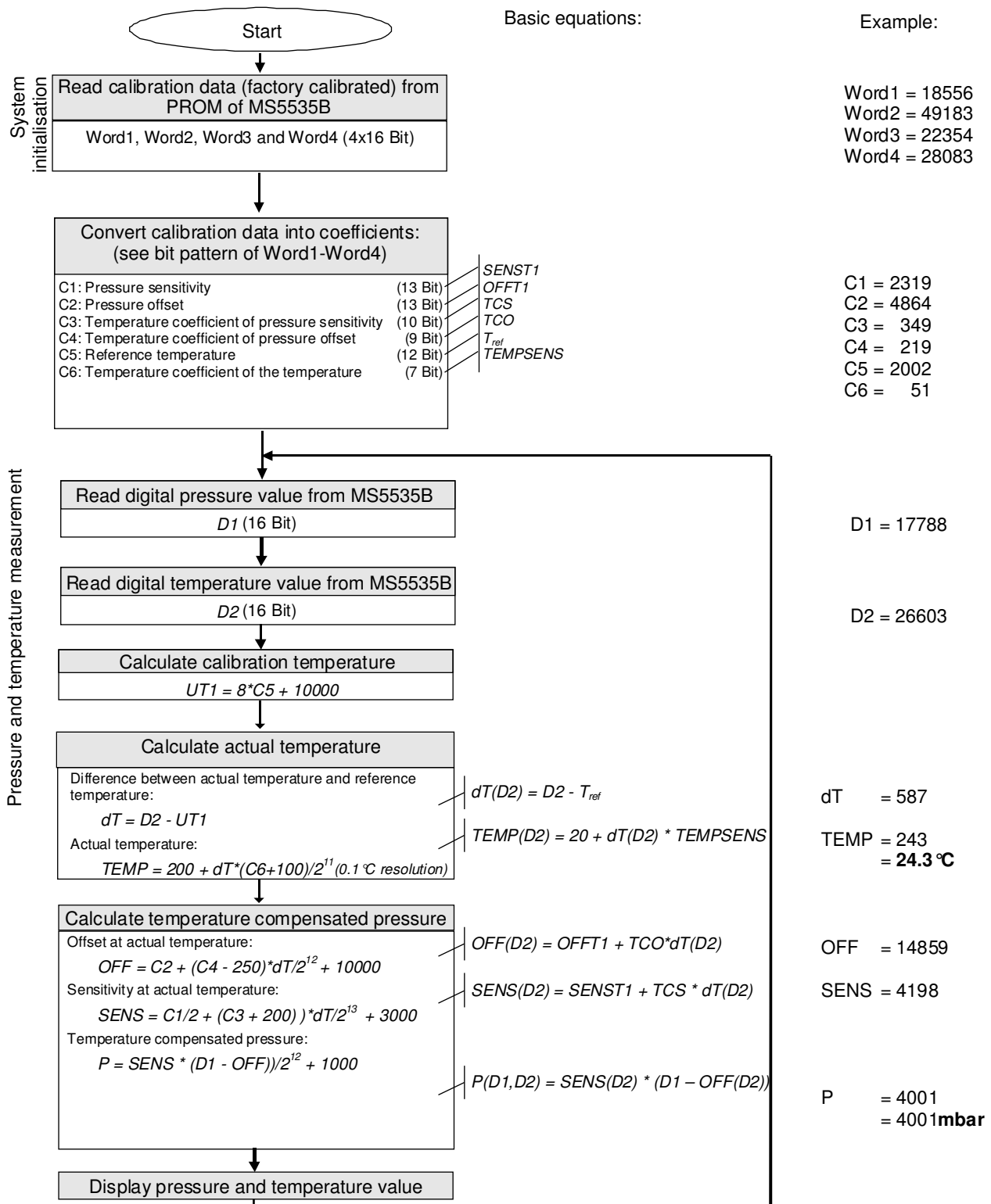

Fig. 3: Flow chart for pressure and temperature reading and software compensation.

**NOTES**

- 1) Readings of D2 can be done less frequently, but the display will be less stable in this case.

- 2) For a stable display of 0.1 mbar resolution, it is recommended to display the average of 8 subsequent pressure values.

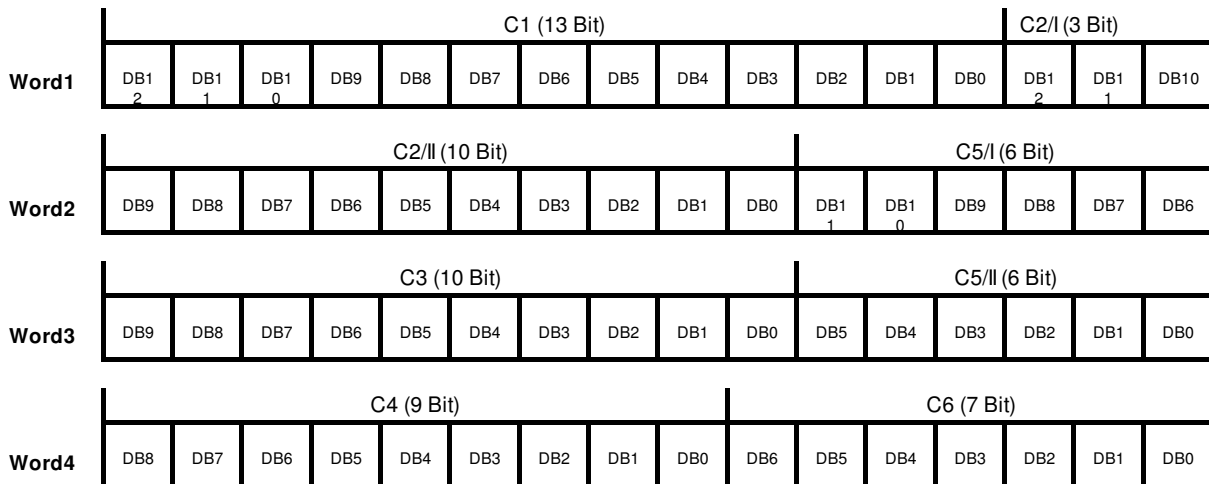

Fig. 4: Arrangement (Bit-pattern) of calibration data in Word1 to Word4.

## SECOND-ORDER TEMPERATURE COMPENSATION

In order to obtain best accuracy over the whole temperature range, it is recommended to compensate for the non-linearity of the output of the temperature sensor. This can be achieved by correcting the calculated temperature and pressure by a second order correction factor. The second-order factors are calculated as follows:

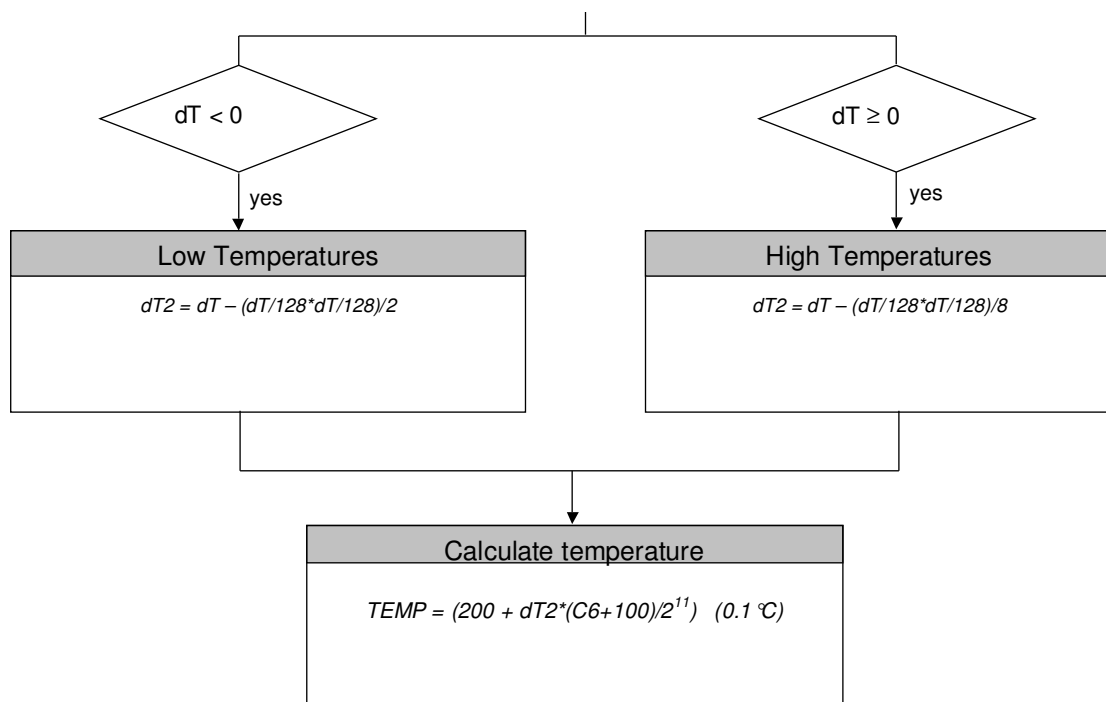

Fig. 5: Flow chart for calculating the temperature and pressure to the optimum accuracy.

## SERIAL INTERFACE

The MS5535B communicates with microprocessors and other digital systems via a 3-wire synchronous serial interface as shown in Fig. 1. The SCLK (Serial clock) signal initiates the communication and synchronises the data transfer with each Bit being sampled by the MS5535B on the rising edge of SCLK and each Bit being sent by the MS5535B on the rising edge of SCLK. The data should thus be sampled by the microcontroller on the falling edge of SCLK and sent to the MS5535B with the falling edge of SCLK. The SCLK-signal is generated by the microprocessor's system. The digital data provided by the MS5535B on the DOUT pin is either the conversion result or the software calibration data. In addition the signal DOUT (Data out) is also used to indicate the conversion status (conversion-ready signal, see below). The selection of the output data is done by sending the corresponding instruction on the pin DIN (Data input).

Following is a list of possible output data instructions:

- Conversion start for pressure measurement and ADC-data-out "D1" (Figure 6a)
- Conversion start for temperature measurement and ADC-data-out "D2" (Figure 6b)
- Calibration data read-out sequence for Word1 (Figure 6c)
- Calibration data read-out sequence for Word2 (Figure 6d)
- Calibration data read-out sequence for Word3 (Figure 6c)
- Calibration data read-out sequence for Word4 (Figure 6d)
- RESET sequence (Figure 6e)

Every communication starts with an instruction sequence at pin DIN. Fig. 6 shows the timing diagrams for the MS5535B. The device does not need a 'Chip select' signal. Instead there is a START sequence (3-Bit high) before each SETUP sequence and STOP sequence (3-Bit low) after each SETUP sequence. The SETUP sequence consists in 4-Bit that select a reading of pressure, temperature or calibration data. In case of pressure- (D1) or temperature- (D2) reading the module acknowledges the start of a conversion by a low to high transition at pin DOUT during the last bit of the STOP sequence.

Two additional clocks at SCLK are required after the acknowledge signal. Then SCLK is to be held low by the microcontroller until a high to low transition on DOUT indicates the end of the conversion.

This signal can be used to create an interrupt in the microcontroller. The microcontroller may now read out the 16-Bit word by giving another 17 clocks on the SCLK pin. It is possible to interrupt the data READOUT sequence with a hold of the SCLK signal. **It is important to always read out the last conversion result before starting a new conversion.**

The RESET sequence is special as its unique pattern is recognised by the module in any state. By consequence it can be used to restart if synchronisation between the microcontroller and the MS5535B has been lost. This sequence is 21-Bit long. The DOUT signal might change during that sequence (see Fig. 6e). **It is recommended to send the RESET sequence before each CONVERSION sequence to avoid hanging up the protocol permanently in case of electrical interference.**

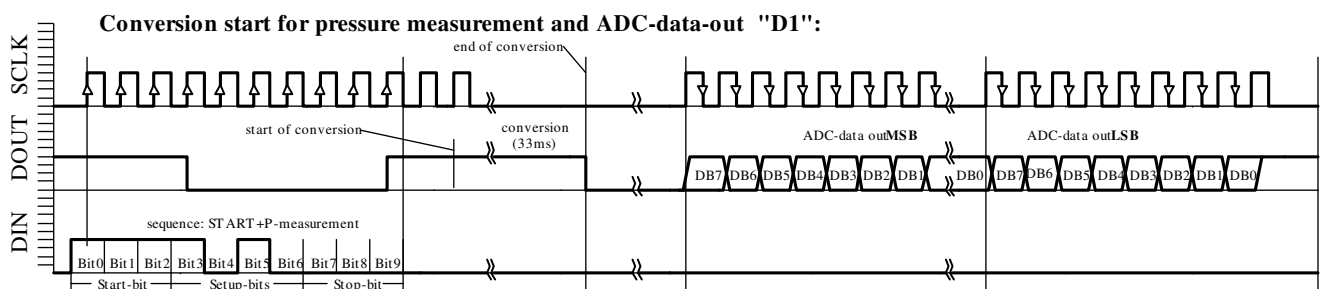

Fig. 6a: D1 ACQUISITION sequence.

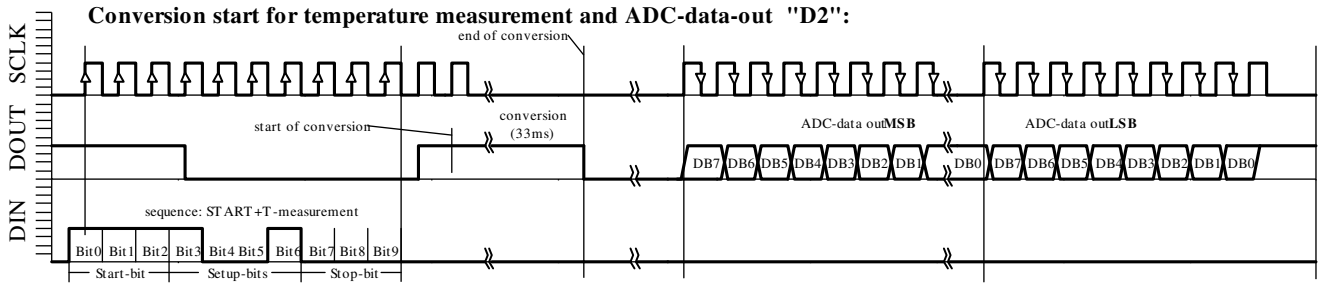

Fig. 6b: D2 ACQUISITION sequence.

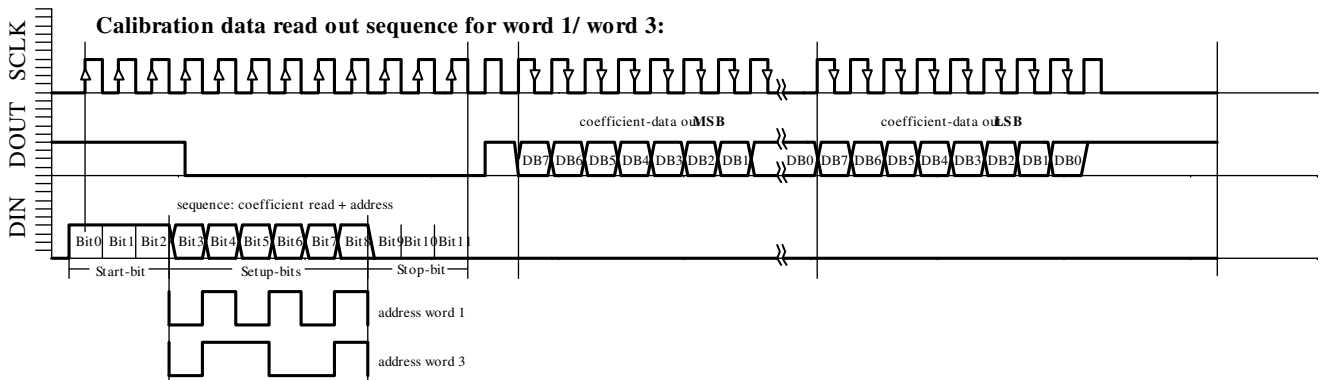

Fig. 6c: Word1, Word3 READING sequence.

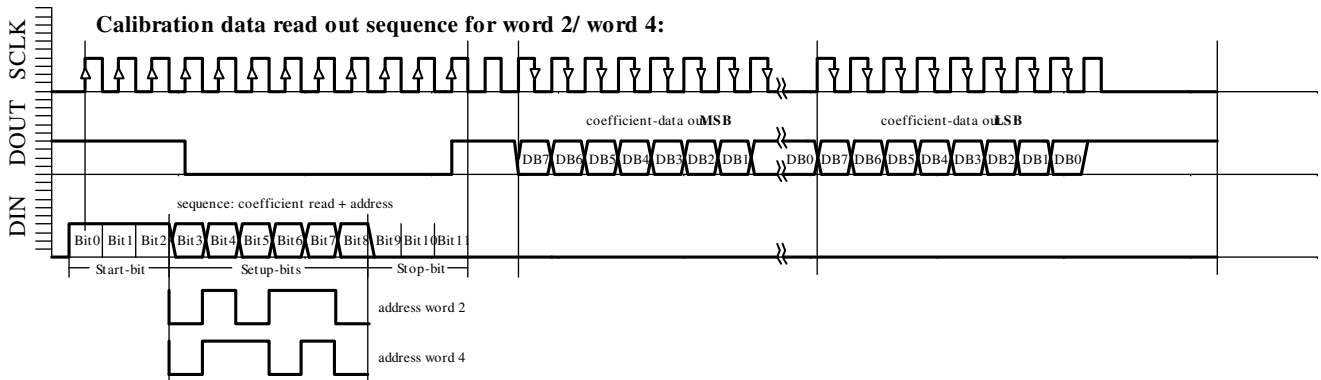

Fig. 6d: W2, W4 READING sequence.

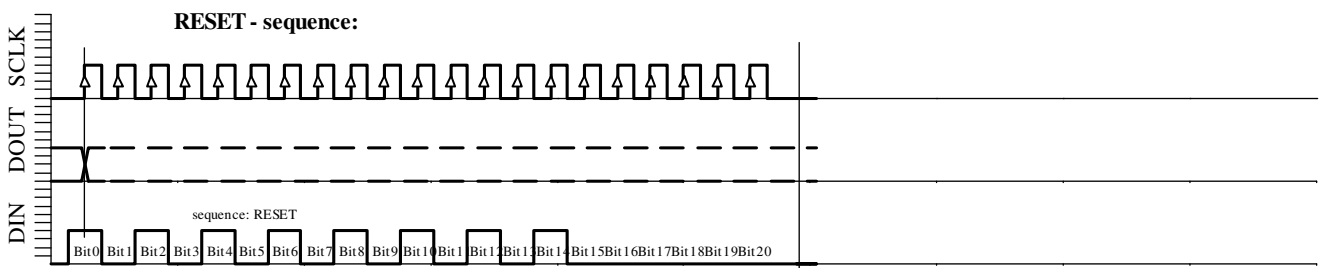

Fig. 6e: RESET sequence (21-Bit).



---

## **APPLICATION INFORMATION**

---

### **GENERAL**

The advantage of combining a pressure sensor with a directly adapted integrated circuit is to save other external components and to achieve a very low power consumption. The main application field for this system includes portable devices with battery supply, but its high accuracy and resolution make it also suited for industrial and automotive applications. The possibility to compensate the sensor with a software allows the user to adapt it to his particular application. Communication between the MS5535B and the widely available microcontrollers is realised over an easy-to-use 3-wire serial interface. Customers may select which microcontroller system to be used, and there are no specific standard interface cells required, which may be of interest for specially designed 4 Bit-microcontroller applications.

### **CALIBRATION**

The MS5535B is factory calibrated. The calibration data is stored inside the 64-Bit PROM memory.

### **SOLDERING**

Please refer to the application note AN808 for all soldering issues.

### **HUMIDITY, WATER PROTECTION**

The MS5535BM carries a metal protection cap filled with silicone gel for enhanced protection against humidity. The properties of this gel ensure function of the sensor even when in direct water contact. This feature can be useful for waterproof watches or other applications, where direct water contact cannot be avoided. Nevertheless the user should avoid drying of hard materials like for example salt particles on the silicone gel surface. In this case it is better to rinse with clean water afterwards. Special care has to be taken to not mechanically damage the gel. Damaged gel could lead to air entrapment and consequently to unstable sensor signal, especially if the damage is close to the sensor surface.

The metal protection cap is fabricated of special anticorrosive stainless steel in order to avoid any corrosive battery effects inside the final product.

### **LIGHT SENSITIVITY**

The MS5535B is sensitive to sunlight, especially to infrared light sources. This is due to the strong photo effect of silicon. As the effect is reversible there will be no damage, but the user has to take care that in the final product the sensor cannot be exposed to direct light during operation. This can be achieved for instance by placing mechanical parts with holes in such that light cannot pass.

### **CONNECTION TO PCB**

The package outline of the module allows the use of a flexible PCB to connect it. This can be important for applications in watches and other special devices, and will also reduce mechanical stress on the device.

For applications subjected to mechanical shock, it is recommended to enhance the mechanical reliability of the solder junctions by covering the rim or the corners of MS5535B's ceramic substrate with glue or Globtop-like material.

## DECOUPLING CAPACITOR

Particular care must be taken when connecting the device to power supply. A 47  $\mu\text{F}$  tantalum capacitor **must** be placed as close as possible of the MS5535B's VDD pin. This capacitor will stabilise the power supply during data conversion and thus, provide the highest possible accuracy.

## APPLICATION EXAMPLE: DIVING COMPUTER SYSTEM USING MS5535B

MS5535B is a circuit that can be used in connection with a microcontroller in diving computer applications. It is designed for low-voltage systems with a supply voltage of 3 V, particularly in battery applications. The MS5535B is optimised for low current consumption as the AD-converter clock (MCLK) can use the 32.768 kHz frequency of a standard watch crystal, which is supplied in most portable watch systems.

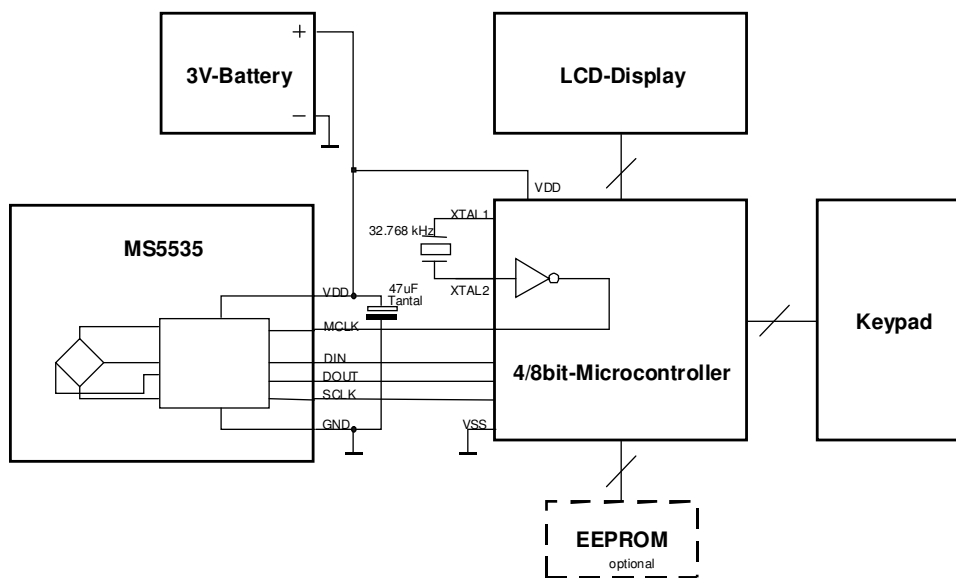

Figure 7: Demonstration of MS5535B in a diving computer.

**DEVICE PACKAGE OUTLINES**

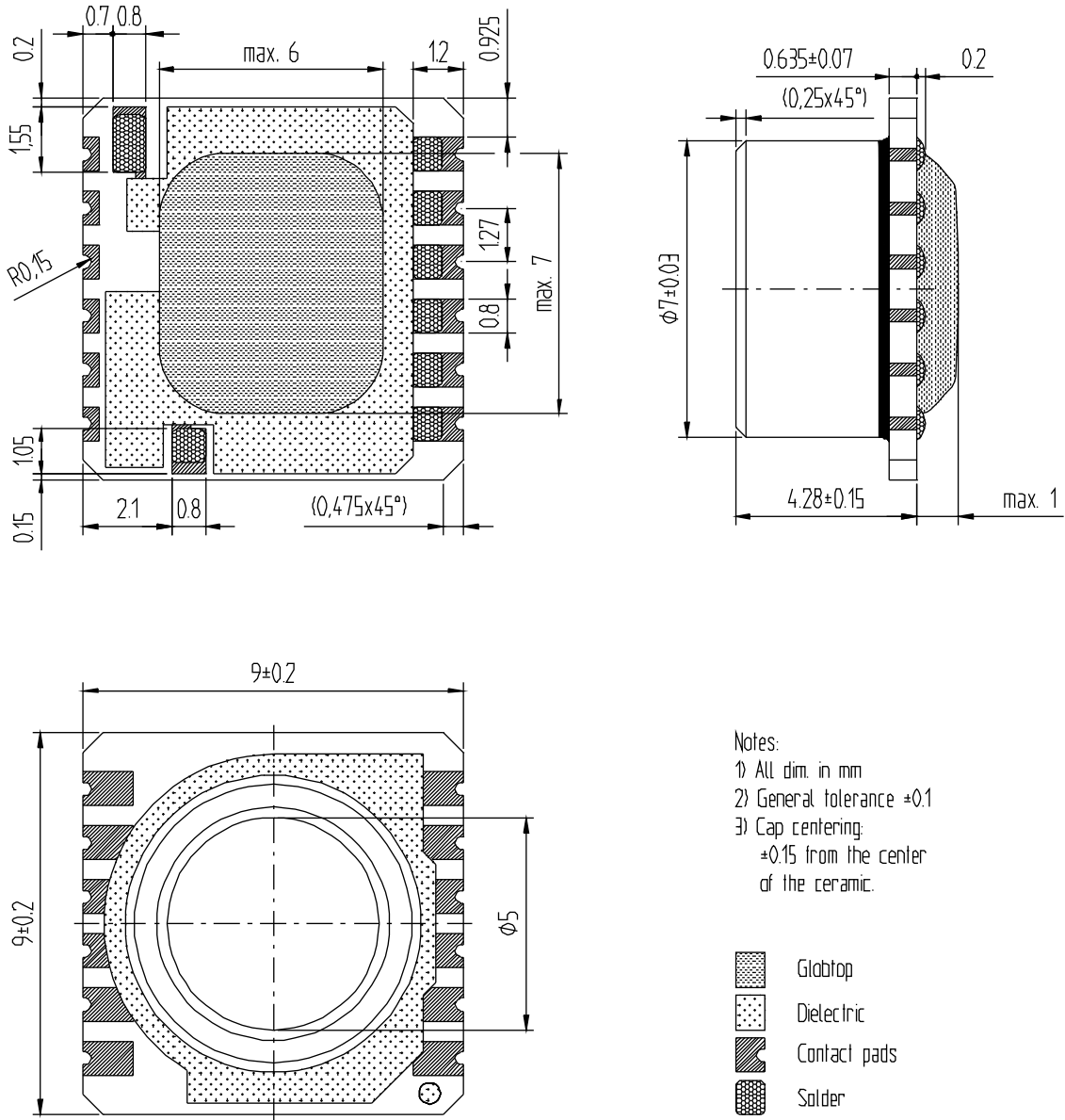
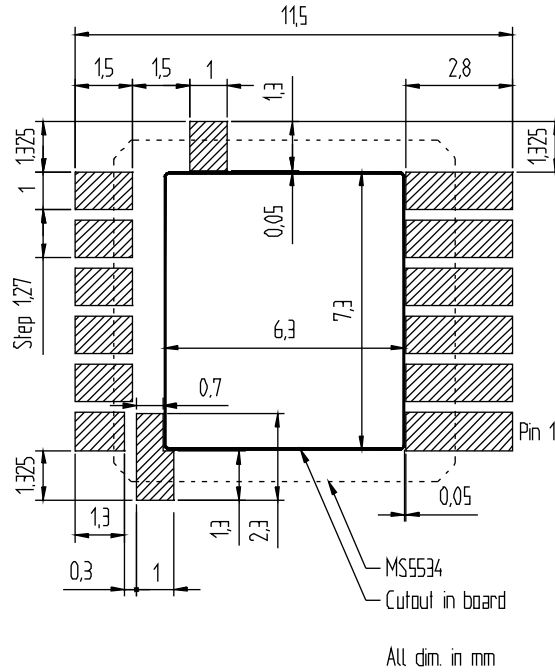

Fig. 8: Device package outlines of **MS5535BM**.

## RECOMMENDED PAD LAYOUT

Pad layout for bottom side of MS5535B soldered onto printed circuit board



Pad layout for top side of MS5535B soldered onto printed circuit board

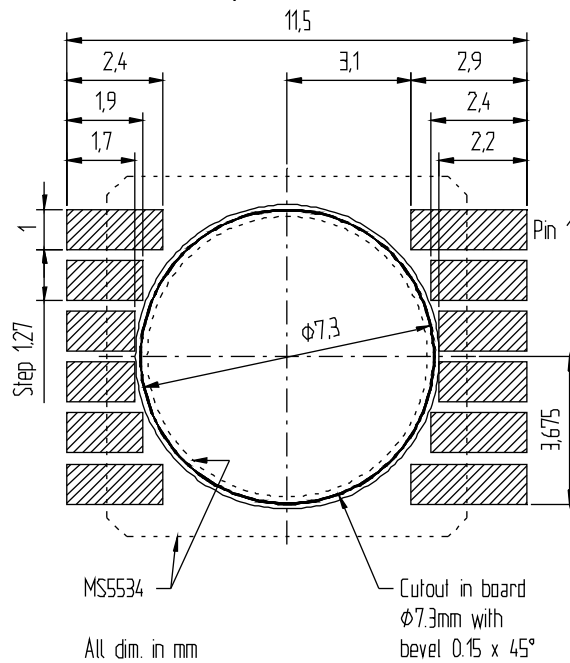

## ASSEMBLY

### MECHANICAL STRESS

It is recommended to avoid mechanical stress on the PCB on which the sensor is mounted. The thickness of the PCB should be not below 1.6 mm. A thicker PCB is more stiff creating less stress on the soldering contacts. For applications where mechanical stress cannot be avoided (for example ultrasound welding of the case or thin PCB's in watches) please fix the sensor with drops of low stress epoxy (for example Hysol FP-4401) at the corners of the sensor as shown below.

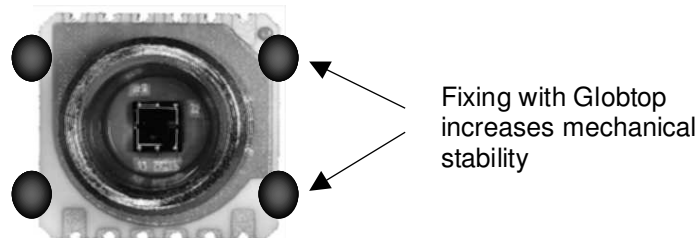

### MOUNTING

The MS5535B can be placed with automatic Pick&Place equipment using vacuum nozzles. It will not be damaged by the vacuum. Due to the low stress assembly the sensor does not show pressure hysteresis effects. Special care has to be taken to not touch the protective gel of the sensor during the assembly.

The MS5535B can be mounted with the cap down or the cap looking upwards. In both cases it is important to solder all contact pads. The Pins PEN and PV shall be left open or connected to VDD. **Do not connect the Pins PEN and PV to GND!**

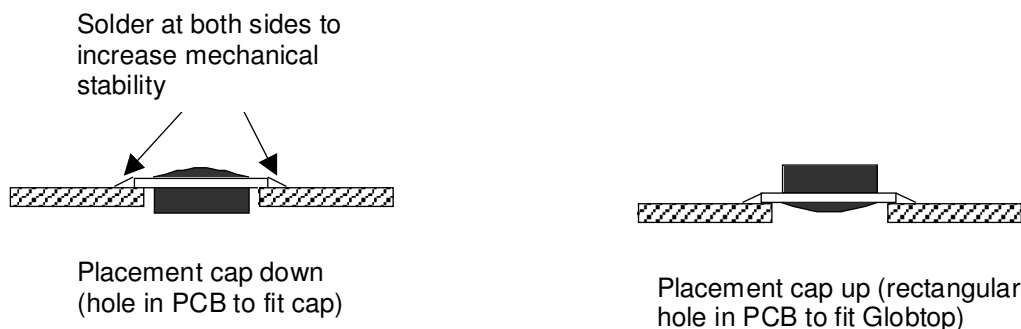

### SEALING WITH O-RING

In products like outdoor watches the electronics must be protected against direct water or humidity. For those products the MS5535BM provides the possibility to seal with an O-ring. The protective cap of the MS5535BM is made of special anticorrosive stainless steel with a polished surface. In addition to this the MS5535BM is filled with silicone gel covering the sensor and the bonding wires. The O-ring (or O-rings) shall be placed at the outer diameter of the metal cap. This method avoids mechanical stress because the sensor can move in vertical direction.

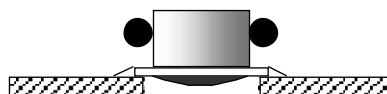

## CLEANING

The MS5535B has been manufactured under cleanroom conditions. Each device has been inspected for the homogeneity and the cleanness of the silicone gel. It is therefore recommended to assemble the sensor under class 10'000 or better conditions. Should this not be possible, it is recommended to protect the sensor opening during assembly from entering particles and dust. To avoid cleaning of the PCB, solder paste of type "no-clean" shall be used. **Cleaning might damage the sensor!**

## ESD PRECAUTIONS

The electrical contacts except programming pads are protected against ESD according to 2 kV HBM (human body model). The PV programming pad is more sensitive due to the nature of the OTP programming cells that store the calibration coefficients. The breakdown voltage of PV is 1 kV. It is therefore essential to ground machines and personal properly during assembly and handling of the device. The MS5535B is shipped in antistatic transport boxes. Any test adapters or production transport boxes used during the assembly of the sensor shall be of an equivalent antistatic material.

---

**ORDERING INFORMATION**

---

Product Code	Product	Art.-Nr.	Package	Comments
MS5535-BM	14 Pressure Sensor Module with gel	325535001	SMD hybrid with solder paste, metal protection cap, silicon gel sensor protection	standard version

---

**FACTORY CONTACTS**

---

Intersema Sensoric SA Ch. Chapons-des-Prés 11 CH-2022 BEVAIX SWITZERLAND	Tel. 032 847 9550 Tel. Int. +41 32 847 9550 Telefax +41 32 847 9569 e-mail: <a href="mailto:sales@intersema.ch">sales@intersema.ch</a> <a href="http://www.intersema.ch">http://www.intersema.ch</a>
---	--

**NOTICE**

Intersema reserves the right to make changes to the products contained in this data sheet in order to improve the design or performance and to supply the best possible products. Intersema assumes no responsibility for the use of any circuits shown in this data sheet, conveys no license under any patent or other rights unless otherwise specified in this data sheet, and makes no claim that the circuits are free from patent infringement. Applications for any devices shown in this data sheet are for illustration only and Intersema makes no claim or warranty that such applications will be suitable for the use specified without further testing or modification.